

Anbaumodule CTM, für elektrische Terminals

Datenblatt

FESTO

Anschlussblock CPX-AB-2-M12

- Adapter für Sub-D Stecker und Dose
- Stecker/Dose 9-polig auf Anschluss 2xM12, 5-polig
- B-codiert (ReverseKey)



Allgemeine Technische Daten		
Typ	CPX-AB-2-M12-RK-IB	CPX-AB-2-M12-RK-DP
Befestigungsart	4 Schrauben M3x25	4 Schrauben M3x25
Feldbus-Schnittstelle	2xM12x1, B-Codiert	M12x1, 5-polig, B-Codiert
Protokoll	INTERBUS	PROFIBUS
Einbaulage	beliebig	beliebig
Betriebsspannungsbereich [V]	24 DC	-
Schutz gegen direktes und indirektes Berühren	PELV	-
Schutzart	IP65/IP67	IP65/IP67

Werkstoffe	
Gehäuse	PA-verstärkt
Kontakte	Bronze, vergoldet

Betriebs- und Umweltbedingungen	
Umgebungstemperatur [°C]	-5 ... +50
Lagertemperatur [°C]	-20 ... +70
Relative Luftfeuchtigkeit [%]	95 nicht kondensierend

Abmessungen

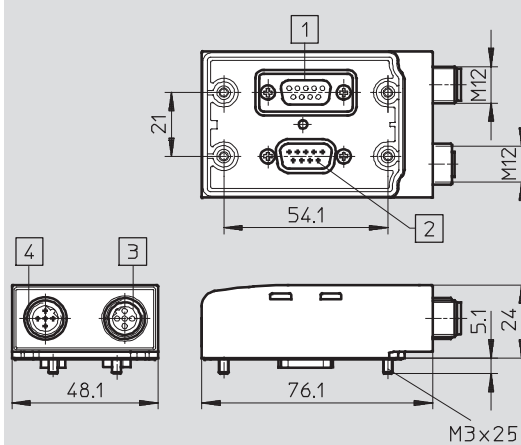

Download CAD-Daten → www.festo.com



- 1 Dose Sub-D 9-polig
(nicht vorhanden bei CPX-AB-2-M12-RK-DP)
- 2 Stecker Sub-D 9-polig
- 3 Dose M12, 5-polig
- 4 Stecker M12, 5-polig

Anbaumodule CTM, für elektrische Terminals

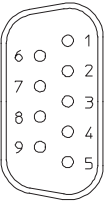
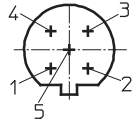
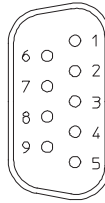
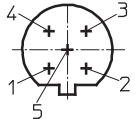
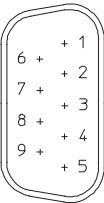
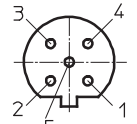
Datenblatt

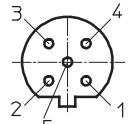
Pinbelegung Sub-D/M12				CPX-AB-2-M12-RK-IB					
Sub-D Anschluss		Pin	Pin	M12 Anschluss	Sub-D Anschluss		Pin	Pin	M12 Anschlüsse
Dose Sub-D		Sub-D	M12	Stecker M12	Dose Sub-D		Sub-D	M12	Stecker M12
	1	1				1	-		
	2	3				2	-		
	3	5				3	4		
	4	-				4	-		
	5	-				5	-		
	6	2				6	-		
	7	4				7	-		
	8	-				8	2		
	9	-				9	-		
	Gehäuse	Gehäuse				Gehäuse	Gehäuse		
Stecker Sub-D		Sub-D	M12	Dose M12	Stecker Sub-D		Sub-D	M12	Dose M12
	1	1				1	-		
	2	3				2	-		
	3	5				3	4		
	4	-				4	-		
	5	-				5	3		
	6	2				6	1		
	7	4				7	-		
	8	-				8	2		
	9	-				9	-		
	Gehäuse	Gehäuse				Gehäuse	Gehäuse		

Bestellangaben				
Elektrischer Anschluss	Protokoll	Gewicht [g]	Teile-Nr.	Typ
Stecker/Dose gerade, Sub-D 9-polig, Stecker/Dose M12 5-polig	INTERBUS	140	534505	CPX-AB-2-M12-RK-IB
Dose gerade, Sub-D 9-polig, Stecker/Dose M12 5-polig	PROFIBUS	85	541519	CPX-AB-2-M12-RK-DP

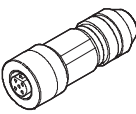
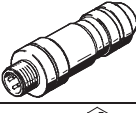
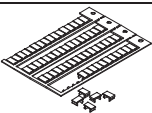
Bestellangaben – Zubehör				
	Beschreibung	Teile-Nr.	Typ	
	Dose M12x1, 5-polig, gerade, zum Selbstkonfektionieren einer Verbindungsleitung	1067905	NECU-M-B12G5-C2-PB	
	Stecker M12x1, 5-polig, gerade, zum Selbstkonfektionieren einer Verbindungsleitung	1066354	NECU-M-S-B12G5-C2-PB	
	Bezeichnungsschilder 6x10 mm, 64 Stück, im Rahmen	18576	IBS-6x10	