

Bremswiderstände CACR

FESTO

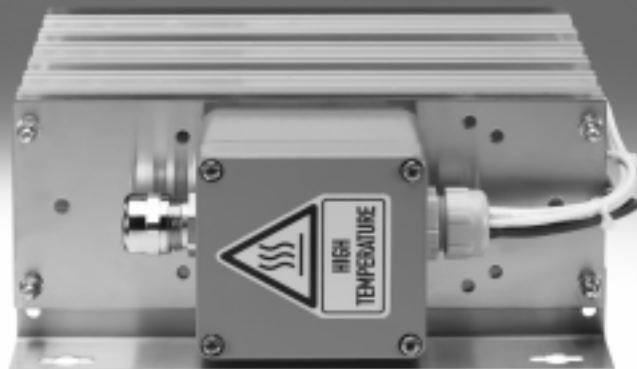

Bremswiderstände CACR

Typenschlüssel

CACR – LE 2 – 100 – W500

Typ	
CACR	Widerstand

Anschluss technik	
LE	Offenes Ende
KL	Klemme

PIN	
2	2-polig

Widerstandswert	
33	33 Ω
40	40 Ω
50	50 Ω
67	67 Ω
72	72 Ω
100	100 Ω

Leistung	
500	500 W
1800	1 800 W
2000	2 000 W
2400	3 600 W

Bremswiderstände CACR

Datenblatt

FESTO

Bremswiderstand
CACR-LE2
CACR-KL2

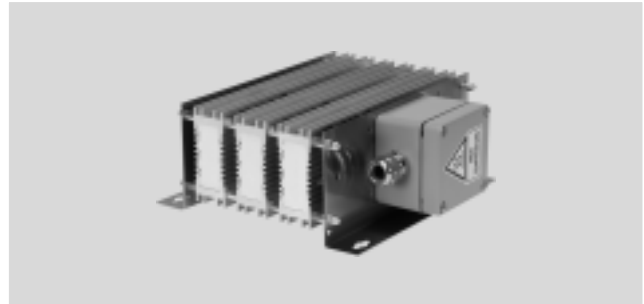

Allgemeine Technische Daten				
Typ	CACR-			
	LE2-50-W500	LE2-72-W500	LE2-100-W500	
Leistung bei 35% ED und 20°C	[W]	500	500	500
Nennleistung	[W]	200	200	200
Widerstandswert	[Ω]	50	72	100
Anschlusstechnik	offenes Ende			
Einbaulage	senkrecht			
	freie Konvektion			
Befestigungsart	mit Zubehör			
	mit Durchgangsbohrung			
Produktgewicht	[g]	550	550	550

Typ	CACR-			
	KL2-67-W1800	KL2-40-W2000	KL2-33-W2400	
Leistung bei 35% ED und 20°C	[W]	1 800	2 000	3 600 ¹⁾
Nennleistung	[W]	720	800	1 440
Widerstandswert	[Ω]	67	40	33
Anschlusstechnik	Klemme			
Einbaulage	senkrecht			
	freie Konvektion			
Befestigungsart	mit Zubehör			
	mit Durchgangsbohrung			
Produktgewicht	[g]	4 000	2 400	8 000

1) Wegen UL- und CSA-Zulassung ist die Leistungsangabe im Typenschild auf 2 400 W reduziert.

Betriebs- und Umweltbedingungen	
Umgebungstemperatur	[°C] 0 ... 50
Schutzart	IP65
Zulassung	c UL us - Recognized (OL)
	c CSA us (OL)
Werkstoff-Hinweis	RoHS konform
	LABS-haltige Stoffe enthalten

Bremswiderstände CACR

Datenblatt

Abmessungen

Download CAD-Daten → www.festo.com

CACR-LE2-50-W500, CACR-LE2-72-W500, CACR-LE2-100-W500

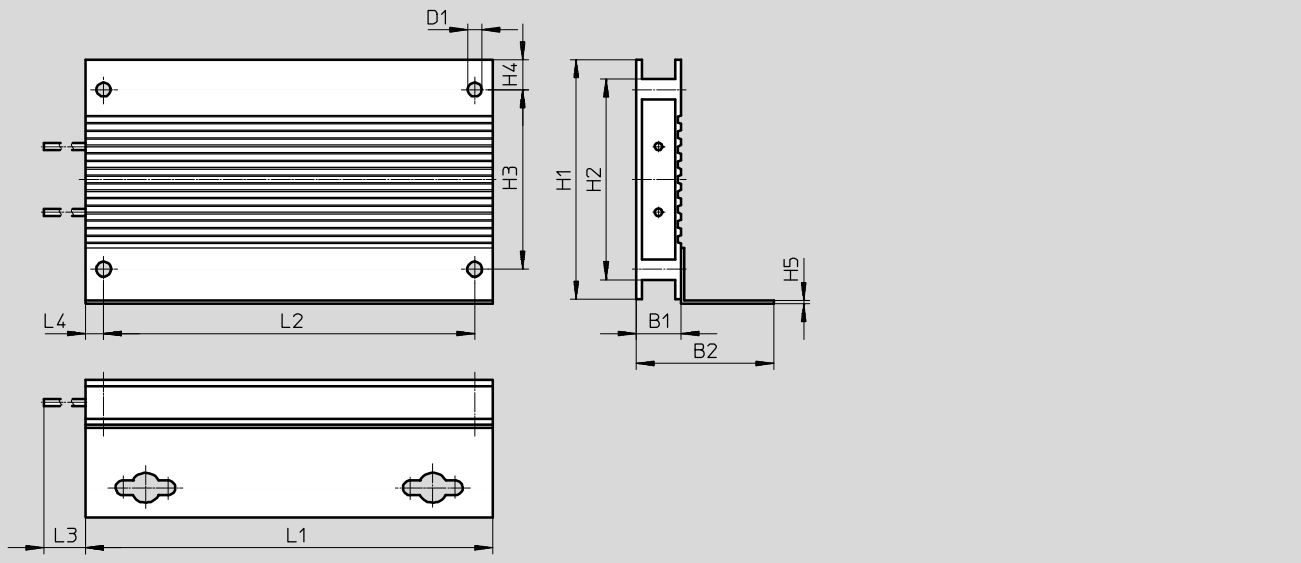

Typ	B1	B2	D1 Ø	H1	H2	H3	H4	H5	L1	L2	L3	L4
	±0,5		±0,1		±0,3	±0,2				±0,2	±40	
CACR-LE2-50-W500												
CACR-LE2-72-W500	15	46	4,7	80	67	60	10	1	216	204	510	6
CACR-LE2-100-W500												

CACR-KL2-67-W1800

CACR-KL2-40-W2000

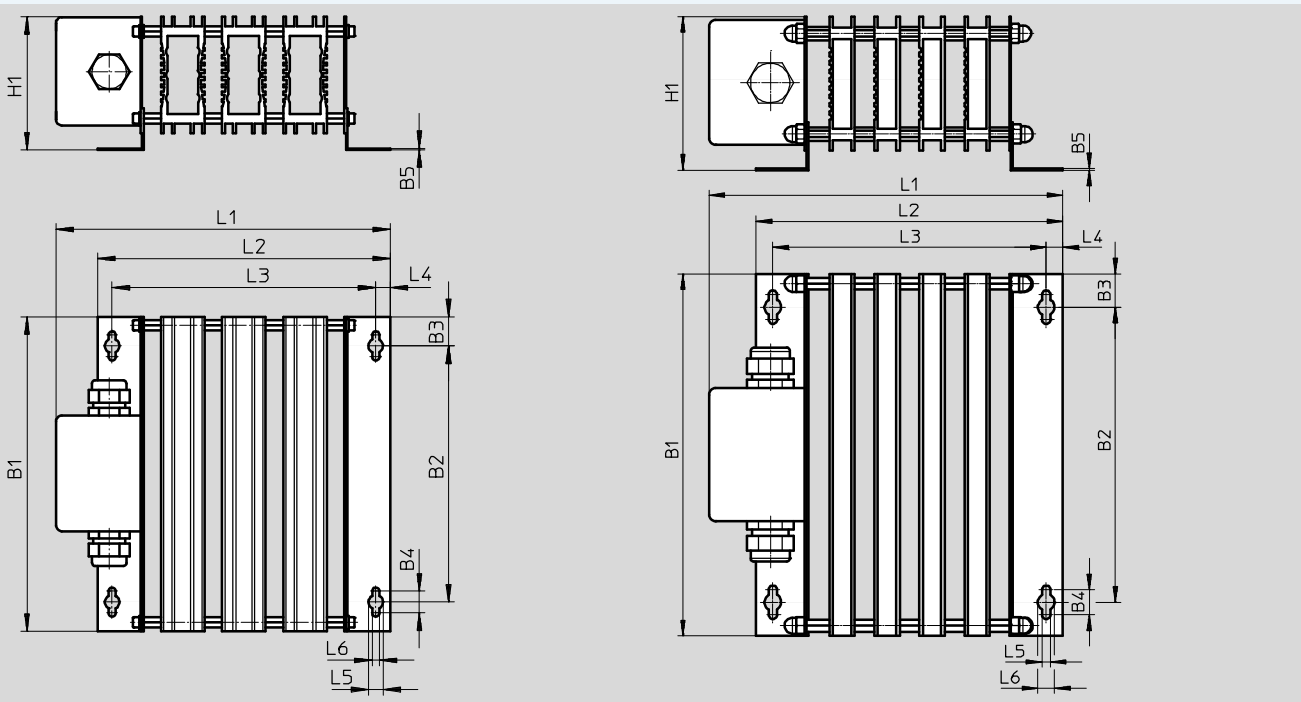

Typ	B1	B2	B3	B4	B5	H1	L1	L2	L3	L4	L5	L6
CACR-KL2-67-W1800	216	176	20	15	1	91,5	230	201	181	10	10	5
CACR-KL2-40-W2000	216	176	20	15	1	91,5	211	183	163	10	10	5

Bremswiderstände CACR

Datenblatt

Abmessungen

Download CAD-Daten → www.festo.com

CACR-KL2-33-W2400

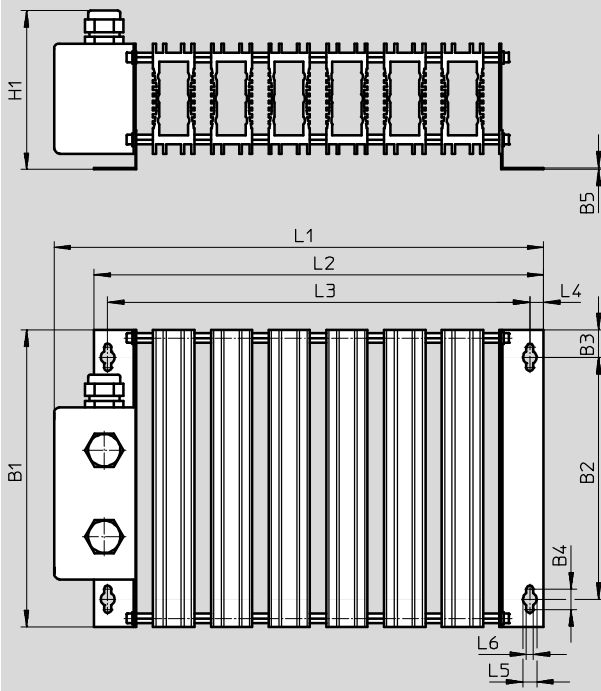

Typ	B1	B2	B3	B4	B5	H1	L1	L2	L3	L4	L5	L6
CACR-KL2-33-W2400	216	176	20	15	1	115,5	356	327	307	10	10	5

Bremswiderstände CACR

Datenblatt

Zuordnung von Bremswiderstand zu Motorcontroller						
Bremswiderstand	CACR-					
	LE2-50-W500	LE2-72-W500	LE2-100-W500	KL2-67-W1800	KL2-40-W2000	KL2-33-W2400
geeignet für Motorcontroller						
CMMP-AS-C2-3A-M0	■ ¹⁾	■	-	-	-	-
CMMP-AS-C5-3A-M0	■ ¹⁾	■	-	-	-	-
CMMP-AS-C5-11A-P3-M0	-	-	-	■	■ ¹⁾	-
CMMP-AS-C10-11A-P3-M0	-	-	-	■	■ ¹⁾	-
CMMP-AS-C2-3A-M3	■ ¹⁾	■	-	-	-	-
CMMP-AS-C5-3A-M3	■ ¹⁾	■	-	-	-	-
CMMP-AS-C5-11A-P3-M3	-	-	-	■	■ ¹⁾	-
CMMP-AS-C10-11A-P3-M3	-	-	-	■	■ ¹⁾	-
CMMP-AS-C20-11A-P3	-	-	-	-	-	■
CMMD-AS-C8-3A	■ ¹⁾	■	-	-	-	-
CMMS-AS-C4-3A-G2	-	-	■	-	-	-

1) Empfohlener Bremswiderstand

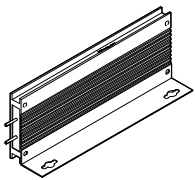
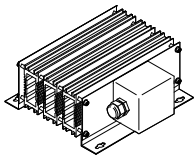
Bestellangaben					
Typ	Widerstandswert [Ω]	Nennleistung [W]	Teile-Nr.	Typ	
CACR-LE2-...					
	50	500	2882342	CACR-LE2-50-W500	
	72	500	1336611	CACR-LE2-72-W500	
	100	500	1336615	CACR-LE2-100-W500	
CACR-KL2-...					
	67	1 800	1336617	CACR-KL2-67-W1800	
	40	2 000	2882343	CACR-KL2-40-W2000	
	33	3 600	1336619	CACR-KL2-33-W2400	