



- Electrically or pneumatically actuated valves
- With internal or external pilot air
- Sturdy and reliable

Specified types in accordance with ATEX directive for potentially explosive atmospheres

→ [www.festo.com/en/ex](http://www.festo.com/en/ex)

# Solenoid/pneumatic valves, Tiger 2000

Key features

FESTO

## General information

- A complete and comprehensive range with 5/2- and 5/3-way valves
- Poppet valve for single solenoid functions or piston spool for more complex versions with air spring, and 5/3-way valves
- Optimised for increased flow rates without increasing size
- Tubing connection threads in sizes G $\frac{1}{8}$ , G $\frac{1}{4}$ , G $\frac{3}{8}$
- Diverse and flexible, side and front mounting
- Pneumatic or electrical actuation
- Versatile electrical connection with F or V solenoid coil with minimal power consumption, can also be used with valve terminals
- Functional and timeless design, enclosed front housing

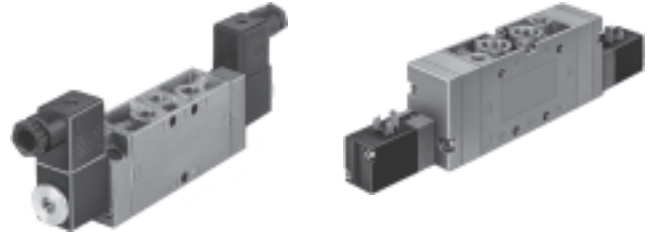

## Solenoid coils

### F solenoid coils

Voltage:

- 12 to 230 V DC
- 12 to 240 V AC (50 to 60 Hz)

Power consumption:

- 4.5 W

- For all MFH valves
- Selected types conform to the ATEX directive for explosive atmospheres  
→ [www.festo.com](http://www.festo.com)

- Easily interchangeable solenoid coils
- Solenoid coil not included in scope of delivery

### V solenoid coils

Voltage:

- 24 V DC

Power consumption:

- 2.5 W

- For all MVH valves
- Minimal heat-up

- Solenoid coil included in scope of delivery

## Manifold mounting

### With PAL manifold strip



### With PRS manifold



The Tiger 2000 valves can be mounted on PAL manifold strips with common supply port or on PRS manifolds with common supply port and common exhausts. Manifold strips and manifolds have 2 to 10 valve positions.

# Solenoid/pneumatic valves, Tiger 2000

Key features

FESTO

## Valve terminals

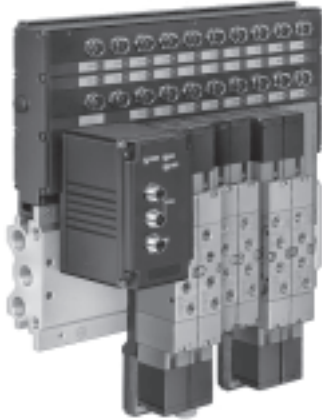

Ready to connect, completely assembled type 02 valve terminal, available with Tiger 2000 valves (V solenoid).

Connection options:

- Central multi-pin plug
- Fieldbus interface for all common fieldbus protocols
- Autonomous with integrated controller (PLC)
- For G $\frac{1}{8}$  and G $\frac{1}{4}$

## Manual override for valves with V solenoid coil

Resetting (standard)



Press on the aluminium plate

## Conversion to detenting actuation

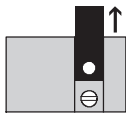

1 Pull out the aluminium plate

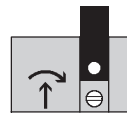

2 Using a screwdriver, simultaneously push and turn the exposed manual override

## Blocking the manual override

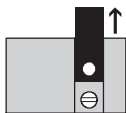

1 Pull out the aluminium plate

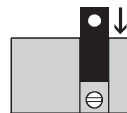

2 Rotate the aluminium plate by 180° and replace



3 The manual override is now blocked

## Pilot exhaust air for valves with V solenoid coil

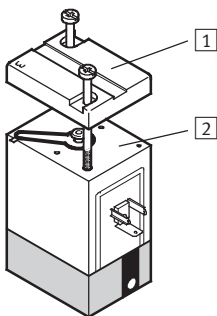

- 1 The cap may not be turned when removing the seal
- 2 Seal installed

Free pilot exhaust air Unducted by removing the seal in the top cover, the 3 on the cap must always be aligned with valve port 84 or 82.

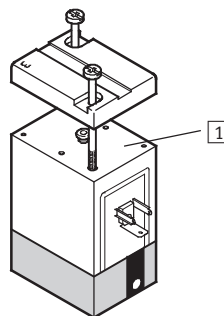

- 1 Seal removed

# Solenoid valves, Tiger 2000

Product range overview

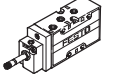
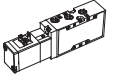
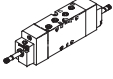
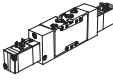

Function	Version	Type	Pneumatic connection	Operating voltage		Pilot air supply		Type of reset		→ Page/Internet
				[V DC]	[V AC]	Internal	External	Pneumatic spring	Mechanical spring	
5/2-way valves	Solenoid valve									
		MFH	G1/8	12, 24, 42, 48	12, 24, 42, 48, 110, 230, 240	■	■	■	■	11
			G1/4			■	■	■	■	
			G3/8			■	■	■	■	
		MVH	G1/8	24	-	■	■	■	■	29
			G1/4			■	■	■	■	
			G3/8			■	■	■	■	
	Double solenoid valve									
		JMFH	G1/8	12, 24, 42, 48	12, 24, 42, 48, 110, 230, 240	■	■	-	-	18
			G1/4			■	■	-	-	
G3/8			■			■	-	-		
	JMVH	G1/8	24	-	■	■	-	-	35	
		G1/4			■	■	-	-		
		G3/8			■	■	-	-		

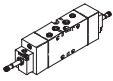
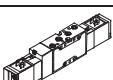
Function	Version	Type	Pneumatic connection	Operating voltage		Pilot air supply		Normal position			→ Page/Internet
				[V DC]	[V AC]	Internal	External	Closed	Exhausted	Pressurised	
5/3-way valves	Solenoid valve										
		MFH-5/3	G1/8	12, 24, 42, 48	12, 24, 42, 48, 110, 230, 240	■	■	■	■	■	23
			G1/4			■	■	■	■	■	
			G3/8			■	■	■	■	■	
		MVH-5/3	G1/8	24	-	■	■	■	■	■	41
			G1/4			■	■	■	■	■	
G3/8			■			■	■	■	■		

# Pneumatic valves, Tiger 2000

Product range overview

FESTO

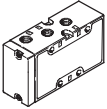
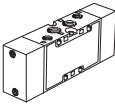
Function	Version	Type	Pneumatic connection	Type of reset		→ Page/Internet
				Pneumatic spring	Mechanical spring	
5/2-way valves	Pneumatic valve					
		VL	G1/8	-	■	49
			G1/4	-	■	
			G3/8	-	■	
	Double pilot valve					
		J	G1/8	-	-	53
G1/4			-	-		
G3/8			-	-		

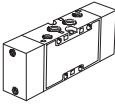
Function	Version	Type	Pneumatic connection	Normal position			→ Page/Internet
				Closed	Exhausted	Pressurised	
5/3-way valves	Pneumatic valve						
		VL	G1/8	■	■	■	56
			G1/4	■	■	■	
			G3/8	■	■	■	

# Solenoid valves, Tiger 2000

Peripherals overview

## Mounting on manifold

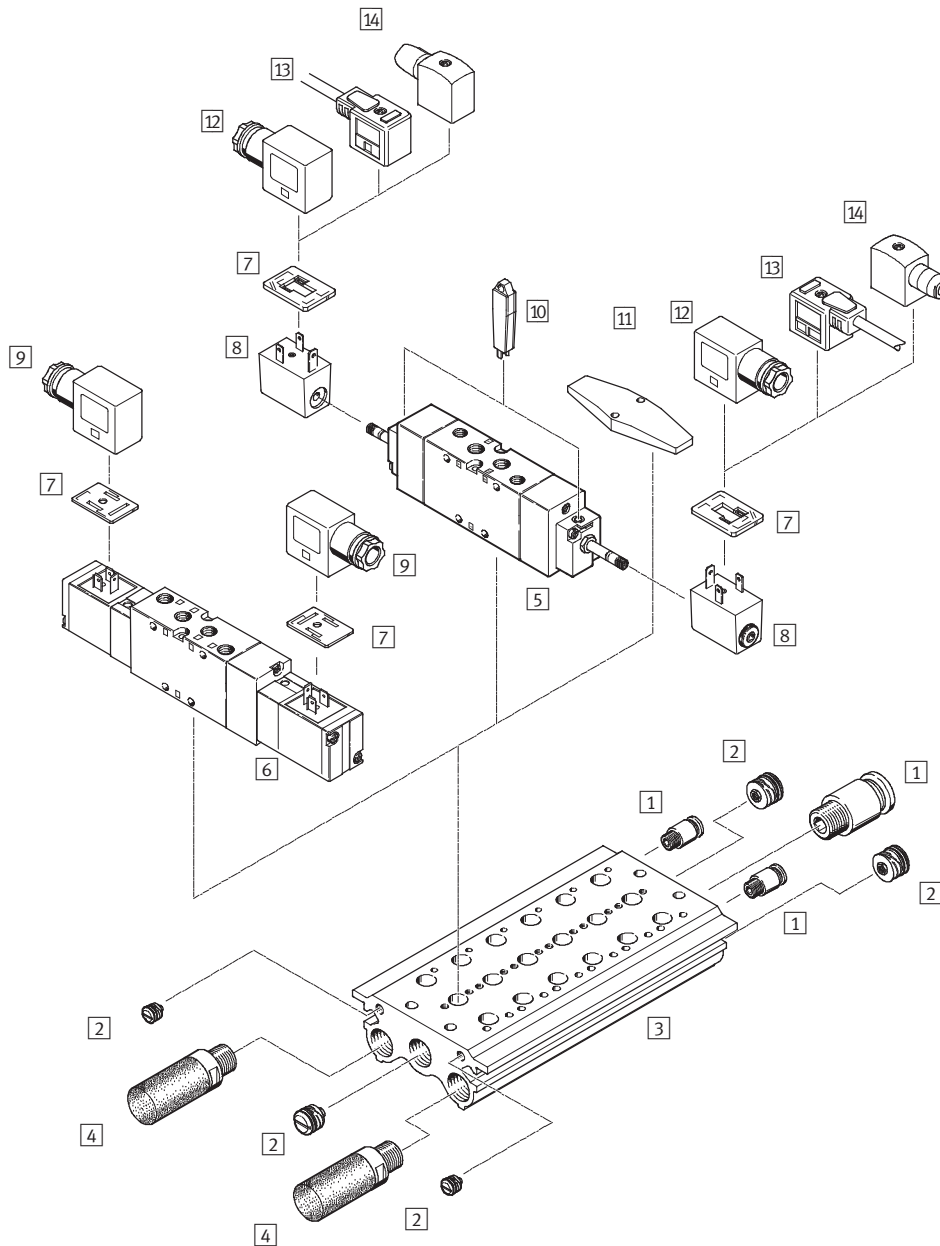

### Variants

MFH-5...-B

MVH-5...-B

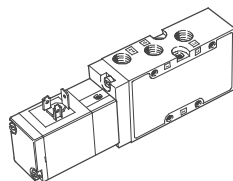
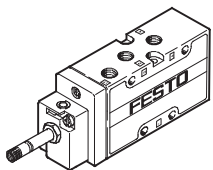

# Solenoid valves, Tiger 2000

Peripherals overview

Accessories		
	Brief description	→ Page/Internet
1	Push-in fitting QS	quick star
2	Sealing plug PRSV	64
3	Manifold PRS	62
4	Silencer	For fitting in exhaust ports u
5	Solenoid valve MFH	For F solenoid coil 4
6	Solenoid valve MVH	With V solenoid coil 4
7	Illuminating seal M...-LD	For displaying the switching status 66
8	F solenoid coil MSFG, MSFW	65
9	Plug socket MSSD-V	For valves MVH, JMVH 66
10	Manual override tool AHB	65
11	Blanking plate PRSB	For covering vacant positions 64
12	Plug socket MSSD-F	For valves MFH, JMFH 66
13	Plug socket cable KMF	For valves MFH, JMFH 66
14	Plug socket MSSD-F-S	For valves MFH, JMFH 66

# Solenoid valves, Tiger 2000

Peripherals overview



## Mounting on manifold strip

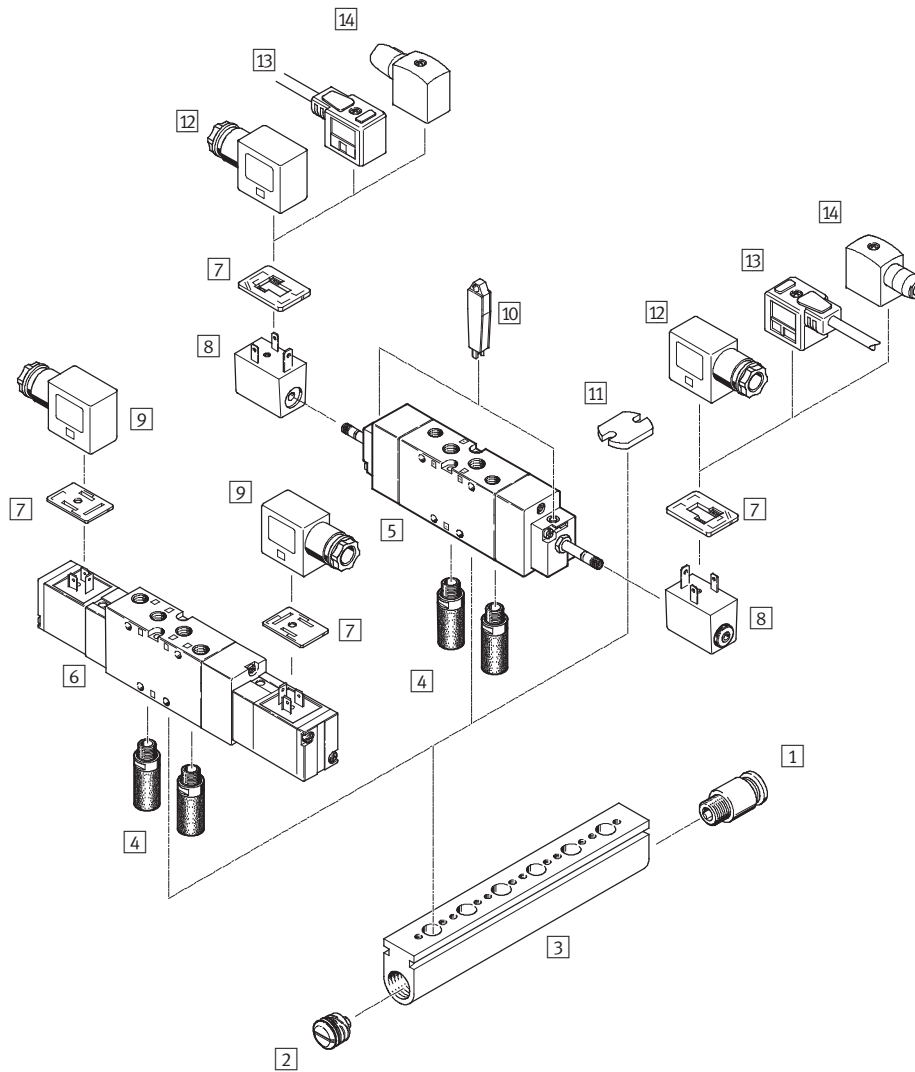

### Variants

MFH-5...-B

MVH-5...-B

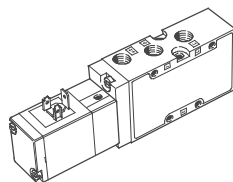
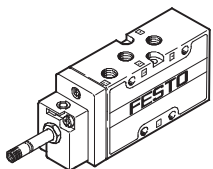



# Solenoid valves, Tiger 2000

Peripherals overview

Accessories		
	Brief description	→ Page/Internet
1	Push-in fitting QS	For connecting compressed air tubing with standard O.D. quick star
2	Sealing plug PRSV	64
3	Manifold strip PAL	60
4	Silencer	For fitting in exhaust ports u
5	Solenoid valve MFH	For F solenoid coil 4
6	Solenoid valve MVH	With V solenoid coil 4
7	Illuminating seal M...-LD	For displaying the switching status 66
8	F solenoid coil MSFG, MSFW	For solenoid valves MFH, JMFH 65
9	Plug socket MSSD-V	For solenoid valves MVH, JMVH 66
10	Manual override tool AHB	65
11	Blanking plate PALB	For covering vacant positions 64
12	Plug socket MSSD-F	For solenoid valves MFH, JMFH 66
13	Plug socket cable KMF	For solenoid valves MFH, JMFH 66
14	Plug socket MSSD-F-S	For solenoid valves MFH, JMFH 66

# Solenoid valves, Tiger 2000

Type code

FESTO

MFH - 5/3 G - 1/8 - - - B

Type	
MFH	Single solenoid, for F solenoid coil
MVH	Single solenoid, with V solenoid coil
JMFH	Double solenoid, for F solenoid coil
JMVH	Double solenoid, with V solenoid coil
Valve function	
5	5/2-way valve
5/3	5/3-way valve
Normal position	
G	Closed
E	Exhausted
B	Pressurised
Pneumatic connection	
1/8	G1/8
1/4	G1/4
3/8	G3/8
Type of reset	
	Mechanical spring
L	Pneumatic spring
Pilot air supply	
	Internal
S	External
Generation	
B	Series B

# Solenoid valves MFH-B, Tiger 2000

Technical data – 5/2-way valves

FESTO

Flow rate

750 ... 2000 l/min

Voltage

12, 24, 42, 48 V DC  
24, 42, 48, 110, 230,  
240 V AC  
Wearing parts kits  
→ 16



General technical data							
Pneumatic connection	G $\frac{1}{8}$		G $\frac{1}{4}$		G $\frac{3}{8}$		
Type of reset	Mechanical	Pneumatic	Mechanical	Pneumatic	Mechanical	Pneumatic	
Valve function	5/2-way, single solenoid						
Constructional design	Poppet	Piston spool	Poppet	Piston spool			
Sealing principle	Soft						
Actuation type	Electrical						
Type of pilot control	Piloted						
Pilot air supply	Internal or external						
Direction of flow	Non-reversible	Reversible	Non-reversible	Reversible			
Exhaust function	With flow control						
Manual override	Via accessory, detenting						
Type of mounting	Via through-holes						
Mounting position	Any						
Nominal size [mm]	5	8	7	10	12		
Standard nominal flow rate [l/min]	750	1000	1300	1600	2000		
Grid dimension [mm]	27		33		41		
Product weight [g]	220	280	300	380	630		

Operating and environmental conditions							
Pneumatic connection	G $\frac{1}{8}$		G $\frac{1}{4}$		G $\frac{3}{8}$		
Type of reset	Pneumatic	Mechanical	Pneumatic	Mechanical	Pneumatic	Mechanical	
Operating medium	Compressed air in accordance with ISO 8573-1:2010 [7:4:4]						
Pilot medium	Compressed air in accordance with ISO 8573-1:2010 [7:4:4]						
Note on operating/ pilot medium	Operation with lubricated medium possible (in which case lubricated operation will always be required)						
Operating pressure	Internal pilot air supply [bar]	3 ... 10	2 ... 10	3 ... 10	2 ... 10	2 ... 10	2 ... 10
	External pilot air supply [bar]	-0.9 ... +10	0 ... 10	-0.9 ... +10	0 ... 10	-0.9 ... +10	-0.9 ... +10
Pilot pressure [bar]	3 ... 10	2 ... 10	3 ... 10	1.5 ... 10	2 ... 10	2 ... 10	
Ambient temperature [°C]	-5 ... +40						
Temperature of medium [°C]	-10 ... +60						
Note on materials	RoHS-compliant						

# Solenoid valves MFH-B, Tiger 2000

Technical data – 5/2-way valves



## Minimum pilot pressure $p_{12}$ , $p_{14}$ as a function of the operating pressure $p_1$ (external pilot air supply)

MFH-5-1/8-S-B

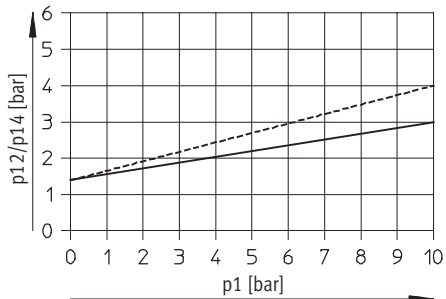

----- Exhaust throttled  
 ———— Exhaust unthrottled

MFH-5-1/4-S-B

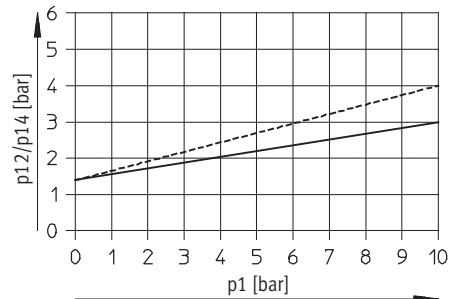

----- Exhaust throttled  
 ———— Exhaust unthrottled

MFH-5-3/8-S-B

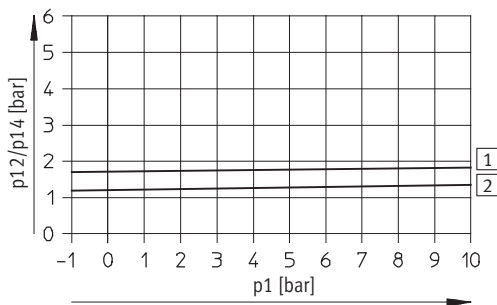

1 On  
 2 Off

## Valve response times [ms]

Pneumatic connection	G1/8		G1/4		G3/8	
Type of reset	Pneumatic	Mechanical	Pneumatic	Mechanical	Pneumatic	Mechanical
On	10	10	25	12	28	20
Off	30	30	44	36	55	56

# Solenoid valves MFH-B, Tiger 2000

Technical data – 5/2-way valves

Electrical data			
F solenoid coil			
Electrical connection		Plug vanes for plug sockets MSSD-F, KMF	
Operating voltage	D.C. voltage	[V DC]	12, 24, 42, 48
	A.C. voltage	[V AC]	24, 42, 48, 110, 230, 240 (50 ... 60 Hz)
Coil characteristics	D.C. voltage	[W]	4.5
	A.C. voltage	[VA]	Pull: 7.5 Hold: 6
Protection class to EN 60 529		IP65 (in combination with plug socket)	

## Materials

Sectional view

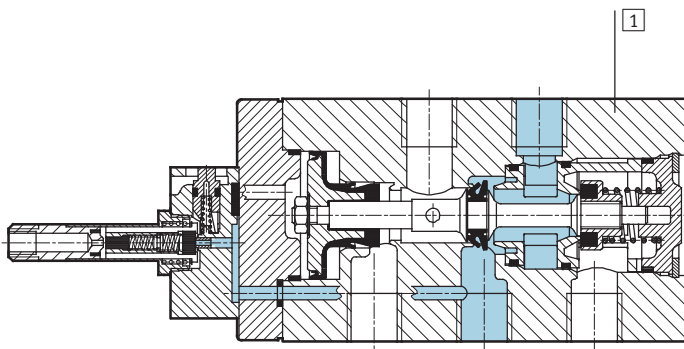

1	Housing	Die-cast aluminium
-	Seals	Nitrile rubber

# Solenoid valves MFH-B, Tiger 2000

Technical data – 5/2-way valves



## Dimensions – Pneumatic connection G $\frac{1}{8}$ , G $\frac{1}{4}$

Download CAD Data → [www.festo.com/us/cad](http://www.festo.com/us/cad)

### Basic valve

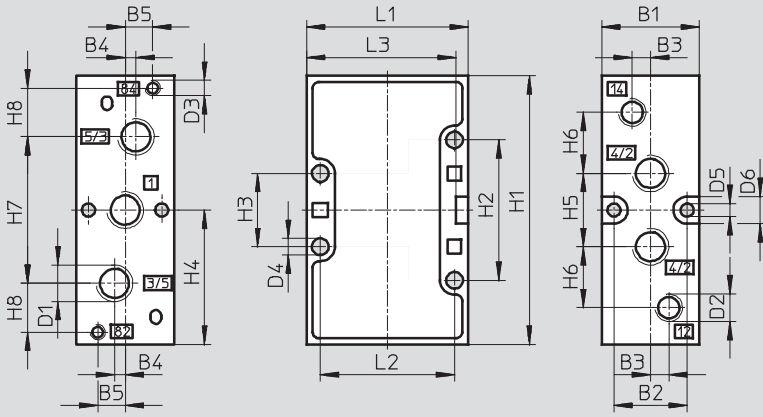

### Installation dimensions with F solenoid coil

#### Mechanical reset

#### Pneumatic reset

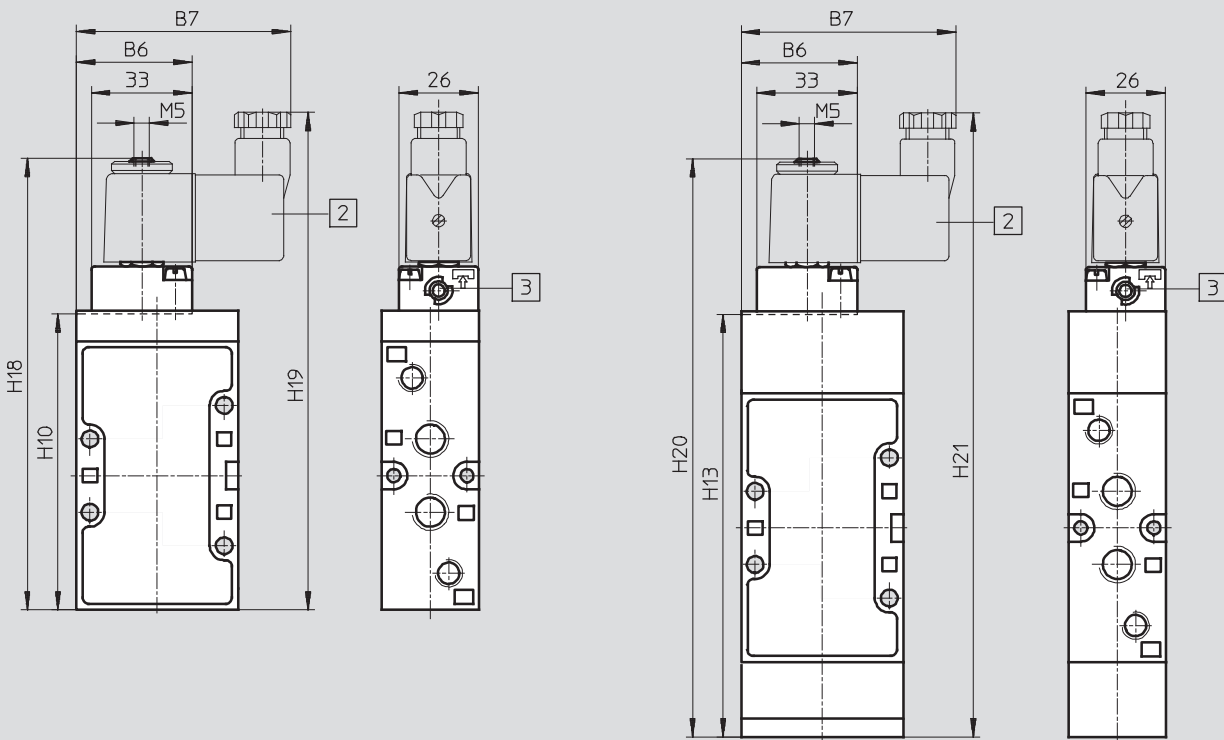

2 Solenoid coil is 360° rotatable

3 Manual override can be repositioned by 180°

Pneumatic connection	B1	B2	B3	B4	B5	B6	B7	D1	D2	D3	D4	D5	D6	H1	H2
G $\frac{1}{8}$	26	19.5	5	3.5	8	36.8	67	G $\frac{1}{8}$	G $\frac{1}{8}$	M5	4.5	4.3	9	77	41
G $\frac{1}{4}$	32	24	6	3.5	9	38	70	G $\frac{1}{4}$	G $\frac{1}{8}$	M5	5.5	4.3	9	88	46

Pneumatic connection	H3	H4	H5	H6	H7	H8	H10	H13	H18	H19	H20	H21	L1	L2	L3
G $\frac{1}{8}$	21	38.5	22	19	42	12	86.5	126.2	136	152	175	192	47	40	43
G $\frac{1}{4}$	24	44	24	20	48	16	97.5	139	147	163	188	205	53	44	49

# Solenoid valves MFH-B, Tiger 2000

Technical data – 5/2-way valves

## Dimensions – Pneumatic connection G $\frac{3}{8}$

Download CAD Data → [www.festo.com/us/cad](http://www.festo.com/us/cad)

### Basic valve

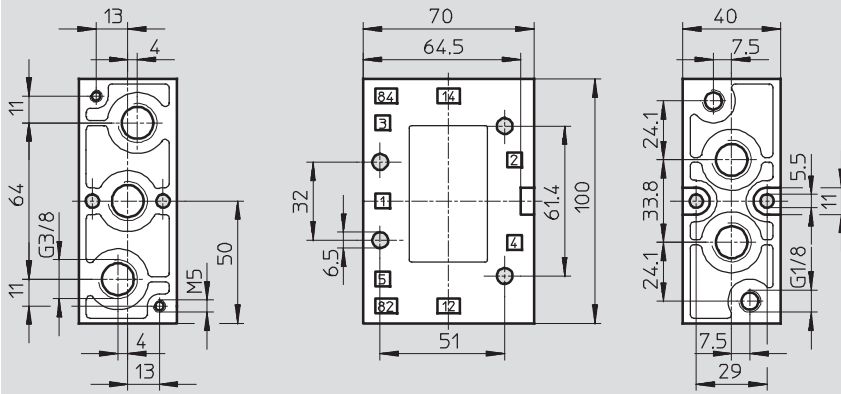

### Installation dimensions with F solenoid coil

#### Mechanical or pneumatic reset

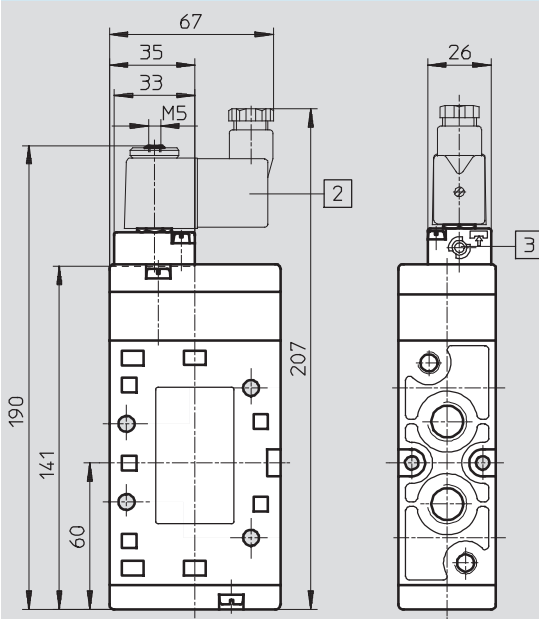

- 2 Solenoid coil is 360° rotatable
- 3 Manual override can be repositioned by 180°

# Solenoid valves MFH-B, Tiger 2000

Technical data – 5/2-way valves

Ordering data			
Circuit symbol	Description	Pneumatic connection	Part No. Type
	Without F solenoid coil <sup>1)</sup> , pneumatic reset, internal pilot air supply	G $\frac{1}{8}$	<b>30991</b> MFH-5- $\frac{1}{8}$ -L-B
		G $\frac{1}{4}$	<b>31010</b> MFH-5- $\frac{1}{4}$ -L-B
		G $\frac{3}{8}$	<b>14946</b> MFH-5- $\frac{3}{8}$ -L-B
	Without F solenoid coil <sup>1)</sup> , pneumatic reset, external pilot air supply	G $\frac{1}{8}$	<b>30992</b> MFH-5- $\frac{1}{8}$ -L-S-B
		G $\frac{1}{4}$	<b>33185</b> MFH-5- $\frac{1}{4}$ -L-S-B
		G $\frac{3}{8}$	<b>33181</b> MFH-5- $\frac{3}{8}$ -L-S-B
	Without F solenoid coil <sup>1)</sup> , mechanical reset, internal pilot air supply	G $\frac{1}{8}$	<b>19758</b> MFH-5- $\frac{1}{8}$ -B
		G $\frac{1}{4}$	<b>15901</b> MFH-5- $\frac{1}{4}$ -B
		G $\frac{3}{8}$	<b>19705</b> MFH-5- $\frac{3}{8}$ -B
	Without F solenoid coil <sup>1)</sup> , mechanical reset, external pilot air supply	G $\frac{1}{8}$	<b>19759</b> MFH-5- $\frac{1}{8}$ -S-B
		G $\frac{1}{4}$	<b>15902</b> MFH-5- $\frac{1}{4}$ -S-B
	Without F solenoid coil <sup>1)</sup> , mechanical reset, external pilot air supply	G $\frac{3}{8}$	<b>19706</b> MFH-5- $\frac{3}{8}$ -S-B

1) F solenoid coils → 65

Ordering data – Wearing parts kits		
Pneumatic connection	Part No.	Type
G $\frac{1}{8}$	<b>125710</b>	MFH-5- $\frac{1}{8}$ -B
G $\frac{1}{4}$	<b>115580</b>	MFH-5- $\frac{1}{4}$ -B
G $\frac{3}{8}$	<b>115074</b>	MFH-5- $\frac{3}{8}$ -B



# Solenoid valves JMFH-B, Tiger 2000

Technical data – 5/2-way valves, double solenoid

FESTO

## Flow rate

1000 ... 2000 l/min

## Voltage

12, 24, 42, 48 V DC  
24, 42, 48, 110, 230,  
240 V AC

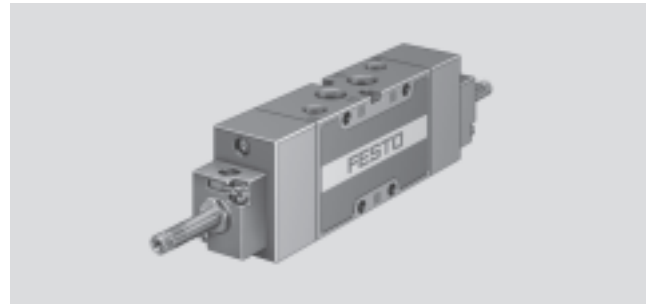

General technical data				
Pneumatic connection	G $\frac{1}{8}$	G $\frac{1}{4}$	G $\frac{3}{8}$	
Valve function	5/2-way, double solenoid			
Constructional design	Piston spool			
Sealing principle	Soft			
Actuation type	Electrical			
Type of pilot control	Piloted			
Pilot air supply	Internal or external			
Direction of flow	Non-reversible			
Exhaust function	With flow control			
Manual override	Via accessory, detenting			
Type of mounting	Via through-holes			
Mounting position	Any			
Nominal size	[mm]	8	10	12
Standard nominal flow rate	[l/min]	1000	1600	2000
Grid dimension	[mm]	27	33	41
Product weight	[g]	400	460	650

Operating and environmental conditions			
Pneumatic connection	G $\frac{1}{8}$	G $\frac{1}{4}$	G $\frac{3}{8}$
Operating medium	Compressed air in accordance with ISO 8573-1:2010 [7:4:4]		
Pilot medium	Compressed air in accordance with ISO 8573-1:2010 [7:4:4]		
Note on operating/ pilot medium	Operation with lubricated medium possible (in which case lubricated operation will always be required)		
Operating pressure	Internal pilot air supply	[bar]	2 ... 10
	External pilot air supply	[bar]	-0.9 ... +10
Pilot pressure	[bar]	2 ... 10	
Ambient temperature	[°C]	-5 ... +40	
Temperature of medium	[°C]	-10 ... +60	
Note on materials	RoHS-compliant		

# Solenoid valves JMFH-B, Tiger 2000

Technical data – 5/2-way valves, double solenoid

## Minimum pilot pressure $p_{12}/p_{14}$ as a function of the operating pressure $p_1$ (external pilot air supply)

JMFH-5- $\frac{1}{8}$ -S-B

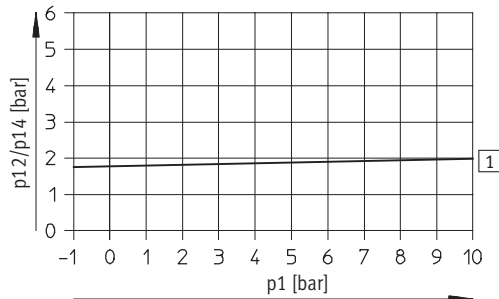

1 On

JMFH-5- $\frac{1}{4}$ -S-B

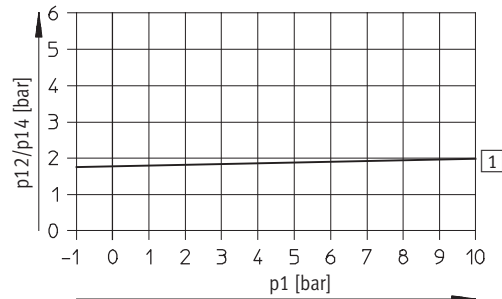

1 On

JMFH-5- $\frac{3}{8}$ -S-B

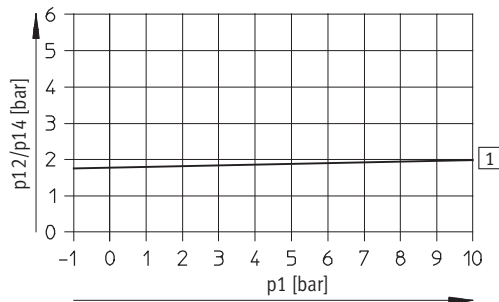

1 On

## Valve response times [ms]

Pneumatic connection	G $\frac{1}{8}$	G $\frac{1}{4}$	G $\frac{3}{8}$
Changeover	12	14	12

## Electrical data

F solenoid coil			
Electrical connection	Plug vanes for plug sockets MSSD-F, KMF		
Operating voltage	D.C. voltage	[V DC]	12, 24, 42, 48
	A.C. voltage	[V AC]	24, 42, 48, 110, 230, 240 (50 ... 60 Hz)
Coil characteristics	D.C. voltage	[W]	4.5
	A.C. voltage	[VA]	Pull: 7.5 Hold: 6
Protection class to EN 60 529	IP65 (in combination with plug socket)		

# Solenoid valves JMFH-B, Tiger 2000

Technical data – 5/2-way valves, double solenoid

## Materials

Sectional view

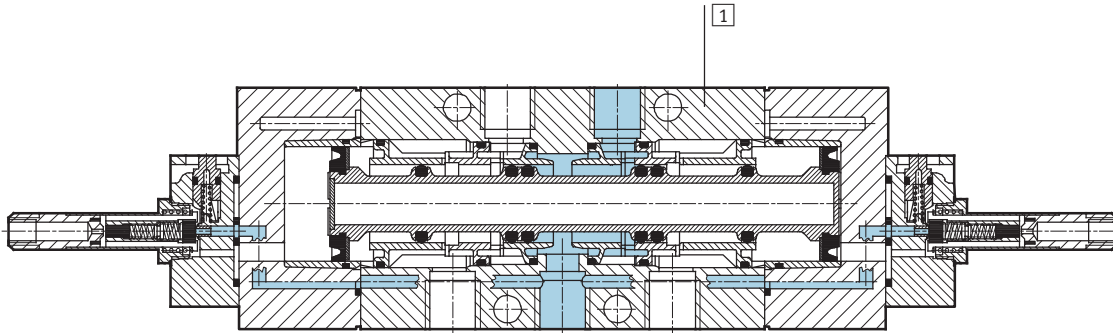

1	Housing	Die-cast aluminium
-	Seals	Nitrile rubber

# Solenoid valves JMFH-B, Tiger 2000

Technical data – 5/2-way valves, double solenoid



## Dimensions – Pneumatic connection G<sup>1</sup>/<sub>8</sub>, G<sup>1</sup>/<sub>4</sub>

Download CAD Data → [www.festo.com/us/cad](http://www.festo.com/us/cad)

Basic valve

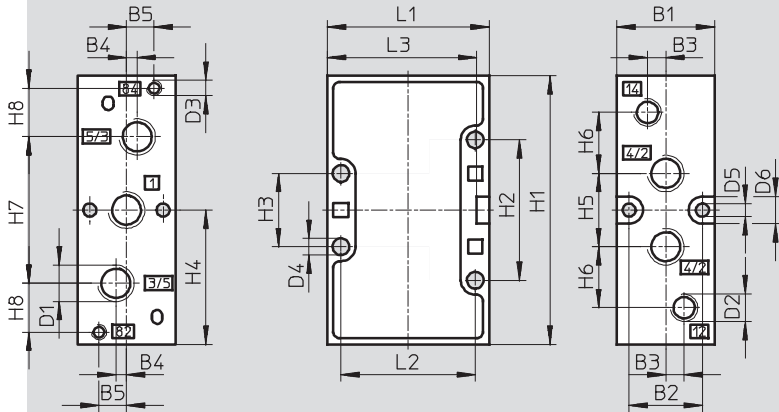

## Installation dimensions with F solenoid coil, mechanical or pneumatic reset

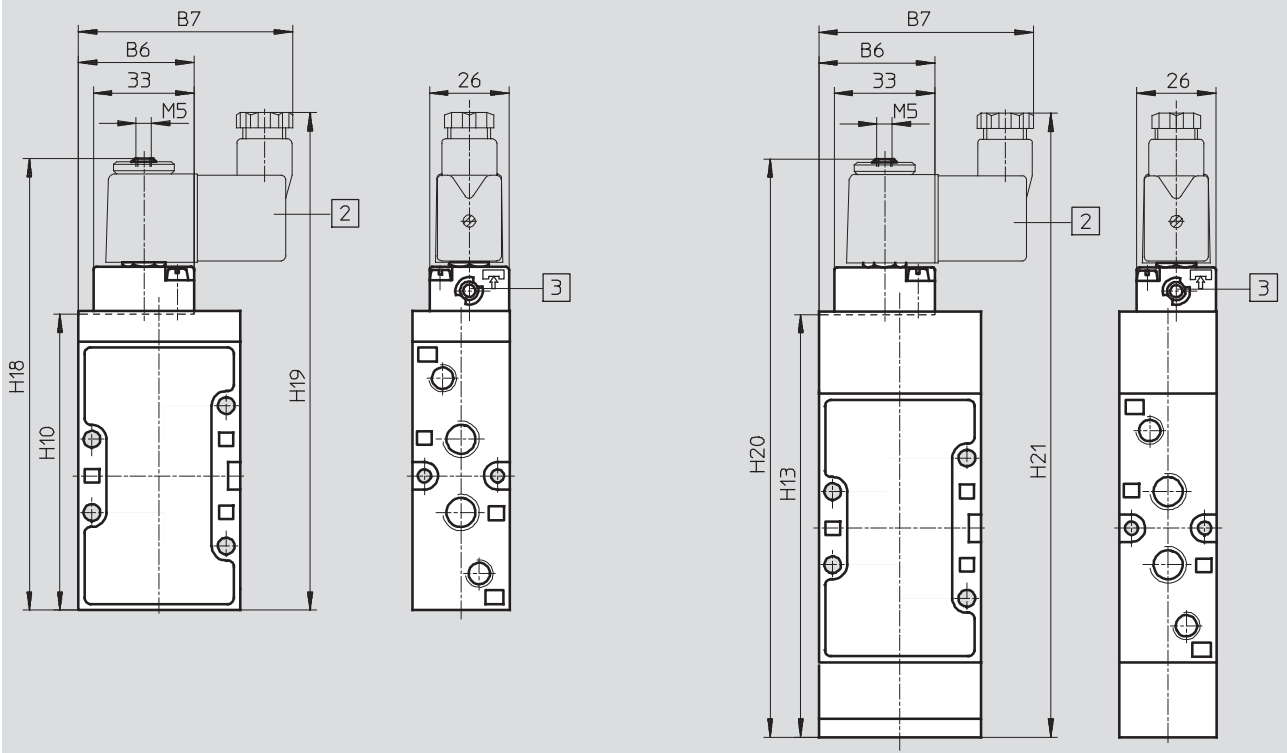

Pneumatic connection	B1	B2	B3	B4	B5	B6	B7	D1	D2	D3	D4	D5	D6	H1
G <sup>1</sup> / <sub>8</sub>	26	19.5	5	3.5	8	36.8	67	G <sup>1</sup> / <sub>8</sub>	G <sup>1</sup> / <sub>8</sub>	M5	4.5	4.3	9	77
G <sup>1</sup> / <sub>4</sub>	32	24	6	3.5	9	38	70	G <sup>1</sup> / <sub>4</sub>	G <sup>1</sup> / <sub>8</sub>	M5	5.5	4.3	9	88

Pneumatic connection	H2	H3	H4	H5	H6	H7	H8	H16	H22	H23	L1	L2	L3
G <sup>1</sup> / <sub>8</sub>	41	21	38.5	22	19	42	12	129	227	260	47	40	43
G <sup>1</sup> / <sub>4</sub>	46	24	44	24	20	48	16	141.5	240	273	53	44	49

# Solenoid valves JMFH-B, Tiger 2000

Technical data – 5/2-way valves, double solenoid

## Dimensions – Pneumatic connection G3/8

Download CAD Data → [www.festo.com/us/cad](http://www.festo.com/us/cad)

### Basic valve

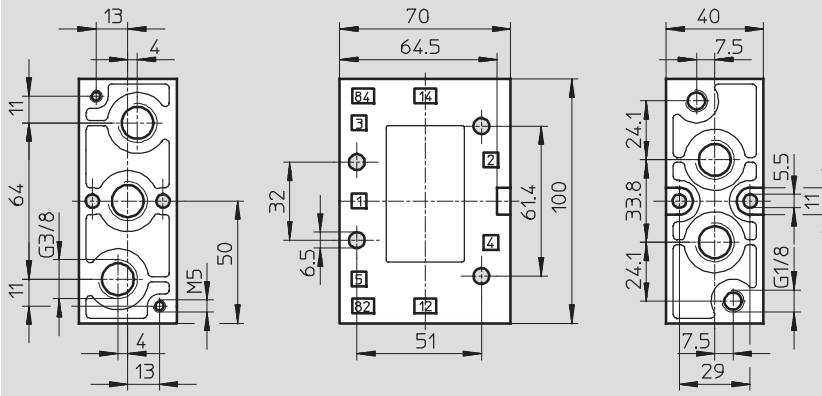

### Installation dimensions with F solenoid coil, mechanical or pneumatic reset

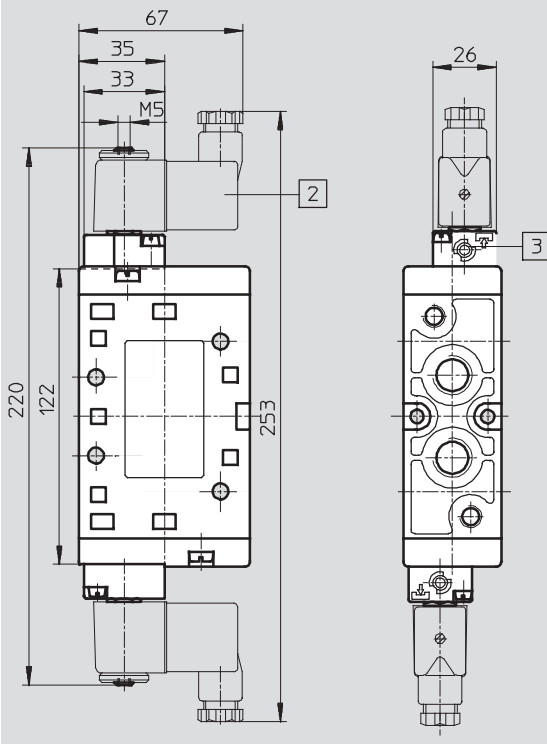

- 2 Solenoid coil is 360° rotatable
- 3 Manual override can be repositioned by 180°

# Solenoid valves JMFH-B, Tiger 2000

Technical data – 5/2-way valves, double solenoid

Ordering data				
Circuit symbol	Description	Pneumatic connection	Part No.	Type
	Without F solenoid coil <sup>1)</sup> , internal pilot air supply	G1/8	<b>30486</b>	<b>JMFH-5-1/8-B</b>
		G1/4	<b>19789</b>	<b>JMFH-5-1/4-B</b>
		G3/8	<b>19700</b>	<b>JMFH-5-3/8-B</b>
	Without F solenoid coil <sup>1)</sup> , external pilot air supply	G1/8	<b>30487</b>	<b>JMFH-5-1/8-S-B</b>
		G1/4	<b>19790</b>	<b>JMFH-5-1/4-S-B</b>
		G3/8	<b>19702</b>	<b>JMFH-5-3/8-S-B</b>

1) F solenoid coils → 65

# Solenoid valves MFH-B, Tiger 2000

Technical data – 5/3-way valves

Flow rate

1000 ... 2600 l/min

Voltage

12, 24, 42, 48 V DC  
24, 42, 48, 110, 230,  
240 V AC



General technical data					
Pneumatic connection		G $\frac{1}{8}$	G $\frac{1}{4}$	G $\frac{3}{8}$	
Valve function		5/3-way, double solenoid			
Constructional design		Piston spool			
Sealing principle		Soft			
Actuation type		Electrical			
Type of reset		Mechanical spring			
Type of pilot control		Piloted			
Pilot air supply		Internal or external			
Direction of flow		Non-reversible			
Exhaust function		With flow control			
Manual override		Via accessory, detenting			
Type of mounting		Via through-holes			
Mounting position		Any			
Nominal size		[mm]	5	7	12
Standard nominal flow rate	Closed	[l/min]	1000	1600	2000
	Exhausted	[l/min]			2200
	Pressurised	[l/min]			2600
Grid dimension		[mm]	27	33	41
Product weight		[g]	400	500	780

Operating and environmental conditions					
Pneumatic connection		G $\frac{1}{8}$	G $\frac{1}{4}$	G $\frac{3}{8}$	
Operating medium		Compressed air in accordance with ISO 8573-1:2010 [7:4:4]			
Pilot medium		Compressed air in accordance with ISO 8573-1:2010 [7:4:4]			
Note on operating/ pilot medium		Operation with lubricated medium possible (in which case lubricated operation will always be required)			
Operating pressure	Internal pilot air supply	[bar]	3 ... 10	3 ... 10	3 ... 10
	External pilot air supply	[bar]	-0.9 ... +10	-0.9 ... +10	-0.9 ... +10
Pilot pressure		[bar]	3 ... 10	3 ... 10	3 ... 10
Ambient temperature		[°C]	-5 ... +40		
Temperature of medium		[°C]	-10 ... +60		
Note on materials		RoHS-compliant			

# Solenoid valves MFH-B, Tiger 2000

Technical data – 5/3-way valves



## Minimum pilot pressure $p_{12}/p_{14}$ as a function of the operating pressure $p_1$ (external pilot air supply)

MFH-5/3...-1/8-S-B

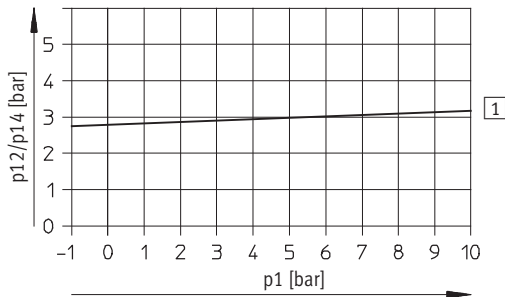

1 On

MFH-5/3...-1/4-S-B

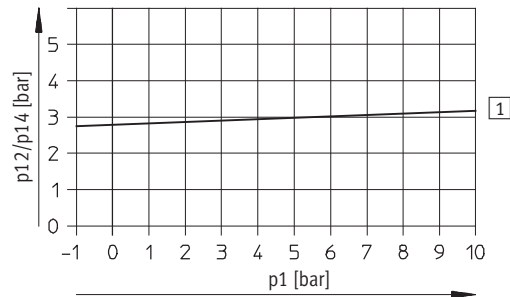

1 On

MFH-5/3...-3/8-S-B

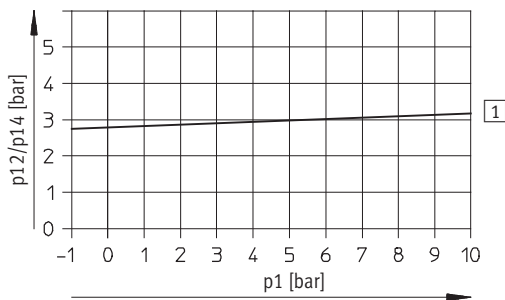

1 On

## Valve response times [ms]

Pneumatic connection	G <sup>1/8</sup>		G <sup>1/4</sup>		G <sup>3/8</sup>	
	On	Off	On	Off	On	Off
Closed	18	20	20	22	24	80
Exhausted	20	20	24	36	36	85
Pressurised	24	24	34	30	30	82



# Solenoid valves MFH-B, Tiger 2000

Technical data – 5/3-way valves

Electrical data			
F solenoid coil			
Electrical connection	Plug vanes for plug sockets MSSD-F, KMF		
Operating voltage	D.C. voltage	[V DC]	12, 24, 42, 48
	A.C. voltage	[V AC]	24, 42, 48, 110, 230, 240 (50 ... 60 Hz)
Coil characteristics	D.C. voltage	[W]	4.5
	A.C. voltage	[VA]	Pull: 7.5 Hold: 6
Protection class to EN 60 529	IP65 (in combination with plug socket)		

## Materials

Sectional view

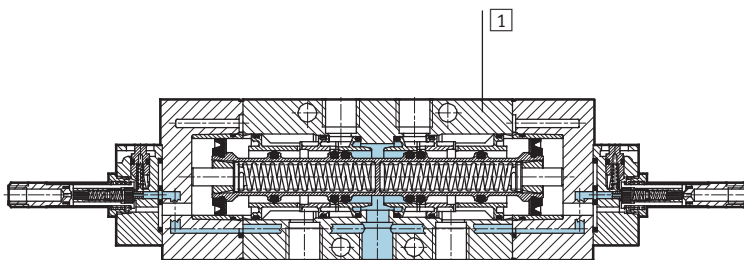

1	Housing	Die-cast aluminium
-	Seals	Nitrile rubber

# Solenoid valves MFH-B, Tiger 2000

Technical data – 5/3-way valves



Dimensions – Pneumatic connection G $\frac{1}{8}$ , G $\frac{1}{4}$

Download CAD Data → [www.festo.com/us/cad](http://www.festo.com/us/cad)

Basic valve

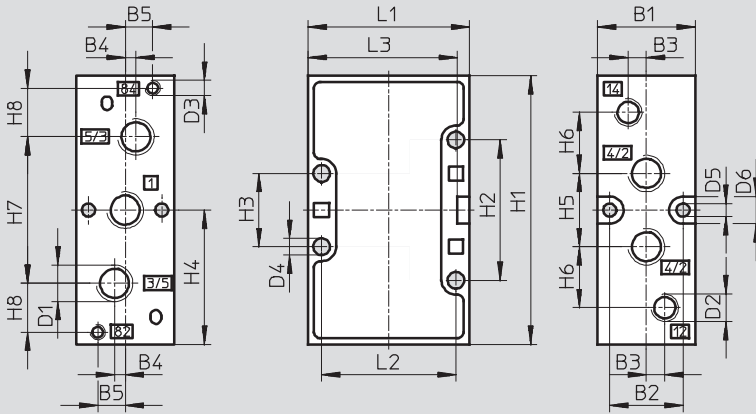

Installation dimensions with F solenoid coil, mechanical or pneumatic reset

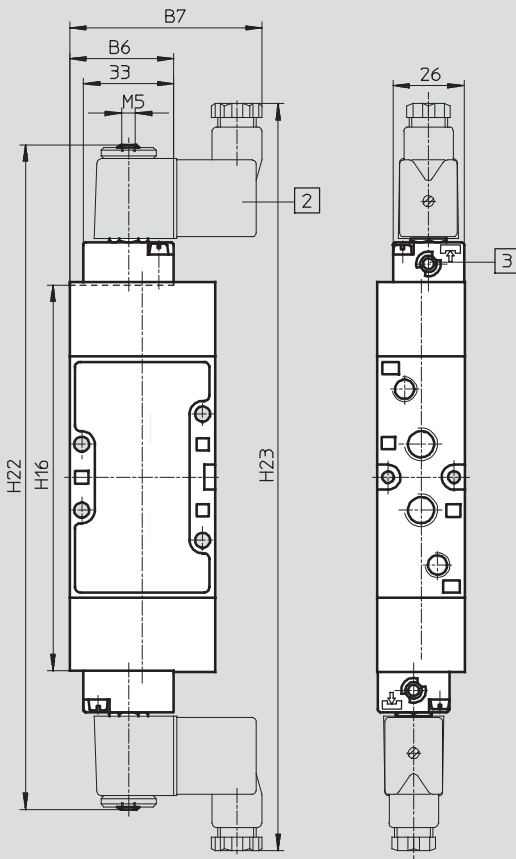

- 2 Solenoid coil is 360° rotatable
- 3 Manual override can be repositioned by 180°

Pneumatic connection	B1	B2	B3	B4	B5	B6	B7	D1	D2	D3	D4	D5	D6	H1
G $\frac{1}{8}$	26	19.5	5	3.5	8	36.8	67	G $\frac{1}{8}$	G $\frac{1}{8}$	M5	4.5	4.3	9	77
G $\frac{1}{4}$	32	24	6	3.5	9	38	70	G $\frac{1}{4}$	G $\frac{1}{8}$	M5	5.5	4.3	9	88

Pneumatic connection	H2	H3	H4	H5	H6	H7	H8	H16	H22	H23	L1	L2	L3
G $\frac{1}{8}$	41	21	38.5	22	19	42	12	129	227	260	47	40	43
G $\frac{1}{4}$	46	24	44	24	20	48	16	141.5	240	273	53	44	49

# Solenoid valves MFH-B, Tiger 2000

Technical data – 5/3-way valves

## Dimensions – Pneumatic connection G<sup>3</sup>/<sub>8</sub>

Download CAD Data → [www.festo.com/us/cad](http://www.festo.com/us/cad)

### Basic valve

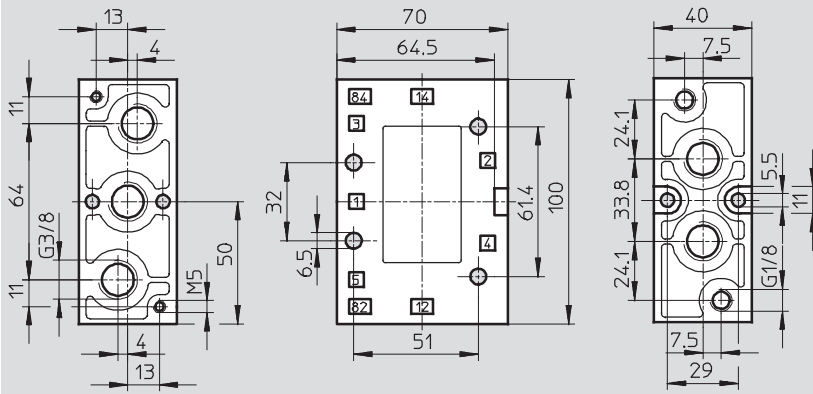

### Installation dimensions with F solenoid coil, mechanical or pneumatic reset

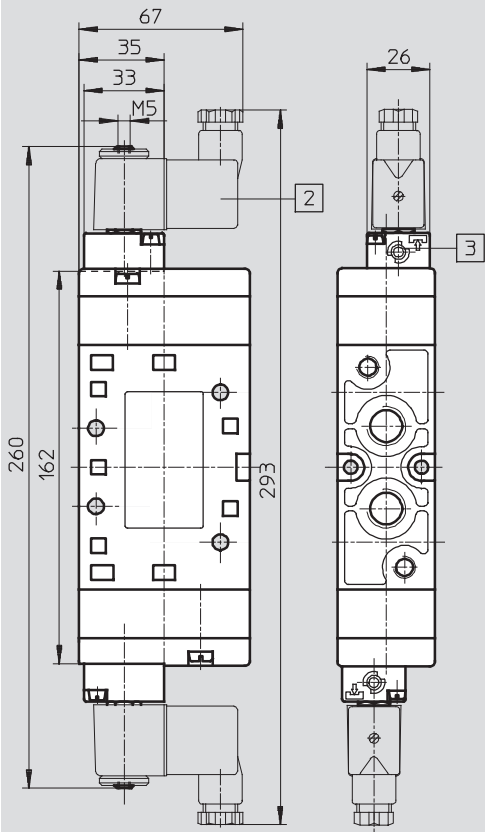

- 2 Solenoid coil is 360° rotatable
- 3 Manual override can be repositioned by 180°

# Solenoid valves MFH-B, Tiger 2000

Technical data – 5/3-way valves



Ordering data				
Circuit symbol	Description	Pneumatic connection	Part No.	Type
	Without F solenoid coil <sup>1)</sup> , normally closed, internal pilot air supply	G $\frac{1}{8}$	30484	MFH-5/3G-1/8-B
		G $\frac{1}{4}$	19787	MFH-5/3G-1/4-B
		G $\frac{3}{8}$	19707	MFH-5/3G-3/8-B
	Without F solenoid coil <sup>1)</sup> , normally closed, external pilot air supply	G $\frac{1}{8}$	30993	MFH-5/3G-1/8-S-B
		G $\frac{1}{4}$	31001	MFH-5/3G-1/4-S-B
		G $\frac{3}{8}$	31317	MFH-5/3G-3/8-S-B
	Without F solenoid coil <sup>1)</sup> , normally exhausted, internal pilot air supply	G $\frac{1}{8}$	30483	MFH-5/3E-1/8-B
		G $\frac{1}{4}$	19786	MFH-5/3E-1/4-B
		G $\frac{3}{8}$	19708	MFH-5/3E-3/8-B
	Without F solenoid coil <sup>1)</sup> , normally exhausted, external pilot air supply	G $\frac{1}{8}$	30994	MFH-5/3E-1/8-S-B
		G $\frac{1}{4}$	31002	MFH-5/3E-1/4-S-B
		G $\frac{3}{8}$	31318	MFH-5/3E-3/8-S-B
	Without F solenoid coil <sup>1)</sup> , normally pressurised, internal pilot air supply	G $\frac{1}{8}$	30485	MFH-5/3B-1/8-B
		G $\frac{1}{4}$	19788	MFH-5/3B-1/4-B
		G $\frac{3}{8}$	19709	MFH-5/3B-3/8-B
	Without F solenoid coil <sup>1)</sup> , normally pressurised, external pilot air supply	G $\frac{1}{8}$	30995	MFH-5/3B-1/8-S-B
		G $\frac{1}{4}$	31003	MFH-5/3B-1/4-S-B
		G $\frac{3}{8}$	31319	MFH-5/3B-3/8-S-B

1) F solenoid coils → 65

# Solenoid valves MVH-B, Tiger 2000

Technical data – 5/2-way valves

FESTO

Flow rate

750 ... 2000 l/min

Voltage

24 V DC

Wearing parts kits

→ 34



General technical data						
Pneumatic connection	G $\frac{1}{8}$		G $\frac{1}{4}$		G $\frac{3}{8}$	
Type of reset	Mechanical	Pneumatic	Mechanical	Pneumatic	Mechanical	Pneumatic
Valve function	5/2-way, single solenoid					
Constructional design	Poppet	Piston spool	Poppet	Piston spool	Piston spool	
Sealing principle	Soft					
Actuation type	Electrical					
Type of pilot control	Piloted					
Pilot air supply	Internal or external					
Direction of flow	Non-reversible					
Exhaust function	With flow control					
Manual override	Resetting, detenting, covered					
Type of mounting	Via through-holes					
Mounting position	Any					
Nominal size [mm]	5	8	7	10	12	
Standard nominal flow rate [l/min]	750	1000	1300	1600	2000	
Grid dimension [mm]	27		33		41	
Product weight [g]	230	290	360	495	750	

Operating and environmental conditions						
Pneumatic connection	G $\frac{1}{8}$		G $\frac{1}{4}$		G $\frac{3}{8}$	
Type of reset	Pneumatic	Mechanical	Pneumatic	Mechanical	Pneumatic	Mechanical
Operating medium	Compressed air in accordance with ISO 8573-1:2010 [7:4:4]					
Pilot medium	Compressed air in accordance with ISO 8573-1:2010 [7:4:4]					
Note on operating/ pilot medium	Operation with lubricated medium possible (in which case lubricated operation will always be required)					
Operating pressure	Internal pilot air supply [bar]	3 ... 10	2 ... 10	3 ... 10	2 ... 10	2 ... 10
	External pilot air supply [bar]	-0.9 ... +10	0 ... 10	-0.9 ... +10	0 ... 10	-0.9 ... +10
Pilot pressure [bar]	3 ... 10	2 ... 10	3 ... 10	1.5 ... 10	2 ... 10	2 ... 10
Ambient temperature [°C]	-5 ... +50					
Temperature of medium [°C]	-5 ... +50					
Note on materials	RoHS-compliant					

# Solenoid valves MVH-B, Tiger 2000

Technical data – 5/2-way valves

## Minimum pilot pressure $p_{12}/p_{14}$ as a function of the operating pressure $p_1$ (external pilot air supply)

MVH-5-1/8-S-B

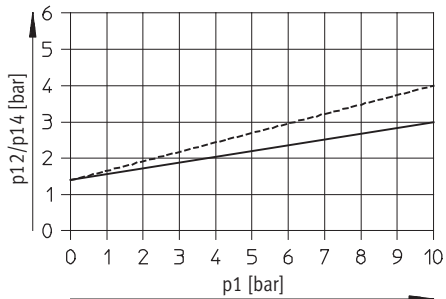

----- Exhaust throttled  
 ———— Exhaust unthrottled

MVH-5-1/4-S-B

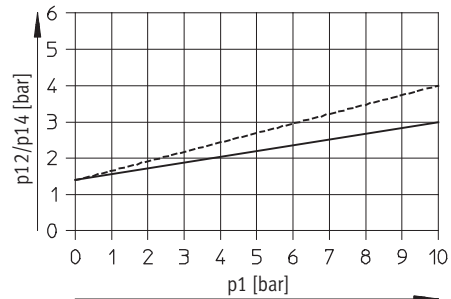

----- Exhaust throttled  
 ———— Exhaust unthrottled

MVH-5-3/8-S-B

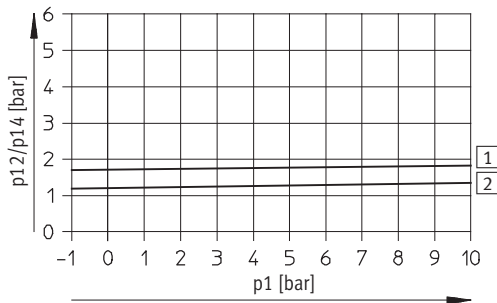

1 On  
 2 Off

## Valve response times [ms]

Pneumatic connection	G1/8		G1/4		G3/8	
Type of reset	Pneumatic	Mechanical	Pneumatic	Mechanical	Pneumatic	Mechanical
On	31	20	33	15	22	22
Off	18	36	40	36	60	60

# Solenoid valves MVH-B, Tiger 2000

Technical data – 5/2-way valves

Electrical data			
V solenoid			
Electrical connection		To EN 175301-803 type B	
Operating voltage	D.C. voltage	[V DC]	24
Coil characteristics	D.C. voltage	[W]	2.5
Protection class to EN 60 529			IP65 (in combination with plug socket)

## Materials

Sectional view

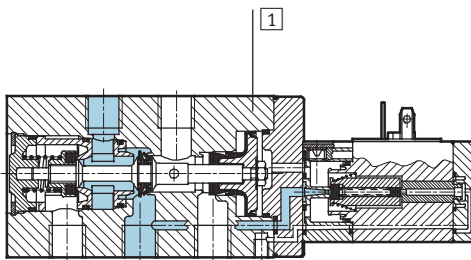

1	Housing	Die-cast aluminium, plastic
-	Seals	Nitrile rubber

# Solenoid valves MVH-B, Tiger 2000

Technical data – 5/2-way valves



## Dimensions – Pneumatic connection G $\frac{1}{8}$ , G $\frac{1}{4}$

Download CAD Data → [www.festo.com/us/cad](http://www.festo.com/us/cad)

### Basic valve

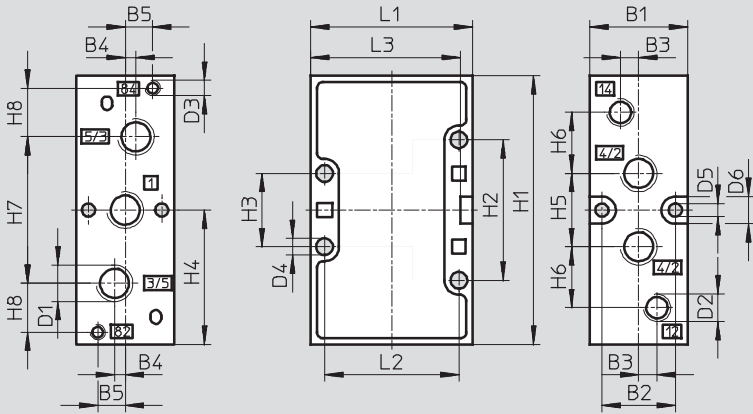

### Installation dimensions with V solenoid coil

#### Mechanical reset

#### Pneumatic reset

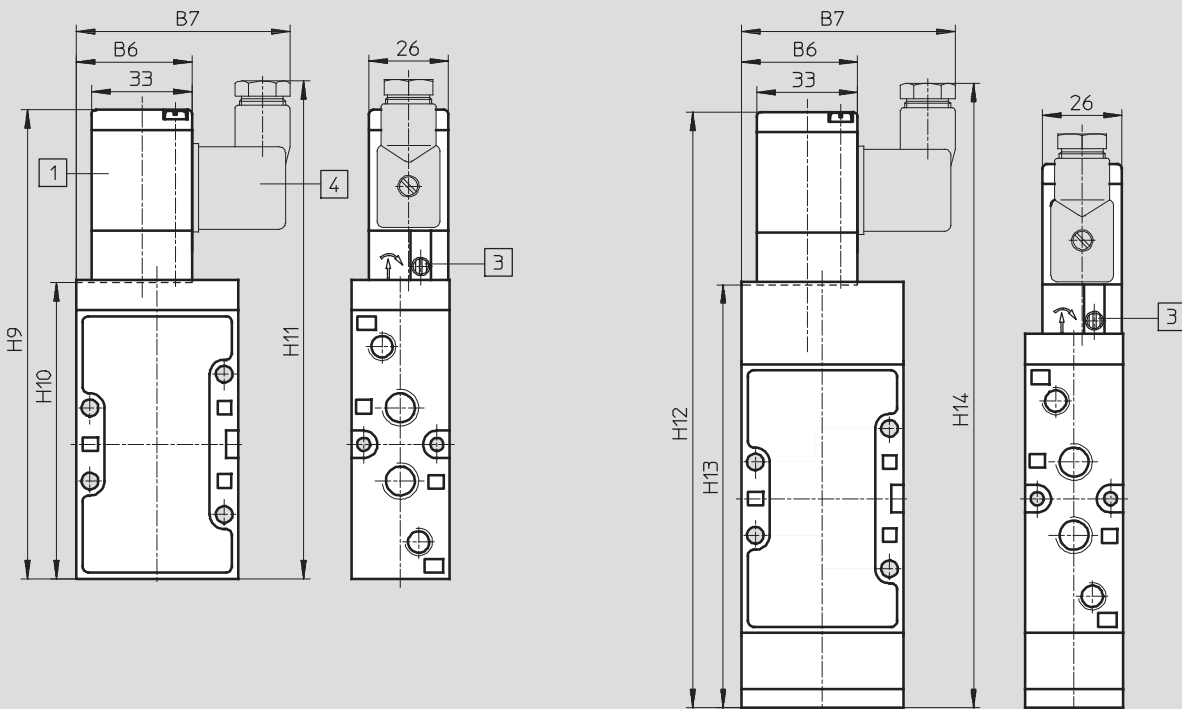

1 Solenoid coil can be repositioned by 180°

3 Manual override can be repositioned by 180°

4 Plug socket connection to EN 175301-803 type B

Pneumatic connection	B1	B2	B3	B4	B5	B6	B7	D1	D2	D3	D4	D5	D6	H1	H2	H3	H4
G $\frac{1}{8}$	26	19.5	5	3.5	8	36.8	67	G $\frac{1}{8}$	G $\frac{1}{8}$	M5	4.5	4.3	9	77	41	21	38.5
G $\frac{1}{4}$	32	24	6	3.5	9	38	70	G $\frac{1}{4}$	G $\frac{1}{8}$	M5	5.5	4.3	9	88	46	24	44

Pneumatic connection	H5	H6	H7	H8	H9	H10	H11	H12	H13	H14	H18	H19	H20	H21	L1	L2	L3
G $\frac{1}{8}$	22	19	42	12	143	86.5	153	183	126.2	193	136	152	175	192	47	40	43
G $\frac{1}{4}$	24	20	48	16	154	97.5	163	196	139	206	147	163	188	205	53	44	49



# Solenoid valves MVH-B, Tiger 2000

Technical data – 5/2-way valves

## Dimensions – Pneumatic connection G $\frac{3}{8}$

Download CAD Data → [www.festo.com/us/cad](http://www.festo.com/us/cad)

### Basic valve

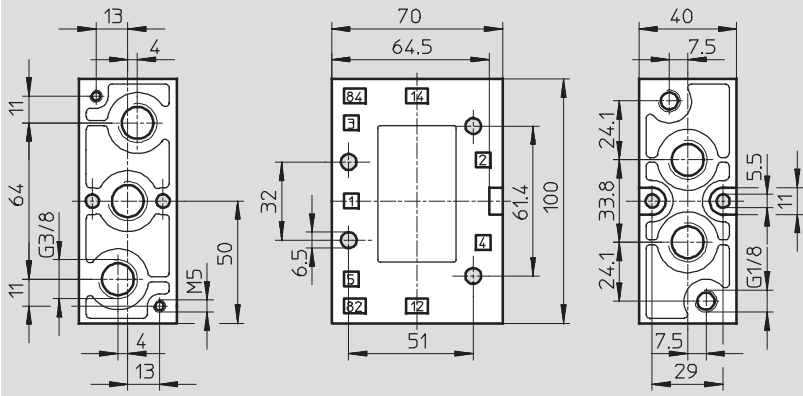

### Installation dimensions with V solenoid coil

#### Mechanical or pneumatic reset

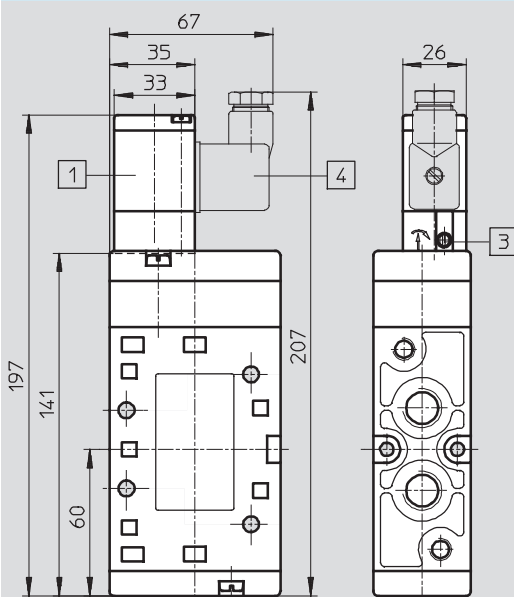

- 1 Solenoid coil is 360° rotatable
- 3 Manual override can be repositioned by 180°
- 4 Plug socket connection to EN 175301-803 type B

# Solenoid valves MVH-B, Tiger 2000

Technical data – 5/2-way valves

Ordering data					
Circuit symbol	Description	Voltage	Pneumatic connection	Part No.	Type
	With V solenoid coil, pneumatic reset, internal pilot air supply	24 V DC	G $\frac{1}{8}$	<b>19749</b>	<b>MVH-5-1/8-L-B</b>
			G $\frac{1}{4}$	<b>31009</b>	<b>MVH-5-1/4-L-B</b>
			G $\frac{3}{8}$	<b>14947</b>	<b>MVH-5-3/8-L-B</b>
	With V solenoid coil, pneumatic reset, external pilot air supply	24 V DC	G $\frac{1}{8}$	<b>19750</b>	<b>MVH-5-1/8-L-S-B</b>
			G $\frac{1}{4}$	<b>33184</b>	<b>MVH-5-1/4-L-S-B</b>
			G $\frac{3}{8}$	<b>33180</b>	<b>MVH-5-3/8-L-S-B</b>
	With V solenoid coil, mechanical reset, internal pilot air supply	24 V DC	G $\frac{1}{8}$	<b>19779</b>	<b>MVH-5-1/8-B</b>
			G $\frac{1}{4}$	<b>19701</b>	<b>MVH-5-1/4-B</b>
			G $\frac{3}{8}$	<b>14945</b>	<b>MVH-5-3/8-B</b>
	With V solenoid coil, mechanical reset, external pilot air supply	24 V DC	G $\frac{1}{8}$	<b>30996</b>	<b>MVH-5-1/8-S-B</b>
			G $\frac{1}{4}$	<b>15903</b>	<b>MVH-5-1/4-S-B</b>
			G $\frac{3}{8}$	<b>15342</b>	<b>MVH-5-3/8-S-B</b>

Ordering data – Wearing parts kits		
Pneumatic connection	Part No.	Type
G $\frac{1}{8}$	<b>125071</b>	<b>MVH-5-1/8-B</b>
G $\frac{1}{4}$	<b>115588</b>	<b>MVH-5-1/4-B</b>
G $\frac{3}{8}$	<b>115074</b>	<b>MVH-5-3/8-B</b>

# Solenoid valves JMVH-B, Tiger 2000

Technical data – 5/2-way valves, double solenoid

FESTO

Flow rate

1000 ... 2000 l/min

Voltage

24 V DC

Wearing parts kits

→ 40



General technical data				
Pneumatic connection	G1/8	G1/4	G3/8	
Valve function	5/2-way, double solenoid			
Constructional design	Piston spool			
Sealing principle	Soft			
Actuation type	Electrical			
Type of pilot control	Piloted			
Pilot air supply	Internal or external			
Direction of flow	Non-reversible			
Exhaust function	With flow control			
Manual override	Resetting, detenting, covered			
Type of mounting	Via through-holes			
Mounting position	Any			
Nominal size	[mm]	5	7	12
Standard nominal flow rate	[l/min]	750	1300	2000
Grid dimension	[mm]	27	33	41
Product weight	[g]	560	615	900

Operating and environmental conditions					
Pneumatic connection	G1/8	G1/4	G3/8		
Operating medium	Compressed air in accordance with ISO 8573-1:2010 [7:4:4]				
Pilot medium	Compressed air in accordance with ISO 8573-1:2010 [7:4:4]				
Note on operating/ pilot medium	Operation with lubricated medium possible (in which case lubricated operation will always be required)				
Operating pressure	Internal pilot air supply	[bar]	2 ... 10	2 ... 10	2 ... 10
	External pilot air supply	[bar]	-0.9 ... +10	-0.9 ... +10	-0.9 ... +10
Pilot pressure	[bar]	2 ... 10	2 ... 10	2 ... 10	
Ambient temperature	[°C]	-5 ... +50			
Temperature of medium	[°C]	-5 ... +50			
Note on materials	RoHS-compliant				

# Solenoid valves JMVH-B, Tiger 2000

Technical data – 5/2-way valves, double solenoid

## Minimum pilot pressure $p_{12}/p_{14}$ as a function of the operating pressure $p_1$ (external pilot air supply)

JMVH-5-1/8-S-B

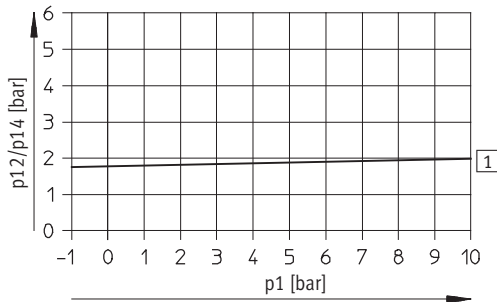

1 On

JMVH-5-1/4-S-B

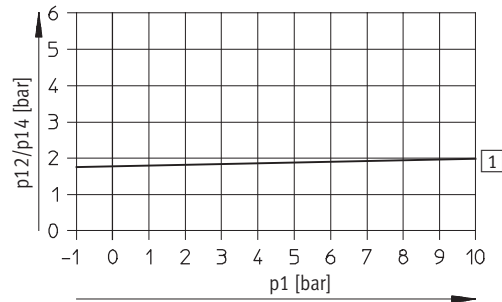

1 On

JMVH-5-3/8-S-B

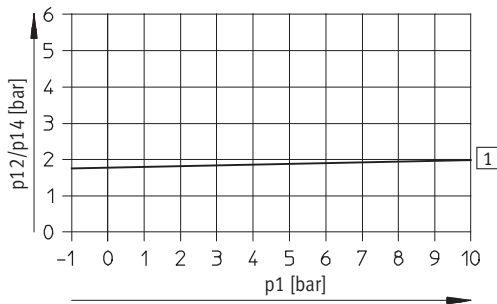

1 On

## Valve response times [ms]

Pneumatic connection	G1/8	G1/4	G3/8
Changeover	18	16	17

# Solenoid valves JMVH-B, Tiger 2000

Technical data – 5/2-way valves, double solenoid

Electrical data			
V solenoid			
Electrical connection			To EN 175301-803 type B
Operating voltage	D.C. voltage	[V DC]	24
Coil characteristics	D.C. voltage	[W]	2.5
Protection class to EN 60 529			IP65 (in combination with plug socket)

## Materials

Sectional view

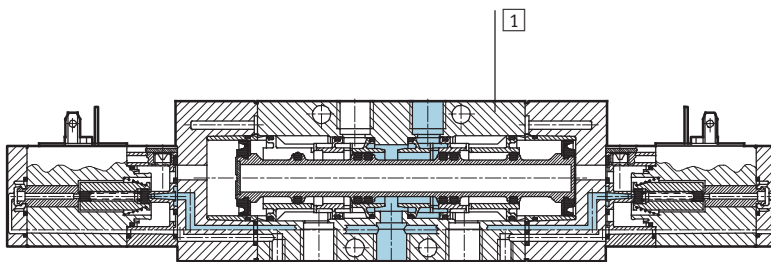

1	Housing	Die-cast aluminium, plastic
-	Seals	Nitrile rubber

# Solenoid valves JMVH-B, Tiger 2000

Technical data – 5/2-way valves, double solenoid



Dimensions – Pneumatic connection G $\frac{1}{8}$ , G $\frac{1}{4}$

Download CAD Data → [www.festo.com/us/cad](http://www.festo.com/us/cad)

Basic valve

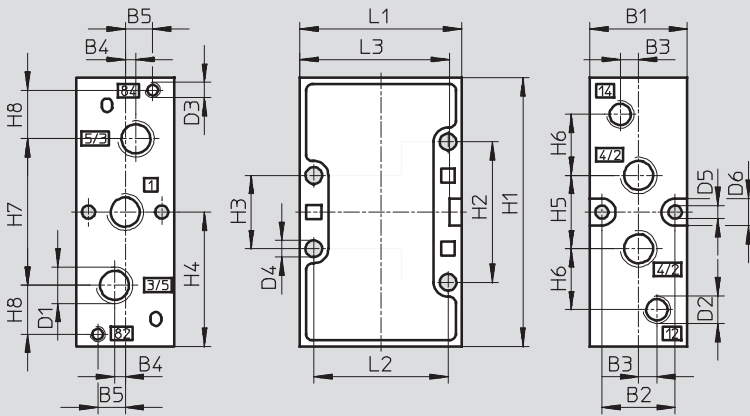

Installation dimensions with V solenoid coil, mechanical or pneumatic reset

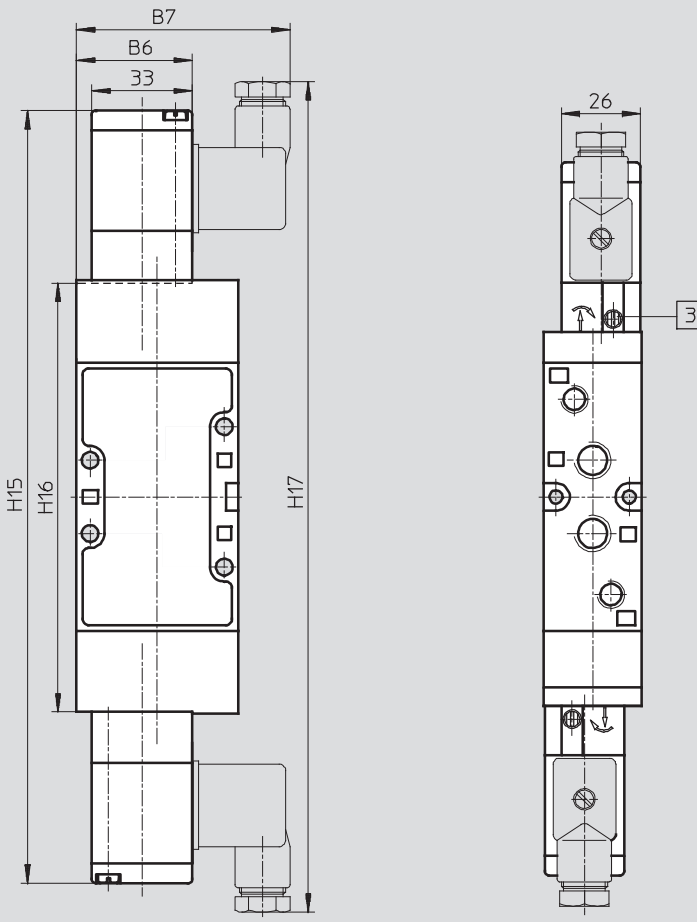

3 Manual override can be repositioned by 180°

Pneumatic connection	B1	B2	B3	B4	B5	B6	B7	D1	D2	D3	D4	D5	D6	H1
G $\frac{1}{8}$	26	19.5	5	3.5	8	36.8	67	G $\frac{1}{8}$	G $\frac{1}{8}$	M5	4.5	4.3	9	77
G $\frac{1}{4}$	32	24	6	3.5	9	38	70	G $\frac{1}{4}$	G $\frac{1}{8}$	M5	5.5	4.3	9	88

Pneumatic connection	H2	H3	H4	H5	H6	H7	H8	H15	H16	H17	L1	L2	L3
G $\frac{1}{8}$	41	21	38.5	22	19	42	12	242	129	262	47	40	43
G $\frac{1}{4}$	46	24	44	24	20	48	16	255	141.5	275	53	44	49

# Solenoid valves JMVH-B, Tiger 2000

Technical data – 5/2-way valves, double solenoid

## Dimensions – Pneumatic connection G $\frac{3}{8}$

Download CAD Data → [www.festo.com/us/cad](http://www.festo.com/us/cad)

### Basic valve

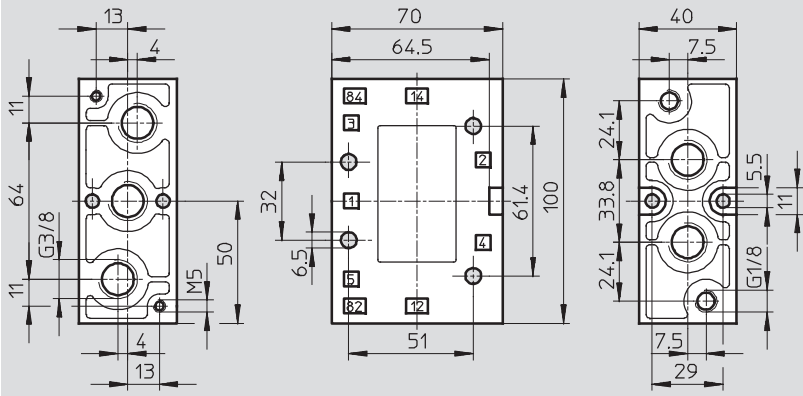

### Installation dimensions with V solenoid coil, mechanical or pneumatic reset

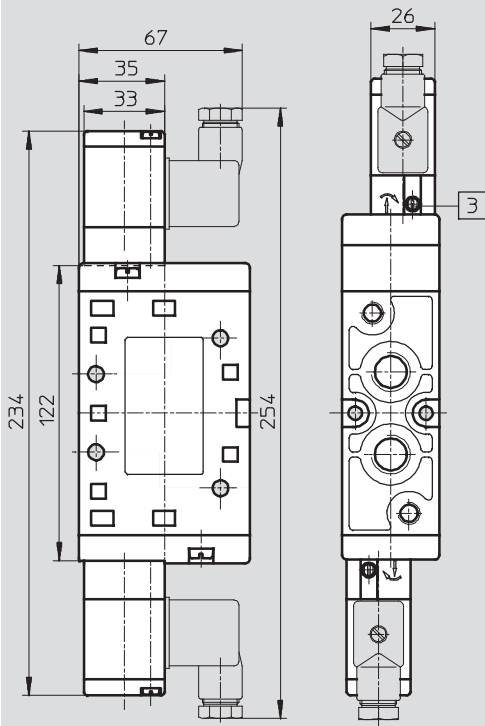

3 Manual override can be repositioned by 180°

# Solenoid valves JMVH-B, Tiger 2000

FESTO

Technical data – 5/2-way valves, double solenoid

Ordering data					
Circuit symbol	Solenoid coil	Voltage	Pneumatic connection	Part No.	Type
	With V solenoid coil, internal pilot air supply	24 V DC	G $\frac{1}{8}$	<b>30475</b>	<b>JMVH-5-<math>\frac{1}{8}</math>-B</b>
			G $\frac{1}{4}$	<b>19136</b>	<b>JMVH-5-<math>\frac{1}{4}</math>-B</b>
			G $\frac{3}{8}$	<b>14948</b>	<b>JMVH-5-<math>\frac{3}{8}</math>-B</b>
	With V solenoid coil, external pilot air supply	24 V DC	G $\frac{1}{8}$	<b>30476</b>	<b>JMVH-5-<math>\frac{1}{8}</math>-S-B</b>
			G $\frac{1}{4}$	<b>19137</b>	<b>JMVH-5-<math>\frac{1}{4}</math>-S-B</b>
			G $\frac{3}{8}$	<b>15343</b>	<b>JMVH-5-<math>\frac{3}{8}</math>-S-B</b>

Ordering data – Wearing parts kits		
Pneumatic connection	Part No.	Type
G $\frac{1}{8}$	<b>115590</b>	<b>JMVH-5-<math>\frac{1}{8}</math>-B-(SB)</b>
G $\frac{1}{4}$	<b>115589</b>	<b>JMVH-5-<math>\frac{1}{4}</math>-B-(SB)</b>



# Solenoid valves MVH-B, Tiger 2000

Technical data – 5/3-way valves

Flow rate

1000 ... 2600 l/min

Voltage

24 V DC



General technical data				
Pneumatic connection		G $\frac{1}{8}$	G $\frac{1}{4}$	G $\frac{3}{8}$
Valve function		5/3-way, double solenoid		
Constructional design		Piston spool		
Sealing principle		Soft		
Actuation type		Electrical		
Type of reset		Mechanical spring		
Type of pilot control		Piloted		
Pilot air supply		Internal or external		
Direction of flow		Non-reversible		
Exhaust function		With flow control		
Manual override		Resetting, detenting, covered		
Type of mounting		Via through-holes		
Mounting position		Any		
Nominal size [mm]		5	7	12
Standard nominal flow rate	Closed [l/min]	1000	1600	2000
	Exhausted [l/min]			2200
	Pressurised [l/min]			2600
Grid dimension [mm]		27	33	41
Product weight [g]		575	660	1000

Operating and environmental conditions				
Pneumatic connection		G $\frac{1}{8}$	G $\frac{1}{4}$	G $\frac{3}{8}$
Operating medium		Compressed air in accordance with ISO 8573-1:2010 [7:4:4]		
Pilot medium		Compressed air in accordance with ISO 8573-1:2010 [7:4:4]		
Note on operating/ pilot medium		Operation with lubricated medium possible (in which case lubricated operation will always be required)		
Operating pressure	Internal pilot air supply [bar]	3 ... 10	3 ... 10	3 ... 10
	External pilot air supply [bar]	-0.9 ... +10	-0.9 ... +10	-0.9 ... +10
Pilot pressure [bar]		3 ... 10	3 ... 10	3 ... 10
Ambient temperature [°C]		-5 ... +50		
Temperature of medium [°C]		-5 ... +50		
Note on materials		RoHS-compliant		

# Solenoid valves MVH-B, Tiger 2000

Technical data – 5/3-way valves

## Minimum pilot pressure $p_{12}/p_{14}$ as a function of the operating pressure $p_1$ (external pilot air supply)

MVH-5/3...-1/8-S-B

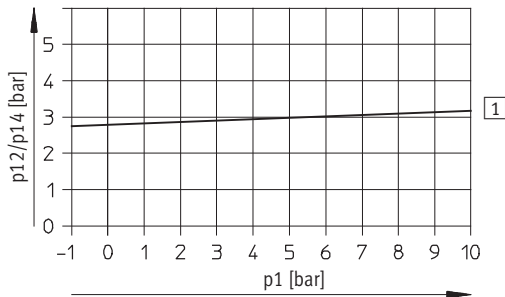

1 On

MVH-5/3...-1/4-S-B

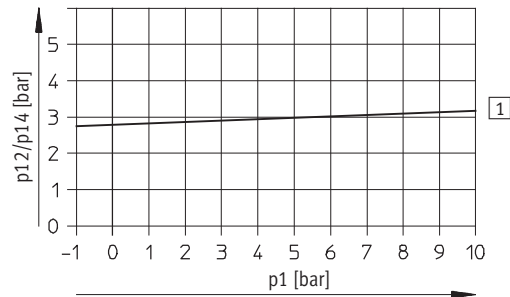

1 On

MVH-5/3...-3/8-S-B

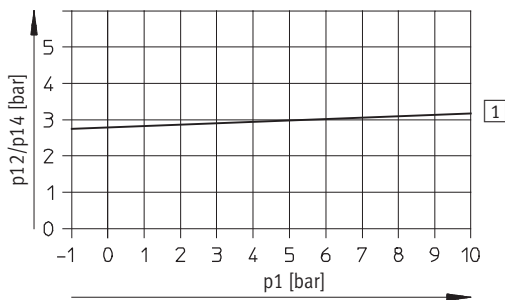

1 On

## Valve response times [ms]

Pneumatic connection	G <sup>1</sup> / <sub>8</sub>		G <sup>1</sup> / <sub>4</sub>		G <sup>3</sup> / <sub>8</sub>	
	On	Off	On	Off	On	Off
Closed	18	20	20	22	24	80
Exhausted	20	20	24	36	36	85
Pressurised	24	24	34	30	30	82

# Solenoid valves MVH-B, Tiger 2000

Technical data – 5/3-way valves

Electrical data			
V solenoid			
Electrical connection		To EN 175301-803 type B	
Operating voltage	D.C. voltage	[V DC]	24
Coil characteristics	D.C. voltage	[W]	2.5
Protection class to EN 60 529		IP65 (in combination with plug socket)	

## Materials

Sectional view

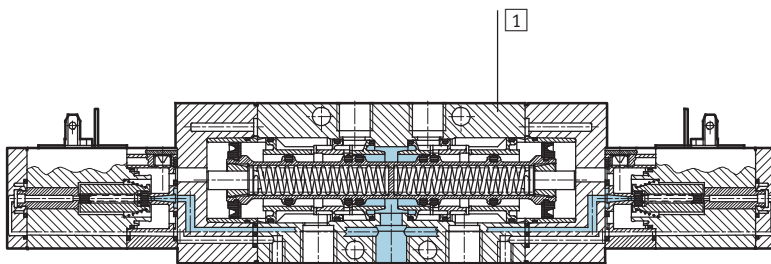

1	Housing	Die-cast aluminium, plastic
-	Seals	Nitrile rubber

# Solenoid valves MVH-B, Tiger 2000

Technical data – 5/3-way valves



## Dimensions – Pneumatic connection G<sup>1</sup>/<sub>8</sub>, G<sup>1</sup>/<sub>4</sub>

Download CAD Data → [www.festo.com/us/cad](http://www.festo.com/us/cad)

Basic valve

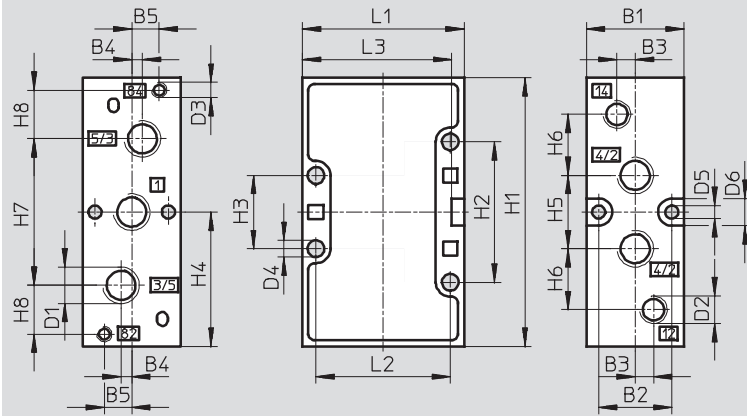

## Installation dimensions with V solenoid coil, mechanical or pneumatic reset

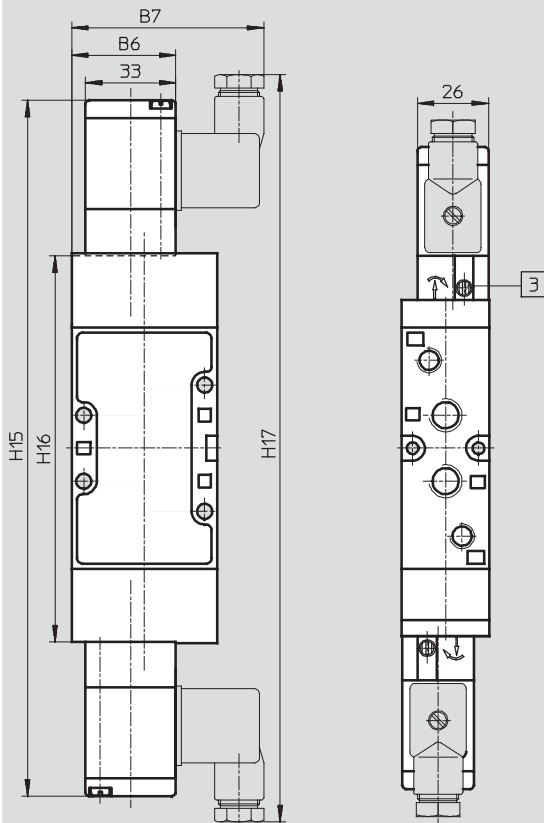

3 Manual override can be repositioned by 180°

Pneumatic connection	B1	B2	B3	B4	B5	B6	B7	D1	D2	D3	D4	D5	D6	H1
G <sup>1</sup> / <sub>8</sub>	26	19.5	5	3.5	8	36.8	67	G <sup>1</sup> / <sub>8</sub>	G <sup>1</sup> / <sub>8</sub>	M5	4.5	4.3	9	77
G <sup>1</sup> / <sub>4</sub>	32	24	6	3.5	9	38	70	G <sup>1</sup> / <sub>4</sub>	G <sup>1</sup> / <sub>8</sub>	M5	5.5	4.3	9	88

Pneumatic connection	H2	H3	H4	H5	H6	H7	H8	H15	H16	H17	L1	L2	L3
G <sup>1</sup> / <sub>8</sub>	41	21	38.5	22	19	42	12	242	129	262	47	40	43
G <sup>1</sup> / <sub>4</sub>	46	24	44	24	20	48	16	255	141.5	275	53	44	49

# Solenoid valves MVH-B, Tiger 2000

Technical data – 5/3-way valves

## Dimensions – Pneumatic connection G $\frac{3}{8}$

Download CAD Data → [www.festo.com/us/cad](http://www.festo.com/us/cad)

### Basic valve

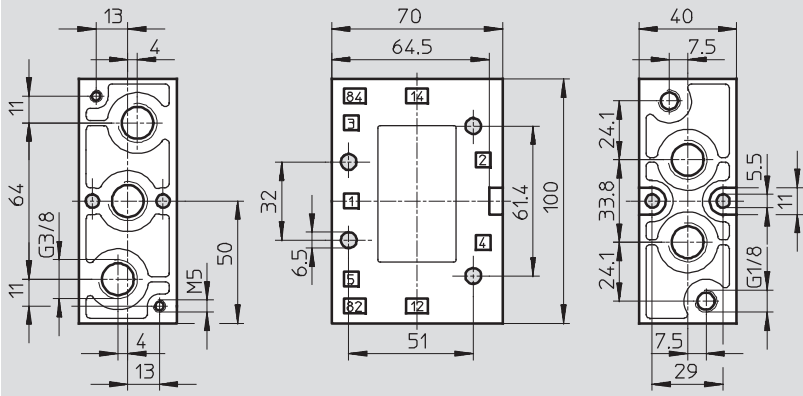

### Installation dimensions with V solenoid coil, mechanical or pneumatic reset

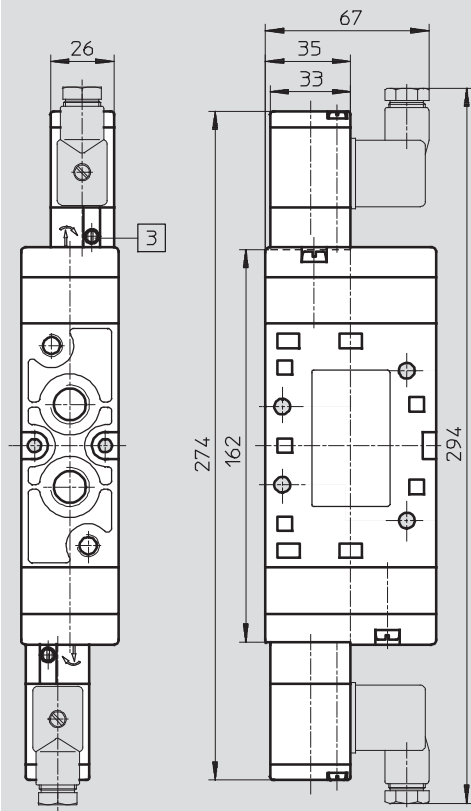

3 Manual override can be repositioned by 180°

# Solenoid valves MVH-B, Tiger 2000

Technical data – 5/3-way valves

Ordering data					
Circuit symbol	Description	Voltage	Pneumatic connection	Part No.	Type
	With V solenoid coil, normally closed, internal pilot air supply	24 V DC	G $\frac{1}{8}$	30477	MVH-5/3G-1/8-B
			G $\frac{1}{4}$	19138	MVH-5/3G-1/4-B
			G $\frac{3}{8}$	14944	MVH-5/3G-3/8-B
	With V solenoid coil, normally closed, external pilot air supply	24 V DC	G $\frac{1}{8}$	30997	MVH-5/3G-1/8-S-B
			G $\frac{1}{4}$	31004	MVH-5/3G-1/4-S-B
			G $\frac{3}{8}$	15346	MVH-5/3G-3/8-S-B
	With V solenoid coil, normally exhausted, internal pilot air supply	24 V DC	G $\frac{1}{8}$	30478	MVH-5/3E-1/8-B
			G $\frac{1}{4}$	19139	MVH-5/3E-1/4-B
			G $\frac{3}{8}$	14943	MVH-5/3E-3/8-B
	With V solenoid coil, normally exhausted, external pilot air supply	24 V DC	G $\frac{1}{8}$	30998	MVH-5/3E-1/8-S-B
			G $\frac{1}{4}$	31005	MVH-5/3E-1/4-S-B
			G $\frac{3}{8}$	15344	MVH-5/3E-3/8-S-B
	With V solenoid coil, normally pressurised, internal pilot air supply	24 V DC	G $\frac{1}{8}$	30480	MVH-5/3B-1/8-B
			G $\frac{1}{4}$	19140	MVH-5/3B-1/4-B
			G $\frac{3}{8}$	19699	MVH-5/3B-3/8-B
	With V solenoid coil, normally pressurised, external pilot air supply	24 V DC	G $\frac{1}{8}$	30999	MVH-5/3B-1/8-S-B
			G $\frac{1}{4}$	31006	MVH-5/3B-1/4-S-B
			G $\frac{3}{8}$	15345	MVH-5/3B-3/8-S-B

# Pneumatic valves, Tiger 2000

Peripherals overview

FESTO

## Mounting on manifold

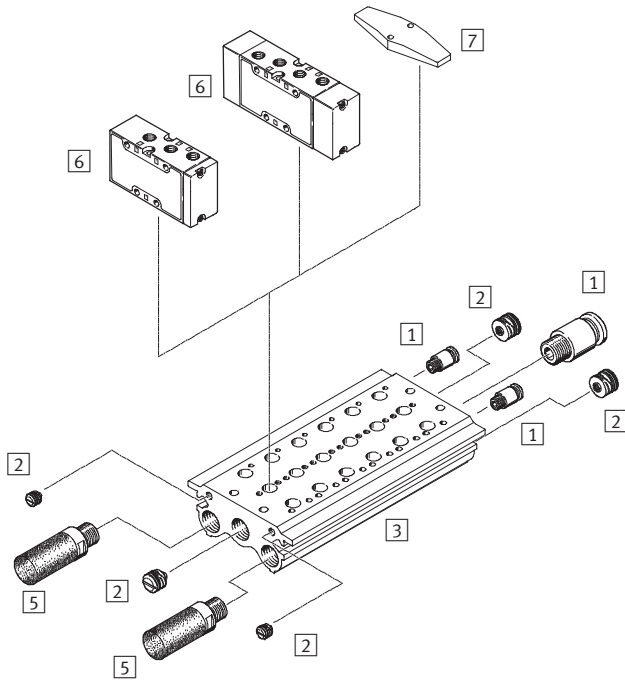

## Mounting on manifold strip

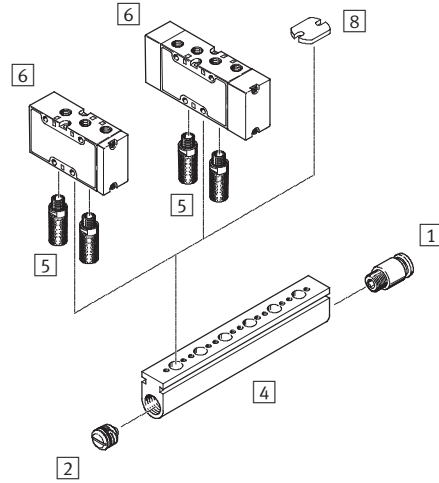

Accessories		
	Brief description	→ Page/Internet
1	Push-in fitting QS	For connecting compressed air tubing with standard O.D. quick star
2	Sealing plug PRSV	64
3	Manifold PRS	62
4	Manifold strip PAL	60
5	Silencer	For fitting in exhaust ports u
6	Pneumatic valve VL, J	5
7	Blanking plate PRSB	For covering vacant positions 64
8	Blanking plate PALB	For covering vacant positions 64

# Pneumatic valves, Tiger 2000

Type code

FESTO

		VL	-	5/3	G	-	1/8	-	B
<b>Type</b>									
VL	Single pilot								
J	Double pilot								
<b>Valve function</b>									
5	5/2-way valve								
5/3	5/3-way valve								
<b>Normal position</b>									
G	Closed								
E	Exhausted								
B	Pressurised								
<b>Pneumatic connection</b>									
1/8	G1/8								
1/4	G1/4								
3/8	G3/8								
<b>Generation</b>									
B	Series B								



# Pneumatic valves VL, Tiger 2000

Technical data – 5/2-way valves

Flow rate

750 ... 2000 l/min

Wearing parts kits

→ 52



General technical data			
Pneumatic connection	G1/8	G1/4	G3/8
Valve function	5/2-way, single pilot		
Constructional design	Poppet		Piston spool
Sealing principle	Soft		
Actuation type	Pneumatic		
Type of reset	Mechanical spring		
Type of pilot control	Direct		
Direction of flow	Non-reversible		Reversible
Exhaust function	With flow control		
Manual override	None		
Type of mounting	Via through-holes		
Mounting position	Any		
Nominal size [mm]	5	7	12
Standard nominal flow rate [l/min]	750	1300	2000
Grid dimension [mm]	27	33	41
Product weight [g]	170	240	570

Operating and environmental conditions			
Pneumatic connection	G1/8	G1/4	G1/4
Operating medium	Compressed air in accordance with ISO 8573-1:2010 [7:4:4]		
Pilot medium	Compressed air in accordance with ISO 8573-1:2010 [7:4:4]		
Note on operating/ pilot medium	Operation with lubricated medium possible (in which case lubricated operation will always be required)		
Operating pressure [bar]	0 ... 10	0 ... 10	-0.9 ... +10
Pilot pressure [bar]	1.5 ... 10	1.5 ... 10	2 ... 10
Ambient temperature [°C]	-10 ... +60		
Temperature of medium [°C]	-10 ... +60		
Note on materials	RoHS-compliant		

# Pneumatic valves VL, Tiger 2000

Technical data – 5/2-way valves

FESTO

## Minimum pilot pressure $p_{12}$ , $p_{14}$ as a function of the operating pressure $p_1$

VL-5-1/8-B

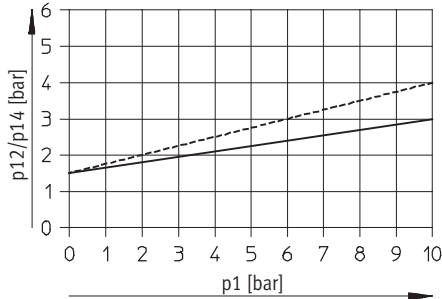

----- Exhaust throttled  
 ————— Exhaust unthrottled

VL-5-1/4-B

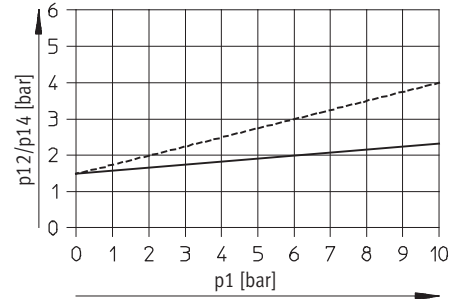

----- Exhaust throttled  
 ————— Exhaust unthrottled

VL-5-3/8-B

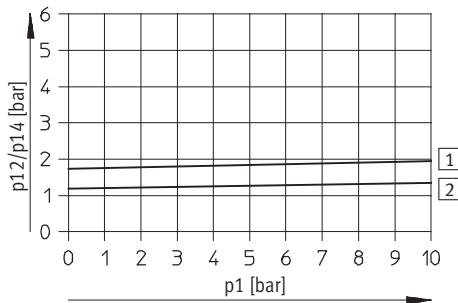

1 On  
 2 Off

## Valve response times [ms]

Pneumatic connection	G1/8	G1/4	G3/8
On	2	2	4
Off	10	12	16

## Materials

Sectional view

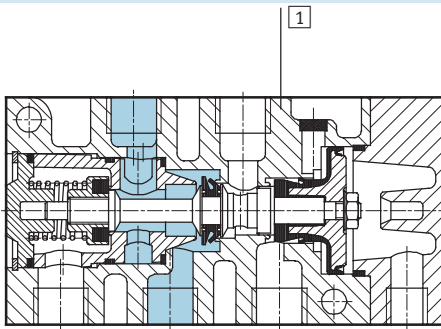

1	Housing	Die-cast aluminium
-	Seals	Nitrile rubber

# Pneumatic valves VL, Tiger 2000

Technical data – 5/2-way valves



## Dimensions – Pneumatic connection G $\frac{1}{8}$ , G $\frac{1}{4}$

Download CAD Data → [www.festo.com/us/cad](http://www.festo.com/us/cad)

Basic valve

VL-5-...-B

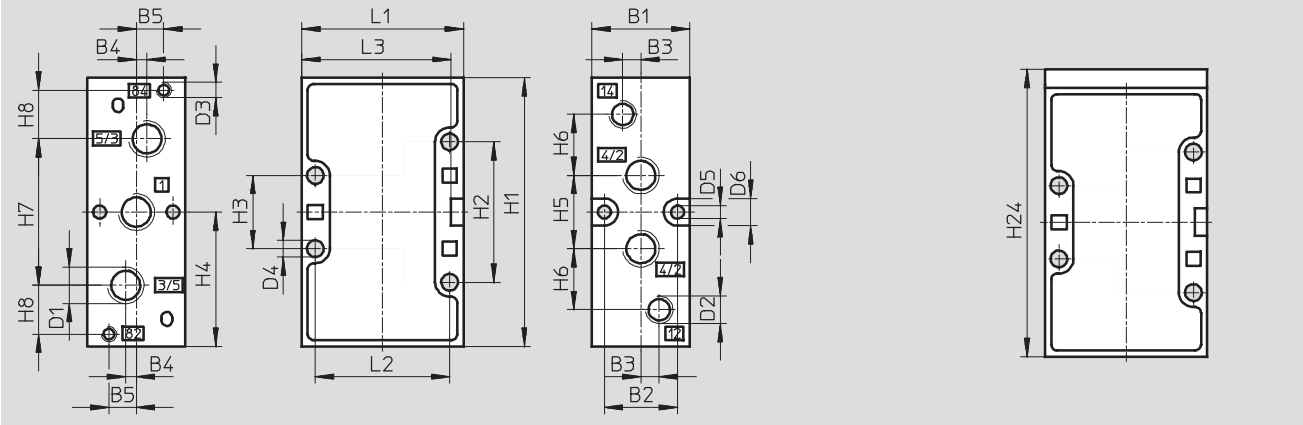

Pneumatic connection	B1	B2	B3	B4	B5	D1	D2	D3	D4	D5	D6	H1
G $\frac{1}{8}$	26	19.5	5	3.5	8	G $\frac{1}{8}$	G $\frac{1}{8}$	M5	4.5	4.3	9	77
G $\frac{1}{4}$	32	24	6	3.5	9	G $\frac{1}{4}$	G $\frac{1}{8}$	M5	5.5	4.3	9	88

Pneumatic connection	H2	H3	H4	H5	H6	H7	H8	H24	L1	L2	L3
G $\frac{1}{8}$	41	21	38.5	22	19	42	12	83	47	40	43
G $\frac{1}{4}$	46	24	44	24	20	48	16	94	53	44	49

## Dimensions – Pneumatic connection G $\frac{3}{8}$

Download CAD Data → [www.festo.com/us/cad](http://www.festo.com/us/cad)

Basic valve

VL-5- $\frac{3}{8}$ -B

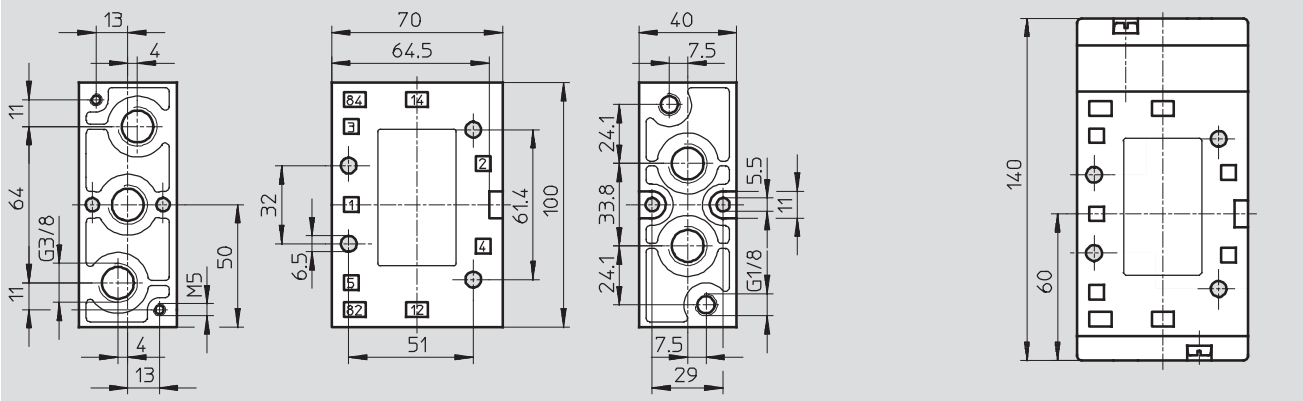

# Pneumatic valves VL, Tiger 2000

Technical data – 5/2-way valves

Ordering data				
Circuit symbol	Description	Pneumatic connection	Part No.	Type
	Mechanical reset	G $\frac{1}{8}$	31000	VL-5- $\frac{1}{8}$ -B
		G $\frac{1}{4}$	14294	VL-5- $\frac{1}{4}$ -B
		G $\frac{3}{8}$	14952	VL-5- $\frac{3}{8}$ -B

Ordering data – Wearing parts kits		
Pneumatic connection	Part No.	Type
G $\frac{1}{8}$	125710	VL-5- $\frac{1}{8}$ -B
G $\frac{1}{4}$	115580	VL-5- $\frac{1}{4}$ -B

# Pneumatic valves J, Tiger 2000

Technical data – 5/2-way valves, double pilot

FESTO

Flow rate

800 ... 2000 l/min



General technical data				
Pneumatic connection	G $\frac{1}{8}$	G $\frac{1}{4}$	G $\frac{3}{8}$	
Valve function	5/2-way, double pilot			
Constructional design	Piston spool			
Sealing principle	Soft			
Actuation type	Pneumatic			
Type of pilot control	Direct			
Direction of flow	Reversible			
Exhaust function	With flow control			
Manual override	None			
Type of mounting	Via through-holes			
Mounting position	Any			
Nominal size	[mm]	8	10	12
Standard nominal flow rate	[l/min]	800	1600	2000
Grid dimension	[mm]	27	33	41
Product weight	[g]	320	375	550

Operating and environmental conditions				
Pneumatic connection	G $\frac{1}{8}$	G $\frac{1}{4}$	G $\frac{1}{4}$	
Operating medium	Compressed air in accordance with ISO 8573-1:2010 [7:4:4]			
Pilot medium	Compressed air in accordance with ISO 8573-1:2010 [7:4:4]			
Note on operating/pilot medium	Operation with lubricated medium possible (in which case lubricated operation will always be required)			
Operating pressure	[bar]	-0.9 ... +10	-0.9 ... +10	-0.9 ... +10
Pilot pressure	[bar]	3 ... 10	3 ... 10	3 ... 10
Ambient temperature	[°C]	-10 ... +60		
Temperature of medium	[°C]	-10 ... +60		
Note on materials	RoHS-compliant			

# Pneumatic valves J, Tiger 2000

Technical data – 5/2-way valves, double pilot

FESTO

## Minimum pilot pressure $p_{12}/p_{14}$ as a function of the operating pressure $p_1$

J-5-3/8-B

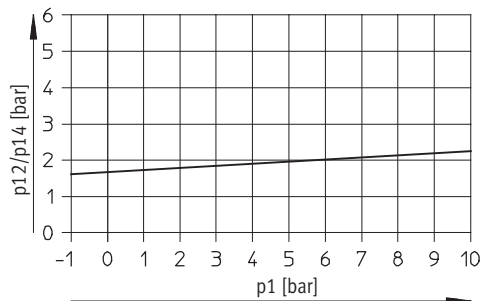

J-5-1/4-B

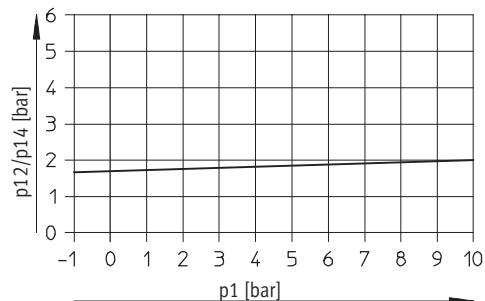

J-5-3/8-B

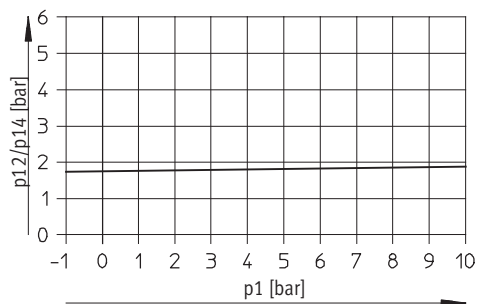

## Valve response times [ms]

Pneumatic connection	G1/8	G1/4	G3/8
Changeover	3	3	3

## Materials

Sectional view

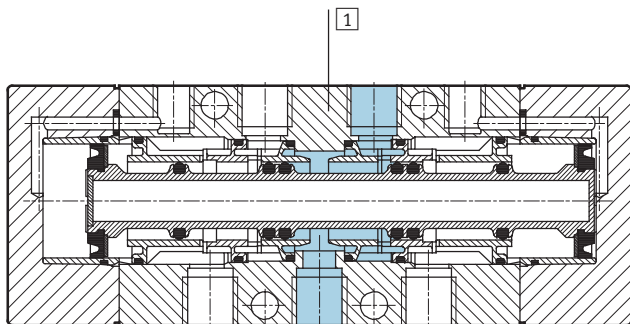

1	Housing	Die-cast aluminium
-	Seals	Nitrile rubber

# Pneumatic valves J, Tiger 2000

Technical data – 5/2-way valves, double pilot



## Dimensions – Pneumatic connection G<sup>1</sup>/<sub>8</sub>, G<sup>1</sup>/<sub>4</sub>

Download CAD Data → [www.festo.com/us/cad](http://www.festo.com/us/cad)

Basic valve

J-5-...-B

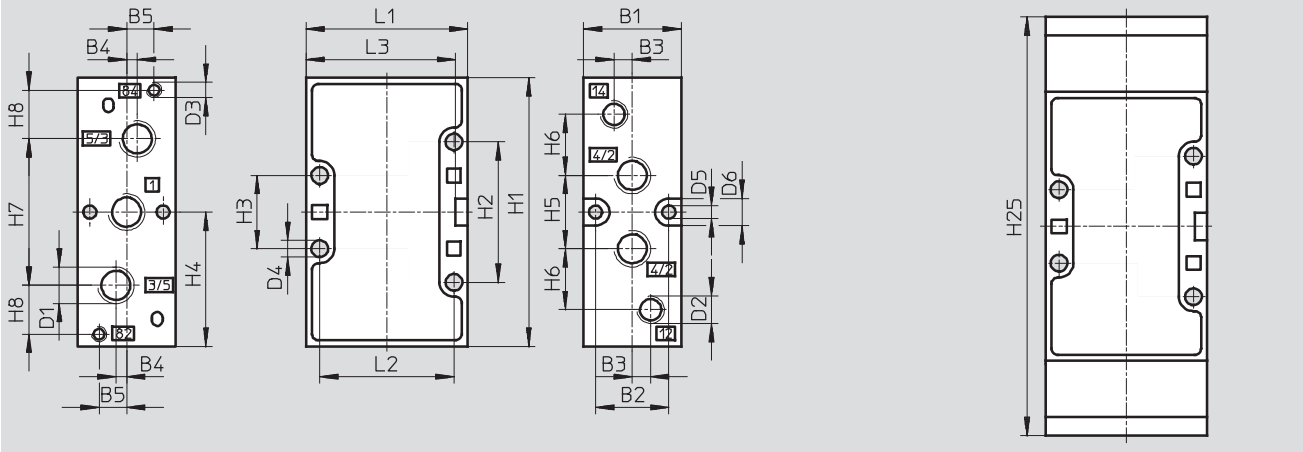

Pneumatic connection	B1	B2	B3	B4	B5	D1	D2	D3	D4	D5	D6	H1
G <sup>1</sup> / <sub>8</sub>	26	19.5	5	3.5	8	G <sup>1</sup> / <sub>8</sub>	G <sup>1</sup> / <sub>8</sub>	M5	4.5	4.3	9	77
G <sup>1</sup> / <sub>4</sub>	32	24	6	3.5	9	G <sup>1</sup> / <sub>4</sub>	G <sup>1</sup> / <sub>8</sub>	M5	5.5	4.3	9	88

Pneumatic connection	H2	H3	H4	H5	H6	H7	H8	H25	L1	L2	L3
G <sup>1</sup> / <sub>8</sub>	41	21	38.5	22	19	42	12	124	47	40	43
G <sup>1</sup> / <sub>4</sub>	46	24	44	24	20	48	16	137	53	44	49

## Dimensions – Pneumatic connection G<sup>3</sup>/<sub>8</sub>

Download CAD Data → [www.festo.com/us/cad](http://www.festo.com/us/cad)

Basic valve

J-5-3/8-B

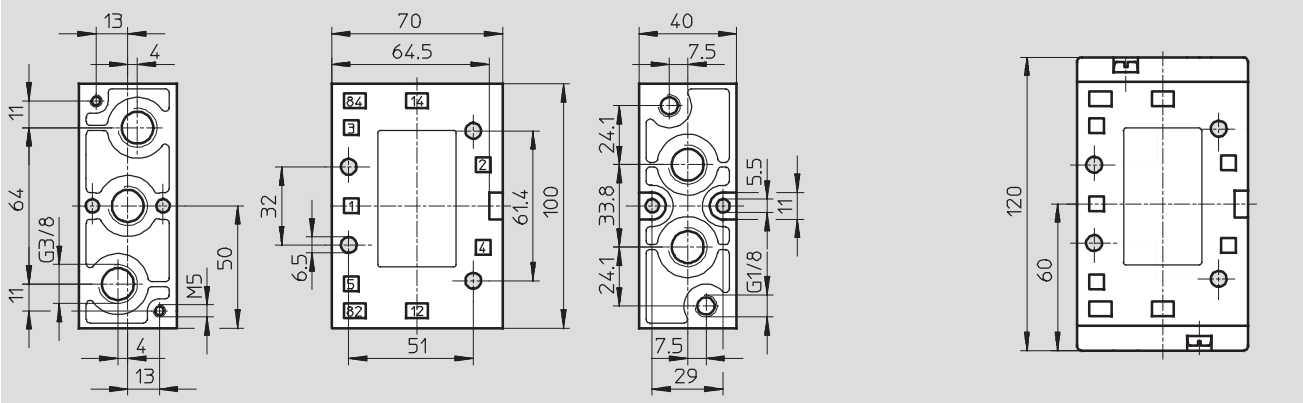

## Ordering data

Circuit symbol	Pneumatic connection	Part No.	Type
	G <sup>1</sup> / <sub>8</sub>	30988	J-5-1/8-B
	G <sup>1</sup> / <sub>4</sub>	14295	J-5-1/4-B
	G <sup>3</sup> / <sub>8</sub>	14953	J-5-3/8-B

# Pneumatic valves VL, Tiger 2000

FESTO

Technical data – 5/3-way valves

Flow rate

800 ... 2000 l/min



General technical data				
Pneumatic connection		G $\frac{1}{8}$	G $\frac{1}{4}$	G $\frac{3}{8}$
Valve function		5/3-way, double pilot		
Constructional design		Piston spool		
Sealing principle		Soft		
Actuation type		Pneumatic		
Type of reset		Mechanical spring		
Type of pilot control		Direct		
Direction of flow		Reversible		
Exhaust function		With flow control		
Manual override		None		
Type of mounting		Via through-holes		
Mounting position		Any		
Nominal size	[mm]	8	10	12
Standard nominal flow rate	[l/min]	800	1600	2000
Grid dimension	[mm]	27	33	41
Product weight	[g]	320	375	680

Operating and environmental conditions				
Pneumatic connection		G $\frac{1}{8}$	G $\frac{1}{4}$	G $\frac{3}{8}$
Operating medium		Compressed air in accordance with ISO 8573-1:2010 [7:4:4]		
Pilot medium		Compressed air in accordance with ISO 8573-1:2010 [7:4:4]		
Note on operating/pilot medium		Operation with lubricated medium possible (in which case lubricated operation will always be required)		
Operating pressure	[bar]	-0.9 ... +10	-0.9 ... +10	-0.9 ... +10
Pilot pressure	[bar]	3 ... 10	3 ... 10	3 ... 10
Ambient temperature	[°C]	-10 ... +60		
Temperature of medium	[°C]	-10 ... +60		
Note on materials		RoHS-compliant		



# Pneumatic valves VL, Tiger 2000

Technical data – 5/3-way valves

## Minimum pilot pressure $p_{12}/p_{14}$ as a function of the operating pressure $p_1$

VL-5/3...-1/8-B

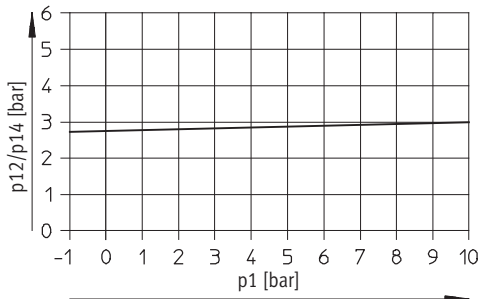

VL-5/3...-1/4-B

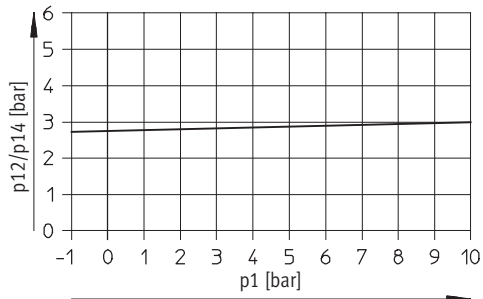

VL-5/3...-3/8-B

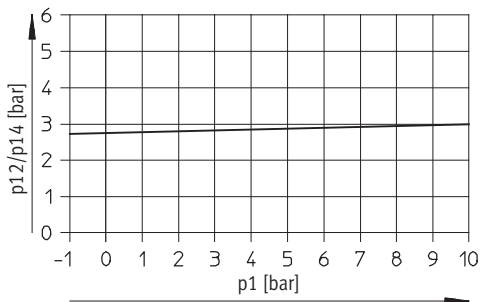

## Valve response times [ms]

Pneumatic connection	G1/8	G1/4	G3/8
On	5	6	7
Off	14	26	28

## Materials

Sectional view

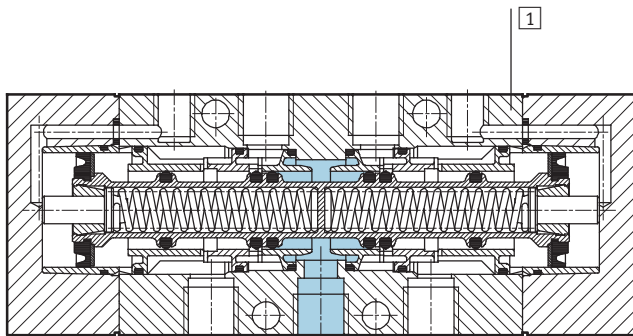

1	Housing	Die-cast aluminium
-	Seals	Nitrile rubber

# Pneumatic valves VL, Tiger 2000

Technical data – 5/3-way valves



## Dimensions – Pneumatic connection G $\frac{1}{8}$ , G $\frac{1}{4}$

Download CAD Data → [www.festo.com/us/cad](http://www.festo.com/us/cad)

Basic valve

J-5-...-B

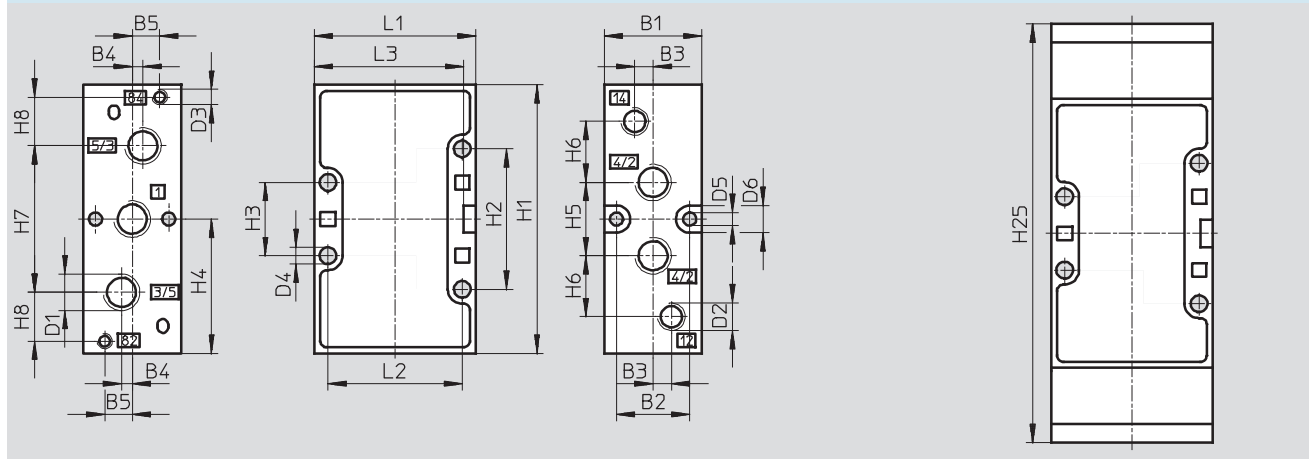

Pneumatic connection	B1	B2	B3	B4	B5	D1	D2	D3	D4	D5	D6	H1
G $\frac{1}{8}$	26	19.5	5	3.5	8	G $\frac{1}{8}$	G $\frac{1}{8}$	M5	4.5	4.3	9	77
G $\frac{1}{4}$	32	24	6	3.5	9	G $\frac{1}{4}$	G $\frac{1}{8}$	M5	5.5	4.3	9	88

Pneumatic connection	H2	H3	H4	H5	H6	H7	H8	H25	L1	L2	L3
G $\frac{1}{8}$	41	21	38.5	22	19	42	12	124	47	40	43
G $\frac{1}{4}$	46	24	44	24	20	48	16	137	53	44	49

## Dimensions – Pneumatic connection G $\frac{3}{8}$

Download CAD Data → [www.festo.com/us/cad](http://www.festo.com/us/cad)

Basic valve

VL-5/3...-3/8-B

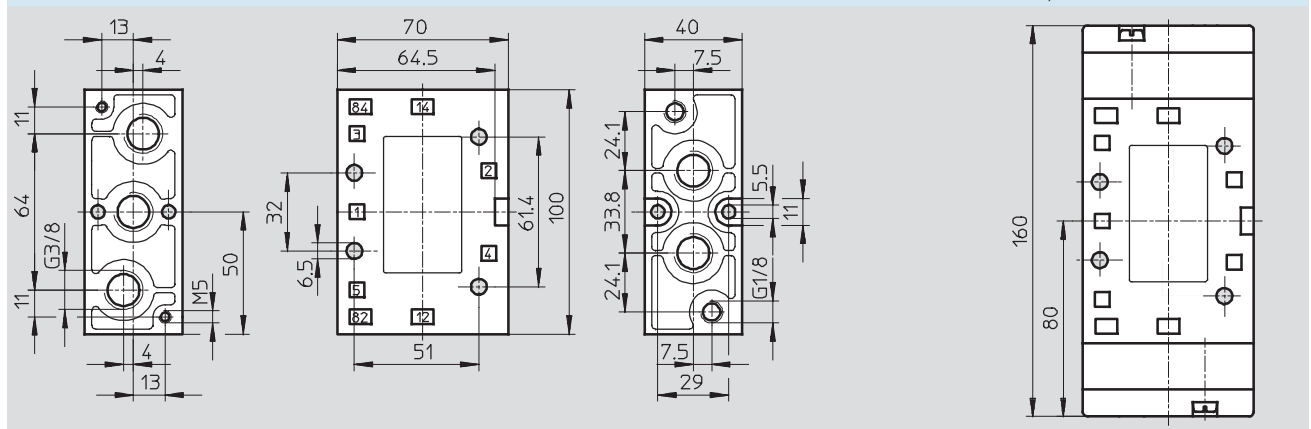

# Pneumatic valves VL, Tiger 2000

Technical data – 5/3-way valves

Ordering data				
Circuit symbol	Description	Pneumatic connection	Part No.	Type
	Normally closed	G1/8	30990	VL-5/3G-1/8-B
		G1/4	14298	VL-5/3G-1/4-B
		G3/8	14950	VL-5/3G-3/8-B
	Normally exhausted	G1/8	31309	VL-5/3E-1/8-B
		G1/4	14297	VL-5/3E-1/4-B
		G3/8	14949	VL-5/3E-3/8-B
	Normally pressurised	G1/8	31310	VL-5/3B-1/8-B
		G1/4	14299	VL-5/3B-1/4-B
		G3/8	14951	VL-5/3B-3/8-B

# Solenoid/pneumatic valves, Tiger 2000

Accessories

FESTO

Manifold strip  
PAL-...-B

Material:  
Anodised aluminium

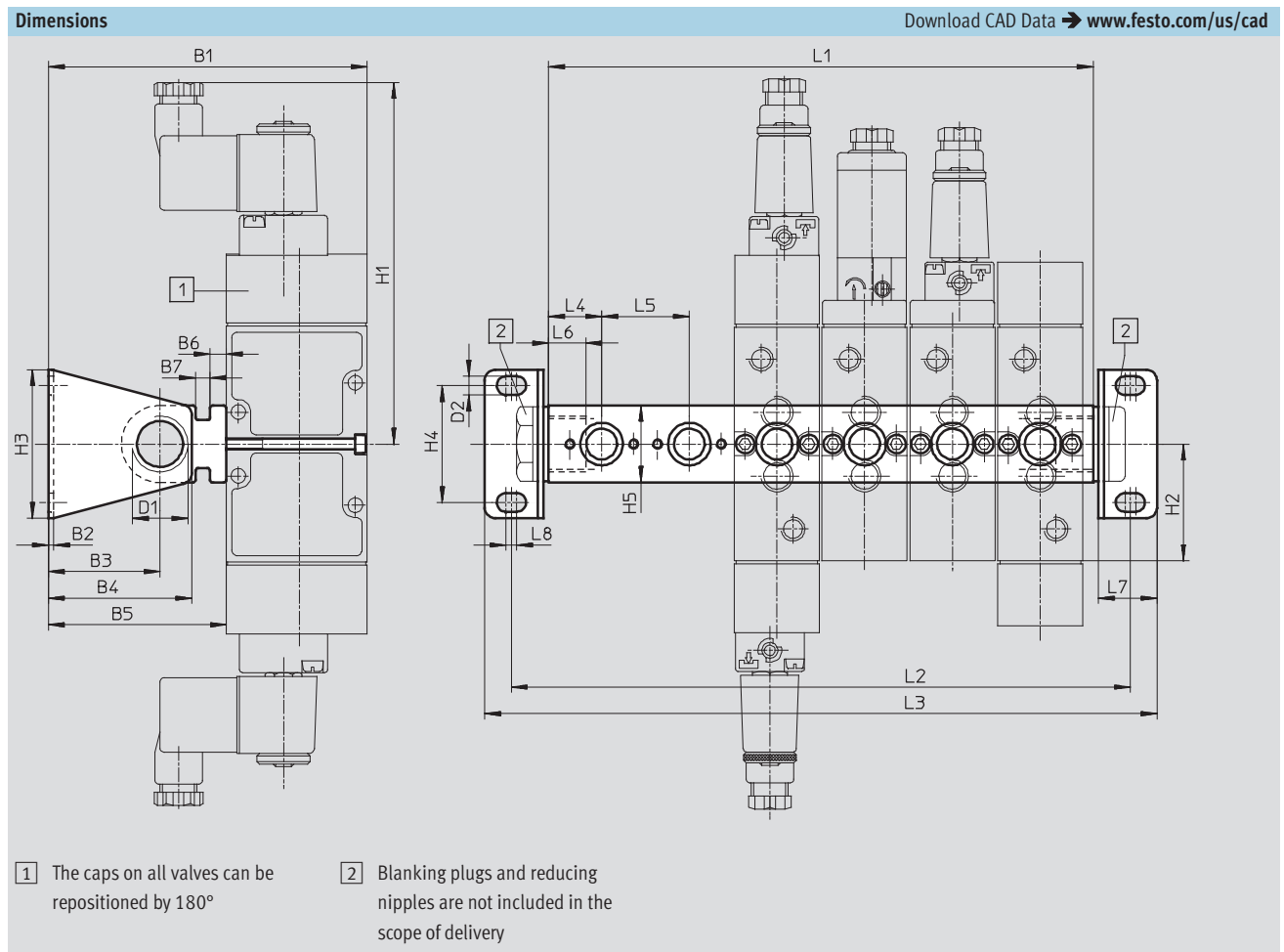
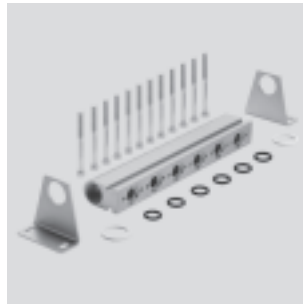

Type	B1	B2	B3	B4	B5	B6	B7	D1	D2	H1	H2	H3	H4	L4	L5	L6	L7	L8
PAL-1/8-...	104	2	33.5	44.5	57	5	5.5	G3/8	5.2	130	38.5	44	32	18	27	12	20	4
PAL-1/4-...	120	2	42	54	67	6.1	5.5	G1/2	7	136	44	56	44	20	33	14	22	4
PAL-3/8-...	176	3	75	93	106	4	14	G3/4	9	147	50	80	60	25	41	17	30	5

# Solenoid/pneumatic valves, Tiger 2000

FESTO

Accessories

Dimensions and ordering data						
Number of valve ports	L1	L2	L3	Weight [g]	Part No.	Type
Pneumatic connection G $\frac{1}{8}$						
2	63	89	107	150	30552	PAL- $\frac{1}{8}$ -2-B
3	90	116	134	190	30553	PAL- $\frac{1}{8}$ -3-B
4	117	143	161	230	30554	PAL- $\frac{1}{8}$ -4-B
5	144	170	188	260	30555	PAL- $\frac{1}{8}$ -5-B
6	171	197	215	290	30556	PAL- $\frac{1}{8}$ -6-B
7	198	224	242	340	30557	PAL- $\frac{1}{8}$ -7-B
8	225	251	269	370	30558	PAL- $\frac{1}{8}$ -8-B
9	252	278	296	410	30559	PAL- $\frac{1}{8}$ -9-B
10	279	305	323	450	30560	PAL- $\frac{1}{8}$ -10-B
Pneumatic connection G $\frac{1}{4}$						
2	73	101	121	230	30280	PAL- $\frac{1}{4}$ -2-B
3	106	134	154	290	30281	PAL- $\frac{1}{4}$ -3-B
4	139	167	187	350	30282	PAL- $\frac{1}{4}$ -4-B
5	172	200	220	420	30283	PAL- $\frac{1}{4}$ -5-B
6	205	233	253	480	30284	PAL- $\frac{1}{4}$ -6-B
7	238	266	286	540	30285	PAL- $\frac{1}{4}$ -7-B
8	271	299	319	600	30286	PAL- $\frac{1}{4}$ -8-B
9	304	322	352	660	30287	PAL- $\frac{1}{4}$ -9-B
10	337	365	385	730	30288	PAL- $\frac{1}{4}$ -10-B
Pneumatic connection G $\frac{3}{8}$						
2	91	127	155	510	30692	PAL- $\frac{3}{8}$ -2-B
3	132	168	196	610	30693	PAL- $\frac{3}{8}$ -3-B
4	173	209	237	720	30694	PAL- $\frac{3}{8}$ -4-B
5	214	250	278	830	30695	PAL- $\frac{3}{8}$ -5-B
6	255	291	319	960	30696	PAL- $\frac{3}{8}$ -6-B
7	296	332	360	1060	30697	PAL- $\frac{3}{8}$ -7-B
8	337	373	401	1160	30698	PAL- $\frac{3}{8}$ -8-B
9	378	414	442	1260	30699	PAL- $\frac{3}{8}$ -9-B
10	419	455	483	1360	30680	PAL- $\frac{3}{8}$ -10-B

# Solenoid/pneumatic valves, Tiger 2000

Accessories

FESTO

Manifold  
PRS

Material:  
Anodised aluminium

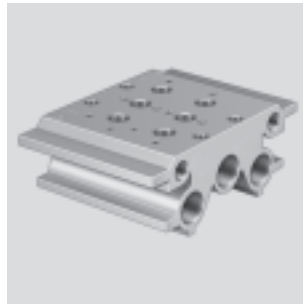

## Dimensions

Download CAD Data → [www.festo.com/us/cad](http://www.festo.com/us/cad)

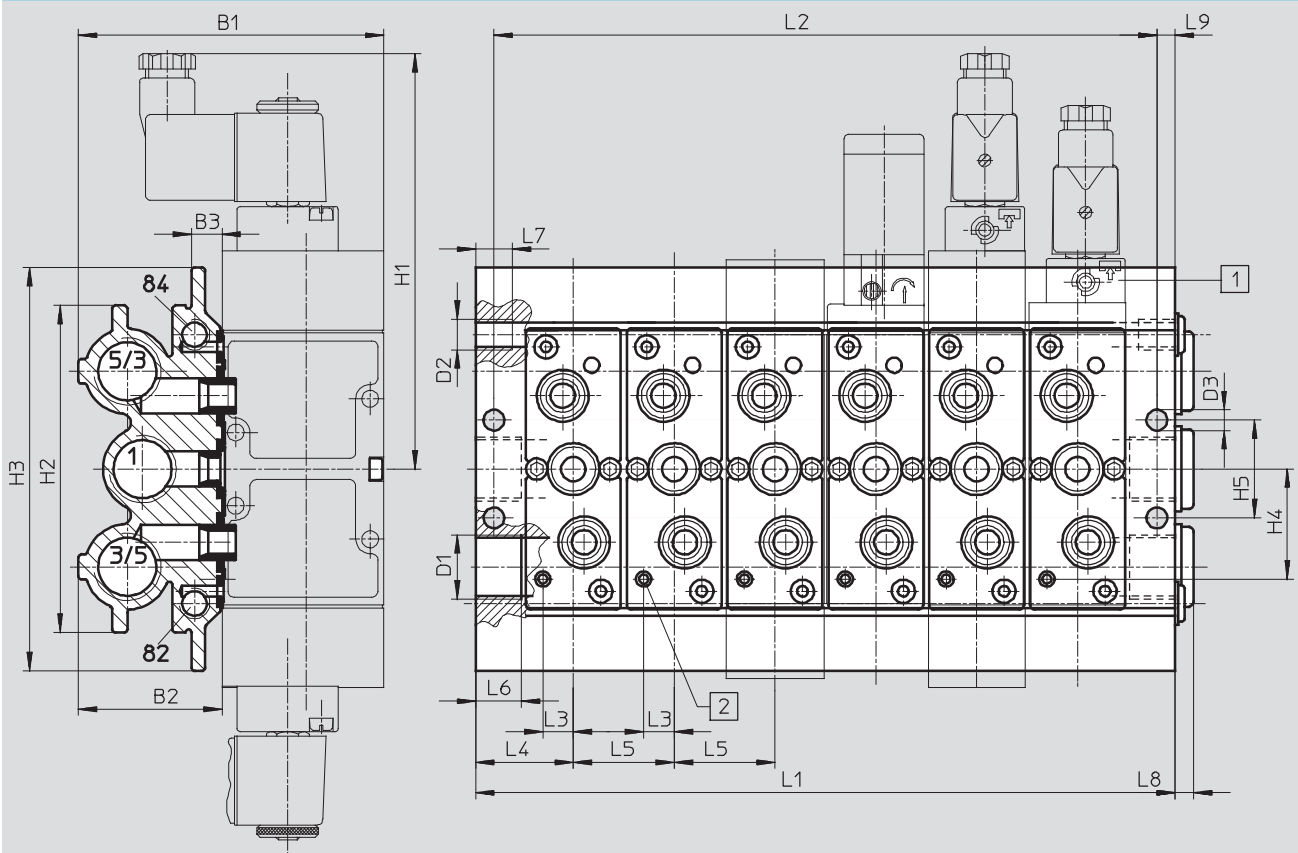

1 The caps on all valves can be repositioned by 180°

2 Hole for dowel pin to DIN 7346  
Ø 3 mm

Type	B1	B2	B3	D1	D2	D3	H1	H2	H3	H4	H5	L3	L4	L5	L6	L7	L8	L9
PRS-1/8-...	93	45.5	11.2	G3/8	G1/8	6.8	130	95	120	27	27.5	9.4	25.5	27	14	8	5	6
PRS-1/4-...	100	47	10	G1/2	G1/8	6.8	136	107	132	36	32	10	32	33	15	12	6	9
PRS-3/8-...	131	60.5	12.5	G3/4	G1/8	9	147	128	153	44	44	15.2	36.5	41	16	12	6	7.5

# Solenoid/pneumatic valves, Tiger 2000

Accessories

Dimensions and ordering data					
Number of valve ports	L1	L2	Weight [g]	Part No.	Type
Pneumatic connection G $\frac{1}{8}$					
2	78	66	700	30542	PRS- $\frac{1}{8}$ -2-BB
3	105	93	920	30543	PRS- $\frac{1}{8}$ -3-BB
4	132	120	1150	30544	PRS- $\frac{1}{8}$ -4-BB
5	159	147	1320	30545	PRS- $\frac{1}{8}$ -5-BB
6	186	174	1520	30546	PRS- $\frac{1}{8}$ -6-BB
7	213	201	1750	30547	PRS- $\frac{1}{8}$ -7-BB
8	240	228	2010	30548	PRS- $\frac{1}{8}$ -8-BB
9	267	255	2200	30549	PRS- $\frac{1}{8}$ -9-BB
10	294	282	2400	30550	PRS- $\frac{1}{8}$ -10-BB
Pneumatic connection G $\frac{1}{4}$					
2	97	85	1050	15861	PRS- $\frac{1}{4}$ -2-B
3	130	118	1310	15862	PRS- $\frac{1}{4}$ -3-B
4	163	151	1610	15863	PRS- $\frac{1}{4}$ -4-B
5	196	184	1900	15864	PRS- $\frac{1}{4}$ -5-B
6	229	217	2200	15865	PRS- $\frac{1}{4}$ -6-B
7	262	250	2500	15866	PRS- $\frac{1}{4}$ -7-B
8	259	283	2800	15867	PRS- $\frac{1}{4}$ -8-B
9	328	316	3100	15868	PRS- $\frac{1}{4}$ -9-B
10	361	349	3360	15869	PRS- $\frac{1}{4}$ -10-B
Pneumatic connection G $\frac{3}{8}$					
2	114	99	1600	30682	PRS- $\frac{3}{8}$ -2-B
3	155	140	2100	30683	PRS- $\frac{3}{8}$ -3-B
4	196	181	2630	30684	PRS- $\frac{3}{8}$ -4-B
5	237	222	3100	30685	PRS- $\frac{3}{8}$ -5-B
6	278	263	3500	30686	PRS- $\frac{3}{8}$ -6-B
8	360	345	4620	30688	PRS- $\frac{3}{8}$ -8-B
10	442	427	5600	30690	PRS- $\frac{3}{8}$ -10-B

# Solenoid/pneumatic valves, Tiger 2000

Accessories

FESTO

## Blanking plate for vacant positions PRSB

Material:  
Die-cast aluminium



Ordering data			
Pneumatic connection	Weight [g]	Part No.	Type
G $\frac{1}{8}$	33	15909	PRBS- $\frac{1}{8}$ -B
G $\frac{1}{4}$	40	30666	PRSB- $\frac{1}{4}$ -B
G $\frac{3}{8}$	72	30681	PRSB- $\frac{3}{8}$ -B

## Blanking plate for vacant positions PALB

Material:  
Steel



Ordering data			
Pneumatic connection	Weight [g]	Part No.	Type
G $\frac{1}{8}$	14	30903	PALB- $\frac{1}{8}$ -B
G $\frac{1}{4}$	22	30904	PALB- $\frac{1}{4}$ -B
G $\frac{3}{8}$	32	30905	PALB- $\frac{3}{8}$ -B

## Sealing plug PRSV

Material:  
Steel



Ordering data			
Pneumatic connection	Weight [g]	Part No.	Type
G $\frac{1}{8}$	18	160997	PRSV- $\frac{1}{8}$
G $\frac{1}{4}$	27	160996	PRSV- $\frac{1}{4}$



# Solenoid/pneumatic valves, Tiger 2000

Accessories

## Manual override tool

### AHB

Material:

Polymer

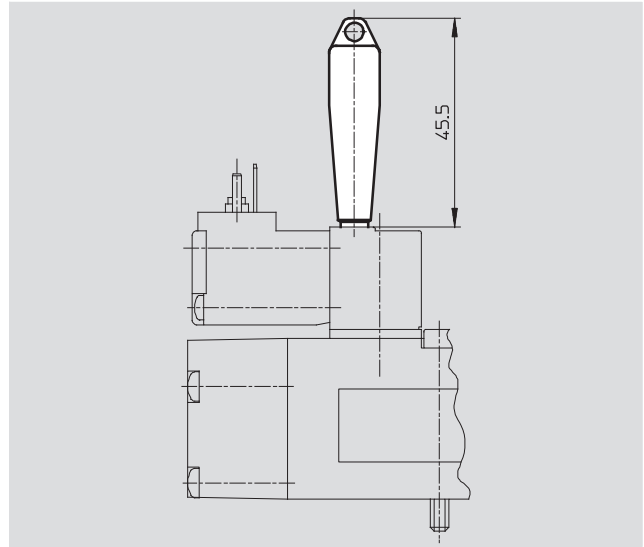

Ordering data				
For valve	Weight [g]	CRC <sup>1)</sup>	Part No.	Type
MFH/JMFH	10	2	157651	AHB-MD/MF/MV

1) Corrosion resistance class 2 according to Festo standard 940 070

Components requiring moderate corrosion resistance. Externally visible parts with primarily decorative surface requirements which are in direct contact with a surrounding industrial atmosphere or media such as cooling or lubricating agents.

## Inscription labels

### KMC/F/V-BZ-35X

Material:

Polymer

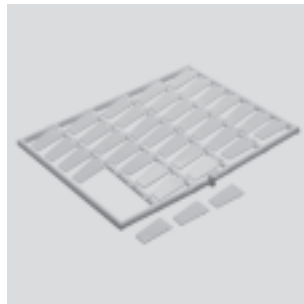



Ordering data			
	Weight [g]	Part No.	Type
Inscription labels for valves (35 in frames included in scope of delivery)	20	33362	KMC/F/V-BZ-35x

Ordering data – Solenoid coils			Technical data → Internet: msf	
	Voltage	Cable length [m]	Part No.	Type
F solenoid coils for valves MFH, JMFH				
	12 V DC	–	34410	MSFG-12DC-OD
	24 V DC and 42 V AC, 50 ... 60 Hz	–	34411	MSFG-24/42-50/60-OD
	42 V DC	–	34413	MSFG-42DC-OD
	24 V AC	–	34415	MSFG-24AC-OD
	48 V AC, 50 ... 60 Hz	–	34418	MSFW-48AC-OD
	110 V AC, 50 ... 60 Hz and 120 V AC, 60 Hz	–	34420	MSFW-110AC-OD
	230 V AC, 50 ... 60 Hz and 240 V AC, 60 Hz	–	34422	MSFW-230AC-OD
	240 V AC, 50 ... 60 Hz	–	34424	MSFW-240AC-OD



# Solenoid/pneumatic valves, Tiger 2000

Accessories

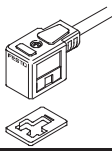
**FESTO**

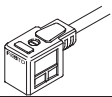
Ordering data – Plug sockets, plug sockets with cable for F solenoid coils					
	Voltage	Cable length [m]	Switching status display with LED	Part No.	Type
Plug socket without cable					Technical data → Internet: mssd
	–	–	–	34431	MSSD-F
	–	–	–	539710	MSSD_F-M16
Plug socket without cable with insulation displacement technology					Technical data → Internet: mssd
	–	–	–	192746	MSSD-F-S-M16
Plug socket with cable					Technical data → Internet: kmf
	24 V DC	2.5	■	30935	KMF-1-24DC-2,5-LED
		5	■	30937	KMF-1-24DC-5-LED
		10	■	193458	KMF-1-24DC-10-LED
	Up to 240 V	2.5	–	30936	KMF-1-230AC-2,5
		5	–	30938	KMF-1-230AC-5

Ordering data – Plug sockets, plug sockets with cable for V solenoid coils					
	Voltage	Cable length [m]	Switching status display with LED	Part No.	Type
Plug socket without cable					Technical data → Internet: mssd
	–	–	–	33295	MSSD-V
	–	–	–	539713	MSSD-V-M16
Plug socket with cable					Technical data → Internet: kmv
	24 V DC	2.5	■	30939	KMV-1-24DC-2,5-LED
		5	■	30941	KMV-1-24DC-5-LED
		10	■	193456	KMV-1-24-10-LED

Ordering data – Illuminating seal					Technical data → Internet: illuminating seal
	Voltage			Part No.	Type
For F solenoid coils					
	12 ... 24 V DC			19143	MF-LD-12-24DC
	230 V DC/V AC			19144	MF-LD-230AC
For V solenoid coils					
	12 ... 24 V DC			35558	MV-LD-12-24DC

# Product Range and Company Overview

## A Complete Suite of Automation Services

Our experienced engineers provide complete support at every stage of your development process, including: conceptualization, analysis, engineering, design, assembly, documentation, validation, and production.



**Custom Automation Components**  
Complete custom engineered solutions



**Custom Control Cabinets**  
Comprehensive engineering support and on-site services



**Complete Systems**  
Shipment, stocking and storage services

## The Broadest Range of Automation Components

With a comprehensive line of more than 30,000 automation components, Festo is capable of solving the most complex automation requirements.



**Electromechanical**  
Electromechanical actuators, motors, controllers & drives



**Pneumatics**  
Pneumatic linear and rotary actuators, valves, and air supply



**PLCs and I/O Devices**  
PLC's, operator interfaces, sensors and I/O devices

## Supporting Advanced Automation... As No One Else Can!

Festo is a leading global manufacturer of pneumatic and electromechanical systems, components and controls for industrial automation, with more than 12,000 employees in 56 national headquarters serving more than 180 countries. For more than 80 years, Festo has continuously elevated the state of manufacturing with innovations and optimized motion control solutions that deliver higher performing, more profitable automated manufacturing and processing equipment. Our dedication to the advancement of automation extends beyond technology to the education and development of current and future automation and robotics designers with simulation tools, teaching programs, and on-site services.

## Quality Assurance, ISO 9001 and ISO 14001 Certifications

Festo Corporation is committed to supply all Festo products and services that will meet or exceed our customers' requirements in product quality, delivery, customer service and satisfaction.

To meet this commitment, we strive to ensure a consistent, integrated, and systematic approach to management that will meet or exceed the requirements of the ISO 9001 standard for Quality Management and the ISO 14001 standard for Environmental Management.



© Copyright 2008, Festo Corporation. While every effort is made to ensure that all dimensions and specifications are correct, Festo cannot guarantee that publications are completely free of any error, in particular typing or printing errors. Accordingly, Festo cannot be held responsible for the same. For Liability and Warranty conditions, refer to our "Terms and Conditions of Sale", available from your local Festo office. All rights reserved. No part of this publication may be reproduced, distributed, or transmitted in any form or by any means, electronic, mechanical, photocopying or otherwise, without the prior written permission of Festo. All technical data subject to change according to technical update.



Printed on recycled paper at New Horizon Graphic, Inc., FSC certified as an environmentally friendly printing plant.

# Festo North America

## Festo Regional Contact Center

5300 Explorer Drive  
Mississauga, Ontario L4W 5G4  
Canada

### USA Customers:

For ordering assistance,

**Call:** 1.800.99.FESTO (1.800.993.3786)

**Fax:** 1.800.96.FESTO (1.800.963.3786)

**Email:** [customer.service@us.festo.com](mailto:customer.service@us.festo.com)

For technical support,

**Call:** 1.866.GO.FESTO (1.866.463.3786)

**Fax:** 1.800.96.FESTO (1.800.963.3786)

**Email:** [product.support@us.festo.com](mailto:product.support@us.festo.com)

### Canadian Customers:

**Call:** 1.877.GO.FESTO (1.877.463.3786)

**Fax:** 1.877.FX.FESTO (1.877.393.3786)

**Email:** [festo.canada@ca.festo.com](mailto:festo.canada@ca.festo.com)

---

## USA Headquarters

Festo Corporation  
395 Moreland Road  
P.O. Box 18023  
Hauppauge, NY 11788, USA  
[www.festo.com/us](http://www.festo.com/us)

---

## USA Sales Offices

### Appleton

North 922 Tower View Drive, Suite N  
Greenville, WI 54942, USA

### Boston

120 Presidential Way, Suite 330  
Woburn, MA 01801, USA

### Chicago

1441 East Business Center Drive  
Mt. Prospect, IL 60056, USA

### Dallas

1825 Lakeway Drive, Suite 600  
Lewisville, TX 75057, USA

### Detroit – Automotive Engineering Center

2601 Cambridge Court, Suite 320  
Auburn Hills, MI 48326, USA

### New York

395 Moreland Road  
Hauppauge, NY 11788, USA

### Silicon Valley

4935 Southfront Road, Suite F  
Livermore, CA 94550, USA

## United States



**USA Headquarters, East:** Festo Corp., 395 Moreland Road, Hauppauge, NY 11788

Phone: 1.631.435.0800; Fax: 1.631.435.8026;

Email: [info@festo-usa.com](mailto:info@festo-usa.com)

[www.festo.com/us](http://www.festo.com/us)

## Canada



**Headquarters:** Festo Inc., 5300 Explorer Drive, Mississauga, Ontario L4W 5G4

Phone: 1.905.624.9000; Fax: 1.905.624.9001;

Email: [festo.canada@ca.festo.com](mailto:festo.canada@ca.festo.com)

[www.festo.ca](http://www.festo.ca)

## Mexico



**Headquarters:** Festo Pneumatic, S.A., Av. Ceylán 3, Col. Tequesquahuac,  
54020 Tlalneantla, Edo. de México

Phone: 011 52 [55] 53 21 66 00; Fax: 011 52 [55] 53 21 66 65;

Email: [festo.mexico@mx.festo.com](mailto:festo.mexico@mx.festo.com)

[www.festo.com/mx](http://www.festo.com/mx)

---

## Central USA

Festo Corporation  
1441 East Business  
Center Drive  
Mt. Prospect, IL 60056, USA  
Phone: 1.847.759.2600  
Fax: 1.847.768.9480



## Western USA

Festo Corporation  
4935 Southfront Road,  
Suite F  
Livermore, CA 94550, USA  
Phone: 1.925.371.1099  
Fax: 1.925.245.1286



---

## Festo Worldwide

Argentina Australia Austria Belarus Belgium Brazil Bulgaria Canada Chile China Colombia Croatia Czech Republic Denmark  
Estonia Finland France Germany Great Britain Greece Hong Kong Hungary India Indonesia Iran Ireland Israel Italy Japan Latvia  
Lithuania Malaysia Mexico Netherlands New Zealand Norway Peru Philippines Poland Romania Russia Serbia Singapore  
Slovakia Slovenia South Africa South Korea Spain Sweden Switzerland Taiwan Thailand Turkey Ukraine United States Venezuela

[www.festo.com](http://www.festo.com)