

Axial kits EAMM-A

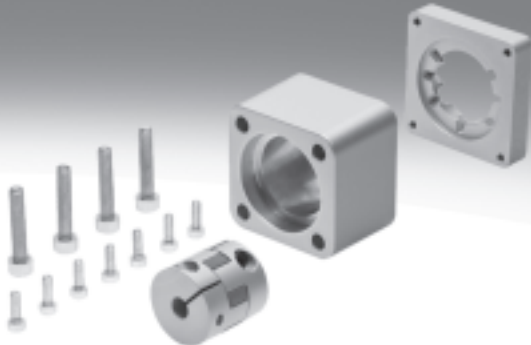

Axial kits EAMM-A

Product range overview

FESTO

Permissible axis/motor combinations with toothed belt axis DGE-ZR

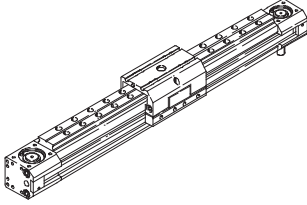

Without gear unit		
Motor	Axial kit	
Type	Part No.	Type
DGE-8-...-ZR		
With servo motor		
EMMS-AS-40-...	550921	EAMM-A-G13-40A
With stepper motor		
EMMS-ST-42-...	550922	EAMM-A-G13-42A
DGE-12-...-ZR		
With servo motor		
EMMS-AS-40-...	550923	EAMM-A-G16-40A
EMMS-AS-55-...	550925	EAMM-A-G16-55A
With stepper motor		
EMMS-ST-42-...	550924	EAMM-A-G16-42A
DGE-18-...-ZR		
With servo motor		
EMMS-AS-40-...	550926	EAMM-A-G19-40A
EMMS-AS-55-...	550927	EAMM-A-G19-55A
With stepper motor		
EMMS-ST-57-...	550928	EAMM-A-G19-57A
DGE-25-...-ZR		
With servo motor		
EMMS-AS-55-...	550929	EAMM-A-F30-55A
EMMS-AS-70-...	550932	EAMM-A-F30-70A
With stepper motor		
EMMS-ST-57-...	550930	EAMM-A-F30-57A
EMMS-ST-87-...	550933	EAMM-A-F30-87A
DGE-25-...-ZR-RF		
With servo motor		
EMMS-AS-55-...	550942	EAMM-A-F37-55A
EMMS-AS-70-...	550945	EAMM-A-F37-70A
With stepper motor		
EMMS-ST-57-...	550943	EAMM-A-F37-57A
EMMS-ST-87-...	550946	EAMM-A-F37-87A

Without gear unit		
Motor	Axial kit	
Type	Part No.	Type
DGE-40-...-ZR		
With servo motor		
EMMS-AS-70-...	550934	EAMM-A-F40-70A
EMMS-AS-100-...	550937	EAMM-A-F40-100A
With stepper motor		
EMMS-ST-87-...	550936	EAMM-A-F40-87A
DGE-40-...-ZR-RF		
With servo motor		
EMMS-AS-100-...	550949	EAMM-A-F47-100A
EMMS-AS-140-...	550950	EAMM-A-F47-140A
With stepper motor		
EMMS-ST-87-...	550948	EAMM-A-F47-87A
DGE-63-...-ZR		
With servo motor		
EMMS-AS-100-...	550939	EAMM-A-F62-100A
EMMS-AS-140-...	550941	EAMM-A-F62-140A
DGE-63-...-ZR-RF		
With servo motor		
EMMS-AS-100-...	550952	EAMM-A-F80-100A
EMMS-AS-140-...	550954	EAMM-A-F80-140A

Axial kits EAMM-A

Product range overview

Permissible axis/motor combinations with toothed belt axis DGE-ZR

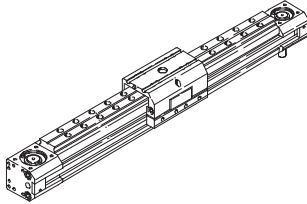

With gear unit		
Motor	Axial kit	
Gear unit	Part No.	Type
DGE-25-...-ZR		
With servo motor and gear unit		
EMMS-AS-55-...	550931	EAMM-A-F30-60G
EMGA-60-P-G...-SAS-55		
With stepper motor and gear unit		
EMMS-ST-57-...	550931	EAMM-A-F30-60G
EMGA-60-P-G...-SST-57		
DGE-25-...-ZR-RF		
With servo motor and gear unit		
EMMS-AS-55-...	550944	EAMM-A-F37-60G
EMGA-60-P-G...-SAS-55		
With stepper motor		
EMMS-ST-57-...	550944	EAMM-A-F37-60G
EMGA-60-P-G...-SST-57		
DGE-40-...-ZR		
With servo motor and gear unit		
EMMS-AS-100-...	550935	EAMM-A-F40-80G
EMGA-80-P-G...-SAS-100		
With stepper motor and gear unit		
EMMS-ST-87-...	550935	EAMM-A-F40-80G
EMGA-80-P-G...-SST-87		
DGE-40-...-ZR-RF		
With servo motor and gear unit		
EMMS-AS-100-...	550947	EAMM-A-F47-80G
EMGA-80-P-G...-SAS-100		
With stepper motor and gear unit		
EMMS-ST-87-...	550947	EAMM-A-F47-80G
EMGA-80-P-G...-SST-87		

With gear unit		
Motor	Axial kit	
Gear unit	Part No.	Type
DGE-63-...-ZR		
With servo motor and gear unit		
EMMS-AS-100-...	550940	EAMM-A-F62-120G
EMGA-120-P-G...-SAS-100		
EMMS-AS-140-...	550940	EAMM-A-F62-120G
EMGA-120-P-G...-SAS-140		
With stepper motor and gear unit		
EMMS-ST-87-...	550938	EAMM-A-F62-80G
EMGA-80-P-G...-SST-87		
DGE-63-...-ZR-RF		
With servo motor and gear unit		
EMMS-AS-100-...	550951	EAMM-A-F80-80G
EMGA-80-P-G...-SAS-100		
EMMS-AS-140-S-...	550953	EAMM-A-F80-120G
EMGA-120-P-G...-SAS-140		
EMMS-AS-140-L-...	550955	EAMM-A-F80-160G
EMGA-160-P-G...-SAS-140		
With stepper motor and gear unit		
EMMS-ST-87-...	550951	EAMM-A-F80-80G
EMGA-80-P-G...-SST-87		

Axial kits EAMM-A

Product range overview

FESTO

Permissible axis/motor combinations with spindle axis DGE-SP

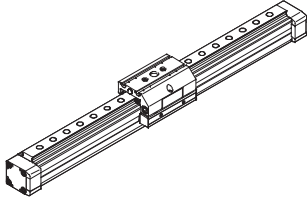

Without gear unit		
Motor	Axial kit	
Type	Part No.	Type
DGE-18		
With servo motor		
EMMS-AS-40-...	550961	EAMM-A-E20-40A
EMMS-AS-55-...	550963	EAMM-A-E20-55A
With stepper motor		
EMMS-ST-42-...	550962	EAMM-A-E20-42A
DGE-25		
With servo motor		
EMMS-AS-40-...	550964	EAMM-A-E32-40A
EMMS-AS-55-...	550965	EAMM-A-E32-55A
With stepper motor		
EMMS-ST-57-...	550966	EAMM-A-E32-57A
DGE-40		
With servo motor		
EMMS-AS-55-...	550969	EAMM-A-E48-55A
EMMS-AS-70-...	550971	EAMM-A-E48-44A-70A
EMMS-AS-100-...	550973	EAMM-A-E48-100A
With stepper motor		
EMMS-ST-57-...	550970	EAMM-A-E48-57A
EMMS-ST-87-...	550972	EAMM-A-E48-87A
DGE-63		
With servo motor		
EMMS-AS-70-...	550975	EAMM-A-E72-70A
EMMS-AS-100-...	550978	EAMM-A-E72-100A
With stepper motor		
EMMS-ST-87-...	550977	EAMM-A-E72-87A

With gear unit		
Motor	Axial kit	
Gear unit	Part No.	Type
DGE-40		
With servo motor and gear unit		
EMMS-AS-40-...	550968	EAMM-A-E48-40G
EMGA-40-P-G...-SAS-40		
DGE-63		
With servo motor and gear unit		
EMMS-AS-70-S-...	550974	EAMM-A-E72-60G
EMGA-60-P-G...-SAS-70		
EMMS-AS-70-M-...	550976	EAMM-A-E72-80G
EMGA-80-P-G...-SAS-70		
With stepper motor and gear unit		
EMMS-ST-87-...	550976	EAMM-A-E72-80G
EMGA-80-P-G...-SST-87		

Axial kits EAMM-A

Product range overview

Permissible axis/motor combinations with positioning axis DMES

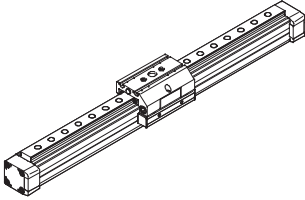

Without gear unit		
Motor	Axial kit	
Type	Part No.	Type
DMES-18		
With servo motor		
EMMS-AS-40-...	550961	EAMM-A-E20-40A
EMMS-AS-55-...	550963	EAMM-A-E20-55A
With stepper motor		
EMMS-ST-42-...	550962	EAMM-A-E20-42A
With motor unit		
MTR-DCI-32S-...	556991	EAMM-A-E20-32B
DMES-25		
With servo motor		
EMMS-AS-40-...	550964	EAMM-A-E32-40A
EMMS-AS-55-...	550965	EAMM-A-E32-55A
With stepper motor		
EMMS-ST-57-...	550966	EAMM-A-E32-57A
With motor unit		
MTR-DCI-42S-...G7	556992	EAMM-A-E32-42B
MTR-DCI-42S-...G14	556993	EAMM-A-E32-42C
DMES-40		
With servo motor		
EMMS-AS-70-...	557448	EAMM-A-E48-64A-70A
EMMS-AS-100-...	550973	EAMM-A-E48-100A
With stepper motor		
EMMS-ST-87-...	550972	EAMM-A-E48-87A
With motor unit		
MTR-DCI-52S-...G7	556994	EAMM-A-E48-52B
MTR-DCI-52S-...G14	556995	EAMM-A-E48-52C
DMES-63		
With servo motor		
EMMS-AS-70-...	550975	EAMM-A-E72-70A
EMMS-AS-100-...	550978	EAMM-A-E72-100A
With stepper motor		
EMMS-ST-87-...	550977	EAMM-A-E72-87A
With motor unit		
MTR-DCI-62S-...	556996	EAMM-A-E72-62B

With gear unit		
Motor	Axial kit	
Gear unit	Part No.	Type
DMES-63		
With servo motor and gear unit		
EMMS-AS-70-S-...	550974	EAMM-A-E72-60G
EMGA-60-P-G...-SAS-70		
EMMS-AS-70-M-...	550976	EAMM-A-E72-80G
EMGA-80-P-G...-SAS-70		
With stepper motor and gear unit		
EMMS-ST-87-...	550976	EAMM-A-E72-80G
EMGA-80-P-G...-SST-87		

Axial kits EAMM-A

Product range overview

FESTO

Permissible axis/motor combinations with electric cylinder DNCE

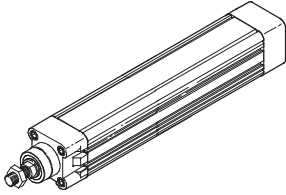

Without gear unit		
Motor	Axial kit	
Type	Part No.	Type
DNCE-32		
With servo motor		
EMMS-AS-40-...	543147	EAMM-A-D32-40A
	1322178	EAMM-A-D32A-40A-S1 ¹⁾
EMMS-AS-55-...	550979	EAMM-A-D32-55A
	1322180	EAMM-A-D32A-55A-S1 ¹⁾
With stepper motor		
EMMS-ST-42-...	543148	EAMM-A-D32-42A
	1322179	EAMM-A-D32A-42A-S1 ¹⁾
EMMS-ST-57-...	550980	EAMM-A-D32-57A
	1322181	EAMM-A-D32A-57A-S1 ¹⁾
With motor unit		
MTR-DCI-32S-... ²⁾	543149	EAMM-A-D32-32B
DNCE-40		
With servo motor		
EMMS-AS-55-...	543153	EAMM-A-D40-55A
	1322182	EAMM-A-D40A-55A-S1 ¹⁾
EMMS-AS-70-...	550981	EAMM-A-D40-70A
	1322185	EAMM-A-D40A-70A-S1 ¹⁾
With servo motor and gear unit		
EMMS-AS-40-...	560282	EAMM-A-D40-40G
EMGA-40-P-G...-SAS-40		
With stepper motor		
EMMS-ST-57-...	543154	EAMM-A-D40-57A
	1322183	EAMM-A-D40A-57A-S1 ¹⁾
EMMS-ST-87-...	550982	EAMM-A-D40-87A
	1322186	EAMM-A-D40A-87A-S1 ¹⁾
With motor unit		
MTR-DCI-42S-...-G7 ²⁾	543155	EAMM-A-D40-42B
MTR-DCI-42S-...-G14 ²⁾	543156	EAMM-A-D40-42C

Without gear unit		
Motor	Axial kit	
Type	Part No.	Type
DNCE-63		
With servo motor		
EMMS-AS-70-...	543161	EAMM-A-D60-70A
	1322187	EAMM-A-D60A-70A-S1 ¹⁾
EMMS-AS-100-...	550983	EAMM-A-D60-100A
	1322190	EAMM-A-D60A-100A-S1 ¹⁾
With servo motor and gear unit		
EMMS-AS-55-...	560283	EAMM-A-D60-60G
EMGA-60-P-G...-SAS-55		
EMMS-AS-70-...	560283	EAMM-A-D60-60G
EMGA-60-P-G...-SAS-70		
With stepper motor		
EMMS-ST-87-...	543162	EAMM-A-D60-87A
	1322188	EAMM-A-D60A-87A-S1 ¹⁾
With stepper motor and gear unit		
EMMS-ST-57-...	560283	EAMM-A-D60-60G
EMGA-60-P-G...-SST-57		
With motor unit		
MTR-DCI-52S-...-G7 ²⁾	543163	EAMM-A-D60-52B
MTR-DCI-52S-...-G14 ²⁾	543164	EAMM-A-D60-52C

- 1) With protection class IP65.
- 2) Only in combination with DNCE-...-LS.

Note

Depending on the combination of motor/motor unit and electric cylinder, it may not be possible to reach the maximum feed force of the cylinder.

The axial kit (without "S1" in the type code) can be retrofitted with a seal set EADS-F to change the protection class from IP40 to IP65.
→ 44

Axial kits EAMM-A

Product range overview

Permissible axis/motor combinations with electric cylinder ESBF

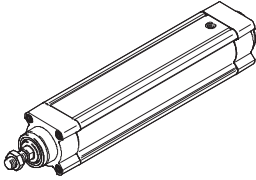

Without gear unit		
Motor	Axial kit	
Type	Part No.	Type
ESBF-63		
With servo motor		
EMMS-AS-70-...	543161	EAMM-A-D60-70A
	1679566	EAMM-A-D60B-70A-S1 ¹⁾
EMMS-AS-100-...	550983	EAMM-A-D60-100A
	1679518	EAMM-A-D60B-100A-S1 ¹⁾
With servo motor and gear unit		
EMMS-AS-55-... EMGA-60-P-G...-SAS-55	560283	EAMM-A-D60-60G
EMMS-AS-70-... EMGA-60-P-G...-SAS-70	560283	EAMM-A-D60-60G
With stepper motor and gear unit		
EMMS-ST-57-... EMGA-60-P-G...-SST-57	560283	EAMM-A-D60-60G
ESBF-80		
With servo motor		
EMMS-AS-100-...	1589665	EAMM-A-D80-100A
	1600673	EAMM-A-D80B-100A-S1 ¹⁾
EMMS-AS-140-...	1588299	EAMM-A-D80-140A
	1600674	EAMM-A-D80B-140A-S1 ¹⁾
ESBF-100		
With servo motor		
EMMS-AS-140-...	1588349	EAMM-A-D100-140A
	1600675	EAMM-A-D100B-140A-S1 ¹⁾

1) With protection class IP65.

Note

The axial kit (without "S1" in the type code) can be retrofitted with a seal set EADS-F to change the protection class from IP40 to IP65.

→ 44

Axial kits EAMM-A

Product range overview

FESTO

Permissible axis/motor combinations with toothed belt axis EGC-TB

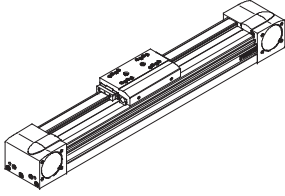

Without gear unit		
Motor	Axial kit	
Type	Part No.	Type
EGC-50		
With servo motor		
EMMS-AS-55-...	557975	EAMM-A-L27-55A
With stepper motor		
EMMS-ST-57-...	560678	EAMM-A-L27-57A
EGC-70		
With servo motor		
EMMS-AS-70-...	557979	EAMM-A-L38-70A
With stepper motor		
EMMS-ST-57-...	560679	EAMM-A-L38-57A
EMMS-ST-87-...	560680	EAMM-A-L38-87A
EGC-80		
With servo motor		
EMMS-AS-70-...	557982	EAMM-A-L48-70A
EMMS-AS-100-...	557984	EAMM-A-L48-100A
With stepper motor		
EMMS-ST-87-...	560683	EAMM-A-L48-87A
EGC-120		
With servo motor		
EMMS-AS-100-...	557988	EAMM-A-L62-100A
EMMS-AS-140-...	557990	EAMM-A-L62-140A
EGC-185		
With servo motor		
EMMS-AS-140-...	557994	EAMM-A-L95-140A
EMMS-AS-190-...	1378474	EAMM-A-L95-190A

With gear unit		
Motor	Axial kit	
Gear unit	Part No.	Type
EGC-50		
With servo motor and gear unit		
EMMS-AS-40-... EMGA-40-P-G...-SAS-40	557974	EAMM-A-L27-40G
EGC-70		
With servo motor and gear unit		
EMMS-AS-55-... EMGA-60-P-G...-SAS-55	557978	EAMM-A-L38-60G
EGC-80		
With servo motor and gear unit		
EMMS-AS-70-... EMGA-60-P-G...-SAS-70	557983	EAMM-A-L48-60G
EGC-120		
With servo motor and gear unit		
EMMS-AS-100-... EMGA-80-P-G...-SAS-100	557989	EAMM-A-L62-80G
EGC-185		
With servo motor and gear unit		
EMMS-AS-140-... EMGA-120-P-G...-SAS-140	557995	EAMM-A-L95-120G

Axial kits EAMM-A

Product range overview

Permissible axis/motor combinations with spindle axis EGC-BS

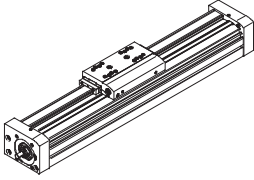

Without gear unit		
Motor	Axial kit	
Type	Part No.	Type
EGC-70		
With servo motor		
EMMS-AS-40-...	558162	EAMM-A-S38-40A
EMMS-AS-55-...	558163	EAMM-A-S38-55A
With stepper motor		
EMMS-ST-42-...	560685	EAMM-A-S38-42A
EMMS-ST-57-...	560686	EAMM-A-S38-57A
EGC-80		
With servo motor		
EMMS-AS-55-...	558164	EAMM-A-S48-55A
EMMS-AS-70-...	558165	EAMM-A-S48-70A
With stepper motor		
EMMS-ST-57-...	560687	EAMM-A-S48-57A
EMMS-ST-87-...	560688	EAMM-A-S48-87A

Without gear unit		
Motor	Axial kit	
Type	Part No.	Type
EGC-120		
With servo motor		
EMMS-AS-70-...	558166	EAMM-A-S62-70A
EMMS-AS-100-...	558167	EAMM-A-S62-100A
EMMS-AS-140-...	558168	EAMM-A-S62-140A
With stepper motor		
EMMS-ST-87-...	560689	EAMM-A-S62-87A
EGC-185		
With servo motor		
EMMS-AS-100-...	558169	EAMM-A-S95-100A
EMMS-AS-140-...	558170	EAMM-A-S95-140A

Permissible axis/motor combinations with toothed belt axis ELGA-TB

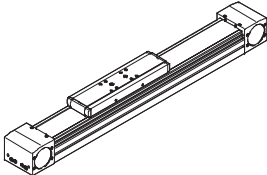

Without gear unit		
Motor	Axial kit	
Type	Part No.	Type
ELGA-TB-...-70		
With servo motor		
EMMS-AS-70-...	1202331	EAMM-A-N38-70A
ELGA-TB-...-80		
With servo motor		
EMMS-AS-100-...	1201894	EAMM-A-N48-100A
ELGA-TB-...-120		
With servo motor		
EMMS-AS-140-...	1201691	EAMM-A-N80-140A

With gear unit		
Motor	Axial kit	
Gear unit	Part No.	Type
ELGA-TB-...-70		
With servo motor and gear unit		
EMMS-AS-70-... EMGA-60-P-G...-SAS-70	1202253	EAMM-A-N38-60G
ELGA-TB-...-80		
With servo motor and gear unit		
EMMS-AS-70-... EMGA-80-P-G...-SAS-70	1258793	EAMM-A-N48-80G
EMMS-AS-100-... EMGA-80-P-G...-SAS-100	1258793	EAMM-A-N48-80G
ELGA-TB-...-120		
With servo motor and gear unit		
EMMS-AS-140-... EMGA-120-P-G...-SAS-140	1201695	EAMM-A-N80-120G

Axial kits EAMM-A

Product range overview

FESTO

Permissible axis/motor combinations with toothed belt axis EGC-HD-TB

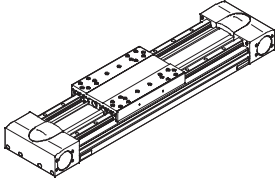

With gear unit		
Motor	Axial kit	
Type	Part No.	Type
EGC-HD-125		
With servo motor and gear unit		
EMMS-AS-70-...	1190076	EAMM-A-M43-60G
EMGA-60-P-G...-SAS-70		
EGC-HD-160		
With servo motor and gear unit		
EMMS-AS-100-...	1190421	EAMM-A-M48-80G
EMGA-80-P-G...-SAS-100		
EGC-HD-220		
With servo motor and gear unit		
EMMS-AS-140-...	1190774	EAMM-A-M80-120G
EMGA-120-P-G...-SAS-140		

Permissible axis/motor combinations with spindle axis EGC-HD-BS

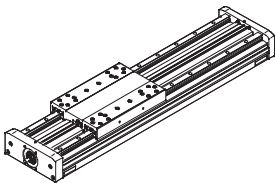

Without gear unit		
Motor	Axial kit	
Type	Part No.	Type
EGC-HD-125		
With servo motor		
EMMS-AS-40-...	558162	EAMM-A-S38-40A
EMMS-AS-55-...	558163	EAMM-A-S38-55A
With stepper motor		
EMMS-ST-42-...	560685	EAMM-A-S38-42A
EMMS-ST-57-...	560686	EAMM-A-S38-57A
EGC-HD-160		
With servo motor		
EMMS-AS-55-...	558164	EAMM-A-S48-55A
EMMS-AS-70-...	558165	EAMM-A-S48-70A
With stepper motor		
EMMS-ST-57-...	560687	EAMM-A-S48-57A
EMMS-ST-87-...	560688	EAMM-A-S48-87A

Without gear unit		
Motor	Axial kit	
Type	Part No.	Type
EGC-HD-220		
With servo motor		
EMMS-AS-70-...	558166	EAMM-A-S62-70A
EMMS-AS-100-...	558167	EAMM-A-S62-100A
EMMS-AS-140-...	558168	EAMM-A-S62-140A
With stepper motor		
EMMS-ST-87-...	560689	EAMM-A-S62-87A

Axial kits EAMM-A

Product range overview

Permissible axis/motor combinations with mini slide EGSL

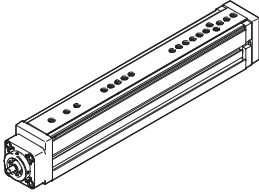

Without gear unit		
Motor	Axial kit	
Type	Part No.	Type
EGSL-35		
With servo motor		
EMMS-AS-40-...	1199152	EAMM-A-D19-40A
With stepper motor		
EMMS-ST-28-...	1081659	EAMM-A-D19-28A
EMMS-ST-42-...	1087642	EAMM-A-D19-42A
EGSL-45		
With servo motor		
EMMS-AS-40-...	543147	EAMM-A-D32-40A
EMMS-AS-55-...	550979	EAMM-A-D32-55A
With stepper motor		
EMMS-ST-42-...	543148	EAMM-A-D32-42A
EMMS-ST-57-...	550980	EAMM-A-D32-57A

Without gear unit		
Motor	Axial kit	
Type	Part No.	Type
EGSL-55		
With servo motor		
EMMS-AS-55-...	543153	EAMM-A-D40-55A
EMMS-AS-70-...	550981	EAMM-A-D40-70A
With stepper motor		
EMMS-ST-57-...	543154	EAMM-A-D40-57A
EMMS-ST-87-...	550982	EAMM-A-D40-87A
EGSL-75		
With servo motor		
EMMS-AS-70-...	543161	EAMM-A-D60-70A
EMMS-AS-100-...	550983	EAMM-A-D60-100A
With stepper motor		
EMMS-ST-87-...	543162	EAMM-A-D60-87A

Permissible axis/motor combinations with cantilever axis EGSA

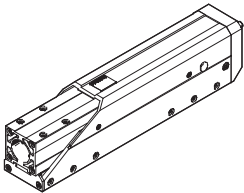

Without gear unit		
Motor	Axial kit	
Type	Part No.	Type
EGSA-50		
With servo motor		
EMMS-AS-40-...	559798	EAMM-A-A19-40A
With stepper motor		
EMMS-ST-42-...	558895	EAMM-A-A19-42A
EGSA-60		
With servo motor		
EMMS-AS-55-...	559799	EAMM-A-A22-55A
EMMS-AS-70-...	558898	EAMM-A-A22-70A
With stepper motor		
EMMS-ST-57-...	558897	EAMM-A-A22-57A

Axial kits EAMM-A

Product range overview

FESTO

Permissible axis/motor combinations with electric slide EGSK, EGSP

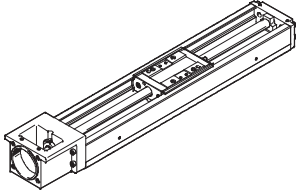

Without gear unit		
Motor	Axial kit	
Type	Part No.	Type
EGSK-15		
With stepper motor		
EMMS-ST-28-...	1703478	EAMM-A-P3-28D-28A
EGSK-20/EGSP-20		
With servo motor		
EMMS-AS-40-...	562637	EAMM-A-P4-28B-40A
With stepper motor		
EMMS-ST-28-...	1731466	EAMM-A-P4-28B-28A
EMMS-ST-42-...	562636	EAMM-A-P4-28B-42A
EGSK-26/EGSP-26		
With servo motor		
EMMS-AS-40-...	562641	EAMM-A-P5-28B-40A
With stepper motor		
EMMS-ST-28-...	1731474	EAMM-A-P5-28B-28A
EMMS-ST-42-...	562640	EAMM-A-P5-28B-42A
EGSK-33		
With servo motor		
EMMS-AS-40-...	562646	EAMM-A-P6-38A-40A
EMMS-AS-55-...	562647	EAMM-A-P6-38A-55A
With stepper motor		
EMMS-ST-42-...	562644	EAMM-A-P6-38A-42A
EMMS-ST-57-...	562645	EAMM-A-P6-38A-57A

Without gear unit		
Motor	Axial kit	
Type	Part No.	Type
EGSK-46/EGSP-33		
With servo motor		
EMMS-AS-40-...	562652	EAMM-A-P8-38A-40A
EMMS-AS-55-...	562653	EAMM-A-P8-38A-55A
EMMS-AS-70-...	564996	EAMM-A-P8-38A-70A
With stepper motor		
EMMS-ST-42-...	562650	EAMM-A-P8-38A-42A
EMMS-ST-57-...	562651	EAMM-A-P8-38A-57A
EMMS-ST-87-...	564998	EAMM-A-P8-38A-87A
EGSP-46		
With servo motor		
EMMS-AS-55-...	562659	EAMM-A-P10-38A-55A
EMMS-AS-70-...	564997	EAMM-A-P10-38A-70A
With stepper motor		
EMMS-ST-57-...	562658	EAMM-A-P10-38A-57A
EMMS-ST-87-...	564999	EAMM-A-P10-38A-87A

Axial kits EAMM-A

Product range overview

Permissible axis/motor combinations with cantilever axis DGEA

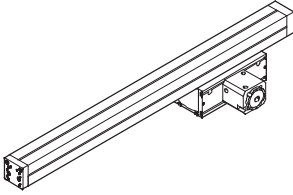

Without gear unit		
Motor	Axial kit	
Type	Part No.	Type
DGEA-18		
With stepper motor		
EMMS-ST-57-...	550956	EAMM-A-F28-57A
EMMS-ST-87-...	550958	EAMM-A-F28-87A
DGEA-25		
With stepper motor		
EMMS-ST-87-...	550960	EAMM-A-F32-87A

With gear unit		
Motor	Axial kit	
Gear unit	Part No.	Type
DGEA-18		
With servo motor and gear unit		
EMMS-AS-55-...	550957	EAMM-A-F28-60G
EMGA-60-P-G...-SAS-55		
With stepper motor and gear unit		
EMMS-ST-57-...	550957	EAMM-A-F28-60G
EMGA-60-P-G...-SST-57		
DGEA-25		
With servo motor and gear unit		
EMMS-AS-70-...	550959	EAMM-A-F32-60G
EMGA-60-P-G...-SAS-70		
DGEA-40		
With servo motor and gear unit		
EMMS-AS-100-...	550935	EAMM-A-F40-80G
EMGA-80-P-G...-SAS-100		
With stepper motor and gear unit		
EMMS-ST-87-...	550935	EAMM-A-F40-80G
EMGA-80-P-G...-SST-87		

Axial kits EAMM-A

Product range overview

FESTO

Permissible axis/motor combinations with toothed belt axis ELGG

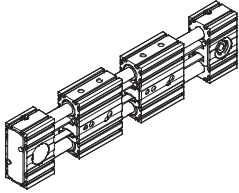

Without gear unit		
Motor	Axial kit	
Type	Part No.	Type
ELGG-35		
With servo motor		
EMMS-AS-55-...	1133400	EAMM-A-R27-55A
With stepper motor		
EMMS-ST-57-...	1133403	EAMM-A-R27-57A
ELGG-45		
With servo motor		
EMMS-AS-70-...	1133401	EAMM-A-R38-70A
With stepper motor		
EMMS-ST-57-...	1578138	EAMM-A-R38-57A
EMMS-ST-87-...	1133404	EAMM-A-R38-87A

Without gear unit		
Motor	Axial kit	
Type	Part No.	Type
ELGG-55		
With servo motor		
EMMS-AS-70-...	1578139	EAMM-A-R48-70A
EMMS-AS-100-...	1133402	EAMM-A-R48-100A
With stepper motor		
EMMS-ST-87-...	1133405	EAMM-A-R48-87A

Permissible axis/motor combinations with toothed belt axis ELGR

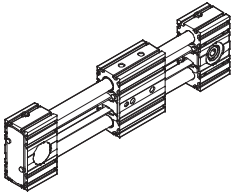

Without gear unit		
Motor	Axial kit	
Type	Part No.	Type
ELGR-35		
With servo motor		
EMMS-AS-55-...	1133400	EAMM-A-R27-55A
With stepper motor		
EMMS-ST-57-...	1133403	EAMM-A-R27-57A
ELGR-45		
With servo motor		
EMMS-AS-70-...	1133401	EAMM-A-R38-70A
With stepper motor		
EMMS-ST-57-...	1578138	EAMM-A-R38-57A
EMMS-ST-87-...	1133404	EAMM-A-R38-87A

Without gear unit		
Motor	Axial kit	
Type	Part No.	Type
ELGR-55		
With servo motor		
EMMS-AS-70-...	1578139	EAMM-A-R48-70A
EMMS-AS-100-...	1133402	EAMM-A-R48-100A
With stepper motor		
EMMS-ST-87-...	1133405	EAMM-A-R48-87A

Axial kits EAMM-A

Product range overview

Permissible axis/motor combinations with rotary module ERMB

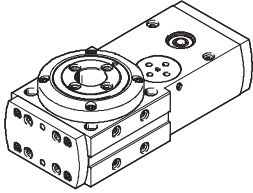

Without gear unit		
Motor	Axial kit	
Type	Part No.	Type
ERMB-20		
With servo motor		
EMMS-AS-40-...	560281	EAMM-A-D32-35A-40A
With stepper motor		
EMMS-ST-42-...	543148	EAMM-A-D32-42A
EMMS-ST-57-...	550980	EAMM-A-D32-57A
With motor unit		
MTR-DCI-32S-...	543149	EAMM-A-D32-32B
ERMB-25		
With servo motor		
EMMS-AS-55-...	543153	EAMM-A-D40-55A
EMMS-AS-70-...	550981	EAMM-A-D40-70A
With stepper motor		
EMMS-ST-57-...	543154	EAMM-A-D40-57A
With motor unit		
MTR-DCI-42S-...-G7	543155	EAMM-A-D40-42B
MTR-DCI-42S-...-G14	543156	EAMM-A-D40-42C
ERMB-32		
With servo motor		
EMMS-AS-70-...	543161	EAMM-A-D60-70A
EMMS-AS-100-...	550983	EAMM-A-D60-100A
With stepper motor		
EMMS-ST-87-...	543162	EAMM-A-D60-87A
With motor unit		
MTR-DCI-52S-...-G7	543163	EAMM-A-D60-52B
MTR-DCI-52S-...-G14	543164	EAMM-A-D60-52C

With gear unit		
Motor	Axial kit	
Gear unit	Part No.	Type
ERMB-25		
With servo motor and gear unit		
EMMS-AS-40-...	560282	EAMM-A-D40-40G
EMGA-40-P-G...-SAS-40		
ERMB-32		
With servo motor and gear unit		
EMMS-AS-55-...	560283	EAMM-A-D60-60G
EMGA-60-P-G...-SAS-55		
EMMS-AS-70-...	560283	EAMM-A-D60-60G
EMGA-60-P-G...-SAS-70		
With stepper motor and gear unit		
EMMS-ST-57-...	560283	EAMM-A-D60-60G
EMGA-60-P-G...-SST-57		

Axial kits EAMM-A

Product range overview

FESTO

Permissible axis/motor combinations with rotary/lifting module EHMB

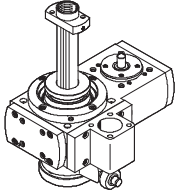

Without gear unit – for linear motion		
Motor	Axial kit	
Type	Part No.	Type
DNCE-32		
With servo motor		
EMMS-AS-40-...	543147	EAMM-A-D32-40A
EMMS-AS-55-...	550979	EAMM-A-D32-55A
With stepper motor		
EMMS-ST-42-...	543148	EAMM-A-D32-42A
EMMS-ST-57-...	550980	EAMM-A-D32-57A
With motor unit		
MTR-DCI-32S-... ¹⁾	543149	EAMM-A-D32-32B
DNCE-40		
With servo motor		
EMMS-AS-55-...	543153	EAMM-A-D40-55A
EMMS-AS-70-...	550981	EAMM-A-D40-70A
With stepper motor		
EMMS-ST-57-...	543154	EAMM-A-D40-57A
EMMS-ST-87-...	550982	EAMM-A-D40-87A
With motor unit		
MTR-DCI-42S-...-G7 ¹⁾	543155	EAMM-A-D40-42B
MTR-DCI-42S-...-G14 ¹⁾	543156	EAMM-A-D40-42C

1) Only in combination with DNCE-...-LS.

Note

Depending on the combination of motor/motor unit and electric cylinder, it may not be possible to reach the maximum feed force of the cylinder.

Without gear unit – for rotary motion		
Motor	Axial kit	
Type	Part No.	Type
EHMB-20		
With servo motor		
EMMS-AS-40-...	560281	EAMM-A-D32-35A-40A
With stepper motor		
EMMS-ST-42-...	543148	EAMM-A-D32-42A
EMMS-ST-57-...	550980	EAMM-A-D32-57A
With motor unit		
MTR-DCI-32S-...	543149	EAMM-A-D32-32B
EHMB-25		
With servo motor		
EMMS-AS-55-...	543153	EAMM-A-D40-55A
EMMS-AS-70-...	550981	EAMM-A-D40-70A
With stepper motor		
EMMS-ST-57-...	543154	EAMM-A-D40-57A
With motor unit		
MTR-DCI-42S-...-G7	543155	EAMM-A-D40-42B
MTR-DCI-42S-...-G14	543156	EAMM-A-D40-42C
EHMB-32		
With servo motor		
EMMS-AS-70-...	543161	EAMM-A-D60-70A
EMMS-AS-100-...	550983	EAMM-A-D60-100A
With stepper motor		
EMMS-ST-87-...	543162	EAMM-A-D60-87A
With motor unit		
MTR-DCI-52S-...-G7	543163	EAMM-A-D60-52B
MTR-DCI-52S-...-G14	543164	EAMM-A-D60-52C

With gear unit – for rotary motion		
Motor	Axial kit	
Gear unit		
Type	Part No.	Type
EHMB-25		
With servo motor and gear unit		
EMMS-AS-40-...	560282	EAMM-A-D40-40G
EMGA-40-P-G...-SAS-40		
EHMB-32		
With servo motor and gear unit		
EMMS-AS-55-...	560283	EAMM-A-D60-60G
EMGA-60-P-G...-SAS-55		
EMMS-AS-70-...	560283	EAMM-A-D60-60G
EMGA-60-P-G...-SAS-70		
With stepper motor and gear unit		
EMMS-ST-57-...	560283	EAMM-A-D60-60G
EMGA-60-P-G...-SST-57		

Axial kits EAMM-A

Type codes

With protection class IP40

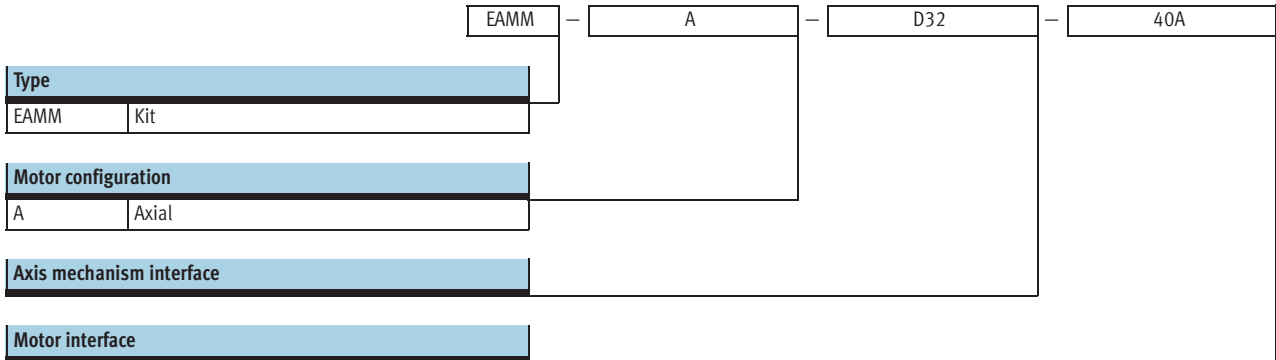

With protection class IP65

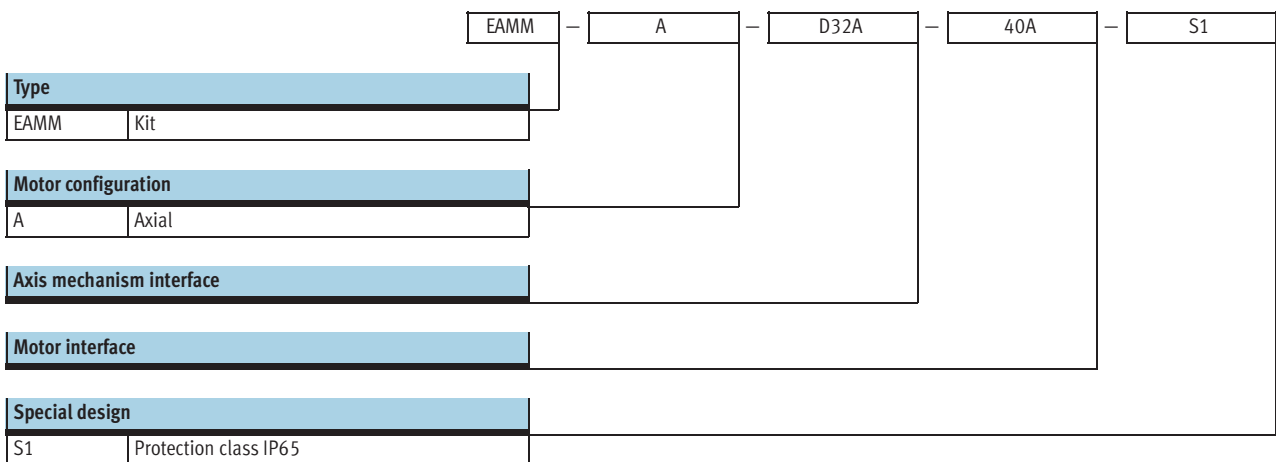

- 1 - Type discontinued EGSA
Available up until 2013

Axial kits EAMM-A

Technical data

Materials:

Coupling housing, coupling hubs,

motor flange: Aluminium

Screws: Galvanised steel



General technical data							
Type	For axis	Transferable torque [Nm]	Mass moment of inertia [kgmm ²]	Max. rotational speed [rpm]	Weight [g]	Protection class ¹⁾	→ Page
EAMM-A-A19-40A	EGSA	2.3	1.06	10,000	240	IP40	42
EAMM-A-A19-42A	EGSA	2.2	1.06	8,000	270	IP40	
EAMM-A-A22-55A	EGSA	8	6.06	10,000	430	IP40	
EAMM-A-A22-57A	EGSA	7.5	6.06	8,000	430	IP40	
EAMM-A-A22-70A	EGSA	8	6.06	10,000	480	IP40	
EAMM-A-D19-28A	EGSL	1.1	0.28	10,000	80	IP40	28
EAMM-A-D19-40A	EGSL	1.1	0.28	10,000	110	IP40	
EAMM-A-D19-42A	EGSL	1.1	0.28	10,000	130	IP40	
EAMM-A-D32-32B	DNCE, ERMB, EHMB	1.1	0.3	10,000	150	IP40	
EAMM-A-D32-35A-40A	ERMB	4	5.87	8,000	220	IP40	
EAMM-A-D32-40A	EGSL, DNCE, EHMB	1.1	0.3	10,000	130	IP40	
EAMM-A-D32A-40A-S1	DNCE	1.1	0.3	10,000	130	IP65	
EAMM-A-D32-42A	EGSL, DNCE, ERMB, EHMB	0.8	0.3	10,000	140	IP40	
EAMM-A-D32A-42A-S1	DNCE	0.8	0.3	10,000	140	IP65	
EAMM-A-D32-55A	EGSL, DNCE, EHMB	4	5.87	8,000	260	IP40	
EAMM-A-D32A-55A-S1	DNCE	4	5.87	8,000	260	IP65	
EAMM-A-D32-57A	EGSL, DNCE, ERMB, EHMB	4	5.87	8,000	270	IP40	
EAMM-A-D32A-57A-S1	DNCE	4	5.87	8,000	270	IP65	
EAMM-A-D40-40G	ERMB	8	5.87	8,000	350	IP40	
EAMM-A-D40-42B	DNCE, ERMB, EHMB	8	5.87	8,000	340	IP40	
EAMM-A-D40-42C	DNCE, ERMB, EHMB	8	5.87	8,000	370	IP40	
EAMM-A-D40-55A	EGSL, DNCE, ERMB, EHMB	8	5.87	8,000	350	IP40	
EAMM-A-D40A-55A-S1	DNCE	8	5.87	8,000	350	IP65	
EAMM-A-D40-57A	EGSL, DNCE, ERMB, EHMB	6	5.87	8,000	350	IP40	
EAMM-A-D40A-57A-S1	DNCE	6	5.87	8,000	350	IP65	
EAMM-A-D40-70A	EGSL, DNCE, ERMB, EHMB	8	5.87	8,000	410	IP40	
EAMM-A-D40A-70A-S1	DNCE	8	5.87	8,000	410	IP65	
EAMM-A-D40-87A	EGSL, DNCE, EHMB	8	5.87	8,000	530	IP40	
EAMM-A-D40A-87A-S1	DNCE	8	5.87	8,000	530	IP65	
EAMM-A-D60-52B	DNCE, ERMB	14	35.5	6,000	930	IP40	
EAMM-A-D60-52C	DNCE, ERMB	14	35.5	6,000	1,020	IP40	
EAMM-A-D60-60G	ERMB, ESBF	12	35.5	6,000	830	IP40	
EAMM-A-D60-70A	EGSL, DNCE, ESBF, ERMB	12	35.5	6,000	750	IP40	
EAMM-A-D60A-70A-S1	DNCE	12	35.5	6,000	750	IP65	
EAMM-A-D60B-70A-S1	ESBF	12	35.5	6,000	750	IP65	
EAMM-A-D60-87A	EGSL, DNCE, ERMB	12	35.5	6,000	890	IP40	
EAMM-A-D60A-87A-S1	DNCE	12	35.5	6,000	890	IP65	
EAMM-A-D60-100A	EGSL, DNCE, ERMB, ESBF	14	35.5	6,000	1,170	IP40	
EAMM-A-D60A-100A-S1	DNCE	14	35.5	6,000	1,170	IP65	
EAMM-A-D60B-100A-S1	ESBF	14	35.5	6,000	1,170	IP65	

1) Only in combination with attached motor and axis.

Axial kits EAMM-A

Technical data



General technical data							
Type	For axis	Transferable torque [Nm]	Mass moment of inertia [kgmm ²]	Max. rotational speed [rpm]	Weight [g]	Protection class ¹⁾	→ Page
EAMM-A-D80-100A	ESBF	17	34.8	6,000	2,030	IP40	28
EAMM-A-D80B-100A-S1	ESBF	17	34.8	6,000	2,030	IP65	
EAMM-A-D80-140A	ESBF	60	128	5,500	2,920	IP40	
EAMM-A-D80B-140A-S1	ESBF	60	128	5,500	2,920	IP65	
EAMM-A-D100-140A	ESBF	143	280	4,500	3,460	IP40	
EAMM-A-D100B-140A-S1	ESBF	143	280	4,500	3,460	IP65	
EAMM-A-E20-32B	DMES	1.5	0.23	10,000	80	IP40	26
EAMM-A-E20-40A	DGE-SP, DMES	1	0.13	12,000	78	IP40	
EAMM-A-E20-42A	DGE-SP, DMES	1	0.13	12,000	91	IP40	
EAMM-A-E20-55A	DGE-SP, DMES	1	0.13	12,000	134	IP40	
EAMM-A-E32-40A	DGE-SP, DMES	7.5	6.1	8,000	243	IP40	
EAMM-A-E32-42B	DMES	7	5.87	8,000	50	IP40	
EAMM-A-E32-42C	DMES	7	5.87	8,000	50	IP40	
EAMM-A-E32-55A	DGE-SP, DMES	7.5	6.1	8,000	271	IP40	
EAMM-A-E32-57A	DGE-SP, DMES	7.5	6.1	8,000	288	IP40	
EAMM-A-E48-52B	DMES	17	35.5	6,000	142	IP40	
EAMM-A-E48-52C	DMES	17	35.5	6,000	142	IP40	
EAMM-A-E48-55A	DGE-SP	8.3	6.1	8,000	523	IP40	
EAMM-A-E48-57A	DGE-SP	7.5	6.1	8,000	534	IP40	
EAMM-A-E48-44A-70A	DGE-SP	8.9	6.1	8,000	591	IP40	
EAMM-A-E48-64A-70A	DMES	17	42.3	6,500	785	IP40	
EAMM-A-E48-87A	DGE-SP, DMES	17	42.3	6,500	1,278	IP40	
EAMM-A-E48-100A	DGE-SP, DMES	17	42.3	6,500	1,492	IP40	
EAMM-A-E48-40G	DGE-SP	8.6	6.1	8,000	542	IP40	
EAMM-A-E72-62B	DMES	17	35.5	6,000	2,800	IP40	
EAMM-A-E72-70A	DGE-SP, DMES	17	42.3	6,500	2,362	IP40	
EAMM-A-E72-87A	DGE-SP, DMES	17	42.3	6,500	3,032	IP40	
EAMM-A-E72-100A	DGE-SP, DMES	17	42.3	6,500	3,235	IP40	
EAMM-A-E72-60G	DGE-SP, DMES	17	42.3	6,500	3,182	IP40	
EAMM-A-E72-80G	DGE-SP, DMES	17	42.3	6,500	3,183	IP40	
EAMM-A-F28-57A	DGEA	7.5	6.1	8,000	282	IP40	43
EAMM-A-F28-87A	DGEA	8	6.1	8,000	454	IP40	
EAMM-A-F28-60G	DGEA	8	6.1	8,000	345	IP40	
EAMM-A-F30-55A	DGE-ZR	8	6.1	8,000	271	IP40	22
EAMM-A-F30-57A	DGE-ZR	7.5	6.1	8,000	282	IP40	
EAMM-A-F30-70A	DGE-ZR	8	6.1	8,000	327	IP40	
EAMM-A-F30-87A	DGE-ZR	8	6.1	8,000	439	IP40	
EAMM-A-F30-60G	DGE-ZR	8	6.1	8,000	409	IP40	
EAMM-A-F32-87A	DGEA	17	42.3	6,500	773	IP40	43
EAMM-A-F32-60G	DGEA	17	42.3	6,500	918	IP40	
EAMM-A-F40-80G	DGEA	17	42.3	6,500	890	IP40	
EAMM-A-F37-55A	DGE-ZR	8	6.1	8,000	271	IP40	22
EAMM-A-F37-57A	DGE-ZR	7.5	6.1	8,000	274	IP40	
EAMM-A-F37-70A	DGE-ZR	8	6.1	8,000	328	IP40	
EAMM-A-F37-87A	DGE-ZR	8	6.1	8,000	478	IP40	
EAMM-A-F37-60G	DGE-ZR	8	6.1	8,000	348	IP40	
EAMM-A-F40-70A	DGE-ZR	17	42.3	6,500	637	IP40	
EAMM-A-F40-87A	DGE-ZR	17	42.3	6,500	786	IP40	
EAMM-A-F40-100A	DGE-ZR	17	42.3	6,500	938	IP40	
EAMM-A-F40-80G	DGE-ZR	17	42.3	6,500	893	IP40	

1) Only in combination with attached motor and axis.

Axial kits EAMM-A

Technical data

General technical data							
Type	For axis	Transferable torque [Nm]	Mass moment of inertia [kgmm ²]	Max. rotational speed [rpm]	Weight [g]	Protection class ¹⁾	→ Page
EAMM-A-F47-87A	DGE-ZR	17	42.3	6,500	778	IP40	22
EAMM-A-F47-100A	DGE-ZR	17	42.3	6,500	1,012	IP40	
EAMM-A-F47-140A	DGE-ZR	17	42.3	6,500	1,927	IP40	
EAMM-A-F47-80G	DGE-ZR	17	42.3	6,500	1,000	IP40	
EAMM-A-F62-100A	DGE-ZR	85	417	4,500	2,538	IP40	
EAMM-A-F62-140A	DGE-ZR	92	417	4,500	2,777	IP40	
EAMM-A-F62-80G	DGE-ZR	85	417	4,500	2,760	IP40	
EAMM-A-F62-120G	DGE-ZR	92	417	4,500	2,478	IP40	
EAMM-A-F80-100A	DGE-ZR	85	417	4,500	2,563	IP40	
EAMM-A-F80-140A	DGE-ZR	92	417	4,500	2,635	IP40	
EAMM-A-F80-80G	DGE-ZR	85	417	4,500	2,803	IP40	
EAMM-A-F80-120G	DGE-ZR	92	417	4,500	2,725	IP40	
EAMM-A-F80-160G	DGE-ZR	62	417	4,500	5,237	IP40	
EAMM-A-G13-40A	DGE-ZR	1	0.13	12,000	71	IP40	
EAMM-A-G13-42A	DGE-ZR	1	0.13	12,000	84	IP40	
EAMM-A-G16-40A	DGE-ZR	1	0.13	12,000	76	IP40	
EAMM-A-G16-42A	DGE-ZR	1	0.13	12,000	117	IP40	
EAMM-A-G16-55A	DGE-ZR	1	0.13	12,000	138	IP40	
EAMM-A-G19-40A	DGE-ZR	1.5	0.47	8,000	158	IP40	
EAMM-A-G19-55A	DGE-ZR	1.5	0.47	8,000	183	IP40	
EAMM-A-G19-57A	DGE-ZR	1.5	0.47	8,000	199	IP40	
EAMM-A-L27-55A	EGC-TB	2	0.445	10,000	220	IP40	33
EAMM-A-L27-57A	EGC-TB	1.6	0.355	10,000	180	IP40	
EAMM-A-L27-40G	EGC-TB	2	0.445	10,000	180	IP40	
EAMM-A-L38-57A	EGC-TB	3.6	3.2	8,000	220	IP40	
EAMM-A-L38-70A	EGC-TB	4.4	3.2	8,000	290	IP40	
EAMM-A-L38-87A	EGC-TB	4.4	3.2	8,000	480	IP40	
EAMM-A-L38-60G	EGC-TB	4.4	3.2	8,000	345	IP40	
EAMM-A-L48-70A	EGC-TB	12.5	14.5	8,000	345	IP40	
EAMM-A-L48-87A	EGC-TB	12.5	14.5	8,000	590	IP40	
EAMM-A-L48-100A	EGC-TB	17	39	6,000	985	IP40	
EAMM-A-L48-60G	EGC-TB	12.5	14.5	8,000	485	IP40	
EAMM-A-L62-100A	EGC-TB	47	147	5,500	1,605	IP40	
EAMM-A-L62-140A	EGC-TB	47	147	5,500	2,420	IP40	
EAMM-A-L62-80G	EGC-TB	47	147	5,500	1,620	IP40	
EAMM-A-L95-140A	EGC-TB	143	374	4,500	3,710	IP40	
EAMM-A-L95-190A	EGC-TB	192	374	4,500	5,279	IP40	
EAMM-A-L95-120G	EGC-TB	150	374	4,500	3,660	IP40	33
EAMM-A-M43-60G	EGC-HD-TB	12.5	14.5	8,000	126	IP40	
EAMM-A-M48-80G	EGC-HD-TB	21	39	6,000	190	IP40	
EAMM-A-M80-120G	EGC-HD-TB	75	147	5,500	392	IP40	36
EAMM-A-N38-70A	ELGA	12.5	14.5	8,000	430	IP40	
EAMM-A-N38-60G	ELGA	12.5	14.5	8,000	470	IP40	
EAMM-A-N48-100A	ELGA	17	39	6,000	1,070	IP40	
EAMM-A-N48-80G	ELGA	17	39	6,000	1,080	IP40	
EAMM-A-N80-140A	ELGA	60	147	5,500	2,070	IP40	
EAMM-A-N80-120G	ELGA	60	147	5,500	1,990	IP40	35
EAMM-A-S38-40A	EGC-BS, EGC-HD-BS	6.5	5.87	8,000	370	IP40	
EAMM-A-S38-42A	EGC-BS, EGC-HD-BS	3.5	5.87	8,000	412	IP40	
EAMM-A-S38-55A	EGC-BS, EGC-HD-BS	6.5	5.87	8,000	400	IP40	
EAMM-A-S38-57A	EGC-BS, EGC-HD-BS	6.5	5.87	8,000	400	IP40	

1) Only in combination with attached motor and axis.

Axial kits EAMM-A

Technical data

FESTO

General technical data							
Type	For axis	Transferable torque [Nm]	Mass moment of inertia [kgmm ²]	Max. rotational speed [rpm]	Weight [g]	Protection class ¹⁾	→ Page
EAMM-A-S48-55A	EGC-BS, EGC-HD-BS	12.5	5.87	8,000	590	IP40	35
EAMM-A-S48-57A	EGC-BS, EGC-HD-BS	6.5	5.87	8,000	580	IP40	
EAMM-A-S48-70A	EGC-BS, EGC-HD-BS	12.5	5.87	8,000	610	IP40	
EAMM-A-S48-87A	EGC-BS, EGC-HD-BS	12.5	5.87	8,000	760	IP40	
EAMM-A-S62-70A	EGC-BS, EGC-HD-BS	17	45.5	6,000	1,950	IP40	
EAMM-A-S62-87A	EGC-BS, EGC-HD-BS	17	45.5	6,000	2,070	IP40	
EAMM-A-S62-100A	EGC-BS, EGC-HD-BS	17	34.8	6,000	2,050	IP40	
EAMM-A-S62-140A	EGC-BS, EGC-HD-BS	17	34.1	6,000	2,870	IP40	
EAMM-A-S95-100A	EGC-BS	60	128	5,500	4,910	IP40	
EAMM-A-S95-140A	EGC-BS	60	127	5,500	5,500	IP40	
EAMM-A-P3-28D-28A	EGSK	0.7	0.28	10,000	8	IP40	39
EAMM-A-P4-28B-28A	EGSK, EGSP	0.7	0.28	10,000	8	IP40	
EAMM-A-P4-28B-40A	EGSK, EGSP	0.7	0.28	10,000	50	IP40	
EAMM-A-P4-28B-42A	EGSK, EGSP	0.7	0.28	10,000	60	IP40	
EAMM-A-P5-28B-28A	EGSK, EGSP	1.1	0.28	10,000	8	IP40	
EAMM-A-P5-28B-40A	EGSK, EGSP	1.1	0.28	10,000	50	IP40	
EAMM-A-P5-28A-42A	EGSK, EGSP	1.1	0.28	10,000	60	IP40	
EAMM-A-P6-38A-40A	EGSK, EGSP	6.5	5.88	8,000	100	IP40	
EAMM-A-P6-38A-42A	EGSK, EGSP	3.5	5.88	8,000	160	IP40	
EAMM-A-P6-38A-55A	EGSK, EGSP	6.5	5.88	8,000	130	IP40	
EAMM-A-P6-38A-57A	EGSK, EGSP	6.5	5.88	8,000	130	IP40	
EAMM-A-P8-38A-40A	EGSK, EGSP	6.5	5.88	8,000	100	IP40	
EAMM-A-P8-38A-42A	EGSK, EGSP	3.5	5.88	8,000	160	IP40	
EAMM-A-P8-38A-55A	EGSK, EGSP	12.5	5.88	8,000	130	IP40	
EAMM-A-P8-38A-57A	EGSK, EGSP	6.5	5.88	8,000	130	IP40	
EAMM-A-P8-38A-70A	EGSK, EGSP	12.5	5.88	8,000	200	IP40	
EAMM-A-P8-38A-87A	EGSK, EGSP	12.5	5.88	8,000	380	IP40	
EAMM-A-P10-38A-55A	EGSK, EGSP	12.5	5.88	8,000	130	IP40	
EAMM-A-P10-38A-57A	EGSK, EGSP	6.5	5.88	8,000	130	IP40	
EAMM-A-P10-38A-70A	EGSK, EGSP	12.5	5.88	8,000	200	IP40	
EAMM-A-P10-38A-87A	EGSK, EGSP	12.5	5.88	8,000	380	IP40	
EAMM-A-R27-55A	ELGR, ELGG	2	0.445	10,000	170	IP40	41
EAMM-A-R27-57A	ELGR, ELGG	1.6	0.355	10,000	170	IP40	
EAMM-A-R38-57A	ELGR, ELGG	3.6	3.2	8,000	280	IP40	
EAMM-A-R38-70A	ELGR, ELGG	4.4	3.2	8,000	350	IP40	
EAMM-A-R38-87A	ELGR, ELGG	4.4	3.2	8,000	530	IP40	
EAMM-A-R48-70A	ELGR, ELGG	12.5	14.5	8,000	126	IP40	
EAMM-A-R48-87A	ELGR, ELGG	12.5	14.5	8,000	590	IP40	
EAMM-A-R48-100A	ELGR, ELGG	17	39	6,000	970	IP40	

1) Only in combination with attached motor and axis.

Operating and environmental conditions		
Ambient temperature	[°C]	-10 ... +60
Storage temperature	[°C]	-25 ... +60
Protection class ¹⁾		IP40
Relative air humidity	[%]	0 ... 95
Corrosion resistance class CRC ²⁾		1
Note on materials		RoHS-compliant

1) Only in combination with attached motor and axis.

2) Corrosion resistance class 1 according to Festo standard 940 070

Components subject to low corrosion stress. Transport and storage protection. Parts that do not have primarily decorative surface requirements, e.g. in internal areas that are not visible or behind covers.

Axial kits EAMM-A

Technical data

FESTO

Dimensions and ordering data

Download CAD Data → www.festo.com/us/cad

DGE-ZR-...

EAMM-A-G-...

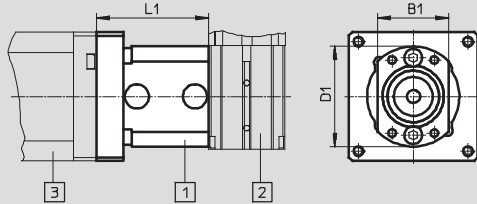

EAMM-A-F-...

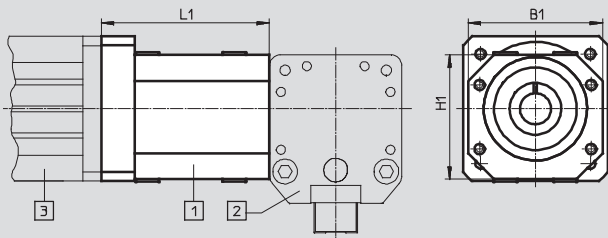

Illustration:

- 1 Axial kit
- 2 Toothed belt axis
- 3 Motor

Type	B1	H1	L1
EAMM-A-F30-55A	45	45	51.4
EAMM-A-F30-57A			52.7
EAMM-A-F30-70A			54.2
EAMM-A-F30-87A			56.2
EAMM-A-F30-60G			60.7
EAMM-A-F37-55A	45	45	51.4
EAMM-A-F37-57A			52.7
EAMM-A-F37-70A			54.2
EAMM-A-F37-87A			56.2
EAMM-A-F37-60G			60.7
EAMM-A-F40-70A	65	60	81.2
EAMM-A-F40-87A			82.7
EAMM-A-F40-100A			86.2
EAMM-A-F40-80G			89.4
EAMM-A-F47-87A			65
EAMM-A-F47-100A	86.2		
EAMM-A-F47-140A	95.5		
EAMM-A-F47-80G	89.4		

Axial kits EAMM-A



Technical data

Type	B1	H1	L1
EAMM-A-F62-100A	100	100	116.2
EAMM-A-F62-140A			112
EAMM-A-F62-80G			119
EAMM-A-F62-120G			119
EAMM-A-F80-100A	100	100	116.2
EAMM-A-F80-140A			112
EAMM-A-F80-80G			119
EAMM-A-F80-120G			119
EAMM-A-F80-160G			151
EAMM-A-G13-40A	22	29	33.9
EAMM-A-G13-42A		42.2	
EAMM-A-G16-40A	22	31	34.9
EAMM-A-G16-42A			42.4
EAMM-A-G16-55A			37.7
EAMM-A-G19-40A	31	44.5	38.5
EAMM-A-G19-55A			39.7
EAMM-A-G19-57A			41

Axial kits EAMM-A

Technical data

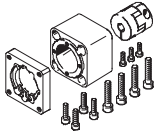

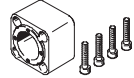
FESTO

Component parts			
Axial kit	Comprising:		
	Motor flange	Coupling	Coupling housing
			
Part No. Type	Part No. Type	Part No. Type	Part No. Type
550929 EAMM-A-F30-55A	529942 EAMF-A-44A/B-55A	557390 EAMC-30-35-8-9	124628 EAMK-A-F30-44A
550930 EAMM-A-F30-57A	530081 EAMF-A-44A/B-57A	530088 EAMC-30-35-6.35-8	124628 EAMK-A-F30-44A
550932 EAMM-A-F30-70A	529943 EAMF-A-44A/B-70A	123042 EAMC-30-35-8-11	124628 EAMK-A-F30-44A
550933 EAMM-A-F30-87A	530082 EAMF-A-44A/B-87A	123042 EAMC-30-35-8-11	124628 EAMK-A-F30-44A
550931 EAMM-A-F30-60G	529944 EAMF-A-44A/B-60G	123042 EAMC-30-35-8-11	124628 EAMK-A-F30-44A
550942 EAMM-A-F37-55A	529942 EAMF-A-44A/B-55A	557390 EAMC-30-35-8-9	534394 EAMK-A-F37-44A
550943 EAMM-A-F37-57A	530081 EAMF-A-44A/B-57A	530088 EAMC-30-35-6.35-8	534394 EAMK-A-F37-44A
550945 EAMM-A-F37-70A	529943 EAMF-A-44A/B-70A	123042 EAMC-30-35-8-11	534394 EAMK-A-F37-44A
550946 EAMM-A-F37-87A	530082 EAMF-A-44A/B-87A	123042 EAMC-30-35-8-11	534394 EAMK-A-F37-44A
550944 EAMM-A-F37-60G	529944 EAMF-A-44A/B-60G	123042 EAMC-30-35-8-11	534394 EAMK-A-F37-44A
550934 EAMM-A-F40-70A	529945 EAMF-A-64A/B-70A	550998 EAMC-40-66-11-15	124629 EAMK-A-F40-64A
550936 EAMM-A-F40-87A	533140 EAMF-A-64A/B-87A	550998 EAMC-40-66-11-15	124629 EAMK-A-F40-64A
550937 EAMM-A-F40-100A	529947 EAMF-A-64A/C/D-100A	123844 EAMC-40-66-15-19	124629 EAMK-A-F40-64A
550935 EAMM-A-F40-80G	533139 EAMF-A-64A/C-80G	123845 EAMC-40-66-15-20	124629 EAMK-A-F40-64A
550948 EAMM-A-F47-87A	533140 EAMF-A-64A/B-87A	550998 EAMC-40-66-11-15	534395 EAMK-A-F47-64A
550949 EAMM-A-F47-100A	529947 EAMF-A-64A/C/D-100A	123844 EAMC-40-66-15-19	534395 EAMK-A-F47-64A
550950 EAMM-A-F47-140A	550988 EAMF-A-64A-140A	176033 EAMC-40-66-15-24	534395 EAMK-A-F47-64A
550947 EAMM-A-F47-80G	533139 EAMF-A-64A/C-80G	123845 EAMC-40-66-15-20	534395 EAMK-A-F47-64A

Axial kits EAMM-A

Technical data

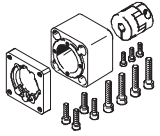
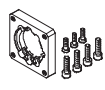
FESTO

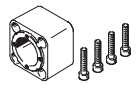
Component parts			
Axial kit	Comprising:		
	Motor flange	Coupling	Coupling housing
			
Part No. Type	Part No. Type	Part No. Type	Part No. Type
550939 EAMM-A-F62-100A	529949 EAMF-A-118C-100A	551000 EAMC-65-90-19-25	124630 EAMK-A-F62-118A/B/C
550941 EAMM-A-F62-140A	550991 EAMF-A-118B-140A	123852 EAMC-65-90-24-25	124630 EAMK-A-F62-118A/B/C
550938 EAMM-A-F62-80G	550989 EAMF-A-118A-80G	176035 EAMC-65-90-20-25	124630 EAMK-A-F62-118A/B/C
550940 EAMM-A-F62-120G	550990 EAMF-A-118A-120G	123853 EAMC-65-90-25-25	124630 EAMK-A-F62-118A/B/C
550952 EAMM-A-F80-100A	529949 EAMF-A-118C-100A	551000 EAMC-65-90-19-25	534396 EAMK-A-F80-118A/B/C
550954 EAMM-A-F80-140A	550991 EAMF-A-118B-140A	123852 EAMC-65-90-24-25	534396 EAMK-A-F80-118A/B/C
550951 EAMM-A-F80-80G	550989 EAMF-A-118A-80G	176035 EAMC-65-90-20-25	534396 EAMK-A-F80-118A/B/C
550953 EAMM-A-F80-120G	550990 EAMF-A-118A-120G	123853 EAMC-65-90-25-25	534396 EAMK-A-F80-118A/B/C
550955 EAMM-A-F80-160G	550992 EAMF-A-118A-160G	551001 EAMC-65-90-25-40	534396 EAMK-A-F80-118A/B/C
550921 EAMM-A-G13-40A	540301 EAMF-A-28A/30A-40A	540750 EAMC-15-22-4-6	171186 EAMK-A-G13-28A
550922 EAMM-A-G13-42A	530080 EAMF-A-28A-42A	530084 EAMC-15-22-4-5	171186 EAMK-A-G13-28A
550923 EAMM-A-G16-40A	540301 EAMF-A-28A/30A-40A	540750 EAMC-15-22-4-6	171185 EAMK-A-G16-30A
550924 EAMM-A-G16-42A	530079 EAMF-A-30A-42A	530084 EAMC-15-22-4-5	171185 EAMK-A-G16-30A
550925 EAMM-A-G16-55A	534807 EAMF-A-30A-55A	184262 EAMC-15-22-4-9	171185 EAMK-A-G16-30A
550926 EAMM-A-G19-40A	550985 EAMF-A-44A/B-40A	184265 EAMC-19-24-6-6	170375 EAMK-A-G19-44B
550927 EAMM-A-G19-55A	529942 EAMF-A-44A/B-55A	184263 EAMC-19-24-6-9	170375 EAMK-A-G19-44B
550928 EAMM-A-G19-57A	530081 EAMF-A-44A/B-57A	530086 EAMC-19-24-6-6.35	170375 EAMK-A-G19-44B

Axial kits EAMM-A

Technical data

FESTO

Dimensions and ordering data

Download CAD Data → www.festo.com/us/cad

DGE-SP-...

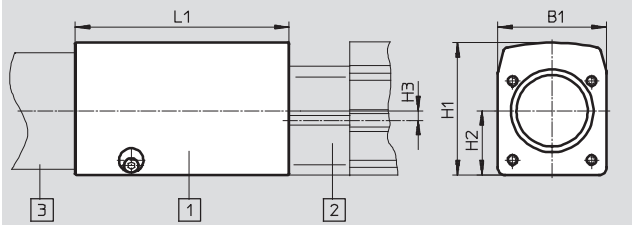

Illustration:

- 1 Axial kit
- 2 Spindle axis
- 3 Motor

DMES-...

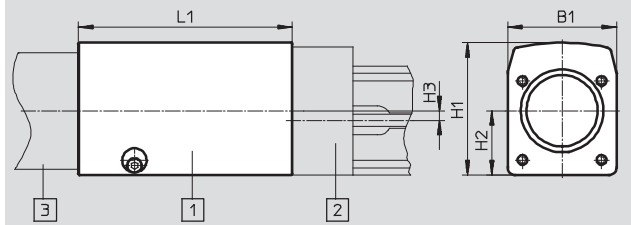

Illustration:



- 1 Axial kit
- 2 Positioning axis
- 3 Motor

Type	B1	H1	H2	H3	L1
EAMM-A-E20-32B	33.6	41	21.6	0	27
EAMM-A-E20-40A	33.5	31.5	15.75	0	27.4
EAMM-A-E20-42A	33.5	31.5	15.75	0	35.7
EAMM-A-E20-55A	33.5	31.5	15.75	0	29.5
EAMM-A-E32-40A	45	45	26.5	4	52.5
EAMM-A-E32-42B	44.8	54.4	26.4	4	88
EAMM-A-E32-42C	44.8	54.4	26.4	4	101
EAMM-A-E32-55A	45	45	26.5	4	53.7
EAMM-A-E32-57A	45	45	26.5	4	55
EAMM-A-E48-52B	63.8	76.4	36.9	5	121
EAMM-A-E48-52C	63.8	76.4	36.9	5	135
EAMM-A-E48-55A	64	64	32	5	57.2
EAMM-A-E48-57A	64	64	32	5	58.5
EAMM-A-E48-44A-70A	64	64	32	5	60
EAMM-A-E48-64A-70A	65	64	32	5	86.2
EAMM-A-E48-87A	65	64	32	5	87.7
EAMM-A-E48-100A	65	64	32	5	91.2
EAMM-A-E48-40G	64	64	32	5	63.5
EAMM-A-E72-62B	105.1	127.3	60.8	8	150
EAMM-A-E72-70A	105.6	114.8	60.8	8	98.7
EAMM-A-E72-87A	105.6	114.8	60.8	8	100.2
EAMM-A-E72-100A	105.6	114.8	60.8	8	103.7
EAMM-A-E72-60G	105.6	114.8	60.8	8	106.9
EAMM-A-E72-80G	105.6	114.8	60.8	8	106.9

Axial kits EAMM-A

Technical data

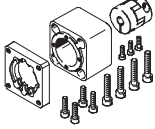
FESTO

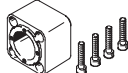
Component parts			
Axial kit	Comprising:		
	Motor flange	Coupling	Coupling housing
			
Part No. Type	Part No. Type	Part No. Type	Part No. Type
556991 EAMM-A-E20-32B	–	533707 EAMC-15-20-5-6	533703 EAMK-A-E20-32B
550961 EAMM-A-E20-40A	552163 EAMF-A-28B-40A	540751 EAMC-15-22-5-6	170374 EAMK-A-E20-28B
550962 EAMM-A-E20-42A	552164 EAMF-A-28B-42A	530085 EAMC-15-22-5-5	170374 EAMK-A-E20-28B
550963 EAMM-A-E20-55A	529946 EAMF-A-28A/B-55A	529953 EAMC-15-22-5-9	170374 EAMK-A-E20-28B
550964 EAMM-A-E32-40A	550985 EAMF-A-44A/B-40A	123040 EAMC-30-35-6-6	124631 EAMK-A-E32-44A
556992 EAMM-A-E32-42B	–	533708 EAMC-30-32-6-8	533704 EAMK-A-E32-42B
556993 EAMM-A-E32-42C	–	533708 EAMC-30-32-6-8	538578 EAMK-A-E32-42C
550965 EAMM-A-E32-55A	529942 EAMF-A-44A/B-55A	530941 EAMC-30-35-6-9	124631 EAMK-A-E32-44A
550966 EAMM-A-E32-57A	530081 EAMF-A-44A/B-57A	530087 EAMC-30-35-6-6.35	124631 EAMK-A-E32-44A
556994 EAMM-A-E48-52B	–	533709 EAMC-42-50-12-12	533705 EAMK-A-E48-52B
556995 EAMM-A-E48-52C	–	533709 EAMC-42-50-12-12	538579 EAMK-A-E48-52C
550969 EAMM-A-E48-55A	529942 EAMF-A-44A/B-55A	550996 EAMC-30-35-9-12	124632 EAMK-A-E48-44A
550970 EAMM-A-E48-57A	530081 EAMF-A-44A/B-57A	550995 EAMC-30-35-6.35-12	124632 EAMK-A-E48-44A
550971 EAMM-A-E48-44A-70A	529943 EAMF-A-44A/B-70A	123051 EAMC-30-35-11-12	124632 EAMK-A-E48-44A
557448 EAMM-A-E48-64A-70A	529945 EAMF-A-64A/B-70A	525864 EAMC-40-66-11-12	529940 EAMK-A-E48-64A
550972 EAMM-A-E48-87A	533140 EAMF-A-64A/B-87A	525864 EAMC-40-66-11-12	529940 EAMK-A-E48-64A
550973 EAMM-A-E48-100A	529947 EAMF-A-64A/C/D-100A	529952 EAMC-40-66-12-19	529940 EAMK-A-E48-64A
550968 EAMM-A-E48-40G	550986 EAMF-A-44A/B-40G	552640 EAMC-30-35-10-12	124632 EAMK-A-E48-44A
556996 EAMM-A-E72-62B	–	533710 EAMC-42-50-14-20	533706 EAMK-A-E72-62B
550975 EAMM-A-E72-70A	529945 EAMF-A-64A/B-70A	550999 EAMC-40-66-11-20	529941 EAMK-A-E72-64A
550977 EAMM-A-E72-87A	533140 EAMF-A-64A/B-87A	550999 EAMC-40-66-11-20	529941 EAMK-A-E72-64A
550978 EAMM-A-E72-100A	529947 EAMF-A-64A/C/D-100A	123847 EAMC-40-66-19-20	529941 EAMK-A-E72-64A
550974 EAMM-A-E72-60G	550987 EAMF-A-64A/B-60G	550999 EAMC-40-66-11-20	529941 EAMK-A-E72-64A
550976 EAMM-A-E72-80G	533139 EAMF-A-64A/C-80G	123849 EAMC-40-66-20-20	529941 EAMK-A-E72-64A

Axial kits EAMM-A

Technical data

FESTO

Dimensions and ordering data

Download CAD Data → www.festo.com/us/cad

EGSL-...

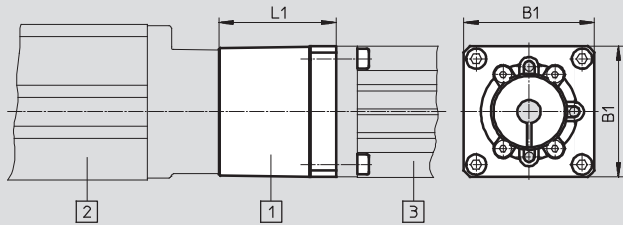

Illustration:

- 1 Axial kit
- 2 Mini slide
- 3 Motor

DNCE-... with protection class IP40

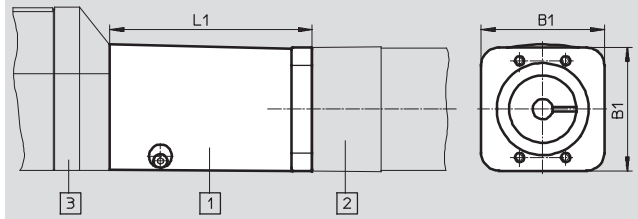

Illustration:

- 1 Axial kit
- 2 Electric cylinder
- 3 Motor

ESBF-... with protection class IP40

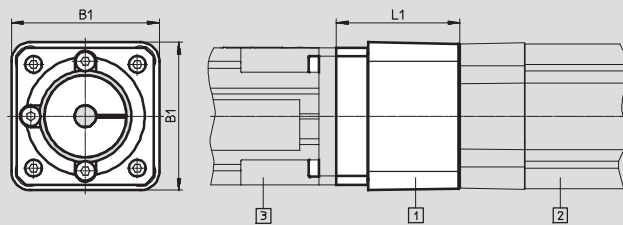

Illustration:

- 1 Axial kit
- 2 Electric cylinder
- 3 Motor

ERMB-...

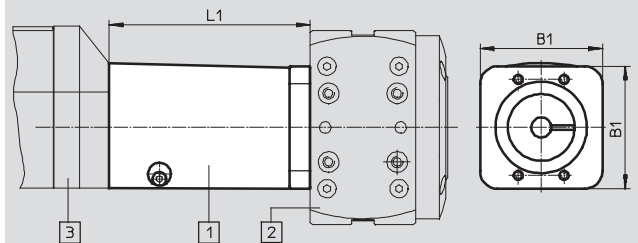

Illustration:

- 1 Axial kit
- 2 Rotary module
- 3 Motor

EHMB-...

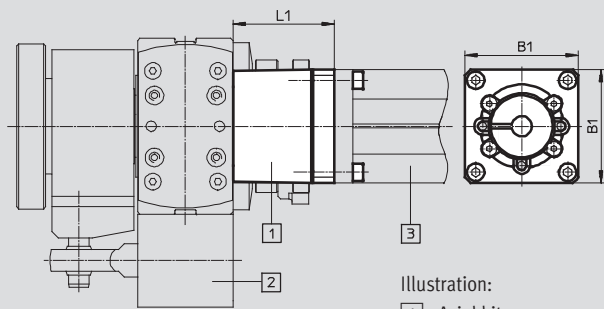

Illustration:

- 1 Axial kit
- 2 Rotary/lifting module
- 3 Motor



Type	B1	L1
EAMM-A-D19-28A	31	46.2
EAMM-A-D19-40A	40	42.7
EAMM-A-D19-42A	42	50
EAMM-A-D32-32B	45	43
EAMM-A-D32-35A-40A	40	46
EAMM-A-D32-40A	45	39.8
EAMM-A-D32-42A	45	48
EAMM-A-D32-55A	45	49.2
EAMM-A-D32-57A	45	50.5

Axial kits EAMM-A

Technical data

FESTO

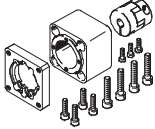

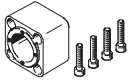
Type	B1	L1
EAMM-A-D40-40G	53.5	55.5
EAMM-A-D40-42B	53.5	88
EAMM-A-D40-42C	53.5	101
EAMM-A-D40-55A	53.5	49.2
EAMM-A-D40-57A	53.5	50.5
EAMM-A-D40-70A	53.5	52
EAMM-A-D40-87A	53.5	54
EAMM-A-D60-52B	74	112
EAMM-A-D60-52C	74	126
EAMM-A-D60-60G	74	71.4
EAMM-A-D60-70A	74	63.2
EAMM-A-D60-87A	74	64.7
EAMM-A-D60-100A	74	78.2
EAMM-A-D80-100A	100	92
EAMM-A-D80-140A	140.5	102
EAMM-A-D100-140A	140.5	109.5

Component parts			
Axial kit	Comprising:		
	Motor flange	Coupling	Coupling housing
			
Part No. Type	Part No. Type	Part No. Type	Part No. Type
1081659 EAMM-A-D19-28A	1087613 EAMF-A-28D-28A	562676 EAMC-16-20-5-5	1087585 EAMK-A-D19-28D
1199152 EAMM-A-D19-40A	1199144 EAMF-A-28D-40A	543419 EAMC-16-20-5-6	1087585 EAMK-A-D19-28D
1087642 EAMM-A-D19-42A	1087630 EAMF-A-28D-42A	562676 EAMC-16-20-5-5	1087585 EAMK-A-D19-28D
543149 EAMM-A-D32-32B	–	543420 EAMC-16-20-6-6	552156 EAMK-A-D32-32B
560281 EAMM-A-D32-35A-40A	–	558312 EAMC-30-32-6-6	560280 EAMK-A-D32-35-40A
543147 EAMM-A-D32-40A	552163 EAMF-A-28B-40A	543420 EAMC-16-20-6-6	552155 EAMK-A-D32-28B
543148 EAMM-A-D32-42A	552164 EAMF-A-28B-42A	543419 EAMC-16-20-5-6	552155 EAMK-A-D32-28B
550979 EAMM-A-D32-55A	529942 EAMF-A-44A/B-55A	551003 EAMC-30-32-6-9	551006 EAMK-A-D32-44A
550980 EAMM-A-D32-57A	530081 EAMF-A-44A/B-57A	551002 EAMC-30-32-6-6.35	551006 EAMK-A-D32-44A
560282 EAMM-A-D40-40G	550986 EAMF-A-44A/B-40G	558029 EAMC-30-32-8-10	552157 EAMK-A-D40-44A

Axial kits EAMM-A

Technical data

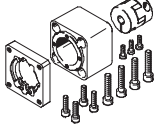
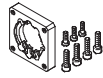
FESTO

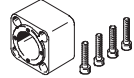
Component parts			
Axial kit	Comprising:		
	Motor flange	Coupling	Coupling housing
			
Part No. Type	Part No. Type	Part No. Type	Part No. Type
543155 EAMM-A-D40-42B	–	543422 EAMC-30-32-8-8	522158 EAMK-A-D40-42B
543156 EAMM-A-D40-42C	–	543422 EAMC-30-32-8-8	522159 EAMK-A-D40-42C
543153 EAMM-A-D40-55A	529942 EAMF-A-44A/B-55A	543423 EAMC-30-32-8-9	552157 EAMK-A-D40-44A
543154 EAMM-A-D40-57A	530081 EAMF-A-44A/B-57A	543421 EAMC-30-32-6.35-8	552157 EAMK-A-D40-44A
550981 EAMM-A-D40-70A	529943 EAMF-A-44A/B-70A	551004 EAMC-30-32-8-11	552157 EAMK-A-D40-44A
550982 EAMM-A-D40-87A	530082 EAMF-A-44A/B-87A	551004 EAMC-30-32-8-11	552157 EAMK-A-D40-44A
543163 EAMM-A-D60-52B	–	533709 EAMC-42-50-12-12	552161 EAMK-A-D60-52B
543164 EAMM-A-D60-52C	–	533709 EAMC-42-50-12-12	552162 EAMK-A-D60-52C
560283 EAMM-A-D60-60G	550987 EAMF-A-64A/B-60G	543424 EAMC-42-50-11-12	552160 EAMK-A-D60-64B
543161 EAMM-A-D60-70A	529945 EAMF-A-64A/B-70A	543424 EAMC-42-50-11-12	552160 EAMK-A-D60-64B
543162 EAMM-A-D60-87A	533140 EAMF-A-64A/B-87A	543424 EAMC-42-50-11-12	552160 EAMK-A-D60-64B
550983 EAMM-A-D60-100A	529947 EAMF-A-64A/C/D-100A	551005 EAMC-42-50-12-19	551007 EAMK-A-D60-64C
560283 EAMM-A-D60-60G	550987 EAMF-A-64A/B-60G	543424 EAMC-42-50-11-12	552160 EAMK-A-D60-64B
1589665 EAMM-A-D80-100A	1593628 EAMF-A-77A-100A	1485673 EAMC-56-58-19-19	1593627 EAMK-A-D80-77A
1588299 EAMM-A-D80-140A	1593636 EAMF-A-77A-140A	1485674 EAMC-56-58-19-24	1593627 EAMK-A-D80-77A
1588349 EAMM-A-D100-140A	1593636 EAMF-A-77A-140A	1451407 EAMC-67-62-24-24	1593914 EAMK-A-D100-77A/B

Axial kits EAMM-A

Technical data

Dimensions and ordering data

Download CAD Data → www.festo.com/us/cad

DNCE-... with protection class IP65

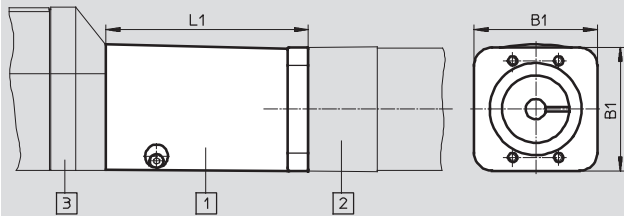

ESBF-... with protection class IP65

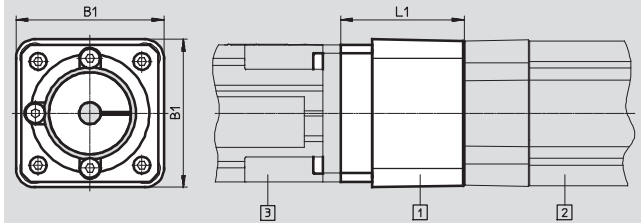

Illustration:



- 1 Axial kit
- 2 Electric cylinder
- 3 Motor

Type	B1	L1
EAMM-A-D32A-40A-S1	45	41.3
EAMM-A-D32A-42A-S1	45	49.5
EAMM-A-D32A-55A-S1	45	50.2
EAMM-A-D32A-57A-S1	45	51.5
EAMM-A-D40A-55A-S1	53.5	50.2
EAMM-A-D40A-57A-S1	53.5	51.5
EAMM-A-D40A-70A-S1	53.5	53
EAMM-A-D40A-87A-S1	53.5	55
EAMM-A-D60A-70A-S1	74	64.2
EAMM-A-D60A-87A-S1	74	65.7
EAMM-A-D60A-100A-S1	74	79.2
EAMM-A-D60B-70A-S1	74	64.7
EAMM-A-D60B-100A-S1	74	79.7
EAMM-A-D80B-100A-S1	100	93.5
EAMM-A-D80B-140A-S1	140.5	103.5
EAMM-A-D100B-140A-S1	140.5	111

Axial kits EAMM-A

Technical data

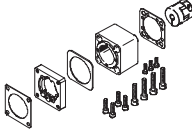
FESTO

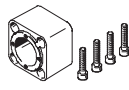
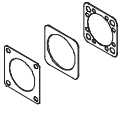
Component parts				
Axial kit	Comprising:			
	Motor flange	Coupling	Coupling housing	Seal set
				
Part No. Type	Part No. Type	Part No. Type	Part No. Type	Part No. Type
1322178 EAMM-A-D32A-40A-S1	552163 EAMF-A-28B-40A	543420 EAMC-16-20-6-6	552155 EAMK-A-D32-28B	1561526 EADS-F-D32A-40A
1322179 EAMM-A-D32A-42A-S1	552164 EAMF-A-28B-42A	543419 EAMC-16-20-5-6	552155 EAMK-A-D32-28B	1561527 EADS-F-D32A-42A
1322180 EAMM-A-D32A-55A-S1	529942 EAMF-A-44A/B-55A	551003 EAMC-30-32-6-9	551006 EAMK-A-D32-44A	1561528 EADS-F-D32A-55A
1322181 EAMM-A-D32A-57A-S1	530081 EAMF-A-44A/B-57A	551002 EAMC-30-32-6-6.35	551006 EAMK-A-D32-44A	1561529 EADS-F-D32A-57A
1322182 EAMM-A-D40A-55A-S1	529942 EAMF-A-44A/B-55A	543423 EAMC-30-32-8-9	552157 EAMK-A-D40-44A	1561530 EADS-F-D40A-55A
1322183 EAMM-A-D40A-57A-S1	530081 EAMF-A-44A/B-57A	543421 EAMC-30-32-6.35-8	552157 EAMK-A-D40-44A	1561531 EADS-F-D40A-57A
1322185 EAMM-A-D40A-70A-S1	529943 EAMF-A-44A/B-70A	551004 EAMC-30-32-8-11	552157 EAMK-A-D40-44A	1561532 EADS-F-D40A-70A
1322186 EAMM-A-D40A-87A-S1	530082 EAMF-A-44A/B-87A	551004 EAMC-30-32-8-11	552157 EAMK-A-D40-44A	1561533 EADS-F-D40A-87A
1322187 EAMM-A-D60A-70A-S1	529945 EAMF-A-64A/B-70A	543424 EAMC-42-50-11-12	552160 EAMK-A-D60-64B	1561534 EADS-F-D60A-70A
1322188 EAMM-A-D60A-87A-S1	530082 EAMF-A-44A/B-87A	543424 EAMC-42-50-11-12	552160 EAMK-A-D60-64B	1561536 EADS-F-D60A-87A
1322190 EAMM-A-D60A-100A-S1	529947 EAMF-A-64A/C/D-100A	551005 EAMC-42-50-12-19	551007 EAMK-A-D60-64C	1561537 EADS-F-D60A-100A
1679566 EAMM-A-D60B-70A-S1	529945 EAMF-A-64A/B-70A	543424 EAMC-42-50-11-12	552160 EAMK-A-D60-64B	1679570 EADS-F-D60B-70A
1679518 EAMM-A-D60B-100A-S1	529947 EAMF-A-64A/C/D-100A	551005 EAMC-42-50-12-19	551007 EAMK-A-D60-64C	1679522 EADS-F-D60B-100A
1600673 EAMM-A-D80B-100A-S1	1593628 EAMF-A-77A-100A	1485673 EAMC-56-58-19-19	1593627 EAMK-A-D80-77A	1593617 EADS-F-D80B-100A
1600674 EAMM-A-D80B-140A-S1	1593636 EAMF-A-77A-140A	1485674 EAMC-56-58-19-24	1593627 EAMK-A-D80-77A	1593671 EADS-F-D80B-140A
1600675 EAMM-A-D100B-140A-S1	1593636 EAMF-A-77A-140A	1451407 EAMC-67-62-24-24	1593914 EAMK-A-D100-77A/B	1593991 EADS-F-D100B-140A

Axial kits EAMM-A

Technical data

FESTO

Dimensions and ordering data

Download CAD Data → www.festo.com/us/cad

EGC-TB-...

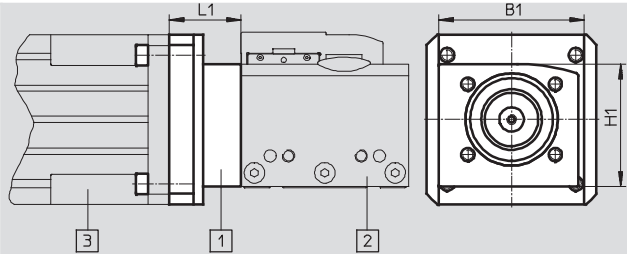

Illustration:

- 1 Axial kit
- 2 Toothed belt axis
- 3 Motor





Type	B1	H1	L1
EAMM-A-L27-55A	-	-	23.1
EAMM-A-L27-57A			23.1
EAMM-A-L27-40G			29.2
EAMM-A-L38-57A	57.5	50.3	26.7
EAMM-A-L38-70A			29.5
EAMM-A-L38-87A			33.7
EAMM-A-L38-60G			41.7
EAMM-A-L48-70A			40.2
EAMM-A-L48-87A	65	61	44
EAMM-A-L48-100A			59
EAMM-A-L48-60G			52.5
EAMM-A-L62-100A			62.5
EAMM-A-L62-140A	100	90.5	72.5
EAMM-A-L62-80G			62.5
EAMM-A-L95-140A			76
EAMM-A-L95-190A	140	142.5	86
EAMM-A-L95-120G			81

Component parts

Axial kit	Comprising:			
	Motor flange	Coupling	Coupling housing	Screw set
Part No. Type	Part No. Type	Part No. Type	Part No. Type	Part No. Type
557975 EAMM-A-L27-55A	558016 EAMF-A-27-55A	557999 EAMD-19-15-9-8X10	-	-
560678 EAMM-A-L27-57A	560690 EAMF-A-27-57A	561292 EAMD-16-15-6,35-8X10	-	-
557974 EAMM-A-L27-40G	558015 EAMF-A-27-40G	557998 EAMD-19-15-10-8X10	-	-
560679 EAMM-A-L38-57A	560692 EAMF-A-38A-57A	561293 EAMD-25-22-6,35-10X12	558011 EAMK-A-L38-38A	567484 EAHM-L2-M5-30
557979 EAMM-A-L38-70A	558018 EAMF-A-38A-70A	558000 EAMD-25-22-11-10X12	558011 EAMK-A-L38-38A	567484 EAHM-L2-M5-30
560680 EAMM-A-L38-87A	560693 EAMF-A-38A-87A	558000 EAMD-25-22-11-10X12	558011 EAMK-A-L38-38A	567485 EAHM-L2-M5-35
557978 EAMM-A-L38-60G	558017 EAMF-A-38A-60G	558000 EAMD-25-22-11-10X12	558011 EAMK-A-L38-38A	567485 EAHM-L2-M5-35
557982 EAMM-A-L48-70A	558025 EAMF-A-48A-70A	558001 EAMD-32-32-11-16X20	558012 EAMK-A-L48-48A	567486 EAHM-L2-M5-40
560683 EAMM-A-L48-87A	560695 EAMF-A-48A-87A	558001 EAMD-32-32-11-16X20	558012 EAMK-A-L48-48A	567487 EAHM-L2-M5-45
557984 EAMM-A-L48-100A	558020 EAMF-A-48A-100A	558002 EAMD-42-40-19-16X25	558012 EAMK-A-L48-48A	567489 EAHM-L2-M5-55
557983 EAMM-A-L48-60G	558019 EAMF-A-48A-60G	558001 EAMD-32-32-11-16X20	558012 EAMK-A-L48-48A	567486 EAHM-L2-M5-40

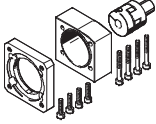
Axial kits EAMM-A

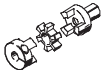
Technical data

Component parts				
Axial kit	Comprising:			
	Motor flange	Coupling	Coupling housing	Screw set
				
Part No. Type	Part No. Type	Part No. Type	Part No. Type	Part No. Type
557988 EAMM-A-L62-100A	558026 EAMF-A-62A-100A	558003 EAMD-56-46-19-23X27	558013 EAMK-A-L62-62A	567491 EAHM-L2-M6-65
557990 EAMM-A-L62-140A	558022 EAMF-A-62A-140A	558005 EAMD-56-46-24-23X27	558013 EAMK-A-L62-62A	567493 EAHM-L2-M6-70
557989 EAMM-A-L62-80G	558021 EAMF-A-62A-80G	558004 EAMD-56-46-20-23X27	558013 EAMK-A-L62-62A	567492 EAHM-L2-M6-65-L
557994 EAMM-A-L95-140A	558023 EAMF-A-95A-140A	558008 EAMD-67-51-24-32X32	558014 EAMK-A-L95-95A	567497 EAHM-L2-M8-80
1378474 EAMM-A-L95-190A	1378473 EAMF-A-95A-190A	1379269 EAMD-67-51-32-32X32	558014 EAMK-A-L95-95A	567497 EAHM-L2-M8-80
557995 EAMM-A-L95-120G	558024 EAMF-A-95A-120G	558006 EAMD-67-51-25-32X32	558014 EAMK-A-L95-95A	567496 EAHM-L2-M8-70

Axial kits EAMM-A

Technical data

FESTO

Dimensions and ordering data

Download CAD Data → www.festo.com/us/cad

EGC-BS-...

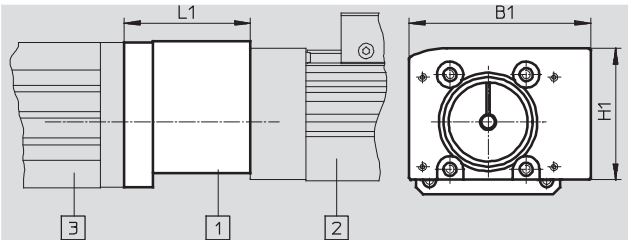

Illustration:

- 1 Axial kit
- 2 Spindle axis
- 3 Motor

Type	B1	H1	L1
EAMM-A-S38-40A	69	50	44
EAMM-A-S38-42A			52
EAMM-A-S38-55A			48
EAMM-A-S38-57A	82	61.5	48
EAMM-A-S48-55A			47.2
EAMM-A-S48-57A			47.2
EAMM-A-S48-70A			50.2
EAMM-A-S48-87A	120	88.5	54
EAMM-A-S62-70A			78.5
EAMM-A-S62-87A			81.5
EAMM-A-S62-100A			81
EAMM-A-S62-140A	186	140.5	91
EAMM-A-S95-100A			85.5
EAMM-A-S95-140A			95.5

Component parts

Axial kit	Comprising:			
	Motor flange	Coupling	Coupling housing	Screw set
Part No. Type	Part No. Type	Part No. Type	Part No. Type	Part No. Type
558162 EAMM-A-S38-40A	558175 EAMF-A-38B-40A	558312 EAMC-30-32-6-6	558171 EAMK-A-S38-38A/B	-
560685 EAMM-A-S38-42A	560691 EAMF-A-38B-42A	561333 EAMC-30-32-5-6	558171 EAMK-A-S38-38A/B	-
558163 EAMM-A-S38-55A	558176 EAMF-A-38A-55A	551003 EAMC-30-32-6-9	558171 EAMK-A-S38-38A/B	567488 EAHM-L2-M5-50
560686 EAMM-A-S38-57A	560692 EAMF-A-38A-57A	551002 EAMC-30-32-6-6.35	558171 EAMK-A-S38-38A/B	567488 EAHM-L2-M5-50
558164 EAMM-A-S48-55A	558177 EAMF-A-48B-55A	543423 EAMC-30-32-8-9	558172 EAMK-A-S48-48A/B	-
560687 EAMM-A-S48-57A	560694 EAMF-A-48B-57A	543421 EAMC-30-32-6.35-8	558172 EAMK-A-S48-48A/B	-
558165 EAMM-A-S48-70A	558025 EAMF-A-48A-70A	551004 EAMC-30-32-8-11	558172 EAMK-A-S48-48A/B	567488 EAHM-L2-M5-50
560688 EAMM-A-S48-87A	560695 EAMF-A-48A-87A	551004 EAMC-30-32-8-11	558172 EAMK-A-S48-48A/B	567489 EAHM-L2-M5-55
558166 EAMM-A-S62-70A	558179 EAMF-A-62B-70A	558313 EAMC-42-66-11-12	558173 EAMK-A-S62-62A/B	-
560689 EAMM-A-S62-87A	560696 EAMF-A-62B-87A	558313 EAMC-42-66-11-12	558173 EAMK-A-S62-62A/B	-
558167 EAMM-A-S62-100A	558026 EAMF-A-62A-100A	551005 EAMC-42-50-12-19	558173 EAMK-A-S62-62A/B	567494 EAHM-L2-M6-80
558168 EAMM-A-S62-140A	558022 EAMF-A-62A-140A	558314 EAMC-42-50-12-24	558173 EAMK-A-S62-62A/B	567495 EAHM-L2-M6-90
558169 EAMM-A-S95-100A	558182 EAMF-A-95B-100A	558315 EAMC-56-58-19-25	558174 EAMK-A-S95-95A/B	-
558170 EAMM-A-S95-140A	558023 EAMF-A-95A-140A	558316 EAMC-56-58-24-25	558174 EAMK-A-S95-95A/B	567498 EAHM-L2-M8-100

Axial kits EAMM-A

Technical data

FESTO

Dimensions and ordering data

Download CAD Data → www.festo.com/us/cad

ELGA-...

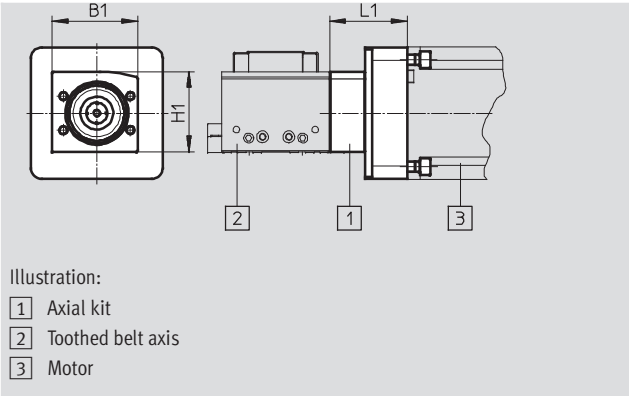

Type	B1	H1	L1
EAMM-A-N38-70A	57.5	50.3	37.5
EAMM-A-N38-60G			49.5
EAMM-A-N48-100A	65	61	59
EAMM-A-N48-80G			59.1
EAMM-A-N80-140A	100	90.5	72.5
EAMM-A-N80-120G			77.5

Component parts

Axial kit				
Comprising:				
	Motor flange	Coupling	Coupling housing	Screw set
Part No. Type	Part No. Type	Part No. Type	Part No. Type	Part No. Type
1202331 EAMM-A-N38-70A	1202337 EAMF-A-38D-70A	558001 EAMD-32-32-11-16X20	1345947 EAMK-A-N38-38D	1202288 EAHM-L5-M6-35
1202253 EAMM-A-N38-60G	1190015 EAMF-A-38D-60G	558001 EAMD-32-32-11-16X20	1345947 EAMK-A-N38-38D	1202262 EAHM-L5-M6-40
1201894 EAMM-A-N48-100A	1201924 EAMF-A-48C-100A	558002 EAMD-42-40-19-16X25	1345949 EAMK-A-N48-48C	1201874 EAHM-L5-M6-50
1258793 EAMM-A-N48-80G	1190375 EAMF-A-48C-80G	1188350 EAMD-42-40-20-16X25	1345949 EAMK-A-N48-48C	1201874 EAHM-L5-M6-50
1201691 EAMM-A-N80-140A	1190796 EAMF-A-80A-140A	558005 EAMD-56-46-24-23X27	1345953 EAMK-A-N80-80A	1201751 EAHM-L5-M8-75
1201695 EAMM-A-N80-120G	1190702 EAMF-A-80A-120G	1188801 EAMD-56-46-25-23X27	1345953 EAMK-A-N80-80A	1201712 EAHM-L5-M8-60

Axial kits EAMM-A

Technical data

Dimensions and ordering data

Download CAD Data → www.festo.com/us/cad

EGC-HD-TB-...

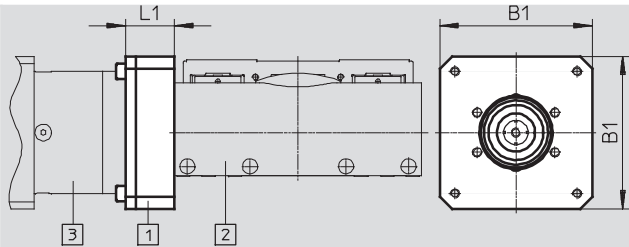

Illustration:

- 1 Axial kit
- 2 Toothed belt axis
- 3 Motor

Type	B1	L1
EAMM-A-M43-60G	60	33
EAMM-A-M48-80G	100	32
EAMM-A-M80-120G	124	34

Component parts

Axial kit	Comprising:		
	Motor flange	Coupling	Centring ring
Part No. Type	Part No. Type	Part No. Type	Part No. Type
1190076 EAMM-A-M43-60G	1597579 EAMF-A-43D-60G	558001 EAMD-32-32-11-16X20	575962 EAML-43-4-43
1190421 EAMM-A-M48-80G	1190375 EAMF-A-48C-80G	1781043 EAMD-42-40-20-16X25-U	558031 EAML-48-4-48
1190774 EAMM-A-M80-120G	1190702 EAMF-A-80A-120G	1781045 EAMD-56-46-25-23X27-U	1209006 EAML-80-6-80

Axial kits EAMM-A

Technical data

FESTO

Dimensions and ordering data

Download CAD Data → www.festo.com/us/cad

EGC-HD-BS-...

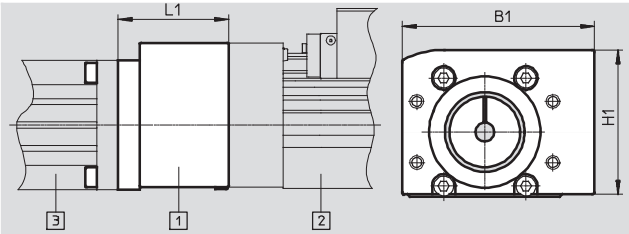

Illustration:

- 1 Axial kit
- 2 Spindle axis
- 3 Motor

Type	B1	H1	L1
EAMM-A-S38-40A	69	50	44
EAMM-A-S38-42A			52
EAMM-A-S38-55A			48
EAMM-A-S38-57A			48
EAMM-A-S48-55A	82	61.5	47.2
EAMM-A-S48-57A			47.2
EAMM-A-S48-70A			50.2
EAMM-A-S48-87A			54
EAMM-A-S62-70A	120	88.5	78.5
EAMM-A-S62-87A			81.5
EAMM-A-S62-100A			81
EAMM-A-S62-140A			91

Component parts

Axial kit	Comprising:			
	Motor flange	Coupling	Coupling housing	Screw set
Part No. Type	Part No. Type	Part No. Type	Part No. Type	Part No. Type
558162 EAMM-A-S38-40A	558175 EAMF-A-38B-40A	558312 EAMC-30-32-6-6	558171 EAMK-A-S38-38A/B	–
558163 EAMM-A-S38-55A	558176 EAMF-A-38A-55A	551003 EAMC-30-32-6-9	558171 EAMK-A-S38-38A/B	567488 EAHM-L2-M5-50
560685 EAMM-A-S38-42A	560691 EAMF-A-38B-42A	561333 EAMC-30-32-5-6	558171 EAMK-A-S38-38A/B	–
560686 EAMM-A-S38-57A	560692 EAMF-A-38A-57A	551002 EAMC-30-32-6-6.35	558171 EAMK-A-S38-38A/B	567488 EAHM-L2-M5-50
558164 EAMM-A-S48-55A	558177 EAMF-A-48B-55A	543423 EAMC-30-32-8-9	558172 EAMK-A-S48-48A/B	–
558165 EAMM-A-S48-70A	558025 EAMF-A-48A-70A	551004 EAMC-30-32-8-11	558172 EAMK-A-S48-48A/B	567488 EAHM-L2-M5-50
560687 EAMM-A-S48-57A	560694 EAMF-A-48B-57A	543421 EAMC-30-32-6.35-8	558172 EAMK-A-S48-48A/B	–
560688 EAMM-A-S48-87A	560695 EAMF-A-48A-87A	551004 EAMC-30-32-8-11	558172 EAMK-A-S48-48A/B	567489 EAHM-L2-M5-55
558166 EAMM-A-S62-70A	558179 EAMF-A-62B-70A	558313 EAMC-42-66-11-12	558173 EAMK-A-S62-62A/B	–
558167 EAMM-A-S62-100A	558026 EAMF-A-62A-100A	551005 EAMC-42-50-12-19	558173 EAMK-A-S62-62A/B	567494 EAHM-L2-M6-80
558168 EAMM-A-S62-140A	558022 EAMF-A-62A-140A	558314 EAMC-42-50-12-24	558173 EAMK-A-S62-62A/B	567495 EAHM-L2-M6-90
560689 EAMM-A-S62-87A	560696 EAMF-A-62B-87A	558313 EAMC-42-66-11-12	558173 EAMK-A-S62-62A/B	–

Axial kits EAMM-A

Technical data

FESTO

Dimensions and ordering data

Download CAD Data → www.festo.com/us/cad

EGSK-..., EGSP-...

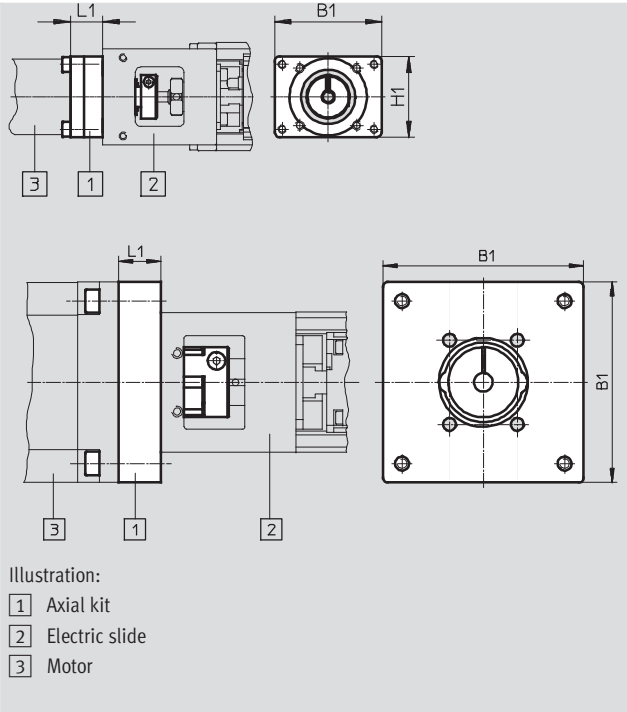

Type	B1	H1	L1
EAMM-A-P3-28D-28A	30	–	15
EAMM-A-P4-28B-28A	39.6	30	12
EAMM-A-P4-28B-40A	40	–	8.3
EAMM-A-P5-28B-28A	39.6	30	12
EAMM-A-P5-28B-40A	40	–	8.3
EAMM-A-P4-28B-42A	42	–	16.5
EAMM-A-P5-28B-42A			
EAMM-A-P6-38A-40A	50	–	9
EAMM-A-P8-38A-40A			
EAMM-A-P6-38A-42A	55	–	15
EAMM-A-P8-38A-42A			
EAMM-A-P6-38A-55A	55	–	11
EAMM-A-P8-38A-55A			
EAMM-A-P10-38A-55A	56	–	11
EAMM-A-P6-38A-57A			
EAMM-A-P8-38A-57A	70	–	13.75
EAMM-A-P10-38A-70A			
EAMM-A-P8-38A-87A	85.8	–	18
EAMM-A-P10-38A-87A			

Component parts

Axial kit	Comprising:	
	Motor flange	Coupling
Part No. Type	Part No. Type	Part No. Type
1703478 EAMM-A-P3-28D-28A	1087613 EAMF-A-28D-28A	562672 EAMC-16-20-3-5
1731466 EAMM-A-P4-28B-28A	1704476 EAMF-A-28B-28A	562674 EAMC-16-20-4-5
562637 EAMM-A-P4-28B-40A	552163 EAMF-A-28B-40A	562673 EAMC-16-20-4-6
562636 EAMM-A-P4-28B-42A	552164 EAMF-A-28B-42A	562674 EAMC-16-20-4-5
1731474 EAMM-A-P5-28B-28A	1704476 EAMF-A-28B-28A	562676 EAMC-16-20-5-5
562641 EAMM-A-P5-28B-40A	552163 EAMF-A-28B-40A	543419 EAMC-16-20-5-6
562640 EAMM-A-P5-28B-42A	552164 EAMF-A-28B-42A	562676 EAMC-16-20-5-5
562646 EAMM-A-P6-38A-40A	562667 EAMF-A-38A-40A	558312 EAMC-30-32-6-6
562644 EAMM-A-P6-38A-42A	562668 EAMF-A-38A-42A	561333 EAMC-30-32-5-6
562647 EAMM-A-P6-38A-55A	558176 EAMF-A-38A-55A	551003 EAMC-30-32-6-9
562645 EAMM-A-P6-38A-57A	560692 EAMF-A-38A-57A	551002 EAMC-30-32-6-6.35

Axial kits EAMM-A

Technical data

FESTO

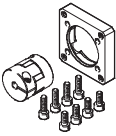
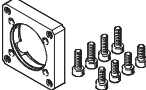
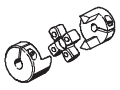
Component parts		
Axial kit	Comprising:	
	Motor flange	Coupling
		
Part No. Type	Part No. Type	Part No. Type
562652 EAMM-A-P8-38A-40A	562667 EAMF-A-38A-40A	533708 EAMC-30-32-6-8
562650 EAMM-A-P8-38A-42A	562668 EAMF-A-38A-42A	562678 EAMC-30-32-5-8
562653 EAMM-A-P8-38A-55A	558176 EAMF-A-38A-55A	543423 EAMC-30-32-8-9
562651 EAMM-A-P8-38A-57A	560692 EAMF-A-38A-57A	543421 EAMC-30-32-6.35-8
564996 EAMM-A-P8-38A-70A	558018 EAMF-A-38A-70A	551004 EAMC-30-32-8-11
564998 EAMM-A-P8-38A-87A	560693 EAMF-A-38A-87A	551004 EAMC-30-32-8-11
562659 EAMM-A-P10-38A-55A	558176 EAMF-A-38A-55A	562680 EAMC-30-32-9-10
562658 EAMM-A-P10-38A-57A	560692 EAMF-A-38A-57A	562679 EAMC-30-32-6.35-10
564997 EAMM-A-P10-38A-70A	558018 EAMF-A-38A-70A	565008 EAMC-30-32-10-11
564999 EAMM-A-P10-38A-87A	560693 EAMF-A-38A-87A	565008 EAMC-30-32-10-11

Axial kits EAMM-A

Technical data

FESTO

Dimensions and ordering data

Download CAD Data → www.festo.com/us/cad

ELGR-...

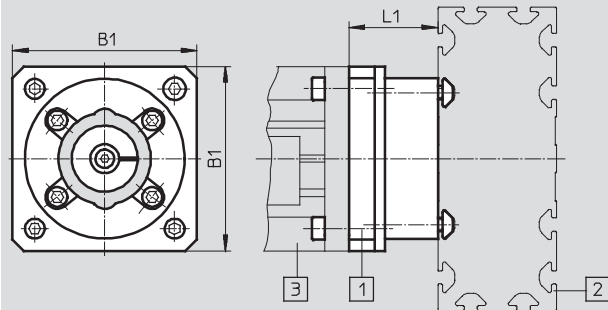

Illustration:

- 1 Axial kit
- 2 Toothed belt axis
- 3 Motor

ELGG-...

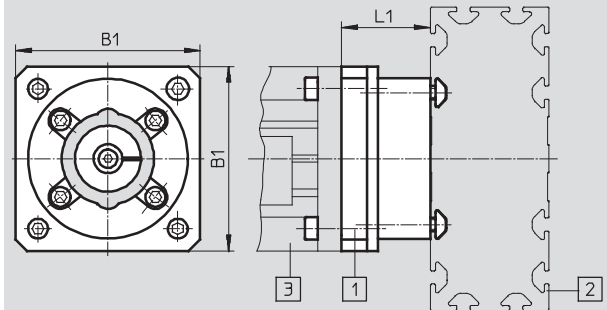

Illustration:

- 1 Axial kit
- 2 Toothed belt axis
- 3 Motor

Type	B1	L1
EAMM-A-R27-55A	55	26
EAMM-A-R27-57A	56	26
EAMM-A-R38-57A	56	31
EAMM-A-R38-70A	70	33.75
EAMM-A-R38-87A	85.8	38
EAMM-A-R48-70A	70	40.2
EAMM-A-R48-87A	85.8	44
EAMM-A-R48-100A	100.5	59

Component parts

Axial kit	Comprising:		
	Motor flange	Coupling	Coupling housing
Part No. Type	Part No. Type	Part No. Type	Part No. Type
1133400 EAMM-A-R27-55A	558176 EAMF-A-38A-55A	557999 EAMD-19-15-9-8X10	1133397 EAMK-A-R27-38A
1133403 EAMM-A-R27-57A	560692 EAMF-A-38A-57A	561292 EAMD-16-15-6.35-8X10	1133397 EAMK-A-R27-38A
1578138 EAMM-A-R38-57A	560692 EAMF-A-38A-57A	561293 EAMD-25-22-6.35-10X12	1133398
1133401 EAMM-A-R38-70A	558018 EAMF-A-38A-70A	558000 EAMD-25-22-11-10X12	1133398 EAMK-A-R38-38A
1133404 EAMM-A-R38-87A	560693 EAMF-A-38A-87A	558000 EAMD-25-22-11-10X12	1133398 EAMK-A-R38-38A
1578139 EAMM-A-R48-70A	558025 EAMF-A-48A-70A	558001 EAMD-32-32-11-16X20	1133399 EAMK-A-R48-48A
1133405 EAMM-A-R48-87A	560695 EAMF-A-48A-87A	558001 EAMD-32-32-11-16X20	1133399 EAMK-A-R48-48A
1133402 EAMM-A-R48-100A	558020 EAMF-A-48A-100A	558002 EAMD-42-40-19-16X25	1133399 EAMK-A-R48-48A

- 1 - Type discontinued EGSA
Available up until 2013

Axial kits EAMM-A

Technical data

FESTO

Dimensions and ordering data

Download CAD Data → www.festo.com/us/cad

EGSA-...

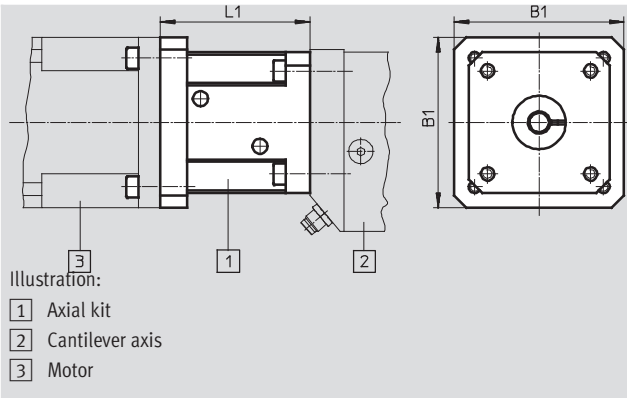

Type	B1	L1
EAMM-A-A19-40A	49	49
EAMM-A-A19-42A	49	55.5
EAMM-A-A22-55A	58	59
EAMM-A-A22-57A	58	59
EAMM-A-A22-70A	70	61.5

Component parts

Axial kit	Comprising:		
	Motor flange	Coupling	Coupling housing
Part No. Type	Part No. Type	Part No. Type	Part No. Type
559798 EAMM-A-A19-40A	558904 EAMF-A-28C-40A	558901 EAMC-20-30-6-6	559801 EAMK-A-A19-28C
558895 EAMM-A-A19-42A	558905 EAMF-A-28C-42A	558902 EAMC-20-30-5-6	559801 EAMK-A-A19-28C
559799 EAMM-A-A22-55A	559800 EAMF-A-38C-55A	557390 EAMC-30-35-8-9	559802 EAMK-A-A22-38C
558897 EAMM-A-A22-57A	558907 EAMF-A-38C-57A	530088 EAMC-30-35-6.35-8	559802 EAMK-A-A22-38C
558898 EAMM-A-A22-70A	558908 EAMF-A-38C-70A	123042 EAMC-30-35-8-11	559802 EAMK-A-A22-38C

Axial kits EAMM-A

Technical data

Dimensions and ordering data

Download CAD Data → www.festo.com/us/cad

DGEA-...

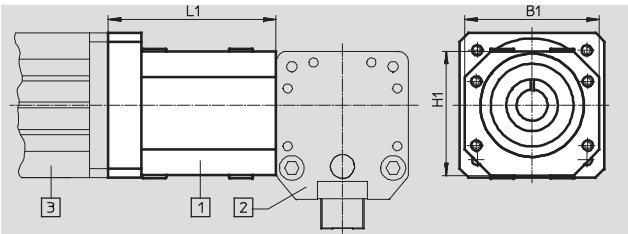

Illustration:

- 1 Axial kit
- 2 Cantilever axis
- 3 Motor

Type	B1	H1	L1
EAMM-A-F28-57A	45	45	52.7
EAMM-A-F28-87A			56.2
EAMM-A-F28-60G			60.7
EAMM-A-F32-87A	65	60	82.7
EAMM-A-F32-60G			89.4
EAMM-A-F40-80G			89.4

Component parts

Axial kit	Comprising:		
	Motor flange	Coupling	Coupling housing
Part No. Type	Part No. Type	Part No. Type	Part No. Type
550956 EAMM-A-F28-57A	530081 EAMF-A-44A/B-57A	530088 EAMC-30-35-6.35-8	530468 EAMK-A-F28-44A
550958 EAMM-A-F28-87A	530082 EAMF-A-44A/B-87A	123042 EAMC-30-35-8-11	530468 EAMK-A-F28-44A
550957 EAMM-A-F28-60G	529944 EAMF-A-44A/B-60G	123042 EAMC-30-35-8-11	530468 EAMK-A-F28-44A
550960 EAMM-A-F32-87A	533140 EAMF-A-64A/B-87A	530090 EAMC-40-66-11-11	530469 EAMK-A-F32-64A
550959 EAMM-A-F32-60G	550987 EAMF-A-64A/B-60G	530090 EAMC-40-66-11-11	530469 EAMK-A-F32-64A
550935 EAMM-A-F40-80G	533139 EAMF-A-64A/C-80G	123845 EAMC-40-66-15-20	124629 EAMK-A-F40-64A

Axial kits EAMM-A

Accessories

FESTO

Seal set

Contains PWIS (paint-wetting
impairment substances)

RoHS-compliant

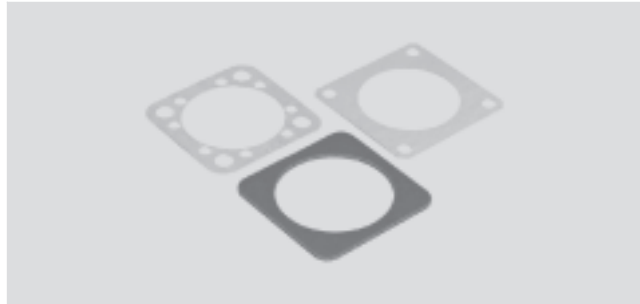

Ordering data						
Type	For axial kit	For electric cylinder	Ambient temperature [°C]	CRC ¹⁾	Part No.	Type
EADS-F-D32A-40A	EAMM-A-D32-40A	DNCE	-25 ... +60	4	1561526	EADS-F-D32A-40A
EADS-F-D32A-42A	EAMM-A-D32-42A	DNCE			1561527	EADS-F-D32A-42A
EADS-F-D32A-55A	EAMM-A-D32-55A	DNCE			1561528	EADS-F-D32A-55A
EADS-F-D32A-57A	EAMM-A-D32-57A	DNCE			1561529	EADS-F-D32A-57A
EADS-F-D40A-55A	EAMM-A-D40-55A	DNCE			1561530	EADS-F-D40A-55A
EADS-F-D40A-57A	EAMM-A-D40-57A	DNCE			1561531	EADS-F-D40A-57A
EADS-F-D40A-70A	EAMM-A-D40-70A	DNCE			1561532	EADS-F-D40A-70A
EADS-F-D40A-87A	EAMM-A-D40-87A	DNCE			1561533	EADS-F-D40A-87A
EADS-F-D60A-70A	EAMM-A-D60-70A	DNCE			1561534	EADS-F-D60A-70A
EADS-F-D60A-87A	EAMM-A-D60-87A	DNCE			1561536	EADS-F-D60A-87A
EADS-F-D60A-100A	EAMM-A-D60-100A	DNCE			1561537	EADS-F-D60A-100A
EADS-F-D60B-70A	EAMM-A-D60-70A	ESBF			1679570	EADS-F-D60B-70A
EADS-F-D60B-100A	EAMM-A-D60-100A	ESBF			1679522	EADS-F-D60B-100A
EADS-F-D80B-100A	EAMM-A-D80-100A	ESBF			1593617	EADS-F-D80B-100A
EADS-F-D80B-140A	EAMM-A-D80-140A	ESBF			1593671	EADS-F-D80B-140A
EADS-F-D100B-140A	EAMM-A-D100-140A	ESBF			1593991	EADS-F-D100B-140A

1) Corrosion resistance class 4 to Festo standard 940 070

Components subject to high corrosion stress. Parts used with aggressive media, e.g. in the food or chemical industry. These applications should be supported with special tests with the media if required.

Product Range and Company Overview

A Complete Suite of Automation Services

Our experienced engineers provide complete support at every stage of your development process, including: conceptualization, analysis, engineering, design, assembly, documentation, validation, and production.



Custom Automation Components
Complete custom engineered solutions



Custom Control Cabinets
Comprehensive engineering support and on-site services



Complete Systems
Shipment, stocking and storage services

The Broadest Range of Automation Components

With a comprehensive line of more than 30,000 automation components, Festo is capable of solving the most complex automation requirements.



Electromechanical
Electromechanical actuators, motors, controllers & drives



Pneumatics
Pneumatic linear and rotary actuators, valves, and air supply



PLCs and I/O Devices
PLC's, operator interfaces, sensors and I/O devices

Supporting Advanced Automation... As No One Else Can!

Festo is a leading global manufacturer of pneumatic and electromechanical systems, components and controls for industrial automation, with more than 12,000 employees in 56 national headquarters serving more than 180 countries. For more than 80 years, Festo has continuously elevated the state of manufacturing with innovations and optimized motion control solutions that deliver higher performing, more profitable automated manufacturing and processing equipment. Our dedication to the advancement of automation extends beyond technology to the education and development of current and future automation and robotics designers with simulation tools, teaching programs, and on-site services.

Quality Assurance, ISO 9001 and ISO 14001 Certifications

Festo Corporation is committed to supply all Festo products and services that will meet or exceed our customers' requirements in product quality, delivery, customer service and satisfaction.

To meet this commitment, we strive to ensure a consistent, integrated, and systematic approach to management that will meet or exceed the requirements of the ISO 9001 standard for Quality Management and the ISO 14001 standard for Environmental Management.



© Copyright 2008, Festo Corporation. While every effort is made to ensure that all dimensions and specifications are correct, Festo cannot guarantee that publications are completely free of any error, in particular typing or printing errors. Accordingly, Festo cannot be held responsible for the same. For Liability and Warranty conditions, refer to our "Terms and Conditions of Sale", available from your local Festo office. All rights reserved. No part of this publication may be reproduced, distributed, or transmitted in any form or by any means, electronic, mechanical, photocopying or otherwise, without the prior written permission of Festo. All technical data subject to change according to technical update.



Printed on recycled paper at New Horizon Graphic, Inc., FSC certified as an environmentally friendly printing plant.

Festo North America

Festo Regional Contact Center

5300 Explorer Drive
Mississauga, Ontario L4W 5G4
Canada

USA Customers:

For ordering assistance,

Call: 1.800.99.FESTO (1.800.993.3786)

Fax: 1.800.96.FESTO (1.800.963.3786)

Email: customer.service@us.festo.com

For technical support,

Call: 1.866.GO.FESTO (1.866.463.3786)

Fax: 1.800.96.FESTO (1.800.963.3786)

Email: product.support@us.festo.com

Canadian Customers:

Call: 1.877.GO.FESTO (1.877.463.3786)

Fax: 1.877.FX.FESTO (1.877.393.3786)

Email: festo.canada@ca.festo.com

USA Headquarters

Festo Corporation
395 Moreland Road
P.O. Box 18023
Hauppauge, NY 11788, USA
www.festo.com/us

USA Sales Offices

Appleton

North 922 Tower View Drive, Suite N
Greenville, WI 54942, USA

Boston

120 Presidential Way, Suite 330
Woburn, MA 01801, USA

Chicago

1441 East Business Center Drive
Mt. Prospect, IL 60056, USA

Dallas

1825 Lakeway Drive, Suite 600
Lewisville, TX 75057, USA

Detroit – Automotive Engineering Center

2601 Cambridge Court, Suite 320
Auburn Hills, MI 48326, USA

New York

395 Moreland Road
Hauppauge, NY 11788, USA

Silicon Valley

4935 Southfront Road, Suite F
Livermore, CA 94550, USA

United States



USA Headquarters, East: Festo Corp., 395 Moreland Road, Hauppauge, NY 11788

Phone: 1.631.435.0800; Fax: 1.631.435.8026;

Email: info@festo-usa.com

www.festo.com/us

Canada



Headquarters: Festo Inc., 5300 Explorer Drive, Mississauga, Ontario L4W 5G4

Phone: 1.905.624.9000; Fax: 1.905.624.9001;

Email: festo.canada@ca.festo.com

www.festo.ca

Mexico



Headquarters: Festo Pneumatic, S.A., Av. Ceylán 3, Col. Tequesquahuac,
54020 Tlalneantla, Edo. de México

Phone: 011 52 [55] 53 21 66 00; Fax: 011 52 [55] 53 21 66 65;

Email: festo.mexico@mx.festo.com

www.festo.com/mx

Central USA

Festo Corporation
1441 East Business
Center Drive
Mt. Prospect, IL 60056, USA
Phone: 1.847.759.2600
Fax: 1.847.768.9480



Western USA

Festo Corporation
4935 Southfront Road,
Suite F
Livermore, CA 94550, USA
Phone: 1.925.371.1099
Fax: 1.925.245.1286



Festo Worldwide

Argentina Australia Austria Belarus Belgium Brazil Bulgaria Canada Chile China Colombia Croatia Czech Republic Denmark
Estonia Finland France Germany Great Britain Greece Hong Kong Hungary India Indonesia Iran Ireland Israel Italy Japan Latvia
Lithuania Malaysia Mexico Netherlands New Zealand Norway Peru Philippines Poland Romania Russia Serbia Singapore
Slovakia Slovenia South Africa South Korea Spain Sweden Switzerland Taiwan Thailand Turkey Ukraine United States Venezuela

www.festo.com