

Electric cylinders DNCE, with spindle drive



Electric cylinders DNCE, with spindle drive

Key features

At a glance

General

The electric cylinder DNCE is a mechanical linear axis with piston rod. The drive component consists of an electrically driven spindle, which converts the rotary motion of the motor into the linear motion of the

piston rod.
The mechanical interfaces are largely compatible with the standard cylinder DNC.

Properties

- Choice of spindle type:
 - With lead screw (LS)
 - With ball screw (BS)
- Electric cylinder with lead screw spindle is self-retarding
- Compact dimensions
- Optional:
 - Protection class IP65
 - High corrosion protection
 - NSF-H1 lubricant for the food industry

Range of applications

- Lead screw spindle
 - For applications with slow feed speeds
- Ball screw spindle
 - For applications with high feed speeds and high running performance

Note

The electric cylinder is of limited suitability for the food industry. More information on suitability for use in

the food industry → Manufacturer's declaration.

Entire system consisting of electric cylinder, motor and motor mounting kit

Electric cylinder

→ 6

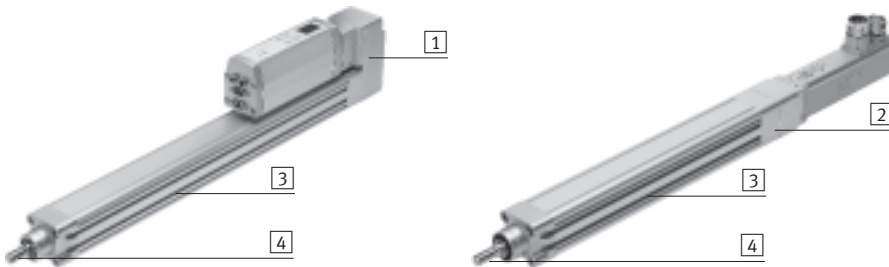

- 1** Parallel kit
- 2** Axial kit
- 3** Slot for proximity sensor
- 4** Choice of spindle type:
 - With lead screw spindle (LS)
 - With ball screw spindle (BS)

Note

The lead screw spindle is self-retarding, which means that slow movements cannot be excluded in the event of vibration. The entire system with intelligent motor unit MTR-DCI is self-locking.

Motor/motor unit

→ 18

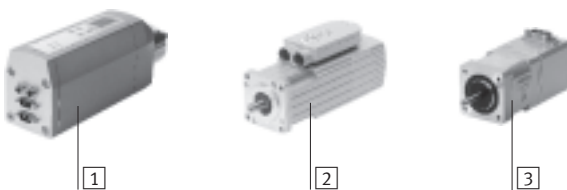

- 1** Motor unit MTR-DCI
- 2** Servo motor EMMS-AS
- 3** Stepper motor EMMS-ST

Note

A range of specially adapted complete solutions is available for the electric cylinder DNCE and the motors/motor units.

Motor mounting kit

→ 18

Axial kit

Parallel kit



A range of complete kits is available for both parallel and axial motor mounting.

Electric cylinders DNCE, with spindle drive

Key features and type codes

Longer service life with bellows kit EADB

→ 25



The protective bellows kit is a leak-free system. To prevent unwanted media from being drawn in, the supply and exhaust air must be ducted via a pressure compensation hole in the connection part **1**.

The kit protects the piston rod, seal and bearings against a wide variety of media, for example:

- Dust
- Chippings
- Oil
- Grease
- Fuel

Use in dusty or wet environments thanks to protection to IP65 (feature P5)

→ 17

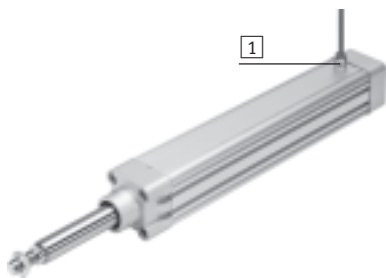

The electric cylinder to IP65 fulfils the specifications to IEC 60 529.

Air is exchanged between the interior of the cylinder and the environment via a pressure compensation hole **1** in the cylinder barrel. This prevents negative pressure or excess pressure in the interior of the cylinder.

It also prevents unwanted media being drawn in.

Protection to IP65 can only be selected in combination with DNCE...-BS (ball screw spindle).

Type codes

		DNCE	-	32	-	100	-	BS	-	"10" P	-	Q-P5
Type												
DNCE	Electric cylinder											
Size												
Stroke [mm]												
Drive function												
LS	Lead screw spindle											
BS	Ball screw spindle											
Spindle pitch [mm]												
Variant												
Q	Non-rotating piston rod											
K8	Extended piston rod											
K3	Female piston rod thread											
P5	Protection class IP65											
R3	High corrosion protection											
FG	Lubrication approved for use in food applications											

Electric cylinders DNCE, with spindle drive

Peripherals overview

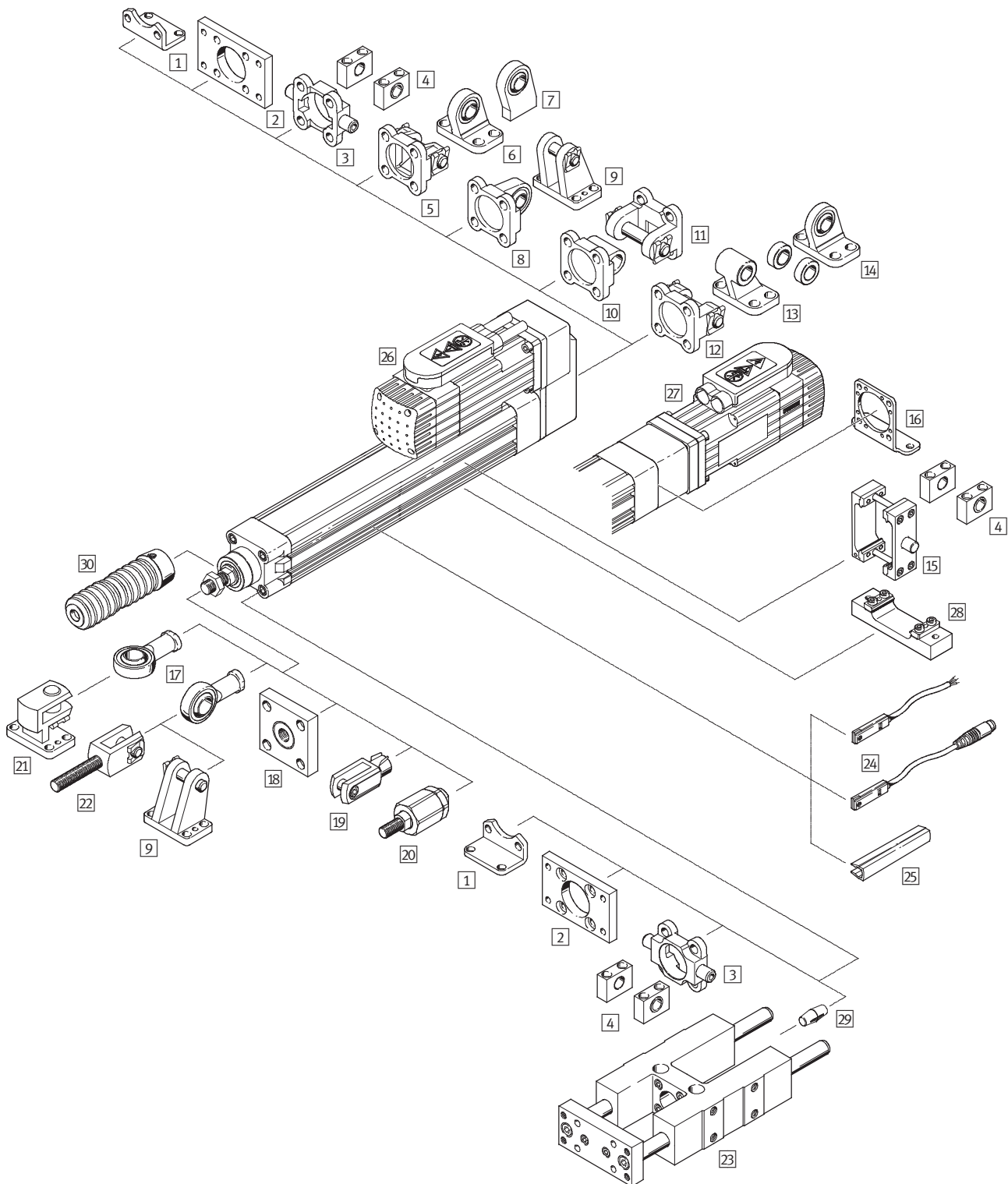

Mounting attachments and accessories		
	Brief description	→ Page/Internet
1	Foot mounting HNC/CRHNC	For mounting the cylinder 30
2	Flange mounting FNC/CRFNG	- Cannot be used on the bearing cap in combination with bellows kit EADB 31
3	Trunnion flange ZNCF/CRZNG	- Cannot be used on the bearing cap in combination with bellows kit EADB 32

Electric cylinders DNCE, with spindle drive

Peripherals overview

Mounting attachments and accessories		
	Brief description	→ Page/Internet
4	Trunnion support LNZG/CRLNZG	For cylinders with trunnion mounting 33
5	Swivel flange SNC	With parallel motor mounting 34
6	Clevis foot LSNG	With parallel motor mounting, with spherical bearing 37
7	Clevis foot LSNSG	With parallel motor mounting, weld-on, with spherical bearing 37
8	Swivel flange SNCS	With parallel motor mounting, with spherical bearing 34
9	Clevis foot LBG	With parallel motor mounting, with spherical bearing 37
10	Swivel flange SNCL	With parallel motor mounting 35
11	Swivel flange SNCB/SNCB-...-R3	With parallel motor mounting, with spherical bearing 36
12	Swivel flange SNCB/SNCB-...-R3	With parallel motor mounting 36
13	Clevis foot LNG/CRLNG	With parallel motor mounting 37
14	Clevis foot LSN	With parallel motor mounting, with spherical bearing 37
15	Trunnion mounting kit ZNCM	For mounting anywhere along the cylinder profile barrel. Cannot be mounted in the vicinity of the motor with parallel motor mounting 37
16	Foot mounting HNCE	– With axial motor mounting – Cannot be used in combination with the axial kit EAMM-A-...-S1 (protection class IP65) 28
17	Rod eye SGS/CRSGS	With spherical bearing 38
18	Coupling piece KSZ	To compensate for radial deviations 38
19	Rod clevis SG/CRSG	Permits a swivelling movement of the cylinder in one plane 38
20	Self-aligning rod coupler FK	For compensating radial and angular deviations 38
21	Right-angle clevis foot LQG	For rod eye SGS 38
22	Rod clevis SGA	For swivel mounting of cylinders 38
23	Guide unit FENG	– For protecting electric cylinders against rotation at high torque loads – Cannot be used in combination with bellows kit EADB 38
24	Proximity sensor SME/SMT-8	For position sensing. Can be integrated in the sensor slot, thus avoiding projecting parts 39
25	Slot cover ABP-5-S	For protecting against the ingress of dirt 39
26	Parallel kit EAMM-U	For parallel motor mounting 18
27	Axial kit EAMM-A	For axial motor mounting 18
28	Profile mounting EAHF	– For mounting the electric cylinder via the profile – Cannot be mounted in the vicinity of the motor in combination with the parallel kit EAMM-U 29
29	Compensating element EADC	Compensates the play between the piston rod of the electric cylinder DNCE and the yoke plate of the guide unit FENG 39
30	Bellows kit EADB	– Protects the cylinder (piston rod, seal and bearings) against a wide range of media and thus prevents premature wear – The kit can only be used in combination with an extended piston rod (K8) 25

Electric cylinders DNCE, with spindle drive

Technical data

Function

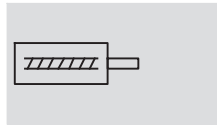

-N- Size
32 ... 63
-T- Stroke length
1 ... 800 mm
[www.festo.com/en/
Spare_parts_service](http://www.festo.com/en/Spare_parts_service)

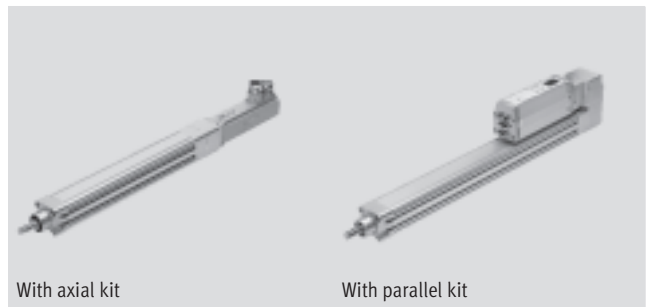

General technical data			
Size	32	40	63
Design	With lead screw spindle (LS) With ball screw spindle (BS)		
Piston rod thread			
Male thread	M10x1.25	M12x1.25	M16x1.5
Female thread	M6	M8	M10
Working stroke [mm]	1 ... 400	1 ... 600	1 ... 800
Variant	Non-rotating piston rod		
Protection against rotation/guide	Plain-bearing guide		
Stroke reserve [mm]	0		
Max. torsion angle of the piston rod [°]	±0.30	±0.25	±0.20
Impact energy (E) in the end positions [J]	0.0001 $E = 0.5 \times m \times v^2$	0.0002 $E = 0.5 \times m \times v^2$	0.0004 $E = 0.5 \times m \times v^2$
Duty cycle ¹⁾ [%]	100		
Position sensing	Via proximity sensor		
Type of mounting	Via female thread Via accessories		
Mounting position	Any		

1) In the case of the variant with lead screw spindle (LS), the duty cycle depends on the speed

Mechanical data									
Size	32			40			63		
Spindle design	LS-"1,5"P	BS-"3"P	BS-"10"P	LS-"2,5"P	BS-"5"P	BS-"12,7"P	LS-"4"P	BS-"10"P	BS-"20"P
Spindle pitch [mm/rev.]	1.5	3	10	2.5	5	12.7	4	10	20
Spindle diameter [mm]	9	10	10	12.5	12	12.7	20	20	20
Max. stat. axial force [N]	600	600	600	1,400	1,400	1,400	3,700	3,700	3,700
Max. feed force F_x ¹⁾ [N]	300	300	350	600	525	800	1,000	2,500	1,625
Continuous feed force ¹⁾ [N]	300	240	280	600	420	640	1,000	2,000	1,300
Max. driving torque ²⁾ [Nm]	0.4	0.4	0.8	1.15	0.9	1.9	3	4.9	5.9
Max. radial force ³⁾ [N]	120	120	120	260	260	260	300	300	300
Max. speed [m/s]	0.06	0.15	0.5	0.07	0.25	0.64	0.07	0.5	1.0
Max. rotational speed [rpm]	2,400	3,000	3,000	1,650	3,000	3,000	1,050	3,000	3,000
Max. acceleration [m/s ²]	1	6	6	1	6	6	1	6	6
Reversing backlash ⁴⁾ [mm]	0.2	0.05	0.05	0.2	0.05	0.05	0.2	0.05	0.05
Repetition accuracy [mm]	±0.07	±0.02	±0.02	±0.07	±0.02	±0.02	±0.07	±0.02	±0.02

1) In the case of the variant with lead screw spindle (LS), the feed force depends on the speed → 10
The feed force in the case of the variant with ball screw spindle (BS) → 8

2) In the case of the variant with lead screw spindle (LS), the driving torque depends on the rotational speed → 11

3) At the drive shaft

4) In new condition

Electric cylinders DNCE, with spindle drive

Technical data

Mechanical data										
Size	32			40			63			
Spindle design	LS-™1,5™P	BS-™3™P	BS-™10™P	LS-™2,5™P	BS-™5™P	BS-™12,7™P	LS-™4™P	BS-™10™P	BS-™20™P	
No-load driving torque										
With axial kit ¹⁾										
DNCE-...	[Nm]	0.08	0.08	0.08	0.12	0.12	0.12	0.3	0.2	0.2
DNCE-...-P5	[Nm]	-	0.12	0.12	-	0.18	0.18	-	0.3	0.3
With parallel kit ¹⁾										
DNCE-...	[Nm]	0.13	0.13	0.13	0.22	0.22	0.22	0.6	0.5	0.5
DNCE-...-P5	[Nm]	-	0.17	0.17	0.17	0.28	0.28	-	0.6	0.6
Continuous driving torque	[Nm]	0.4	0.3	0.6	1.15	0.8	1.6	3	4.1	4.8

1) Measured at a speed of 200 rpm

Operating and environmental conditions	
Ambient temperature ¹⁾	[°C] 0 ... 50
Storage temperature	[°C] -25 ... +60
Protection class to IEC 60529	
DNCE-...	IP40
DNCE-...-P5	IP65
Relative air humidity	[%] 0 ... 95
Suitability for use in the food industry	As per manufacturer's declaration (→ Support / Downloads)
Corrosion resistance class CRC ²⁾	
DNCE-...-R3	3

1) Note operating range of proximity sensors and motors

2) Corrosion resistance class 3 according to Festo standard 940 070

Components subject to high corrosion stress. External visible parts in direct contact with industrial atmospheres or media such as solvents and cleaning agents, with a predominantly functional requirement for the surface.

Only with combined attachment of motor

Weight [g]										
Size	32			40			63			
Spindle design	LS-™1,5™P	BS-™3™P	BS-™10™P	LS-™2,5™P	BS-™5™P	BS-™12,7™P	LS-™4™P	BS-™10™P	BS-™20™P	
Basic weight with 0 mm stroke	720	750	770	1,210	1,270	1,350	2,790	3,010	3,010	
Additional weight per 10 mm stroke	32.4	33	33.6	46.1	45.5	46.7	79.8	81.2	81.2	
Moving load with 0 mm stroke	150	170	200	250	310	380	600	810	810	
Moving load per 10 mm stroke	6.9	6.9	6.9	8.9	8.9	8.9	12.8	12.8	12.8	

Mass moment of inertia										
Size	32			40			63			
Spindle design	LS-™1,5™P	BS-™3™P	BS-™10™P	LS-™2,5™P	BS-™5™P	BS-™12,7™P	LS-™4™P	BS-™10™P	BS-™20™P	
J ₀ with 0 mm stroke	[kg cm ²]	0.0433	0.0439	0.0446	0.1316	0.1304	0.1337	0.7565	0.7626	0.7624
j _H per metre stroke	[kg cm ² /m]	0.0361	0.0476	0.0595	0.1341	0.1163	0.1572	0.8176	0.9090	0.9103
j _L per kg working load	[kg cm ² /kg]	0.0006	0,0023	0.0253	0.0016	0.0063	0.0409	0.0041	0.0253	0.1013

The mass moment of inertia J_A of the electric cylinder is calculated as follows:

$$J_A = J_0 + j_H \times \text{working stroke [m]} + j_L \times m_{\text{working load [kg]}}$$

Electric cylinders DNCE, with spindle drive

Technical data



Calculation of the mean feed force F_{xm} for the electric cylinder DNCE with ball screw spindle (BS)

The peak feed force value must not exceed the maximum feed force within a movement cycle. In the case of vertical operation, the peak value is

generally achieved during the acceleration phase of the upwards stroke. If the maximum feed force is exceeded, this can increase wear and

thus shorten the service life of the ball screw spindle. The maximum speed must likewise not be exceeded.

$$F_x \leq F_{x\max.}$$

and

$$v_x \leq v_{x\max.}$$

Mean feed force (to DIN 69 051-4)

During operation, the continuous feed force may be briefly exceeded up to the maximum feed force. The

continuous feed force must, however, be adhered to when averaged over a movement cycle.

$$F_{xm} \leq F_{xcont}$$

$$F_{xm} = \sqrt[3]{\sum F_x^3 \times \frac{v_x}{v_{xm}} \times \frac{q}{100}} =$$

$$F_{xm} = \sqrt[3]{F_{x1}^3 \times \frac{v_{x1}}{v_{xm}} \times \frac{q_1}{100} + F_{x2}^3 \times \frac{v_{x2}}{v_{xm}} \times \frac{q_2}{100} + F_{x3}^3 \times \frac{v_{x3}}{v_{xm}} \times \frac{q_3}{100} + \dots}$$

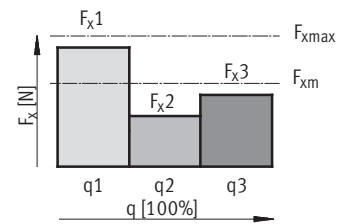

Mean feed speed (to DIN 69 051-4)

$$v_{xm} = \sum v_x \times \frac{q}{100} = v_{x1} \times \frac{q_1}{100} + v_{x2} \times \frac{q_2}{100} + v_{x3} \times \frac{q_3}{100} + \dots$$

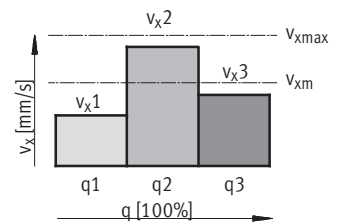

F_x	Feed force	v_x	Feed speed
F_{xm}	Mean feed force	v_{xm}	Mean feed speed
$F_{x\max.}$	Max. feed force	$v_{x\max.}$	Max. feed speed
F_{xcont}	Continuous feed force		
q	Time		

Materials

Sectional view

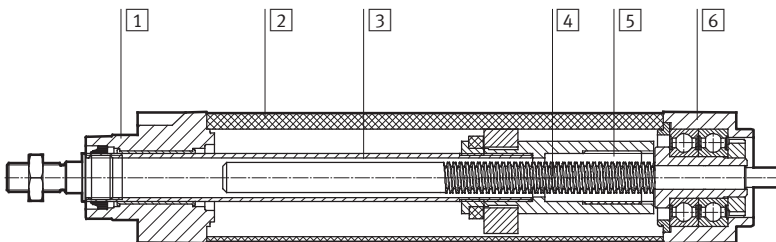

Electric cylinder	
1	Bearing cap Painted die-cast aluminium
2	Cylinder barrel Smooth anodised wrought aluminium alloy
3	Piston rod High-alloy stainless steel
4	Spindle Steel
5	Spindle nut for LS Polyacetal
	Spindle nut for BS Steel
6	Drive cover Painted die-cast aluminium

Electric cylinders DNCE, with spindle drive

Technical data

Maximum permissible loads on the piston rod

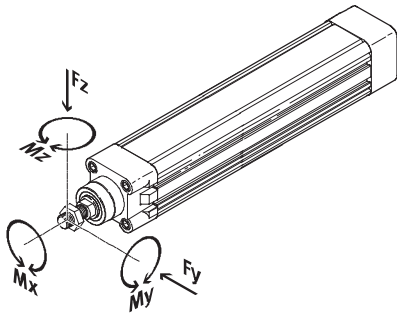

If there are two or more forces and torques simultaneously acting on the piston rod, the following equations must be satisfied:

$$\frac{|F_y|}{F_{y_{max}}} + \frac{|F_z|}{F_{z_{max}}} + \frac{|M_y|}{M_{y_{max}}} + \frac{|M_z|}{M_{z_{max}}} \leq 1$$

$$|F_x| \leq F_{x_{max}}$$

$$|M_x| \leq M_{x_{max}}$$

Definition of the stroke length l:

$$l = \text{Stroke} + \text{value of the piston rod extension K8}$$

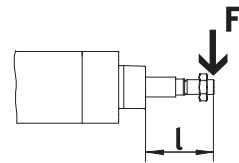

Maximum permissible lateral forces $F_{y_{max}}$ and $F_{z_{max}}$ on the piston rod as a function of stroke length l

Horizontal mounting position

Vertical mounting position

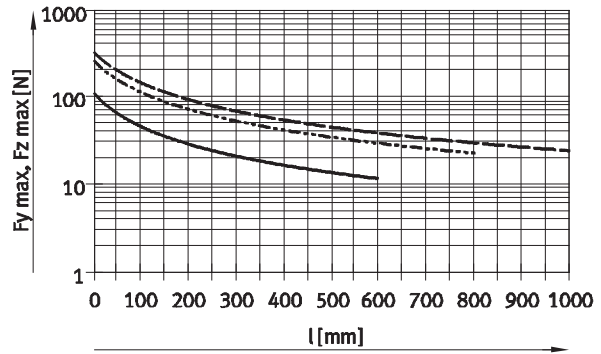
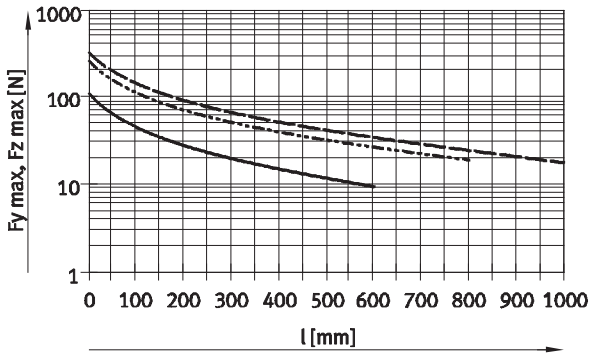

- DNCE-32-LS/BS
- - - DNCE-40-LS/BS
- DNCE-63-LS/BS

Note

PositioningDrives
sizing software
→ www.festo.com

Size	32	40	63
Maximum permissible forces and torques			
$F_{x_{max}}$ (static) [N]	600	1,400	3,700
$M_{x_{max}}$ [Nm]	1	1	1.5
$M_{y_{max}}, M_{z_{max}}$ [Nm]	8	20	27

Electric cylinders DNCE, with spindle drive

Technical data

FESTO

Feed force F as a function of speed v

DNCE-32-1...299-LS-...

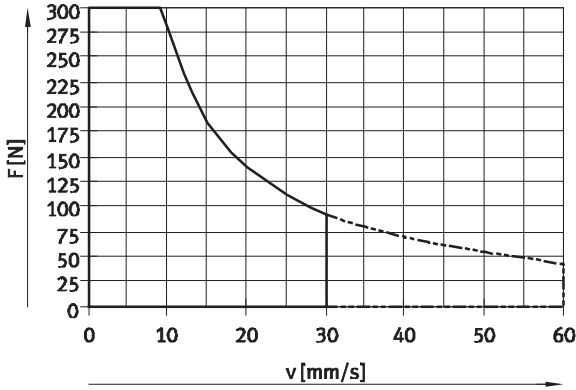

DNCE-32-300...400-LS-...

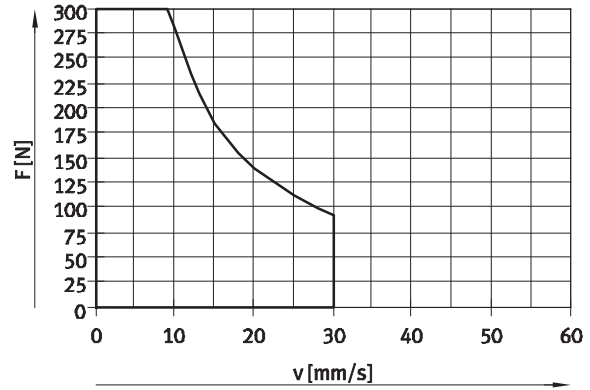

DNCE-40-1...299-LS-...

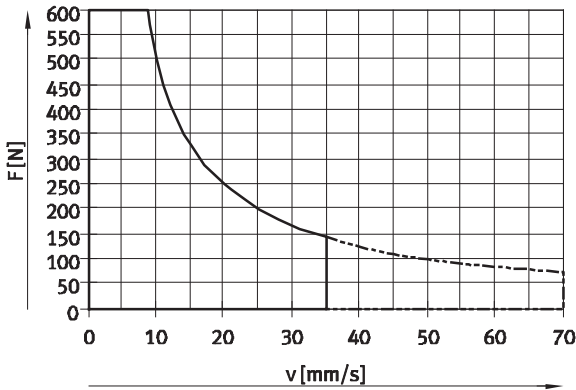

DNCE-40-300...600-LS-...

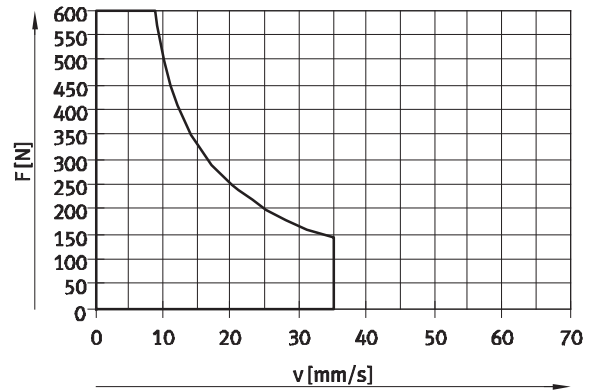

DNCE-63-1...419-LS-...

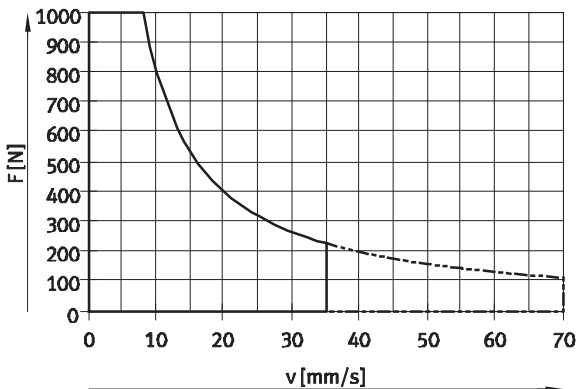

DNCE-63-420...800-LS-...

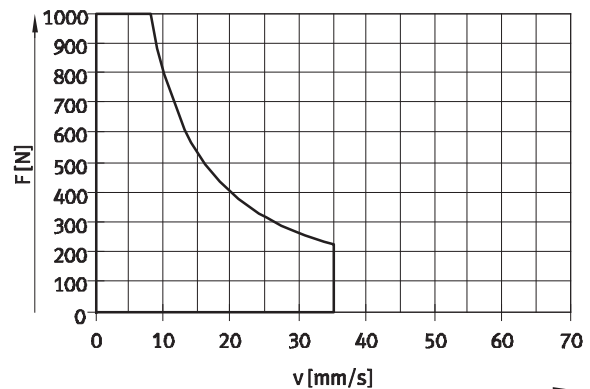

- Recommended operating range
- - - Permissible operating range
(duty cycle < 50% recommended)

Electric cylinders DNCE, with spindle drive

Technical data

Driving torque M as a function of rotational speed n

DNCE-32-1...299-LS-...

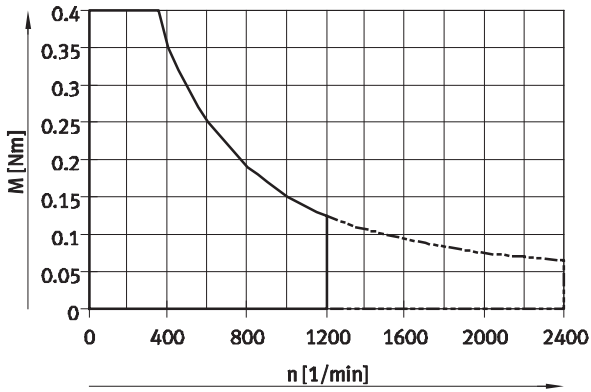

DNCE-32-300...400-LS-...

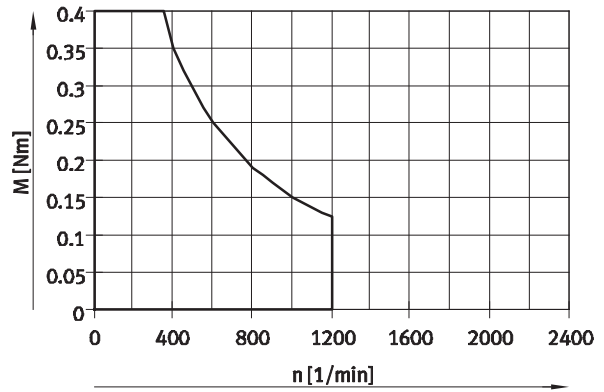

DNCE-40-1...299-LS-...

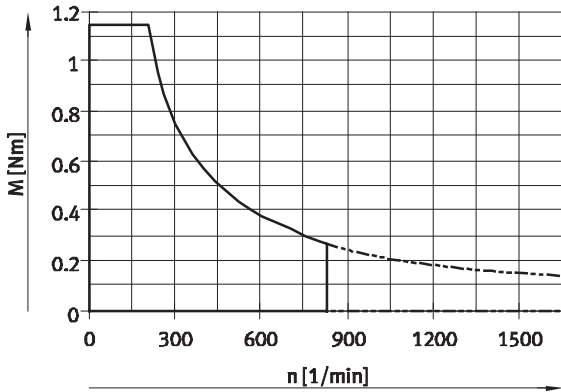

DNCE-40-300...600-LS-...

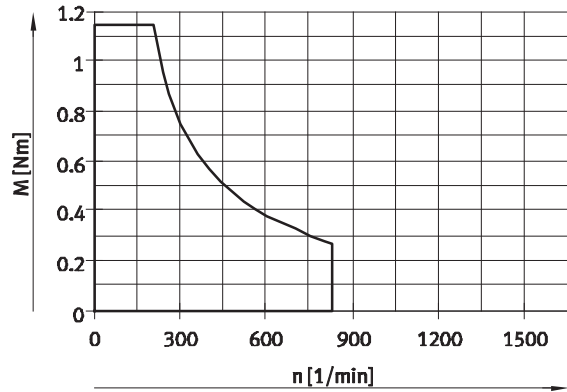

DNCE-63-1...419-LS-...

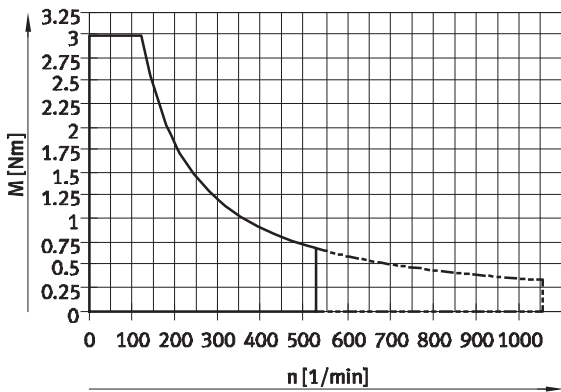

DNCE-63-420...800-LS-...

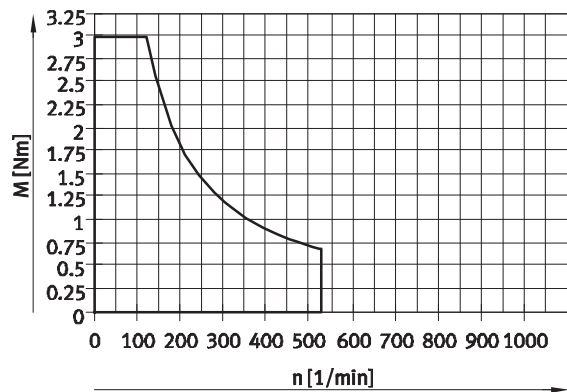

- Recommended operating range
- - - Permissible operating range
(duty cycle < 50% recommended)

Electric cylinders DNCE, with spindle drive

Technical data

Rotational speed n as a function of speed v

DNCE-...-LS-...

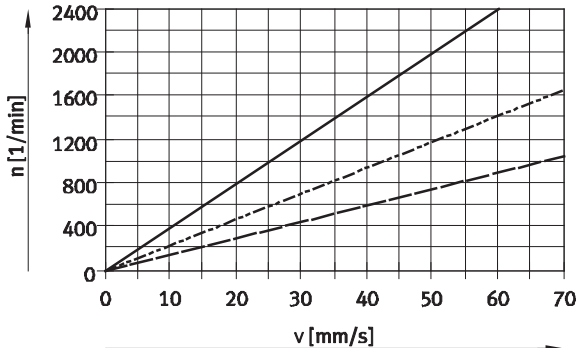

- DNCE-32-LS-1,5''P
- - - DNCE-40-LS-2,5''P
- · - DNCE-63-LS-4''P

DNCE-...-BS-...

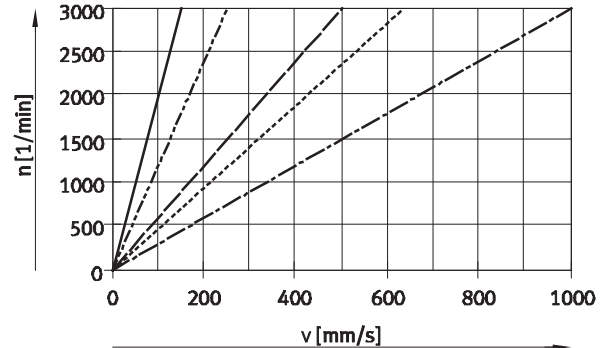

- DNCE-32-BS-3''P
- - - DNCE-40-BS-5''P
- · - DNCE-63-BS-10''P
- · - DNCE-32-BS-10''P
- · - DNCE-40-BS-12,7''P
- · - DNCE-63-BS-20''P

Driving torque M as a function of feed force F

Note

The frictional torques at room temperature are taken into consideration in the graphs.

The frictional torques with the DNCE-...-LS (lead screw spindle) increase at lower temperatures.

PositioningDrives sizing software
→ www.festo.com

DNCE-...-LS-...

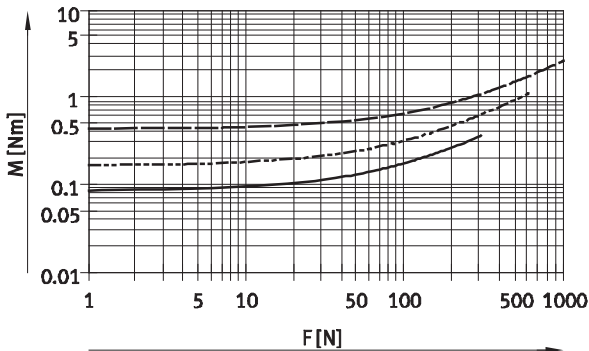

- DNCE-32-LS-1,5''P
- - - DNCE-40-LS-2,5''P
- · - DNCE-63-LS-4''P

DNCE-...-BS-...

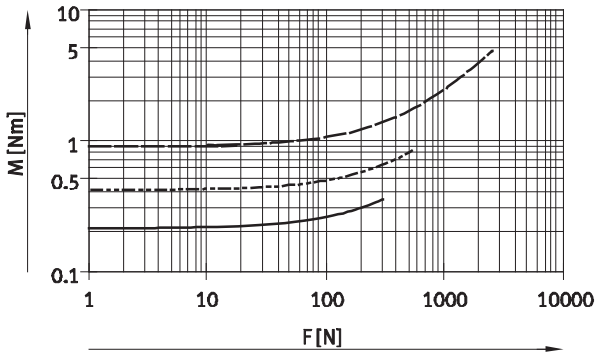

- DNCE-32-BS-3''P
- - - DNCE-40-BS-5''P
- · - DNCE-63-BS-10''P

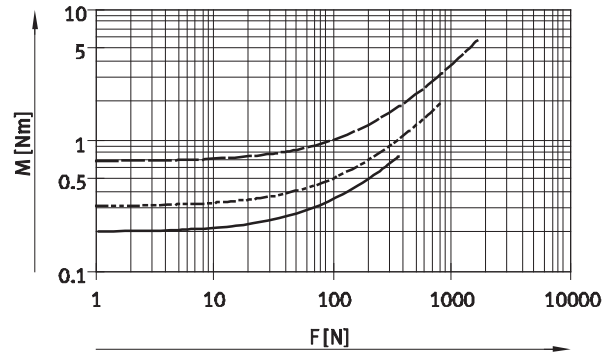

- DNCE-32-BS-10''P
- - - DNCE-40-BS-12,7''P
- · - DNCE-63-BS-20''P

Electric cylinders DNCE, with spindle drive

Technical data

Piston rod displacement f as a function of stroke length l

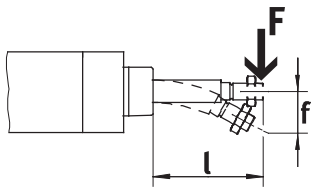

Definition of the stroke length l :
 $l = \text{Stroke} + \text{value of the piston rod extension K8}$

DNCE-32-...

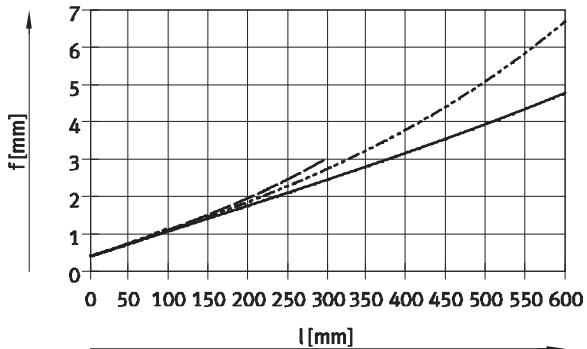

- Lateral force $F = 0$ N
- - - Lateral force $F = 10$ N
- - - Lateral force $F = 20$ N
- - - Lateral force $F = 45$ N

DNCE-40-...

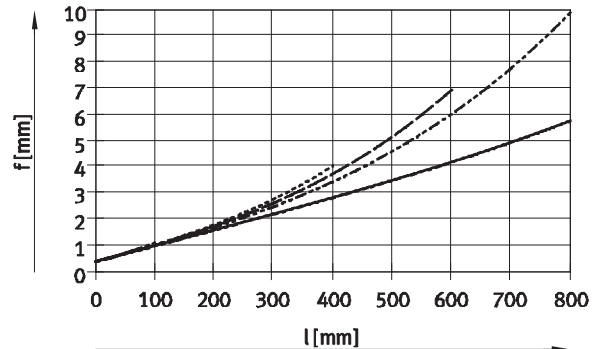

- Lateral force $F = 0$ N
- - - Lateral force $F = 20$ N
- - - Lateral force $F = 30$ N
- - - Lateral force $F = 40$ N
- - - Lateral force $F = 115$ N

DNCE-63-...

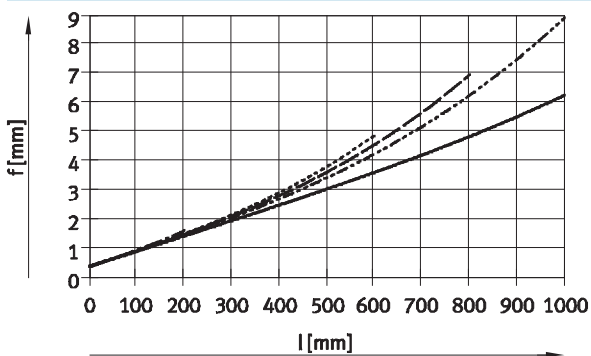

- Lateral force = 0 N
- - - Lateral force = 20 N
- - - Lateral force = 30 N
- - - Lateral force = 40 N
- - - Lateral force = 95 N

Electric cylinders DNCE, with spindle drive

Technical data

Mean feed force F as a function of running performance L (to DIN 69 051-4)

DNCE-32-...-BS-...

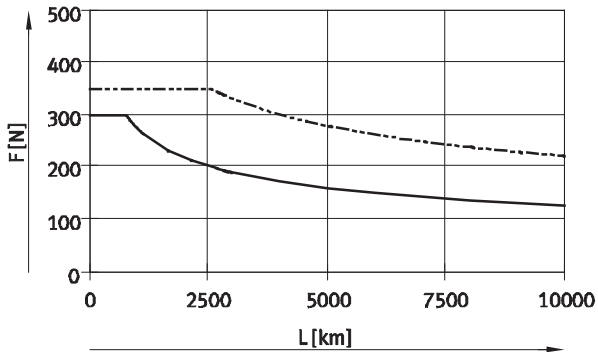

— DNCE-32-BS-3\"P
 - - - DNCE-32-BS-10\"P

DNCE-40-...-BS-...

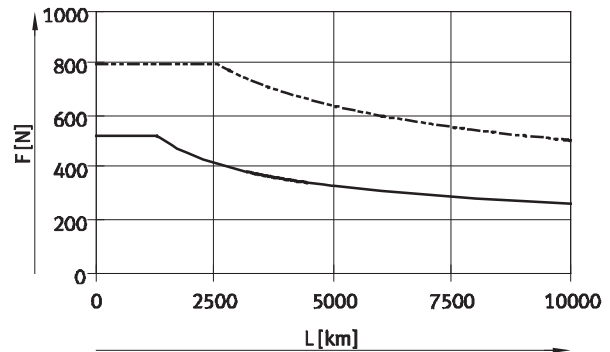

— DNCE-40-BS-5\"P
 - - - DNCE-40-BS-12,7\"P

DNCE-63-...-BS-...

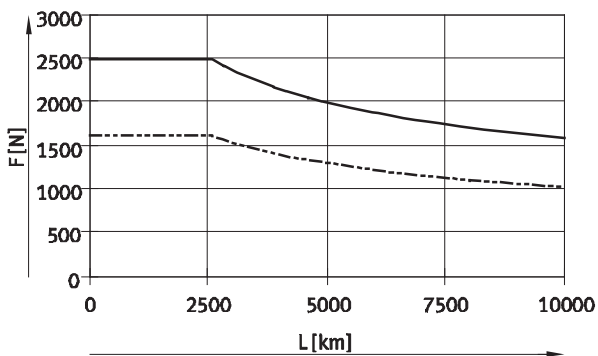

— DNCE-63-BS-10\"P
 - - - DNCE-63-BS-20\"P

Note

- The specifications for running performance are based on experimentally determined and theoretically calculated data. The running performance attainable in practice can deviate considerably from the specified curves under different parameters.

Electric cylinders DNCE, with spindle drive

Technical data



Dimensions

Download CAD Data → www.festo.com/us/cad

Basic version

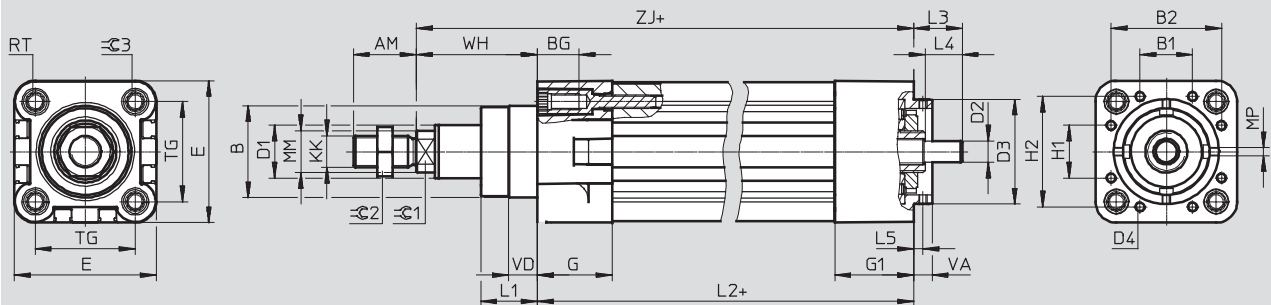

+ = plus stroke length

Size	AM	B	B1	B2	BG	D1	D2	D3	D4	E	G	G1	H1	H2	KK
[mm]		\varnothing d11				\varnothing h9	\varnothing h6	\varnothing f7							
32	22	30	19	32	16	16	6	32	M3	45.5	24	26	19	32	M10x1.25
40	24	35	20	42	16	20	8	40	M4	54	28.5	30	20	42	M12x1.25
63	32	45	31	62	17	28	12	60	M5	75.5	34	36	31	62	M16x1.5

Size	L1	L2	L3	L4	L5	MM	MP	RT	TG	VA	VD	WH	ZJ	$\varnothing 1$	$\varnothing 2$	$\varnothing 3$
[mm]											+1/-0.7		± 1			
32	18	122	15.9	8	3.5	12	M3	M6	32.5	7	10	26	148	10	17	6
40	21.5	146.5	18.4	14	3.5	16	M3	M6	38	7	10.5	30	176.5	13	19	6
63	28.5	177	23.5	17	4.5	20	M4	M8	56.5	9	15	37	214	17	24	8

Variants

K8 – Extended piston rod

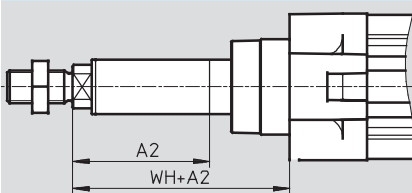

K3 – Female piston rod thread

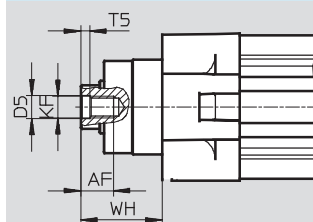

P5 – Protection class IP65

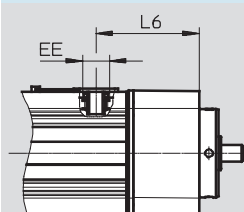

Size	A2	AF	EE	KF	L6	T5	D5	WH
[mm]	max.							
32	200	12	G $\frac{1}{8}$	M6	37.6	2.6	6.4	26
40	200	12	G $\frac{1}{4}$	M8	45.6	3.3	8.4	30
63	200	16	G $\frac{1}{4}$	M10	57.6	4.7	10.5	37

Electric cylinders DNCE, with spindle drive

Technical data

FESTO

Ordering data – DNCE-32			
Stroke [mm]	Part No.	Type	
Ball screw spindle with spindle pitch 3 mm			
100	543 115	DNCE-32-100-BS-”3”P-Q	
200	543 116	DNCE-32-200-BS-”3”P-Q	
300	543 117	DNCE-32-300-BS-”3”P-Q	
400	543 118	DNCE-32-400-BS-”3”P-Q	
Ball screw spindle with spindle pitch 10 mm			
100	543 119	DNCE-32-100-BS-”10”P-Q	
200	543 120	DNCE-32-200-BS-”10”P-Q	
300	543 121	DNCE-32-300-BS-”10”P-Q	
400	543 122	DNCE-32-400-BS-”10”P-Q	
Lead screw spindle with spindle pitch 1.5 mm			
100	543 111	DNCE-32-100-LS-”1,5”P-Q	
200	543 112	DNCE-32-200-LS-”1,5”P-Q	
300	543 113	DNCE-32-300-LS-”1,5”P-Q	
400	543 114	DNCE-32-400-LS-”1,5”P-Q	

Ordering data – DNCE-40			
Stroke [mm]	Part No.	Type	
Ball screw spindle with spindle pitch 5 mm			
100	543 127	DNCE-40-100-BS-”5”P-Q	
200	543 128	DNCE-40-200-BS-”5”P-Q	
300	555 466	DNCE-40-300-BS-”5”P-Q	
400	543 129	DNCE-40-400-BS-”5”P-Q	
600	543 130	DNCE-40-600-BS-”5”P-Q	
Ball screw spindle with spindle pitch 12.7 mm			
100	543 131	DNCE-40-100-BS-”12,7”P-Q	
200	543 132	DNCE-40-200-BS-”12,7”P-Q	
300	555 467	DNCE-40-300-BS-”12,7”P-Q	
400	543 133	DNCE-40-400-BS-”12,7”P-Q	
600	543 134	DNCE-40-600-BS-”12,7”P-Q	
Lead screw spindle with spindle pitch 2.5 mm			
100	543 123	DNCE-40-100-LS-”2,5”P-Q	
200	543 124	DNCE-40-200-LS-”2,5”P-Q	
300	555 465	DNCE-40-300-LS-”2,5”P-Q	
400	543 125	DNCE-40-400-LS-”2,5”P-Q	
600	543 126	DNCE-40-600-LS-”2,5”P-Q	

Ordering data – DNCE-63			
Stroke [mm]	Part No.	Type	
Ball screw spindle with spindle pitch 10 mm			
100	555 470	DNCE-63-100-BS-”10”P-Q	
200	543 139	DNCE-63-200-BS-”10”P-Q	
300	555 471	DNCE-63-300-BS-”10”P-Q	
400	543 140	DNCE-63-400-BS-”10”P-Q	
600	543 141	DNCE-63-600-BS-”10”P-Q	
800	543 142	DNCE-63-800-BS-”10”P-Q	
Ball screw spindle with spindle pitch 20 mm			
100	555 472	DNCE-63-100-BS-”20”P-Q	
200	543 143	DNCE-63-200-BS-”20”P-Q	
300	555 473	DNCE-63-300-BS-”20”P-Q	
400	543 144	DNCE-63-400-BS-”20”P-Q	
600	543 145	DNCE-63-600-BS-”20”P-Q	
800	543 146	DNCE-63-800-BS-”20”P-Q	
Lead screw spindle with spindle pitch 4 mm			
100	555 468	DNCE-63-100-LS-”4”P-Q	
200	543 135	DNCE-63-200-LS-”4”P-Q	
300	555 469	DNCE-63-300-LS-”4”P-Q	
400	543 136	DNCE-63-400-LS-”4”P-Q	
600	543 137	DNCE-63-600-LS-”4”P-Q	
800	543 138	DNCE-63-800-LS-”4”P-Q	

Note

Order variable strokes via the modular product system → 17

Electric cylinders DNCE, with spindle drive

Ordering data – Modular products

FESTO

Ordering table						
Size	32	40	63	Conditions	Code	Enter code
M Module No.	555488	555489	555490			
Function	Electric cylinder				DNCE	DNCE
Size	32	40	63		-...	
Stroke [mm]	100				-...	
	200					
	300					
	400					
	-	600				
	-	-	800			
	1 ... 400	1 ... 600	1 ... 800	[1]		
Drive type	Lead screw spindle				-LS	
	Ball screw spindle				-BS	
Spindle pitch [mm]	1.5	-	-	[2]	-“...”P	
	-	2.5	-	[2]		
	3	-	-	[3]		
	-	-	4	[2]		
	-	5	-	[3]		
	10	-	10	[3]		
	-	12.7	-	[3]		
	-	-	20	[3]		
Protection against rotation	Non-rotating piston rod				-Q	-Q
O Extended piston rod	1 ... 200			[3]	-...K8	
Female thread	M6	M8	M10	[3]	-K3	
Protection class to IEC 60529	IP65			[3]	-P5	
Corrosion protection	High corrosion protection			[3] [4]	-R3	
Lubrication	Lubrication approved for use in food applications			[3] [5]	-FG	

- [1] ... Additional stroke lengths on request
- [2] **“1.5”P, “2.5”P, “4”P**
Only with drive type LS
- [3] **“3”P, “5”P, “10”P, “12.7”P, “20”P, ...K8, K3, P5**
Only with ball screw spindle BS
- [4] **R3** Only with P5
- [5] **FG** Only with R3 and P5

Transfer order code

DNCE - - - - - - **Q** - - -

Electric cylinders DNCE, with spindle drive

Accessories

FESTO

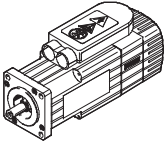
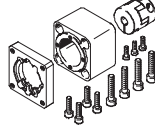
Permissible axis/motor combinations with axial kit		Technical data → Internet: eamm-a	
Motor/motor unit	Axial kit		
			
Type	Part No.	Type	
DNCE-32			
With servo motor			
EMMS-AS-40-...	543147	EAMM-A-D32-40A	
	1322178	EAMM-A-D32A-40A-S1 ¹⁾	
EMMS-AS-55-...	550979	EAMM-A-D32-55A	
	1322180	EAMM-A-D32A-55A-S1 ¹⁾	
With stepper motor			
EMMS-ST-42-...	543148	EAMM-A-D32-42A	
	1322179	EAMM-A-D32A-42A-S1 ¹⁾	
EMMS-ST-57-...	550980	EAMM-A-D32-57A	
	1322181	EAMM-A-D32A-57A-S1 ¹⁾	
With motor unit			
MTR-DCI-32S-... ²⁾	543149	EAMM-A-D32-32B	
DNCE-40			
With servo motor			
EMMS-AS-55-...	543153	EAMM-A-D40-55A	
	1322182	EAMM-A-D40A-55A-S1 ¹⁾	
EMMS-AS-70-...	550981	EAMM-A-D40-70A	
	1322185	EAMM-A-D40A-70A-S1 ¹⁾	
With servo motor and gear unit			
EMMS-AS-40-... EMGA-40-P-G...-SAS-40	560282	EAMM-A-D40-40G	
With stepper motor			
EMMS-ST-57-...	543154	EAMM-A-D40-57A	
	1322183	EAMM-A-D40A-57A-S1 ¹⁾	
EMMS-ST-87-...	550982	EAMM-A-D40-87A	
	1322186	EAMM-A-D40A-87A-S1 ¹⁾	
With motor unit			
MTR-DCI-42S-...-G7 ²⁾	543155	EAMM-A-D40-42B	
MTR-DCI-42S-...-G14 ²⁾	543156	EAMM-A-D40-42C	

- 1) With protection class IP65
2) Only in conjunction with DNCE-...-LS

Note

Depending on the combination of motor/motor unit and electric cylinder, it may not be possible to reach the maximum feed force of the cylinder.

The following tool is available for sizing:
PositioningDrives
sizing software
→ www.festo.com

Electric cylinders DNCE, with spindle drive

Accessories

FESTO

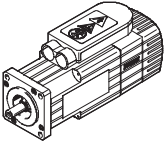
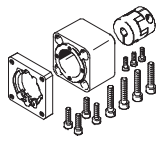
Permissible axis/motor combinations with axial kit		Technical data → Internet: eamm-a
Motor/motor unit	Axial kit	
		
Type	Part No.	Type
DNCE-63		
With servo motor		
EMMS-AS-70-...	543161	EAMM-A-D60-70A
	1322187	EAMM-A-D60A-70A-S1 ¹⁾
EMMS-AS-100-...	550983	EAMM-A-D60-100A
	1322190	EAMM-A-D60A-100A-S1 ¹⁾
With servo motor and gear unit		
EMMS-AS-55-... EMGA-60-P-G...-SAS-55	560283	EAMM-A-D60-60G
EMMS-AS-70-... EMGA-60-P-G...-SAS-70	560283	EAMM-A-D60-60G
With stepper motor		
EMMS-ST-87-...	543162	EAMM-A-D60-87A
	1322188	EAMM-A-D60A-87A-S1 ¹⁾
With servo motor and gear unit		
EMMS-ST-57-... EMGA-60-P-G...-SST-57	560283	EAMM-A-D60-60G
With motor unit		
MTR-DCI-52S-...-G7 ²⁾	543163	EAMM-A-D60-52B
MTR-DCI-52S-...-G14 ²⁾	543164	EAMM-A-D60-52C

- 1) With protection class IP65
2) Only in conjunction with DNCE-...-LS

Note



Depending on the combination of motor/motor unit and electric cylinder, it may not be possible to reach the maximum feed force of the cylinder.

The following tool is available for sizing:
PositioningDrives
sizing software
→ www.festo.com

Electric cylinders DNCE, with spindle drive

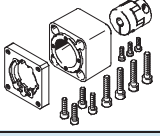

Accessories

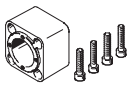
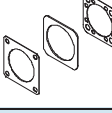
FESTO

Component parts of the axial kit				
Axial kit	Consisting of:			
	Motor flange	Coupling	Coupling housing	Seal set
				
Part No. Type	Part No. Type	Part No. Type	Part No. Type	Part No. Type
DNCE-32				
543149 EAMM-A-D32-32B	–	543420 EAMC-16-20-6-6	552156 EAMK-A-D32-32B	–
543147 EAMM-A-D32-40A	552163 EAMF-A-28B-40A	543420 EAMC-16-20-6-6	552155 EAMK-A-D32-28B	–
1322178 EAMM-A-D32A-40A-S1				1561526 EADS-F-D32A-40A
543148 EAMM-A-D32-42A	552164 EAMF-A-28B-42A	543419 EAMC-16-20-5-6	552155 EAMK-A-D32-28B	–
1322179 EAMM-A-D32A-42A-S1				1561527 EADS-F-D32A-42A
550979 EAMM-A-D32-55A	529942 EAMF-A-44A/B-55A	551003 EAMC-30-32-6-9	551006 EAMK-A-D32-44A	–
1322180 EAMM-A-D32A-55A-S1				1561528 EADS-F-D32A-55A
550980 EAMM-A-D32-57A	530081 EAMF-A-44A/B-57A	551002 EAMC-30-32-6-6.35	551006 EAMK-A-D32-44A	–
1322181 EAMM-A-D32A-57A-S1				1561529 EADS-F-D32A-57A
DNCE-40				
543155 EAMM-A-D40-42B	–	543422 EAMC-30-32-8-8	552158 EAMK-A-D40-42B	–
543156 EAMM-A-D40-42C	–	543422 EAMC-30-32-8-8	552159 EAMK-A-D40-42C	–
543153 EAMM-A-D40-55A	529942 EAMF-A-44A/B-55A	543423 EAMC-30-32-8-9	552157 EAMK-A-D40-44A	–
1322182 EAMM-A-D40A-55A-S1				1561530 EADS-F-D40A-55A
543154 EAMM-A-D40-57A	530081 EAMF-A-44A/B-57A	543421 EAMC-30-32-6.35-8	552157 EAMK-A-D40-44A	–
1322183 EAMM-A-D40A-57A-S1				1561531 EADS-F-D40A-57A
550981 EAMM-A-D40-70A	529943 EAMF-A-44A/B-70A	551004 EAMC-30-32-8-11	552157 EAMK-A-D40-44A	–
1322185 EAMM-A-D40A-70A-S1				1561532 EADS-F-D40A-70A
550982 EAMM-A-D40-87A	530082 EAMF-A-44A/B-87A	551004 EAMC-30-32-8-11	552157 EAMK-A-D40-44A	–
1322186 EAMM-A-D40A-87A-S1				1561533 EADS-F-D40A-87A
560282 EAMM-A-D40-40G	550986 EAMF-44A/B-40G	558029 EAMC-30-32-8-10	552157 EAMK-A-D40-44A	–

Electric cylinders DNCE, with spindle drive

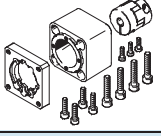
Accessories

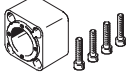
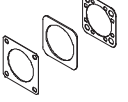
Component parts of the axial kit				
Axial kit	Consisting of:			
	Motor flange	Coupling	Coupling housing	Seal set
				
Part No. Type	Part No. Type	Part No. Type	Part No. Type	Part No. Type
DNCE-63				
543163 EAMM-A-D60-52B	–	533709 EAMC-42-50-12-12	552161 EAMK-A-D60-52B	–
543164 EAMM-A-D60-52C	–	533709 EAMC-42-50-12-12	552162 EAMK-A-D60-52C	–
543161 EAMM-A-D60-70A	529945 EAMF-A-64A/B-70A	543424 EAMC-42-50-11-12	552160 EAMK-A-D60-64B	–
1322187 EAMM-A-D60A-70A-S1				1561534 EADS-F-D60A-70A
543162 EAMM-A-D60-87A	533140 EAMF-A-64A/B-87A	543424 EAMC-42-50-11-12	552160 EAMK-A-D60-64B	–
1322188 EAMM-A-D60A-87A-S1				1561536 EADS-F-D60A-87A
550983 EAMM-A-D60-100A	529947 EAMF-A-64A/C-100A	551005 EAMC-42-50-12-19	551007 EAMK-A-D60-64C	–
1322190 EAMM-A-D60A-100A-S1				1561537 EADS-F-D60A-100A
560283 EAMM-A-D60-60G	550987 EAMF-A-64A/B-60G	543424 EAMC-42-50-11-12	552160 EAMK-A-D60-64B	–

Electric cylinders DNCE, with spindle drive

Accessories

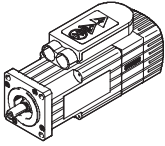
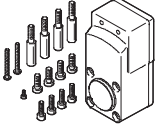
Permissible axis/motor combinations with parallel kit		Technical data → Internet: eamm-u	
Motor/motor unit	Parallel kit		
		<ul style="list-style-type: none"> Space-saving gravity die-cast housing 	
Type	Part No.	Type	
DNCE-32			
With servo motor			
EMMS-AS-40-...	543150	EAMM-U-D32-40A	
With motor unit			
MTR-DCI-32S-...	543152	EAMM-U-D32-32B	
DNCE-40			
With servo motor			
EMMS-AS-55-...	543157	EAMM-U-D40-55A	
With motor unit			
MTR-DCI-42S-...-G7	543159	EAMM-U-D40-42B	
MTR-DCI-42S-...-G14	543160	EAMM-U-D40-42C	
DNCE-63			
With servo motor			
EMMS-AS-70-...	543165	EAMM-U-D60-70A	
With motor unit			
MTR-DCI-52S-...-G7	543167	EAMM-U-D60-52B	
MTR-DCI-52S-...-G14	543168	EAMM-U-D60-52C	

Note

Depending on the combination of motor/motor unit and electric cylinder, it may not be possible to reach the maximum feed force of the cylinder.

The respective no-load driving torque of the kit must be taken into consideration when using parallel kits.

The following tool is available for sizing:
PositioningDrives
sizing software
→ www.festo.com

Electric cylinders DNCE, with spindle drive

Accessories

FESTO

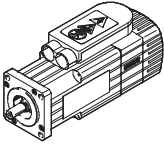
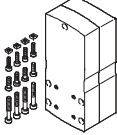
Permissible axis/motor combinations with parallel kit		Technical data → Internet: eamm-u
Motor/motor unit	Parallel kit	
		<ul style="list-style-type: none"> • Increased housing rigidity • Flexible motor connection possible • Optionally with protection class IP65 • Use in combination with third-party motors on request
Type	Part No.	Type
DNCE-32		
With servo motor		
EMMS-AS-40-...	1201591	EAMM-U-50-D32-40A-78
	1202302	EAMM-U-50-D32-40A-78-S1 ¹⁾
EMMS-AS-55-...	1210126	EAMM-U-60-D32-55A-91
	1210450	EAMM-U-60-D32-55A-91-S1 ¹⁾
With stepper motor		
EMMS-ST-42-...	1201607	EAMM-U-50-D32-42A-78
	1202312	EAMM-U-50-D32-42A-78-S1 ¹⁾
EMMS-ST-57-...	1210419	EAMM-U-60-D32-57A-91
	1210453	EAMM-U-60-D32-57A-91-S1 ¹⁾
With motor unit		
MTR-DCI-32S-...	1570862	EAMM-U-50-D32-32B-78
MTR-DCI-42S-...	1577393	EAMM-U-60-D32-42B/C-91
	1577380	EAMM-U-60-D32-42B/C-91-S1 ¹⁾
With gear unit		
EMGA-40-P-...	1577358	EAMM-U-60-D32-40G-91
	1577346	EAMM-U-60-D32-40G-91-S1 ¹⁾
DNCE-40		
With servo motor		
EMMS-AS-55-...	1210438	EAMM-U-60-D40-55A-91
	1210458	EAMM-U-60-D40-55A-91-S1 ¹⁾
EMMS-AS-70-...	1212826	EAMM-U-86-D40-70A-102
	1212854	EAMM-U-86-D40-70A-102-S1 ¹⁾
With stepper motor		
EMMS-ST-57-...	1210442	EAMM-U-60-D40-57A-91
	1210462	EAMM-U-60-D40-57A-91-S1 ¹⁾
EMMS-ST-87-...	1215802	EAMM-U-86-D40-87A-102
	1215814	EAMM-U-86-D40-87A-102-S1 ¹⁾
With motor unit		
MTR-DCI-42S-...	1570950	EAMM-U-60-D40-42B/C-91
	1430735	EAMM-U-60-D40-42B/C-91-S1 ¹⁾
MTR-DCI-52S-...	1537046	EAMM-U-86-D40-52B/C-102
	1537011	EAMM-U-86-D40-52B/C-102-S1 ¹⁾
With gear unit		
EMGA-40-P-...	1577165	EAMM-U-60-D40-40G-91
	1435968	EAMM-U-60-D40-40G-91-S1 ¹⁾
EMGA-60-P-...	1586445	EAMM-U-86-D40-60G-102
	1586429	EAMM-U-86-D40-60G-102-S1 ¹⁾
EMGC-60-P-...	1586496	EAMM-U-86-D40-60H-102
	1586372	EAMM-U-86-D40-60H-102-S1 ¹⁾

1) With protection class IP65

Electric cylinders DNCE, with spindle drive

Accessories

FESTO

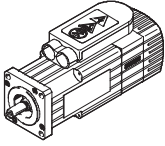
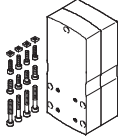
Permissible axis/motor combinations with parallel kit		Technical data → Internet: eamm-u
Motor/motor unit	Parallel kit	
		<ul style="list-style-type: none"> • Increased housing rigidity • Flexible motor connection possible • Optionally with protection class IP65 • Use in combination with third-party motors on request
Type	Part No.	Type
DNCE-63		
With servo motor		
EMMS-AS-70-...	1212477	EAMM-U-86-D60-70A-102
	1212835	EAMM-U-86-D60-70A-102-S1 ¹⁾
EMMS-AS-100-...	1202436	EAMM-U-110-D60-100A-120
	1203112	EAMM-U-110-D60-100A-120-S1 ¹⁾
With stepper motor		
EMMS-ST-87-...	1215784	EAMM-U-86-D60-87A-102
	1215810	EAMM-U-86-D60-87A-102-S1 ¹⁾
With motor unit		
MTR-DCI-52S-...	1537000	EAMM-U-86-D60-52B/C-102
	1431381	EAMM-U-86-D60-52B/C-102-S1 ¹⁾
MTR-DCI-62S-...	1536988	EAMM-U-110-D60-62B-120
	1431443	EAMM-U-110-D60-62B-120-S1 ¹⁾
With gear unit		
EMGA-60-P-...	1586347	EAMM-U-86-D60-60G-102
	1437163	EAMM-U-86-D60-60G-102-S1 ¹⁾
EMGC-60-P-...	1586276	EAMM-U-86-D60-60H-102
	1530837	EAMM-U-86-D60-60H-102-S1 ¹⁾
EMGA-60-P-...	1543240	EAMM-U-110-D60-60G-120
	1436183	EAMM-U-110-D60-60G-120-S1 ¹⁾
EMGC-60-P-...	1542264	EAMM-U-110-D60-60H-120
	1530621	EAMM-U-110-D60-60H-120-S1 ¹⁾
EMGA-80-P-...	1532949	EAMM-U-110-D60-80G-120
	1530875	EAMM-U-110-D60-80G-120-S1 ¹⁾

1) With protection class IP65

Note

The clamping component EADT is required to adjust the toothed belt pretension with EAMM-U-110.

The motor and/or axis shaft can optionally be supported with a counter bearing EAMG.
More information → eamm-u

Electric cylinders DNCE, with spindle drive

Accessories

FESTO

Bellows kit EADB



General technical data				
Type EADB-V1-		32	40	63
Max. stroke range of cylinder ¹⁾	[mm]	10 ... 400	10 ... 500	10 ... 500
Type of mounting		Push on		
		Via threaded pin		
Mounting position		Any		
Resistance to media		Dust, chippings, oil, grease, fuel (→ Internet: Resistance to media)		
Ambient temperature ²⁾	[°C]	-10 ... +80		
Protection class to IEC 60529		IP65		
Corrosion resistance class CRC ³⁾		3		

1) In combination with the bellows kit EADB

2) Note operating range of proximity sensors and cylinder

3) Corrosion resistance class 3 according to Festo standard 940 070

Components subject to high corrosion stress. External visible parts in direct contact with industrial atmospheres or media such as solvents and cleaning agents, with a predominantly functional requirement for the surface.

Materials

Sectional view

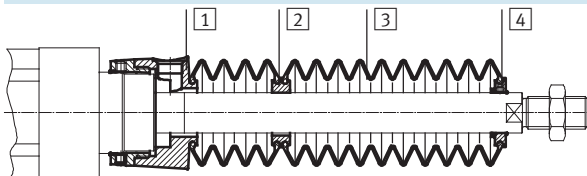

Bellows		
1	Connection	Anodised wrought aluminium alloy
2	Adapter	Polyamide
3	Bellows	Nitrile rubber
4	End piece	Anodised wrought aluminium alloy
-	O-ring	Nitrile rubber
Note on materials		Free of copper and PTFE Conforms to RoHS

Weight [g]				
Type EADB-V1-		32	40	63
Stroke [mm]				
Product weight				
10 ... 100		77	116	196
101 ... 200		108	153	263
201 ... 300		122	172	309
301 ... 400		153	209	376
401 ... 500		-	227	397
Moving load				
10 ... 100		35	43	86
101 ... 200		66	80	153
201 ... 300		80	99	199
301 ... 400		111	136	266
401 ... 500		-	154	287

Electric cylinders DNCE, with spindle drive

Accessories



Travel speed v as a function of tubing length l



The bellows kit is a leak-free system. To prevent unwanted media from being drawn in, the supply and exhaust air must be ducted via a pressure compensation hole in the

connection part **1**. The pressure generated in the bellows kit by the positioning motion is primarily defined by the travel speed

and tubing length. The recommended tubing length based on the travel speed of the drive can be read from the graph.

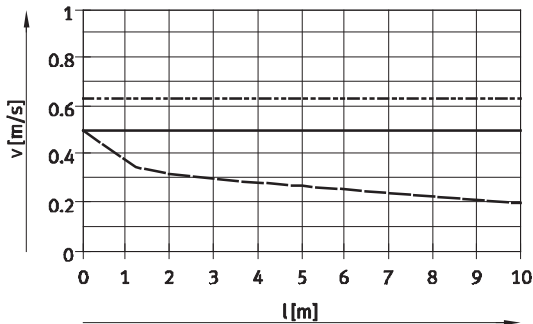

— EADB-V1-32/tubing Ø 8 mm
 - - - EADB-V1-40/tubing Ø 16 mm
 - · - EADB-V1-63/tubing Ø 16 mm

Note

The push-in fittings opposite must be used for the pressure compensation hole.

Silencers can be used as an alternative. This reduces the travel speed slightly.

Tubing length and push-in fitting for venting hole

Ø [mm]	Tubing O.D. [mm]	Push-in fitting	
		Part No.	Type
32	8	186109	QS-G $\frac{1}{8}$ -8-I
		533929	QS-F-G $\frac{1}{8}$ -8-I
40, 63	16	186350	QS-G $\frac{1}{4}$ -12
		533848	QS-F-G $\frac{1}{4}$ -12
		153261	QSH-16-12

Dimensions

Download CAD Data → www.festo.com/us/cad

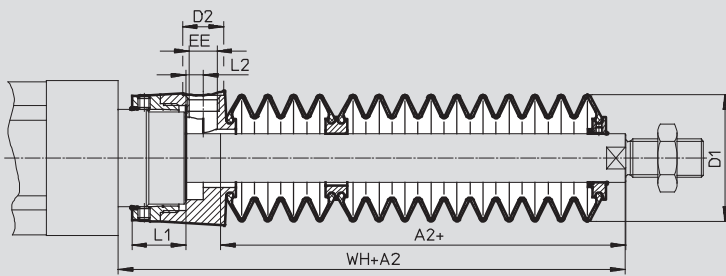

+ = plus stroke length

Ø Stroke [mm]	32							40						
	A2 ¹⁾	D1 max.	D2	EE	L1	L2	WH+A2	A2 ¹⁾	D1 max.	D2	EE	L1	L2	WH+A2
10 ... 100	44	46	14	G $\frac{1}{8}$	12.9	5.4	70	48	57	17	G $\frac{1}{4}$	16.3	7	78
101 ... 200	74						100	77						107
201 ... 300	88						114	88						118
301 ... 400	117						143	117						147
401 ... 500	-	-	-	-	-	-	-	135	-	-	-	-	-	165

Ø Stroke [mm]	63						
	A2 ¹⁾	D1 max.	D2	EE	L1	L2	WH+A2
10 ... 100	43	93	17	G $\frac{1}{4}$	22.4	7	80
101 ... 200	68						105
201 ... 300	80						117
301 ... 400	104						141
401 ... 500	117						154

1) The dimension corresponds to the K8 value (extended piston rod) of the cylinder

Electric cylinders DNCE, with spindle drive

Accessories



Ordering data – Bellows kit

An extended piston rod (order code K8) → 17 is absolutely necessary when using a bellows kit.

The necessary dimensions for K8 as a function of cylinder size and stroke as well as the corresponding bellows kit are indicated in the table below:

Order example:

Selected electric cylinder:

DNCE-32-250-BS-“3”P-Q-...K8

The dimension for the corresponding K8 value (see table):
88 mm

Complete type code for electric cylinder:

DNCE-32-250-BS-“3”P-Q-88K8

The corresponding bellows kit:

EADB-V1-32-S201-300

Cylinder data			Bellows kit		Cylinder data			Bellows kit	
∅	Stroke	Dimension for K8	Part No.	Type	∅	Stroke	Dimension for K8	Part No.	Type
[mm]	[mm]	[mm]			[mm]	[mm]	[mm]		
32	10 ... 100	44	570262	EADB-V1-32-S10-100	40	10 ... 100	48	570266	EADB-V1-40-S10-100
	101 ... 200	74	570263	EADB-V1-32-S101-200		101 ... 200	77	570267	EADB-V1-40-S101-200
	201 ... 300	88	570264	EADB-V1-32-S201-300		201 ... 300	88	570268	EADB-V1-40-S201-300
	301 ... 400	117	570265	EADB-V1-32-S301-400		301 ... 400	117	570269	EADB-V1-40-S301-400
	–					401 ... 500	135	570270	EADB-V1-40-S401-500
63	10 ... 100	43	570271	EADB-V1-63-S10-100					
	101 ... 200	68	570272	EADB-V1-63-S101-200					
	201 ... 300	80	570273	EADB-V1-63-S201-300					
	301 ... 400	104	570274	EADB-V1-63-S301-400					
	401 ... 500	117	570275	EADB-V1-63-S401-500					

Electric cylinders DNCE, with spindle drive



Accessories

Foot mounting HNCE, for axial motor mounting

Material:
Galvanised steel

Free of copper and PTFE

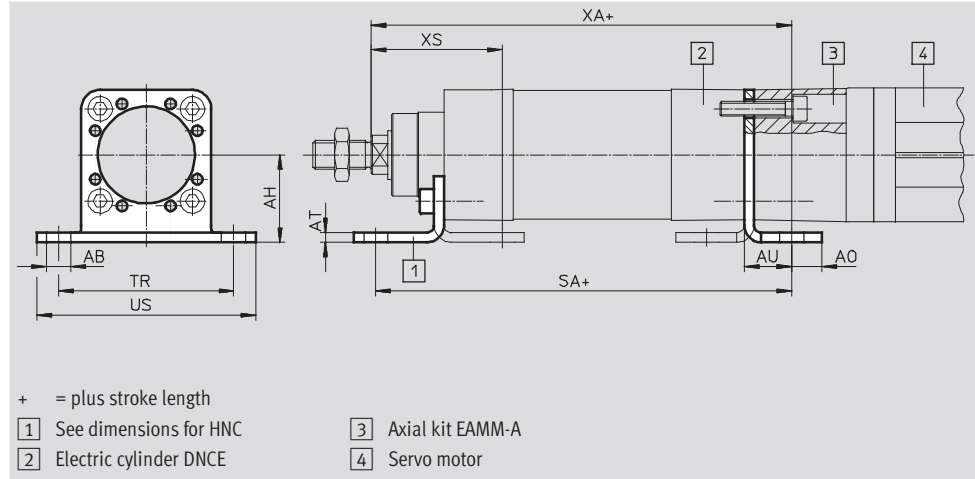

Dimensions and ordering data

For size	AB ∅	AH	AO	AT	AU	SA	TR	US	XA	XS
[mm]										
32	7	32	10.5	4	17.5	163.5	58	71	165.5	46
40	10	36	12.5	4	19.5	194.5	72	90	196	54
63	10	50	15	5	23	232	92	110	237	64

For size	CRC ¹⁾	Weight	Part No.	Type
[mm]		[g]		
32	1	160	547949	HNCE-32-AX
40	1	220	547950	HNCE-40-AX
63	1	470	547951	HNCE-63-AX

1) Corrosion resistance class 1 according to Festo standard 940 070
Components subject to low corrosion stress. Transport and storage protection. Parts that do not have primarily decorative surface requirements, e.g. in internal areas that are not visible or behind covers.

Electric cylinders DNCE, with spindle drive

Accessories

Profile mounting EAHF

Materials:

RoHS-compliant

Plate: Anodised aluminium

Clamping pieces: Galvanised steel

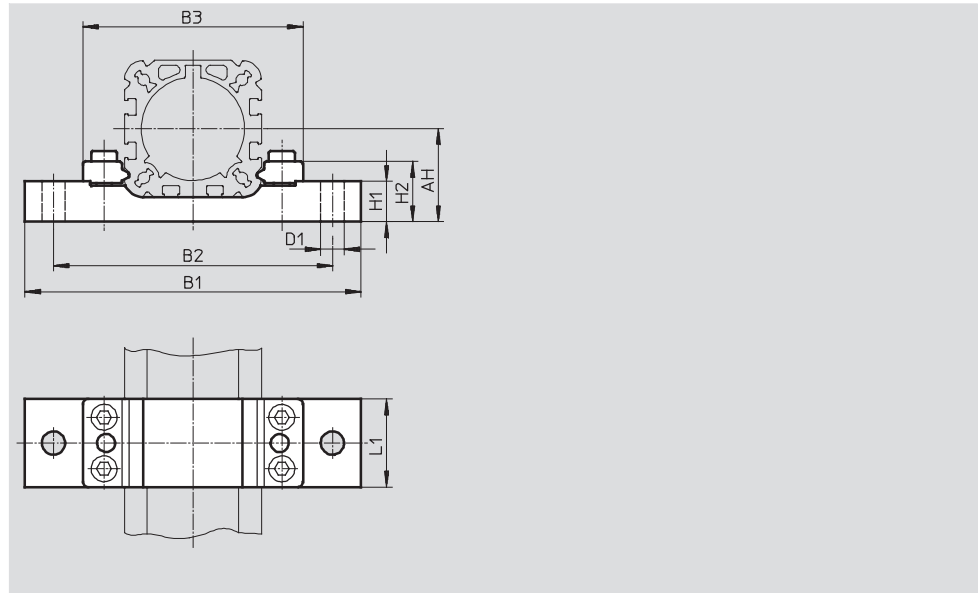

Dimensions and ordering data								
For size	AH	B1	B2	B3	D1	H1	H2	L1
[mm]					∅			
32	32	100	84	66.1	6.6	17.5	26.1	32
40	36	130	108	85.2	9	15.7	23.3	34
63	50	150	128	104.8	9	22.9	30.4	41

For size	CRC ¹⁾	Weight	Part No.	Type
[mm]		[g]		
32	1	175	1098473	EAHF-V1-32-P
40	1	230	1098478	EAHF-V1-40-P
63	1	400	1098481	EAHF-V1-63-P

1) Corrosion resistance class 1 according to Festo standard 940 070

Components subject to low corrosion stress. Transport and storage protection. Parts that do not have primarily decorative surface requirements, e.g. in internal areas that are not visible or behind covers.

Electric cylinders DNCE, with spindle drive

Accessories



Foot mounting HNC/CRHNC,
for parallel motor mounting

Material:
HNC: Galvanised steel
CRHNC: High-alloy steel

Free of copper and PTFE

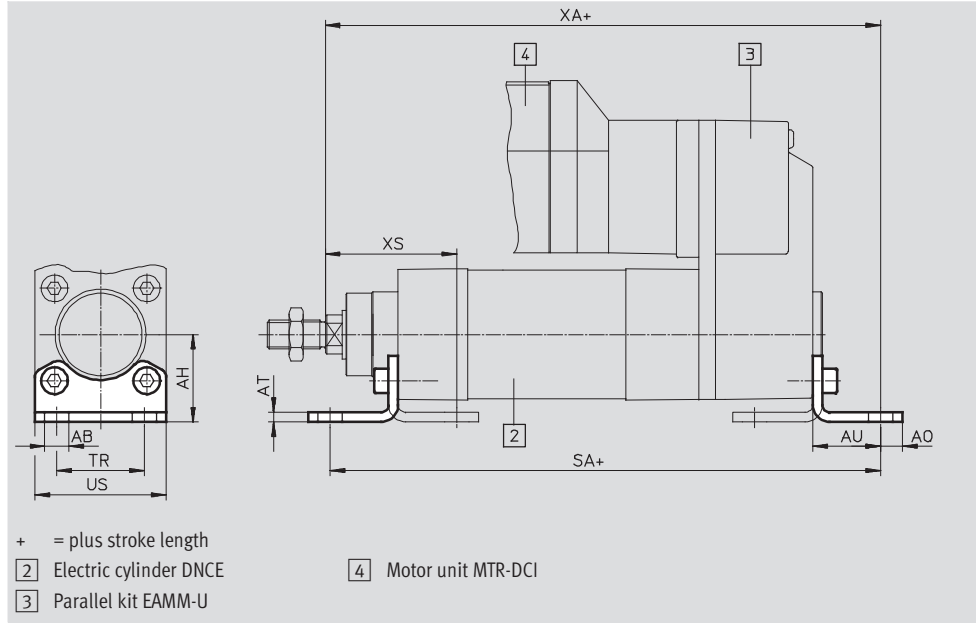

Dimensions and ordering data										
For size	AB	AH	AO	AT	AU	SA	TR	US	XA	XS
[mm]	∅									
32	7	32	6.5	4	24	210	32	45	212	46
40	10	36	9	4	28	249.5	36	54	251.5	54
63	10	50	12.5	5	32	299	50	75	304	64

For size	Basic version				High corrosion protection			
	CRC ¹⁾	Weight [g]	Part No.	Type	CRC ¹⁾	Weight [g]	Part No.	Type
[mm]								
32	2	144	174369	HNC-32	4	139	176937	CRHNC-32
40	2	193	174370	HNC-40	4	188	176938	CRHNC-40
63	2	436	174372	HNC-63	4	424	176940	CRHNC-63

1) Corrosion resistance class 2 according to Festo standard 940 070
 Components subject to moderate corrosion stress. Externally visible parts with primarily decorative surface requirements which are in direct contact with a normal industrial environment or media such as coolants or lubricating agents.
 Corrosion resistance class 4 according to Festo standard 940 070
 Components subject to particularly high corrosion stress. Parts used with aggressive media, e.g. in the food or chemical industry. These applications should be supported with special tests with the media if required.

Electric cylinders DNCE, with spindle drive

Accessories

Flange mounting FNC/CRFNG

Material:
 FNC: Galvanised steel
 CRFNG: High-alloy steel

Free of copper and PTFE
 RoHS-compliant

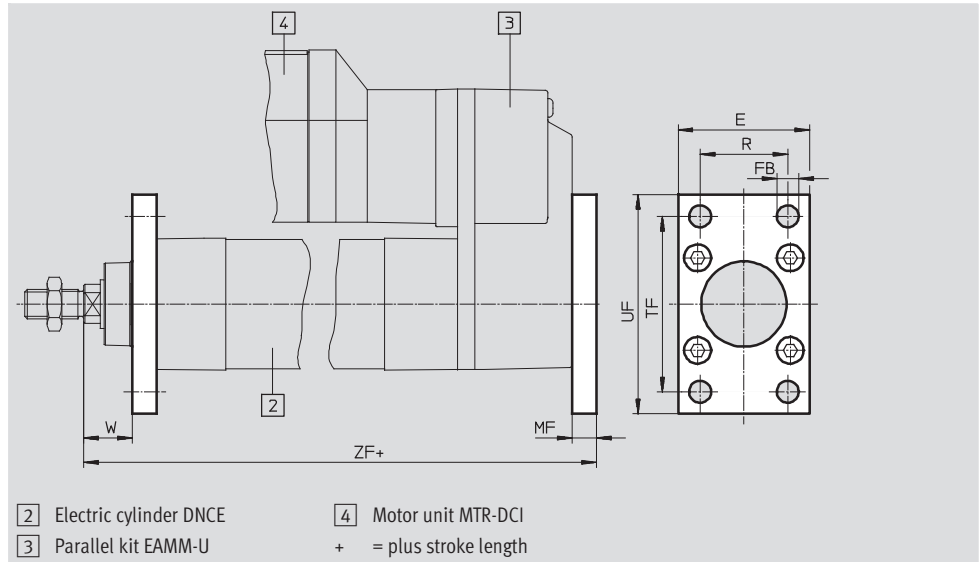

Dimensions and ordering data								
For size	E	FB ∅ H13	MF	R	TF	UF	W	ZF
[mm]								
32	45	7	10	32	64	80	16	198
40	54	9	10	36	72	90	20	233.5
63	75	9	12	50	100	120	25	284

For size [mm]	Basic version				High corrosion protection			
	CRC ¹⁾	Weight [g]	Part No.	Type	CRC ¹⁾	Weight [g]	Part No.	Type
32	1	221	174376	FNC-32	4	225	161846	CRFNG-32
40	1	291	174377	FNC-40	4	300	161847	CRFNG-40
63	1	679	174379	FNC-63	4	680	161849	CRFNG-63

1) Corrosion resistance class 1 according to Festo standard 940 070
 Components subject to low corrosion stress. Transport and storage protection. Parts that do not have primarily decorative surface requirements, e.g. in internal areas that are not visible or behind covers.
 Corrosion resistance class 4 according to Festo standard 940 070
 Components subject to particularly high corrosion stress. Parts used with aggressive media, e.g. in the food or chemical industry. These applications should be supported with special tests with the media if required.

Electric cylinders DNCE, with spindle drive

Accessories



Trunnion flange ZNCF/CRZNG

Material:
 ZNCF: Stainless steel casting
 CRZNG: Electropolished stainless steel casting

Free of copper and PTFE
 RoHS-compliant

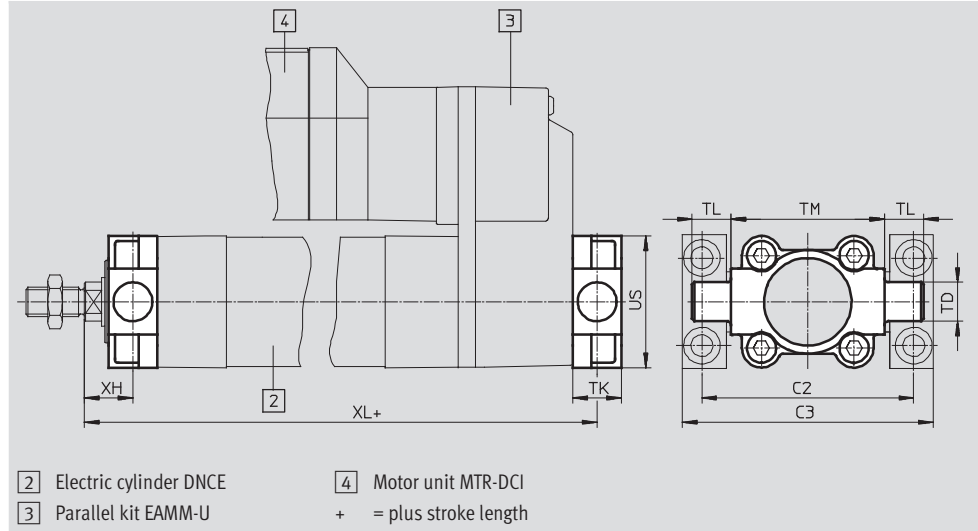

Dimensions and ordering data

For size	C2	C3	TD ∅ e9	TK	TL	TM	US	XH	XL
[mm]									
32	71	86	12	16	12	50	45	18	196
40	87	105	16	20	16	63	54	20	233.5
63	116	136	20	24	20	90	75	25	284

For size [mm]	Basic version				High corrosion protection			
	CRC ¹⁾	Weight [g]	Part No.	Type	CRC ¹⁾	Weight [g]	Part No.	Type
32	2	150	174411	ZNCF-32	4	150	161852	CRZNG-32
40	2	285	174412	ZNCF-40	4	285	161853	CRZNG-40
63	2	687	174414	ZNCF-63	4	687	161855	CRZNG-63

1) Corrosion resistance class 2 according to Festo standard 940 070
 Components subject to moderate corrosion stress. Externally visible parts with primarily decorative surface requirements which are in direct contact with a normal industrial environment or media such as coolants or lubricating agents.
 Corrosion resistance class 4 according to Festo standard 940 070
 Components subject to particularly high corrosion stress. Parts used with aggressive media, e.g. in the food or chemical industry. These applications should be supported with special tests with the media if required.

Electric cylinders DNCE, with spindle drive

Accessories

Trunnion support LNZG

Materials:

Trunnion support: Anodised aluminium

Plain bearing: Plastic

Free of copper and PTFE

RoHS-compliant

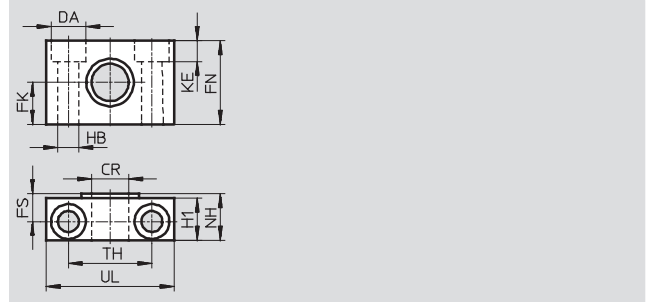
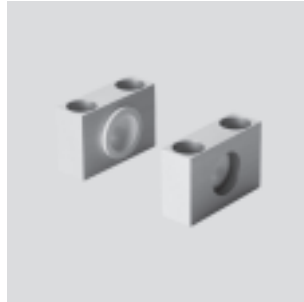

Dimensions and ordering data														Weight	Part No.	Type
For size	CR	DA	FK	FN	FS	H1	HB	KE	NH	TH	UL	CRC ¹⁾	Weight	Part No.	Type	
[mm]	∅ D11	∅ H13	±0.1				∅ H13			±0.2			[g]			
32	12	11	15	30	10.5	15	6.6	6.8	18	32	46	2	83	32959	LNZG-32	
40	16	15	18	36	12	18	9	9	21	36	55	2	129	32960	LNZG-40/50	
63	20	18	20	40	13	20	11	11	23	42	65	2	178	32961	LNZG-63/80	

Trunnion support CRLNZG

Material:

High-alloy steel

Free of copper and PTFE

RoHS-compliant

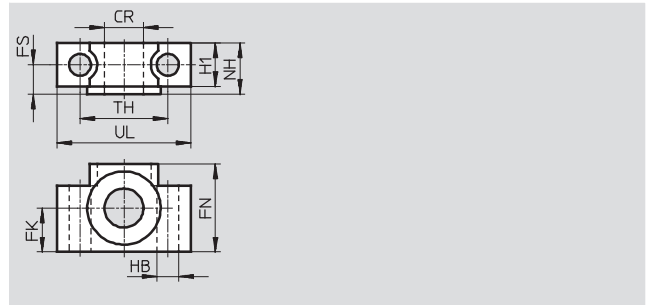
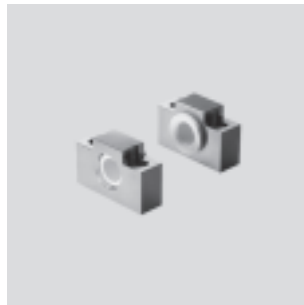

Dimensions and ordering data														Weight	Part No.	Type
For size	CR	FK	FN	FS	H1	HB	NH	TH	UL	CRC ¹⁾	Weight	Part No.	Type			
[mm]	∅ D11	∅ ±0.1				∅ H13		±0.2			[g]					
32	12	15	30	10.5	15	6.6	18	32	46	4	205	161874	CRLNZG-32			
40	16	18	36	12	18	9	21	36	55	4	323	161875	CRLNZG-40/50			
63	20	20	40	13	20	11	23	42	65	4	435	161876	CRLNZG-63/80			

1) Corrosion resistance class 2 according to Festo standard 940 070
 Components subject to moderate corrosion stress. Externally visible parts with primarily decorative surface requirements which are in direct contact with a normal industrial environment or media such as coolants or lubricating agents.
 Corrosion resistance class 4 according to Festo standard 940 070
 Components subject to particularly high corrosion stress. Parts used with aggressive media, e.g. in the food or chemical industry. These applications should be supported with special tests with the media if required.

Electric cylinders DNCE, with spindle drive

Accessories



Swivel flange SNC

Material:
Die-cast aluminium

Free of copper and PTFE
RoHS-compliant

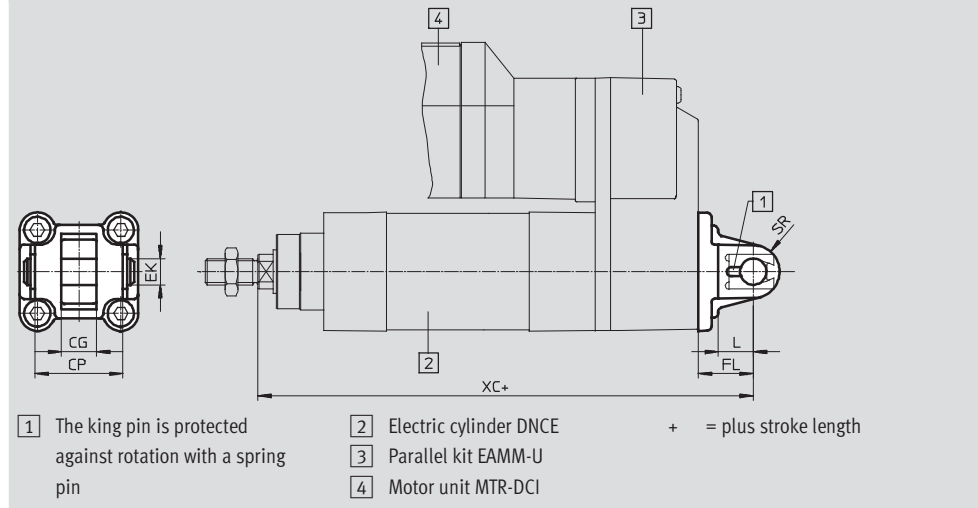

Dimensions and ordering data											
For size	CG	CP	EK ∅	FL	L	SR	XC	CRC ¹⁾	Weight	Part No.	Type
[mm]	H14	h14		±0.2					[g]		
32	14	34	10	22	13	10	210	2	90	174383	SNC-32
40	16	40	12	25	16	12	248.5	2	120	174384	SNC-40
63	21	51	16	32	21	16	304	2	320	174386	SNC-63

Swivel flange SNCS

Material:
Die-cast aluminium

Free of copper and PTFE
RoHS-compliant

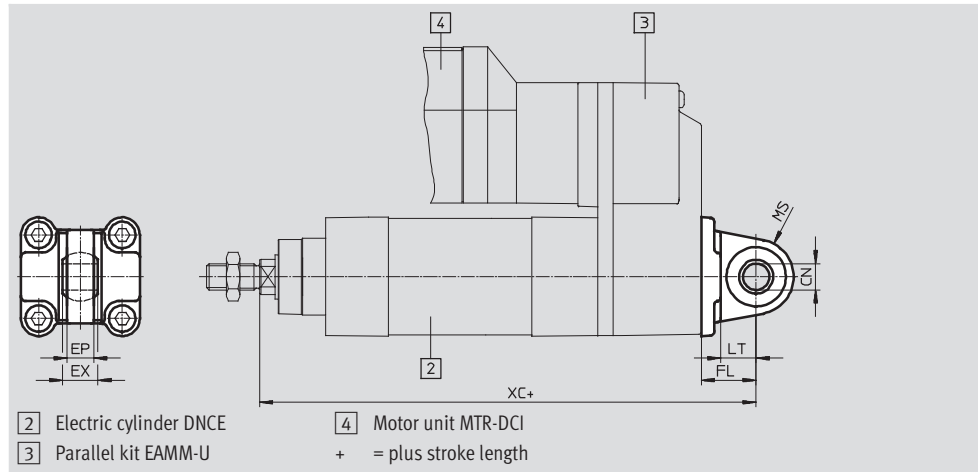
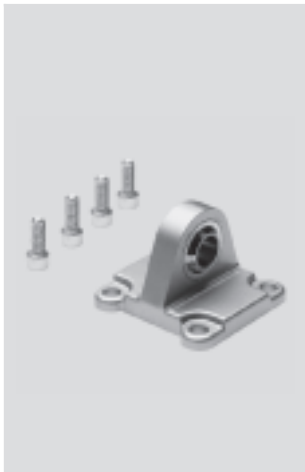

Dimensions and ordering data											
For size	CN ∅	EP	EX	FL	LT	MS	XC	CRC ¹⁾	Weight	Part No.	Type
[mm]	H7	+0.2		±0.2					[g]		
32	10	10.5	14	22	13	15	210	2	85	174397	SNCS-32
40	12	12	16	25	16	17	248.5	2	125	174398	SNCS-40
63	16	15	21	32	21	22	304	2	280	174400	SNCS-63

1) Corrosion resistance class 2 according to Festo standard 940 070
Components subject to moderate corrosion stress. Externally visible parts with primarily decorative surface requirements which are in direct contact with a normal industrial environment or media such as coolants or lubricating agents.

Electric cylinders DNCE, with spindle drive

Accessories

Swivel flange SNCL

Material:
Die-cast aluminium

Free of copper and PTFE
RoHS-compliant

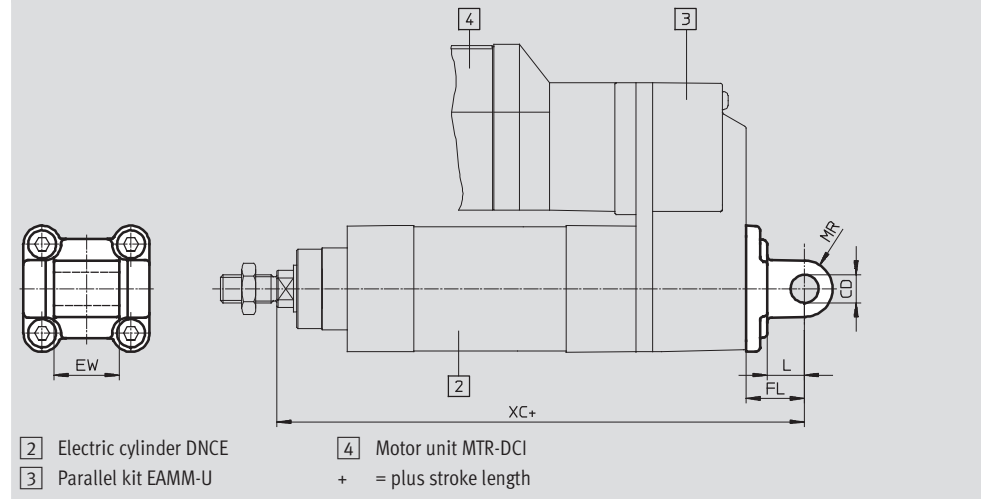

Dimensions and ordering data										
For size	CD	EW	FL	L	MR	XC	CRC ¹⁾	Weight	Part No.	Type
[mm]	∅ H9	h12	±0.2					[g]		
32	10	26	22	13	10	210	2	75	174404	SNCL-32
40	12	28	25	16	12	248.5	2	100	174405	SNCL-40
63	16	40	32	21	16	304	2	250	174407	SNCL-63

1) Corrosion resistance class 2 according to Festo standard 940 070
 Components subject to moderate corrosion stress. Externally visible parts with primarily decorative surface requirements which are in direct contact with a normal industrial environment or media such as coolants or lubricating agents.

Electric cylinders DNCE, with spindle drive

Accessories



Swivel flange
SNCB/SNCB-...-R3

Material:
SNCB: Die-cast aluminium
SNCB-...-R3: Die-cast aluminium with protective coating, high corrosion protection

Free of copper and PTFE
RoHS-compliant

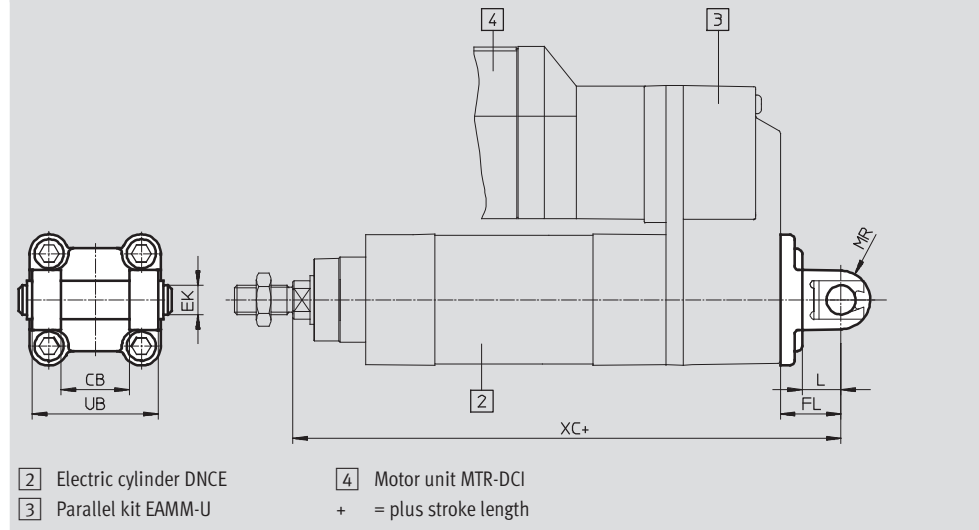

Dimensions and ordering data							
For size	CB	EK	FL	L	MR	UB	XC
[mm]	H14	∅ e8	±0.2			h14	
32	26	10	22	13	10	45	210
40	28	12	25	16	12	52	248.5
63	40	16	32	21	16	70	304

For size	Basic version				Variant R3 – High corrosion protection			
	CRC ¹⁾	Weight [g]	Part No.	Type	CRC ¹⁾	Weight [g]	Part No.	Type
32	2	103	174390	SNCB-32	3	100	176944	SNCB-32-R3
40	2	155	174391	SNCB-40	3	151	176945	SNCB-40-R3
63	2	375	174393	SNCB-63	3	371	176947	SNCB-63-R3

1) Corrosion resistance class 2 according to Festo standard 940 070
Components subject to moderate corrosion stress. Externally visible parts with primarily decorative surface requirements which are in direct contact with a normal industrial environment or media such as coolants or lubricating agents.
Corrosion resistance class 3 according to Festo standard 940 070
Components subject to high corrosion stress. Externally visible parts with primarily decorative surface requirements which are in direct contact with a normal industrial environment or media such as solvents and cleaning agents.

Electric cylinders DNCE, with spindle drive

Accessories

Trunnion mounting kit ZNCM

Material:
Galvanised steel
Free of copper and PTFE

The mounting kit can be attached at any position along the profile barrel of a cylinder.
The trunnion mounting kit cannot be

mounted in the vicinity of the motor when used in combination with the parallel kit EAMM-U.

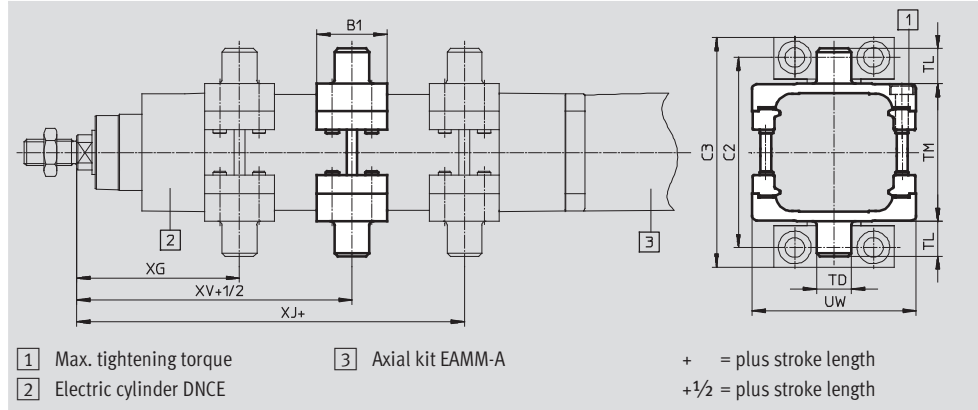

Dimensions and ordering data								
For size	B1	C2	C3	TD	TL	TM	UW	XG
[mm]				∅ e9				
32	30	71	86	12	12	50	65	65
40	32	87	105	16	16	63	75	74.5
63	41	116	136	20	20	90	105	91.5

For size	XJ	XV	Max. tightening torque	CRC ¹⁾	Weight	Part No.	Type
[mm]			[Nm]		[g]		
32	107	86	4+1	2	224	163525	ZNCM-32
40	130.5	102.5	8+1	2	396	163526	ZNCM-40
63	157.5	124.5	18+2	2	931	163528	ZNCM-63

1) Corrosion resistance class 2 according to Festo standard 940 070
Components subject to moderate corrosion stress. Externally visible parts with primarily decorative surface requirements which are in direct contact with a normal industrial environment or media such as coolants or lubricating agents.





Ordering data – Mounting attachments				Technical data → Internet: clevis foot			
Designation	For size	Part No.	Type	Designation	For size	Part No.	Type
Clevis foot LNG				Clevis foot LSN			
	32	33890	LNG-32		32	5561	LSN-32
	40	33891	LNG-40		40	5562	LSN-40
	63	33893	LNG-63		63	5564	LSN-63
Clevis foot LSNG				Clevis foot LSNSG			
	32	31740	LSNG-32		32	31747	LSNSG-32
	40	31741	LSNG-40		40	31748	LSNSG-40
	63	31743	LSNG-63		63	31750	LSNSG-63
Clevis foot LBG				Right-angle clevis foot LQG			
	32	31761	LBG-32		32	31768	LQG-32
	40	31762	LBG-40		40	31769	LQG-40
	63	31764	LBG-63		63	31771	LQG-63

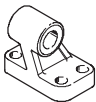

Electric cylinders DNCE, with spindle drive

Accessories

FESTO

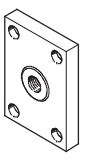
Ordering data – Mounting attachments, corrosion-resistant			Technical data → Internet: clevis foot	
Designation	For size	Part No.	Type	
Clevis foot CRLNG				
	32	161840	CRLNG-32	
	40	161841	CRLNG-40	
	63	161843	CRLNG-63	

Ordering data – Piston rod attachments				Technical data → Internet: piston rod attachment			
Designation	For size	Part No.	Type	Designation	For size	Part No.	Type
Rod eye SGS				Rod clevis SGA			
	32	9261	SGS-M10x1,25		32	32954	SGA-M10x1,25
	40	9262	SGS-M12x1,25		40	10767	SGA-M12x1,25
	63	9263	SGS-M16x1,5		63	10768	SGA-M16x1,5
Rod clevis SG				Self-aligning rod coupler FK			
	32	6144	SG-M10x1,25		32	6140	FK-M10x1,25
	40	6145	SG-M12x1,25		40	6141	FK-M12x1,25
	63	6146	SG-M16x1,5		63	6142	FK-M16x1,5
Coupling piece KSZ							
	32	36125	KSZ-M10x1,25				
	40	36126	KSZ-M12x1,25				
	63	36127	KSZ-M16x1,5				

Ordering data – Piston rod attachments, corrosion-resistant				Technical data → Internet: piston rod attachment			
Designation	For size	Part No.	Type	Designation	For size	Part No.	Type
Rod eye CRSGS				Rod clevis CRSG			
	32	195582	CRSGS-M10x1,25		32	13569	CRSG-M10x1,25
	40	195583	CRSGS-M12x1,25		40	13570	CRSG-M12x1,25
	63	195584	CRSGS-M16x1,5		63	13571	CRSG-M16x1,5

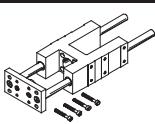
Ordering data – Guide units for fixed strokes (recirculating ball bearing guide only)				Technical data → Internet: feng			
	Stroke [mm]	Part No.	Type	Stroke [mm]	Part No.	Type	
	For size 32			For size 40			
	10 ... 100	34494	FENG-32-100-KF	10 ... 100	34500	FENG-40-100-KF	
	10 ... 200	34496	FENG-32-200-KF	10 ... 200	34502	FENG-40-200-KF	
	10 ... 320	34497	FENG-32-320-KF	10 ... 320	34504	FENG-40-320-KF	
	10 ... 400	150290	FENG-32-400-KF	10 ... 400	150291	FENG-40-400-KF	
	10 ... 500	34498	FENG-32-500-KF	10 ... 500	34505	FENG-40-500-KF	
	For size 63						
	10 ... 100	34514	FENG-63-100-KF				
	10 ... 200	34516	FENG-63-200-KF				
	10 ... 320	34518	FENG-63-320-KF				
	10 ... 400	34519	FENG-63-400-KF				
	10 ... 500	34520	FENG-63-500-KF				

Electric cylinders DNCE, with spindle drive

Accessories

FESTO

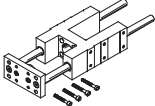
Ordering data – Guide units for variable strokes					Technical data → Internet: feng	
	For size [mm]	Stroke [mm]	With recirculating ball bearing guide		With plain-bearing guide	
			Part No.	Type	Part No.	Type
	32	10 ... 500	34487	FENG-32-...-KF	34481	FENG-32-...
	40	10 ... 500	34488	FENG-40-...-KF	34482	FENG-40-...
	63	10 ... 500	34490	FENG-63-...-KF	34484	FENG-63-...



Ordering data – Compensating elements in combination with guide unit FENG			
Designation	For size	Part No.	Type
	32	570305	EADC-V1-32
	40	570306	EADC-V1-40
	63	570307	EADC-V1-50/63

Permissible proximity sensors in combination with motor units MTR-DCI

Ordering data – Proximity sensors for T-slot, magneto-resistive						Technical data → Internet: smt	
	Type of mounting	Switching output	Electrical connection	Cable length [m]	Part No.	Type	
N/O contact							
	Insertable in the slot from above, flush with cylinder profile, short design	PNP	Plug M8x1, 3-pin	0.3	574334	SMT-8M-A-PS-24V-E-0,3-M8D	

Permissible proximity sensors in combination with servo motors EMMS-AS, stepper motors EMMS-ST or guide units FENG

Ordering data – Proximity sensors for T-slot, magneto-resistive						Technical data → Internet: smt	
	Type of mounting	Switching output	Electrical connection	Cable length [m]	Part No.	Type	
N/O contact							
	Insertable in the slot from above, flush with cylinder profile, short design	PNP	Cable, 3-wire	2.5	574335	SMT-8M-A-PS-24V-E-2,5-OE	

Ordering data – Proximity sensors for T-slot, magnetic reed						Technical data → Internet: sme	
	Type of mounting	Switching output	Electrical connection	Cable length [m]	Part No.	Type	
N/O contact							
	Insertable in the slot from above, flush with the cylinder profile	Contacting	Cable, 3-wire	2.5	543862	SME-8M-DS-24V-K-2,5-OE	
				5.0	543863	SME-8M-DS-24V-K-5,0-OE	
	Insertable in the slot lengthwise, flush with the cylinder profile	Contacting	Cable, 3-wire	2.5	150855	SME-8-K-LED-24	

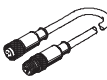
Ordering data – Connecting cable					Technical data → Internet: km8	
	Assembly	Connection	Cable length [m]	Part No.	Type	
Straight socket						
	Union nut M8, both ends	3-pin	0.5	175488	KM8-M8-GSGD-0,5	
			1	175489	KM8-M8-GSGD-1	
			2.5	165610	KM8-M8-GSGD-2,5	
			5	165611	KM8-M8-GSGD-5	

Ordering data – Slot cover for T-slot				
	Assembly	Length	Part No.	Type
	Insertable from above	2x 0.5 m	151680	ABP-5-S

Product Range and Company Overview

A Complete Suite of Automation Services

Our experienced engineers provide complete support at every stage of your development process, including: conceptualization, analysis, engineering, design, assembly, documentation, validation, and production.



Custom Automation Components
Complete custom engineered solutions



Custom Control Cabinets
Comprehensive engineering support and on-site services

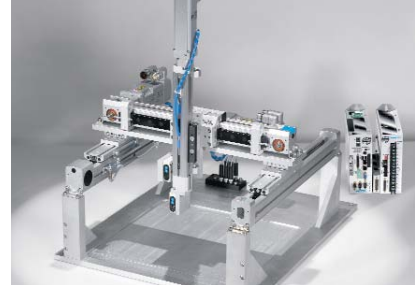

Complete Systems
Shipment, stocking and storage services

The Broadest Range of Automation Components

With a comprehensive line of more than 30,000 automation components, Festo is capable of solving the most complex automation requirements.



Electromechanical
Electromechanical actuators, motors, controllers & drives



Pneumatics
Pneumatic linear and rotary actuators, valves, and air supply



PLCs and I/O Devices
PLC's, operator interfaces, sensors and I/O devices

Supporting Advanced Automation... As No One Else Can!

Festo is a leading global manufacturer of pneumatic and electromechanical systems, components and controls for industrial automation, with more than 12,000 employees in 56 national headquarters serving more than 180 countries. For more than 80 years, Festo has continuously elevated the state of manufacturing with innovations and optimized motion control solutions that deliver higher performing, more profitable automated manufacturing and processing equipment. Our dedication to the advancement of automation extends beyond technology to the education and development of current and future automation and robotics designers with simulation tools, teaching programs, and on-site services.

Quality Assurance, ISO 9001 and ISO 14001 Certifications

Festo Corporation is committed to supply all Festo products and services that will meet or exceed our customers' requirements in product quality, delivery, customer service and satisfaction.

To meet this commitment, we strive to ensure a consistent, integrated, and systematic approach to management that will meet or exceed the requirements of the ISO 9001 standard for Quality Management and the ISO 14001 standard for Environmental Management.



© Copyright 2008, Festo Corporation. While every effort is made to ensure that all dimensions and specifications are correct, Festo cannot guarantee that publications are completely free of any error, in particular typing or printing errors. Accordingly, Festo cannot be held responsible for the same. For Liability and Warranty conditions, refer to our "Terms and Conditions of Sale", available from your local Festo office. All rights reserved. No part of this publication may be reproduced, distributed, or transmitted in any form or by any means, electronic, mechanical, photocopying or otherwise, without the prior written permission of Festo. All technical data subject to change according to technical update.



Printed on recycled paper at New Horizon Graphic, Inc., FSC certified as an environmentally friendly printing plant.

Festo North America

Festo Regional Contact Center

5300 Explorer Drive
Mississauga, Ontario L4W 5G4
Canada

USA Customers:

For ordering assistance,

Call: 1.800.99.FESTO (1.800.993.3786)

Fax: 1.800.96.FESTO (1.800.963.3786)

Email: customer.service@us.festo.com

For technical support,

Call: 1.866.GO.FESTO (1.866.463.3786)

Fax: 1.800.96.FESTO (1.800.963.3786)

Email: product.support@us.festo.com

Canadian Customers:

Call: 1.877.GO.FESTO (1.877.463.3786)

Fax: 1.877.FX.FESTO (1.877.393.3786)

Email: festo.canada@ca.festo.com

USA Headquarters

Festo Corporation
395 Moreland Road
P.O. Box 18023
Hauppauge, NY 11788, USA
www.festo.com/us

USA Sales Offices

Appleton

North 922 Tower View Drive, Suite N
Greenville, WI 54942, USA

Boston

120 Presidential Way, Suite 330
Woburn, MA 01801, USA

Chicago

1441 East Business Center Drive
Mt. Prospect, IL 60056, USA

Dallas

1825 Lakeway Drive, Suite 600
Lewisville, TX 75057, USA

Detroit – Automotive Engineering Center

2601 Cambridge Court, Suite 320
Auburn Hills, MI 48326, USA

New York

395 Moreland Road
Hauppauge, NY 11788, USA

Silicon Valley

4935 Southfront Road, Suite F
Livermore, CA 94550, USA

United States



USA Headquarters, East: Festo Corp., 395 Moreland Road, Hauppauge, NY 11788

Phone: 1.631.435.0800; Fax: 1.631.435.8026;

Email: info@festo-usa.com

www.festo.com/us

Canada



Headquarters: Festo Inc., 5300 Explorer Drive, Mississauga, Ontario L4W 5G4

Phone: 1.905.624.9000; Fax: 1.905.624.9001;

Email: festo.canada@ca.festo.com

www.festo.ca

Mexico



Headquarters: Festo Pneumatic, S.A., Av. Ceylán 3, Col. Tequesquahuac,
54020 Tlalneantla, Edo. de México

Phone: 011 52 [55] 53 21 66 00; Fax: 011 52 [55] 53 21 66 65;

Email: festo.mexico@mx.festo.com

www.festo.com/mx

Central USA

Festo Corporation
1441 East Business
Center Drive
Mt. Prospect, IL 60056, USA
Phone: 1.847.759.2600
Fax: 1.847.768.9480



Western USA

Festo Corporation
4935 Southfront Road,
Suite F
Livermore, CA 94550, USA
Phone: 1.925.371.1099
Fax: 1.925.245.1286



Festo Worldwide

Argentina Australia Austria Belarus Belgium Brazil Bulgaria Canada Chile China Colombia Croatia Czech Republic Denmark
Estonia Finland France Germany Great Britain Greece Hong Kong Hungary India Indonesia Iran Ireland Israel Italy Japan Latvia
Lithuania Malaysia Mexico Netherlands New Zealand Norway Peru Philippines Poland Romania Russia Serbia Singapore
Slovakia Slovenia South Africa South Korea Spain Sweden Switzerland Taiwan Thailand Turkey Ukraine United States Venezuela

www.festo.com