

Control block VOFA with safety function



Control block VOFA with safety function

Key features

FESTO

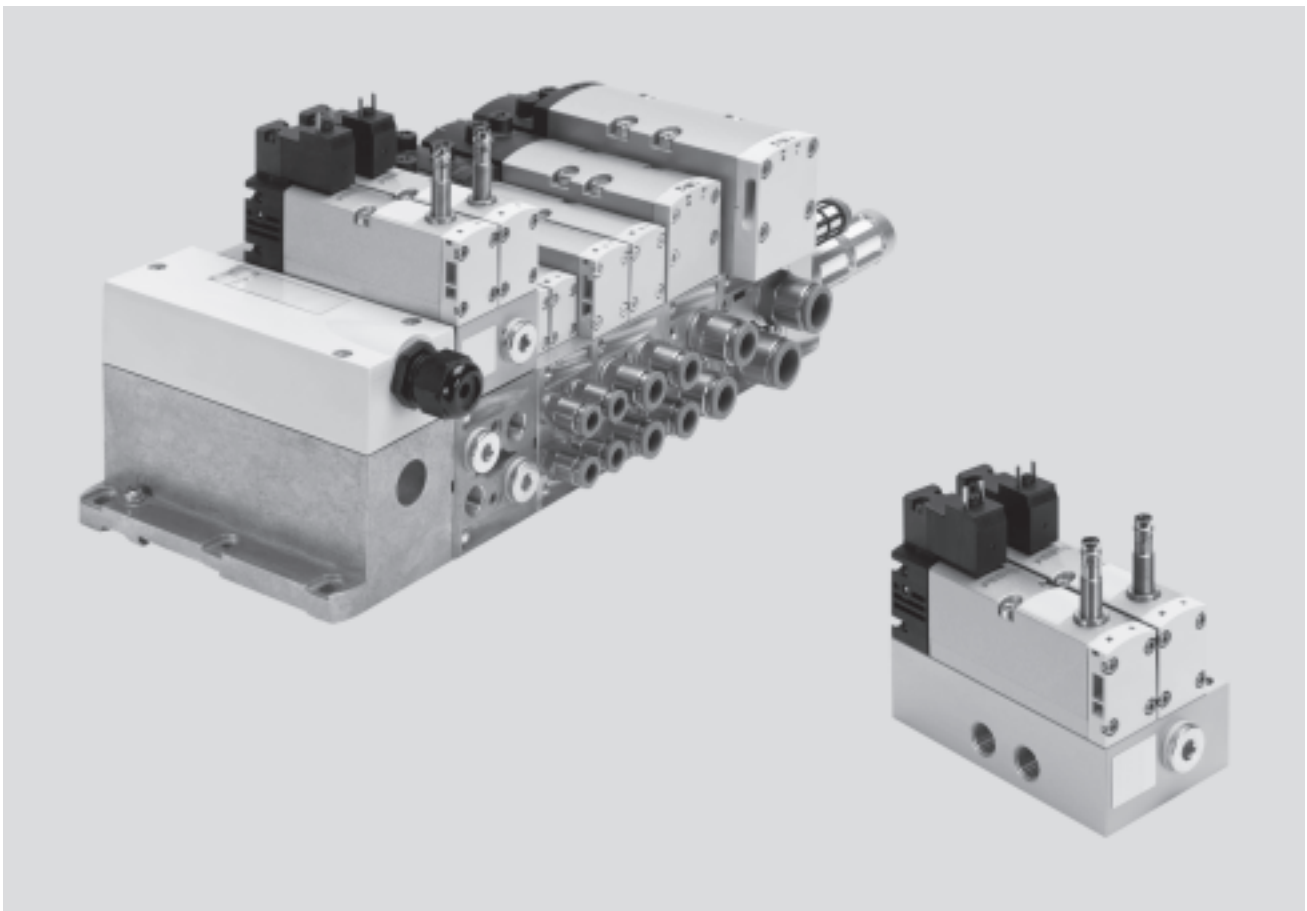

Innovative

- Can be used as a press safety valve for safe reversing of a hazardous movement (5/2-way solenoid valve)
- Purely mechanical solution as a press safety valve, without integrated diagnostics

Versatile

- Control block can be selected as version for valve terminal VTSA/VTSA-F
- Control block can be selected as individual pneumatic connection
- High pressure range of 3 ... 10 bar
- Flow rates of up to 950 l/min

Reliable

- Sturdy and durable metal components
- Designed as a purely mechanical solution with regard to safety

Easy to mount

- Ready-to-install and tested unit
- Lower selection, ordering, installation and commissioning costs
- Mounting via through-hole (with individual pneumatic connection)
- Mounting as sandwich construction on manifold sub-base of the valve terminal

Note

The control block as a decentralised individual connection variant must not be converted to a 3/2-way solenoid valve function by the customer without authorisation as this

invalidates the IFA approval. An IFA certificate is linked to the certified safety function of the component.

Control block VOFA with safety function

Key features

Description			
<p>The control block is designed for two-channel actuation of pneumatic drive components such as double-acting cylinders and can be used to realise the following safety measures:</p> <ul style="list-style-type: none"> • Protection against unexpected start-up (EN 1037) • Reversing hazardous movements provided the reversing movement will not lead to any further hazards (with 5/2-way single solenoid valve function) 	<p>The control attributes of the control block enable Performance Level e (up to Category 4, corresponds to the highest risk level) to be achieved for the safety measures. The Performance Level (PL) is a measure of the reliability of a safety function. The control block has been developed and manufactured in accordance with the basic and proven safety principles of EN ISO 13849-1 and EN ISO 13849-2.</p>	<p>The requirements of EN ISO 13849-1 and EN ISO 13849-2 (e.g. CCF, DC) must be taken into consideration for implementation and operation of the component and for use in higher categories (2 to 4). When using this product in machines or systems subject to specific C standards, the requirements specified in these standards must be observed.</p>	<p>The control block with safety function is designed for installation in machines and automation systems and must only be used in industrial applications (high-demand mode). The control block with safety function is suitable for use as a press safety valve to EN 962.</p> <p>Further information and technical data in the support portal → Internet: safety-related guidelines</p>

Pneumatic/electrical interlinking			
Function			
<p>The safety function is achieved through two-channel pneumatic interlinking of two single solenoid 5/2-way valves, width 26 mm, within the control block:</p> <ul style="list-style-type: none"> • Port 4 is only pressurised if both solenoid valves are in switching position. • Port 2 is always pressurised if at least one of the two solenoid valves is in normal position. The valve is reset via a mechanical spring. 	<p>The switching operation of the solenoid valves can be monitored by sensing the proximity sensor at the solenoid valves (switching position sensing). This is done by linking the control signal and signal change of the proximity sensor so that it is possible to check whether the piston spools of the solenoid valves are reaching or leaving the normal position (expectations).</p>	<p>The piston spools of the solenoid valves are designed so that pneumatic short circuits between ports 2 and 4 are ruled out (freedom from overlap). The two solenoid valves must be actuated via two independent channels in order to achieve the desired</p>	<p>Category 4 (Performance Level e, to EN ISO 13849-1).</p> <p>The valves used are always 2x 5/2-way solenoid valves. The function of a 3/2-way valve is achieved by sealing ports 2 and 3 with blanking plugs.</p>

Control block VOFA with safety function

Key features

FESTO

Version

Decentralised individual connection variant (VOFA-L26-...)

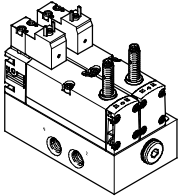

With the decentralised individual connection variant, the electrical connection for the control block is established as an individual connection to ISO 15407-1. The pneumatic connection is also established as an individual connection. With this variant, the two 5/2-way solenoid valves are pneumatically interlinked via two channels by means of the individual sub-base.

The electrical connection for the solenoid valves is established separately via a standardised square plug to EN 175301-803, type C. The piston position sensing feature of

the inductive PNP or NPN proximity sensor is realised using a push-in connector in the size M8x1 to EN 61076-2-104.

Version for valve terminal VTSA/VTSA-F (VOFA-B26-...)

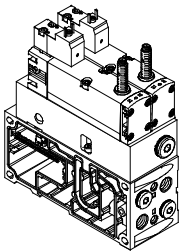

With the version of the control block for valve terminal VTSA/VTSA-F, the valves are actuated separately from the valve terminal via an individual electrical connection. The pneumatic connection is established via the valve terminal VTSA/VTSA-F. With the variant for valve terminals, the two 5/2-way solenoid valves are pneumatically interlinked via two channels by means of an intermediate plate in a sandwich construction.

The electrical connection for the solenoid valves is established separately via a standardised square plug to EN 175301-803, type C. The piston position sensing feature of

the inductive PNP or NPN proximity sensor is realised using a push-in connector in the size M8x1 to EN 61076-2-104.

Control block VOFA with safety function

Key features

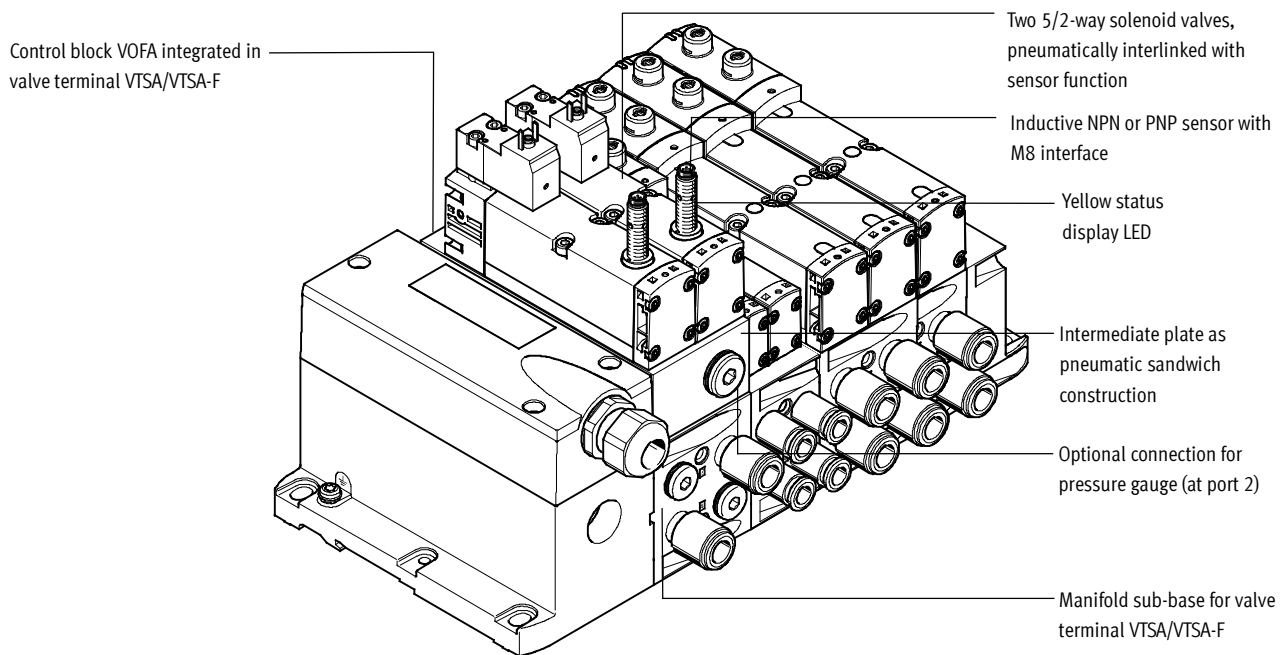

Equipment options

Control block for valve terminals

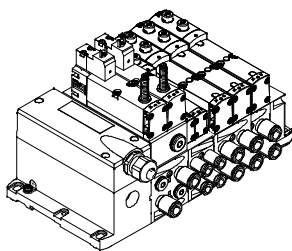

- 5/2-way solenoid valves, single solenoid, connected in series, interlinked via two channels
- Mechanical spring
 - Switching position sensing via inductive sensors with PNP or NPN output
 - Protection against unexpected start-up to EN 1037
 - Reversing

Application:

- Protection against unexpected start-up
- Safe reversing
- Drives in manually loaded devices

Control block as decentralised individual connection variant

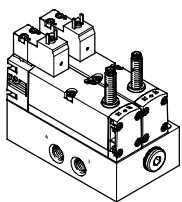

- 5/2-way solenoid valves, single solenoid, connected in series, interlinked via two channels
- Mechanical spring
 - Switching position sensing via inductive sensors with PNP or NPN output
 - Protection against unexpected start-up to EN 1037
 - 5/2-way solenoid valves, reversing

Application:

- 5/2-way solenoid valves, single solenoid, connected in series, interlinked via two channels
- Protection against unexpected start-up
 - Drives in manually loaded devices
 - 5/2-way solenoid valves, safe reversing



Note

The control block as a decentralised individual connection variant must not be converted to a 3/2-way solenoid valve function by the customer without authorisation as this invalidates the IFA approval. An IFA certificate is linked to the certified safety function of the component.

Control block VOFA with safety function

Key features

Special features	
Control block for valve terminals VTSA/VTSA-F	Control block as decentralised individual connection variant
<p>Electrical connection</p> <ul style="list-style-type: none"> • Electrical connection to EN 175301-803, type C (square plug) • 3-pin sensor push-in connector M8 	<p>Pneumatic connection</p> <ul style="list-style-type: none"> • Via valve terminal VTSA/VTSA-F • Pilot air supply via valve terminal • Interlinked via two channels with intermediate plate in sandwich construction (output 2 is parallel, output 4 is connected in series)
<p>Electrical connection</p> <ul style="list-style-type: none"> • Electrical connection to EN 175301-803, type C (square plug) • 3-pin sensor push-in connector M8 	<p>Pneumatic connection</p> <ul style="list-style-type: none"> • Individual pneumatic connection • Internal pilot air supply • Interlinked via two channels with individual sub-base (output 2 is parallel, output 4 is connected in series)

Applications	
This control block is suitable for use as a press safety valve to EN 962.	This valve is a safety component in accordance with the Machinery Directive 2006/42/EC.

Valve terminal configurator		→ Internet: www.festo.com	
<p>A valve terminal configurator is available to help you select a suitable VTSA/VTSA-F valve terminal. The control block VOFA for the valve terminal is ordered using this valve terminal configurator. This makes it much easier to order the right product.</p>	<p>The valve terminals are fully assembled according to your order specification and are individually tested. This reduces assembly and installation time to a minimum.</p>	<p>You order a control block VOFA for the valve terminal VTSA using the order code:</p> <p>Ordering system for VTSA → Internet: vtsa</p>	<p>You order a control block VOFA for the valve terminal VTSA-F using the order code:</p> <p>Ordering system for VTSA-F → Internet: vtsa-f</p>

Control block VOFA with safety function

Key features

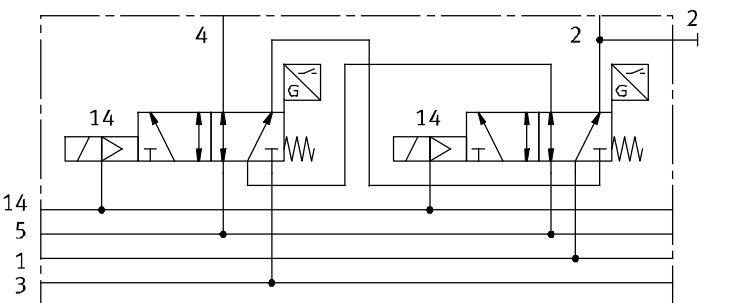
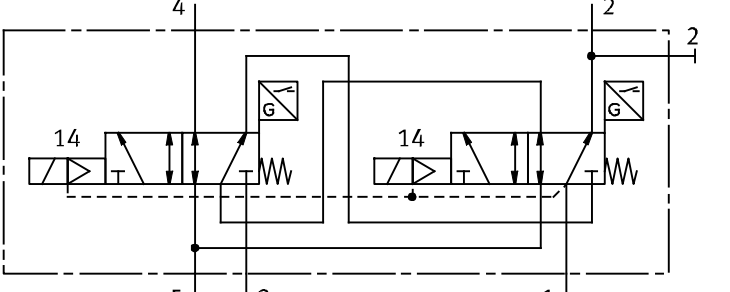
Valve function	Description
<p>Circuit symbol¹⁾</p> 	<p>Control block VOFA-B26-T52-... for valve terminal VTSA/VTSA-F with 2x 5/2-way solenoid valve, single solenoid</p> <ul style="list-style-type: none"> • Pneumatic connection via valve terminal • Mechanical spring return • With NPN sensor (code SN) or PNP sensor (code SP) • Fulfils the safety function <ul style="list-style-type: none"> - Safe reversing - Protection against unexpected start-up (EN 1037)
	<p>Control block VOFA-L26-T52-... as decentralised individual connection variant with 2x 5/2-way valve, single solenoid</p> <ul style="list-style-type: none"> • As individual pneumatic connection • Mechanical spring return • With NPN or PNP sensor • Fulfils the safety function <ul style="list-style-type: none"> - Safe reversing - Protection against unexpected start-up (EN 1037)

1) The symbol represents a valve with a proximity sensor with a switching output signal, in the illustration an N/O contact. In accordance with ISO 1219-1, this symbol applies to both N/O contacts as well as N/C contacts. The switching element function of all sensors used here is an N/C contact.

-  - Note

- The 2x 5/2-way solenoid valves each have their own electrical connection.
- The 2x 5/2-way solenoid valves are pneumatically interlinked via two channels by means of an individual sub-base/intermediate plate (output 2 is parallel, output 4 is connected in series).

Control block VOFA with safety function

Technical data

Safety-related characteristics		
Control block	VOFA-L26-T52-...	VOFA-B26-T52-... on valve terminal
Conforms to	EN 13849-1	
Safety function	Security against manipulation, protection against unexpected start-up (up to Category 4, Performance Level e) Reversing of a movement	
Performance Level (PL)	Security against manipulation, protection against unexpected start-up (up to Category 4, Performance Level e)	
Reliable component	Yes	
Note on forced checking procedure	Switching frequency at least 1/week	
Certificate issuing authority	IFA 1001179	
CE marking (see declaration of conformity)	To EU Machinery Directive To EU EMC Directive ¹⁾	
Max. positive test pulse with 0 signal ²⁾	[μs]	1,000
Max. negative test pulse with 1 signal ²⁾	[μs]	800
Shock resistance ²⁾	Shock test with severity level 2, to EN 60068-2-27	
Vibration resistance ²⁾	Transport application test with severity level 2, to EN 60068-2-6	

- 1) For information about the applicability of the component see the manufacturer's EC declaration of conformity at: www.festo.com → Support → User documentation.
If the component is subject to restrictions on usage in residential, office or commercial environments or small businesses, further measures to reduce the emitted interference may be necessary.
- 2) Please also note the safety-related applications and safety technology on the Support Portal

General technical data		
Control block	VOFA-L26-T52-...	VOFA-B26-T52-... on valve terminal
Design	Piston spool valve	
Standard nominal flow rate	[l/min]	950 830
Reset method	Mechanical spring	
Sealing principle	Soft	
Exhaust function	With flow control	
Actuation type	Electric	
Non-overlapping	Yes	
Type of control	Piloted	
Direction of flow	Non-reversible	
Exhaust function	With flow control	
Suitability for vacuum	-	
Pilot air supply	Internal	Via valve terminal
Type of mounting	Via through-hole, on manifold sub-base	
Mounting position	Any	
Manual override	-	
Valve switching status display	Via accessories	
Pneumatic connections		
Supply	1	G $\frac{1}{4}$ Via the manifold sub-base of the valve terminal
Exhaust	3/5	G $\frac{1}{4}$
Working lines	2/4	G $\frac{1}{4}$
Pilot air supply	14	-
Pressure gauge		G $\frac{1}{4}$ G $\frac{1}{4}$

Control block VOFA with safety function

Technical data

Fault and failure types

VOFA-L26-T52-...

Cause:

- Failure of the solenoid valve V2 to switch back completely
- Failure of the solenoid valve V1 to switch back completely
- Failure of the two solenoid valves (V1 and V2) to switch back completely at the same time

Effect:

- ... can result in incomplete reversal of the cylinder movement.
- ... can result in the pressure present at working port 4 not being reduced.
- ... can result in the loss of the safety function.

Solenoid valve designations

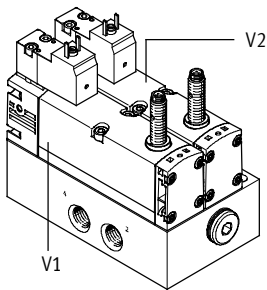

- V1 – The closest solenoid valve
- V2 – The furthest solenoid valve

Operating and environmental conditions

Control block	VOFA-L26-T52-...	VOFA-B26-T52-... on valve terminal
Operating medium	Compressed air to ISO 8573-1:2010 [7:4:4]	
Pilot medium	Compressed air to ISO 8573-1:2010 [7:4:4]	
Note about the operating/pilot medium	Lubricated operation possible (required during subsequent operation)	
Operating pressure [bar]	3 ... 10	0 ... 10
Operating pressure for valve terminal with internal pilot air supply [bar]	–	3 ... 10
Pilot pressure [bar]	3 ... 10	
Noise level LpA [dB(A)]	85	
Ambient temperature [°C]	–5 ... +50	
Temperature of medium [°C]	–5 ... +50	
Fire protection classification to UL94	HB	
Corrosion resistance class CRC	0	

Control block VOFA with safety function

Technical data

Electrical data – Control block			
Control block		VOFA-L26-T52-...	VOFA-B26-T52-... on valve terminal
Electrical connection		Plug to EN 175301-803, type C, without protective earth conductor	
Nominal operating voltage	[V DC]	24	
Permissible voltage fluctuations	[%]	-15/+10	
Surge resistance	[kV]	2.5	
Degree of contamination		3	
Power consumption	[W]	1.8	
Max. magnetic disruption field	[mT]	60	
Piston position sensing		Normal position via sensor	
Switching position display		With accessories	
Duty cycle	[%]	100	
Protection class to EN 60529		IP65, NEMA 4 (for all types of signal transmission in assembled state)	
Protection against direct and indirect contact		PELV (Protective Extra-Low Voltage) Protected to EN 60950/IEC 950	
Valve switching time	On [ms]	22	22
	Off [ms]	56	59
Valve sensor switching time ¹⁾	On [ms]	60	60
	Off [ms]	11	11

- 1) Valve sensor switching time off: period of time from coil being energised to sensor being switched off when using a PNP sensor.
Valve sensor switching time on: period of time from coil being de-energised to 0-L edge at the sensor when using a PNP sensor.

 Note
With a duty cycle of 100%, the control block must be de-energised once a week.

Electrical data – Sensor (to EN-60947-5-2)	
Electrical connection	
Cable, 3-wire	
Plug M8x1, 3-pin	
Cable length	[m] 2.5
Switching output	
PNP or NPN	
Switching element function	
N/C contact	
Switching status display	
Yellow LED	
Operating voltage range	[V DC] 10 ... 30
Residual ripple	[%] ±10
Sensor idle current	[mA] Max. 10
Max. output current	[mA] 200
Voltage drop	[V] Max. 2
Max. switching frequency	[Hz] 5,000
Protection against short circuit	
Pulsed	
Protection against polarity reversal for sensor	
For all electrical connections	
Measuring principle	
Inductive	

Materials	
Sub-base/manifold sub-base	Wrought aluminium alloy
Housing	Die-cast aluminium, PA
Seals	NBR, FPM
Screws	Galvanised steel
Sensor housing	High-alloy stainless steel
Sensor cable sheath	PUR
Note on materials	Contains PWIS (paint-wetting impairment substances), RoHS-compliant

Control block VOFA with safety function

Technical data

Dimensions

Download CAD data → www.festo.com

Decentralised individual connection variant

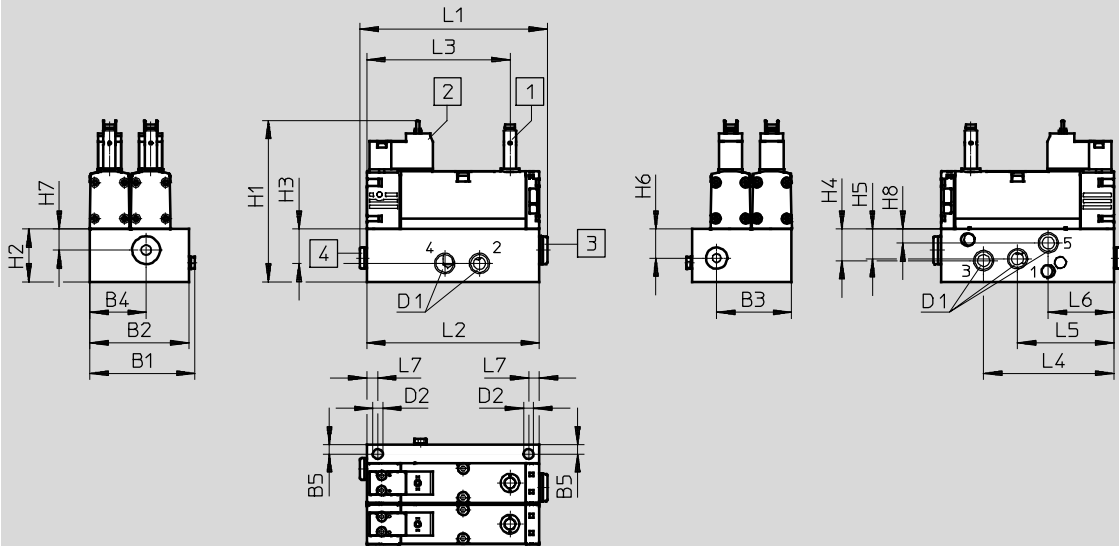

1 Proximity sensor PNP or NPN, size M8x1, plug connection to EN 61076-2-104

2 Electrical connection to EN 175301-803, type C

3 Pneumatic connection G1/4 sealed with blanking plug

4 Pneumatic connection G1/8 sealed with blanking plug

Type	B1	B2	B3	B4	B5	D1	D2	H1	H2	H3	H4	H5	H6	H7	H8
VOFA-L26-T52-M-G14-1C1-APP	69	65	49.5	37	6	G1/4	6.5	105.8	34.6	22.6	20.7	19.5	19.1	13.8	9.1
VOFA-L26-T52-M-G14-1C1-ANP															

Type	L1	L2	L3	L4	L5	L6	L7
VOFA-L26-T52-M-G14-1C1-APP	122.9	113.1	93.8	85.3	63.1	42.9	7.1
VOFA-L26-T52-M-G14-1C1-ANP							

Control block VOFA with safety function

Technical data

FESTO

Dimensions

Download CAD data → www.festo.com

Version for valve terminal VTSA/VTSA-F

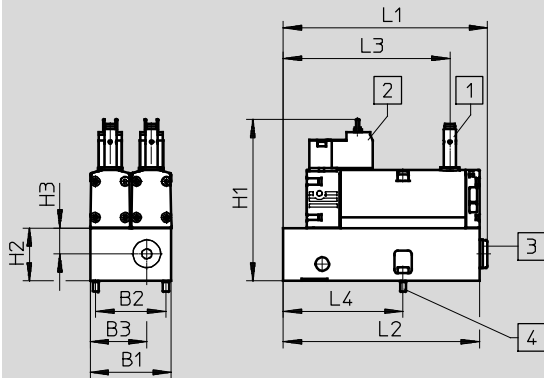

1 Proximity sensor PNP or NPN, size M8x1, plug connection to EN 61076-2-104

2 Electrical connection to EN 175301-803, type C

3 Pneumatic connection G1/4 sealed with blanking plug

4 2x screw with internal hex (2.5 A/F), M4x12 (included in the scope of delivery)

Type	B1	B2	B3	H1	H2	H3	L1	L2	L3	L4
VOFA-B26-T52-M-1C1-APP	53	46	37	105.8	34.6	17	133.7	128.5	109.2	78.5
VOFA-B26-T52-M-1C1-ANP										

Control block VOFA with safety function

Ordering data – Control block

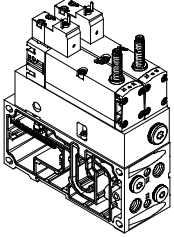
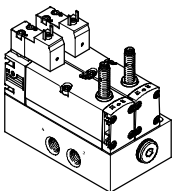
Ordering data							
	Valve function	Code	Switching output	Width [mm]	Weight [g]	Part No.	Type
Control block, version for valve terminal VTSA/VTSA-F							
	5/2-way valve, single solenoid, mechanical spring return, with switching position sensing via inductive sensor and 3-pin sensor push-in connector M8, mounted on intermediate plate for pneumatic interlinking	SP ²⁾	PNP	53	1,112	– ¹⁾	VOFA-B26-T52-M-1C1-APP
		SN ²⁾	NPN	53	1,112	– ¹⁾	VOFA-B26-T52-M-1C1-ANP
Control block, as decentralised individual connection variant							
	5/2-way valve, single solenoid, mechanical spring return, with switching position sensing via inductive sensor and 3-pin sensor push-in connector M8, mounted on individual sub-base	–	PNP	65	1,138	569819	VOFA-L26-T52-M-G14-1C1-APP
		–	NPN	65	1,138	569820	VOFA-L26-T52-M-G14-1C1-ANP

- 1) The control block with safety function can only be ordered via the valve terminal configurator and therefore does not have a separate part number.
 2) Code letter within the order code for a valve terminal configuration.







 Note

The sensors contained in the valves must not be replaced. Incorrect assembly can result in malfunctions or damage to the valve. Please contact Festo in the event of a malfunction.

Control block VOFA with safety function

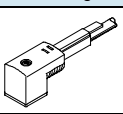
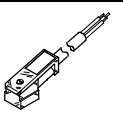
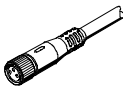
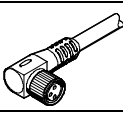
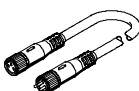
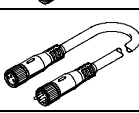
Accessories

FESTO

Ordering data					
	Description	Part No.	Type		
Plug socket for electrical connection of individual valves					
	Angled socket, 3-pin, screw terminal, cable connector	PG7	151687	MSSD-EB	
		M12	539712	MSSD-EB-M12	
Illuminating seal for plug pattern to EN 175301-803, type C					
	For plug socket MSSD	151717	MEB-LD-12-24DC		
Connecting cable for electrical connection of individual valves					
	Angled socket, 3-pin, with switching status display via LED	2.5 m	151688	KMEB-1-24-2,5-LED	
		5 m	151689	KMEB-1-24-5-LED	
		10 m	193457	KMEB-1-24-10-LED	
	Angled socket, 4-pin, with switching status display via LED	2.5 m	174844	KMEB-2-24-2,5-LED	
		5 m	174845	KMEB-2-24-5-LED	
Connecting cable for electrical connection of sensors for switching position sensing					
	Straight socket, 3-pin, plug M8	2.5 m	541333	NEBU-M8G3-K-2,5-LE3	
		5 m	541334	NEBU-M8G3-K-5-LE3	
	Angled socket, 3-pin, plug M8	2.5 m	541338	NEBU-M8-W3-K-2,5-LE3	
		5 m	541341	NEBU-M8W3-K-5-LE3	
	Straight socket, straight plug, 3-pin, 4-pin plug M8	2.5 m	554037	NEBU-M8G3-K-2,5-M8G4	
	Modular system for connecting cables	–	–	NEBU-... → Internet: nebu	
Silencer					
	Connecting thread	G $\frac{1}{4}$	2316	U-$\frac{1}{4}$	
Push-in fitting					
	Connecting thread G $\frac{1}{4}$ for tubing O.D.	12 mm	10 pieces	186350	QS-G$\frac{1}{4}$-12
		10 mm	10 pieces	186101	QS-G$\frac{1}{4}$-10
		8 mm	10 pieces	186099	QS-G$\frac{1}{4}$-8
Blanking plug					
	Connecting thread	G $\frac{1}{4}$	10 pieces	3569	B-$\frac{1}{4}$