

Vacuum generators VADM/VADMI

FESTO

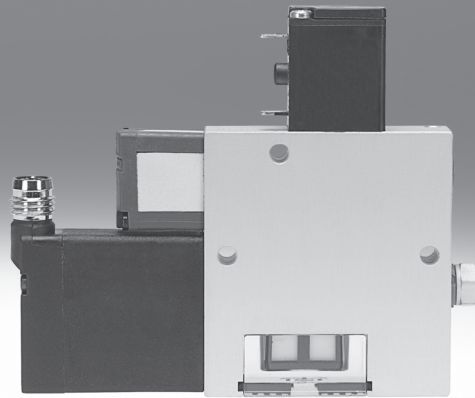

Vacuum generators

Key features

FESTO

Product overview

Vacuum generator

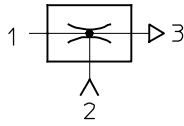

All Festo vacuum generators have a single-stage design and operate according to the venturi principle. The product families described below

have been designed for a wide range of applications. The different performance classes of the individual

product families make it possible to select vacuum generators tailored to suit specific requirements.

Standard and inline ejectors

VN-...

Technical data → Internet: vn



- Nominal size
0.45 ... 3 mm
- Max. vacuum
93%
- Temperature range
0 ... +60 °C
- A range of extremely effective generators suitable for use directly in the workplace
- Available as straight or T-shaped housing
- Low space requirement
- Low-cost
- No wearing parts
- Extremely fast evacuation time
- Vacuum switch (optional)
- Optional with additional functions:
 - integrated eject pulse
 - electric control for vacuum ON/OFF
 - combination of eject pulse and control

VAD-.../VAK-...

Technical data → Internet: vad



- Nominal size
0.5 ... 1.5 mm
- Max. vacuum
80%
- Temperature range
-20 ...+80 °C
- Range of vacuum generators with sturdy aluminium casing
- VAK-...: Built-in reservoir
- VAD-...: Connection for additional external reservoir
- Maintenance-free
- VAK-...: Reliable setting down of workpieces

Vacuum generators

Key features

Compact ejectors

VADM-.../VADMI-...

→ 8



- Nominal size
0.45 ... 3 mm
- Max. vacuum
84%
- Temperature range
0 ... +60 °C
- Compact design
- Minimal installation work required
- Short response times
- Built-in solenoid valve (on/off)
- VADMI-...: Additional built-in solenoid valve for ejector pulse
- Filter with display
- Air-saving circuit (optional)
- Vacuum switch (optional)
- Reliable setting down of workpieces

VAD-M-.../VAD-M-...-I-...

Technical data → Internet: vad-m

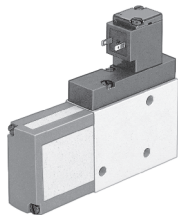

- Nominal size
0.7 ... 2 mm
- Max. vacuum
85%
- Temperature range
0 ... +40 °C
- Compact design
- Minimal installation work required
- Short response times
- Built-in solenoid valve (on/off)
- VAD-M-I-...: Additional built-in solenoid valve for ejector pulse
- Reliable setting down of workpieces

Vacuum generators VADM/VADMI

Features



At a glance

- Compact and sturdy design
- Components with numerous individual functions form a single unit
- Extremely short switching times thanks to integrated solenoid valves
- No external or additional components required
- Easily fitted thanks to compact dimensions and therefore particularly suitable for handling operations
- Cost effective assembly as the solenoid valve, vacuum generator and silencer are all in a single unit.
- Protection class IP65
- With manual override
- With integrated silencer for reducing exhaust noise
- With integrated filter for the air to be evacuated and a display window which shows the degree of filter contamination
- With or without integrated vacuum switch to monitor the vacuum with PNP or NPN output
- With 2 vacuum ports, optional

Vacuum generator VADM-.../-...-P/-N

The compressed air supply of these vacuum generators is controlled by the built-in solenoid valve. When the electrical power supply is switched on, the valve is actuated and the flow of compressed air from 1 (P) to 3 (R) generates a vacuum at port 2 (V), operating on the ejector principle. Suction stops when the supply power to the valve is switched off. The integrated silencer reduces exhaust noise to a minimum.

- Built-in solenoid valve for:
 - Vacuum ON/OFF
- With the vacuum generators VADM-...-P/N the vacuum can be monitored by means of a vacuum switch.

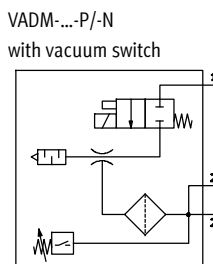
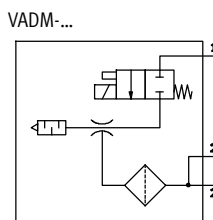

1 = Pressure supply port
2 = Vacuum port

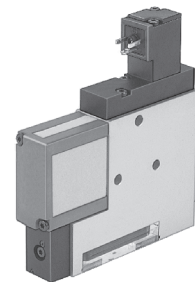

Vacuum generator VADMI-.../-...-P/-N with ejector pulse and vacuum switch

Compressed air enters the vacuum generator following the application of a voltage signal to the integrated solenoid valve, thereby creating a vacuum. Once the voltage is switched off at the vacuum valve and switched on at the ejector valve, the vacuum is rapidly purged at port 2 as a result of the application of pressure. The integrated silencer reduces exhaust noise to a minimum.

- Two built-in solenoid valves for:
 - Vacuum ON/OFF
 - Ejector pulse
 - With sensing interface
 - With integrated non-return valve as safety function
- With the vacuum generators VADMI-...-P/-N the vacuum can be monitored by means of a vacuum switch.

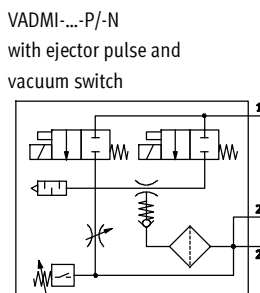
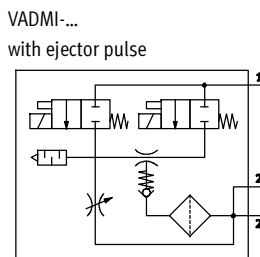

1 = Pressure supply port
2 = Vacuum port

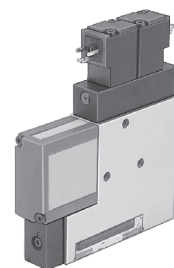

Vacuum generators VADM/VADMI

Features

Vacuum generator VADMI-...-LS-P/N with ejector pulse, vacuum switch and air-saving circuit

This vacuum generator is identically constructed to the other VADMI types. In addition, however, this ejector has a built-in vacuum switch with air-saving circuit:

If the vacuum level falls below the required range, vacuum generation is activated automatically (operating principle of vacuum switch for VADMI-...-LS-P/N → 13).

- Solenoid valve for vacuum generation
- Integrated silencer
- Integrated 40 µm filter with contamination indication
- With sensing interface for vacuum fault signal
- With integrated non-return valve as safety function
- With vacuum switch for pressure monitoring
- With 2 vacuum ports

VADM-...-LS-P/N
with air-saving circuit
PNP output

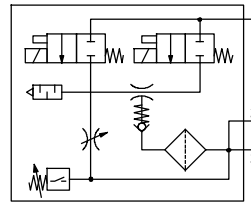

1 = Pressure supply port
2 = Vacuum port

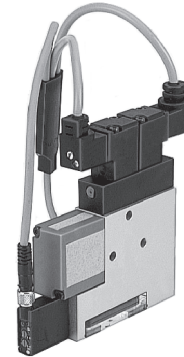

Vacuum generators VADM/VADMI

Peripherals overview

FESTO

VADM/VADMI-45/70

VADM/VADMI-95/140/200/300

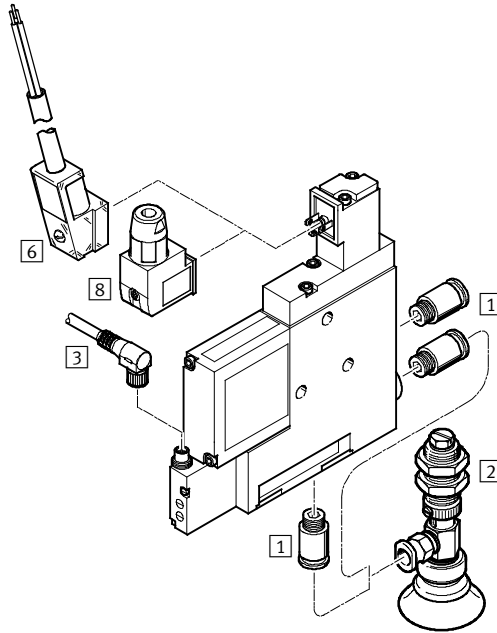
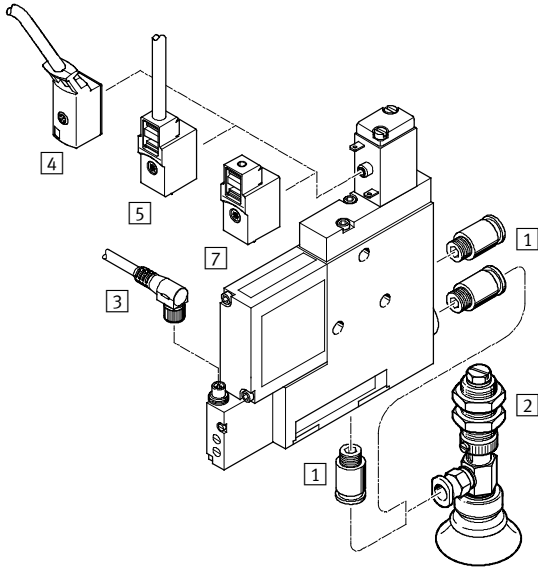

Mounting attachments and accessories			
	VADM/VADMI-45/70	VADM/VADMI-95/140/200/300	→ Page/Internet
1 Push-in fitting QS	■	■	quick star
2 Suction gripper ESG	■	■	esg
3 Connecting cable NEBU-M8	■	■	nebu-m8
4 Plug socket with cable KMYZ-2	■	-	kmyz-2
5 Plug socket with cable KMYZ-4	■	-	kmyz-4
6 Plug socket with cable KMEB-2	-	■	kmeb-2
7 Plug socket MSSD-ZBZC	■	-	mssd-zbzc
8 Plug socket MSSD-E	-	■	mssd-e
- Suction cup holder ESH	■	■	esh
- Suction cup ESS	■	■	ess
- Illuminating seal ME-LD	-	■	me-ld

Vacuum generators VADM/VADMI

Type codes

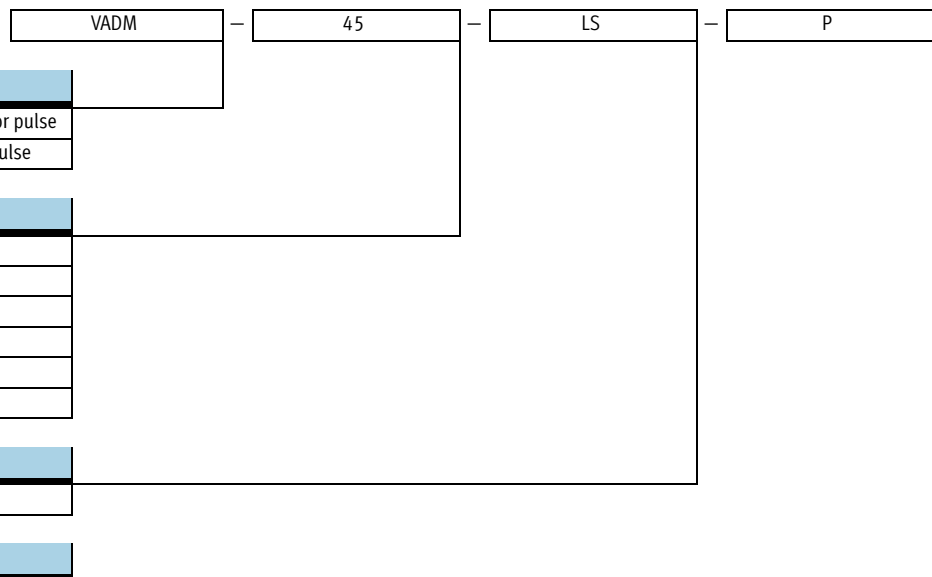

Type	
VADM	Vacuum generator without ejector pulse
VADMI	Vacuum generator with ejector pulse

Nominal laval nozzle size [mm]	
45	0.45
70	0.70
95	0.95
140	1.40
200	2.00
300	3.00

Functions	
LS	With air-saving circuit

Switching type	
P	PNP design (vacuum switch, output potential)
N	NPN design (vacuum switch, output potential)

 Note
Possible combinations can be found in the ordering data.

Vacuum generators VADM/VADMI

FESTO

Technical data

Function

VADM-...

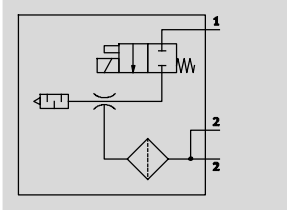

-  - Temperature range
-0 ... +60 °C

-  - Operating pressure
1.5 ... 8 bar

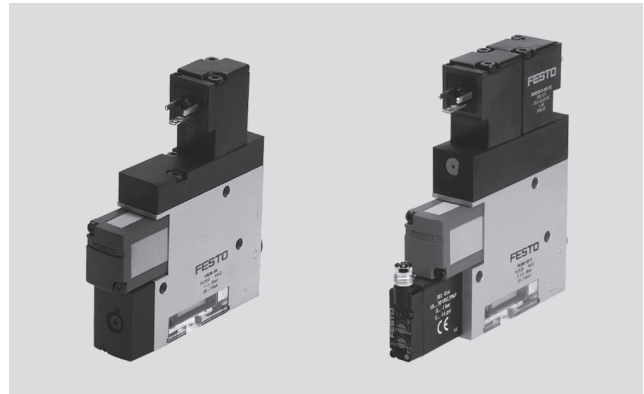

VADMI-...

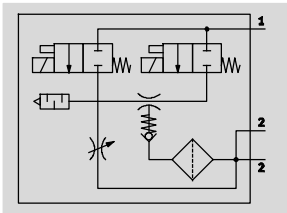

General technical data						
Nominal size	45	70	95	140	200	300
Design	Slim rectangular					
Operating medium	Compressed air in accordance with ISO 8573-1:2010 [7:4:4]					
Note on operating/pilot medium	Operation with lubricated medium not possible					
Mounting position	Any					
Ejector features	High vacuum					
Type of mounting	Either: Via female thread, via through-holes					
Pneumatic connection 1/2	M5/M5	M5/G ¹ / ₈	G ¹ / ₈ /G ¹ / ₈	G ¹ / ₈ /G ¹ / ₄	G ¹ / ₄ /G ³ / ₈	G ¹ / ₄ /G ³ / ₈
Nominal size of laval nozzle [mm]	0.45	0.7	0.95	1.4	2.0	3.0
Operating pressure [bar]	1.5 ... 8		2 ... 8			
Duty cycle [%]	100					
Power consumption [W]	1.4		1.5 piloted			
Protection class	IP65					

• Note: This product conforms to ISO 1179-1 and to ISO 228-1

Ambient conditions						
Nominal size	45	70	95	140	200	300
Ambient temperature [°C]	-0 ... +60					
Note on material	Free of copper, PTFE and silicone					
Authorisation	c UL us - Recognized (OL)					

Weights [g]						
Nominal size	45	70	95	140	200	300
VADM-...	60	140	210	290	320	340
VADM-...-P/-N	65	145	220	300	330	350
VADMI-...	85	170	240	320	350	370
VADMI-...-P/-N/-LS-P	90	180	250	330	360	380

Vacuum generators VADM/VADMI

Technical data

Vacuum Δp_u as a function of operating pressure p

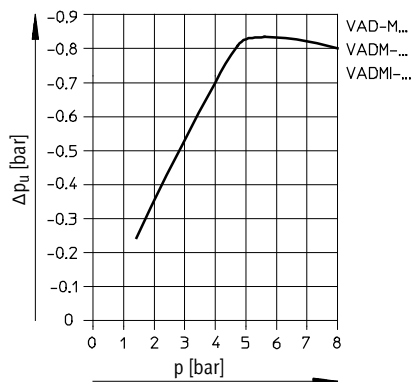

Evacuation time t [s] for 1 litre volume at 6 bar operating pressure

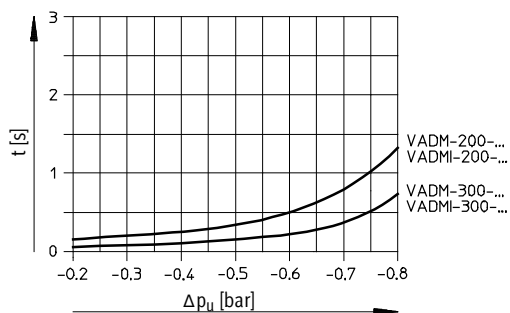
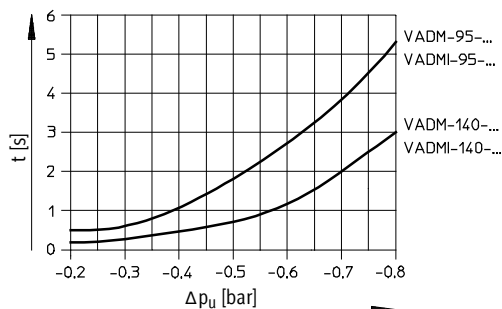
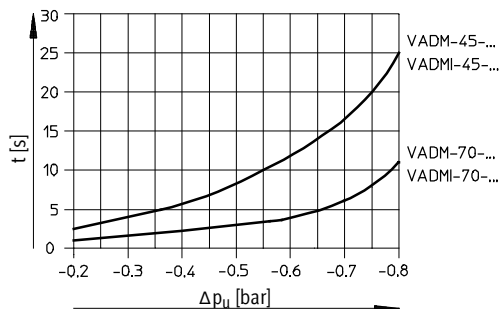

Air supply time for 1 litre volume at 6 bar operating pressure¹⁾

Type	With ejector pulse [s]	Without ejector pulse [s]	Max. flow rate [l/min]
VADM-45-...	-	5.9	-
VADMI-45-...	1.9	-	21
VADM-70-...	-	2.2	-
VADMI-70-...	0.59	-	48
VADM-95-...	-	1.18	-
VADMI-95-...	0.24	-	104
VADM-140-...	-	0.69	-
VADMI-140-...	0.19	-	265
VADM-200-...	-	0.29	-
VADMI-200-...	0.15	-	260
VADM-300-...	-	0.26	-
VADMI-300-...	0.2	-	250

1) Time required to build up vacuum from -0.75 to -0.05 bar.

Vacuum generators VADM/VADMI

Technical data

FESTO

Air consumption Q as a function of operating pressure p

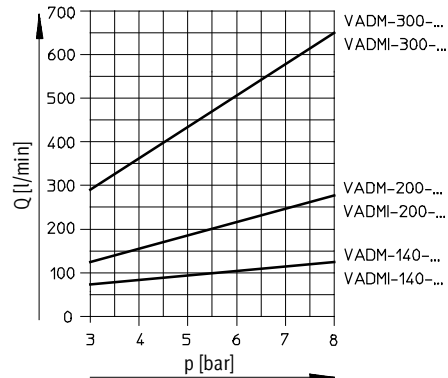
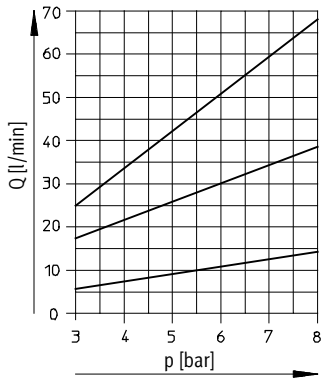

Noise level Lp as a function of operating pressure p (without suction flow)

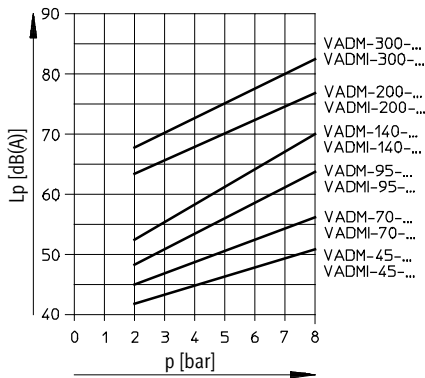

Efficiency η as a function of vacuum Δp_U at P_{nom} 6 bar

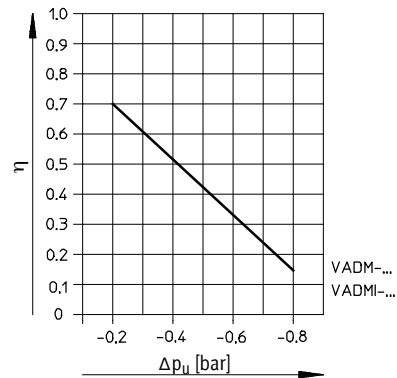

Suction rate qn as a function of vacuum Δp_U

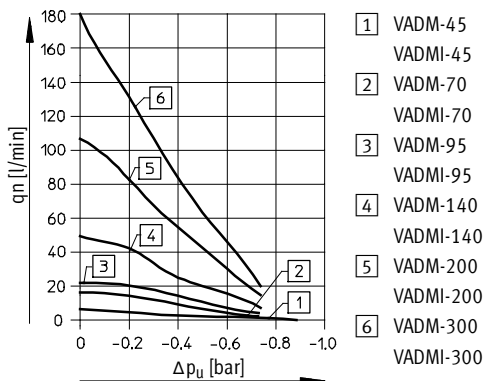

Vacuum generators VADM/VADMI

Technical data

Vacuum switch for vacuum generators
VADM...-...-P/N

Circuit diagram

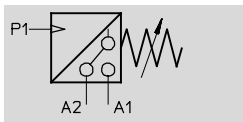
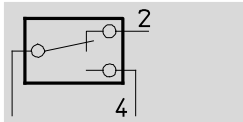

- Piezo-resistive vacuum switch with adjustable switching point and adjustable hysteresis
- Switching status display, yellow LED
- Electrical connection, polarity safe

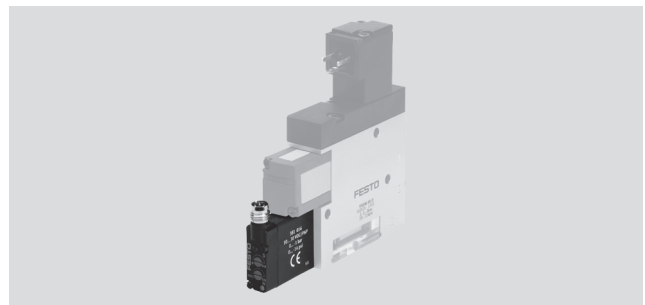

General technical data		
Pneumatic data		
Max. operating pressure	[bar]	0 ... -0.95
Switching point	[bar]	0 ... -0.9 (adjustable)
Hysteresis	[bar]	0.05 ... 0.5 (adjustable)
Temperature influence		≤ ±5 mbar/10K (on switching point)
Electrical data		
Operating voltage	[V DC]	24 (15 ... 30)
Voltage drop	[V]	1.2 (at switch output)
Switch output current	[mA]	130
Max. intrinsic current consumption	[mA]	25
Max. switching delay	[ms]	5
Connection		Reverse polarity protected
Mechanical data		
Design		Piezo-resistive vacuum switch with adjustable switching point and hysteresis
Ambient conditions		
Protection class		IP65

Ambient conditions		
Ambient temperature	[°C]	-0 ... +60
Note on material		Free of copper, PTFE and silicone
CE marking symbol (see conformity declaration)		As per EU EMC directive
Authorisation		c UL us - Recognized (OL) C-Tick

Vacuum switch control panel

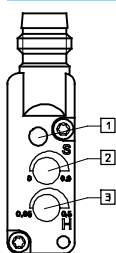

- 1 Switching status display, yellow LED
- 2 Switching point adjustment
- 3 Hysteresis adjustment

Vacuum generators VADM/VADMI

Technical data

FESTO

Terminal allocation

PNP output

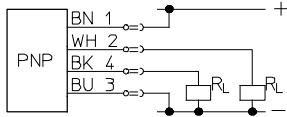

NPN output

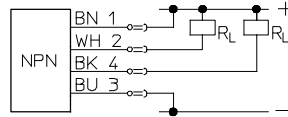

BN = Brown
WH = White
BK = Black
BU = Blue
RL = Load

Pin allocation

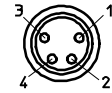

1 Brown: Positive terminal
2 White: NC contact
3 Blue: Negative terminal
4 Black: NO contact

Energy-saving function with VADMI-...-P/N

The conventional vacuum switch → A cost-effective energy-saving measure

With the vacuum generators VADMI a maximum value is first set and then the hysteresis is regulated (reliable operating range). The lower limit defines the minimum value.

Once the vacuum level is within this range, reliable workpiece transport is guaranteed.

The vacuum generator VADMI is only activated by the external controller if the level drops below the minimum value and is deactivated again once that minimum value is regained.

A non-return valve prevents the vacuum level from being purged during the inactive phase of vacuum generation.

The functional sequence

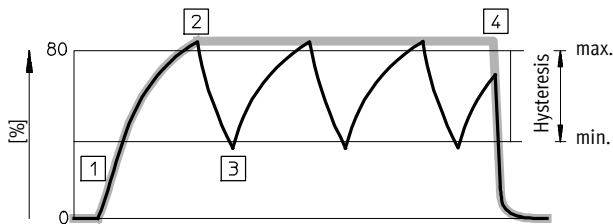

Optimum vacuum curve
Actual vacuum curve

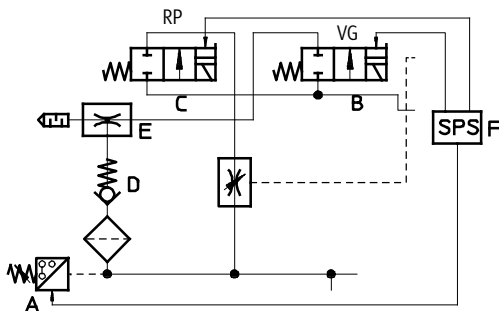

RP Ejector pulse
VG Vacuum on/off
E Vacuum generator
D Non-return valve
A Vacuum switch

Vacuum on

- 1 External controller F switches on the VG solenoid
 - Valve for compressed air supply B is opened
 - Vacuum generation E is activated

Vacuum stop

- 2 The specified maximum level is achieved:
 - Pressure sensor A sends a signal to the external controller
 - Controller switches the VG solenoid off
 - Vacuum generation is interrupted
 - Non-return valve D prevents the vacuum level from being purged

Vacuum on

- 3 Leakage causes the vacuum level to drop to the minimum value
 - Pressure sensor A sends a signal to the external controller F
 - Controller F switches the VG solenoid B back on
 - Vacuum generation E is active again
 - Constant repetition of points 2 and 3

Cycle ended: Vacuum off

- 4 Transport process ended
 - External controller (PLC) F deactivates VG solenoid B
 - Vacuum generation E is ended
 - External controller switches on ejector RP solenoid C
 - Vacuum level at 0
 - Workpiece is released

Vacuum generators VADM/VADMI

Technical data

Vacuum switch and cable set for vacuum generators with air-saving circuit VADMI-...-LS-P/N

Circuit diagram

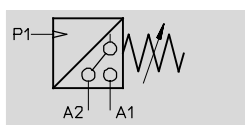
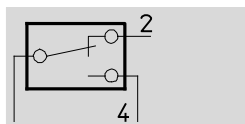

- Piezo-resistive vacuum switch with adjustable switching point and adjustable hysteresis
- Air-saving circuit only in conjunction with supplied cable
- Switching status display, yellow LED
- Electrical connection, polarity safe

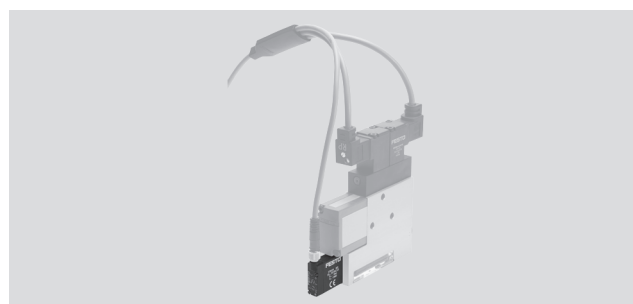

General technical data		
Pneumatic data		
Max. operating pressure	[bar]	0 ... 1
Max. overload pressure	[bar]	5 (for t < 1 min)
Switching point	[bar]	0 ... -0.9 (adjustable)
Hysteresis	[bar]	0.1 ... 0.6 (adjustable)
Temperature influence		≤ ±10 mbar/10K (on switching point)
Electrical data		
Operating voltage	[V DC]	24 V (±10%, at VADMI-70-LS-P +10%-5%)
Voltage drop	[V]	1.2 (at switch output)
Switch output current	[mA]	130
Max. intrinsic current consumption	[mA]	25
Max. switching delay	[ms]	2 (with NPN cable distribution: 20 ms)
Connection		Reverse polarity protected
Mechanical data		
Design		Piezo-resistive vacuum switch with integrated air-saving circuit
Ambient conditions		
Protection class		IP65

Ambient conditions		
Ambient temperature	[°C]	-0 ... +60
Note on material		Free of copper, PTFE and silicone
CE marking symbol (see conformity declaration)		As per EU EMC directive
Authorisation		c UL us - Recognized (OL) C-Tick

Vacuum generators VADM/VADMI

Technical data

Function principle

In conjunction with the supplied cable set, the vacuum generator VADMI-...-LS-P/N contains an air-saving circuit. The vacuum range to be used to hold the workpiece is set on the switch using both potentiometers. The switch generates a pulsating signal A2 which only actuates the solenoid for vacuum ON/OFF in the vacuum generator when the vacuum pressure has fallen below the selected upper limit value due to leakage etc.

At all other times, the vacuum is maintained with the help of the non-return valve, even when the vacuum generator is not switched on. In addition to this, status signal A1 can be interrogated which is connected to +24 V during normal operation, but which is switched to 0 whenever vacuum pressure falls below the critical value by 150 mbar due to a malfunction.

This is the case, for example, if the workpiece has dropped off from the suction cup and it is no longer possible to generate the selected vacuum.

Accessories (included in scope of delivery):

- Connecting cable
The switch may only be operated with the included cable set. Connections 1, 2 and 4 can nevertheless be interchanged with one another without damaging the device.

Vacuum switch control panel

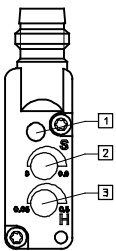

- 1 Switching status display, yellow LED
- 2 Switching point adjustment
- 3 Hysteresis adjustment

Terminal allocation

PNP output

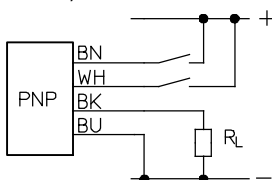

NPN output

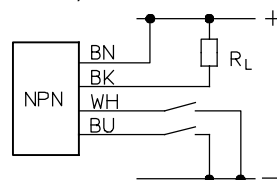

BN = Brown
WH = White
BK = Black
BU = Blue
RL = Load

Pin allocation

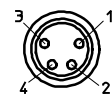

- 1 Brown: Positive terminal
- 2 White: NC contact
- 3 Blue: Negative terminal
- 4 Black: NO contact

Switching points/hysteresis

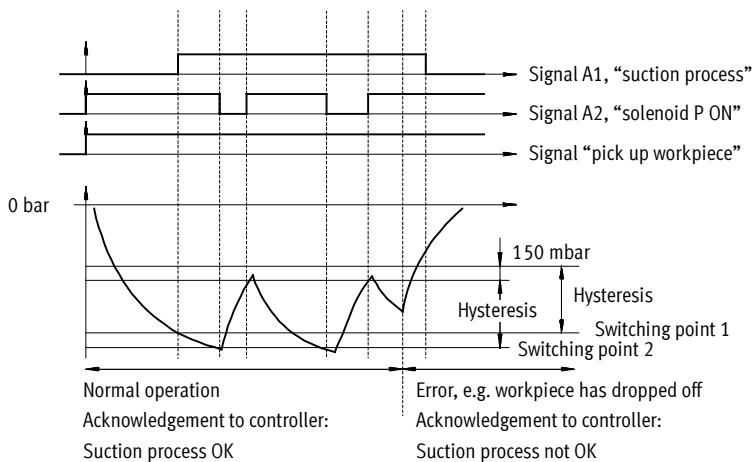

Vacuum generators VADM/VADMI

Technical data

FESTO

Energy-saving function and error reporting with VADMI-...-LS-P/N

The further development of the vacuum switch

In addition to the described functions, error reporting is also used as an additional energy-saving measure. This like the vacuum circuit is controlled via the vacuum switch.

If a suction cup does not pick up a workpiece properly or a tube bursts, the vacuum switch can report such an event to the external control unit (PLC) F so that this or the user can take the necessary steps.

Given the decentrally controlled switching function, external actuation of the vacuum circuit (air-saving circuit) would be superfluous. As a result there is significantly less wiring.

The functional sequence

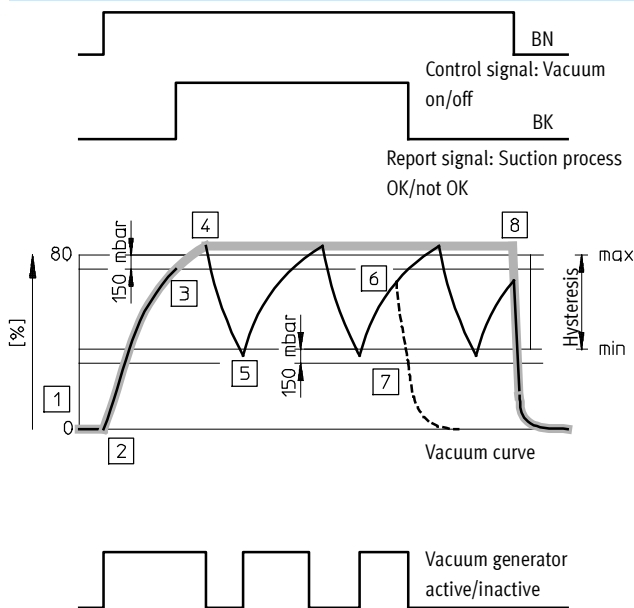

- Optimum vacuum curve
- Actual vacuum curve
- - - Curve after fault

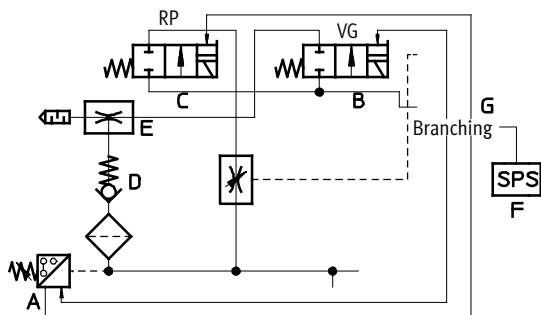

- | | |
|--------------------|-----------------|
| RP Ejector pulse | C Ejector pulse |
| VG Vacuum on/off | G Branching |
| E Vacuum generator | A Vacuum switch |
| D Non-return valve | |

Start signal

- 1 External controller F activates the pressure sensor
 - Pressure sensor A checks the vacuum status
 - No vacuum present

Vacuum on

- 2 Pressure sensor activates the VG solenoid B
 - Valve for compressed air supply is opened
 - Vacuum generation E is activated
- 3 Vacuum level 150 mbar below the maximum level is exceeded
 - Pressure sensor sends an enable signal to external controller (PLC) F BK
 - Transport process can start

Vacuum stop

- 4 The specified maximum level is achieved
 - Pressure sensor A switches the VG solenoid off
 - Compressed air supply stopped
 - Vacuum generation E interrupted
 - Non-return valve D prevents the vacuum level from being purged

Vacuum on

- 5 Leakage causes the vacuum level to drop to the minimum value
 - Pressure sensor A switches the VG solenoid on again
 - Vacuum generation E is active again

Fault: Transport stopped

- 6 Major leakage causes an overly large drop in the vacuum level
 - Vacuum generator E cannot compensate for the drop in level
- 7 Vacuum level is 150 mbar below the minimum value
 - Pressure sensor A sends an error message to the external controller (PLC) F BK
 - External controller interrupts the transport process
 - Vacuum generation E is ended

Cycle ended: Vacuum off

- 8 Transport process ended
 - External controller (PLC) F deactivates VG solenoid
 - Vacuum generation E is ended
 - External controller F switches on ejector RP solenoid C WH
 - Ejector pulse activated
 - Workpiece is released

Vacuum generators VADM/VADMI

Technical data

Connection to PLC

PNP and NPN switching of the VADMI-...-LS-P/N

The three control and supply cable harnesses are combined in a branching directly via the vacuum generator so that only one cable containing one signal wire and three

voltage supply wires need to be conducted from the branching to the PLC.

In principle there are two different signal characteristics with external control units (PLC) for the vacuum generator VADMI-LS, which differ only

slightly in their mode of operation. As both versions are identical in terms of the vacuum generator and the vacuum switch, the signal flow is only converted in the branching, as this is the only difference between the models.

The labelled plug-in connectors for the wiring harness are connected to the relevant elements of the VADMI-LS. The four-wire cable splice of the branching is connected to the control unit in the manner depicted below.

VADMI-...

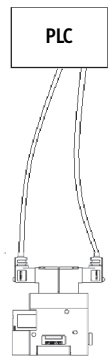

VADMI without vacuum circuit

VADMI-...-P/N

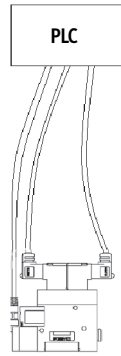

VADMI with vacuum switching

VADMI-...-P/N-LS

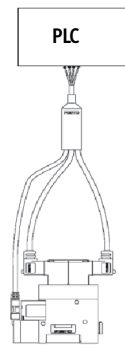

VADMI with air-saving circuit

four-wire cable splice



PNP circuit

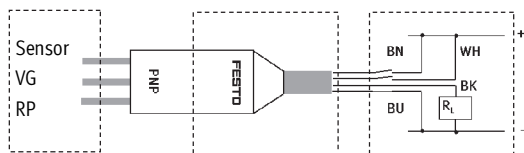

Wiring harness to VADMI Branching PLC (customer-side)

NPN circuit

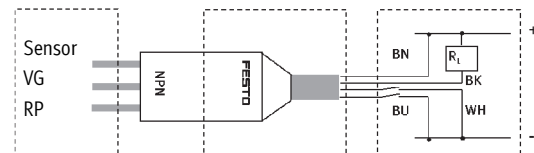

Wiring harness to VADMI Branching PLC (customer-side)

- BN = Brown for vacuum generation
- BK = Black for consumer R_L (PLC)
- VG = White for ejector pulse RP
- BU = Blue for ground

Vacuum generators VADM/VADMI

Technical data

FESTO

Dimensions

VADM-45/-70

VADM-95/-140/-200/-300

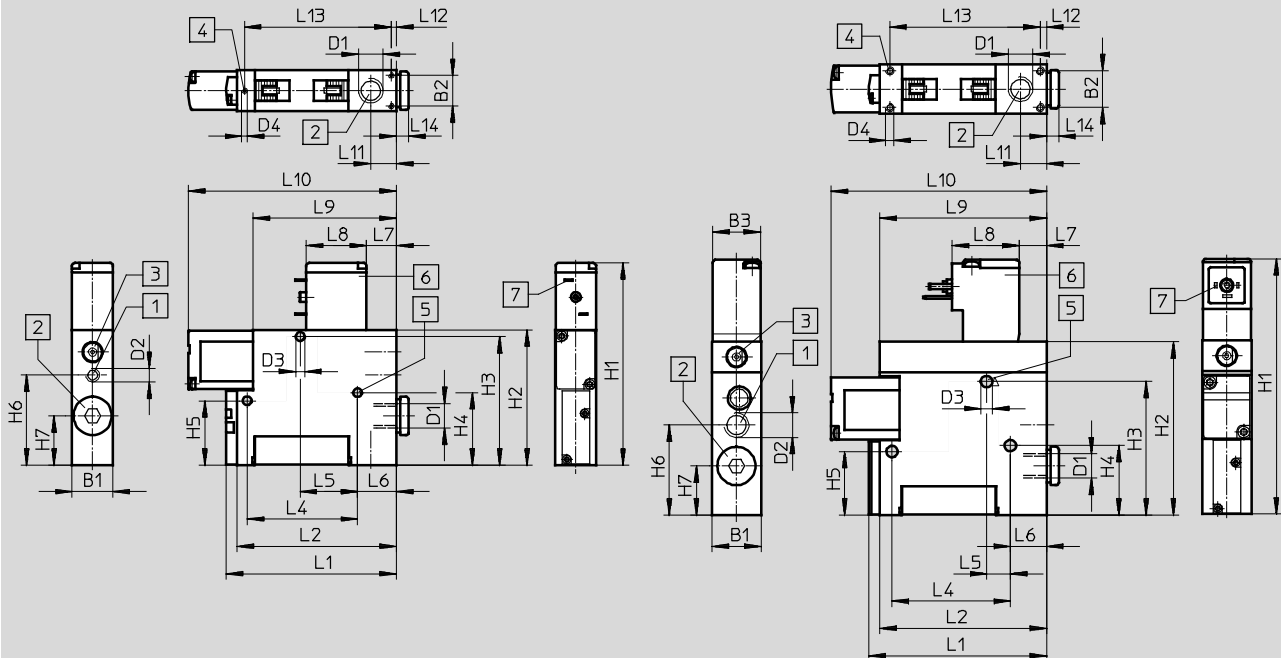

- 1 Compressed air port
- 2 Vacuum port
- 3 Manual override facility
- 4 Mounting thread
- 5 Mounting hole
- 6 Solenoid coil can
be repositioned by 180°
- 7 Suitable socket for:
VADM-45/-70
KMYZ-...
→ Internet: kmyz
VADM-95/-.../-300
KMEB-... and MSSD-EB
→ Internet: kmeb1
→ Internet: mssd-eb

Type	B1	B2	B3	D1	D2	D3 Ø	D4	H1	H2	H3	H4	H5	H6	H7
VADM-45	10	6.2	-	M5	M5	3.2	M2	64.4	44.4	40.8	23.8	23.8	29.6	18
VADM-70	15	11.2	-	G1/8	M5	3.2	M2	73.9	49.4	47	26.5	23.5	32.9	18
VADM-95	18	13.4	18	G1/8	G1/8	4.2	M2.5	93.4	63.4	48.9	25.5	23.3	33	18
VADM-140	22	16.6	18	G1/4	G1/8	5.2	M3	107.4	77.4	61.4	41.4	41.4	36	17.5
VADM-200	22	16.6	18	G3/8	G1/4	5.2	M3	113.4	83.4	67.7	41.4	41.4	40	19
VADM-300	22	16.6	18	G3/8	G1/4	5.2	M3	113.4	83.4	67.7	41.4	41.4	40	19

Type	L1	L2	L4	L5	L6	L7	L8	L9	L10	L11	L12	L13	L14
VADM-45	45	41	33.6	25	3.6	11	16	41	56	7.9	1.9	36.3	4
VADM-70	62.3	58.3	40.4	21	14.2	11	22	52.4	76.1	9.4	1.9	53.7	4.5
VADM-95	65	61	43.3	8.7	13.2	9.7	24.5	61	78.8	9.5	2.3	55	4.5
VADM-140	88	84	26	12.5	28.5	9.7	24.5	61	96.8	13.8	2.3	79.4	5
VADM-200	88	84	26	12.5	28.5	9.7	24.5	61	101.8	12.5	2.3	79.4	5
VADM-300	124.4	120.4	26	12.5	28.5	9.7	24.5	61	137.4	12.5	2.3	115.8	5

• Note: This product conforms to ISO 1179-1 and to ISO 228-1

Vacuum generators VADM/VADMI

Technical data

FESTO

Dimensions

VADM-45/-70-P/-N

VADM-95/-140/-200/-300-P/-N

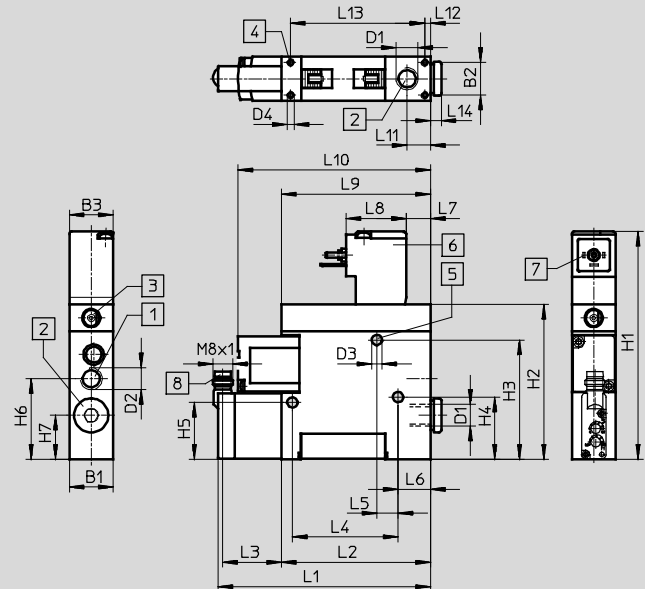
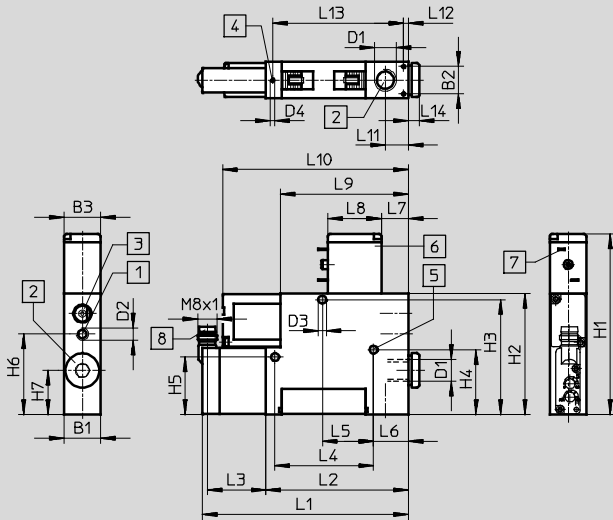

- 1 Compressed air port
- 2 Vacuum port
- 3 Manual override facility
- 4 Mounting thread
- 5 Mounting hole
- 6 Solenoid coil can be repositioned by 180°
- 7 Suitable socket for:
VADM-45/-70-P/-N
KMYZ-...
→ Internet: kmyz
VADM-95/-.../-300-P/-N
KMEB-... and MSSD-EB
→ Internet: kmeb1
→ Internet: mssd-eb
- 8 Connection for connecting
cable NEBU-M8
→ Internet: nebu-m8

Type	B1	B2	B3	D1	D2	D3	D4	H1	H2	H3	H4	H5	H6	H7
VADM-45-P/-N	10	6.2	10	M5	M5	3.2	M2	64.4	44.4	40.8	23.8	23.8	29.6	18
VADM-70-P/-N	15	11.2	15	G1/8	M5	3.2	M2	73.9	49.4	47	26.5	23.5	32.9	18
VADM-95-P/-N	18	13.4	18	G1/8	G1/8	4.2	M2.5	93.4	63.4	48.9	25.5	23.3	33	18
VADM-140-P/-N	22	16.6	18	G1/4	G1/8	5.2	M3	107.4	77.4	61.4	41.4	41.4	36	17.5
VADM-200-P/-N	22	16.6	18	G3/8	G1/4	5.2	M3	113.4	83.4	67.7	41.4	41.4	40	19
VADM-300-P/-N	22	16.6	18	G3/8	G1/4	5.2	M3	113.4	83.4	67.7	41.4	41.4	40	19

Type	L1	L2	L3	L4	L5	L6	L7	L8	L9	L10	L11	L12	L13	L14
VADM-45-P/-N	71.4	41	28.4	33.6	25	3.6	11	16	41	56	7.9	1.9	36.3	4
VADM-70-P/-N	88.7	58.3	28.4	40.4	21	14.2	11	22	52.4	76.1	9.4	1.9	53.7	4.5
VADM-95-P/-N	91.4	61	28.4	43.3	8.7	13.2	9.7	24.5	61	78.8	9.5	2.3	55	4.5
VADM-140-P/-N	114.4	84	28.4	26	12.5	28.5	9.7	24.5	61	96.8	13.8	2.3	79.4	5
VADM-200-P/-N	114.4	84	28.4	26	12.5	28.5	9.7	24.5	61	101.8	12.5	2.3	79.4	5
VADM-300-P/-N	150.8	120.4	28.4	26	12.5	28.5	9.7	24.5	61	137.4	12.5	2.3	115.8	5

– Note: This product conforms to ISO 1179-1 and to ISO 228-1

Vacuum generators VADM/VADMI

Technical data

FESTO

Dimensions

VADMI-45/-70

VADMI-95/-140/-200/-300

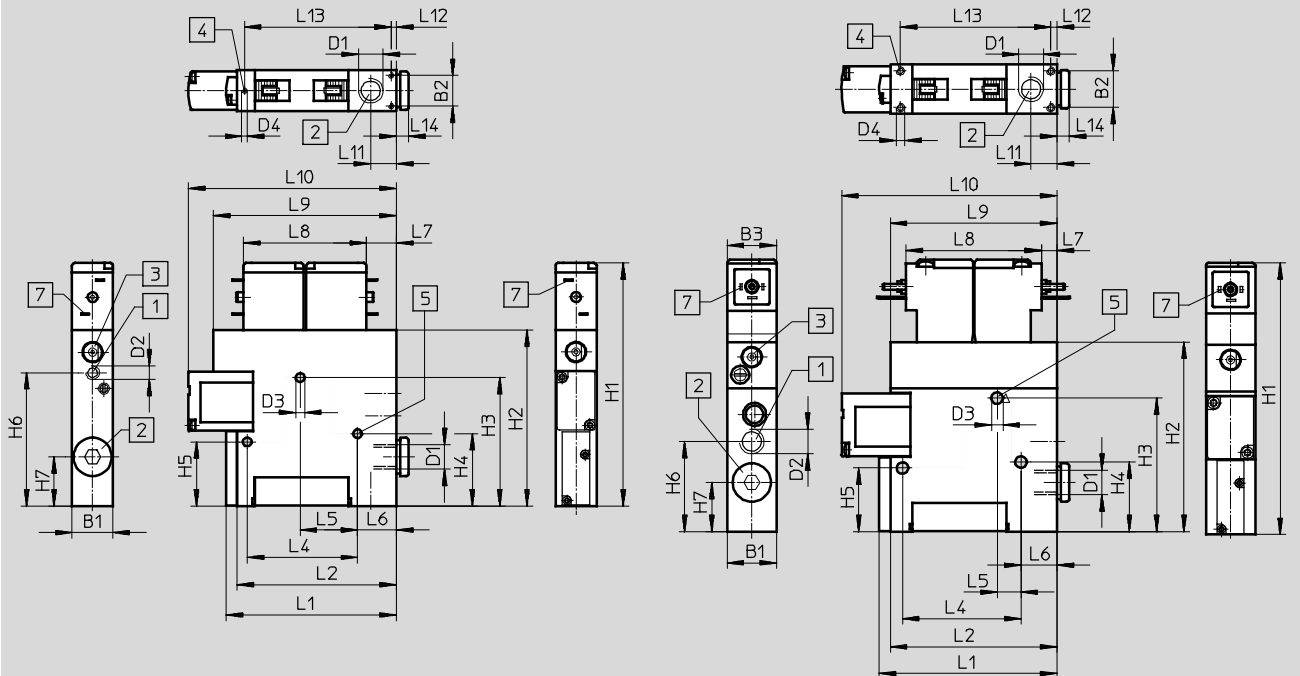

- 1 Compressed air port
- 2 Vacuum port
- 3 Manual override facility
- 4 Mounting thread
- 5 Mounting hole
- 7 Suitable socket for:
 VADMI-45/-70
 KMYZ-...
 → Internet: kmyz
 VADMI-95/-.../-300
 KMEB-... and MSSD-EB
 → Internet: kmeb1
 → Internet: mssd-eb

Type	B1	B2	B3	D1	D2	D3	D4	H1	H2	H3	H4	H5	H6	H7
VADMI-45	10	6.2	-	M5	M5	3.2	M2	78.2	58.2	40.8	23.8	23.8	43.4	18
VADMI-70	15	11.2	-	G $\frac{1}{8}$	M5	3.2	M2	88.9	64.4	47	26.5	23.5	48.8	18
VADMI-95	18	13.4	18	G $\frac{1}{8}$	G $\frac{1}{8}$	4.2	M2.5	99.4	69.4	48.9	25.5	23.3	33	18
VADMI-140	22	16.6	18	G $\frac{1}{4}$	G $\frac{1}{8}$	5.2	M3	113.4	83.4	61.4	41.4	41.4	36	17.5
VADMI-200	22	16.6	18	G $\frac{3}{8}$	G $\frac{1}{4}$	5.2	M3	119.4	89.4	67.7	41.4	41.4	40	19
VADMI-300	22	16.6	18	G $\frac{3}{8}$	G $\frac{1}{4}$	5.2	M3	119.4	89.4	67.7	41.4	41.4	40	19

Type	L1	L2	L4	L5	L6	L7	L8	L9	L10	L11	L12	L13	L14
VADMI-45	45	41	33.6	25	3.6	11	33	55	56	7.9	1.9	36.3	4
VADMI-70	62.3	58.3	40.4	21	14.2	11	45	67	76.1	9.4	1.9	53.7	4.5
VADMI-95	65	61	43.3	8.7	13.2	5.7	49.5	61	78.8	9.5	2.3	55	4.5
VADMI-140	88	84	26	12.5	28.5	5.7	49.5	61	96.8	13.8	2.3	79.4	5
VADMI-200	88	84	26	12.5	28.5	5.7	49.5	61	101.8	12.5	2.3	79.4	5
VADMI-300	124.4	120.4	26	12.5	28.5	5.7	49.5	61	137.4	12.5	2.3	115.8	5

• Note: This product conforms to ISO 1179-1 and to ISO 228-1

Vacuum generators VADMI/VADMI

Technical data

FESTO

Dimensions

VADMI-45/-70-P/-N/-LS-P

VADMI-95/-140/-200/-300-P/-N/-LS-P

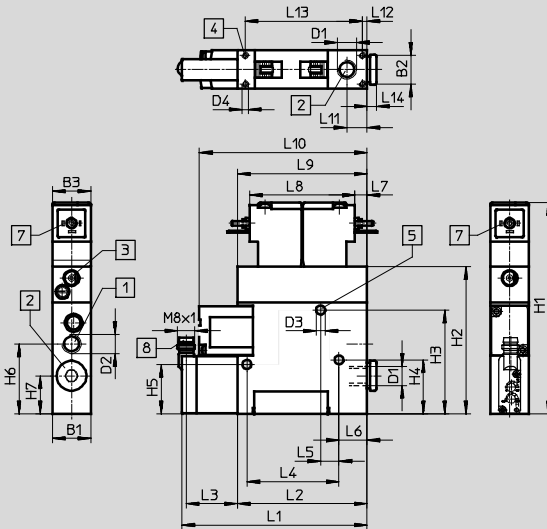
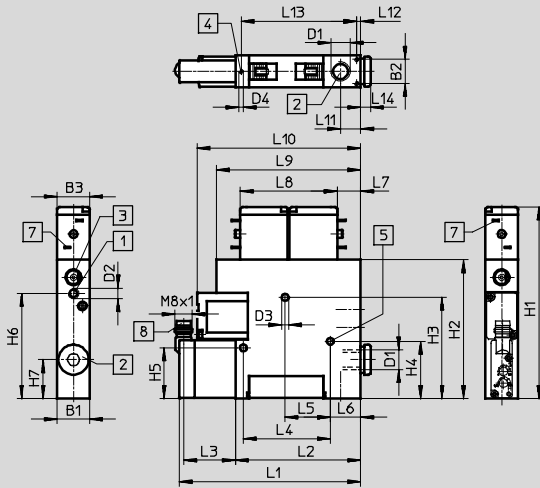

- 1 Compressed air port
- 2 Vacuum port
- 3 Manual override facility

- 4 Mounting thread
- 5 Mounting hole
- 7 Suitable socket for:
VADMI-45/-70 and KMYZ-...

- VADMI-95/-.../-300
KMEB-... and MSSD-EB
➔ Internet: kmeb1
➔ Internet: mssd-eb

- 8 Connection for connecting
cable NEBU-M8
➔ Internet: nebu-m8

Type	B1	B2	B3	D1	D2	D3 Ø	D4	H1	H2	H3	H4	H5	H6	H7
VADMI-45-P/-N	10	6.2	10	M5	M5	3.2	M2	78.2	58.2	40.8	23.8	23.8	43.4	18
VADMI-70-P/-N	15	11.2	15	G1/8	M5	3.2	M2	88.9	64.4	47	26.5	23.5	48.8	18
VADMI-95-P/-N	18	13.4	18	G1/8	G1/8	4.2	M2.5	99.4	69.4	48.9	25.5	23.3	33	18
VADMI-140-P/-N	22	16.6	18	G1/4	G1/8	5.2	M3	113.4	83.4	61.4	41.4	41.4	36	17.5
VADMI-200-P/-N	22	16.6	18	G3/8	G1/4	5.2	M3	119.4	89.4	67.7	41.4	41.4	40	19
VADMI-300-P/-N	22	16.6	18	G3/8	G1/4	5.2	M3	119.4	89.4	67.7	41.4	41.4	40	19
VADMI-45-LS-P	10	6.2	10	M5	M5	3.2	M2	78.2	58.2	40.8	23.8	23.8	43.4	18
VADMI-70-LS-P	15	11.2	15	G1/8	M5	3.2	M2	88.9	64.4	47	26.5	23.5	48.8	18
VADMI-95-LS-P	18	13.4	18	G1/8	G1/8	4.2	M3	99.4	69.4	48.9	25.5	23.3	33	18
VADMI-140-LS-P	22	16.6	18	G1/4	G1/8	5.2	M3	113.4	83.4	61.4	41.4	41.4	36	17.5
VADMI-200-LS-P	22	16.6	18	G3/8	G1/4	5.2	M3	119.4	89.4	67.7	41.4	41.4	40	19
VADMI-300-LS-P	22	16.6	18	G3/8	G1/4	5.2	M3	119.4	89.4	67.7	41.4	41.4	40	19

Type	L1	L2	L3	L4	L5	L6	L7	L8	L9	L10	L11	L12	L13	L14
VADMI-45-P/-N	71.4	41	28.4	33.6	25	3.6	11	33	55	56	7.9	1.9	36.3	4
VADMI-70-P/-N	88.7	58.3	28.4	40.4	21	14.2	11	45	67	76.1	9.4	1.9	53.7	4.5
VADMI-95-P/-N	91.4	61	28.4	43.3	8.7	13.2	5.7	49.5	61	78.8	9.5	2.3	55	4.5
VADMI-140-P/-N	114.4	84	28.4	26	12.5	28.5	5.7	49.5	61	96.8	13.8	2.3	79.4	5
VADMI-200-P/-N	114.4	84	28.4	26	12.5	28.5	5.7	49.5	61	101.8	12.5	2.3	79.4	5
VADMI-300-P/-N	150.8	120.4	28.4	26	12.5	28.5	5.7	49.5	61	137.4	12.5	2.3	115.8	5
VADMI-45-LS-P ¹⁾	71.4	41	28.4	33.6	25	3.6	11	33	55	56	7.9	1.9	36.3	4
VADMI-70-LS-P	88.7	58.3	28.4	40.4	21	14.2	11	45	67	76.1	9.4	1.9	53.7	4.5
VADMI-95-LS-P	91.4	61	28.4	43.3	8.7	13.2	5.7	49.5	61	78.8	9.5	2.3	55	4.5
VADMI-140-LS-P	114.4	84	28.4	26	12.5	28.5	5.7	49.5	61	96.8	13.8	2.3	79.4	5
VADMI-200-LS-P	114.4	84	28.4	26	12.5	28.5	5.7	49.5	61	101.8	12.5	2.3	79.4	5
VADMI-300-LS-P	150.8	120.4	28.4	26	12.5	28.5	5.7	49.5	61	137.4	12.5	2.3	115.8	5

1) Plug sockets are included in the scope of delivery for type ...-LS-....

• Note: This product conforms to ISO 1179-1 and to ISO 228-1

Vacuum generators VADM/VADMI

Technical data

Ordering data								
Size	Solenoid coils	Without vacuum switch				With vacuum switch		
		Part No.		Type	PNP output		NPN output	
		Part No.	Type	Part No.	Type	Part No.	Type	
Without ejector pulse								
45	MZB	162 500	VADM-45	162 512	VADM-45-P	162 513	VADM-45-N	
70	MYB	162 501	VADM-70	162 514	VADM-70-P	162 515	VADM-70-N	
95	MEB	162 502	VADM-95	162 516	VADM-95-P	162 517	VADM-95-N	
140	MEB	162 503	VADM-140	162 518	VADM-140-P	162 519	VADM-140-N	
200	MEB	162 504	VADM-200	162 520	VADM-200-P	162 521	VADM-200-N	
300	MEB	162 505	VADM-300	162 522	VADM-300-P	162 523	VADM-300-N	
With ejector pulse								
45	MZB	162 506	VADMI-45	162 524	VADMI-45-P	162 525	VADMI-45-N	
70	MYB	162 507	VADMI-70	162 526	VADMI-70-P	162 527	VADMI-70-N	
95	MEB	162 508	VADMI-95	162 528	VADMI-95-P	162 529	VADMI-95-N	
140	MEB	162 509	VADMI-140	162 530	VADMI-140-P	162 531	VADMI-140-N	
200	MEB	162 510	VADMI-200	162 532	VADMI-200-P	162 533	VADMI-200-N	
300	MEB	162 511	VADMI-300	162 534	VADMI-300-P	162 535	VADMI-300-N	

Ordering data							
Size	Solenoid coils	With vacuum switch				NPN output	
		PNP output		NPN output		NPN output	
		Part No.	Type	Part No.	Type	Part No.	Type
With ejector pulse and air-saving circuit							
45	MZB	171 053	VADMI-45-LS-P	171 054	VADMI-45-LS-N		
70	MYB	171 055	VADMI-70-LS-P	171 056	VADMI-70-LS-N		
95	MEB	171 057	VADMI-95-LS-P	171 058	VADMI-95-LS-N		
140	MEB	171 059	VADMI-140-LS-P	171 060	VADMI-140-LS-N		
200	MEB	171 061	VADMI-200-LS-P	171 062	VADMI-200-LS-N		
300	MEB	171 063	VADMI-300-LS-P	171 064	VADMI-300-LS-N		

-  - Note

With vacuum generators VADMI-...-LS-P/N, the plug sockets with cable for solenoid coils and vacuum switches are included in the scope of supply. These vacuum generators may only be operated with the cable supplied.