

Valve terminals VTSA/VTSA-F, NPT

FESTO

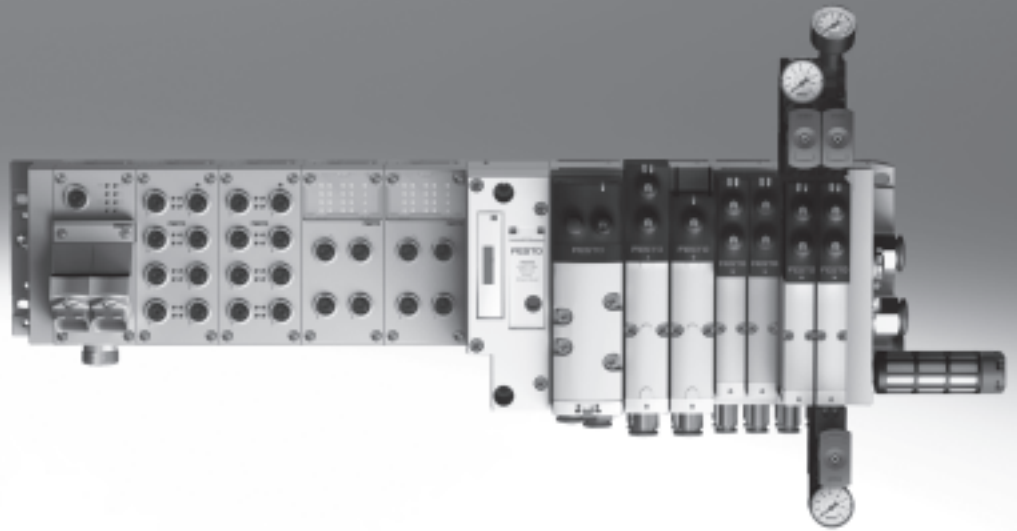

Valve terminals VTSA/VTSA-F, NPT

Key features

FESTO

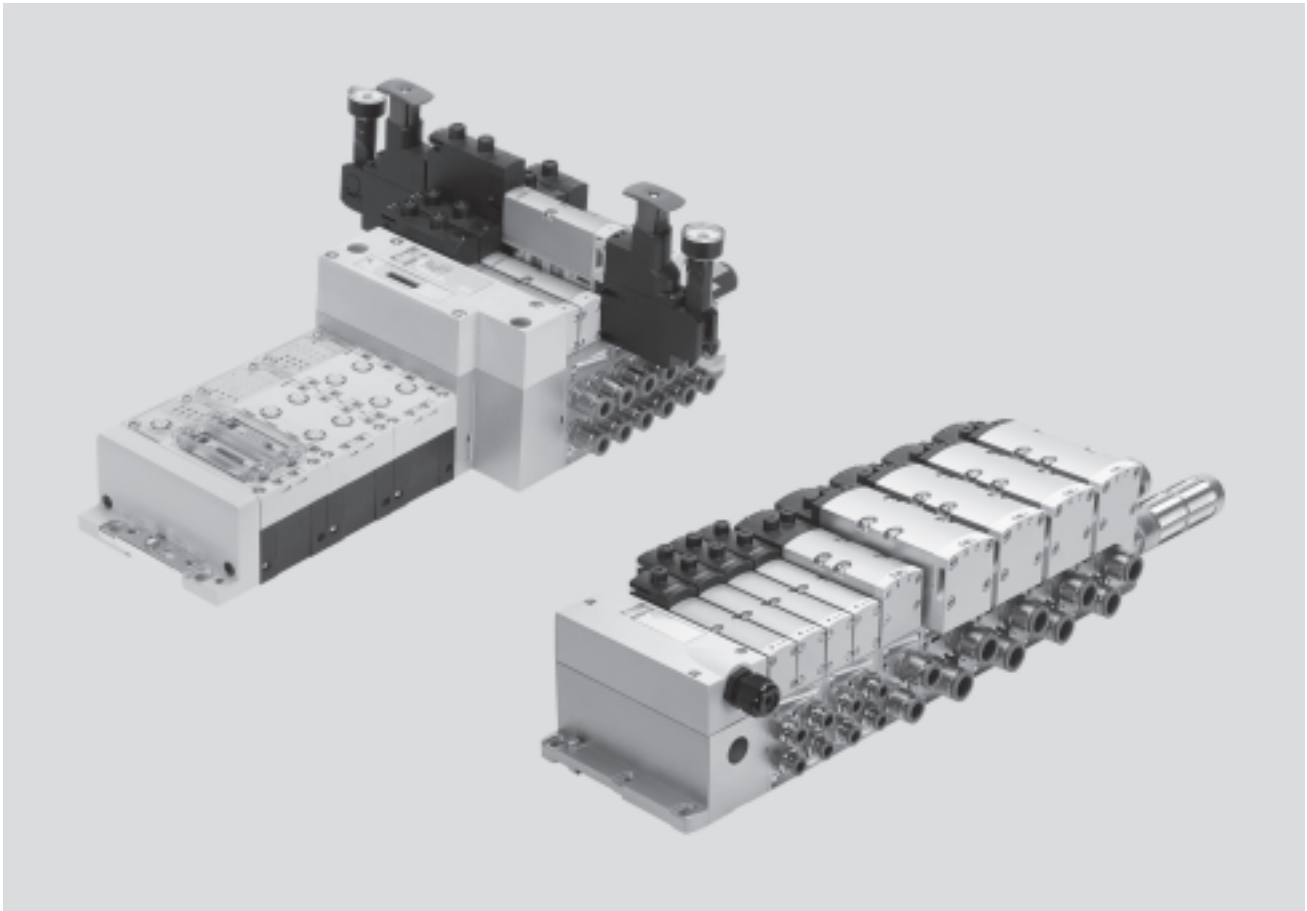

Innovative

- High-performance valves in sturdy metal housing
- Four valve sizes on one valve terminal
- Standardised from the multi-pin plug to the fieldbus connection and control block
- Dream team: fieldbus valve terminal suitable for electrical peripherals CPX. This means:
 - Forward-looking internal communication system for actuating the valves and CPX modules
 - Four valve sizes on one valve terminal without adapters
- Valve functions for integration in control architectures of higher categories to EN ISO 13849-1

Versatile

- Modular system offering a range of configuration options
- Expandable with up to 32 solenoid coils
- Conversions and extensions are possible at any time
- Manifold sub-bases can be extended using four screws, sturdy duct separation on metal support
- Integration of innovative function modules possible
- Supply plates enable a flexible air supply and variable pressure zones
- Reverse operation
- High pressure range
–0.9 ... 10 bar,
flow range 550 ... 2,900 l/min
- Wide range of valve functions
- Valve supply: 24 V DC or 110 V AC

Reliable

- Sturdy and durable metal components
 - Valves
 - Manifold sub-bases
 - Seals
- Fast troubleshooting thanks to LEDs on the valves and diagnostics via fieldbus
- Convenient servicing thanks to valves that can be replaced quickly and easily
- Manual override either non-detenting, non-detenting/detenting or covered
- Durable thanks to tried-and-tested piston spool valves
- Large and durable labelling system
- 100% duty cycle

Easy to mount

- Ready-to-install and tested unit
- Lower selection, ordering, installation and commissioning costs
- Secure mounting on wall or H-rail

Note

The key features, valves and functions of width 65 mm are described separately in the chapter "Adaptation

to width 65 mm, ISO size 3 (technology type 04)"
→ page 125.

Valve terminals VTSA/VTSA-F, NPT

Key features

Reduced downtimes:
On-the-spot diagnostics via LEDs

Width 18 mm, 26 mm,
42 mm and 52 mm can be com-
bined on a single valve terminal
without adapter

Pneumatic interface to CPX

Simple electrical connections
– Fieldbus connection via CPX
– Multi-pin plug connection with
pre-assembled cable or terminal
strip (Cage Clamp®)
– Control block via CPX
– AS-interface
– Individual connection

CPX diagnostic interface for handheld
devices (channel-oriented diagnostics
down to the individual valve)

Quick mounting:
Direct mounting using screws or
H-rail

Safe:
Valves, outputs and logic voltage
can be switched off separately

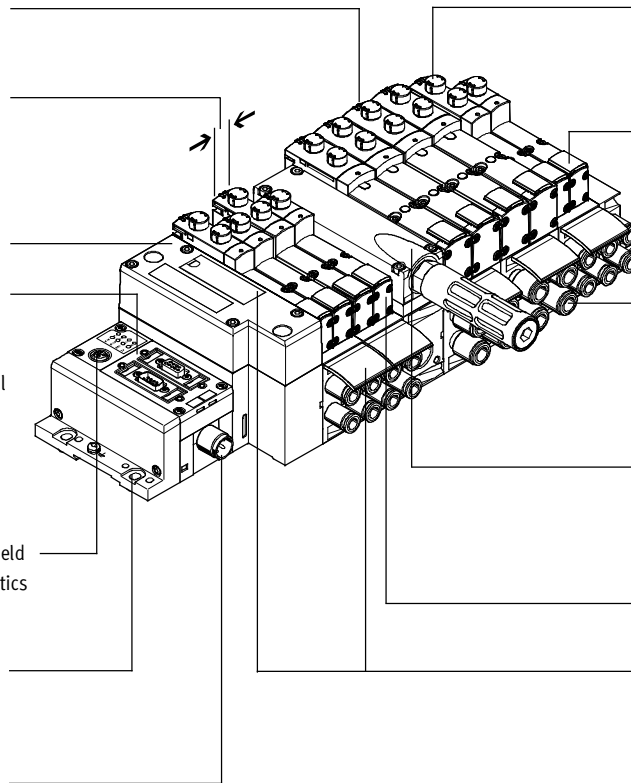

Reliable operation:
Manual override, non-detenting/
detenting or covered

Flexible:
– 32 valve positions/32 solenoid coils
– One valve series for a wide range of
flow rates

Functional:
Large ports, flow-optimised ducts,
sturdy metal thread or pre-assembled
QS connectors

Modular:
Supply plates facilitate the creation of
multiple pressure zones as well as numer-
ous additional exhaust and supply ports

Comprehensive range of valve functions

Practical:
Large inscription labels

Equipment options

Valve functions

- 2x 2/2-way valve, single solenoid, pneumatic spring, normally closed
- 2x 3/2-way valve, single solenoid
 - Normally open
 - Normally open, reversible
 - Normally closed
 - Normally closed, reversible
- 2x 3/2-way valve, single solenoid
 - 1x normally open, 1x normally closed
 - 1x normally open, 1x normally closed, reversible
- 5/2-way valve
 - Single solenoid, pneumatic spring/mechanical spring
 - Double solenoid
 - Double solenoid with dominant signal
- 5/2-way valves for special functions, single solenoid
 - Mechanical spring
 - Switching position sensing via inductive sensors with PNP or NPN output
 - Protection against unexpected start-up to EN 1037
 - Reversing
- 5/3-way solenoid valve
 - Mid-position pressurised
 - Mid-position closed
 - Mid-position exhausted
- 5/3-way solenoid valve for special functions
 - Switching position 14 with memory function (switching position 14 is retained in the event of an emergency-stop application/power failure), there is no spring return on switching position 12
 - Only for valve terminal (plug-in)
 - Mid-position exhausted or mid-position 1→2, 4→5
 - Switching position 14 with memory function
 - Pneumatic spring return
- Soft-start valve for slow and safe pressure build-up
 - High degree of safety
 - Sensor function provides feedback on switching operation

Note

The key features, valves and functions of width 65 mm are described separately in the chapter "Adaptation

to width 65 mm, ISO size 3 (technology type 04)" → page 125.

Valve terminals VTSA/VTSA-F, NPT

Key features

FESTO

Special features

Individual valve on individual sub-base up to width 52 mm

Plug-in

- Electrical connection via standardised 4-pin M12 plug or via 4-pin spring-loaded terminal for configuration by the user
- Available with internal/external pilot air supply

Square plug or plug-in, with integrated piston position sensing

- Electrical connection to DIN EN 175301-803 type C (square plug) or
- For configuration by the user via 4-pin spring-loaded terminal or
- Cable with open end

CPX terminal

- Max. 32 valve positions/
max. 32 solenoid coils
- Any compressed air supply
- Any number of pressure zones

Valve terminal with individual connection

- Max. 20 valve positions/
max. 20 solenoid coils
- Any compressed air supply
- Any number of pressure zones

Valve terminal with multi-pin plug connection

- Max. 32 valve positions/
max. 32 solenoid coils
- Parallel modular valve linking
- Any compressed air supply
- Any number of pressure zones

AS-interface

- 1 to 8 valve positions/
max. 8 solenoid coils
- Soft-start valve for slow and safe pressure build-up

Combinable

- Valve width 18 mm: flow rate up to 550 (700) l/min
- Valve width 26 mm: flow rate up to 1,100 (1,350) l/min
- Valve width 42 mm: flow rate up to 1,300 l/min
- Valve width 52 mm: flow rate up to 2,900 l/min
- Valve widths 18 mm, 26 mm, 42 mm and 52 mm can be combined on a single valve terminal

 Note

- Valve terminal VTSA complies with ISO 15407-2 in width 18 and 26 mm and
- With ISO 5599-2 in size 42 and 52 mm

Values in brackets apply to type 45, VTSA-F

Valve terminal configurator → Internet: www.festo.com

A valve terminal configurator is available to help you select a suitable VTSA/VTSA-F valve terminal. This makes it much easier to order the right product.

The valve terminals are fully assembled according to your order specification and are individually tested. This reduces assembly and installation time to a minimum.

You order a valve terminal VTSA using the order code:

Ordering system for VTSA
→ Internet: vtsa

Ordering system for CPX
→ Internet: cpx

You order a valve terminal VTSA-F using the order code:

Ordering system for VTSA-F
→ Internet: vtsa-f

Ordering system for CPX
→ Internet: cpx

Valve terminals VTSA/VTSA-F, NPT

Key features

Individual pneumatic connection

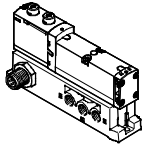

Valves on individual sub-bases up to width 52 mm can be used for actuators further away from the valve terminal.

The electrical connection is established either via a standardised 4-pin M12 plug, 24 V DC (EN 61076-2-101), 4-pin

spring-loaded terminal or a cable with open end, 24 V DC or 110 V AC, which are configured by the user.

Valve terminal with individual electrical connection

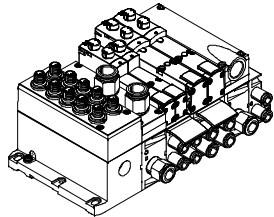

Control signals from the controller to the valve terminal are transmitted via an individual connecting cable.

The valve terminal can be equipped with max. 20 valves and max. 20 solenoid coils.

The electrical connection is established via a 5-pin M12 plug, 24 V DC.

Valve terminal with multi-pin plug connection

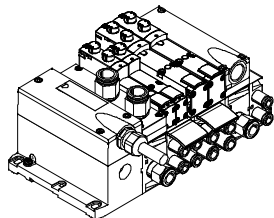

Control signals from the controller to the valve terminal are transmitted via a pre-assembled multi-wire cable or a self-assembled multi-pin plug connection (spring-loaded terminal), which substantially reduces installation time.

The valve terminal can be equipped with max. 32 valves and max. 32 solenoid coils.

Versions

- Multi-pin plug connection with terminal strip (spring-loaded terminal), 24 V DC or 110 V AC
- Pre-assembled connecting cable, 24 V DC
- Sub-D plug connector for assembly by the user, 37-pin
- Round plug connector M23, 19-pin, 24 V DC

AS-interface connection

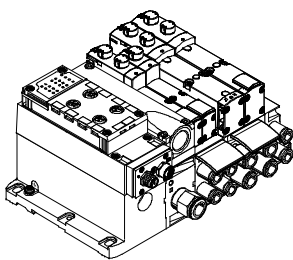

A special feature of the AS-interface is the simultaneous transmission of data and supply power via a two-wire cable. The encoded cable profile prevents connection with incorrect polarity.

The valve terminal with AS-interface is available in the following versions:

- With one to eight modular valve positions (max. 8 solenoid coils). This corresponds to one to eight VSVA valves.
- With all available valve functions. The connection technology used for the inputs can be selected as with

CPX: M8, M12, quick connection, Sub-D, spring-loaded terminal (terminals to IP20).

More information

➔ Internet: as-interface



Note

The valve terminal VTSA/VTSA-F with AS-interface connection is based on the same electrical connection block as the valve terminal with multi-pin plug connection. This means it is possible to convert a valve terminal with multi-pin plug connection using

an AS-interface module (➔ 95). The technical specifications of the AS-interface system must be observed in this case.

➔ Page 53

➔ Internet: as-interface

Valve terminals VTSA/VTSA-F, NPT

Key features

FESTO

Valve terminal with fieldbus connection from the CPX system

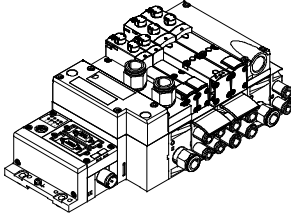

An integrated fieldbus node manages the communication connection with a higher-order PLC. This enables a space-saving pneumatic and electronic solution.

Valve terminals with fieldbus interfaces from the CPX system can be configured with up to 16 manifold sub-bases. With 2 solenoid coils per connection, up to 32 solenoid coils can thus be actuated.

Versions

- Profibus DP
- Interbus
- DeviceNet
- CANopen
- CC-Link
- CPX terminal
- Ethernet/IP
- EtherCAT
- CoDeSys controller
- Modbus/TCP
- PROFINET

➔ Internet: cpx

Valve terminal with control block connection from the CPX system

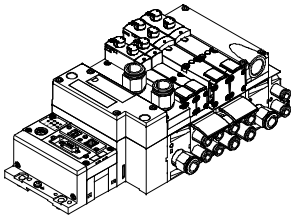

A controller integrated in the Festo valve terminal enables the construction of stand-alone control units with protection to IP65 without a control cabinet thanks to two different operating modes.

In the slave operating mode, these valve terminals can be used for intelligent preprocessing and are therefore ideal modules for designs using decentralised intelligence.

In the master operating mode, terminal groups can be designed with many options and functions that can autonomously control a medium-sized machine/system.

➔ Internet: cpx

CP string extension from the CPX system

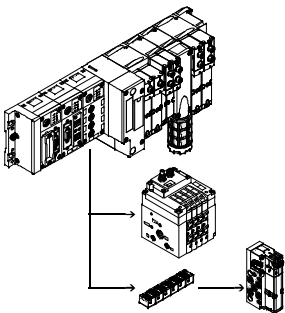

The optional CP string extension enables additional valve terminals and I/O modules to be connected to the fieldbus node of the CPX terminal on up to 4 CP strings. Different input and output modules as well as CPV-SC, CPV and CPA valve terminals can be connected.

The maximum length of the CP string extension is 10 metres, which means that the extension modules can be mounted directly on-site. All the required electrical signals are transmitted via the CP cable, which in turn means that no further installation is needed on the extension module.

One CP string offers:

- 32 input signals
- 32 output signals for output modules 24 V DC or solenoid coils
- Logic and sensor supply for the input modules
- Load voltage supply for the valve terminals
- Logic supply for the output module

➔ Internet: ctec

Solenoid valve with switching position sensing, width 18 mm, 26 mm

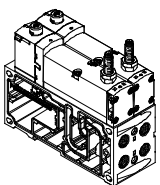

The single solenoid 5/2-way valve with spring return in width 26 mm features switching position sensing. The normal position of the piston spool valve is monitored.

Designed as a plug-in or individual connection valve with pilot valves to ISO 15218 and square plug type C. This valve is not a safety component in accordance with the Machinery Directive 2006/42/EC.

It is suitable for use in safety-related parts of control systems to EN ISO 13849-1.

➔ Page 98

Valve terminals VTSA/VTSA-F, NPT

Key features – Valves

Control block with safety function, width 26 mm

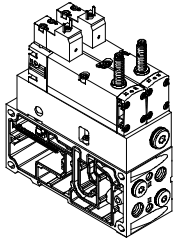

5/2-way solenoid valve
These valves are used for special applications, for example for:

- Protecting against unexpected start-up
- Safe reversing
- Drives in manually loaded devices

This control block is suitable for use as a press safety valve to EN 962.

This valve is a safety component in accordance with the Machinery Directive 2006/42/EC.

→ Page 104

Pilot air switching valve, width 18 mm, 26 mm

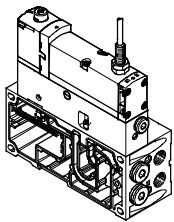

The pilot air switching valve is a combination of a 5/2-way solenoid valve with switching position sensing and the intermediate plate VABF-S4-...-S. It enables verifiable switching on and off (sensor function) of the pilot air supply from duct 1 to 14 for the entire

pressure zone or valve terminal. The piston position sensing feature is realised by means of an inductive PNP proximity sensor with cable and push-in connector in the size M12x1 to EN 61076-2-104. This valve is not a safety component in

accordance with the Machinery Directive 2006/42/EC. It is suitable for use in safety-related parts of control systems to EN ISO 13849-1.

→ Page 110



Note

The pilot air switching valve can only be operated on the valve terminal VTSA/VTSA-F in combination with a right-hand end plate for external

pilot air type VABE-S6-1RZ- Port 14 on the right-hand end plate must be sealed for this.

Soft-start valve, module width 43 mm

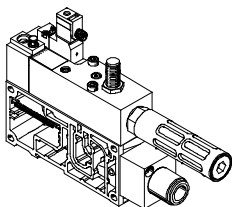

The soft-start valve is separately electrically actuated, independently of the multi-pin plug, AS-interface or field-bus connection, via a 4-pin plug to ISO 15407-1 or optionally via an M12 adapter. The valve can optionally be ordered

with a sensor that monitors switching of the soft-start valve. The soft-start valve can supply the valve terminal or one or more pressure zones with supply air. The optimum pressure build-up and filling time required by the application

for each pressure zone is configured directly on the valve terminal. A maximum of 5 soft-start valves can be integrated on one valve terminal in this way.

→ Page 118

5/3-way solenoid valve for special functions

For holding, blocking a movement (mechanically)

5/3-way solenoid valve for special functions; port 2 is pressurised, port 4 exhausted. Switching position 14 features a memory function.

Possible applications:

- Using lifting cylinders
- Using rotary cylinders

For pressureless switching, self-holding, pneumatic operation

5/3-way solenoid valve for special functions (3 phases). Mid-position is exhausted. Switching position 14 features a memory function.

Possible applications:

- Pneumatic manual clamps for devices (inserting stations)

Valve terminals VTSA/VTSA-F, NPT

Peripherals



Modular pneumatic peripherals

The modular design of the valve terminal VTSA/VTSA-F enables maximum flexibility right from the planning stage and offers maximum ease of service in operation.

The system consists of manifold sub-bases and valves. The manifold sub-bases are screwed together and thus form the support system for the valves.

Inside the manifold sub-bases are the connection ducts for supplying compressed air to and venting from the valves on the terminal as well as the working lines for the pneumatic cylinders for each valve.

Each manifold sub-base is connected to the next using four screws. Individual valve terminal sections can be isolated and further blocks easily inserted by loosening these screws. This ensures that the valve terminal can be rapidly and reliably extended.

Basic system modularity

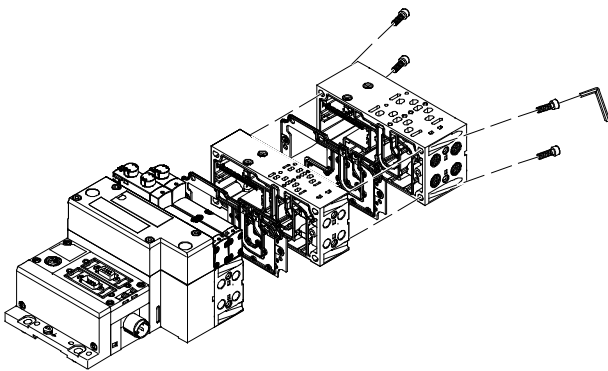

Valve modularity

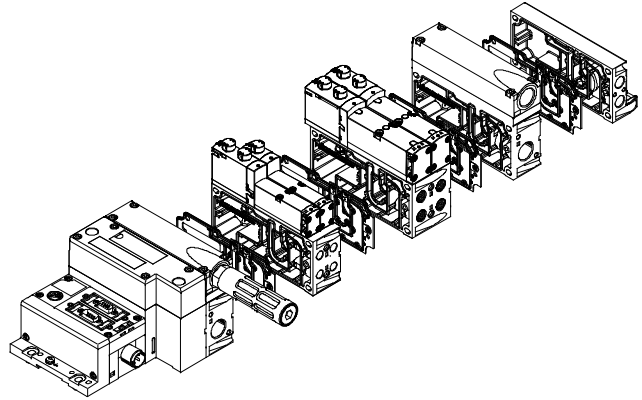

Vertical stacking modularity

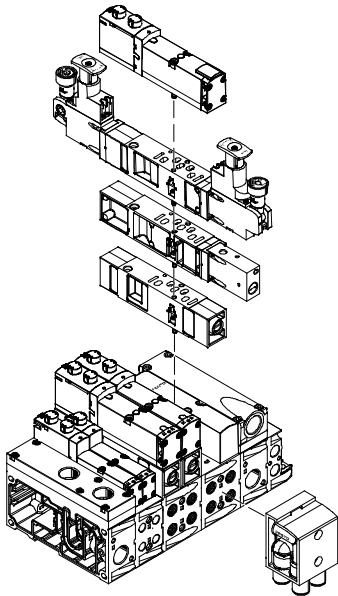

-  - Note

See also "Adaptation to width 65 mm, ISO size 3

(technology type 04)"
→ page 125

Valve terminals VTSA/VTSA-F, NPT

Peripherals

Modular electrical peripherals

The manner in which the valves are actuated differs according to whether you are using a multi-pin terminal or fieldbus terminal.

The VTSA/VTSA-F with CPX interface is based on the internal bus system of the CPX and uses this communication system for all solenoid coils and a range of electrical input and output functions.

Parallel linking enables the following:

- Transmission of switching information
- Compact design
- Position-based diagnostics
- Separate voltage supply for valves
- Flexible conversion without address shifting
- Option of CP interface
- CPX-FEC as stand-alone controller with access via Ethernet and web server
- Transmission of status, parameter and diagnostic data

→ Internet: cpx

VTSA/VTSA-F with electrical peripherals CPX

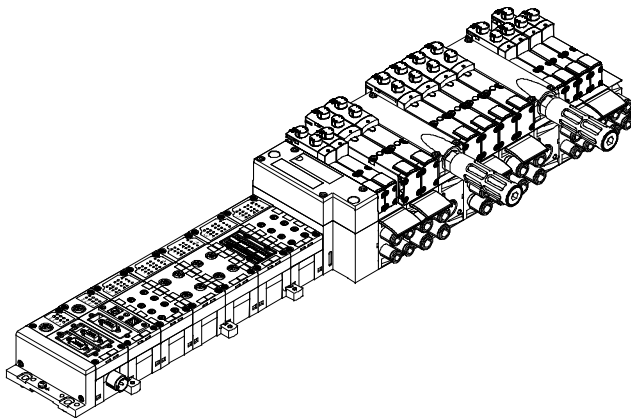

Modularity with electrical peripherals CPX

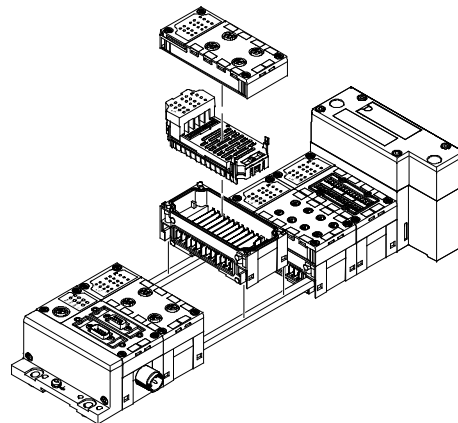

CPX terminal in metal design

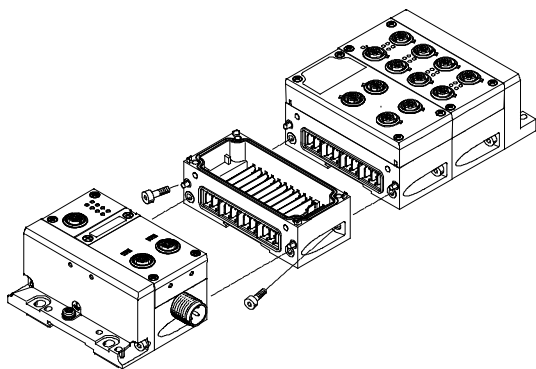

The mechanical connection between the CPX modules in metal design is created using special angle fixings. The CPX terminal can thus be expanded at any time.

-  - Note

The CPX connection blocks are also available in a metal design. This means a complete solution in a sturdy metal design can be selected for applications of the valve terminal VTSA/VTSA-F in welding environments.

Valve terminals VTSA/VTSA-F, NPT

Peripherals – Pneumatic components

Individual sub-base, width 18 mm, ISO 15407-2

Order code: Individual sub-bases can be equipped with any valve.

- Using individual part numbers

Width 18 mm with spring-loaded terminal or cable (open end)

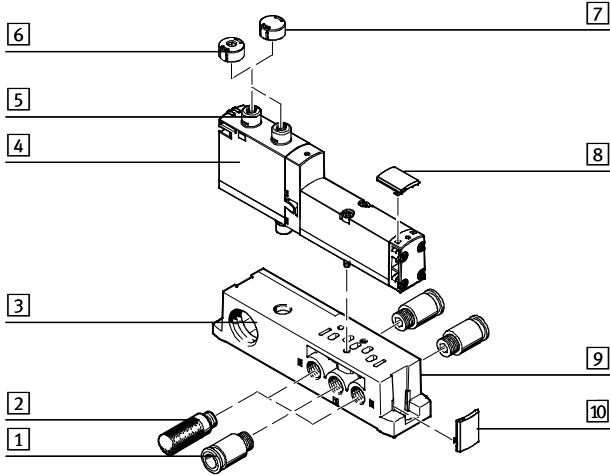

	Brief description	→ Page/Internet	
1	Fitting	1/8" NPT for working air/exhaust ports (1, 3, 5) and working ports (2, 4)	153
2	Silencer	U-1/8-B-NPT for exhaust ports (3, 5)	153
3	Electrical connection	Spring-loaded terminal, cable (open end)	–
4	Valve VSV	Width 18 mm	80
5	Manual override	Non-detenting/detenting, per solenoid coil	–
6	Cover cap	For non-detenting manual override	94
7	Cover cap	For covered manual override	94
8	Inscription label holder	For valves	97
9	Individual sub-base	For valve VSV	152
10	Inscription label holder	For manifold blocks	97

Valve terminals VTSA/VTSA-F, NPT

Peripherals – Pneumatic components

Individual sub-base, width 26 mm, ISO 15407-2

With spring-loaded terminal or cable (open end)

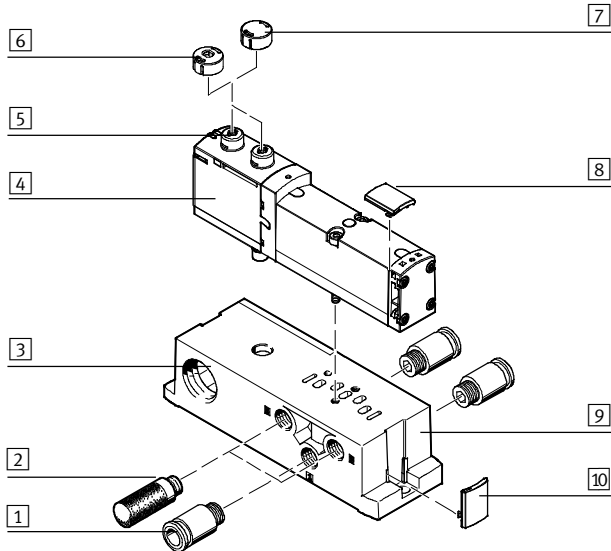

	Brief description	→ Page/Internet
1	Fitting	1/4" NPT for working air/exhaust ports (1, 3, 5) and working ports (2, 4)
2	Silencer	U-1/4-B-NPT for exhaust ports (3, 5)
3	Electrical connection	Spring-loaded terminal, cable (open end)
4	Valve VSVA	Width 26 mm
5	Manual override	Non-detenting/detenting, per solenoid coil
6	Cover cap	For non-detenting manual override
7	Cover cap	For covered manual override
8	Inscription label holder	For valves
9	Individual sub-base	For valve VSVA
10	Inscription label holder	For manifold blocks

Valve terminals VTSA/VTSA-F, NPT

Peripherals – Pneumatic components

FESTO

Individual sub-base, width 42 mm, ISO 5599-2

With spring-loaded terminal or cable (open end)

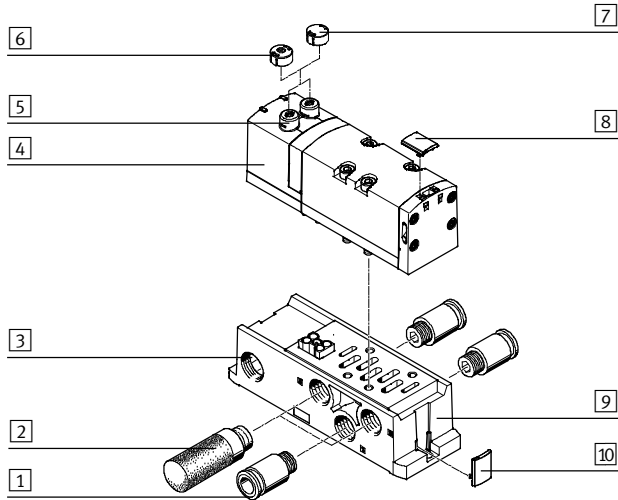

	Brief description	→ Page/Internet	
1	Fitting	3/8" NPT for working air/exhaust ports (1, 3, 5) and working ports (2, 4)	153
2	Silencer	U-3/8-B-NPT for exhaust ports (3, 5)	153
3	Electrical connection	Spring-loaded terminal, cable (open end)	–
4	Valve VSVA	Width 42 mm	82
5	Manual override	Non-detenting/detenting, per solenoid coil	–
6	Cover cap	For non-detenting manual override	94
7	Cover cap	For covered manual override	94
8	Inscription label holder	For valves	97
9	Individual sub-base	For valve VSVA	152
10	Inscription label holder	For manifold blocks	97

Valve terminals VTSA/VTSA-F, NPT

Peripherals – Pneumatic components

FESTO

Individual sub-base, width 52 mm, ISO 5599-2

With spring-loaded terminal or cable (open end)

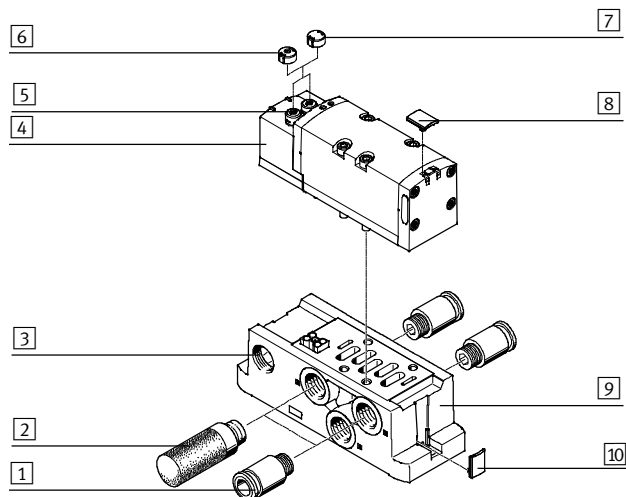

	Brief description	→ Page/Internet	
1	Fitting	1/2" NPT for working air/exhaust ports (1, 3, 5) and working ports (2, 4)	153
2	Silencer	U-1/2-B-NPT for exhaust ports (3, 5)	153
3	Electrical connection	Spring-loaded terminal, cable (open end)	–
4	Valve VSVA	Width 52 mm	83
5	Manual override	Non-detenting/detenting, per solenoid coil	–
6	Cover cap	For non-detenting manual override	94
7	Cover cap	For covered manual override	94
8	Inscription label holder	For valves	97
9	Individual sub-base	For valve VSVA	152
10	Inscription label holder	For manifold blocks	97

Valve terminals VTSA/VTSA-F, NPT

Peripherals – Pneumatic components

Valve terminal pneumatics

The manifold sub-bases for valves with a width of 18 or 26 mm are either prepared for

- 2 single solenoid valves or
- 2 double solenoid valves.

The manifold sub-bases for valves with a width of 42 or 52 mm are suitable for

- 1 single solenoid valve or
- 1 double solenoid valve.

- Double solenoid valve positions can be equipped with any valve or a blanking plate.

- Single solenoid valve positions can only be equipped with single solenoid valves or a blanking plate.

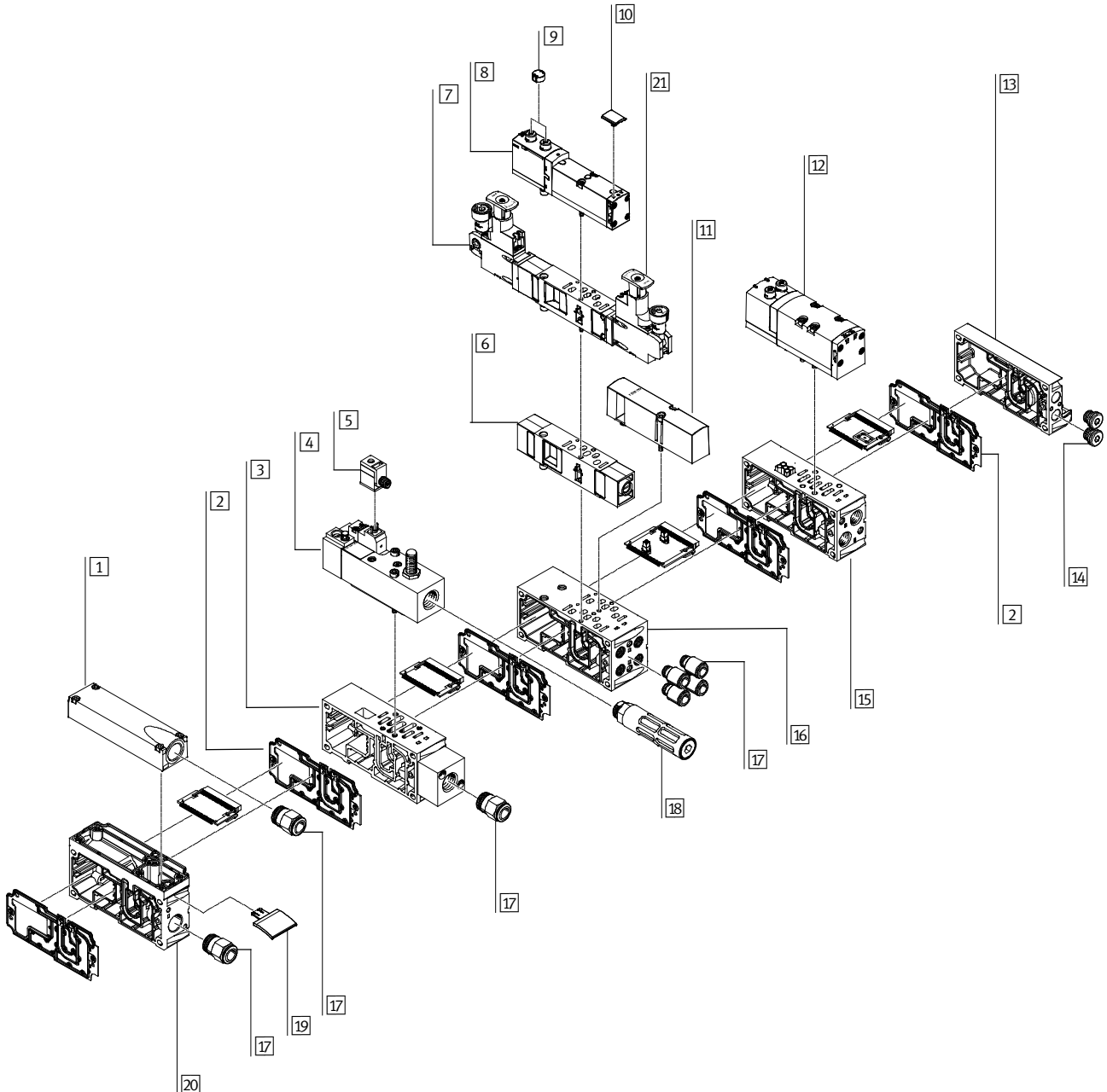

Valve terminals VTSA/VTSA-F, NPT

Peripherals – Pneumatic components

FESTO

Valve terminal pneumatics		
	Brief description	→ Page/Internet
1	Exhaust port cover	For ducted exhaust air (ports 3 and 5 combined)
2	Duct separation/seal	–
3	Manifold sub-base	For soft-start valve
4	Soft-start valve	For slow and safe pressure build-up
5	Plug socket	–
6	Flow control plate	–
7	Pressure regulator plate	–
8	Valve	Width 18 mm or 26 mm
9	Cover cap	For manual override, non-detenting, covered
10	Inscription label holder	For valve
11	Blanking plate	For unused valve position (vacant position)
12	Valve	Width 42 mm or 52 mm
13	End plate with pilot air selector	–
14	Blanking plug	–
15	Manifold sub-base VTSA	For valves with a width of 42 mm or 52 mm
15	Manifold sub-base VTSA-F	For valves with a width of 42 mm or 52 mm
16	Manifold sub-base VTSA	For valves with a width of 18 mm or 26 mm
16	Manifold sub-base VTSA-F	For valves with a width of 18 mm or 26 mm
17	Fittings	–
18	Silencer	–
19	Inscription label holder	For manifold sub-base, sub-base, 90° connection plate
20	Supply plate	–
21	Control element	Regulator knobs in different versions

Valve terminals VTSA/VTSA-F, NPT

Peripherals – Pneumatic components

Valve terminal widths

Order code for VTSA:

- 44E... for the electrical components
- 44P... for the pneumatic components

Order code for VTSA-F:

- 45E... for the electrical components
- 45P... for the pneumatic components

Regardless of the type of actuation (e.g. multi-pin plug, fieldbus, etc.), valve terminals VTSA/VTSA-F in the widths

- 18 mm
- 26 mm
- 42 mm
- 52 mm

can be combined without adapters. This enables a flow range of 400 l/min to 2,900 l/min in the case of VTSA and 700 l/min to 2,900 l/min in the case of VTSA-F to be covered on one valve terminal. A wide range of valve functions and vertical stacking components are available for all widths.

Valves with a width of 65 mm can be mixed with other widths. However, these are only configured after the adapter plate VABA and are thus always at the end of the valve terminal configuration.

See "Adaptation to width 65 mm, ISO size 3 (technology type 04)" → page 125

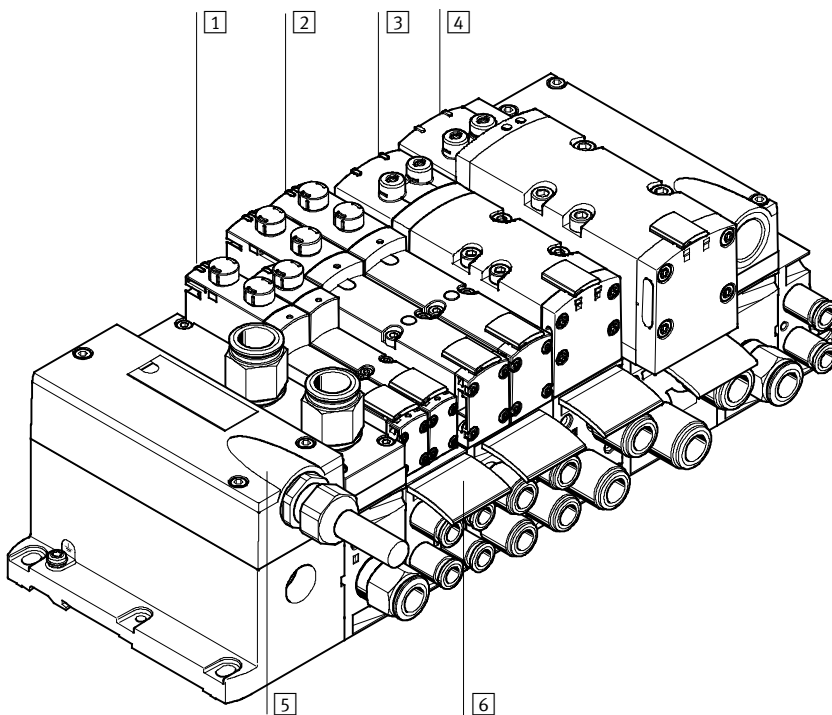

	Brief description	→ Page/Internet
1	Valve Width 18 mm	88
2	Valve Width 26 mm	88
3	Valve Width 42 mm	88
4	Valve Width 52 mm	88
5	Multi-pin plug connection Via multi-pin cable 24 V DC	95
6	Inscription labels For manifold sub-base, sub-base, 90° connection plate	97

Valve terminals VTSA/VTSA-F, NPT

Peripherals – Electrical components

Valve terminal with individual electrical connection

Order code for VTSA:

- 44E... for the electrical components
- 44P... for the pneumatic components

Order code for VTSA-F:

- 45E... for the electrical components
- 45P... for the pneumatic components

Valve terminals VTSA/VTSA-F with individual electrical connection can be expanded with up to 20 valves with max. 20 solenoid coils.

The manifold sub-bases for valves with a width of 18 or 26 mm are either prepared for

- 2 single solenoid valves or
- 2 double solenoid valves

and the manifold sub-bases for valves with a width of 42, 52 and 65 mm are prepared for

- 1 single solenoid valve or
- 1 double solenoid valve.

- Double solenoid valve positions can be equipped with any valve or a blanking plate.
- Single solenoid valve positions can only be equipped with single solenoid valves or a blanking plate.
- The electrical connection is established via a 5-pin M12 plug (24 V DC).

- Valves with a width of 65 mm cannot be mixed with other widths – these are always at the end of the valve terminal configuration. See "Adaptation to width 65 mm, ISO size 3 (technology type 04)"

→ Page 125

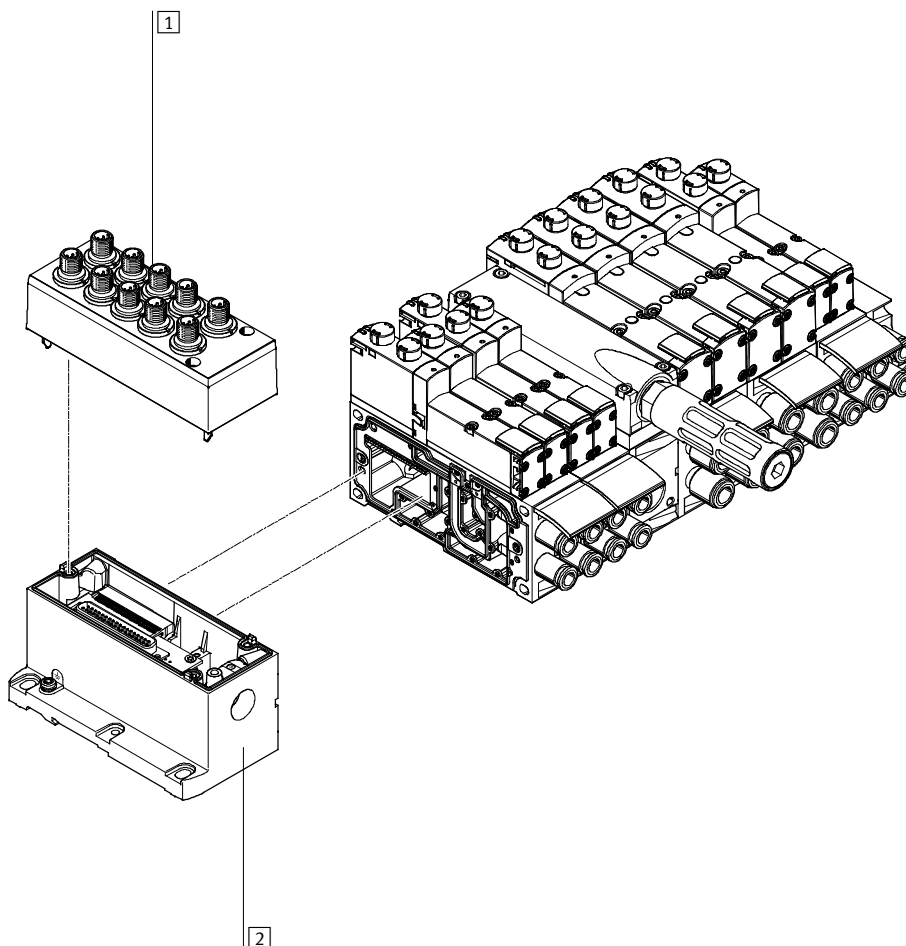

	Brief description	→ Page/Internet
1	Cover For individual connection	95
2	Multi-pin plug connection Individual connection with M12, 10-way or 6-way (including cover)	95

Valve terminals VTSA/VTSA-F, NPT

Peripherals – Electrical components

Valve terminal with electrical multi-pin plug connection

Order code for VTSA:

- 44E... for the electrical components
- 44P... for the pneumatic components

Order code for VTSA-F:

- 45E... for the electrical components
- 45P... for the pneumatic components

Valve terminals VTSA/VTSA-F with multi-pin plug connection can be expanded with up to 32 valves with max. 32 solenoid coils. The manifold sub-bases for valves with a width of 18 or 26 mm are prepared for

- 2 single solenoid valves or
- 2 double solenoid valves

and the manifold sub-bases for valves with a width of 42, 52 and 65 mm are prepared for

- 1 single solenoid valve or
- 1 double solenoid valve.

- Double solenoid valve positions can be equipped with any valve or a blanking plate.
- Single solenoid valve positions can only be equipped with single solenoid valves or a blanking plate.
- The following multi-pin plug connections to IP65 are available:
 - 37-pin Sub-D connection (24 V DC): the connecting cable can be ordered in lengths of 2.5 m, 5 m and 10 m for max. 8, 22 or 32 solenoid coils respectively.

- Terminal strip (24 V DC or 110 V AC) 19-pin round connector (24 V DC)
- Valves with a width of 65 mm cannot be mixed with other widths – these are always at the end of the valve terminal configuration. See "Adaptation to width 65 mm, ISO size 3 (technology type 04)"

→ Page 125

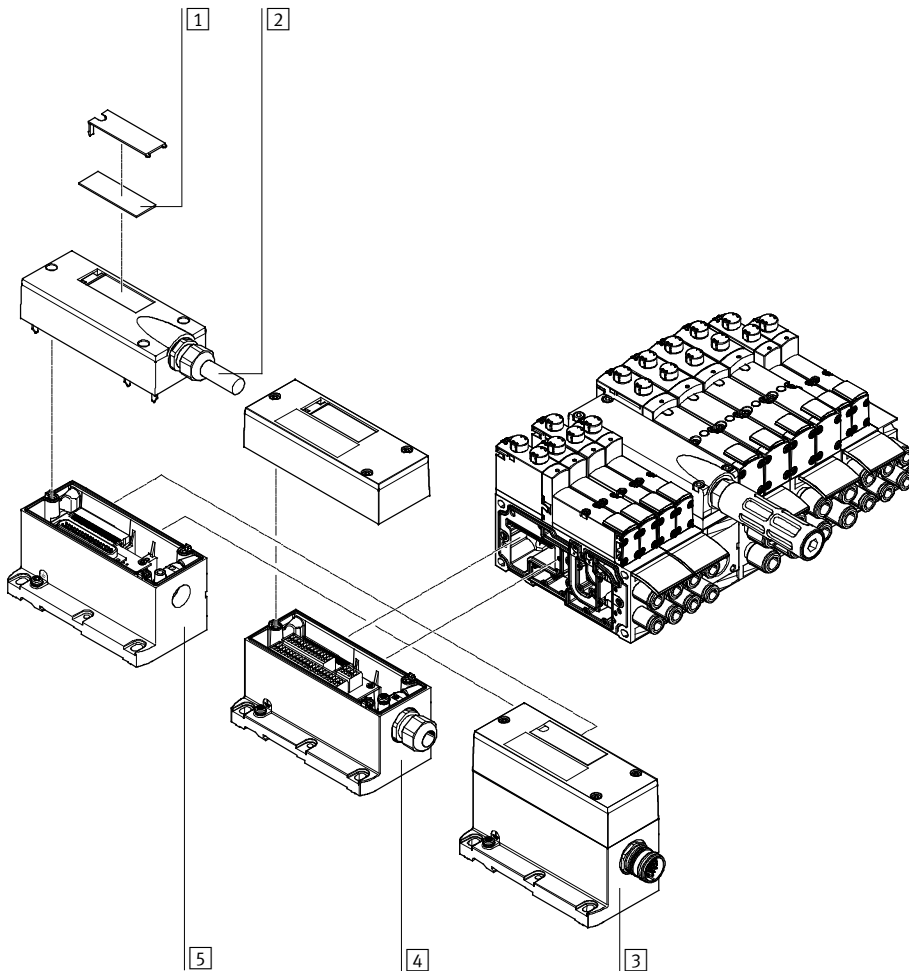

	Brief description	→ Page/Internet
1	Inscription labels Large, for multi-pin plug connection	–
2	Multi-pin plug cable –	96
3	Multi-pin plug connection Via M23 round plug connection, 24 V DC	95
4	Multi-pin plug connection Via terminal strip (Cage Clamp®), 24 V DC or 110 V AC	95
5	Multi-pin plug connection Via multi-pin cable, 24 V DC	95

Valve terminals VTSA/VTSA-F, NPT

Peripherals – Electrical components

Valve terminal with AS-interface connection

Order code for VTSA:

- 52E... for the electrical components
- 44P... for the pneumatic components

Order code for VTSA-F:

- 52E... for the electrical components
- 45P... for the pneumatic components

Valve terminals VTSA/VTSA-F with AS-interface connection can be expanded with up to 8 valves with max. 8 solenoid coils.

The manifold sub-bases for valves with a width of 18 or 26 mm are either prepared for

- 2 single solenoid valves or
- 2 double solenoid valves

and the manifold sub-bases for valves with a width of 42, 52 and 65 mm are prepared for

- 1 single solenoid valve or
- 1 double solenoid valve.

- Double solenoid valve positions can be equipped with any valve or a blanking plate.

- Single solenoid valve positions can only be equipped with single solenoid valves or a blanking plate.

- Valves with a width of 65 mm cannot be mixed with other widths – these are always at the end of the valve terminal configuration. See "Adaptation to width 65 mm, ISO size 3 (technology type 04)"

→ Page 125

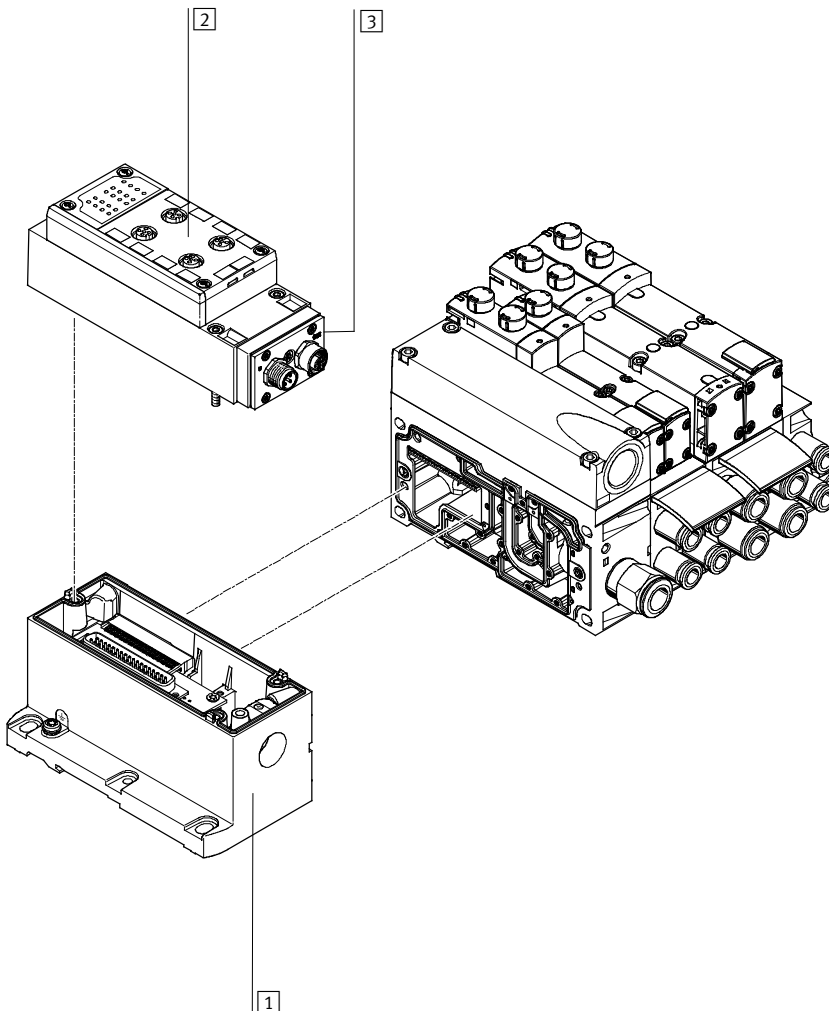

	Brief description	→ Page/Internet
1	Multi-pin plug connection	Can be ordered together with the AS-interface module as an electrical connection for AS-interface 95
2	Manifold block for AS-interface	– 96
3	AS-interface module	– 95

Valve terminals VTSA/VTSA-F, NPT

Peripherals – Electrical components

Valve terminal with fieldbus connection, control block (electrical peripherals CPX)

Order code:

- 50E-... for the electrical peripherals, plastic manifold module
- 51E-... for the electrical peripherals, metal manifold module
- 53E-... for the electrical peripherals, for control cabinet installation

For VTSA:

- 44P-... for the pneumatic components

For VTSA-F:

- 45P-... for the pneumatic components

Valve terminals VTSA/VTSA-F with fieldbus interface can be expanded with up to 32 valves with max. 32 solenoid coils.

The manifold sub-bases for valves with a width of 18 or 26 mm are either prepared for

- 2 single solenoid valves or
 - 2 double solenoid valves
- and the manifold sub-bases for valves with a width of 42, 52 and 65 mm are prepared for
- 1 single solenoid valve or
 - 1 double solenoid valve.

- Double solenoid valve positions can be equipped with any valve or a blanking plate.
- Single solenoid valve positions can only be equipped with single solenoid valves or a blanking plate.

Each valve position can be equipped with any valve or a blanking plate. The rules for CPX apply to the equipment that can be used in combination with the electrical peripherals CPX.

In general:

- Max. 10 electrical modules
- Digital inputs/outputs
- Analogue inputs/outputs

- Parameterisation of inputs and outputs
- Integrated convenient diagnostic system
- Preventive maintenance concepts

- Valves with a width of 65 mm cannot be mixed with other widths – these are always at the end of the valve terminal configuration. See "Adaptation to width 65 mm, ISO size 3 (technology type 04)"

→ Page 125

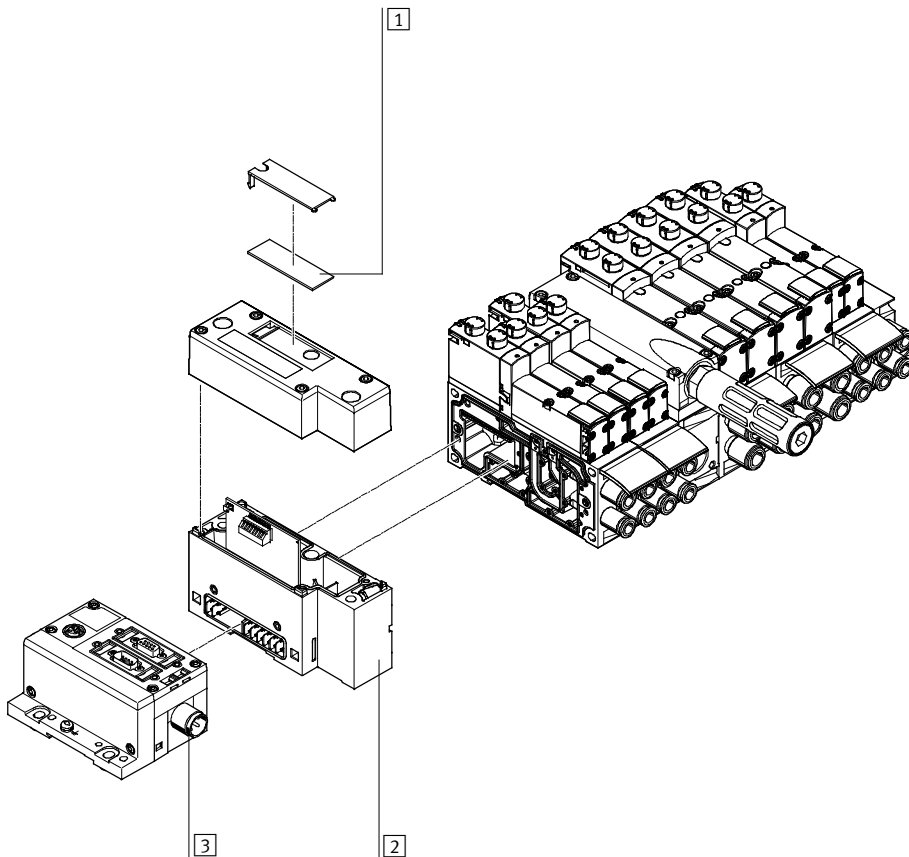

	Brief description	→ Page/Internet
1	Inscription labels Large, for pneumatic interface CPX	-
2	Pneumatic interface	95
3	Fieldbus interface	cpx

Valve terminals VTSA/VTSA-F, NPT

Peripherals – Electrical components

Valve terminal with fieldbus/multi-pin plug connection and individually electrically actuated valve

In applications with specific emergency stop conditions, it may be necessary to switch one or more valves separately from the valve terminal controller. Standard valves (VSVA) with individual electrical connection (round or square plug) are mounted on the

valve terminal to this end. In order for protection class IP65 to be achieved, the functionless opening in the sub-base for the electrical connection must be sealed. A sealing cap is available for the 18 mm and 26 mm widths.

With manifold or individual sub-bases, valves with width 42 mm and 52 mm must be used with a seal to comply with the IP protection class (see → page 94). For central control of the valve terminal via a multi-pin plug or fieldbus

connection, the valve position occupied in this way acts like a vacant position, i.e. the assigned address in the fieldbus node or the corresponding connection in the multi-pin plug connection is occupied.

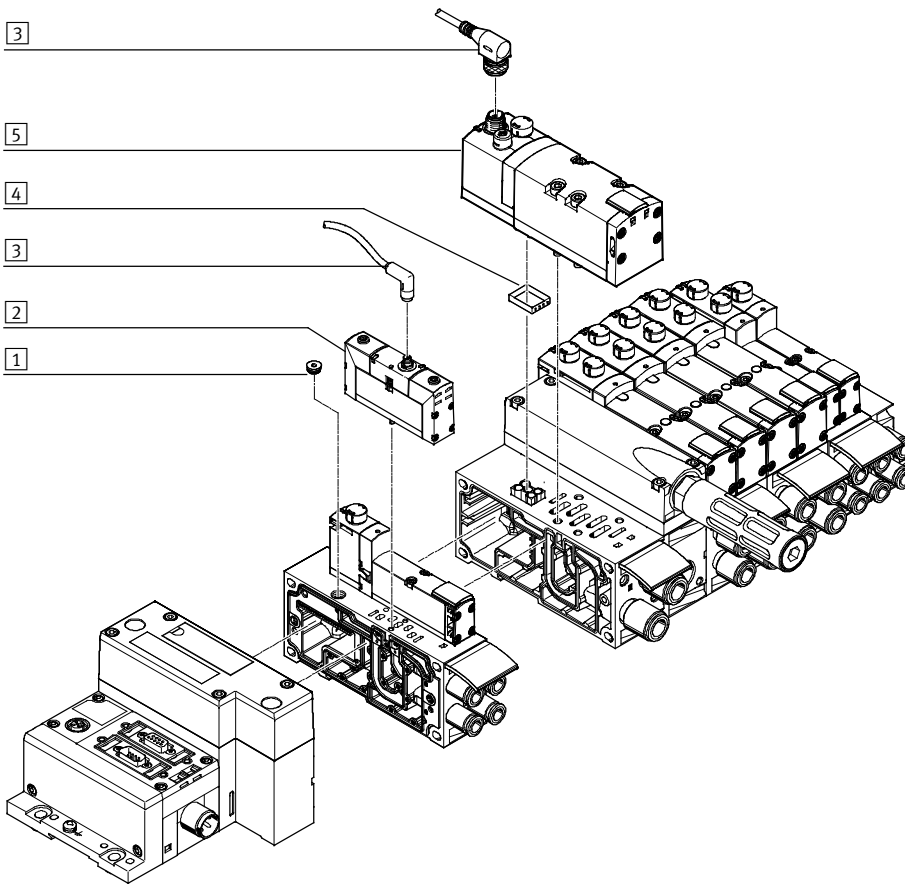

	Brief description	→ Page/Internet
1	Sealing cap	For sealing the electrical connection on the sub-base 94
2	Valve	Width 18 mm or width 26 mm valves vsva
3	Connecting cable	– valves vsva
4	Seal	For ensuring the IP protection class (with width 42 mm and 52 mm) 94
5	Valve	Width 42 mm or width 52 mm valves vsva

 Note

Standard valves VSVA can be used for valve terminal allocation. A vacant position must be provided for this in the valve terminal configurator.

The corresponding standard valve VSVA can be ordered on the Internet at:
→ vsva

Valve terminals VTSA/VTSA-F, NPT

Key features – Pneumatic components

Manifold sub-base

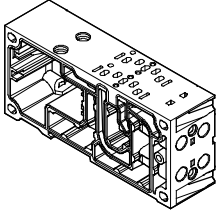

VTSA/VTSA-F is based on a modular system which consists of manifold sub-bases and valves. Manifold sub-bases are available for valve widths 18 mm and 26 mm in a double grid, i.e. two valves per manifold sub-base. For valves with a width of 42 mm or 52 mm, there are manifold sub-bases with one valve per sub-base. The manifold sub-base contains a duct seal and an electrical interlinking module.

They can be freely mixed within a valve terminal. The manifold sub-bases are screwed together and thus form the support system for the valves. Inside the manifold sub-bases are the connection ducts for supplying compressed air to and venting from the valves on the terminal as well as the working lines for the pneumatic cylinders for each valve. Each manifold sub-base is connected to the next

using four screws. Individual valve terminal sections can be isolated and further manifold sub-bases inserted by loosening these screws. This ensures that the valve terminal can be rapidly and reliably extended.

See also "Adaptation to width 65 mm, ISO size 3 (technology type 04)"

➔ Page 125

Port patterns on the manifold sub-base for one valve position

Width 18 mm

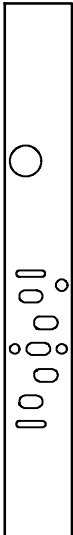

Width 26 mm

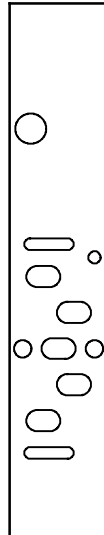

Width 42 mm

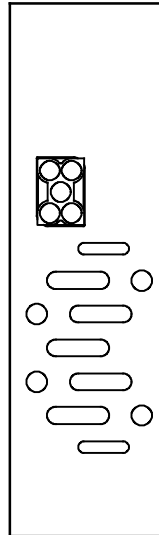

Width 52 mm

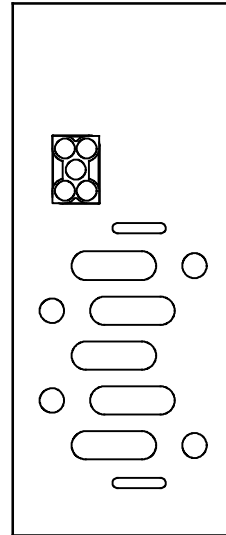

-  - Note

The illustrations shown depict a schematic representation of the pneumatic ISO port patterns.

The port patterns on the valve terminal VTSA-F do not correspond to the ISO standard.

Valve terminals VTSA/VTSA-F, NPT

Key features – Pneumatic components



Manifold sub-base variants with QS fitting, valve terminal VTSA									
Code		Type	Width				No. of valve positions (solenoid coils) ¹⁾	Working ports (2, 4)	
			18 mm	26 mm	42 mm	52 mm		Code M large	Code N small
Manifold sub-base for double solenoid valves									
A		VABV-S4-2S-N18-2T2	■	-	-	-	2 (4)	QB-1/8-5/16-U	-
AK								-	QB-1/8-1/4-U
B		VABV-S4-1S-N14-2T2	-	■	-	-	2 (4)	QB-1/4-3/8-U	-
BK								-	QB-1/4-5/16-U
C		VABV-S2-1S-N38-T2	-	-	■	-	1 (2)	QB-3/8-3/8-U	-
CK								-	QB-3/8-1/2-U
D	VABV-S2-2S-N12-T2	-	-	-	■	1 (2)	QB-1/2-1/2-U	-	
DK							-	-	
Manifold sub-base for single solenoid valves									
E		VABV-S4-2S-N18-2T1	■	-	-	-	2 (2)	QB-1/8-5/16-U	-
EK								-	QB-1/8-1/4-U
F		VABV-S4-1S-N14-2T1	-	■	-	-	2 (2)	QB-1/4-3/8-U	-
FK								-	QB-1/4-5/16-U
G		VABV-S2-1S-N38-T1	-	-	■	-	1 (1)	QB-3/8-1/2-U	-
GK								-	QB-3/8-3/8-U
H	VABV-S2-2S-N12-T1	-	-	-	■	1 (1)	QB-1/2-1/2-U	-	
HK							-	-	

1) Value in brackets is max. number of controllable solenoid coils

Valve terminals VTSA/VTSA-F, NPT

Key features – Pneumatic components

Manifold sub-base variants with QS fitting, valve terminal VTSA-F									
Code	Image	Type	Width				No. of valve positions (solenoid coils) ¹⁾	Working ports (2, 4)	
			18 mm	26 mm	42 mm	52 mm		Code M large	Code N small
Manifold sub-base for double solenoid valves									
A		VABV-S4-2HS-N18-2T2	■	-	-	-	2 (4)	QB-1/8-5/16-U	-
AK								-	QB-1/8-1/4-U
B		VABV-S4-1HS-N14-2T2	-	■	-	-	2 (4)	QB-1/4-3/8-U	-
BK								-	QB-1/4-5/16-U
C		VABV-S2-1S-N38-T2	-	-	■	-	1 (2)	QB-3/8-1/2-U	-
CK								-	QB-3/8-3/8-U
D	VABV-S2-2S-N12-T2	-	-	-	■	1 (2)	QB-1/2-1/2-U	-	
DK							-	-	
Manifold sub-base for single solenoid valves									
E		VABV-S4-2HS-N18-2T1	■	-	-	-	2 (2)	QB-1/8-5/16-U	-
EK								-	QB-1/8-1/4-U
F		VABV-S4-1HS-N14-2T1	-	■	-	-	2 (2)	QB-1/4-3/8-U	-
FK								-	QB-1/4-5/16-U
G		VABV-S2-1S-N38-T1	-	-	■	-	1 (1)	QB-3/8-1/2-U	-
GK								-	QB-3/8-3/8-U
H	VABV-S2-2S-N12-T1	-	-	-	■	1 (1)	QB-1/2-1/2-U	-	
HK							-	-	

1) Value in brackets is max. number of controllable solenoid coils

90° connection plate for working ports 2 and 4 with NPT thread									
Code	Image	Type	Width				Ports	Working ports (2, 4) on the 90° connection plate	
			18 mm	26 mm	42 mm	52 mm			
P		VABF-S4-...-A2G2-N...	■	-	-	-	2 and 4	1/8" NPT	
-			■	-	-	1/4" NPT			
-			-	■	-	3/8" NPT			
-			-	-	■	1/2" NPT			

Valve terminals VTSA/VTSA-F, NPT

Key features – Pneumatic components

Sub-base valve

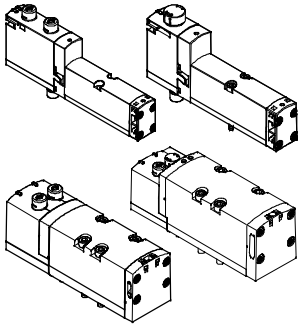

All valves are fitted with piston spool and patented sealing system, which ensures efficient sealing, a broad operating pressure range and long service life.

Sub-base valves can be quickly replaced since the tubing connections remain on the sub-base. Irrespective of the valve function

there are sub-base valves with one solenoid coil (single solenoid) or with two solenoid coils for double solenoid or double valve functions.

Reverse/vacuum operation

Select reverse operation (code Z) if you wish to operate an actuator (cylinder) with different pressures for

the forward and return stroke. Please note that the valves must then be operated via a separate pressure zone.

The reversible 3/2-way solenoid valves are also suitable for vacuum operation.

Reverse operation is only possible in pressure zones with external pilot air supply.

 Note

- If a pressure zone is in reverse mode, supply air is connected at port 3/5 and exhausting takes place at port 1 at all valve positions in this pressure zone.
- Reversible pressure regulators cannot be selected when a pressure zone is in reverse mode.
- With reversible pressure regulators, only the valve at this position is in reverse mode.
- When using 5/3-way valves in reverse mode, the mid-position function switches from exhausted to pressurised and vice versa.

Blanking plate

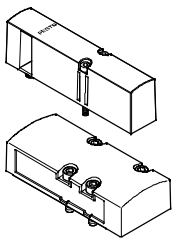

Plate without valve function for reserving valve positions on a valve terminal.

Valves and blanking plates are attached to the manifold sub-base using screws.

Design

Valve replacement

The valves are attached to the metal manifold sub-base using two or four screws, which means that they can be

easily replaced. The mechanical robustness of the manifold sub-base guarantees efficient long-term sealing.

Expansion

Vacant positions can be fitted with valves at a later date. The dimensions, mounting points and existing pneumatic installations remain unchanged during this process.

For more information and technical data on expansion, refer to the manual:

➔ Internet: P:BE-VTSA-44

Valve terminals VTSA/VTSA-F, NPT

Key features – Pneumatic components

Valve function						
Code	Circuit symbol	Width				Description
		18 mm	26 mm	42 mm	52 mm	
VC		■	■	■	■	2x 2/2-way valve, single solenoid <ul style="list-style-type: none"> • Normally closed • Pneumatic spring return
VV		■	■	■	-	2x 2/2-way valve, single solenoid <ul style="list-style-type: none"> • Reverse operation • Normally closed • Pneumatic spring return • Vacuum operation possible at 3 and 5
N		■	■	■	■	2x 3/2-way valve, single solenoid <ul style="list-style-type: none"> • Normally open • Pneumatic spring return • Operating pressure > 3 bar
K		■	■	■	■	2x 3/2-way valve, single solenoid <ul style="list-style-type: none"> • Normally closed • Pneumatic spring return • Operating pressure > 3 bar
H		■	■	■	■	2x 3/2-way valve, single solenoid <ul style="list-style-type: none"> • Normal position <ul style="list-style-type: none"> - 1x closed - 1x open • Pneumatic spring return • Operating pressure > 3 bar
P		■	■	■	■	2x 3/2-way valve, single solenoid <ul style="list-style-type: none"> • Reverse operation only • Normally open • Pneumatic spring return
Q		■	■	■	■	2x 3/2-way valve, single solenoid <ul style="list-style-type: none"> • Reverse operation only • Normally closed • Pneumatic spring return
R		■	■	■	■	2x 3/2-way valve, single solenoid <ul style="list-style-type: none"> • Reverse operation only • Normal position <ul style="list-style-type: none"> - 1x closed - 1x open • Pneumatic spring return

-  - Note

A filter must be installed upstream of valves operated in vacuum mode. This prevents any foreign matter in the intake air getting into the valve (e.g. when operating a suction cup).

Valve terminals VTSA/VTSA-F, NPT

Key features – Pneumatic components

Valve function						
Code	Circuit symbol	Width				Description
		18 mm	26 mm	42 mm	52 mm	
M		■	■	■	■	5/2-way valve, single solenoid • Reverse operation • Pneumatic spring return
O		■	■	■	■	5/2-way valve, single solenoid • Reverse operation • Mechanical spring return
J		■	■	■	■	5/2-way valve, double solenoid
D		■	■	■	■	5/2-way valve, double solenoid • Dominant signal at port 14 on the control side
SO SQ		-	■	-	-	5/2-way solenoid valve ²⁾ , single solenoid, as plug-in or via pilot valve with pneumatic interface to ISO 15218 See also special valve function in the section "Control block with safety function" → page 104
B		■	■	■	■	5/3-way solenoid valve • Mid-position pressurised ¹⁾ • Mechanical spring return
G		■	■	■	■	5/3-way solenoid valve • Mid-position closed ¹⁾ • Mechanical spring return
E		■	■	■	■	5/3-way solenoid valve • Mid-position exhausted ¹⁾ • Mechanical spring return
SA		-	■	-	-	5/3-way solenoid valve, for special functions through signal storage in switching position 14 • Pressureless switching, self-holding, pneumatic operation • Mid-position exhausted, switching position 14 with memory function • Mechanical spring return
SB		-	■	-	-	5/3-way solenoid valve, for special functions through signal storage in switching position 14 • Holding, blocking a movement (mechanically) • Mid-position: port 2 pressurised, port 4 exhausted, switching position 14 with memory function • Mechanical spring return
VG		-	-	■	■	5/3-way solenoid valve • Positioning • Mid-position: port 2 pressurised, port 4 closed ¹⁾ • Mechanical spring return
L	-	■	■	■	■	For valve terminal only: Blanking plate for vacant valve position

1) If neither solenoid coil is energised, the valve moves to its mid-position by means of a mechanical spring. If the two coils are permanently energised one after the other, the valve remains in the switching position of the coil that was activated first.
2) The symbol represents a valve with a proximity sensor with a switching output signal, in the illustration an N/O contact. In accordance with ISO 1219-1, this symbol applies to both N/O contacts as well as N/C contacts. The switching element function of all sensors used here is an N/C contact.

Valve terminals VTSA/VTSA-F, NPT

Key features – Pneumatic components

Vertical stacking

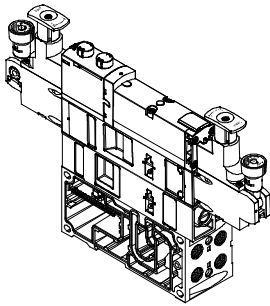

Additional functions can be added to each valve position between the sub-base (manifold sub-base) and the valve. These functions are known as vertical stacking modules and enable

special functioning or control of an individual valve position. Combinations of several valve sizes on one valve terminal are possible.

 Note
Certain combinations are not recommended due to the design of the individual vertical stacking components.

Vertical stacking components

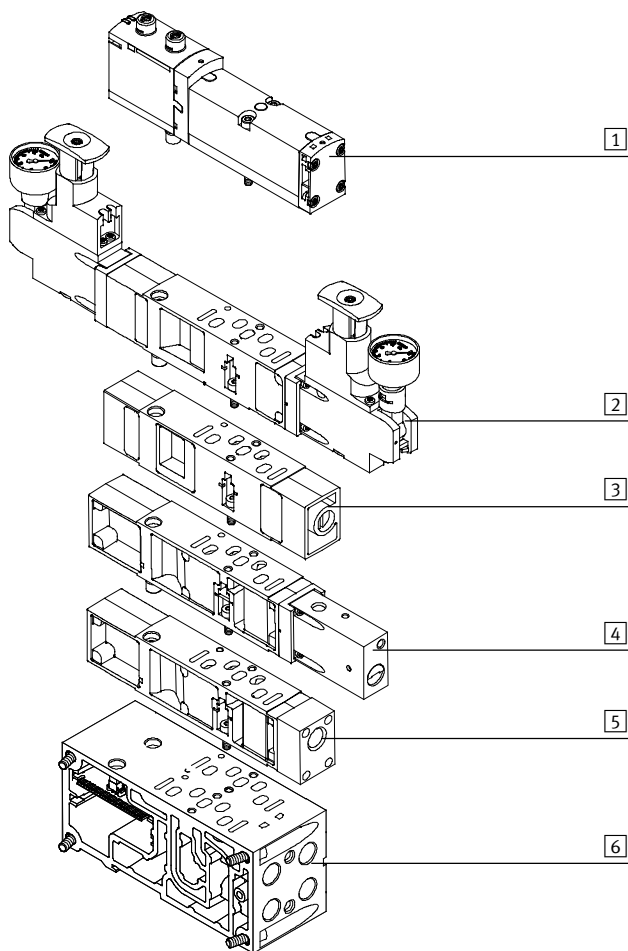

The following component sequence is recommended for valve positions with vertical stacking:

- 1 Valve VSVA
- 2 Pressure regulator plate
- 3 Flow control plate
- 4 Vertical pressure shut-off plate
- 5 Vertical supply plate
- 6 Manifold sub-base

Valve terminals VTSA/VTSA-F, NPT

Key features – Pneumatic components



Vertical stacking

Pressure regulator plate

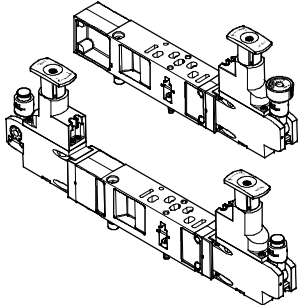

An adjustable pressure regulator can be installed between the sub-base (manifold sub-base) and the valve in order to control the force of the triggered actuator.

This pressure regulator maintains an essentially constant output pressure (secondary side) independent of pressure fluctuations (primary side) and air consumption. Also suitable for valves with symmetrical coil layout (one valve on each side).

Standard version:

- Standard port pattern to ISO 15407-2 or ISO 5599-2
- For supply pressure up to 6 bar or up to 10 bar
- Without pressure gauge (optional)
- Regulator knob with 3 positions (locked, reference position, free running)

Note

With the A, B and AB pressure regulators VABF-S...-1-..., the control pressure should not be under 2 bar.

Use the reversible A, B or AB pressure regulators for control pressures under 2 bar.

Note

Please note for repeat orders of pressure regulators in sizes 42 mm and 52 mm: The part number imprinted on the regulator plate refers only to the standard equipment.

When reordering pressure regulators with additional features, such as a lockable rotary knob, extended design, etc., only use the VABF configurator.

➔ Internet: vabf-s2

Mode of operation of the pressure regulator plate (P regulator) for port 1; code: ZA, ZAY, ZF, ZFY

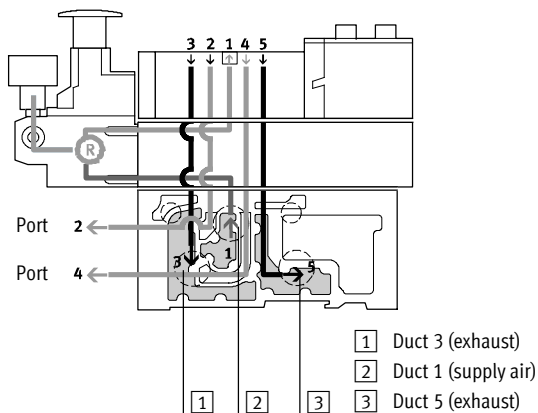

This pressure regulator regulates the pressure upstream of the valve in duct 1. Ducts 2 and 4 thus have the same regulated pressure.

During venting, the exhaust flow in the valve is from duct 2 to duct 3 and from duct 4 to duct 5.

Advantages

- The pressure regulator is not affected by venting, since the pressure is regulated upstream of the valve.
- The pressure regulator can always be adjusted, since the pressure from the valve terminal is always present.

Application examples

- An equal working pressure is required at working ports 2 and 4. (e.g. 3 bar) than the operating pressure present on the valve terminal (e.g. 8 bar) is required.
- A lower working pressure

Valve terminals VTSA/VTSA-F, NPT

Key features – Pneumatic components

FESTO

Vertical stacking

Mode of operation of the pressure regulator plate (AB regulator) for ports 2 and 4; code: ZD, ZDY, ZI, ZIY

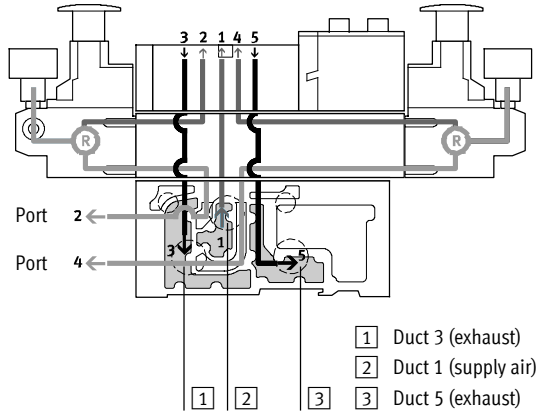

This pressure regulator regulates the pressure in ducts 2 and 4 after the pressure medium flows through the valve. During venting, the exhaust flow in the valve is from duct 2 to duct 3 and from duct 4 to duct 5 via the pressure regulator.

Example with the following switching position:
The supply air flows from duct 1 of the manifold sub-base via the valve to duct 2, it is then regulated and made available at port 2 of the manifold sub-base. At the same time, venting takes place via duct 4 of the manifold sub-base, via the regulator and via the valve into duct 5 of the manifold sub-base.

Restrictions

- The pressure regulator cannot be adjusted in the exhaust position. For example, the pressure regulator for duct 4 cannot be adjusted when the valve is pressurised in the switching position from duct 1 to duct 2 and vented from duct 4 to duct 5.

Application examples

- Two different working pressures are required at ports 2 and 4 instead of the valve terminal operating pressure.

Valve terminals VTSA/VTSA-F, NPT

Key features – Pneumatic components

Vertical stacking

Mode of operation of the pressure regulator plate (AB regulator, reversible) for ports 2 and 4, reversible; code: ZE, ZEY, ZJ, ZJY

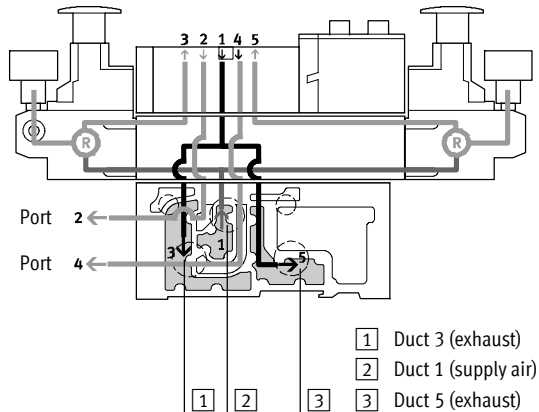

With this pressure regulator, the supply air (duct 1) is split and routed directly to both pressure regulators. In each case the regulated supply air is present in ducts 3 and 5 on the valve. The valve is thus operated in reversible mode.

This means:

- Duct 3 routes the working pressure to port 2
- Duct 5 routes the working pressure to port 4

Example with the following switching position:

The supply air in duct 1 is split between ducts 3 and 5 in the regulator and flows from here to the valve. In the valve, the supply air is routed to port 2 of the manifold sub-base. The exhaust air is simultaneously routed via duct 4 of the manifold sub-base and via the valve to regulator duct 1, where it is split between ducts 3 and 5 and then expelled via the manifold sub-base.

Application examples

- Two different pressures are required in ducts 2 and 4 instead of the valve terminal's operating pressure.
- Fast venting is required.
- The pressure regulator must always be adjustable.

Note

- Reversible pressure regulator plates should only be combined with valves that can be operated in reversible mode.
- Valves in valve positions with vertical pressure shut-off plates are operated with internal pilot air supply, even when the valve terminal is operated with external pilot air supply.
- The following combination of reversible valve terminals with vertical stacking components is not permitted:
 - Reversible pressure regulator plates
 - Flow control plates
 - Vertical pressure shut-off plates
 - Vertical supply plates

Advantages

- Fast cycle times.
- 50% higher exhaust flow rate, as air is not vented via the pressure regulator. The load on the pressure regulator is also reduced.
- No quick exhaust valves are required.
- Operating pressure is always present at the pressure regulator, as the pressure is regulated upstream of the valve, i.e. the regulator can always be adjusted.

Disadvantages

- 2x 3/2-way solenoid valves (code N, K, H) cannot be used, as pressure is present at ports 3 and 5.
- No practical combination with a flow control plate possible.

Valve terminals VTSA/VTSA-F, NPT

Key features – Pneumatic components

Vertical stacking – Pressure regulator plate, variants ¹⁾									
Code	Type	Width				Output pressure		Description	
		18 mm	26 mm	42 mm	52 mm	6 bar	10 bar		
Pressure regulator plate for port 1 (P regulator)									
ZA		VABF-S...-R1C2-C-10	■	■	■	■	–	■	Regulates the operating pressure in duct 1 upstream of the solenoid directional control valve
ZAY ²⁾		VABF-S...-R1C2-C-10-E	■	■	■	■	–	■	
ZF		VABF-S...-R1C2-C-6	■	■	■	■	■	–	
ZFY ²⁾		VABF-S...-R1C2-C-6-E	■	■	■	■	■	–	
Pressure regulator plate for port 2 (B regulator)									
ZC		VABF-S...-R2C2-C-10	■	■	■	■	–	■	Regulates the operating pressure in duct 2 downstream of the solenoid directional control valve
ZCY ²⁾		VABF-S...-R2C2-C-10-E	■	■	■	■	–	■	
ZH		VABF-S...-R2C2-C-6	■	■	■	■	■	–	
ZHY ²⁾		VABF-S...-R2C2-C-6-E	■	■	■	■	■	–	
Pressure regulator plate for port 4 (A regulator)									
ZB ²⁾		VABF-S...-R3C2-C-10	■	■	■	■	–	■	Regulates the operating pressure in duct 4 downstream of the solenoid directional control valve
ZG ²⁾		VABF-S...-R3C2-C-6	■	■	■	■	■	–	
Pressure regulator plate for ports 2 and 4 (AB regulator)									
ZD		VABF-S...-R4C2-C-10	■	■	■	■	–	■	Regulates the working pressure in ducts 2 and 4 downstream of the solenoid directional control valve
ZDY ²⁾		VABF-S...-R4C2-C-10-E	■	■	■	■	–	■	
ZI		VABF-S...-R4C2-C-6	■	■	■	■	■	–	- Note These pressure regulator plates cannot be combined with reversible 2x 3/2-way solenoid valves (code P, Q, R).
ZIY ²⁾		VABF-S...-R4C2-C-6-E	■	■	■	■	■	–	

1) These functions are available via the pressure regulator configurator VABF-S2 for width 42 mm and 52 mm (ISO 5599-2, ISO 1 and ISO 2)

2) Also suitable for valves with symmetrical coil layout

Valve terminals VTSA/VTSA-F, NPT

Key features – Pneumatic components

Vertical stacking – Pressure regulator plate, reversible, variants ¹⁾									
Code		Type	Width				Output pressure		Description
			18 mm	26 mm	42 mm	52 mm	6 bar	10 bar	
Pressure regulator plate for port 2, reversible (B regulator)									
ZL		VABF-S...-R6C2-C-10	■	■	■	■	–	■	Reversible pressure regulator for port 2
ZLY ²⁾		VABF-S...-R6C2-C-10-E	■	■	■	■	–	■	
ZN		VABF-S...-R6C2-C-6	■	■	■	■	■	–	
ZNY ²⁾		VABF-S...-R6C2-C-6-E	■	■	■	■	■	–	
Pressure regulator plate for port 4, reversible (A regulator)									
ZK ²⁾		VABF-S...-R7C2-C-10	■	■	■	■	–	■	Reversible pressure regulator for port 4
ZM ²⁾		VABF-S...-R7C2-C-6	■	■	■	■	■	–	
Pressure regulator plate for ports 2 and 4, reversible (AB regulator)									
ZE		VABF-S...-R5C2-C-10	■	■	■	■	–	■	<ul style="list-style-type: none"> Reversible pressure regulator for ports 2 and 4 Pressure regulation upstream of the solenoid directional control valve Routes the operating pressure from duct 1 to ducts 3 and 5 Routes the exhaust air from duct 1 to ducts 3 and 5
ZEY ²⁾		VABF-S...-R5C2-C-10-E	■	■	■	■	–	■	
ZJ		VABF-S...-R5C2-C-6	■	■	■	■	■	–	
ZJY ²⁾		VABF-S...-R5C2-C-6-E	■	■	■	■	■	–	

1) These functions are available via the pressure regulator configurator VABF-S2 for width 42 mm and 52 mm (ISO 5599-2, ISO 1 and ISO 2)

2) Also suitable for valves with symmetrical coil layout

- - Note
These pressure regulator plates cannot be combined with standard 2x 3/2-way solenoid valves (code N, K, H).
Reversible 2x 3/2-way solenoid valves (code P, Q, R) must not be operated in a separate pressure zone in combination with these pressure regulators.

Valve terminals VTSA/VTSA-F, NPT

Key features – Pneumatic components

Vertical stacking – Pressure regulator plate type codes

		VABF	-	S2	-	1	R1	C2	-	C	-	6	-	L1	-	E
Valve series																
VABF	Regulator plate															
Allocation																
S2	ISO 5599-2 ¹⁾															
S4	ISO 15407-2															
Valve size																
1	26 mm (ISO 15407-2, size 01)															
2	18 mm (ISO 15407-2, size 02)															
1	42 mm (ISO 5599-2, size ISO 1)															
2	52 mm (ISO 5599-2, size ISO 2)															
Function plate																
R1	Pressure regulator, port 1															
R2	Pressure regulator, port 2															
R3	Pressure regulator, port 4															
R4	Pressure regulator, ports 2 and 4															
R5	Pressure regulator, ports 2 and 4, reversible															
R6	Pressure regulator, port 2, reversible															
R7	Pressure regulator, port 4, reversible															
Pressure display																
C2	Sealed															
C3	Pressure gauge [bar] ¹⁾															
C4	Pressure gauge [MPa] ¹⁾															
C6	Pressure gauge [psi] ¹⁾															
Pneumatic connection																
C	Sealed															
Pressure range																
6	6 bar															
10	10 bar															
Control element²⁾																
-	Short (standard button)															
L1	Long															
L2	Long, lockable															
K2	Short, lockable															
K3	With integrated lock															
Optional																
E	Extended design ¹⁾															

1) These functions are available via the pressure regulator configurator VABF-S2 for width 42 mm and 52 mm (ISO 5599-2, ISO 1 and ISO 2) only. Alternatively they can be selected for all four sizes in the valve terminal configurator or via their own order numbers in the chapter Accessories on page 93

2) All variants are only possible for VABF-S2

Valve terminals VTSA/VTSA-F, NPT

Key features – Pneumatic components



Vertical stacking

Flow control plate

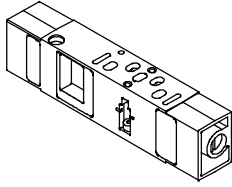

The flow control plate is equipped with two flow control valves on which the exhaust air flow rate at exhaust ports 3 or 5 can be adjusted. This enables the movement of the drive to

be initiated and the desired speed to be set on the valve terminal using the manual override. Ducts 3 and 5 can be adjusted independently of each other.



Note

On reversible valve terminals, supply air flow control takes place in ducts 3 and 5 upstream of the valve.

Code	Type	Width				Description
		18 mm	26 mm	42 mm	52 mm	
X	VABF-S4-...F1B1-C	■	■	■	■	<ul style="list-style-type: none"> Restricts the exhaust air downstream of the valve in ducts 3 and 5

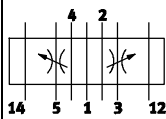

Vertical pressure shut-off plate

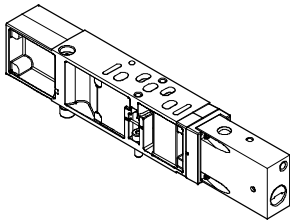

The vertical pressure shut-off plate is equipped with a switch via which the compressed air supply can be shut off. This enables a solenoid directional control valve or subsequent vertical stacking plate to be replaced without switching off the overall air supply. If the control chain has a redundant

connection, the cycle can continue in the case of a cyclical control system. Following activation of the shut-off, the exhaust air/return air from the actuated valve is expelled via the M5 threaded connection in the case of width 18 and 26 mm and via duct 3 in the case of width 42 and 52 mm.



Note

It must be ensured that the operating pressure of the valve terminal lies within the range of the required pilot pressure (i.e. min. 3 bar). When using the end plate with pilot air selector, only the switching position with the code W and U can be used.

Code	Type	Width				Description
		18 mm	26 mm	42 mm	52 mm	
ZT	VABF-S...L1D1-C	■	■	-	-	<ul style="list-style-type: none"> 3/2-way solenoid valve for shutting off the operating pressure at the valve position Blocks ducts 1 and 14 for the valve position
	VABF-S...L1D1-C	-	-	■	■	<ul style="list-style-type: none"> Supplies the valve position with internal pilot air Pressure separation at the valve assembly
ZS	VABF-S...L1D2-C	■	■	-	-	<ul style="list-style-type: none"> 3/2-way solenoid valve for shutting off the operating pressure at the valve position Blocks ducts 1 and 14 for the valve position Supplies the valve position with internal pilot air Key-operated pressure separation at the valve assembly

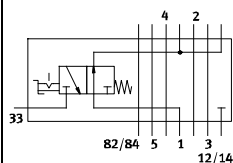
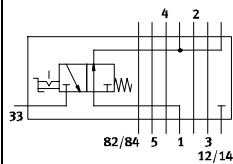

Valve terminals VTSA/VTSA-F, NPT

Key features – Pneumatic components

Vertical supply plate

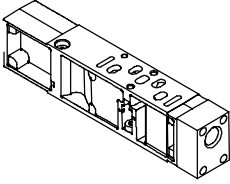

This plate enables a valve to be supplied with individual operating pressure independently of the operating pressure of the valve terminal.

As additional pressure supply for a valve. To supply an additional pressure zone.

Code	Type	Width				Description
		26 mm	18 mm	42 mm	52 mm	
ZU	VABF-S-...P1A3-...	■	■	■	■	<ul style="list-style-type: none"> Plate with port 11 for supplying individual operating pressure to a valve position, duct 1
ZV	VABF-S-...P1A14-...	■	■	■	■	<ul style="list-style-type: none"> Plate with port 11 for supplying individual operating pressure to a valve position, ducts 1 and 14

Valve terminals VTSA/VTSA-F, NPT

Key features – Pneumatic components

Compressed air supply and venting

Right-hand end plate, internal pilot air supply

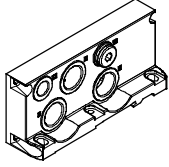

- Code V

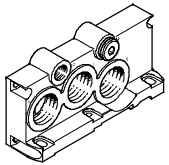

- Code V1, V3

Right-hand end plate, external pilot air supply

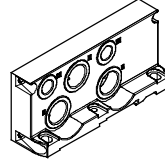

- Code X

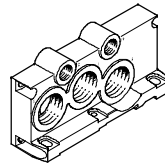

- Code X1, X3

Right-hand end plate, size ISO 3, internal pilot air supply

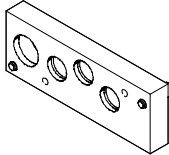

- Code V2, for width 65 mm

Right-hand end plate, size ISO 3, external pilot air supply

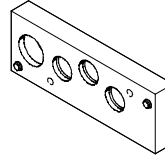

- Code X2, for width 65 mm

Right-hand end plate with pilot air selector

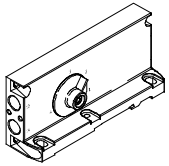

- Code Z, Y, W, U
- Code Z: selector position 1, external pilot air supply
- Code Y: selector position 2, internal pilot air supply

- Code W: selector position 3, external pilot air supply (ducted)

- Code U: selector position 4, internal pilot air supply (ducted)

The valve terminal VTSA/VTSA-F can be supplied with compressed air at one or more points. This is a reliable way of ensuring that all functional components will always offer good performance, even with large-scale

extensions. The valve terminal is generally supplied via supply plates (max. 16 per valve terminal) and/or via the right-hand end plate. When using valves with a width of 65 mm, the compressed air can also be

supplied and vented using the adapter plate VABA-.... Venting is via silencers or ports for ducted exhaust air on the supply plates and/or on the right-hand end plate.

Note
Compressed air supply and venting for size ISO 3 is described in a separate chapter on adaptation to width 65 mm (internal/external pilot air is regulated via MUH plate (solenoid valve)).

Supply plates, exhaust port 3/5 separated

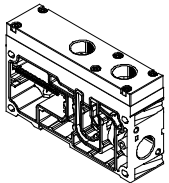

- Code K

Supply plates, exhaust port 3/5 common

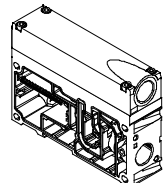

- Code L

Valve terminals VTSA/VTSA-F, NPT

Key features – Pneumatic components

Additional compressed air supply/duct separation

Additional supply plates can be used to ensure the compressed air supply for larger valve terminals or to create additional pressure zones.

These can be selected at any point upstream or downstream of the manifold sub-bases.

Supply plates contain the ports:

- Compressed air supply (1)
- Exhaust port (3/5) common or separated

Depending on your order, the exhaust air ducts are either ducted or vented via silencers.

VTSA/VTSA-F with ducted exhaust air:

With ducted exhaust air, venting can be via a supply plate or a right-hand end plate (code V or X).

If duct separation is required, there are three different options:

- Duct separation 1, 3, 5: code S
- Duct separation 1: code T
- Duct separation 3, 5: code R

If a combination of duct separation (S, T or R) and one or two supply plates is required, the following variants can be selected:

- Supply plate with duct separation on the left-hand side: code SU, TU, RU
- Supply plate with duct separation on the right-hand side: code US, UT, UR
- 2 supply plates with intermediate duct separation: code USU, UTU, URU

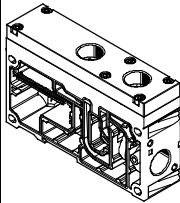
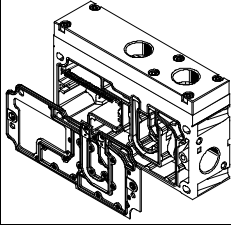
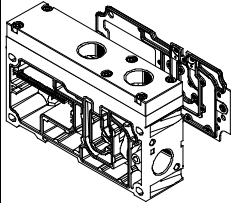
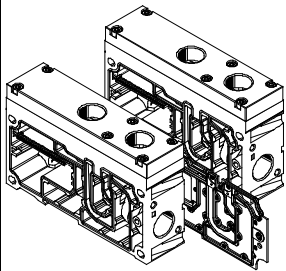
Supply plates							
Code	Image	Type	Width				Description
			18 mm	26 mm	42 mm	52 mm	
U		<ul style="list-style-type: none"> • Exhaust port 3/5 common VABF-S6-10-P1A7-G12 • Exhaust port 3/5 separated VABF-S6-10-P1A6-G12 	■	■	■	■	Supply plate without duct separation (no R, S or T selected)
SU TU RU			■	■	■	■	Supply plate with duct separation on left, if R, S or T selected
US UT UR			■	■	■	■	Supply plate with duct separation on right, if R, S or T selected
USU UTU URU			■	■	■	■	2 supply plates with duct separation in centre, if R, S or T selected

Valve terminals VTSA/VTSA-F, NPT

Key features – Pneumatic components

Right-hand end plate

Right-hand end plates with different port sizes are available depending on the air rate required.

With the following right-hand end plates, the outlet direction of the ports is aligned with the horizontal stacking direction.

Right-hand end plates with pilot air supply/pilot exhaust air

- Internal pilot air supply: code V, V1, V2 and V3 (ducts 1 and 14 are connected)
- External pilot air supply: code X, X1, X2 and X3, as well as XP1, XP2, XP3 and XS

For end plates with pilot air selector, the outlet direction of the ports is to the front of the valve terminal. This means that all the ports on the valve terminal can be combined in one outlet direction.

The special feature of the end plates with pilot air selector is the selector switch itself, which has four settings for different pilot air supply/pilot exhaust air.

End plates with pilot air selector switch set at the factory for:

- External pilot air supply: selector position 1 (code Z)
- Internal pilot air supply: selector position 2 (code Y)
- External pilot air supply, ducted pilot exhaust air: selector position 3 (code W)
- Internal pilot air supply, ducted pilot exhaust air: selector position 4 (code U)

 Note

- The end plate with pilot air selector must be used in combination with a supply plate.
- The reversible 3/2-way solenoid valves (code P, Q, R) must only be operated in selector position 1 or 2.
- Ducted pilot exhaust air via port 12 is only possible with turned seals on the valve.

Right-hand end plate, variants

Code	Blanking plug in duct	Pilot air supply	Ducted pilot exhaust air ¹⁾ Position of seal on solenoid valve ("ISO" is visible)	Connecting thread	
				1, 3, 5	12, 14
V	14	Internal	–	1/2" NPT	1/4" NPT
V1	14		–	3/4" NPT	1/4" NPT
V2	14		–	1" NPT	1/8" NPT
V3	14		■	3/4" NPT	1/4" NPT
X	–	External	–	1/2" NPT	1/4" NPT
X1	–		–	3/4" NPT	1/4" NPT
X2	–		–	1" NPT	1/8" NPT
X3	–		■	3/4" NPT	1/4" NPT
XP1 ²⁾	1	External, via soft-start valve ("gradual pressure build-up")	–	1/2" NPT	1/4" NPT
XP2 ³⁾	1, 14		–	1/2" NPT	1/4" NPT
XP3 ³⁾	1, 3, 5, 14		–	1/2" NPT	1/4" NPT
XS ⁴⁾	14	External, via pilot air switching valve ("switchable pilot air")	–	1/2" NPT	1/4" NPT

- 1) Pilot exhaust air is ducted on the end plate via port duct 12 and vented (done by turning the seal on the solenoid valve to position "ISO")
- 2) Not possible in combination with soft-start valve code PQ, PP, PO (with internal pilot air supply)
- 3) Not possible in combination with soft-start valve code PN, PM, PK (with external pilot air supply)
- 4) Only possible in combination with pilot air switching valve code SS with intermediate plate code Z0

Right-hand end plate with pilot air selector

Code	Pilot air supply	Selector position	Ducted pilot exhaust air ¹⁾ Position of seal on solenoid valve ("ISO" is visible)	Connecting thread 12, 14
Z	External	1	–	1/4" NPT
Y	Internal	2	–	1/4" NPT
W	External (ducted)	3	■	1/4" NPT
U	Internal (ducted)	4	■	1/4" NPT

- 1) Pilot exhaust air is ducted on the end plate via port duct 12 and vented (done by turning the seal on the solenoid valve to position "ISO")

Valve terminals VTSA/VTSA-F, NPT

Key features – Pneumatic components

Handling of the seals with ducted/unducted pilot exhaust air

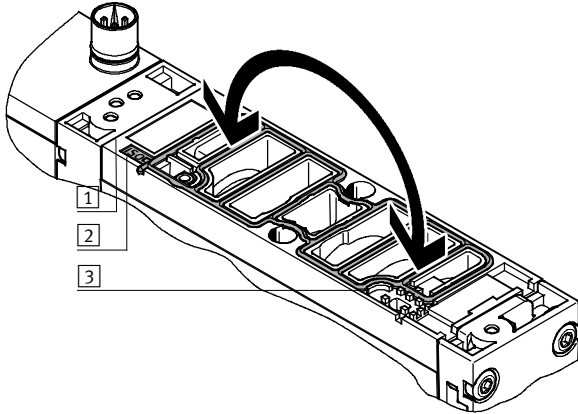

Unducted pilot exhaust air:

- The seal is visible in the inspection window on control side 14.
- The "ISO" mark is visible on the designation label on the seal surface.

Ducted pilot exhaust air:

- The seal is visible in the inspection window on control side 12.
- The "ISO" mark is visible on the designation label on the seal surface.

- 1 Designation label
- 2 Inspection window on control side 14 ("ISO" is visible)
- 3 Inspection window on control side 12 ("ISO" is visible)

Pilot air supply

The port for the pneumatic supply is located on the supply plates or the right-hand end plate.

The ports differ for the following types of pilot air supply:

- Internal
- External

-  - Note

If a gradual pressure build-up is required in the system by means of a soft-start valve, then external pilot

air should be selected whereby the pilot pressure is already applied at the point of switch-on.

Internal pilot air supply

Internal pilot air supply can be selected if the working pressure is between 3 and 10 bar.

In this case the pilot air supply is branched from the compressed air supply 1 using an internal connection. Port 14 on the right-hand end plate is sealed with a blanking plug.

External pilot air supply

If the supply pressure is less than 3 bar, you must operate your valve terminal VTSA/VTSA-F using external pilot air supply.

The pilot air supply is then supplied via port 14 on the right-hand end plate. This is the case even if the valve terminal is operated with different pressure zones.

-  - Note

When using valves with a width of 65 mm, ISO size 3, the internal/external pilot air supply for the valves with a width of 18 ... 52 mm is provided via the adapter plate VABA-....

The external pilot air supply for the valves with a width of 65 mm is provided via the right-hand end plate IEPR

Valve terminals VTSA/VTSA-F, NPT

Key features – Pneumatic components



Right-hand end plate			
Code	Type of compressed air supply and pilot air supply	Description	
Right-hand end plate (symbolic representation)			
V V1 V3 V2 (ISO3)			<p>Internal pilot air supply</p> <ul style="list-style-type: none"> Pilot air supply is branched internally from port 1 Port 14 is sealed with a blanking plug Exhaust air via ports 3 and 5 For operating pressure in the range 3 ... 10 bar Pilot exhaust air via port 12¹⁾ V1 cannot be selected in combination with a soft-start valve in the last pressure zone
X X1 X3 X2 (ISO3)			<p>External pilot air supply</p> <ul style="list-style-type: none"> Pilot air supply between 2 and 10 bar is connected at port 14 Exhaust air via ports 3 and 5 For operating pressure in the range -0.9 ... 10 bar (suitable for vacuum) Pilot exhaust air via port 12¹⁾ X1 cannot be selected in combination with a soft-start valve in the last pressure zone
XP1			<p>External pilot air supply, pressure supply via soft-start valve²⁾</p> <ul style="list-style-type: none"> Port 1 is sealed with a blanking plug Exhaust air via ports 3 and 5 Pilot exhaust air via port 12¹⁾
XP2			<p>External pilot air supply, pressure supply via soft-start valve²⁾</p> <ul style="list-style-type: none"> Internal pilot air supply 14 via soft-start valve Ports 1 and 14 are sealed with a blanking plug Exhaust air via ports 3 and 5 Pilot exhaust air via port 12¹⁾
XP3			<p>External pilot air supply, pressure supply via soft-start valve²⁾</p> <ul style="list-style-type: none"> Internal pilot air supply 14 via soft-start valve Ports 1, 3, 5 and 14 are sealed with a blanking plug Pilot exhaust air via port 12¹⁾
XS			<p>External pilot air supply via pilot air switching valve³⁾</p> <ul style="list-style-type: none"> Internal pilot air supply 14 via pilot air switching valve Port 14 is sealed with a blanking plug Exhaust air via ports 3 and 5 Pilot exhaust air via port 12¹⁾

- 1) Ducted pilot exhaust air is only possible with turned seals on the valve
- 2) Application with XP1, XP2, XP3 and soft-start valve in combination with valves of width 52 mm: please note the maximum flow rate of the soft-start valve in this pressure zone
- 3) Application with XS and pilot air switching valve in combination with intermediate plate

- - Note

The key features, valves and functions of width 65 mm are described separately in the chapter

"Adaptation to width 65 mm, ISO size 3 (technology type 04)"
→ page 125.

Valve terminals VTSA/VTSA-F, NPT

Key features – Pneumatic components

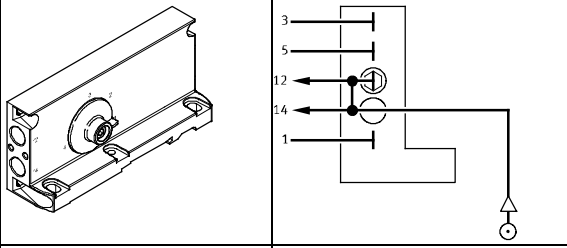
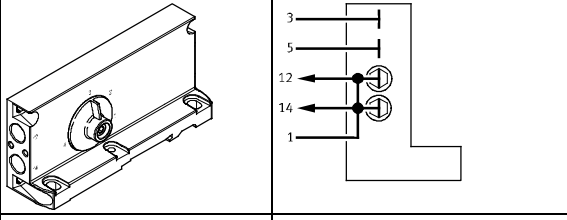
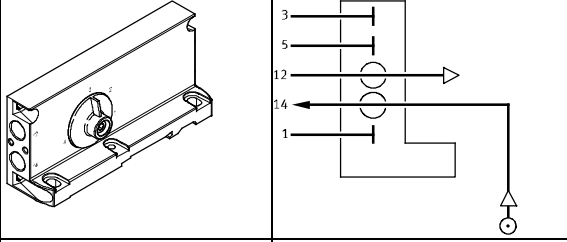
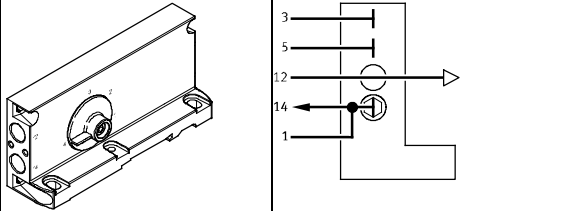
Right-hand end plate		
Code ¹⁾	Type of compressed air supply and pilot air supply	Description
End plate with pilot air selector		
Z (1)		<p>External pilot air supply</p> <ul style="list-style-type: none"> • Pilot air supply is connected at port 14 • Port 12 is sealed with a blanking plug • Ports 12 and 14 are internally connected • Pilot exhaust air unducted via valve housing
Y (2)		<p>Internal pilot air supply</p> <ul style="list-style-type: none"> • Pilot air supply is branched internally from port 1 • Ports 1, 12 and 14 are internally connected • Ports 12 and 14 are sealed with blanking plugs • Pilot exhaust air unducted via valve housing
W (3)		<p>External pilot air supply, ducted pilot exhaust air</p> <ul style="list-style-type: none"> • Pilot air supply is connected at port 14 • Pilot exhaust air via port 12²⁾ • Cannot be selected in combination with a soft-start valve in the last pressure zone
U (4)		<p>Internal pilot air supply, ducted pilot exhaust air</p> <ul style="list-style-type: none"> • Pilot air supply is branched internally from port 1 • Ports 1 and 14 are internally connected • Port 14 is sealed with a blanking plug • Pilot exhaust air via port 12²⁾ • Cannot be selected in combination with a soft-start valve in the last pressure zone

1) Selector setting in brackets

2) Ducted pilot exhaust air is only possible with turned seals on the valve (pilot exhaust air 82/84 including venting air for valves)

-  - Note

The reversible 3/2-way solenoid valves (code P, Q, R) must only be operated in selector position 1 or 2.

Valve terminals VTSA/VTSA-F, NPT

Key features – Pneumatic components



Configuration of all pneumatic connections with NPT thread						
Code		Port (duct)	Designation	Code M Push-in connector, large	Code N Push-in connector, small	
Right-hand end plate						
V			1	Push-in fitting	QS-1/2-5/8-U	QB-1/2-1/2-U
			3 and 5	Silencer or push-in fitting	U-1/2-B-NPT or QS-1/2-5/8-U	U-1/2-B-NPT or QB-1/2-1/2-U
			12	Silencer or push-in fitting	U-1/4-B-NPT or QB-1/4-3/8-U	U-1/4-B-NPT or QB-1/4-5/16-U
			14	Blanking plug	B-1/4-NPT	B-1/4-NPT
X			1	Push-in fitting	QS-1/2-5/8-U	QB-1/2-1/2-U
			3 and 5	Silencer or push-in fitting	U-1/2-B-NPT or QS-1/2-5/8-U	U-1/2-B-NPT or QB-1/2-1/2-U
			12	Silencer or push-in fitting	U-1/4-B-NPT or QB-1/4-3/8-U	U-1/4-B-NPT or QB-1/4-5/16-U
			14	Push-in fitting	QB-1/4-3/8-U	QB-1/4-5/16-U
V1 V3			1	Female hose connector	N-3/4-P-19-NPT ¹⁾	–
			3 and 5	Silencer or female hose connector	U-3/4-B-NPT ¹⁾ or N-3/4-P-19-NPT ¹⁾	–
			12	Silencer or push-in fitting	U-1/4-B-NPT or QB-1/4-1/2-U	U-1/4-B-NPT or QB-1/4-3/8-U
			14	Blanking plug	B-1/4-NPT	B-1/4-NPT
X1 X3			1	Female hose connector	N-3/4-P-19-NPT ¹⁾	–
			3 and 5	Silencer or female hose connector	U-3/4-B-NPT or N-3/4-P-19-NPT ¹⁾	–
			12	Silencer or push-in fitting	U-1/4-B-NPT or QB-1/4-1/2-U	U-1/4-B-NPT or QB-1/4-3/8-U
			14	Push-in fitting	QB-1/4-1/2-U	QB-1/4-3/8-U

1) For tubing with I.D. 19 mm. Use tubing clips to DIN 3017

Note
The key features, valves and functions of width 65 mm are described separately in the chapter "Adaptation to width 65 mm, ISO size 3 (technology type 04)" → page 125.

Valve terminals VTSA/VTSA-F, NPT

Key features – Pneumatic components

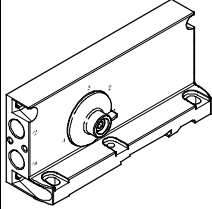
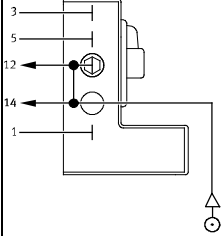
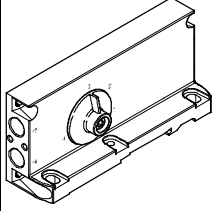
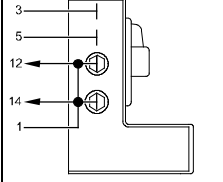
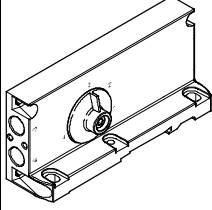
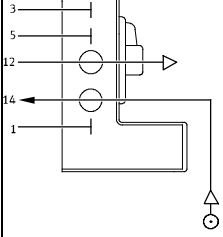
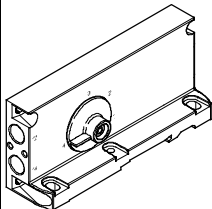
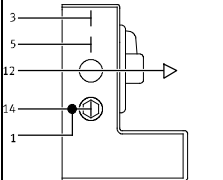
Configuration of all pneumatic connections with NPT thread						
Code ¹⁾		Port	Designation	Code M Push-in connector, large	Code N Push-in connector, small	
End plate with pilot air selector						
Z (1)			12	Blanking plug	B-1/4-NPT	B-1/4-NPT
			14	Push-in fitting	QB-1/4-3/8-U	QB-1/4-5/16-U
Y (2)			12	Blanking plug	B-1/4-NPT	B-1/4-NPT
			14	Blanking plug	B-1/4-NPT	B-1/4-NPT
W (3)			12	Silencer or push-in fitting	U-1/4-B-NPT or QB-1/4-3/8-U	U-1/4-B-NPT or QB-1/4-5/16-U
			14	Push-in fitting	QB-1/4-3/8-U	QB-1/4-5/16-U
U (4)			12	Silencer or push-in fitting	U-1/4-B-NPT or QB-1/4-3/8-U	U-1/4-B-NPT or QB-1/4-5/16-U
			14	Blanking plug	B-1/4-NPT	B-1/4-NPT

1) Selector setting in brackets

Valve terminals VTSA/VTSA-F, NPT

Key features – Pneumatic components



Creating pressure zones and separating exhaust air

The valve terminal VTSA/VTSA-F offers a number of options for creating pressure zones if different working pressures are required. Pressure zones are created by isolating the internal supply ducts between the manifold sub-bases by means of appropriate duct separation.

Compressed air is supplied and vented via a supply plate. The position of the supply plates and duct separations can be freely selected for VTSA/VTSA-F.

Duct separations are integrated ex-works as per your order. Duct separations can be distinguished by their coding, even when the valve terminal is assembled.

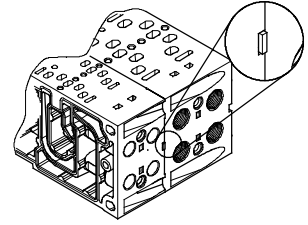

Creating pressure zones							
Code	Separating seal		Width				Description
	Illustrated examples	Coding	18 mm	26 mm	42 mm	52 mm	
T			■	■	■	■	Duct 1 separated
S			■	■	■	■	Ducts 1, 3 and 5 separated
R			■	■	■	■	Ducts 3 and 5 separated

Examples: Compressed air supply and pilot air supply, right-hand end plate

Internal pilot air supply, silencer/ducted exhaust air

Right-hand end plate: code V and V1

The diagram opposite shows an example of the configuration and connection of the compressed air supply with internal pilot air supply. Port 14 on the right-hand end plate is tightly sealed. At exhaust port 3/5 the air is expelled via the silencer. Duct separations can optionally be used to create pressure zones.

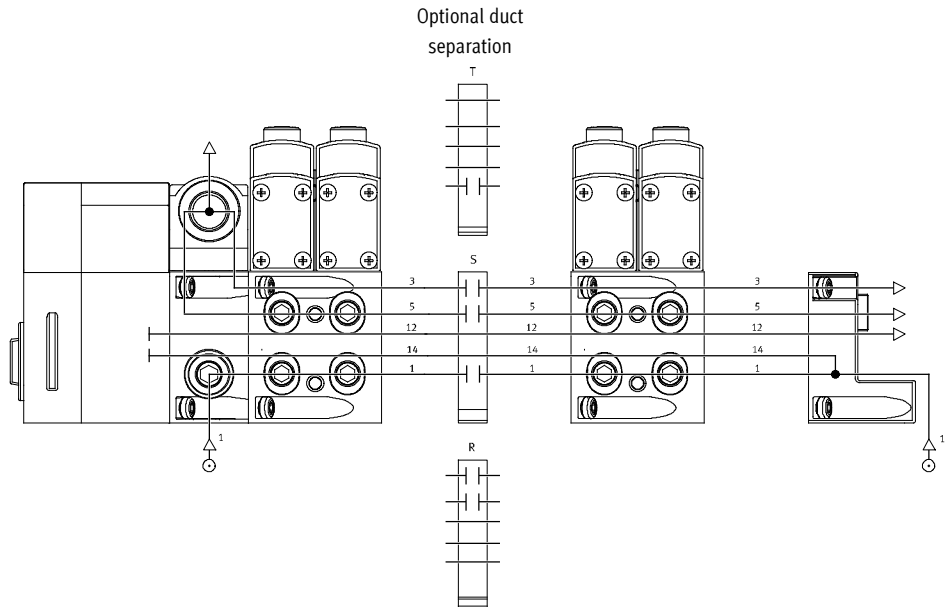

Valve terminals VTSA/VTSA-F, NPT

Key features – Pneumatic components – Compressed air supply and pressure zones, examples

Examples: Compressed air supply and pilot air supply, right-hand end plate

External pilot air supply, silencer/ducted exhaust air

Right-hand end plate: code X and X1

The diagram opposite shows an example of the configuration and connection of the compressed air supply with external pilot air supply. Port 14 on the right-hand end plate is equipped with a fitting for this. At exhaust port 3/5 the air is expelled via the silencer. Duct separations can optionally be used to create pressure zones.

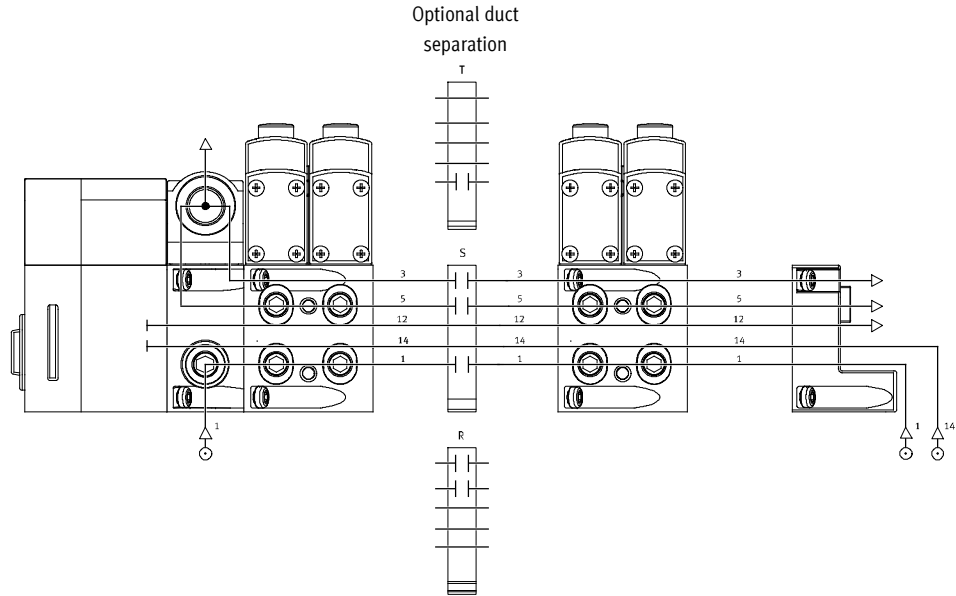

Examples: Compressed air supply and pilot air supply via end plate with pilot air selector

Internal pilot air supply, ducted exhaust air/silencer

Right-hand end plate: code U

The diagram opposite shows an example of the configuration and connection of the compressed air supply with internal pilot air supply. Port 14 on the right-hand end plate is tightly sealed. At exhaust port 3/5 the air is ducted or expelled via the silencer. The selector switch on the pilot air selector is in position 4. Duct separations can optionally be used to create pressure zones.

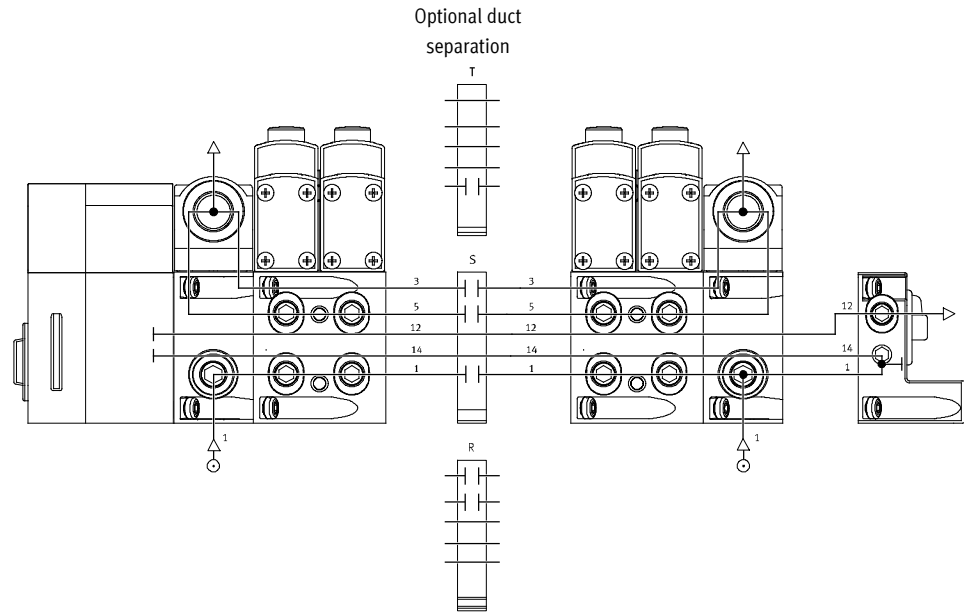

Valve terminals VTSA/VTSA-F, NPT

Key features – Pneumatic components – Compressed air supply and pressure zones, examples

Examples: Compressed air supply and pilot air supply via end plate with pilot air selector

External pilot air supply, ducted exhaust air/silencer

Right-hand end plate: code Z

The diagram opposite shows an example of the configuration and connection of the compressed air supply with external pilot air supply. Port 14 on the right-hand end plate is equipped with a fitting for this. Port 12 is sealed with a blanking plug since it is internally connected with port 14. At exhaust port 3/5 the air is ducted or expelled via the silencer. The selector switch on the pilot air selector is in position 1. Duct separations can optionally be used to create pressure zones.

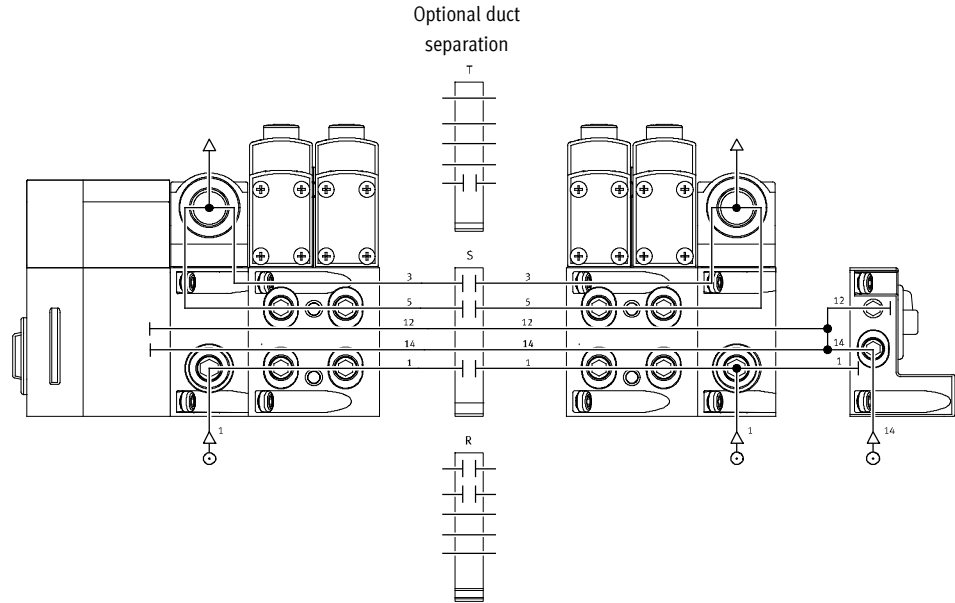

Examples: Creating pressure zones

VTSA/VTSA-F with CPX terminal

VTSA/VTSA-F facilitates the creation of up to 16 pressure zones (up to 32 pressure zones if only size 1, ISO 5599-2, is fitted). The diagram shows an example of the configuration and connection of three pressure zones using duct separations – with internal pilot air supply.

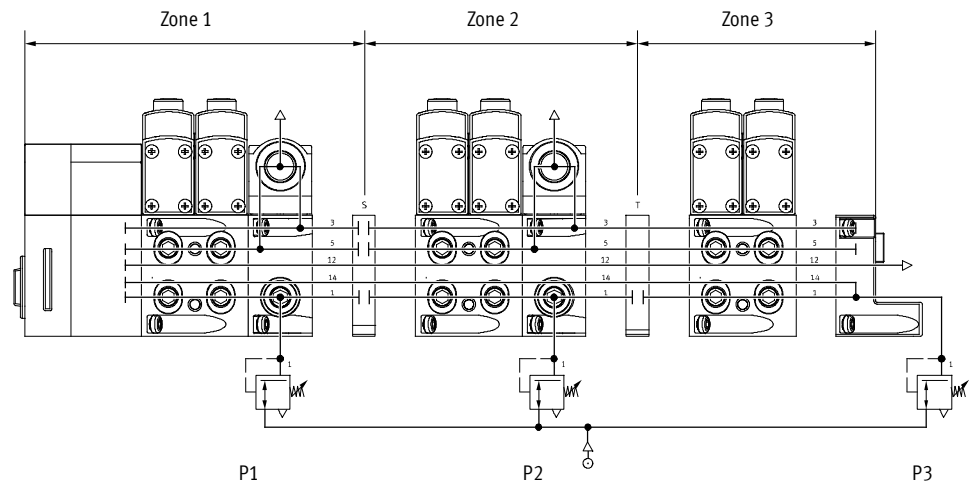

-  Note
 Examples with pressure zones and soft-start valve are described separately in the chapter "Soft-start valve" → page 121.

Valve terminals VTSA/VTSA-F, NPT

Key features – Mounting

Valve terminal mounting

Sturdy valve terminal mounting thanks to:

- Through-holes for wall mounting
- Additional mounting brackets
- H-rail mounting



Further information on mounting the valve terminal can be found by valve terminal configuration on the

catalogue DVD or online.
 → Internet: 2D/3D CAD

Wall mounting, general

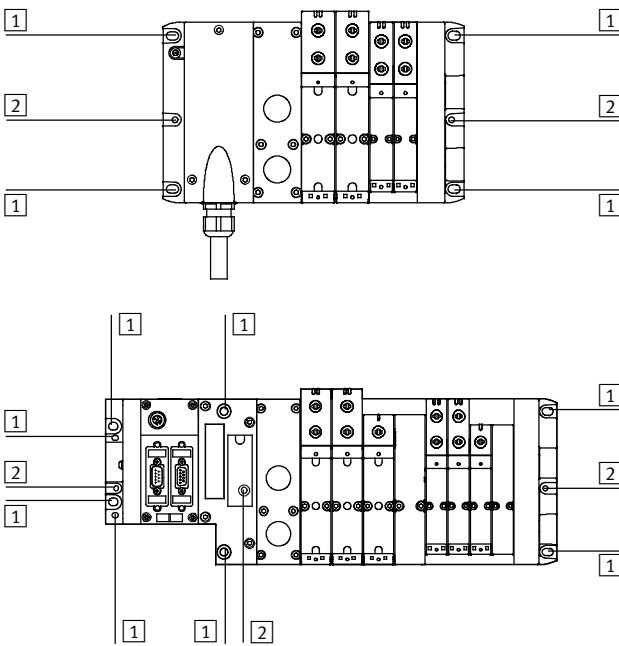

- 1 Hole for M6 screw
- 2 Hole for H-rail mounting

The valve terminal VTSA/VTSA-F is screwed onto the mounting surface using M6 screws. The mounting holes are located at the following points:

- Multi-pin plug (4 pieces):
2 each on the multi-pin connection block and the right-hand end plate
- Fieldbus, CPX (6 pieces):
2 each on the left-hand (CPX) and right-hand (VTSA/VTSA-F) end plate and the pneumatic interface.

Mounting brackets can be mounted on pneumatic supply plates and manifold sub-bases.

If using CPX components, see:
 → Internet: cpx



Wall mounting of the VTSA/VTSA-F with more than five pneumatic modules.

Note the following information to avoid damage to the valve terminal:

- Additionally use mounting brackets of the type VAME-S6-W-M46.
- Mount these at each fourth module (manifold sub-base, supply plate or exhaust plate), counting from left to right, starting after the pneumatic interface.
- No mounting bracket is required next to the right-hand end plate.
- Make sure to use the pre-assembled mounting brackets when mounting factory pre-assembled valve terminals on a wall.

Wall mounting with CPX polymer interface

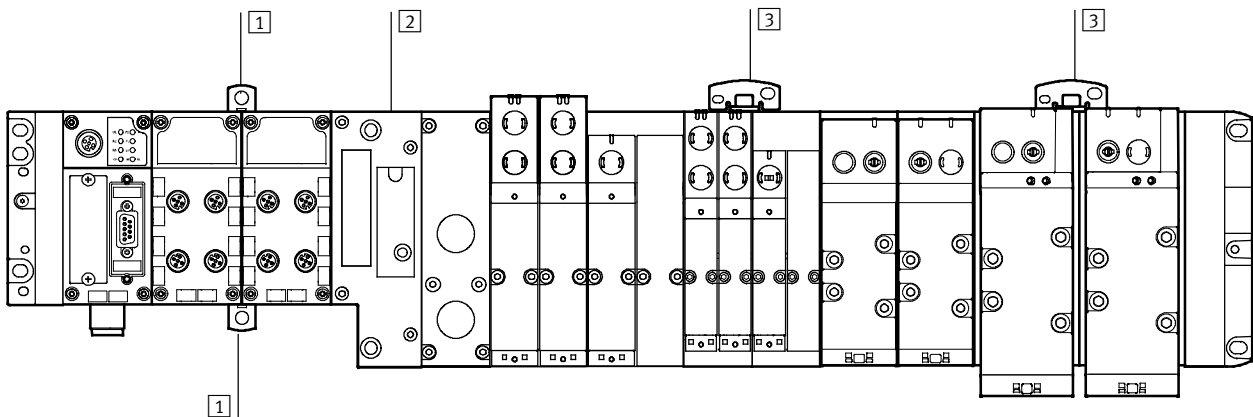

- 1 Additional wall mounting for polymer CPX terminal

- 2 Pneumatic interface

- 3 Additional wall mounting for VTSA/VTSA-F (with hole for M5 and M6 screw)

In the case of CPX terminals in polymer design with 4 and more inter-linking blocks, additional wall mountings of the type CPX-BG-RW must be

used approx. every 100 ... 150 mm. These mountings are clipped in at the top and bottom between the CPX modules.

In the case of the VTSA/VTSA-F, mounting brackets must be mounted on the wall as instructed above.

Brackets of the type VAME-S6-W-M46 must be used as an additional wall mounting.

Valve terminals VTSA/VTSA-F, NPT

Key features – Mounting

Wall mounting with CPX metal interface

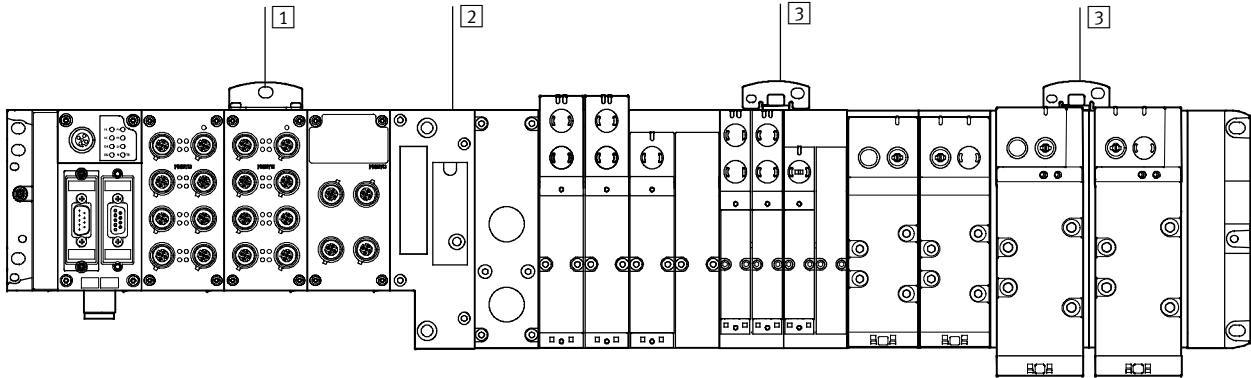

1 Additional wall mounting for metal CPX terminal

2 Pneumatic interface

3 Additional wall mounting for VTSA/VTSA-F (with hole for M5 and M6 screw)

In the case of CPX terminals in metal design with 4 and more interlinking blocks, additional wall mountings of the type CPX-M-BG-RW must be used

approx. every 100 ... 150 mm. These wall mountings are screwed in at the top on the corresponding CPX module.

In the case of the VTSA/VTSA-F, mounting brackets must be mounted on the wall as instructed above. Brackets of the type VAME-S6-W-M46 must be used as an additional wall mounting.

H-rail mounting

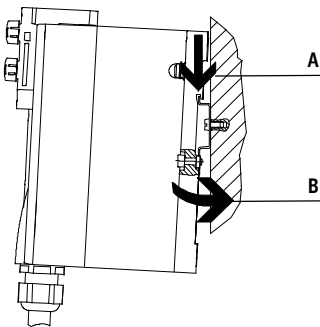

The valve terminal VTSA/VTSA-F is hooked onto the H-rail (see arrow A). It is then swivelled onto the H-rail and secured in place with the clamping component (see arrow B).

This permits mounting of the valve terminal on an H-rail to EN 60715.

For H-rail mounting of the valve terminal you will need the following VTSA/VTSA-F mounting kit:

- CPX-CPA-BG-NRH

Note
Wall mounting is recommended if more than one module is used for vertical stacking or a long valve terminal design is required. Vibration/shock loads are not permissible with H-rail mounting.

Individual valve mounting

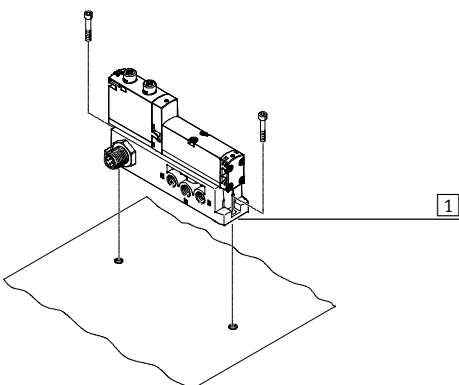

1 Vertical mounting holes

The individual sub-base for wall mounting is designed for integration into a system or machine. It is mounted vertically.

Valve terminals VTSA/VTSA-F, NPT

Key features – Display and operation

Display and operation

Each solenoid coil is allocated an LED which indicates its switching status.

- Indicator 12 shows the switching status of the pilot control for output 2
- Indicator 14 shows the switching status of the pilot control for output 4

Manual override

The manual override enables the valve to be switched when not electrically actuated or energised.

The valve is switched by pushing the manual override. The set switching status can also be locked by turning the manual override.

Alternatives:

- A cover cap (accessory code N) can be fitted over the manual override to prevent it from being turned. The valve can then only be actuated by pressing it.

- A cover cap (code V) can be fitted over the manual override to prevent it from being accidentally actuated.

Pneumatic connection and control elements

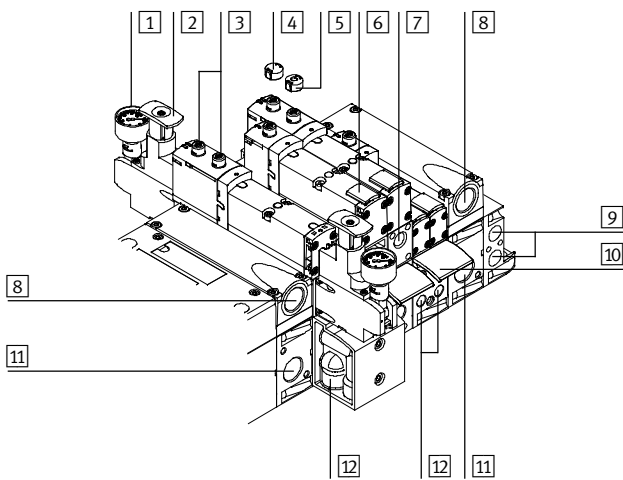

- 1 Pressure gauge (optional)
- 2 Adjusting knob of optional pressure regulator plate
- 3 Manual override (for each pilot solenoid coil, non-detenting or non-detenting/detenting)
- 4 Optional cover cap for manual override (prevents usage of manual override)
- 5 Optional cover cap for manual override with non-detenting function
- 6 Inscription label holder for valve
- 7 Adjusting screw of optional flow control plate
- 8 Exhaust ports "Valves" (3/5)
- 9 Pilot ports 12 and 14 for supplying external pilot air
- 10 Inscription label holder for sub-base
- 11 Supply port 1 (operating pressure)
- 12 Working ports 2 and 4, for each valve position

Note
A manually actuated valve (manual override) cannot be reset electrically. Conversely, an electrically actuated valve cannot be reset using the mechanical manual override.

Electrical connection and display components

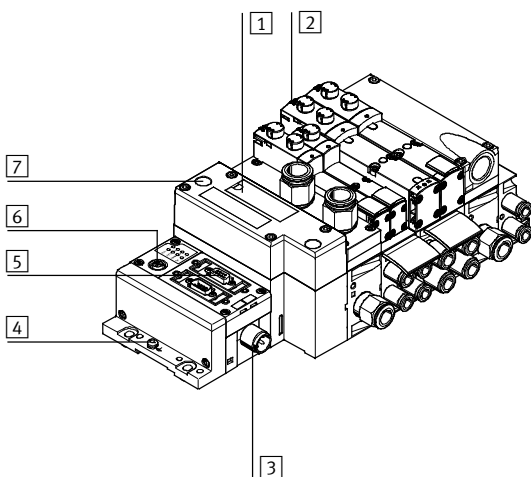

- 1 Inscription area and cover for H-rail mounting
- 2 Yellow LEDs: signal status display for pilot solenoid coils
- 3 Power supply connection
- 4 Earth terminal
- 5 Fieldbus connection (bus-specific)
- 6 Service interface for handheld unit, etc.
- 7 Red LED: common error display for valves

Valve terminals VTSA/VTSA-F, NPT

Key features – Display and operation

Manual override (MO)

MO with automatic return (non-detenting)

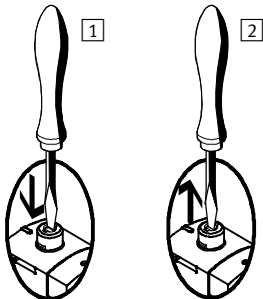

- 1 Press in the stem of the manual override using a pointed object or screwdriver. Valve is then switched.
- 2 Remove the pointed object or screwdriver. Spring force pushes the stem of the manual override back. Valve returns to initial position (not with double solenoid valve code J).

MO with detent (covered)

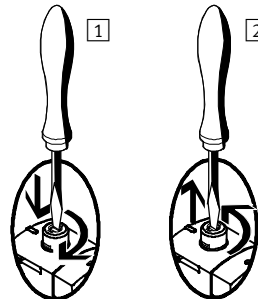

- 1 Press in the stem of the manual override using a pointed object or screwdriver until the valve switches and then turn the stem clockwise by 90° until the stop is reached. Valve remains switched
- 2 Turn the stem anti-clockwise by 90° until the stop is reached and then remove the pointed object or screwdriver. Spring force pushes the stem of the manual override back. Valve returns to initial position (not with double solenoid valve code J and D).

Identification system

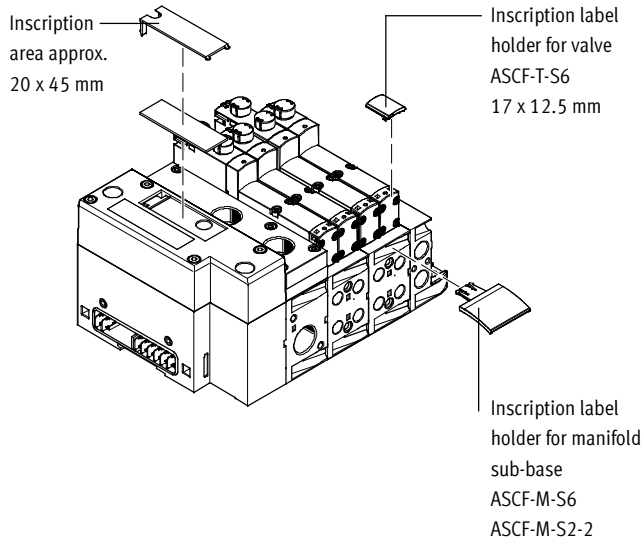

Inscription label holders can be applied to the valves and manifold sub-bases to identify them. These inscription label holders can be ordered by entering the code B or T in the order code for accessories. Scope of delivery: inscription label holder including inscription label. The following inscription labels can be used as spares:

- Inscription label holder for valve type ASCF-T-S6: Part No. 540888

- Inscription label holder for manifold sub-base type ASCF-M-S6: Part No. 540889
 - Inscription label holder for manifold sub-base (for valve width 52 mm) type ASCF-M-S2-2 Part No. 562577
- Large inscription labels can be attached to the pneumatic interface as an alternative or in addition to the smaller labels.

Valve terminals VTSA/VTSA-F, NPT

Key features – Electrical components

Protective circuit

Each VSVA solenoid coil is protected with a spark arresting protective circuit as well as against polarity reversal.

The 24 V DC version of width 52 mm additionally features integrated holding current reduction.

24 V DC version (width 18 to 42 mm)

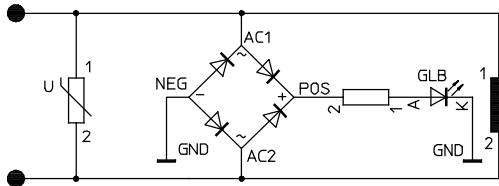

110 V AC version (width 18 to 52 mm)

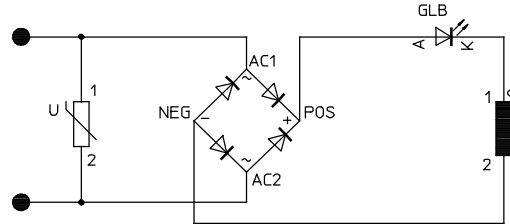

24 V DC version (width 52 mm)

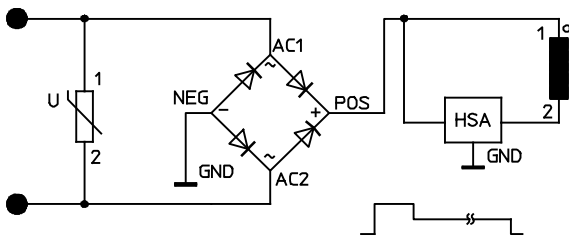

Individual valve

Valves can also be used on individual sub-bases for actuators further away from the valve terminal.

- Electrical connection M12, 4-pin 24 V DC
- 4-pin clamped terminal connection for configuration by the user 24 V DC or 110 V AC
- Cable (open end) for configuration by the user 24 V DC or 110 V AC

Individual electrical connection

A maximum of 20 solenoid coils can be actuated. 2 solenoid coils per valve can be addressed.

Individual electrical connection:

- M12
- 6-way or 10-way
- 5-pin
- 24 V DC

Valve terminals VTSA/VTSA-F, NPT

Key features – Electrical components

Electrical multi-pin plug connection

The following multi-pin plug connection variants are offered for the valve terminal VTSA/VTSA-F:

- Sub-D multi-pin plug connection (37-pin for 24 V DC): this valve terminal can be equipped with 1 ... 16 valve positions (with double solenoid valves) or with 1 ... 32 valve positions (with single solenoid valves). A maximum of 32 solenoid coils can be actuated.
- Terminal box (terminal strip for 24 V DC or 110 V AC): this valve terminal can be equipped with 1 ... 16 valve positions (with double

solenoid valves), or with 1 ... 32 valve positions (with single solenoid valves). A maximum of 32 solenoid coils can be actuated.

- Multi-pin node (round plug connector): electrical multi-pin plug connection with round plug connector, 19-pin to CNOMO E03.62.530.N, connecting thread M23 for 24 V DC. The valve terminals can be fitted with max. 16 solenoid coils.

The valves are switched by means of positive or negative logic (PNP or

NPN). Mixed operation is not permitted.

Each pin on the multi-pin plug (Sub-D) or terminal box (terminal strip) can actuate exactly one solenoid coil. If the maximum configurable number of valve positions is 32, this means that 32 valves, each with a single solenoid coil, can be addressed. With 16 or fewer valve positions, 2 solenoid coils per valve can be addressed.

 - Note

Use the following 37-pin connecting cables from Festo to connect the valve terminal VTSA/VTSA-F with Sub-D multi-pin plug connection:

- NEBV-S1W37-...-LE10 for max. 8 solenoid coils
- NEBV-S1W37-...-LE26 for max. 22 solenoid coils
- NEBV-S1W37-...-LE37 for max. 32 solenoid coils
- NECV-S1W37 pre-assembled plug connector

AS-interface connection

Valve terminals VTSA/VTSA-F with AS-interface connection can be expanded with up to 8 valves with max. 8 solenoid coils.

The valve terminal with AS-interface connection is based on the same electrical connection block as the valve

terminal with multi-pin plug connection. This means it is possible to convert a valve terminal with multi-pin plug connection using an AS-interface module.

The technical specifications of the AS-interface system must be observed in this case.

 - Note

AS-i module VAEM-S6-S-FAS-4-4E. Always operate the AS-i module with additional power supply if 4 solenoid coils (width 52 mm) are simultaneously supplied with current. More information can be found at:

➔ Internet: as-interface

Fieldbus connection/control block

All functions and features of the electrical peripherals CPX are permitted in connection with the CPX interface. This means:

- The valves and electrical outputs are supplied via the operating voltage connection CPX
- The valves are supplied and switched off independently via a separate port on the CPX

 - Note

More information can be found at:

➔ Internet: cpx

Valve terminals VTSA/VTSA-F, NPT

Key features – Electrical components

Rules for addressing

Address allocation

Address allocation does not depend on whether single or double solenoid valves are fitted.

Addresses are allocated in ascending order without gaps, from left to right.

Single solenoid valve

A valve position for actuating one solenoid coil (VABV...T1) occupies one address.

Double solenoid valve

A valve position for actuating two solenoid coils (VABV...T2) occupies two addresses. The following allocation applies in this case:

- Coil 14: lower-value address
- Coil 12: higher-value address

Pin allocation – Multi-pin plug, Sub-D socket, 24 V DC; electrical connection code MP1

	Pin ²⁾	Address/coil	Wire colour ¹⁾		Pin ²⁾	Address/coil	Wire colour ¹⁾
	1	0	WH		17	16	WH PK
	2	1	BN		18	17	PK BN
	3	2	GN		19	18	WH BU
	4	3	YE		20	19	BN BU
	5	4	GY		21	20	WH RD
	6	5	PK		22	21	BN RD
	7	6	BU		23	22	GY GN
	8	7	RD		24	23	YE GY
	9	8	GY PK		25	24	PK GN
	10	9	RD BU		26	25	YE PK
	11	10	WH GN		27	26	GN BU
	12	11	BN GN		28	27	YE BU
	13	12	WH YE		29	28	GN RD
	14	13	YE BN		30	29	YE RD
	15	14	WH GY		31	30	GN BK
	16	15	GY BN		32	31	GY BU
<p>- - Note</p> <p>The drawing shows the view onto the Sub-D plug socket at the connecting cable NEBV-S1W37-....</p>	Conductor						
	33	0 V ³⁾	YE BK		35	0 V ³⁾	BN BK
	34	0 V ³⁾	WH BK		36	0 V ³⁾	BK
	Earthing						
37	FE	VT		-	-	-	-

1) To IEC 757

2) Pin 9 ... 35: not used with connecting cable NEBV-S1-W37-...-LE10
 Pin 23 ... 33: not used with connecting cable NEBV-S1-W37-...-LE26
 Pin 24 ... 33: not used with connecting cable NEBV-S1-W37-...-LE27

3) 0 V for positive switching control signals; connect 24 V for negative switching control signals; mixed operation is not permitted.

Valve terminals VTSA/VTSA-F, NPT

Key features – Electrical components

Dimensions

Download CAD data → www.festo.com

Connecting cable NEBV-S1W37-...

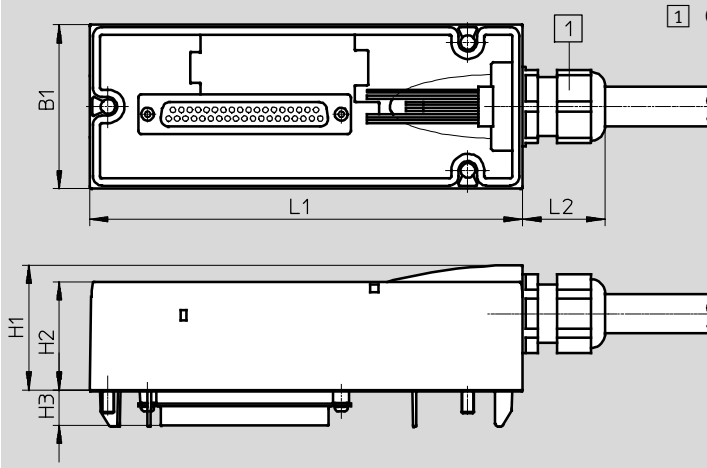

1 Cable connector M20x1.5

The wire colours refer to the following pre-assembled connecting cables from Festo:

- NEBV-S1W37-...-LE10 for valve terminal with max. 8 solenoid coils
- NEBV-S1W37-...-LE26 for valve terminal with max. 22 solenoid coils
- NEBV-S1W37-...-LE37 for valve terminal with max. 32 solenoid coils

Type	B1	H1	H2	H3	L1	L2
NEBV-S1W37	54	41	36	11.6	142	27

Pin allocation – Multi-pin plug, Sub-D plug, 24 V DC, connecting cable; electrical connection code MP1

	Sheath	Length [m]	Cable composition [mm ²]	Cable diameter [mm]	Part No.	Type
	Polyurethane	2.5	10 x 0.34	7.7	539240	NEBV-S1W37-E2.5-LE10
		5			539241	NEBV-S1W37-E5-LE10
		10			539242	NEBV-S1W37-E10-LE10
		2.5	26 x 0.34	11.5	539243	NEBV-S1W37-E2.5-LE26
		5			539244	NEBV-S1W37-E5-LE26
		10			539245	NEBV-S1W37-E10-LE26
		2.5	37 x 0.34	13	539246	NEBV-S1W37-K2.5-LE37
		5			539247	NEBV-S1W37-K5-LE37
		10			539248	NEBV-S1W37-K10-LE37
	Polyvinyl chloride, cable properties (standard)	2.5	10 x 0.34	7.7	543271	NEBV-S1W37-KM-2.5-LE10
		5			543272	NEBV-S1W37-KM-5-LE10
		10			543273	NEBV-S1W37-KM-10-LE10
		2.5	27 x 0.34	11.5	543274	NEBV-S1W37-KM-2.5-LE27
		5			543275	NEBV-S1W37-KM-5-LE27
		10			543276	NEBV-S1W37-KM-10-LE27
		2.5	37 x 0.34	13	543277	NEBV-S1W37-KM-2.5-LE37
		5			543278	NEBV-S1W37-KM-5-LE37
		10			543279	NEBV-S1W37-KM-10-LE37

Valve terminals VTSA/VTSA-F, NPT

Key features – Electrical components



Pin allocation – Multi-pin, terminal strip (Cage Clamp®), 24 V DC and 110 V AC; electrical connection code T					
	Terminal	Coil/address		Terminal	Coil/address
<p>Each solenoid coil must be assigned to a specific terminal on the terminal strip in order for the valves to be actuated.</p>	1	0		17	16
	2	1		18	17
	3	2		19	18
	4	3		20	19
	5	4		21	20
	6	5		22	21
	7	6		23	22
	8	7		24	23
	9	8		25	24
	10	9		26	25
	11	10		27	26
	12	11		28	27
	13	12		29	28
	14	13		30	29
	15	14		31	30
	16	15		32	31
<p> - Note</p> <p>The drawing shows the view onto the multi-pin terminal strip (Cage Clamp®).</p>	Conductor				
	33	0 V		35	0 V
	34	0 V		36	0 V

Pin allocation – Multi-pin, round plug connector, 24 V DC; electrical connection code MP4					
	Address	Pin ¹⁾		Address	Pin ¹⁾
	0	15		8	17
	1	7		9	9
	2	5		10	2
	3	4		11	13
	4	16		12	11
	5	8		13	10
	6	3		14	1
	7	14		15	18

Pin allocation – Multi-pin plug, round plug connector, 24 V DC; electrical connection – CNOMO assignment					
	Pin	Valve position/ solenoid coil		Pin	Valve position/ solenoid coil
	1	8/14		10	7/12
	2	6/14		11	7/14
	3	4/14		12	FE
	4	2/12		13	6/12
	5	2/14		14	4/12
	6	0 V ¹⁾		15	1/14
	7	1/12		16	3/14
	8	3/12		17	5/14
	9	5/12		18	8/12
			19	Unused	

1) Pin 6: 0 V for positive switching control signals; connect 24 V for negative switching control signals; mixed operation is not permitted.
 Pin 12: earth
 Pin 19: unused

Valve terminals VTSA/VTSA-F, NPT

Key features – Electrical components

Electrical connection, individual valve 24 V DC or 110 V AC up to width 52 mm

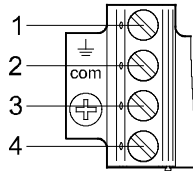
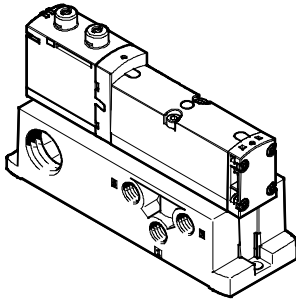

Pin allocation for assembly by the user

With positive logic:

Pin1 – Unused (with 110 V AC connection for earthing)

Pin2 – U_B for coil 12

Pin3 – 0 V for coil 12 and 14

Pin4 – U_B for coil 14

With negative logic:

Pin1 – Unused

Pin2 – 0 V for coil 12

Pin3 – U_B for coil 12 and 14

Pin4 – 0 V for coil 14

Individual electrical connection, 6-way or 10-way, 24 V DC, code MP2/MP3 for valve terminal up to width 52 mm

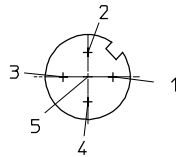
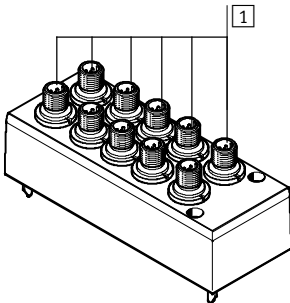

Pin allocation M12

With positive logic:

Pin1 – Unused

Pin2 – U_B for coil 12

Pin3 – 0 V for coil 12 and 14

Pin4 – U_B for coil 14

Pin5 – Functional earth

Pin allocation M12

With negative logic:

Pin1 – Unused

Pin2 – 0 V for coil 12

Pin3 – U_B for coil 12 and 14

Pin4 – 0 V for coil 14

Pin5 – Functional earth

1 Connector plug M12x1, 5-pin



Note

Mixed operation of positive switching (PNP) and negative switching (NPN) control signals is not permitted.

Valve terminals VTSA/VTSA-F, NPT

Instructions for use

FESTO

System equipment

Operate system equipment with unlubricated compressed air if possible. Festo valves and cylinders are designed so that, if used as designated, they will not require additional lubrication and will still achieve a long service life.

The quality of compressed air downstream of the compressor must correspond to that of unlubricated compressed air. If possible, do not operate all of your system equipment with lubricated compressed air. The lubricators should, where possible, always be installed directly upstream of the actuator used.

Incorrect additional oil and too high an oil content in the compressed air reduce the service life of the valve terminal.

Use Festo special oil OFSW-32 or the alternatives listed in the Festo catalogue (as specified in DIN 51524 HLP32; basic oil viscosity 32 CST at 40 °C).

Bio-oils

When using bio-oils (oils which are based on synthetic or native ester, e.g. rapeseed oil methyl ester), the maximum residual oil content of 0.1 mg/m³ must not be exceeded (see ISO 8573-1:2010 Class 2).

Mineral oils

When using mineral oils (e.g. HLP oils to DIN 51524, parts 1 to 3) or similar oils based on poly-alpha-olefins (PAO), the maximum residual oil content of 5 mg/m³ must not be exceeded (see ISO 8573-1:2010 Class 4).

A higher residual oil content irrespective of the compressor oil cannot be permitted, as the basic lubricant would be flushed out over time.

Valve terminals VTSA/VTSA-F, NPT

Technical data – Valve terminal

-  - Valve width to ISO 15407-2
 - 18 mm
 - 26 mm
- to ISO 5599-2
 - 42 mm (ISO 1)
 - 52 mm (ISO 2)

-  - Voltage
 - 24 V DC
 - 110 V AC

-  - Flow rate
 - Width 18 mm: up to 550 (700) l/min
 - Width 26 mm: up to 1,100 (1,350) l/min
 - Width 42 mm: up to 1,300 l/min
 - Width 52 mm: up to 2,900 l/min

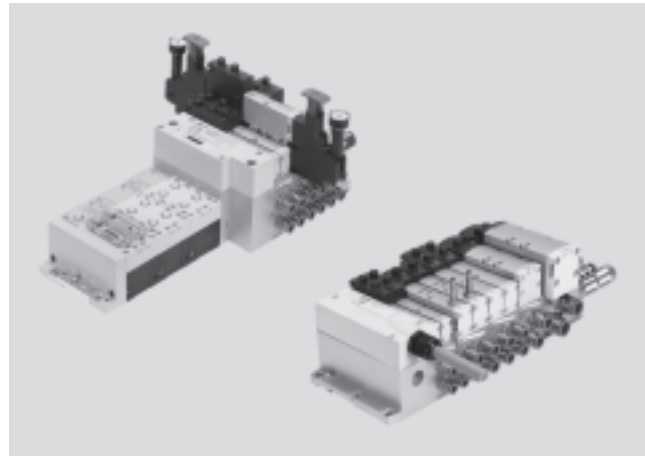

Flow rates in brackets apply to VTSA-F

General technical data					
Design	Piston spool valve				
Sealing principle	Soft				
Actuation type	Electric				
Electrical connection	With multi-pin plug: Multi-pin				
	With fieldbus: Integrated control system, fieldbus, Industrial Ethernet				
Type of control	Piloted				
Exhaust function, with flow control	Via flow control plate				
Lubrication	Lubricated for life				
Type of mounting	Wall mounting				
	On H-rail to EN 60715				
Mounting position	Any				
Manual override	Non-detenting, detenting, covered				
Valve terminal design	Modular, valve sizes can be combined				
Max. no of valve positions	32 ¹⁾				
Pneumatic connections – NPT thread					
Width	18 mm	26 mm	42 mm	52 mm	
Pneumatic connection	Via manifold sub-base				
Supply port ²⁾	1	<ul style="list-style-type: none"> • 1/2" NPT • QS-1/2-5/8-U • QB-1/2-1/2-U 	<ul style="list-style-type: none"> • 1/2" NPT • QS-1/2-5/8-U • QB-1/2-1/2-U 	<ul style="list-style-type: none"> • 3/4" NPT • N-3/4-P-19-NPT 	<ul style="list-style-type: none"> • 3/4" NPT • N-3/4-P-19-NPT
Exhaust port ²⁾	3/5	<ul style="list-style-type: none"> • 1/2" NPT • QS-1/2-5/8-U • QB-1/2-1/2-U 	<ul style="list-style-type: none"> • 1/2" NPT • QS-1/2-5/8-U • QB-1/2-1/2-U 	<ul style="list-style-type: none"> • 3/4" NPT • N-3/4-P-19-NPT 	<ul style="list-style-type: none"> • 3/4" NPT • N-3/4-P-19-NPT
Working ports	2/4	Dependent on the connection type selected			
		<ul style="list-style-type: none"> • 1/8" NPT • QB-1/8-5/16-U • QB-1/8-1/4-U 	<ul style="list-style-type: none"> • 1/4" NPT • QB-1/4-3/8-U • QB-1/4-5/16-U 	<ul style="list-style-type: none"> • 3/8" NPT • QB-3/8-1/2-U • QB-3/8-3/8-U 	<ul style="list-style-type: none"> • 1/2" NPT • QS-1/2-5/8-U • QB-1/2-1/2-U
External pilot air supply port	14	<ul style="list-style-type: none"> • 1/4" NPT • QB-1/4-3/8-U • QB-1/4-5/16-U 	<ul style="list-style-type: none"> • 1/4" NPT • QB-1/4-3/8-U • QB-1/4-5/16-U 	<ul style="list-style-type: none"> • 1/4" NPT • QB-1/4-3/8-U • QB-1/4-5/16-U 	<ul style="list-style-type: none"> • 1/4" NPT • QB-1/4-1/2-U • QB-1/4-3/8-U
Pilot exhaust air port	12	<ul style="list-style-type: none"> • 1/4" NPT • QB-1/4-3/8-U • QB-1/4-5/16-U 	<ul style="list-style-type: none"> • 1/4" NPT • QB-1/4-3/8-U • QB-1/4-5/16-U 	<ul style="list-style-type: none"> • 1/4" NPT • QB-1/4-3/8-U • QB-1/4-5/16-U 	<ul style="list-style-type: none"> • 1/4" NPT • QB-1/4-1/2-U • QB-1/4-3/8-U

1) Dependent on the electrical interface and the manifold sub-bases used
 2) Dependent on the end plate or supply plate used

-  - Note: This product conforms to ISO 1179-1 and to ISO 228-1

Valve terminals VTSA/VTSA-F, NPT

FESTO

Technical data – Valve terminal

Standard nominal flow rate of valve/valve terminal [l/min]																			
Valve function order code	VC	VV	N	K	H	P	Q	R	M	O	J	D	B	E	G	SA	SB	VG	
Type code	T22C	T22CV	T32U	T32C	T32H	T32F	T32N	T32W	M52-AZD	M52-MZD	B52	D52	P53U	P53E	P53C	P53ED	P53AD	P53F	
Width 18 mm																			
Flow rate of valve	700		600			750			700 ¹⁾ 330 ²⁾		700 ¹⁾ 330 ²⁾		700	-	-	-	-	-	-
Flow rate of valve on valve terminal VTSA	500		400			550			450 ¹⁾ 330 ²⁾		450 ¹⁾ 330 ²⁾		450	-	-	-	-	-	-
Flow rate of valve on valve terminal VTSA-F	650		550			700			480 ¹⁾ 330 ²⁾		330 ²⁾		650	-	-	-	-	-	-
Width 26 mm																			
Flow rate of valve	1,350		1,250			1,400			1,400 ¹⁾ , 700 ²⁾		1,400 ¹⁾ , 700 ²⁾		1,400	700	-	-	-	-	-
Flow rate of valve on valve terminal VTSA	1,000		900			1,100			1,000 ¹⁾ , 700 ²⁾		1,000 ¹⁾ , 700 ²⁾		1,000	700	-	-	-	-	-
Flow rate of valve on valve terminal VTSA-F	1,300		1,150			1,350			1,350 ¹⁾ , 700 ²⁾		700 ²⁾		1,000	700	-	-	-	-	-
Width 42 mm																			
Flow rate of valve	1,600		1,600			2,000			1,900 ¹⁾ 950 ²⁾		-		-	-	-	-	-	-	1,700 ¹⁾ 800 ²⁾
Flow rate of valve on valve terminal VTSA	1,400		1,200			1,300			1,200 ¹⁾ 800 ²⁾		-		-	-	-	-	-	-	1,400 ¹⁾ 700 ²⁾
Flow rate of valve on valve terminal VTSA-F	1,400		1,200			1,300			1,200 ¹⁾ 800 ²⁾		-		-	-	-	-	-	-	1,400 ¹⁾ 700 ²⁾
Width 52 mm																			
Flow rate of valve	4,000		3,000			4,000			3,600 ¹⁾ 1,700 ²⁾		-		-	-	-	-	-	-	-
Flow rate of valve on valve terminal VTSA	2,800		2,400			2,900			2,800 ¹⁾ 1,700 ²⁾		-		-	-	-	-	-	-	-
Flow rate of valve on valve terminal VTSA-F	2,800		2,400			2,900			2,800 ¹⁾ 1,700 ²⁾		-		-	-	-	-	-	-	-

- 1) Switching position
2) Mid-position

Standard nominal flow rate of vertical stacking [l/min]				
Width	18 mm	26 mm	42 mm	52 mm
Flow control plate				
VABF-S4-2-F1B1-C	See characteristic curve		-	-
VABF-S4-1-F1B1-C	-	See characteristic curve		-
VABF-S2-1-F1B1-C	-	-	1,100	-
VABF-S2-2-F1B1-C	-	-	-	See characteristic curve
Vertical supply plate				
VABF-S4-2-P1A ... -G18	430	-	-	-
VABF-S4-1-P1A ... -G14	-	900	-	-
VABF-S2-1-P1A ... -G38	-	-	1,300	-
VABF-S2-2-P1A ... -G12	-	-	-	2,800
Vertical pressure shut-off plate				
VABF-S4-2-L1D1-C	400	-	-	-
VABF-S4-1-L1D1-C	-	800	-	-
VABF-S2-1-L1D1-M5	-	-	1,200	-
VABF-S2-2-L1D1-C	-	-	-	1,950

Valve terminals VTSA/VTSA-F, NPT

Technical data – Valve terminal

Flow rate q_n as a function of output pressure p_2 with pressure regulator plates (P regulator plate) for port 1

6 bar

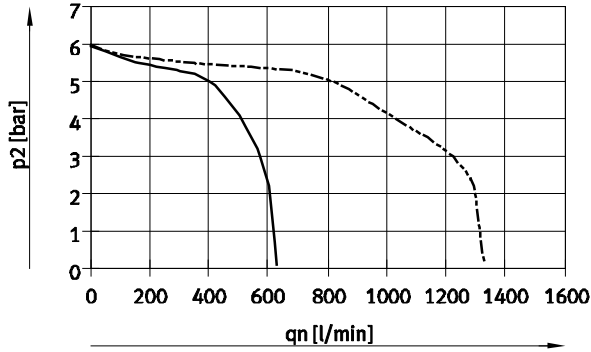

— Width 18 mm
- - - Width 26 mm

10 bar

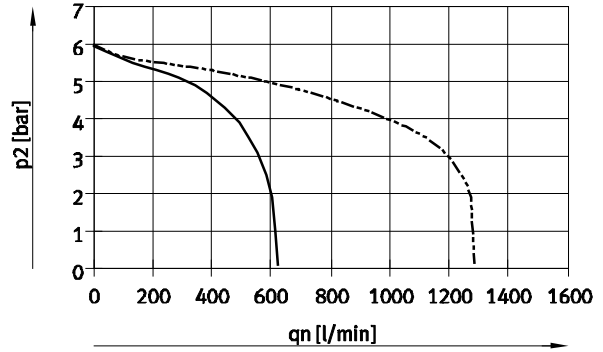

— Width 18 mm
- - - Width 26 mm

Supply pressure 10 bar, set control pressure 6 bar

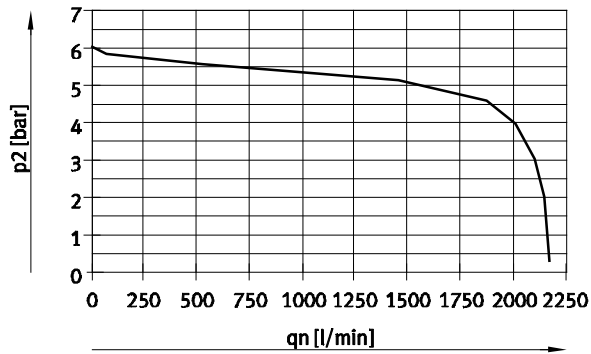

Width 42 mm (ISO 1)

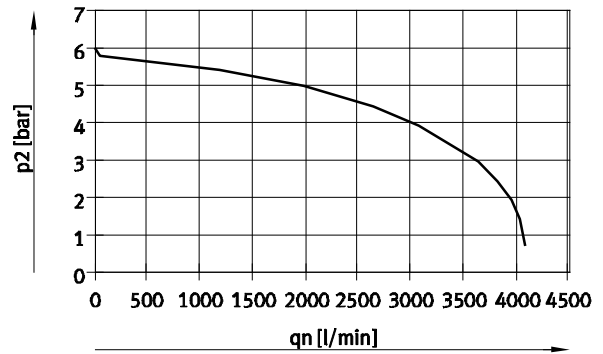

Width 52 mm (ISO 2)

Valve terminals VTSA/VTSA-F, NPT

Technical data – Valve terminal

FESTO

Flow rate q_n as a function of output pressure p_2 with pressure regulator plates (AB regulator plates) for port 2, 4 or ports 4/2

6 bar

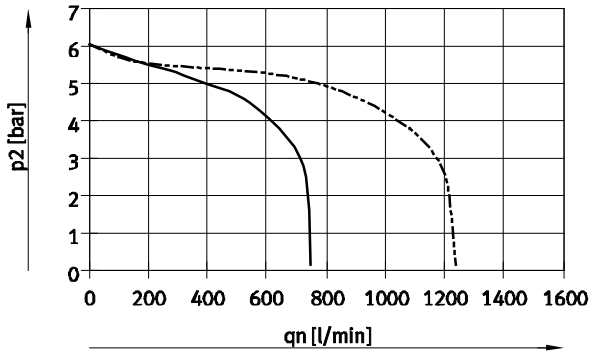

— Width 18 mm
- - - Width 26 mm

10 bar

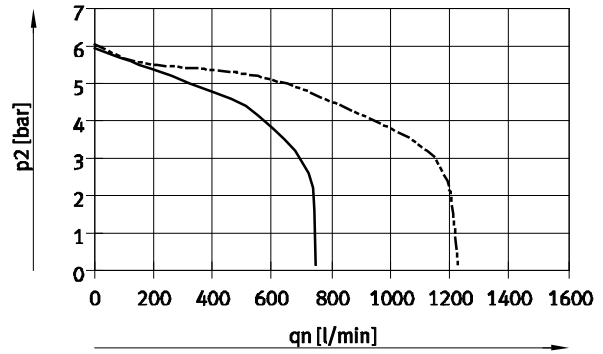

— Width 18 mm
- - - Width 26 mm

Supply pressure 10 bar, set controller pressure 6 bar

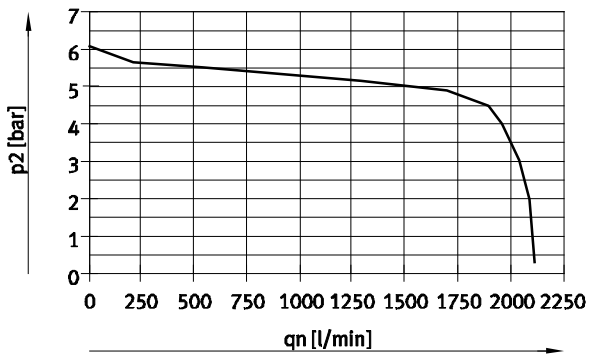

Width 42 mm (ISO 1)

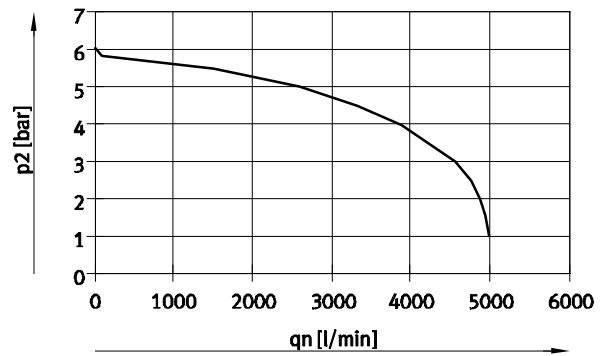

Width 52 mm (ISO 2)

Valve terminals VTSA/VTSA-F, NPT

Technical data – Valve terminal

Flow rate q_n as a function of output pressure p_2 with pressure regulator plates (AB regulator plates, rev.) for ports 4/2, reversible

6 bar

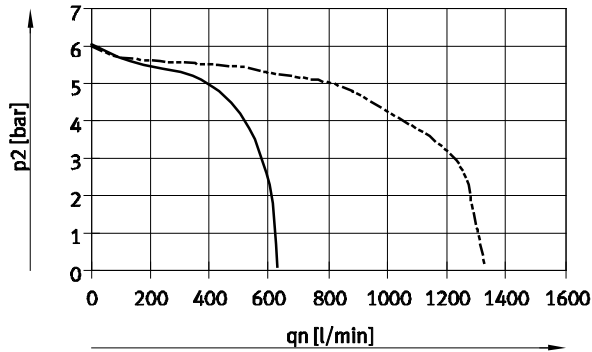

— Width 18 mm
- - - Width 26 mm

10 bar

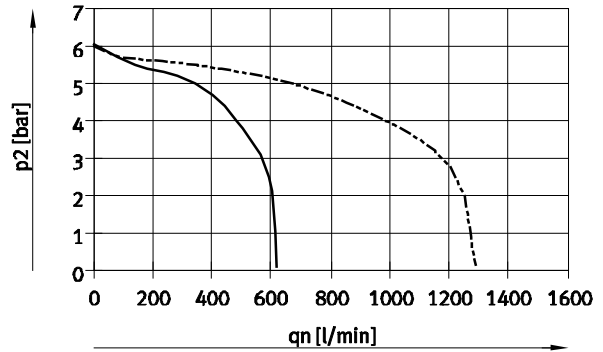

— Width 18 mm
- - - Width 26 mm

Supply pressure 10 bar, set controller pressure 6 bar

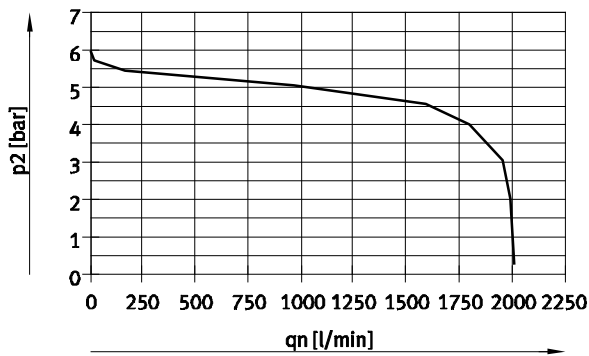

Width 42 mm (ISO 1)

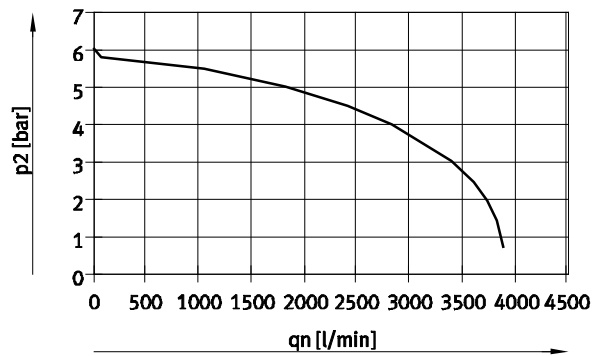

Width 52 mm (ISO 2)

Valve terminals VTSA/VTSA-F, NPT

Technical data – Valve terminal

Flow rate q_N as a function of flow control

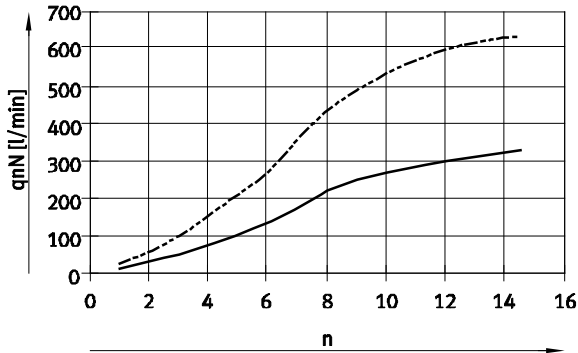

— Width 18 mm
 - - - Width 26 mm

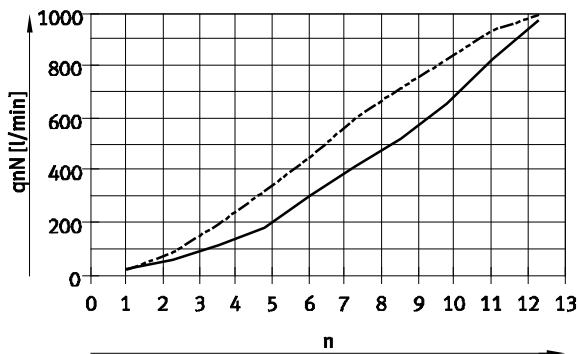

Width 42 mm (ISO 1)
 — Flow control screw from 2 → 3
 - - - Flow control screw from 4 → 5
 n Revolutions of the adjusting screw

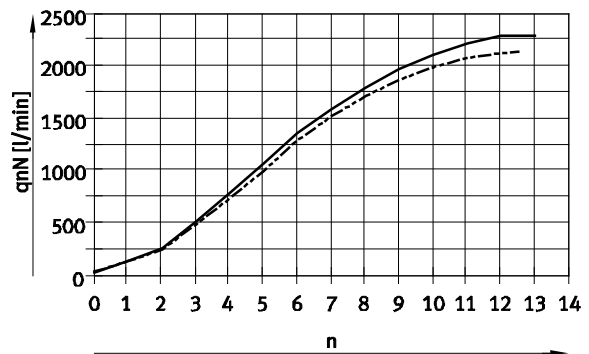

Width 52 mm (ISO 2)
 — Flow control screw from 2 → 3
 - - - Flow control screw from 4 → 5
 n Revolutions of the adjusting screw

Pilot pressure $p_{12/14}$ as a function of operating pressure p_1

For 3/2-way solenoid valves

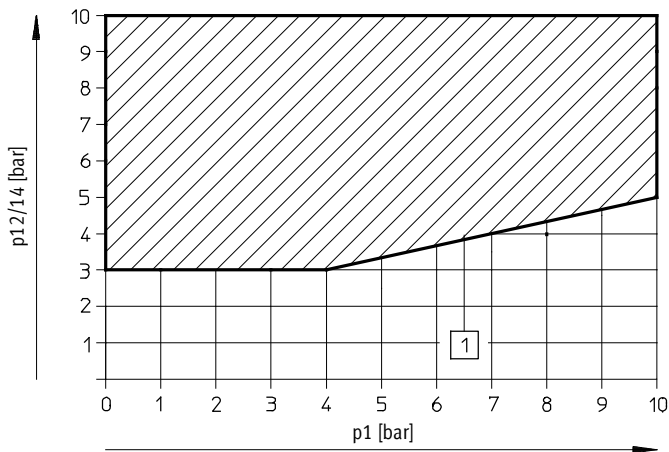

1 Operating range for valves with external pilot air supply

Valve terminals VTSA/VTSA-F, NPT

Technical data – Valve terminal

Pneumatic characteristic data																		
Valve function order code	VC	VV	N	K	H	P	Q	R	M	O	J	D	B	G	E	SA	SB	VG
Direction of flow																		
Any	-	■	-	-	-	-	-	-	■	■	■	■	■	■	■	-	■	■
Reversible only	-	-	-	-	-	■	■	■	-	-	-	-	-	-	-	-	-	-
Non-reversible	■	-	■	■	■	-	-	-	-	-	-	-	-	-	-	■	-	-
Reset method																		
Pneumatic spring	■	■	■	-	■	■	■	■	■	-	-	-	-	-	-	■	■	-
Mechanical spring	-	-	-	■	-	-	-	-	-	■	-	-	■	■	■	-	-	■

Direction of flow of solenoid valves	
Solenoid valves with reversible only flow direction	Solenoid valves with any flow direction
<ul style="list-style-type: none"> • These valves must only be operated on pressure zones with reversible supply (3 and 5 with supply pressure 1 as exhaust air) or on a reversible pressure regulator. If necessary create pressure separation zones with duct separation. • Reversible 3/2-way solenoid valves do not permit the special function "ducted pilot exhaust air" 	<ul style="list-style-type: none"> • Ports 12 and 14 on the end plate variants must be supplied with the same pressure • Right-hand end plate with pilot air selector: can be realised via position 1 or 2 • Right-hand end plate with threaded connections: 12 and 14 must be supplied with the same pressure level
	<ul style="list-style-type: none"> • Valves with any flow direction such as the 5/2-way solenoid valve, code M, for example, are suitable for vacuum operation (standard valves such as the 2x 2/2-way solenoid valve with code VC, for example, may not be used for vacuum operation). • An exception is the 2x 2/2-way solenoid valve with code VV, which only allows vacuum operation at ports 3 and 5. The solenoid valve with code VV cannot be combined with other valve functions; a separate pressure zone is required.

Operating and environmental conditions	
Operating medium	Compressed air to ISO 8573-1:2010 [7:4:4]
Pilot medium	Compressed air to ISO 8573-1:2010 [7:4:4]
Operating pressure for valve terminal with internal pilot air supply ³⁾	
• external	-0.9 ... +10
• internal	3 ... 10
Pilot pressure [bar]	3 ... 10
Noise level LpA [dB(A)]	85
Ambient temperature [°C]	-5 ... +50
Temperature of medium [°C]	-5 ... +50
Storage temperature [°C]	-20 ... +40 (for long-term storage)
Relative humidity [%]	90
PWIS criterion	Free of paint-wetting impairment substances
Certification	BIA (for characteristic SP and/or SN only) C-Tick (only for size 52 mm) cULus recognized (OL) (only for 24 V DC) CSA (OL) (only for 24 V DC, for sizes 18, 26, 42 mm)
CE marking (see declaration of conformity)	In accordance with EU Low Voltage Directive (only VTSA/VTSA-F-MP, 110 V AC) In accordance with EU EMC Directive ¹⁾ To EU Explosion Protection Directive (ATEX, EX1E ²⁾)
ATEX category gas	II 3G (EX1E ²⁾)
Ex-ignition protection type gas	Ex nA IIC T3 X Gc (EX1E ²⁾)
EX-ambient temperature [°C]	-5 ... +50 (EX1E ²⁾)

1) For information about the applicability of the component see the manufacturer's EC declaration of conformity at: www.festo.com → Support → User documentation.
If the component is subject to restrictions on usage in residential, office or commercial environments or small businesses, further measures to reduce the emitted interference may be necessary.

2) EX1E- certification is only valid for: VTSA/VTSA-F-MP, VTSA/VTSA-F-FB

3) Solenoid valves with code VC (2/2-way type ... T22C), N (3/2-way type ... T32U), K (3/2-way type ... T32C), H (3/2-way type ... T32H) must not be operated with vacuum; operating pressure is 3 ... 10 bar here

Valve terminals VTSA/VTSA-F, NPT

Technical data – Valve terminal

Valve switching times																		
Valve function order code ¹⁾	VC	VV	N	K	H	P	Q	R	M	O	J	D	B	G	E	SA	SB	VG
Width 18 mm, nominal operating voltage 24 V DC/110 V AC																		
Switching times [ms]	On	12	12	12	12	12	25	25	25	22	12	-	-	15	15	15	-	-
	Off	30	30	30	30	30	12	12	12	28	38	-	-	44	44	44	-	-
	Change-over	-	-	-	-	-	-	-	-	-	-	11	13	-	-	-	-	-
Width 26 mm, nominal operating voltage 24 V DC/110 V AC																		
Switching times [ms]	On	20	20	20	20	20	32	32	32	25	20	-	-	22	22	22	9/22	9/19
	Off	38	38	38	38	38	30	30	30	45	65	-	-	65	65	65	49	36
	Change-over	-	-	-	-	-	-	-	-	-	-	18	21	-	-	-	33	32
Width 42 mm, nominal operating voltage 24 V DC																		
Switching times [ms]	On	20	20	20	20	20	34	34	34	27	22	-	-	22	22	22	-	-
	Off	38	38	38	38	38	28	28	28	45	60	-	-	65	65	65	-	-
	Change-over	-	-	-	-	-	-	-	-	-	-	16	19	-	-	-	-	-
Width 42 mm, nominal operating voltage 110 V AC																		
Switching times [ms]	On	22	22	22	22	22	34	34	34	20	20	-	-	22	22	22	-	-
	Off	46	46	46	46	46	38	38	38	55	55	-	-	68	68	68	-	-
	Change-over	-	-	-	-	-	-	-	-	-	-	16	19	-	-	-	-	-
Width 52 mm, nominal operating voltage 24 V DC with holding current reduction																		
Switching times [ms]	On	14	-	20	20	20	30	30	30	40	20	-	-	23	23	23	-	-
	Off	35	-	35	35	35	30	30	30	45	60	-	-	60	60	60	-	-
	Change-over	-	-	-	-	-	-	-	-	-	-	18	18	30	30	30	-	-
Width 52 mm, nominal operating voltage 110 V AC																		
Switching times [ms]	On	35	-	35	35	35	50	50	50	70	25	-	-	30	30	30	-	-
	Off	70	-	70	70	70	65	65	65	90	110	-	-	100	100	100	-	-
	Change-over	-	-	-	-	-	-	-	-	-	-	35	42	-	-	-	-	-

1) Valve code SA, switching time 22 ms for control side 12, 9 ms for control side 14
Valve code SB, switching time 19 ms for control side 12, 9 ms for control side 14

Electrical data – Coil characteristics				
Width	18 mm	26 mm	42 mm	52 mm
Coil characteristics at 24 V DC				
2/2-way and 3/2-way solenoid valve [W]	1.3			4.6
5/2-way solenoid valve (code D) [W]	1.3			4.6
5/2-way, 5/3-way solenoid valve [W]	1.6			4.6
Coil characteristics at 110/120 V AC				
2/2-way and 3/2-way solenoid valve [VA]	1.0/1.1			
5/2-way solenoid valve (code D) [W]	1.0/1.1			
5/2-way, 5/3-way solenoid valve [VA]	1.6/1.7			

Valve terminals VTSA/VTSA-F, NPT

Technical data – Valve terminal

Electrical data – Maximum current consumption per solenoid coil, width 52 mm		
At nominal voltage 24 V DC (valves with holding current reduction)		
Nominal pick-up current	[mA]	165
Nominal current following current reduction	[mA]	35
Time until current reduction	[ms]	30

Electrical data – Individual electrical connection		
Load voltage supply for valves (U_{val})		
Operating voltage	[V DC]	24 ±10%
Max. residual current at 24 V DC	[A]	10
Duty cycle		100%
Protection class		IP65, NEMA 4 (for all types of signal transmission in assembled state)

Electrical data – Multi-pin plug connection		
Load voltage supply for valves (U_{val})		
Operating voltage	[V DC]	24 ±10%
	[V AC]	110 ±10% (50 ... 60 Hz)
Max. residual current	[A]	6
Acceptable current load at 40 °C	[A]	1
Surge resistance	[kV]	1.5
Degree of contamination		3
Duty cycle		100%
Protection class		IP65, NEMA 4 (for all types of signal transmission in assembled state)

Electrical data – With CPX terminal		
Power supply for electronics ($U_{EL/SEN}$)		
Operating voltage	[V DC]	24 ±10%
Max. intrinsic current consumption at 24 V DC	[mA]	20
Duty cycle		100%
Load voltage supply for valves (U_{val})		
Operating voltage	[V DC]	24 ±10%
Diagnostic message undervoltage U_{OFF} , load voltage outside function range	[V]	21.6 ... 21.5
Protection class		IP65, NEMA 4 (for all types of signal transmission in assembled state)

Materials	
Manifold sub-base	Die-cast aluminium
Valve	Die-cast aluminium, reinforced polyamide
Seals	Nitrile rubber, elastomer (support made of steel)
Supply plate	Die-cast aluminium
Right-hand end plate	Die-cast aluminium
Pneumatic interface for CPX	Die-cast aluminium
Flow control plate	Die-cast aluminium
Pressure regulator plate	Die-cast aluminium, reinforced polyamide
Multi-pin connection block	Die-cast aluminium
Cover for the pneumatic interface and multi-pin plug connection	Reinforced polyamide
Note on materials	RoHS-compliant

Valve terminals VTSA/VTSA-F, NPT

Technical data – Valve terminal

Product weight				
Approx. weight	[g]			
Width	18 mm	26 mm	42 mm	52 mm
Multi-pin node with Sub-D or terminal strip ¹⁾	550			
Multi-pin node with M12 individual connection	760			
Pneumatic interface CPX ¹⁾	1,470			
Electrical connection for AS-interface	300			
AS-interface module	850			
Supply plate ²⁾				
• Exhaust plate with 3 and 5 common	617			
• Exhaust port cover with 3 and 5 separated	597			
Right-hand end plate ³⁾				
– With threaded connections	339			336
– Selector	281			–
Manifold sub-base ⁴⁾	447	634	340	815
90° connection plate ³⁾	170	230	176	359
Pressure regulator plate				
for port 1 (P)	350	402	640	1,190
for port 4 or 2 (A or B)	367	448	640	1,230
for ports 4 and 2 (A/B)	611	692	920	1,990
Flow control plate	228	320	220	565
Vertical supply plate ³⁾	140	191	340	605
Vertical pressure shut-off plate	209	273	600	1,030
Valves				
• 5/3-way solenoid valve (code: B, G, E)	191	320	456	780
• 5/3-way solenoid valve (code: SA, SB)	–	301	–	–
• 5/3-way solenoid valve (code: VG)	–	–	456	780
• 5/2-way valve, single solenoid (code: M, O)	163	293	426	702
• 5/2-way valve, double solenoid (code: J, D)	172	276	439	732
• 2x 3/2-way solenoid valve (code: N, K, H, P, Q, R)	190	335	442	740
• 2x 2/2-way solenoid valve (code: VC, VV)	190	335	442	740
Blanking plate	34	73	68	146

1) With sheet metal seal, printed circuit board

2) With sheet metal seal and electrical interlinking module

3) With screws

4) With sheet metal seal, electrical interlinking module, inscription label holder, 4 screws

Valve terminals VTSA/VTSA-F, NPT

Technical data – Valve terminal

Dimensions

Download CAD data → www.festo.com

Valve terminal with individual electrical connection

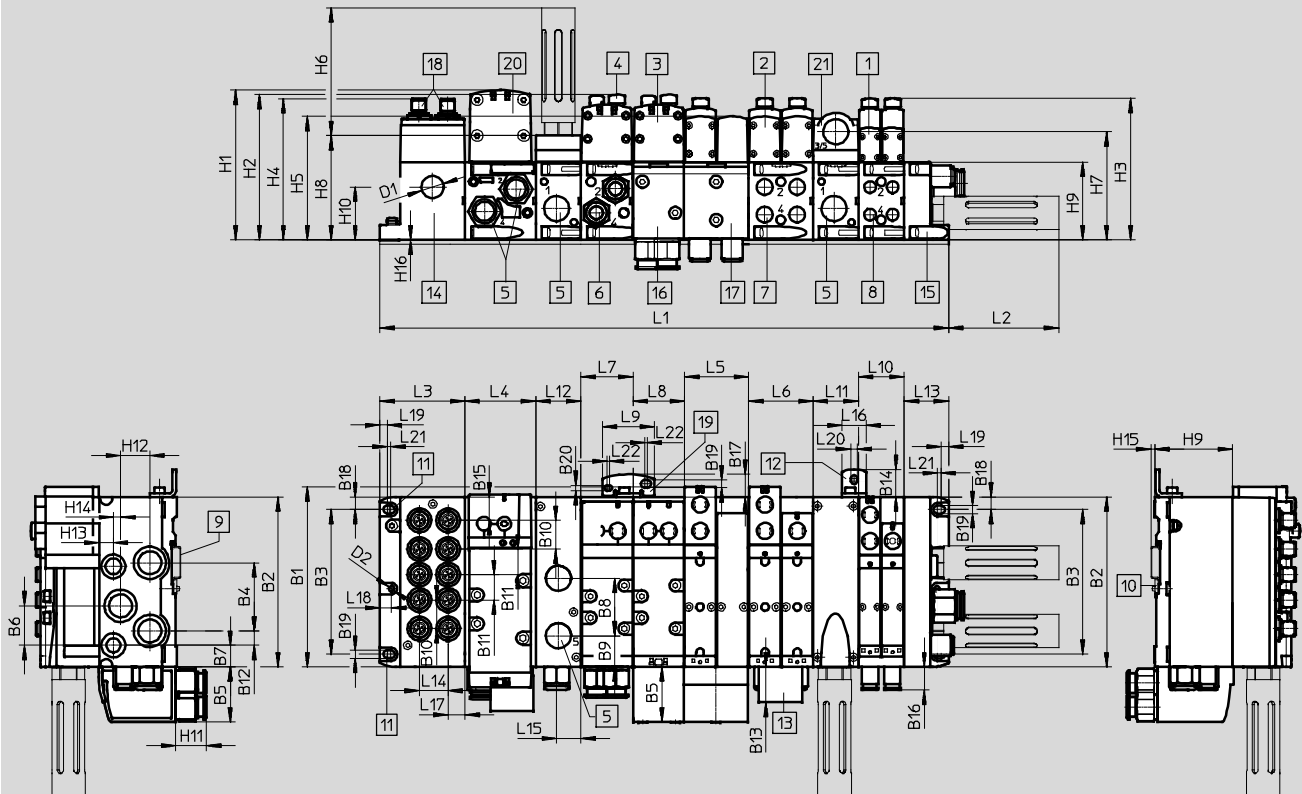

- | | | | |
|--------------------------------|--------------------------------|---|---|
| 1 Solenoid valve, width 18 mm | 7 Threaded connection 1/4" NPT | 16 90° connection plate 43 mm, 3/8" NPT | n02 Number of manifold sub-bases 38 mm |
| 2 Solenoid valve, width 26 mm | 8 Threaded connection 1/8" NPT | 17 90° connection plate 54 mm, 1/4" NPT | n01 Number of manifold sub-bases 54 mm |
| 3 Solenoid valve, width 42 mm | 9 H-rail | 18 M12 plug, 5-pin (6-way or 10-way) | n1 Number of manifold sub-bases 43 mm |
| 4 Cover cap/manual override | 10 H-rail mounting | 19 Additional mounting bracket | n2 Number of manifold sub-bases 59 mm |
| 5 Threaded connection 1/2" NPT | 11 Mounting hole | 20 Solenoid valve, width 52 mm | n Number of supply plates (only with end plate with pilot air selector) |
| 6 Threaded connection 3/8" NPT | 12 Additional mounting bracket | 21 Supply plate | |
| | 13 Inscription label holder | | |
| | 14 Individual connection | | |
| | 15 End plate | | |

Dim.	B1	B2	B3	B4	B5	B6	B7	B8	B9	B10	B11	B12	B13	B14	B15	B16	B17	B18	B19	B20
[mm]	150.5	142	121	57	46	33	18	48	26	24	21.3	12	29.6	23	19.6	19.5	19	10.5	6.6	4.5

Dim.	L2	L3	L4	L5	L6	L7	L8	L9	L10	L11	L12	L13	L14	L15	L16	L17	L18	L19
[mm]	92.4	71.3	n2x59	n01x54	54	n1x43	43	43.5	n02x38	nx38	38	37.3	24	20.5	20	14.1	9.8	6.3

Dim.	L20	L21	L22	D1∅	D2∅	H1	H2	H3	H4	H5	H6	H7	H8	H9	H10	H11	H12	H13	H14	H15	H16
[mm]	5.5	3	2	18.5	4.5	125	121.3	118.2	118	103	107.8	90.3	87	65	44	25.7	24.5	12	6	3.5	0.5

Width	L1
18 mm	71.3 + n02 x 38 + n x 38 + 37.3
26 mm	71.3 + n01 x 54 + n x 38 + 37.3
42 mm	71.3 + n1 x 43 + n x 38 + 37.3
52 mm	71.3 + n2 x 59 + n x 38 + 37.3
Mixture of 18 mm, 26 mm, 42 mm and 52 mm	71.3 + n02 x 38 + n01 x 54 + n1 x 43 + n2x59 + n x 38 + 37.3

– † – Note: This product conforms to ISO 1179-1 and to ISO 228-1

Valve terminals VTSA/VTSA-F, NPT

Technical data – Valve terminal



Dimensions

Download CAD data → www.festo.com

Valve terminal with multi-pin plug connection

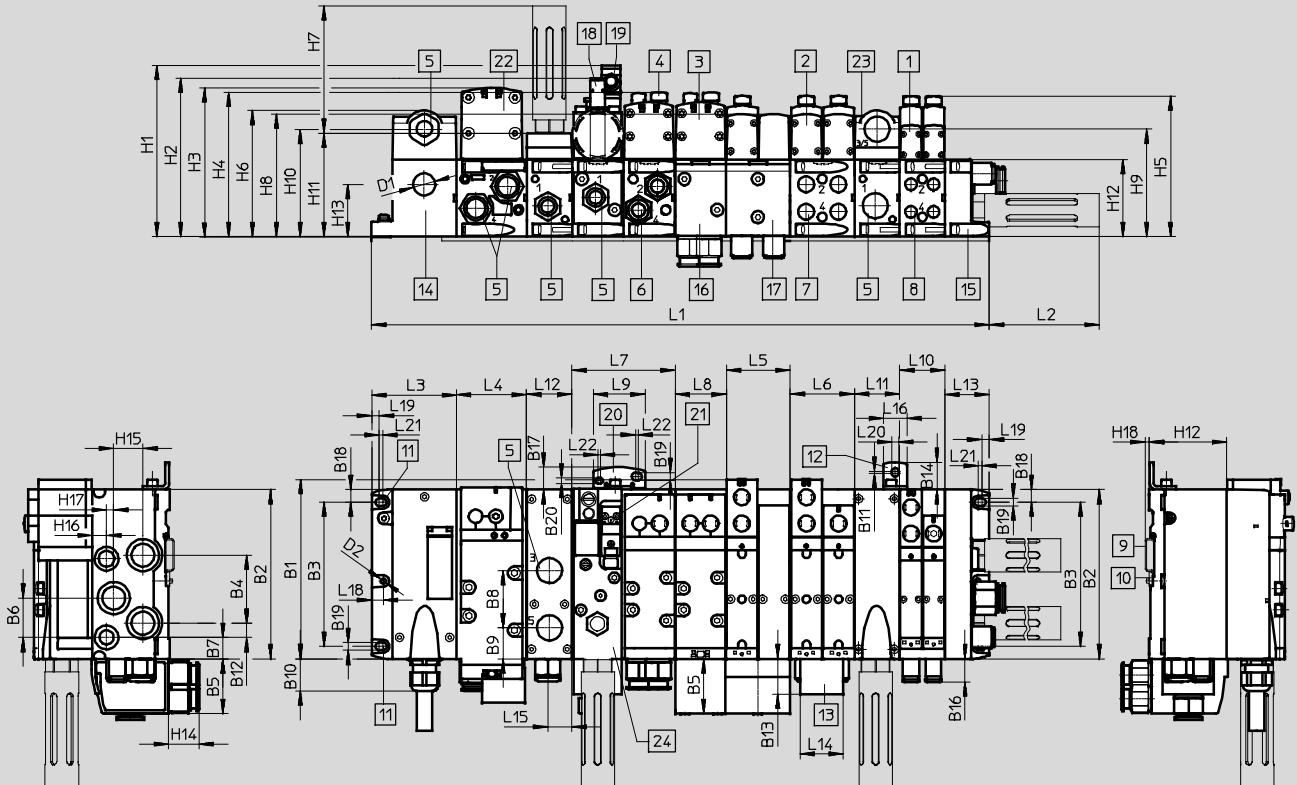

- | | | | |
|--------------------------------|---|---|---|
| 1 Solenoid valve, width 18 mm | 9 H-rail | 17 90° connection plate 54 mm, 1/4" NPT | n02 Number of manifold sub-bases 38 mm |
| 2 Solenoid valve, width 26 mm | 10 H-rail mounting | 18 Proximity sensor M12x1 | n01 Number of manifold sub-bases 54 mm |
| 3 Solenoid valve, width 42 mm | 11 Mounting hole | 19 Plug socket M12x1 | n1 Number of manifold sub-bases 43 mm |
| 4 Cover cap/manual override | 12 Additional mounting bracket | 20 Inscription label holder | n2 Number of manifold sub-bases 59 mm |
| 5 Threaded connection 1/2" NPT | 13 Inscription label holder | 21 Electrical connection to DIN EN 175301-803, type C | n Number of supply plates (only with end plate with pilot air selector) |
| 6 Threaded connection 3/8" NPT | 14 Multi-pin plug connection | 22 Solenoid valve, width 52 mm | |
| 7 Threaded connection 1/4" NPT | 15 End plate | 23 Supply plate | |
| 8 Threaded connection 1/8" NPT | 16 90° connection plate 43 mm, 3/8" NPT | 24 Soft-start valve | |

Dim.	B1	B2	B3	B4	B5	B6	B7	B8	B9	B10	B11	B12	B13	B14	B16	B17	B18	B19	B20
[mm]	150.5	142	121	57	46	33	18	48	26	27	2	12	29.6	23	19.5	19	10.5	6.6	4.5

Dim.	L2	L3	L4	L5	L6	L7	L8	L9	L10	L11	L12	L13	L14	L15	L16	L18	L19	L20	L21
[mm]	92.4	71.3	n2x59	n01x54	54	n1x43	43	43.5	n02x38	nx38	38	37.3	36	20.5	20	9.8	6.3	5.5	3

Dim.	L22	D1Ø	D2Ø	H1	H2	H3	H4	H5	H6	H7	H8	H9	H10	H11	H12	H13	H14	H15	H16	H17	H18
[mm]	2	18.5	4.5	143.9	133.3	125	121.3	118.2	106.3	107.8	103	90.3	90.3	87	65	44	25.7	24.5	12	6	3.5

Width	L1
18 mm	71.3 + n02 x 38 + n x 38 + 37.3
26 mm	71.3 + n01 x 54 + n x 38 + 37.3
42 mm	71.3 + n1 x 43 + n x 38 + 37.3
52 mm	71.3 + n2 x 59 + n x 38 + 37.3
Mixture of 18 mm, 26 mm, 42 mm and 52 mm	71.3 + n02 x 38 + n01 x 54 + n1 x 43 + n2 x 59 + n x 38 + 37.3

• Note: This product conforms to ISO 1179-1 and to ISO 228-1

Valve terminals VTSA/VTSA-F, NPT

Technical data – Valve terminal

Dimensions

Download CAD data → www.festo.com

Multi-pin, terminal strip (CageClamp®), VABE-S6-1LF-C-M1-C...

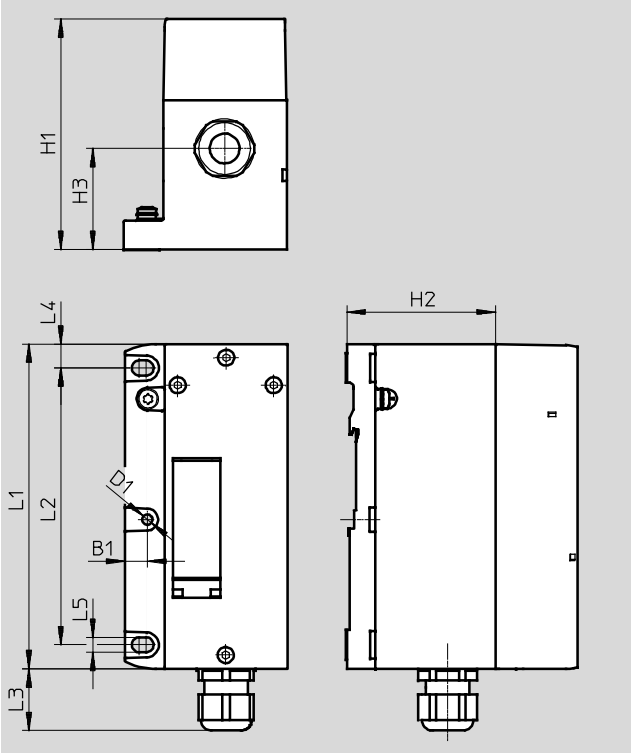

Multi-pin, round plug connector, VABE-S6-1LF-C-M1-R...

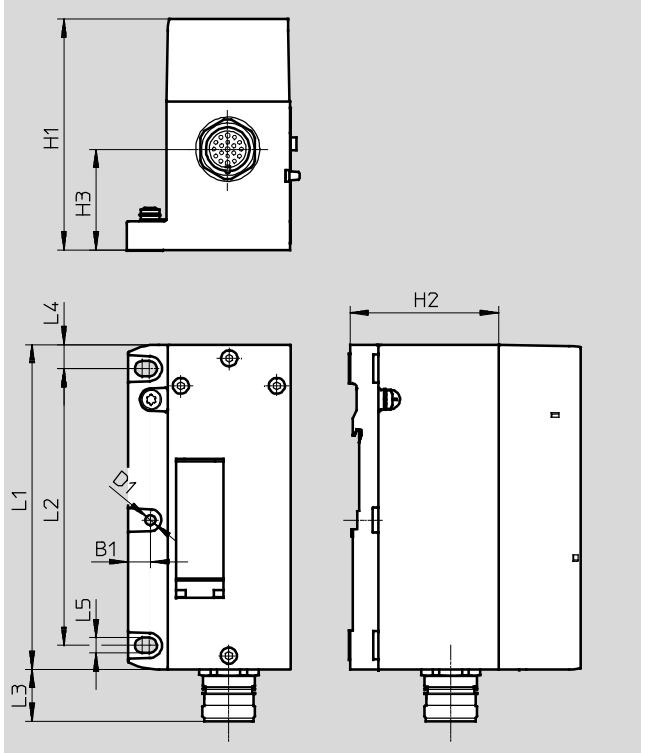

Type	H1	H2	H3	D1Ø	L1	L2	L3	L4	L5	B1
VABE-S6-1LF-C-M1-C...	106.1	65	44	4.5	142	121	27	10.5	6.6	9.8
VABE-S6-1LF-C-M1-R...	101	65	44	4.5	142	121	23	10.5	6.6	9.8

Valve terminals VTSA/VTSA-F, NPT

Technical data – Valve terminal

FESTO

Dimensions

Download CAD data → www.festo.com

Valve terminal with AS-interface connection

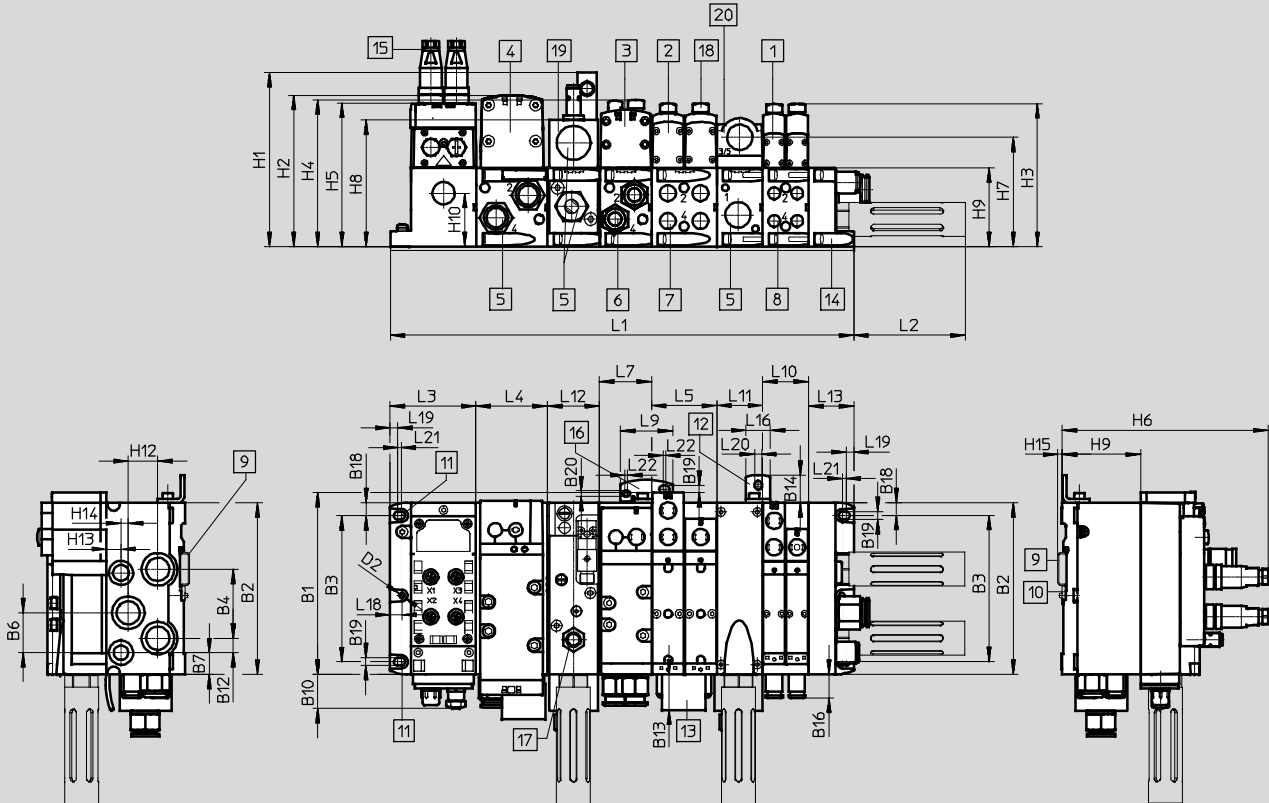

- | | | | |
|--------------------------------|--------------------------------|----------------------------------|--|
| 1 Solenoid valve, width 18 mm | 7 Threaded connection 1/4" NPT | 16 Additional mounting | n02 Number of manifold sub-bases 38 mm |
| 2 Solenoid valve, width 26 mm | 8 Threaded connection 1/8" NPT | 17 Proximity sensor M12x1 | n01 Number of manifold sub-bases 54 mm |
| 3 Solenoid valve, width 42 mm | 9 H-rail | 18 Cover cap/manual override | n1 Number of manifold sub-bases 43 mm |
| 4 Solenoid valve, width 52 mm | 10 H-rail mounting | 19 Soft-start valve, width 43 mm | n2 Number of manifold sub-bases 59 mm |
| 5 Threaded connection 1/2" NPT | 11 Mounting hole | 20 Supply plate | n Number of supply plates |
| 6 Threaded connection 3/8" NPT | 12 Additional mounting bracket | | |
| | 13 Inscription label | | |
| | 14 End plate | | |
| | 15 Plug M12 | | |

Dim.	B1	B2	B3	B4	B6	B7	B10	B12	B13	B14	B16	B18	B19	B20
[mm]	150.5	142	121	57	33	18	28	12	29.6	23	19.5	10.5	6.6	4.5

Dim.	L2	L3	L4	L5	L7	L9	L10	L11	L12	L13	L16	L18	L19	L20	L21
[mm]	92.4	71.3	n2x59	n01x54	n1x43	43.5	n02x38	nx38	43	37.3	20	9.8	6.3	5.5	3

Dim.	L22	D2∅	H1	H2	H3	H4	H5	H6	H7	H8	H9	H10	H12	H13	H14	H15
[mm]	2	4.5	143.9	125	118.2	121.3	118.6	171	90.3	104.5	65	44	24.5	12	6	3.5

Width	L1
18 mm	71.3 + n02 x 38 + n x 38 + 37.3
26 mm	71.3 + n01 x 54 + n x 38 + 37.3
42 mm	71.3 + n1 x 43 + n x 38 + 37.3
52 mm	71.3 + n2 x 59 + n x 38 + 37.3
Mixture of 18 mm, 26 mm, 42 mm and 52 mm	71.3 + n02 x 38 + n01 x 54 + n1 x 43 + n2 x 59 + n x 38 + 37.3

Valve terminals VTSA/VTSA-F, NPT

Technical data – Valve terminal



Dimensions

Download CAD data → www.festo.com

Valve terminal with fieldbus connection

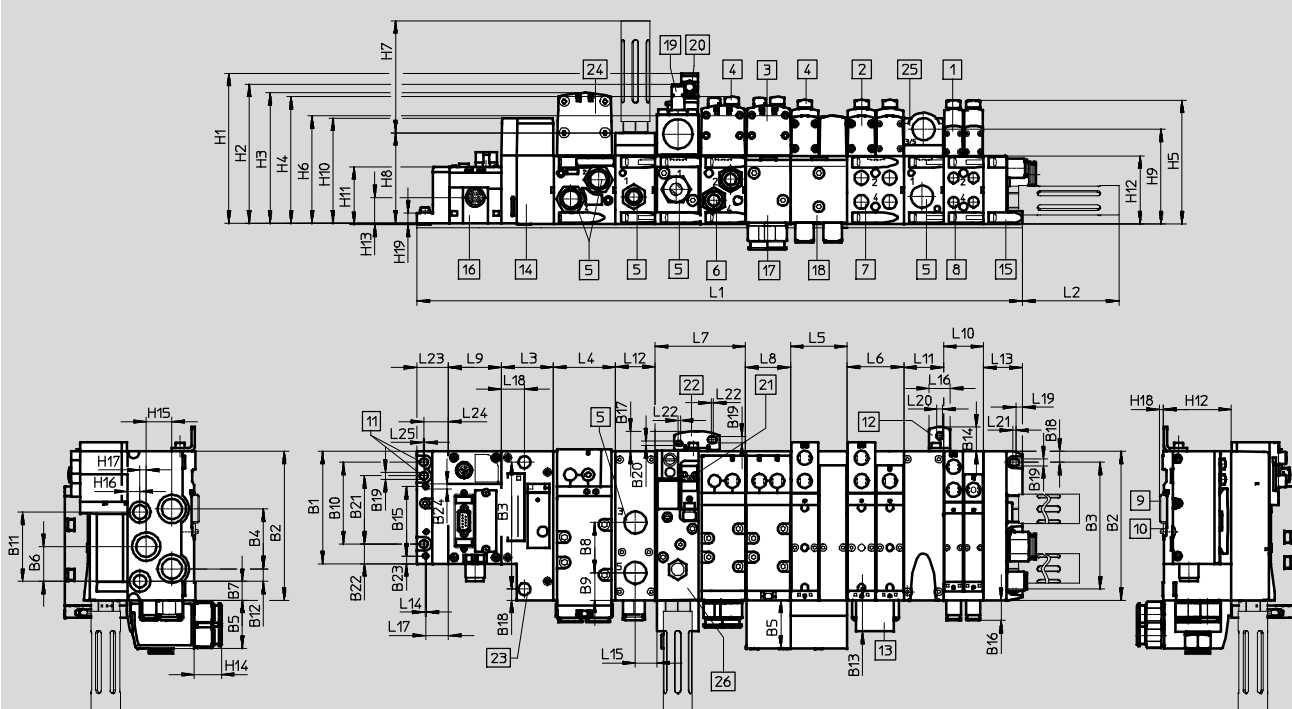

- | | | | |
|--------------------------------|---|---|---|
| 1 Solenoid valve, width 18 mm | 10 H-rail mounting | 19 Proximity sensor M12x1 | n02 Number of manifold sub-bases 38 mm |
| 2 Solenoid valve, width 26 mm | 11 Mounting hole | 20 Plug socket M12x1 | n01 Number of manifold sub-bases 54 mm |
| 3 Solenoid valve, width 42 mm | 12 Additional mounting bracket | 21 Electrical connection to DIN EN 175301-803, type C | n1 Number of manifold sub-bases 43 mm |
| 4 Cover cap/manual override | 13 Inscription label holder | 22 Additional mounting bracket | n2 Number of manifold sub-bases 59 mm |
| 5 Threaded connection 1/2" NPT | 14 Pneumatic interface CPX | 23 Hole for additional mounting, diameter 6.4 2x | n Number of supply plates (only with end plate with pilot air selector) |
| 6 Threaded connection 3/8" NPT | 15 End plate | 24 Solenoid valve, width 52 mm | m Number of CPX modules |
| 7 Threaded connection 1/4" NPT | 16 CPX module/fieldbus node | 25 Supply plate | |
| 8 Threaded connection 1/8" NPT | 17 90° connection plate 43 mm, 3/8" NPT | 26 Soft-start valve | |
| 9 H-rail | 18 90° connection plate 54 mm, 1/4" NPT | | |

Dim.	B1	B2	B3	B4	B5	B6	B7	B8	B9	B10	B11	B12	B13	B14	B16	B18	B19	B20	B21	B22	B23	B24
[mm]	107.3	142	121	57	46	33	18	48	26	78	66	12	29.6	23	19.5	10.5	6.6	4.5	65	18.9	7.5	4.4

Dim.	L2	L3	L4	L5	L6	L7	L8	L9	L10	L11	L12	L13	L14	L15	L16	L17	L18	L19	L20	L21	L22
[mm]	92.4	50	n2x59	n01x54	54	n1x43	43	mx20.1	n02x38	nx38	38	37.3	1	20.5	20	22	22	6.3	5.5	3	2

Dim.	L23	L24	L25	H1	H2	H3	H4	H5	H6	H7	H8	H9	H10	H11	H12	H13	H14	H15	H16	H17	H18	H19
[mm]	30.4	23.7	1.5	143.9	133.3	125	121.3	118.2	103	106.8	87	90.3	101.4	55.1	65	25.8	25.7	24.5	12	6	3.5	10.8

Width	L1
18 mm	$30.4 + m \times 50.1 + 50 + n02 \times 38 + n \times 38 + 37.3$
26 mm	$30.4 + m \times 50.1 + 50 + n01 \times 54 + n \times 38 + 37.3$
42 mm	$30.4 + m \times 50.1 + 50 + n1 \times 43 + n \times 38 + 37.3$
52 mm	$30.4 + m \times 50.1 + 50 + n2 \times 59 + n \times 38 + 37.3$
Mixture of 18 mm, 26 mm, 42 mm and 52 mm	$30.4 + m \times 50.1 + 50 + n02 \times 38 + n01 \times 54 + n1 \times 43 + n2 \times 59 + n \times 38 + 37.3$

– Note: This product conforms to ISO 1179-1 and to ISO 228-1

Valve terminals VTSA/VTSA-F, NPT

Technical data – Valve terminal

FESTO

Dimensions

Download CAD data → www.festo.com

Vertical stacking components, width 18 mm

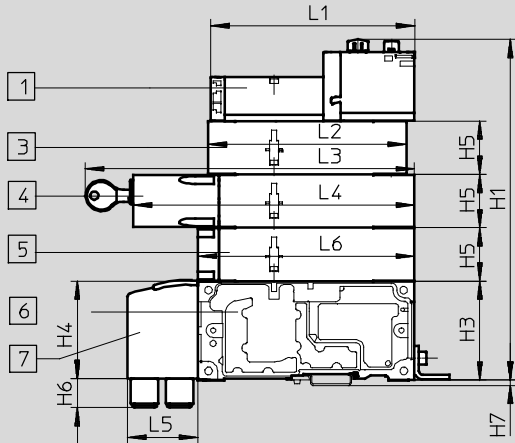

- 1 Solenoid valve with two solenoid coils, width 18 mm
- 3 Flow control plate
- 4 Vertical pressure shut-off plate
- 5 Vertical supply plate
- 6 Manifold sub-base
- 7 90° connection plate

Dim.	L1	L2	L3	L4	L5	L6	H1	H3	H4	H5	H6	H7
[mm]	133.8	130	184.1	203.7	46	142	224	65	64	35	19	3.5

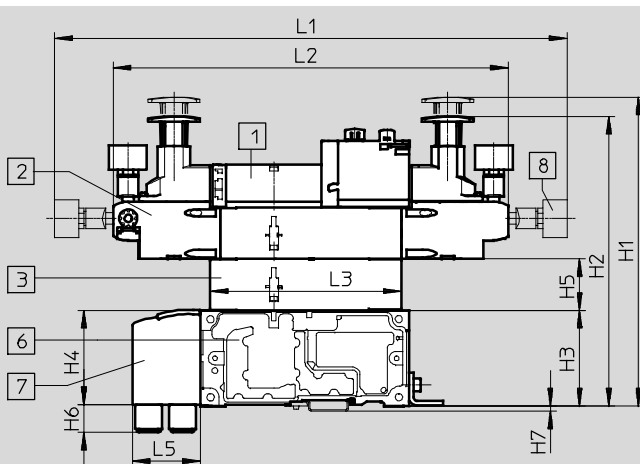

- 1 Solenoid valve with two solenoid coils, width 18 mm
- 2 Pressure regulator plate
- 3 Flow control plate
- 6 Manifold sub-base
- 7 90° connection plate
- 8 Pressure gauge, freely positionable

Dim.	L1	L2	L3	L5	H1	H2	H3	H4	H5	H6	H7
[mm]	348.2	268.6	130	46	210	197	65	64	35	19	3.5

Vertical stacking components, width 18 mm, with the pressure regulator plate also suitable for valves with symmetrical coil layout

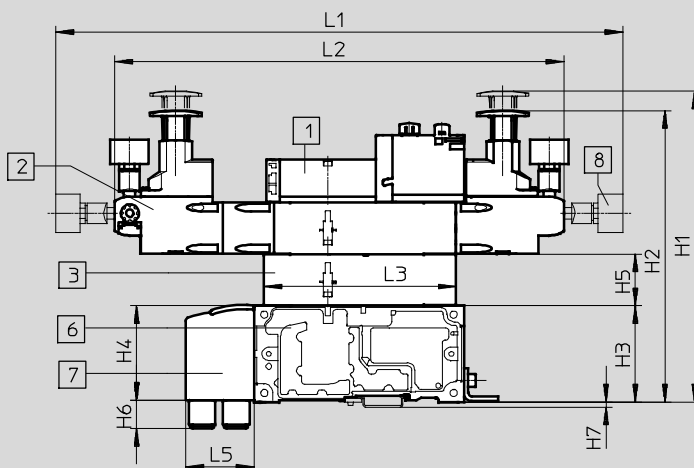

- 1 Solenoid valve with two solenoid coils, width 18 mm
- 2 Pressure regulator plate
- 3 Flow control plate
- 6 Manifold sub-base
- 7 90° connection plate
- 8 Pressure gauge, freely positionable

Dim.	L1	L2	L3	L5	H1	H2	H3	H4	H5	H6	H7
[mm]	383.2	303.6	130	46	210	197	65	64	35	19	3.5

Valve terminals VTSA/VTSA-F, NPT

Technical data – Valve terminal

Dimensions

Download CAD data → www.festo.com

Vertical stacking components, width 26 mm

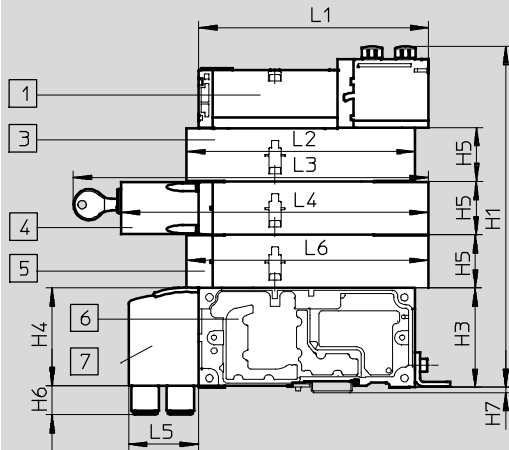

- 1 Solenoid valve with two solenoid coils, width 26 mm
- 3 Flow control plate
- 4 Vertical pressure shut-off plate
- 5 Vertical supply plate
- 6 Manifold sub-base
- 7 90° connection plate

Dim.	L1	L2	L3	L4	L5	L6	H1	H3	H4	H5	H6	H7
[mm]	150.8	150	221	201.4	46	158.5	224	65	64	35	19	3.5

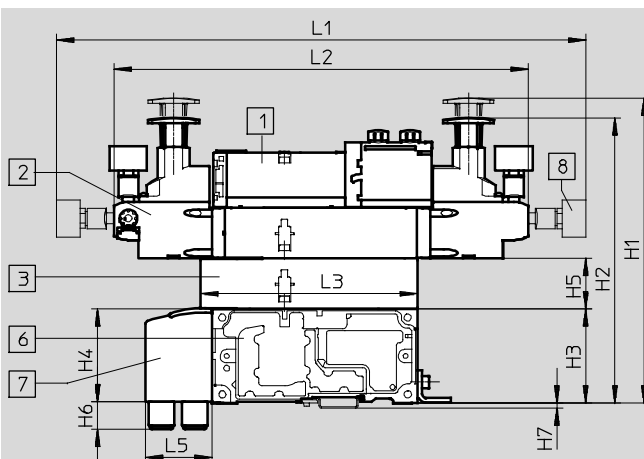

- 1 Solenoid valve with two solenoid coils, width 26 mm
- 2 Pressure regulator plate
- 3 Flow control plate
- 6 Manifold sub-base
- 7 90° connection plate
- 8 Pressure gauge, freely positionable

Dim.	L1	L2	L3	L5	H1	H2	H3	H4	H5	H6	H7
[mm]	365.7	286.1	150	46	210	197	65	64	35	19	3.5

Vertical stacking components, width 26 mm, with the pressure regulator plate also suitable for valves with symmetrical coil layout

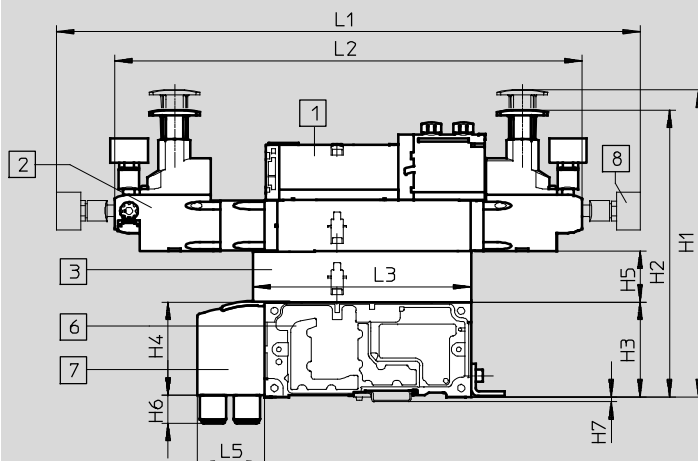

- 1 Solenoid valve with two solenoid coils, width 26 mm
- 2 Pressure regulator plate
- 3 Flow control plate
- 6 Manifold sub-base
- 7 90° connection plate
- 8 Pressure gauge, freely positionable

Dim.	L1	L2	L3	L5	H1	H2	H3	H4	H5	H6	H7
[mm]	400.7	321.1	150	46	210	197	65	64	35	19	3.5

Valve terminals VTSA/VTSA-F, NPT

Technical data – Valve terminal

FESTO

Dimensions

Download CAD data → www.festo.com

Vertical stacking components, width 42 mm

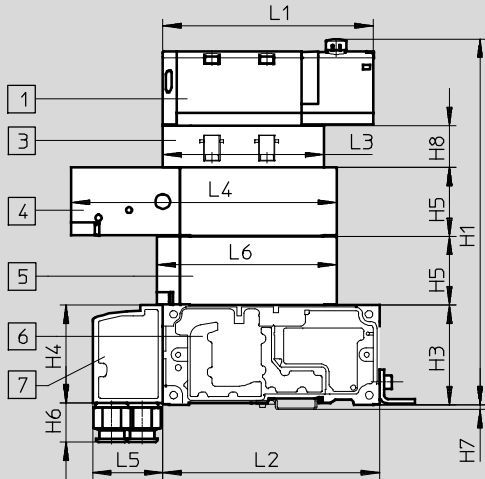

- 1 Solenoid valve
- 3 Flow control plate
- 4 Vertical pressure shut-off plate
- 5 Vertical supply plate
- 6 Manifold sub-base
- 7 90° connection plate

Dim.	L1	L2	L3	L4	L5	L6	H1	H3	H4	H5	H6	H7	H8
[mm]	137.8	142	105.3	173.8	46	117.6	236	65	64	45.3	25.7	3.5	28

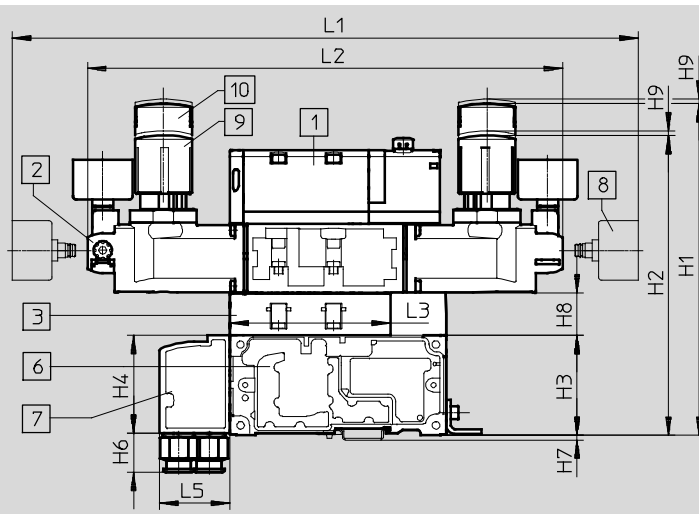

- 1 Solenoid valve
- 2 Pressure regulator plate
- 3 Flow control plate
- 6 Manifold sub-base
- 7 90° connection plate
- 8 Pressure gauge, freely positionable
- 9 Standard rotary knob
- 10 Lockable rotary knob

Dim.	L1	L2	L3	L5	H1	H2	H3	H4	H6	H7	H8	H9
[mm]	410.3	311.6	105.3	46	220.7	196.1	65	64	25.7	3.5	28	3

Note

Pressure regulator plates for valves with symmetrical coil layout with widths of 42 mm and 52 mm can

only be ordered via the pressure regulator configurator VABF-S2.
→ Internet: vabf-s2

Valve terminals VTSA/VTSA-F, NPT

Technical data – Valve terminal

Dimensions

Download CAD data → www.festo.com

Vertical stacking components, width 52 mm

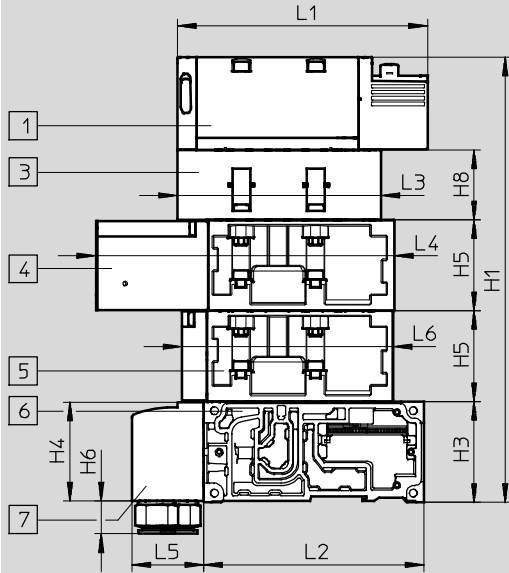

- 1 Solenoid valve
- 3 Flow control plate
- 4 Vertical pressure shut-off plate
- 5 Vertical supply plate
- 6 Manifold sub-base
- 7 90° connection plate

Dim.	L1	L2	L3	L4	L5	L6	H1	H3	H4	H5	H6	H8
[mm]	160.7	142	131	191.2	46	136	287.4	65	63.5	58.7	21.2	45

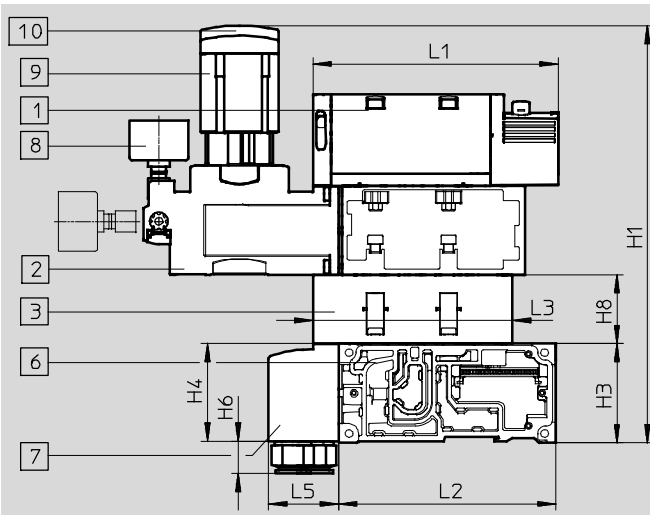

- 1 Solenoid valve
- 2 Pressure regulator plate
- 3 Flow control plate
- 6 Manifold sub-base
- 7 90° connection plate
- 8 Pressure gauge, freely positionable
- 9 Standard rotary knob
- 10 Lockable rotary knob

Dim.	L1	L2	L3	L5	H1	H3	H4	H6	H8
[mm]	160.7	142	131	46	278	32.5	63.5	21.2	22.5

 Note

Pressure regulator plates for valves with symmetrical coil layout with widths of 42 mm and 52 mm can

only be ordered via the pressure regulator configurator VABF-S2.
→ Internet: vabf-s2

Valve terminals VTSA/VTSA-F, NPT

Technical data – Valve terminal

FESTO

Dimensions

Download CAD data → www.festo.com

Supply plate with silencer

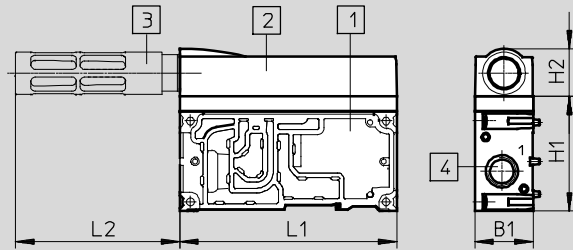

- 1 Supply plate
- 2 Exhaust port cover
- 3 Silencer U-1/2-B-NPT
- 4 Threaded connection 1/2" NPT

Dim.	L1	L2	H1	H2	B1
[mm]	142	107.5	75	31.5	38

Right-hand end plate, VABE-S6-1R...

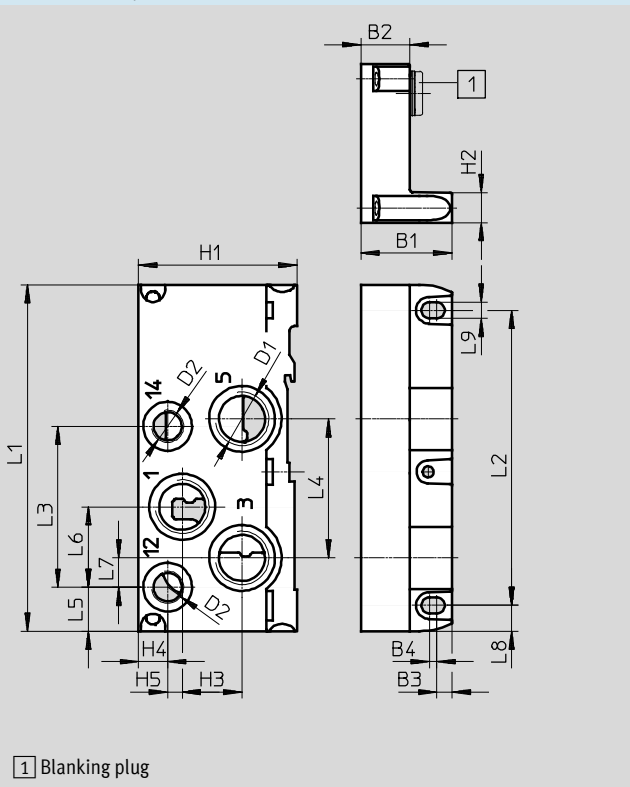

Right-hand end plate, VABE-S6-2R...

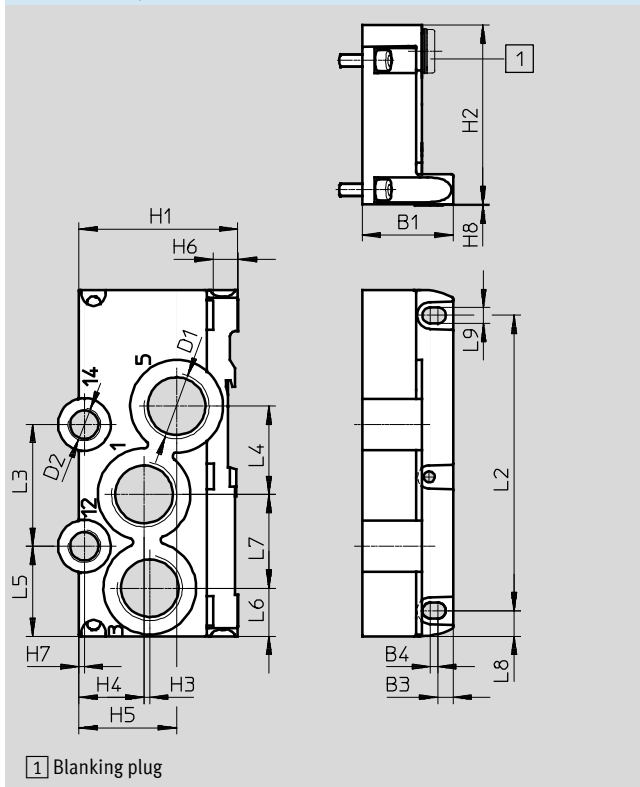

Type	L1	L2	L3	L4	L5	L6	L7	L8	L9	D1	D2	H1	H2	H3	H4	H5	H6	H7	H8	B1	B2	B3	B4	With ¹⁾
VABE-S6-1R-G12	142	121	66	57	18	33	12	10.5	6.6	1/2" NPT	3/4" NPT	65	12.5	24.5	12	6	-	-	-	37.3	22	6.3	3	1
VABE-S6-1RZ-G12	-	-	-	-	-	-	-	-	-	-	-	-	-	-	-	-	-	-	-	-	-	-	-	-
VABE-S6-2R-G34	-	121	49.9	36.2	36.9	19.7	38.4	10.5	6.6	3/4" NPT	3/4" NPT	65	73.6	2.3	26.7	40	10.8	2.2	0.4	37.3	-	6.3	3	1
VABE-S6-2RZ-G34	-	-	-	-	-	-	-	-	-	-	-	-	-	-	-	-	-	-	-	-	-	-	-	-

1) With blanking plug = internal pilot air supply, - without blanking plug = external pilot air supply

- Note: This product conforms to ISO 1179-1 and to ISO 228-1

Valve terminals VTSA/VTSA-F, NPT

Technical data – Valve terminal

Dimensions

Download CAD data → www.festo.com

Right-hand end plate with pilot air selector, VABE-S6-1RZ-G-B1

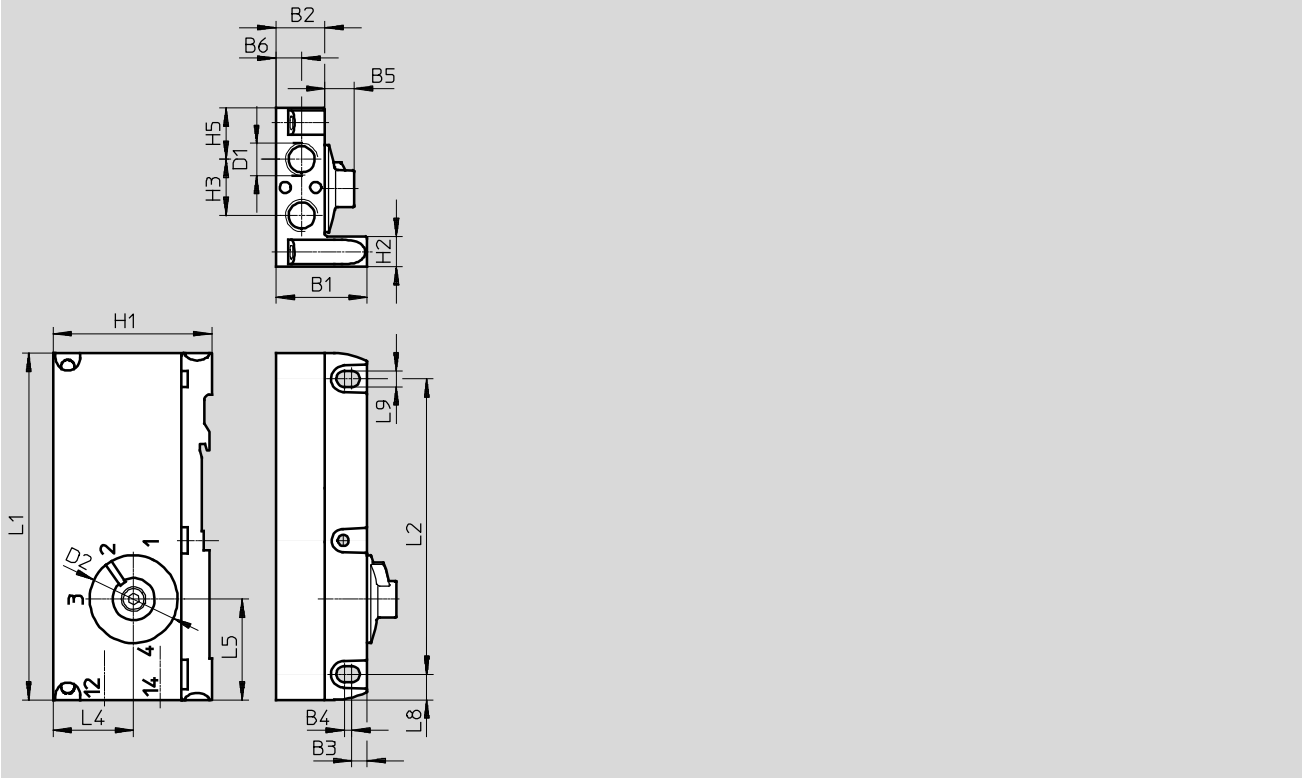

Type	L1	L2	L5	L8	L9	D1	D2	H1	H2	H3	H4	H5	B1	B2	B3	B4	B5	B6
VABE-S6-1RZ-G-B1	142	121	41.3	10.5	6.6	1/4" NPT	37	65.4	12.5	23	33	21	37.3	20	6.3	3	12	10.5

• Note: This product conforms to ISO 1179-1 and to ISO 228-1

Valve terminals VTSA/VTSA-F, NPT

FESTO

Ordering data – Individual valve 24 V DC

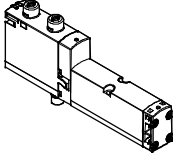
Ordering data					
	Code	Valve function	Width	Part No.	Type
Solenoid valves, 24 V DC					
	VC	2x 2/2-way valve, single solenoid, normally closed, pneumatic spring return	18 mm	561155	VSVA-B-T22C-AZD-A2-1T1L
	VV	2x 2/2-way valve, single solenoid, normally closed, pneumatic spring return, vacuum operation possible at 3 and 5	18 mm	561159	VSVA-B-T22CV-AZD-A2-1T1L
	N	2x 3/2-way valve, single solenoid, normally open	18 mm	539178	VSVA-B-T32U-AZD-A2-1T1L
	K	2x 3/2-way valve, single solenoid, normally closed	18 mm	539176	VSVA-B-T32C-AZD-A2-1T1L
	H	2x 3/2-way valve, single solenoid, 1x normally open, 1x normally closed	18 mm	539180	VSVA-B-T32H-AZD-A2-1T1L
	P	2x 3/2-way valve, single solenoid, reverse operation, normally open	18 mm	539179	VSVA-B-T32F-AZD-A2-1T1L
	Q	2x 3/2-way valve, single solenoid, reverse operation, normally closed	18 mm	539177	VSVA-B-T32N-AZD-A2-1T1L
	R	2x 3/2-way valve, single solenoid, reverse operation, 1x normally open, 1x normally closed	18 mm	539181	VSVA-B-T32W-AZD-A2-1T1L
	M	5/2-way valve, single solenoid, pneumatic spring return	18 mm	539184	VSVA-B-M52-AZD-A2-1T1L
	O	5/2-way valve, single solenoid, mechanical spring return	18 mm	539185	VSVA-B-M52-MZD-A2-1T1L
	J	5/2-way valve, double solenoid	18 mm	539182	VSVA-B-B52-ZD-A2-1T1L
	D	5/2-way valve, double solenoid, with dominant signal	18 mm	539183	VSVA-B-D52-ZD-A2-1T1L
	B	5/3-way solenoid valve, mid-position pressurised	18 mm	539186	VSVA-B-P53U-ZD-A2-1T1L
	G	5/3-way solenoid valve, mid-position closed	18 mm	539188	VSVA-B-P53C-ZD-A2-1T1L
	E	5/3-way solenoid valve, mid-position exhausted	18 mm	539187	VSVA-B-P53E-ZD-A2-1T1L

Valve terminals VTSA/VTSA-F, NPT

Ordering data – Individual valve 24 V DC

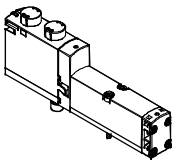
Ordering data				
	Code	Valve function	Width	Part No. Type
Solenoid valves, 24 V DC				
	VC	2x 2/2-way valve, single solenoid, normally closed, pneumatic spring return	26 mm	561149 VSVA-B-T22C-AZD-A1-1T1L
	VV	2x 2/2-way valve, single solenoid, normally closed, pneumatic spring return, vacuum operation possible at 3 and 5	26 mm	561153 VSVA-B-T22CV-AZD-A1-1T1L
	N	2x 3/2-way valve, single solenoid, normally open	26 mm	539152 VSVA-B-T32U-AZD-A1-1T1L
	K	2x 3/2-way valve, single solenoid, normally closed	26 mm	539150 VSVA-B-T32C-AZD-A1-1T1L
	H	2x 3/2-way valve, single solenoid, 1x normally open, 1x normally closed	26 mm	539154 VSVA-B-T32H-AZD-A1-1T1L
	P	2x 3/2-way valve, single solenoid, reverse operation, normally open	26 mm	539153 VSVA-B-T32F-AZD-A1-1T1L
	Q	2x 3/2-way valve, single solenoid, reverse operation, normally closed	26 mm	539151 VSVA-B-T32N-AZD-A1-1T1L
	R	2x 3/2-way valve, single solenoid, reverse operation, 1x normally open, 1x normally closed	26 mm	539155 VSVA-B-T32W-AZD-A1-1T1L
	M	5/2-way valve, single solenoid, pneumatic spring return	26 mm	539158 VSVA-B-M52-AZD-A1-1T1L
	O	5/2-way valve, single solenoid, mechanical spring return	26 mm	539159 VSVA-B-M52-MZD-A1-1T1L
	J	5/2-way valve, double solenoid	26 mm	539156 VSVA-B-B52-ZD-A1-1T1L
	D	5/2-way valve, double solenoid, with dominant signal	26 mm	539157 VSVA-B-D52-ZD-A1-1T1L
	B	5/3-way solenoid valve, mid-position pressurised	26 mm	539160 VSVA-B-P53U-ZD-A1-1T1L
	G	5/3-way solenoid valve, mid-position closed	26 mm	539162 VSVA-B-P53C-ZD-A1-1T1L
	E	5/3-way solenoid valve, mid-position exhausted	26 mm	539161 VSVA-B-P53E-ZD-A1-1T1L
	SA	5/3-way solenoid valve, mid-position exhausted, switching position 14 detenting, mechanical spring return	26 mm	560727 VSVA-B-P53ED-ZD-A1-1T1L
SB	5/3-way solenoid valve, mid-position 1x exhausted from 4 to 5, 1x pressurised from 1 to 2, switching position 14 detenting, same function in both switching positions: pressurised from 1 to 4 and exhausted from 2 to 3, mechanical spring return	26 mm	560728 VSVA-B-P53AD-ZD-A1-1T1L	

Valve terminals VTSA/VTSA-F, NPT

FESTO

Ordering data – Individual valve 24 V DC

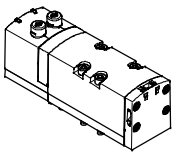
Ordering data					
	Code	Valve function	Width	Part No.	Type
Solenoid valves, 24 V DC					
	VC	2x 2/2-way valve, single solenoid, normally closed, pneumatic spring return	42 mm	561340	VSVA-B-T22C-AZD-D1-1T1L
	VV	2x 2/2-way valve, single solenoid, normally closed, pneumatic spring return, vacuum operation possible at 3 and 5	42 mm	561344	VSVA-B-T22CV-AZD-D1-1T1L
	N	2x 3/2-way valve, single solenoid, normally open	42 mm	543692	VSVA-B-T32U-AZD-D1-1T1L
	K	2x 3/2-way valve, single solenoid, normally closed	42 mm	543690	VSVA-B-T32C-AZD-D1-1T1L
	H	2x 3/2-way valve, single solenoid, 1x normally open, 1x normally closed	42 mm	543694	VSVA-B-T32H-AZD-D1-1T1L
	P	2x 3/2-way valve, single solenoid, reverse operation, normally open	42 mm	543693	VSVA-B-T32F-AZD-D1-1T1L
	Q	2x 3/2-way valve, single solenoid, reverse operation, normally closed	42 mm	543691	VSVA-B-T32N-AZD-D1-1T1L
	R	2x 3/2-way valve, single solenoid, reverse operation, 1x normally open, 1x normally closed	42 mm	543695	VSVA-B-T32W-AZD-D1-1T1L
	M	5/2-way valve, single solenoid, pneumatic spring return	42 mm	543698	VSVA-B-M52-AZD-D1-1T1L
	O	5/2-way valve, single solenoid, mechanical spring return	42 mm	543699	VSVA-B-M52-MZD-D1-1T1L
	J	5/2-way valve, double solenoid	42 mm	543696	VSVA-B-B52-ZD-D1-1T1L
	D	5/2-way valve, double solenoid, with dominant signal	42 mm	543697	VSVA-B-D52-ZD-D1-1T1L
	B	5/3-way solenoid valve, mid-position pressurised	42 mm	543700	VSVA-B-P53U-ZD-D1-1T1L
	G	5/3-way solenoid valve, mid-position closed	42 mm	543702	VSVA-B-P53C-ZD-D1-1T1L
	E	5/3-way solenoid valve, mid-position exhausted	42 mm	543701	VSVA-B-P53E-ZD-D1-1T1L
	VG	5/3-way solenoid valve, mid-position pressurised 1 to 2, 4 to 5 closed	42 mm	8000464	VSVA-B-P53F-ZD-D1-1T1L

Valve terminals VTSA/VTSA-F, NPT

Ordering data – Individual valve 24 V DC

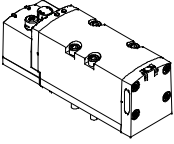
Ordering data				
	Code	Valve function	Width	Part No. Type
Solenoid valves, 24 V DC				
	VC	2x 2/2-way valve, single solenoid, normally closed, pneumatic spring return	52 mm	560831 VSVA-B-T22C-AZD-D2-1T1L
	N	2x 3/2-way valve, single solenoid, normally open	52 mm	560827 VSVA-B-T32U-AZD-D2-1T1L
	K	2x 3/2-way valve, single solenoid, normally closed	52 mm	560825 VSVA-B-T32C-AZD-D2-1T1L
	H	2x 3/2-way valve, single solenoid, 1x normally open, 1x normally closed	52 mm	560829 VSVA-B-T32H-AZD-D2-1T1L
	P	2x 3/2-way valve, single solenoid, reverse operation, normally open	52 mm	560828 VSVA-B-T32F-AZD-D2-1T1L
	Q	2x 3/2-way valve, single solenoid, reverse operation, normally closed	52 mm	560826 VSVA-B-T32N-AZD-D2-1T1L
	R	2x 3/2-way valve, single solenoid, reverse operation, 1x normally open, 1x normally closed	52 mm	560830 VSVA-B-T32W-AZD-D2-1T1L
	M	5/2-way valve, single solenoid, pneumatic spring return	52 mm	560820 VSVA-B-M52-AZD-D2-1T1L
	O	5/2-way valve, single solenoid, mechanical spring return	52 mm	560821 VSVA-B-M52-MZD-D2-1T1L
	J	5/2-way valve, double solenoid	52 mm	560818 VSVA-B-B52-ZD-D2-1T1L
	D	5/2-way valve, double solenoid, with dominant signal	52 mm	560819 VSVA-B-D52-ZD-D2-1T1L
	B	5/3-way solenoid valve, mid-position pressurised	52 mm	560822 VSVA-B-P53U-ZD-D2-1T1L
	G	5/3-way solenoid valve, mid-position closed	52 mm	560824 VSVA-B-P53C-ZD-D2-1T1L
	E	5/3-way solenoid valve, mid-position exhausted	52 mm	560823 VSVA-B-P53E-ZD-D2-1T1L
VG	5/3-way solenoid valve, mid-position pressurised 1 to 2, 4 to 5 closed	52 mm	8000465 VSVA-B-P53F-ZD-D2-1T1L	

Valve terminals VTSA/VTSA-F, NPT

FESTO

Ordering data – Individual valve 110 V AC

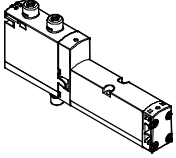
Ordering data					
	Code	Valve function	Width	Part No.	Type
Solenoid valves, 110 V AC					
	VC	2x 2/2-way valve, single solenoid, normally closed, pneumatic spring return	18 mm	561156	VSVA-B-T22C-AZD-A2-2AT1L
	VV	2x 2/2-way valve, single solenoid, normally closed, pneumatic spring return, vacuum operation possible at 3 and 5	18 mm	561160	VSVA-B-T22CV-AZD-A2-2AT1L
	N	2x 3/2-way valve, single solenoid, normally open	18 mm	539165	VSVA-B-T32U-AZD-A2-2AT1L
	K	2x 3/2-way valve, single solenoid, normally closed	18 mm	539163	VSVA-B-T32C-AZD-A2-2AT1L
	H	2x 3/2-way valve, single solenoid, 1x normally open, 1x normally closed	18 mm	539167	VSVA-B-T32H-AZD-A2-2AT1L
	P	2x 3/2-way valve, single solenoid, reverse operation, normally open	18 mm	539166	VSVA-B-T32F-AZD-A2-2AT1L
	Q	2x 3/2-way valve, single solenoid, reverse operation, normally closed	18 mm	539164	VSVA-B-T32N-AZD-A2-2AT1L
	R	2x 3/2-way valve, single solenoid, reverse operation, 1x normally open, 1x normally closed	18 mm	539168	VSVA-B-T32W-AZD-A2-2AT1L
	M	5/2-way valve, single solenoid, pneumatic spring return	18 mm	539171	VSVA-B-M52-AZD-A2-2AT1L
	O	5/2-way valve, single solenoid, mechanical spring return	18 mm	539172	VSVA-B-M52-MZD-A2-2AT1L
	J	5/2-way valve, double solenoid	18 mm	539169	VSVA-B-B52-ZD-A2-2AT1L
	D	5/2-way valve, double solenoid, with dominant signal	18 mm	539170	VSVA-B-D52-ZD-A2-2AT1L
	B	5/3-way solenoid valve, mid-position pressurised	18 mm	539173	VSVA-B-P53U-ZD-A2-2AT1L
	G	5/3-way solenoid valve, mid-position closed	18 mm	539175	VSVA-B-P53C-ZD-A2-2AT1L
	E	5/3-way solenoid valve, mid-position exhausted	18 mm	539174	VSVA-B-P53E-ZD-A2-2AT1L

Valve terminals VTSA/VTSA-F, NPT

Ordering data – Individual valve 110 V AC

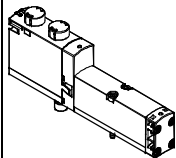
Ordering data				
	Code	Valve function	Width	Part No. Type
Solenoid valves, 110 V AC				
	VC	2x 2/2-way valve, single solenoid, normally closed, pneumatic spring return	26 mm	561150 VSVA-B-T22C-AZD-A1-2AT1L
	VV	2x 2/2-way valve, single solenoid, normally closed, pneumatic spring return, vacuum operation possible at 3 and 5	26 mm	561154 VSVA-B-T22CV-AZD-A1-2AT1L
	N	2x 3/2-way valve, single solenoid, normally open	26 mm	539139 VSVA-B-T32U-AZD-A1-2AT1L
	K	2x 3/2-way valve, single solenoid, normally closed	26 mm	539137 VSVA-B-T32C-AZD-A1-2AT1L
	H	2x 3/2-way valve, single solenoid, 1x normally open, 1x normally closed	26 mm	539141 VSVA-B-T32H-AZD-A1-2AT1L
	P	2x 3/2-way valve, single solenoid, reverse operation, normally open	26 mm	539140 VSVA-B-T32F-AZD-A1-2AT1L
	Q	2x 3/2-way valve, single solenoid, reverse operation, normally closed	26 mm	539138 VSVA-B-T32N-AZD-A1-2AT1L
	R	2x 3/2-way valve, single solenoid, reverse operation, 1x normally open, 1x normally closed	26 mm	539142 VSVA-B-T32W-AZD-A1-2AT1L
	M	5/2-way valve, single solenoid, pneumatic spring return	26 mm	539145 VSVA-B-M52-AZD-A1-2AT1L
	O	5/2-way valve, single solenoid, mechanical spring return	26 mm	539146 VSVA-B-M52-MZD-A1-2AT1L
	J	5/2-way valve, double solenoid	26 mm	539143 VSVA-B-B52-ZD-A1-2AT1L
	D	5/2-way valve, double solenoid, with dominant signal	26 mm	539144 VSVA-B-D52-ZD-A1-2AT1L
	B	5/3-way solenoid valve, mid-position pressurised	26 mm	539147 VSVA-B-P53U-ZD-A1-2AT1L
	G	5/3-way solenoid valve, mid-position closed	26 mm	539149 VSVA-B-P53C-ZD-A1-2AT1L
	E	5/3-way solenoid valve, mid-position exhausted	26 mm	539148 VSVA-B-P53E-ZD-A1-2AT1L

Valve terminals VTSA/VTSA-F, NPT

FESTO

Ordering data – Individual valve 110 V AC

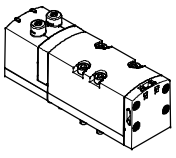
Ordering data					
	Code	Valve function	Width	Part No.	Type
Solenoid valves, 110 V AC					
	VC	2x 2/2-way valve, single solenoid, normally closed, pneumatic spring return	42 mm	561341	VSVA-B-T22C-AZD-D1-2AT1L
	VV	2x 2/2-way valve, single solenoid, normally closed, pneumatic spring return, vacuum operation possible at 3 and 5	42 mm	561345	VSVA-B-T22CV-AZD-D1-2AT1L
	N	2x 3/2-way valve, single solenoid, normally open	42 mm	543679	VSVA-B-T32U-AZD-D1-2AT1L
	K	2x 3/2-way valve, single solenoid, normally closed	42 mm	543677	VSVA-B-T32C-AZD-D1-2AT1L
	H	2x 3/2-way valve, single solenoid, 1x normally open, 1x normally closed	42 mm	543681	VSVA-B-T32H-AZD-D1-2AT1L
	P	2x 3/2-way valve, single solenoid, reverse operation, normally open	42 mm	543680	VSVA-B-T32F-AZD-D1-2AT1L
	Q	2x 3/2-way valve, single solenoid, reverse operation, normally closed	42 mm	543678	VSVA-B-T32N-AZD-D1-2AT1L
	R	2x 3/2-way valve, single solenoid, reverse operation, 1x normally open, 1x normally closed	42 mm	543682	VSVA-B-T32W-AZD-D1-2AT1L
	M	5/2-way valve, single solenoid, pneumatic spring return	42 mm	543685	VSVA-B-M52-AZD-D1-2AT1L
	O	5/2-way valve, single solenoid, mechanical spring return	42 mm	543686	VSVA-B-M52-MZD-D1-2AT1L
	J	5/2-way valve, double solenoid	42 mm	543683	VSVA-B-B52-ZD-D1-2AT1L
	D	5/2-way valve, double solenoid, with dominant signal	42 mm	543684	VSVA-B-D52-ZD-D1-2AT1L
	B	5/3-way solenoid valve, mid-position pressurised	42 mm	543687	VSVA-B-P53U-ZD-D1-2AT1L
	G	5/3-way solenoid valve, mid-position closed	42 mm	543689	VSVA-B-P53C-ZD-D1-2AT1L
	E	5/3-way solenoid valve, mid-position exhausted	42 mm	543688	VSVA-B-P53E-ZD-D1-2AT1L

Valve terminals VTSA/VTSA-F, NPT

FESTO

Ordering data – Individual valve 110 V AC

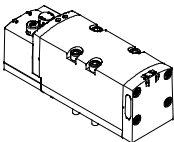
Ordering data				
	Code	Valve function	Width	Part No. Type
Solenoid valves, 110 V AC				
	VC	2x 2/2-way valve, single solenoid, normally closed, pneumatic spring return	52 mm	560812 VSVA-B-T22C-AZD-D2-2AT1L
	N	2x 3/2-way valve, single solenoid, normally open	52 mm	560808 VSVA-B-T32U-AZD-D2-2AT1L
	K	2x 3/2-way valve, single solenoid, normally closed	52 mm	560806 VSVA-B-T32C-AZD-D2-2AT1L
	H	2x 3/2-way valve, single solenoid, 1x normally open, 1x normally closed	52 mm	560810 VSVA-B-T32H-AZD-D2-2AT1L
	P	2x 3/2-way valve, single solenoid, reverse operation, normally open	52 mm	560809 VSVA-B-T32F-AZD-D2-2AT1L
	Q	2x 3/2-way valve, single solenoid, reverse operation, normally closed	52 mm	560807 VSVA-B-T32N-AZD-D2-2AT1L
	R	2x 3/2-way valve, single solenoid, reverse operation, 1x normally open, 1x normally closed	52 mm	560811 VSVA-B-T32W-AZD-D2-2AT1L
	M	5/2-way valve, single solenoid, pneumatic spring return	52 mm	560801 VSVA-B-M52-AZD-D2-2AT1L
	O	5/2-way valve, single solenoid, mechanical spring return	52 mm	560802 VSVA-B-M52-MZD-D2-2AT1L
	J	5/2-way valve, double solenoid	52 mm	560799 VSVA-B-B52-ZD-D2-2AT1L
	D	5/2-way valve, double solenoid, with dominant signal	52 mm	560800 VSVA-B-D52-ZD-D2-2AT1L
	B	5/3-way solenoid valve, mid-position pressurised	52 mm	560803 VSVA-B-P53U-ZD-D2-2AT1L
	G	5/3-way solenoid valve, mid-position closed	52 mm	560805 VSVA-B-P53C-ZD-D2-2AT1L
	E	5/3-way solenoid valve, mid-position exhausted	52 mm	560804 VSVA-B-P53E-ZD-D2-2AT1L

Valve terminals VTSA/VTSA-F, NPT

FESTO



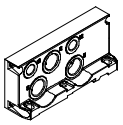
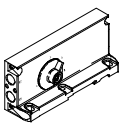
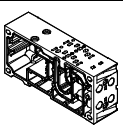
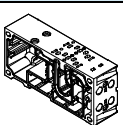

Accessories – Pneumatic components

Ordering data					
	Code	Description	Width	Part No.	Type
Right-hand end plate					
	V	With supply air/exhaust air, internal pilot air supply, 1/2" NPT		539235	VABE-S6-1R-N12
	V1	With supply air/exhaust air, internal pilot air supply, 3/4" NPT		560838	VABE-S6-2R-N34
	X	With supply air/exhaust air, external pilot air supply, 1/2" NPT		539237	VABE-S6-1RZ-N12
	X1	With supply air/exhaust air, external pilot air supply, 3/4" NPT		560840	VABE-S6-2RZ-N34
End plate with pilot air selector					
	Y	Internal pilot air supply		539239	VABE-S6-1RZ-N-B1
	U	Internal pilot air supply, ducted pilot exhaust air			
	Z	External pilot air supply			
	W	External pilot air supply, ducted pilot exhaust air			
Manifold sub-base, port pattern to ISO 15407-2 and ISO 5599-2					
	A	2 valve positions, 4 addresses, for double solenoid valves	18 mm	539223	VABV-S4-2S-N18-2T2
	B	2 valve positions, 4 addresses, for double solenoid valves	26 mm	539219	VABV-S4-1S-N14-2T2
	C	1 valve position, 2 addresses, for double solenoid valves	42 mm	542460	VABV-S2-1S-N38-T2
	D	1 valve position, 2 addresses, for double solenoid valves	52 mm	560843	VABV-S2-2S-N12-T2
	E	2 valve positions, 2 addresses, for single solenoid valves	18 mm	539225	VABV-S4-2S-N18-2T1
	F	2 valve positions, 2 addresses, for single solenoid valves	26 mm	539221	VABV-S4-1S-N14-2T1
	G	1 valve position, 1 address, for single solenoid valves	42 mm	542461	VABV-S2-1S-N38-T1
	H	1 valve position, 1 address, for single solenoid valves	52 mm	560844	VABV-S2-2S-N12-T1
Manifold sub-base VTSA-F, optimised for flow rate					
	A	2 valve positions, 4 addresses, for double solenoid valves	18 mm	546217	VABV-S4-2HS-N18-2T2
	B	2 valve positions, 4 addresses, for double solenoid valves	26 mm	546213	VABV-S4-1HS-N14-2T2
	E	2 valve positions, 2 addresses, for single solenoid valves	18 mm	546216	VABV-S4-2HS-N18-2T1
	F	2 valve positions, 2 addresses, for single solenoid valves	26 mm	546212	VABV-S4-1HS-N14-2T1

Valve terminals VTSA/VTSA-F, NPT

Accessories – Pneumatic components

FESTO

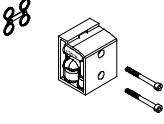
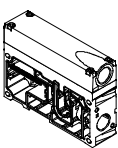
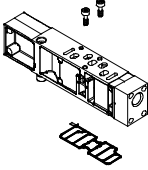
Ordering data					
	Code	Description	Width	Part No.	Type
Separator plate					
	S	Duct separation 1, 3, 5		539228	VABD-S6-1-P3-C
	T	Duct separation 1		539227	VABD-S6-1-P1-C
	R	Duct separation 3, 5		539229	VABD-S6-1-P2-C
Seal					
	–	For manifold sub-bases		668436	VABD-S6-1-C
90° connection plate					
	P	Outlet at bottom, connecting thread 1/8" NPT	18 mm	539720	VABF-S4-2-A2G2-N18
		Outlet at bottom, connecting thread 1/4" NPT	26 mm	539722	VABF-S4-1-A2G2-N14
		Outlet at bottom, connecting thread 3/8" NPT	42 mm	546098	VABF-S2-1-A1G2-N38
		Outlet at bottom, connecting thread 1/2" NPT	52 mm	555703	VABF-S2-2-A1G2-N12
Supply plate					
	L	With exhaust plate, 3/5 common, 1/2" NPT		539233	VABF-S6-1-P1A7-N12
	K	With exhaust port cover, 3/5 separated, 1/2" NPT		539232	VABF-S6-1-P1A6-N12
Vertical supply plate (operating pressure 0.9...10 bar)					
	ZU	Connecting thread 1/8" NPT Individual compressed air supply, duct 1	18 mm	540174	VABF-S4-2-P1A3-N18
		Connecting thread 1/4" NPT Individual compressed air supply, duct 1	26 mm	540172	VABF-S4-1-P1A3-N14
		Connecting thread 3/8" NPT Individual compressed air supply, duct 1	42 mm	546094	VABF-S2-1-P1A3-N38
		Connecting thread 1/2" NPT Individual compressed air supply, duct 1	52 mm	555787	VABF-S2-2-P1A3-N12
		Connecting thread 1/8" NPT Individual compressed air supply, ducts 1 and 14	18 mm	8000694	VABF-S4-2-P1A14-N18
	ZV	Connecting thread 1/4" NPT Individual compressed air supply, ducts 1 and 14	26 mm	8000690	VABF-S4-2-P1A14-N14
		Connecting thread 3/8" NPT Individual compressed air supply, ducts 1 and 14	42 mm	8000540	VABF-S2-1-P1A14-N38
		Connecting thread 1/2" NPT Individual compressed air supply, ducts 1 and 14	52 mm	8000550	VABF-S2-2-P1A14-N12

Valve terminals VTSA/VTSA-F, NPT

Accessories – Pneumatic components

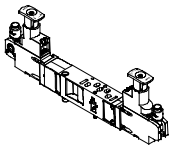
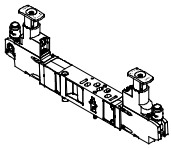
Ordering data					
	Code	Description	Width	Part No.	Type
Regulator plate, width 18 mm					
	ZA	For port 1, 0.5...10 bar	18 mm	540153	VABF-S4-2-R1C2-C-10
	ZF	For port 1, 0.5...6 bar	18 mm	540151	VABF-S4-2-R1C2-C-6
	ZC	For port 2, 2...10 bar	18 mm	540161	VABF-S4-2-R2C2-C-10
	ZH	For port 2, 2...6 bar	18 mm	540159	VABF-S4-2-R2C2-C-6
	ZB	For port 4, 2...10 bar	18 mm	540157	VABF-S4-2-R3C2-C-10
	ZG	For port 4, 2...6 bar	18 mm	540155	VABF-S4-2-R3C2-C-6
	ZD	For ports 2 and 4, 2...10 bar	18 mm	540165	VABF-S4-2-R4C2-C-10
	ZI	For ports 2 and 4, 2...6 bar	18 mm	540163	VABF-S4-2-R4C2-C-6
	ZE	For ports 2 and 4, reversible, 0.5...10 bar	18 mm	540169	VABF-S4-2-R5C2-C-10
	ZJ	For ports 2 and 4, reversible, 0.5...6 bar	18 mm	540167	VABF-S4-2-R5C2-C-6
	ZL	For port 2, reversible, 0.5...10 bar	18 mm	546252	VABF-S4-2-R6C2-C-10
	ZN	For port 2, reversible, 0.5...6 bar	18 mm	546248	VABF-S4-2-R6C2-C-6
	ZK	For port 4, reversible, 0.5...10 bar	18 mm	546254	VABF-S4-2-R7C2-C-10
	ZM	For port 4, reversible, 0.5...6 bar	18 mm	546250	VABF-S4-2-R7C2-C-6
Regulator plate, width 26 mm					
	ZA	For port 1, 0.5...10 bar	26 mm	540154	VABF-S4-1-R1C2-C-10
	ZF	For port 1, 0.5...6 bar	26 mm	540152	VABF-S4-1-R1C2-C-6
	ZC	For port 2, 2...10 bar	26 mm	540162	VABF-S4-1-R2C2-C-10
	ZH	For port 2, 2...6 bar	26 mm	540160	VABF-S4-1-R2C2-C-6
	ZB	For port 4, 2...10 bar	26 mm	540158	VABF-S4-1-R3C2-C-10
	ZG	For port 4, 2...6 bar	26 mm	540156	VABF-S4-1-R3C2-C-6
	ZD	For ports 2 and 4, 2...10 bar	26 mm	540166	VABF-S4-1-R4C2-C-10
	ZI	For ports 2 and 4, 2...6 bar	26 mm	540164	VABF-S4-1-R4C2-C-6
	ZE	For ports 2 and 4, reversible, 0.5...10 bar	26 mm	540170	VABF-S4-1-R5C2-C-10
	ZJ	For ports 2 and 4, reversible, 0.5...6 bar	26 mm	540168	VABF-S4-1-R5C2-C-6
	ZL	For port 2, reversible, 0.5...10 bar	26 mm	546251	VABF-S4-1-R6C2-C-10
	ZN	For port 2, reversible, 0.5...6 bar	26 mm	546247	VABF-S4-1-R6C2-C-6
	ZK	For port 4, reversible, 0.5...10 bar	26 mm	546253	VABF-S4-1-R7C2-C-10
	ZM	For port 4, reversible, 0.5...6 bar	26 mm	546249	VABF-S4-1-R7C2-C-6

Valve terminals VTSA/VTSA-F, NPT

Accessories – Pneumatic components

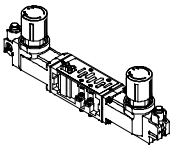
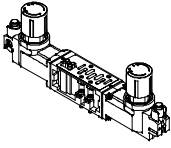
Ordering data					
	Code	Description	Width	Part No.	Type
Regulator plate, width 42 mm					
	ZA	For port 1, 0.5...10 bar	42 mm	546084	VABF-S2-1-R1C2-C-10
	ZF	For port 1, 0.5...6 bar	42 mm	546083	VABF-S2-1-R1C2-C-6
	ZC	For port 2, 0.5...10 bar	42 mm	546088	VABF-S2-1-R2C2-C-10
	ZH	For port 2, 0.5...6 bar	42 mm	546087	VABF-S2-1-R2C2-C-6
	ZB	For port 4, 0.5...10 bar	42 mm	546086	VABF-S2-1-R3C2-C-10
	ZG	For port 4, 0.5...6 bar	42 mm	546085	VABF-S2-1-R3C2-C-6
	ZD	For ports 2 and 4, 0.5...10 bar	42 mm	546090	VABF-S2-1-R4C2-C-10
	ZI	For ports 2 and 4, 0.5...6 bar	42 mm	546089	VABF-S2-1-R4C2-C-6
	ZE	For ports 2 and 4, reversible, 0.5...10 bar	42 mm	546092	VABF-S2-1-R5C2-C-10
	ZJ	For ports 2 and 4, reversible, 0.5...6 bar	42 mm	546091	VABF-S2-1-R5C2-C-6
	ZL	For port 2, reversible, 0.5...10 bar	42 mm	546832	VABF-S2-1-R6C2-C-10
	ZN	For port 2, reversible, 0.5...6 bar	42 mm	546831	VABF-S2-1-R6C2-C-6
	ZK	For port 4, reversible, 0.5...10 bar	42 mm	546834	VABF-S2-1-R7C2-C-10
	ZM	For port 4, reversible, 0.5...6 bar	42 mm	546833	VABF-S2-1-R7C2-C-6
Regulator plate, width 52 mm					
	ZA	For port 1, 0.5...10 bar	52 mm	555772	VABF-S2-2-R1C2-C-10
	ZF	For port 1, 0.5...6 bar	52 mm	555771	VABF-S2-2-R1C2-C-6
	ZC	For port 2, 0.5...10 bar	52 mm	555774	VABF-S2-2-R2C2-C-10
	ZH	For port 2, 0.5...6 bar	52 mm	555773	VABF-S2-2-R2C2-C-6
	ZB	For port 4, 0.5...10 bar	52 mm	555776	VABF-S2-2-R3C2-C-10
	ZG	For port 4, 0.5...6 bar	52 mm	555775	VABF-S2-2-R3C2-C-6
	ZD	For ports 2 and 4, 0.5...10 bar	52 mm	555778	VABF-S2-2-R4C2-C-10
	ZI	For ports 2 and 4, 0.5...6 bar	52 mm	555777	VABF-S2-2-R4C2-C-6
	ZE	For ports 2 and 4, reversible, 0.5...10 bar	52 mm	555780	VABF-S2-2-R5C2-C-10
	ZJ	For ports 2 and 4, reversible, 0.5...6 bar	52 mm	555779	VABF-S2-2-R5C2-C-6
	ZL	For port 2, reversible, 0.5...10 bar	52 mm	555782	VABF-S2-2-R6C2-C-10
	ZN	For port 2, reversible, 0.5...6 bar	52 mm	555781	VABF-S2-2-R6C2-C-6
	ZK	For port 4, reversible, 0.5...10 bar	52 mm	555784	VABF-S2-2-R7C2-C-10
	ZM	For port 4, reversible, 0.5...6 bar	52 mm	555783	VABF-S2-2-R7C2-C-6

Valve terminals VTSA/VTSA-F, NPT

FESTO

Accessories – Pneumatic components

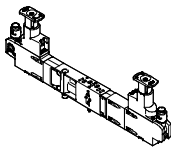
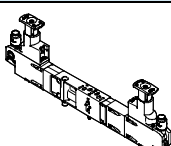
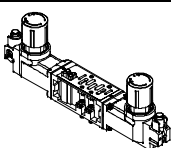

Ordering data					
	Code	Description	Width	Part No.	Type
Regulator plate for valves with symmetrical coil layout, width 18 mm					
	ZAY	For port 1, 0.5...10 bar	18 mm	560756	VABF-S4-2-R1C2-C-10E
	ZFY	For port 1, 0.5...6 bar	18 mm	560758	VABF-S4-2-R1C2-C-6E
	ZCY	For port 2, 2...10 bar	18 mm	560763	VABF-S4-2-R2C2-C-10E
	ZHY	For port 2, 2...6 bar	18 mm	560765	VABF-S4-2-R2C2-C-6E
	ZDY	For ports 2 and 4, 2...10 bar	18 mm	560767	VABF-S4-2-R4C2-C-10E
	ZIY	For ports 2 and 4, 2...6 bar	18 mm	560769	VABF-S4-2-R4C2-C-6E
	ZEY	For ports 2 and 4, reversible, 0.5...10 bar	18 mm	560771	VABF-S4-2-R5C2-C-10E
	ZJY	For ports 2 and 4, reversible, 0.5...6 bar	18 mm	560773	VABF-S4-2-R5C2-C-6E
	ZLY	For port 2, reversible, 0.5...10 bar	18 mm	560775	VABF-S4-2-R6C2-C-10E
	ZNY	For port 2, reversible, 0.5...6 bar	18 mm	560777	VABF-S4-2-R6C2-C-6E
Regulator plate for valves with symmetrical coil layout, width 26 mm					
	ZAY	For port 1, 0.5...10 bar	26 mm	560757	VABF-S4-1-R1C2-C-10E
	ZFY	For port 1, 0.5...6 bar	26 mm	549876	VABF-S4-1-R1C2-C-6E
	ZCY	For port 2, 2...10 bar	26 mm	560764	VABF-S4-1-R2C2-C-10E
	ZHY	For port 2, 2...6 bar	26 mm	560766	VABF-S4-1-R2C2-C-6E
	ZDY	For ports 2 and 4, 2...10 bar	26 mm	560768	VABF-S4-1-R4C2-C-10E
	ZIY	For ports 2 and 4, 2...6 bar	26 mm	560770	VABF-S4-1-R4C2-C-6E
	ZEY	For ports 2 and 4, reversible, 0.5...10 bar	26 mm	560772	VABF-S4-1-R5C2-C-10E
	ZJY	For ports 2 and 4, reversible, 0.5...6 bar	26 mm	560774	VABF-S4-1-R5C2-C-6E
	ZLY	For port 2, reversible, 0.5...10 bar	26 mm	560776	VABF-S4-1-R6C2-C-10E
	ZNY	For port 2, reversible, 0.5...6 bar	26 mm	560778	VABF-S4-1-R6C2-C-6E
Regulator plate for valves with symmetrical coil layout, width 42 mm ¹⁾					
	ZAY	For port 1, 0.5...10 bar	42 mm	–	VABF-S2-1-R1C2-C-10E
	ZFY	For port 1, 0.5...6 bar	42 mm	–	VABF-S2-1-R1C2-C-6E
	ZCY	For port 2, 0.5...10 bar	42 mm	–	VABF-S2-1-R2C2-C-10E
	ZHY	For port 2, 0.5...6 bar	42 mm	–	VABF-S2-1-R2C2-C-6E
	ZBY	For port 4, 0.5...10 bar	42 mm	–	VABF-S2-1-R3C2-C-10E
	ZGY	For port 4, 0.5...6 bar	42 mm	–	VABF-S2-1-R3C2-C-6E
	ZDY	For ports 2 and 4, 0.5...10 bar	42 mm	–	VABF-S2-1-R4C2-C-10E
	ZIY	For ports 2 and 4, 0.5...6 bar	42 mm	–	VABF-S2-1-R4C2-C-6E
	ZEY	For ports 2 and 4, reversible, 0.5...10 bar	42 mm	–	VABF-S2-1-R5C2-C-10E
	ZJY	For ports 2 and 4, reversible, 0.5...6 bar	42 mm	–	VABF-S2-1-R5C2-C-6E
	ZLY	For port 2, reversible, 0.5...10 bar	42 mm	–	VABF-S2-1-R6C2-C-10E
	ZNY	For port 2, reversible, 0.5...6 bar	42 mm	–	VABF-S2-1-R6C2-C-6E
	ZKY	For port 4, reversible, 0.5...10 bar	42 mm	–	VABF-S2-1-R7C2-C-10E
	ZMY	For port 4, reversible, 0.5...6 bar	42 mm	–	VABF-S2-1-R7C2-C-6E

1) These functions are available via the pressure regulator configurator VABF-S2 for width 42 mm and 52 mm (ISO 5599-2, ISO 1 and ISO 2) only.

Valve terminals VTSA/VTSA-F, NPT

FESTO

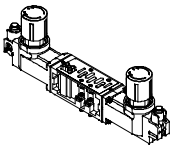
Accessories – Pneumatic components







Ordering data					
	Code	Description	Width	Part No.	Type
Regulator plate for valves with symmetrical coil layout, width 52 mm ¹⁾					
	ZAY	For port 1, 0.5...10 bar	52 mm	–	VABF-S2-2-R1C2-C-10E
	ZFY	For port 1, 0.5...6 bar	52 mm	–	VABF-S2-2-R1C2-C-6E
	ZCY	For port 2, 0.5...10 bar	52 mm	–	VABF-S2-2-R2C2-C-10E
	ZHY	For port 2, 0.5...6 bar	52 mm	–	VABF-S2-2-R2C2-C-6E
	ZBY	For port 4, 0.5...10 bar	52 mm	–	VABF-S2-2-R3C2-C-10E
	ZGY	For port 4, 0.5...6 bar	52 mm	–	VABF-S2-2-R3C2-C-6E
	ZDY	For ports 2 and 4, 0.5...10 bar	52 mm	–	VABF-S2-2-R4C2-C-10E
	ZIY	For ports 2 and 4, 0.5...6 bar	52 mm	–	VABF-S2-2-R4C2-C-6E
	ZEY	For ports 2 and 4, reversible, 0.5...10 bar	52 mm	–	VABF-S2-2-R5C2-C-10E
	ZJY	For ports 2 and 4, reversible, 0.5...6 bar	52 mm	–	VABF-S2-2-R5C2-C-6E
	ZLY	For port 2, reversible, 0.5...10 bar	52 mm	–	VABF-S2-2-R6C2-C-10E
	ZNY	For port 2, reversible, 0.5...6 bar	52 mm	–	VABF-S2-2-R6C2-C-6E
	ZKY	For port 4, reversible, 0.5...10 bar	52 mm	–	VABF-S2-2-R7C2-C-10E
	ZMY	For port 4, reversible, 0.5...6 bar	52 mm	–	VABF-S2-2-R7C2-C-6E
Pressure gauge					
	T	With cartridge connection for regulator, 10 bar, scale bar/psi, display range 0...16 bar/0...240 psi, for regulator plate code ZA, ZB, ZC, ZD, ZE, ZK, ZL	18 mm	543487	PAGN-26-16-P10
			26 mm		
			42 mm	548010	PAGN-40-16-P10
			52 mm		
	U	With cartridge connection for regulator, 6 bar, scale bar/psi, display range 0...10 bar/0...145 psi, for regulator plate code ZF, ZG, ZH, ZI, ZJ, ZM, ZN	18 mm	543488	PAGN-26-10-P10
			26 mm		
			42 mm	548009	PAGN-40-10-P10
			52 mm		
	WT	With cartridge connection for regulator, 10 bar, scale MPa, display range 0...16 bar/0...1.6 MPa, for regulator plate code ZA, ZB, ZC, ZD, ZE, ZK, ZL	18 mm	563735	PAGN-26-1.6M-P10
			26 mm		
			42 mm	563737	PAGN-40-1.6M-P10
			52 mm		
	WU	With cartridge connection for regulator, 6 bar, scale MPa, display range 0...16 bar/0...1 MPa, for regulator plate code ZF, ZG, ZH, ZI, ZJ, ZM, ZN	18 mm	563736	PAGN-26-1M-P10
			26 mm		
42 mm			563738	PAGN-40-1M-P10	
52 mm					
VT	With cartridge connection for regulator, 10 bar, scale psi/bar, display range 0...16 bar/0...232 psi, for regulator plate code ZA, ZB, ZC, ZD, ZE, ZK, ZL	18 mm	563731	PAGN-26-232P-P10	
		26 mm			
		42 mm	563733	PAGN-40-232P-P10	
		52 mm			
VU	With cartridge connection for regulator, 6 bar, scale psi/bar, display range 0...10 bar/0...145 psi, for regulator plate code ZF, ZG, ZH, ZI, ZJ, ZM, ZN	18 mm	563732	PAGN-26-145P-P10	
		26 mm			
		42 mm	563734	PAGN-40-145P-P10	
		52 mm			

1) These functions are available via the pressure regulator configurator VABF-S2 for width 42 mm and 52 mm (ISO 5599-2, ISO 1 and ISO 2) only.

Valve terminals VTSA/VTSA-F, NPT

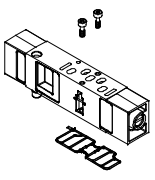
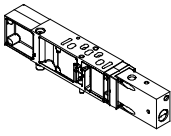
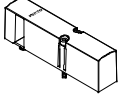
FESTO



Accessories – Pneumatic components

Ordering data					
	Code	Description	Part No.	Type	
Cartridge for regulator plate					
	-	For tubing O.D. 4 mm	1 piece	172972	QSP10-4
	-	Adapter for pressure gauge (allows products with threaded connection G1/8 to be attached to the cartridge connection)	6 pieces	565811	QSP10-G1/8
Flow control plate					
	X	Controls the flow of exhaust air downstream of the valve to ducts 3 and 5	18 mm	540176	VABF-S4-2-F1B1-C
			26 mm	540175	VABF-S4-1-F1B1-C
			42 mm	546095	VABF-S2-1-F1B1-C
			52 mm	555789	VABF-S2-2-F1B1-C
Vertical pressure shut-off plate					
	ZT	2/2-way solenoid valve for shutting off the operating pressure at the valve position Pressure separation can be shut off on the assembled valve	18 mm	542884	VABF-S4-2-L1D1-C
			26 mm	542885	VABF-S4-1-L1D1-C
			42 mm	546096	VABF-S2-1-L1D1-C
			52 mm	555791	VABF-S2-2-L1D1-C
	ZS	3/2-way solenoid valve for shutting off the operating pressure at the valve position Pressure separation can be shut off on the assembled valve using a key	18 mm	8001178	VABF-S4-2-L1D2-C
			26 mm	8001179	VABF-S4-1-L1D2-C
Cover					
	L	Blanking plate for vacant position	18 mm	539213	VABB-S4-2-WT
			26 mm	539212	VABB-S4-1-WT
			42 mm	543186	VABB-S2-1-WT
			52 mm	560845	VABB-S2-2-WT
	N	Cover cap for manual override, non-detenting	10 pieces	541010	VAMC-S6-CH
	V	Cover cap for manual override, covered	10 pieces	541011	VAMC-S6-CS
	-	End cap for electrical interlinking module (with individual connection), size 18 mm and 26 mm	10 pieces	547713	VABD-S4-E-C
	-	Seal (with individual connection), size 42 mm and 52 mm	2 pieces	571343	VABD-S2-1-S-C

Valve terminals VTSA/VTSA-F, NPT

Accessories – Electrical components

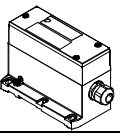

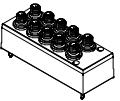
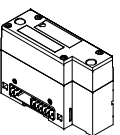
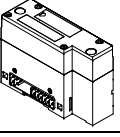
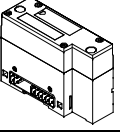
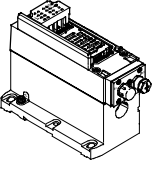
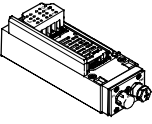
FESTO

Ordering data				
	Code	Description	Part No.	Type
Multi-pin node				
	T	Terminal strip, 36-pin	543412	VABE-S6-1LF-C-M1-C36M
	MP1	Sub-D plug, 37-pin	543414	VABE-S6-1LT-C-M1-S37
	MP4	Round plug, 19-pin	543415	VABE-S6-1LF-C-M1-R19
Individual electrical connection				
	-MP2	Multi-pin node with individual connection M12, 6-way	549046	VABE-S6-LT-C-S6-R5
	-MP3	Multi-pin node with individual connection M12, 10-way	549047	VABE-S6-LT-C-S10-R5
	-	Cover for individual connection M12, 6-way	549048	VAEM-S6-C-S6-R5
	-	Cover for individual connection M12, 10-way	549049	VAEM-S6-C-S10-R5
Pneumatic interface				
	-	For electrical terminal CPX in plastic design	543416	VABA-S6-1-X1
	-	For electrical terminal CPX in metal design	550663	VABA-S6-1-X2
	-	For electrical terminal CPX in metal design, with changed diagnostic function	573613	VABA-S6-1-X2-D
Electrical interface for AS-interface				
	-	4 inputs/4 outputs	549042	VABE-S6-1LF-C-A4-E
	-	8 inputs/8 outputs	549043	VABE-S6-1LF-C-A8-E
AS-interface module				
	-	4 inputs/4 outputs	549044	VAEM-S6-S-FAS-4-4E
	-	8 inputs/8 outputs	549045	VAEM-S6-S-FAS-8-8E

Valve terminals VTSA/VTSA-F, NPT

FESTO

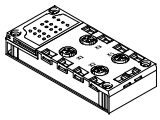

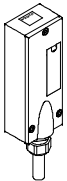
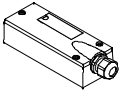

Accessories – Electrical components

Ordering data					
	Code	Description	Part No.	Type	
Manifold block for AS-interface					
	X	4x M12, 5-pin, double, socket	195704	CPX-AB-4-M12x2-5POL	
	GW	4x M12, 5-pin, socket, metal thread	541254	CPX-AB-4-M12x2-5POL-R	
	R	8x M8, 3-pin, socket	195706	CPX-AB-8-M8-3POL	
	J	8x spring-loaded terminal, Cage Clamp®, 4-pin	195708	CPX-AB-8-KL-4POL	
	H	4xHarax®, 4-pin, socket	525636	CPX-AB-4-HAR-4POL	
	B	Sub-D, 25-pin, socket	525676	CPX-AB-1-SUB-BU-25POL	
Connecting cable with Sub-D plug socket (polyurethane, IP65)					
	GA	Connecting cable for max. 8 solenoid coils, 10-pin	2.5 m	539240	NEBV-S1W37-E-2.5-LE10
	GB		5 m	539241	NEBV-S1W37-E-5-LE10
	GC		10 m	539242	NEBV-S1W37-E-10-LE10
	GD	Connecting cable for max. 22 solenoid coils, 26-pin	2.5 m	539243	NEBV-S1W37-E-2.5-LE26
	GE		5 m	539244	NEBV-S1W37-E-5-LE26
	GF		10 m	539245	NEBV-S1W37-E-10-LE26
	GG	Connecting cable for max. 32 solenoid coils, 37-pin	2.5 m	539246	NEBV-S1W37-K-2.5-LE37
	GH		5 m	539247	NEBV-S1W37-K-5-LE37
	GI		10 m	539248	NEBV-S1W37-K-10-LE37
Connecting cable with Sub-D plug socket (polyvinyl chloride, IP65)					
	GK	Connecting cable for max. 8 solenoid coils, 10-pin, cable properties (standard)	2.5 m	543271	NEBV-S1W37-KM-2.5-LE10
	GL		5 m	543272	NEBV-S1W37-KM-5-LE10
	GM		10 m	543273	NEBV-S1W37-KM-10-LE10
	GN	Connecting cable for max. 23 solenoid coils, 27-pin, cable properties (standard)	2.5 m	543274	NEBV-S1W37-KM-2.5-LE27
	GO		5 m	543275	NEBV-S1W37-KM-5-LE27
	GP		10 m	543276	NEBV-S1W37-KM-10-LE27
	GQ	Connecting cable for max. 32 solenoid coils, 37-pin, cable properties (standard)	2.5 m	543277	NEBV-S1W37-KM-2.5-LE37
	GR		5 m	543278	NEBV-S1W37-KM-5-LE37
	GS		10 m	543279	NEBV-S1W37-KM-10-LE37
Cover for multi-pin plug					
	-	For user configuration	545974	NECV-S1W37	

Valve terminals VTSA/VTSA-F, NPT

Accessories – General

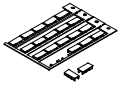
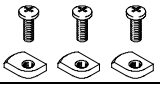
FESTO

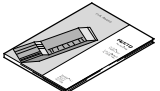



Ordering data					
	Code	Description	Part No.	Type	
Inscription label holder/inscription labels					
	B	Clip-on inscription label holder for valve cap	5 pieces	540888	ASCF-T-S6
	T	Inscription label holder for manifold blocks	5 pieces	540889	ASCF-M-S6
	TD	Inscription label holder for manifold blocks, size 52 mm	5 pieces	562577	ASCF-M-S2-2
	–	Inscription label (20 labels in frames)	20 pieces	18182	IBS-9x20
	–	Inscription label for pressure zone separation <ul style="list-style-type: none"> • 4 inscription labels, duct 1/3/5 separated • 4 inscription labels, duct 1 separated • 4 inscription labels, duct 3/5 separated 	3x4 pieces	8003303	ASLR-L-S6-2016
H-rail mounting					
	–	VTSA/VTSA-F	3 pieces	526032	CPX-CPA-BG-NRH
Wall mounting					
	U	Mounting bracket	5 pieces	539214	VAME-S6-10-W
	–		1 piece	567038	VAME-S6-W-M46
Manual					
	D	Manual for valve terminal VTSA/VTSA-F	German	538922	P.BE-VTSA-44-DE
	E		English	538923	P.BE-VTSA-44-EN
	S		Spanish	538924	P.BE-VTSA-44-ES
	F		French	538925	P.BE-VTSA-44-FR
	I		Italian	538926	P.BE-VTSA-44-IT
	V		Swedish	538927	P.BE-VTSA-44-SV
Pneumatic connection accessories					
<p>A selection of possible fittings, blanking plugs, silencers and other pneumatic accessories can be found in the chapter Accessories → page 153 or on the Internet via the individual search terms:</p> <p>Internet → connection technology, silencer, blanking plug</p>					

Valve terminals VTSA/VTSA-F, NPT

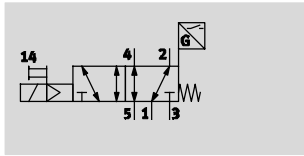
Technical data – Solenoid valve with switching position sensing

Function¹⁾



-  - Flow rate
Up to 1,100 l/min
-  - Valve width
18 mm
26 mm
-  - Voltage
24 V DC
-  - Operating pressure
3 ... 10 bar

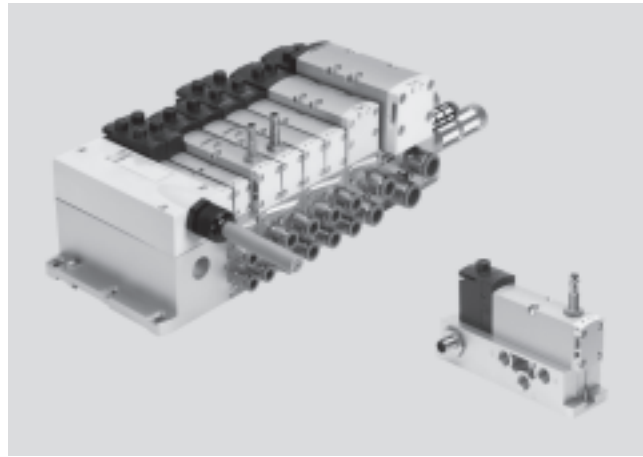

ISO valves with switching position sensing for safety-oriented pneumatic components

Function

The single solenoid 5/2-way valve with spring return in width 18 mm and 26 mm features valve diagnostics. Designed as a plug-in or individual connection valve with pilot valves to ISO 15218 and square plug type C. The normal position of the piston spool valve is monitored by the

inductive sensor. This valve is not a safety component in accordance with the Machinery Directive 2006/42/EC. When used in higher categories, the sensor signal from the valve must be evaluated by the control system.

This valve is suitable for use in safety-related parts of control systems to EN ISO 13849-1. The control block has been developed and manufactured in accordance with the basic and proven safety principles of

EN ISO 13849-2. This valve is designed for installation in machines and automation systems and must only be used in industrial applications (high-demand mode).

Decentralised individual connection variant

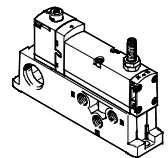

Valve on individual sub-base (square plug or plug-in), with integrated piston position sensing.

The electrical connection is established either via a standardised 4-pin M12 plug 24 V DC (ISO 15407-2), a 4-pin spring-loaded terminal or a cable (open end) 24 V DC/110 V AC,

which are configured by the user. The individual sub-base can be supplied with internal or external pilot air depending on the version.

Variant for valve terminal VTSA/VTSA-F

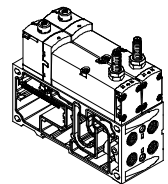

The valves with integrated piston position sensing in plug-in design for valve terminal VTSA/VTSA-F can be used regardless of the type of electrical actuation (individual, multi-pin plug or fieldbus/control block connection).

Pilot air supply:
The valve terminal can be supplied with internal or external pilot air via the various end plate variants.

-  - Note
Valves in plug-in design always get their pilot air from duct 14 in the manifold sub-base.

1) The circuit symbol represents a valve with a proximity sensor with switching output signal with an N/O contact. In accordance with ISO 1219-1, this symbol applies to both N/O contacts as well as N/C contacts. The switching element function of the sensors used here is designed as an N/C contact.

-  - Note
Pilot exhaust air port 12 vents directly at the valve, without a connection.
If the customer requests a "turned seal", exhaust air is vented at the end plates of the valve terminal, which does not conform to the ISO standard.

Valve terminals VTSA/VTSA-F, NPT

Technical data – Solenoid valve with switching position sensing

FESTO

General technical data			
Valve	VSVA-B-M52-MZD-A2-1T1L-...	VSVA-B-M52-MZD-A1-1T1L-...	VSVA-B-M52-MZ-A1-1C1-...
Width	18 mm	26 mm	26 mm
Conforms to	ISO 15407-2		ISO 15407-1
Design	Piston spool valve		
Sealing principle	Soft		
Actuation type	Electric		
Type of control	Piloted		
Exhaust function, with flow control	Via individual sub-base, via flow control plate		
Lubrication	Lubricated for life		
Type of mounting	Via through-hole, on manifold sub-base		
Mounting position	Any		
Manual override	Covered		
Individual sub-base			→144
Valve terminal			→59

Standard nominal flow rate [l/min]			
Valve	VSVA-B-M52-MZD-A2-1T1L-...	VSVA-B-M52-MZD-A1-1T1L-...	VSVA-B-M52-MZ-A1-1C1-...
Width	18 mm	26 mm	26 mm
Flow rate of valve on individual sub-base	600	1,200	1,100
Flow rate of valve on valve terminal VTSA	550	1,100	1,100
Flow rate of valve on valve terminal VTSA-F	700	1,350	–

Operating and environmental conditions	
Operating medium	Compressed air to ISO 8573-1:2010 [7:4:4]
Note about the operating/pilot medium	Lubricated operation possible (required during subsequent operation)
Operating pressure [bar]	-0.9 ... 10
Operating pressure for valve terminal with internal pilot air supply [bar]	3 ... 10
Pilot pressure [bar]	3 ... 10
Ambient temperature [°C]	-5 ... +50
Temperature of medium [°C]	-5 ... +50
Storage temperature [°C]	-20 ... +40 (for long-term storage)
Note on materials	Contains PWIS (paint-wetting impairment substances), RoHS-compliant
Noise level LpA [dB(A)]	85
CE marking (see declaration of conformity)	To EU EMC Directive ¹⁾
Fire protection classification to UL 94	HB
Certification	UL - Recognized (OL), only Part Nos.: 560723, 560724, 560742, 560743, 570850, 573201, 573202, 573203
	C-Tick
	CSA (OL), only Part Nos.: 560723, 560724, 560742, 560743, 570850, 573201, 573202, 573203

1) For information about the applicability of the component see the manufacturer's EC declaration of conformity at: www.festo.com → Support → User documentation.
If the component is subject to restrictions on usage in residential, office or commercial environments or small businesses, further measures to reduce the emitted interference may be necessary.

Valve terminals VTSA/VTSA-F, NPT

Technical data – Solenoid valve with switching position sensing

Valve switching times [ms]				
Valve		VSVA-B-M52-MZD-A2-1T1L-...	VSVA-B-M52-MZD-A1-1T1L-...	VSVA-B-M52-MZ-A1-1C1-...
Width		18 mm	26 mm	26 mm
Valve switching times	On	12	20	21
	Off	38	54	41
Sensor switching times	On	32	60	60
	Off	9	11	11

Electrical data – Valve				
Valve		VSVA-B-M52-MZD-A2-1T1L-...	VSVA-B-M52-MZD-A1-1T1L-...	VSVA-B-M52-MZ-A1-1C1-...
Width		18 mm	26 mm	26 mm
Electrical connection		4-pin plug to ISO 15407-2		Plug to EN 175301-803, type C, without protective earth conductor
Nominal operating voltage	[V DC]	24		
Permissible voltage fluctuations	[%]	±10		-15/+10
Surge resistance	[kV]	2.5		
Degree of contamination		3		
Power consumption	[W]	1.6 W		1.8 W
Piston position sensing		Normal position via sensor		
Duty cycle	[%]	100		
Max. positive test pulse with 0 signal	[µs]	800		
Max. negative test pulse with 1 signal	[µs]	800		
Protection class to EN 60529		IP65, NEMA 4 (for all types of signal transmission in assembled state)		

Electrical data – Sensor	
Electrical connection	Cable, 3-wire
	Plug M8x1, 3-pin
Cable length	[m] 2.5
Switching output	PNP or NPN
Switching element function	N/C contact
Switching status display	Yellow LED
Operating voltage range	[V DC] 10 ... 30
Residual ripple	[%] ±10
Sensor idle current	[mA] ≤10
Max. output current	[mA] 200
Voltage drop	[V] ≤2
Max. switching frequency	[Hz] 5,000
Protection against short circuit	Pulsed
Protection against polarity reversal for sensor	For all electrical connections
Measuring principle	Inductive
Piston position sensing	Valve normal position via sensor

Valve terminals VTSA/VTSA-F, NPT

Technical data – Solenoid valve with switching position sensing

Materials	
Sub-base/manifold sub-base	Die-cast aluminium
Valve	Die-cast aluminium, reinforced polyamide
Seals	Nitrile rubber, elastomer (support made of steel)
Screws	Galvanised steel
Sensor housing	High-alloy stainless steel
Sensor cable sheath	Polyurethane (PUR)

Product weight		
Width	18 mm	26 mm
5/2-way solenoid valve type		
VSVA-B-M52-MZD-A2-1T1L-APX-0.5	157 g	–
VSVA-B-M52-MZD-A2-1T1L-APP	140 g	–
VSVA-B-M52-MZD-A2-1T1L-ANP	140 g	–
VSVA-B-M52-MZD-A1-1T1L-APC	–	307 g
VSVA-B-M52-MZD-A1-1T1L-APP	–	264 g
VSVA-B-M52-MZ-A1-1C1-APC	–	332 g
VSVA-B-M52-MZ-A1-1C1-APP	–	289 g
VSVA-B-M52-MZD-A1-1T1L-ANC	–	307 g
VSVA-B-M52-MZD-A1-1T1L-ANP	–	264 g
VSVA-B-M52-MZ-A1-1C1-ANC	–	332 g
VSVA-B-M52-MZ-A1-1C1-ANP	–	289 g
VSVA-B-M52-MZD-A1-1T1L-APX-0,5	–	281 g
Individual connection		
Individual sub-base	–	302 g

Valve terminals VTSA/VTSA-F, NPT

Ordering data – Solenoid valve with switching position sensing

Ordering data					
	Code	Valve function	Width	Part No.	Type
Solenoid valves, 24 V DC, plug-in design for valve terminal VTSA/VTSA-F					
	-	5/2-way valve, single solenoid, mechanical spring return, with switching position sensing via inductive sensor with PNP output and cable, 3-wire, 2.5 m	26 mm	560723	VSVA-B-M52-MZD-A1-1T1L-APC
	-	5/2-way valve, single solenoid, mechanical spring return, with switching position sensing via inductive sensor with NPN output and cable, 3-wire, 2.5 m	26 mm	560742	VSVA-B-M52-MZD-A1-1T1L-ANC
	SS	5/2-way valve, single solenoid, mechanical spring return, with switching position sensing via inductive sensor with PNP output with 0.5 m connecting cable and 4-pin sensor push-in connector M12x1	26 mm	570850	VSVA-B-M52-MZD-A1-1T1L-APX-0,5
			18 mm	573201	VSVA-B-M52-MZD-A2-1T1L-APX-0,5
	SO	5/2-way valve, single solenoid, mechanical spring return, with switching position sensing via inductive sensor with PNP output and 3-pin sensor push-in connector M8x1	18 mm	573202	VSVA-B-M52-MZD-A2-1T1L-APP
			26 mm	560724	VSVA-B-M52-MZD-A1-1T1L-APP
	SQ	5/2-way valve, single solenoid, mechanical spring return, with switching position sensing via inductive sensor with NPN output and 3-pin sensor push-in connector M8x1	18 mm	573203	VSVA-B-M52-MZD-A2-1T1L-ANP
			26 mm	560743	VSVA-B-M52-MZD-A1-1T1L-ANP
Solenoid valves, 24 V DC, with pneumatic interface to ISO 15218 for individual sub-base					
	-	5/2-way valve, single solenoid, mechanical spring return, with switching position sensing via inductive sensor with PNP output and cable, 3-wire	26 mm	560725	VSVA-B-M52-MZ-A1-1C1-APC
	-	5/2-way valve, single solenoid, mechanical spring return, with switching position sensing via inductive sensor with NPN output and cable, 3-wire	26 mm	560744	VSVA-B-M52-MZ-A1-1C1-ANC
	-	5/2-way valve, single solenoid, mechanical spring return, with switching position sensing via inductive sensor with PNP output and 3-pin sensor push-in connector M8x1	26 mm	560726	VSVA-B-M52-MZ-A1-1C1-APP
	-	5/2-way valve, single solenoid, mechanical spring return, with switching position sensing via inductive sensor with NPN output and 3-pin sensor push-in connector M8x1	26 mm	560745	VSVA-B-M52-MZ-A1-1C1-ANP



Note

- The sensors contained in the valves must not be replaced. Incorrect assembly can result in malfunctions or damage to the valve. Return the module to Festo for maintenance in the event of a fault.
- Valves with switching position sensing from the VSVA-B-M52-... series can only be ordered individually. If these are used on a valve terminal, appropriate vacant positions must be provided for them. Exceptions are the two valves with ident. code SO and SQ.

Valve terminals VTSA/VTSA-F, NPT



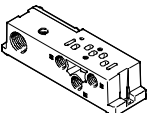

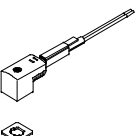
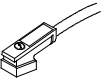
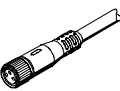
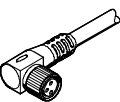
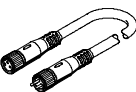
Accessories – Solenoid valve with switching position sensing

FESTO

Ordering data						
	Code	Description		Part No.	Type	
Individual sub-base, port pattern to ISO 15407-2, electrical connection via cable terminals						
	-	Threaded connection, internal pilot air supply, lateral connections	1/8" NPT	18 mm	541068	VABS-S4-2S-N18-B-K2
			1/4" NPT	26 mm	541066	VABS-S4-1S-N14-B-K2
	-	Threaded connection, external pilot air supply, lateral connections	1/8" NPT	18 mm	539724	VABS-S4-2S-N18-K2
			1/4" NPT	26 mm	539726	VABS-S4-1S-N14-K2
Plug socket for electrical connection of individual valves, type C						
	-	<ul style="list-style-type: none"> Angled socket, type C, 3-pin Straight plug, PG7 230 V AC 			151687	MSSD-EB
			<ul style="list-style-type: none"> Angled socket, type C, 3-pin Straight plug, M12x1 			
Illuminating seal for plug pattern EN 175301-803, type C Technical data → Internet: meb-ld						
	-	For plug socket MSSD, 12 ... 24 V DC			151717	MEB-LD-12-24DC
Connecting cable for electrical connection of individual valves, type C						
	GG	<ul style="list-style-type: none"> Angled socket, type C, 3-pin, with LED Open end, 3-wire 24 V DC, PVC 	2.5 m		151688	KMEB-1-24-2,5-LED
	GH		5 m		151689	KMEB-1-24-5-LED
	GJ		10 m		193457	KMEB-1-24-10-LED
	-	<ul style="list-style-type: none"> Angled socket, type C, 4-pin, with LED Open end, 3-wire 24 V DC, polyurethane (PUR) 	2.5 m		174844	KMEB-2-24-2,5-LED
			5 m		174845	KMEB-2-24-5-LED
Connecting cable for electrical connection of sensors for switching position sensing						
	GM	<ul style="list-style-type: none"> Straight socket, M8x1, 3-pin Open end, 3-wire 	2.5 m		541333	NEBU-M8G3-K-2,5-LE3
	GN		5 m		541334	NEBU-M8G3-K-5-LE3
	GO	<ul style="list-style-type: none"> Angled socket, M8x1, 3-pin Open end, 3-wire 	2.5 m		541338	NEBU-M8W3-K-2,5-LE3
	GP		5 m		541341	NEBU-M8W3-K-5-LE3
	-		2.5 m		8001660	NEBU-M8R3-K-2.5-LE3
	-		5 m		8001661	NEBU-M8R3-K-5-LE3
	GQ	<ul style="list-style-type: none"> Straight socket, M8x1, 3-pin Straight plug, M8x1, 4-pin 	2.5 m		554037	NEBU-M8G3-K-2,5-M8G4
	-				-	NEBU-... → Internet: nebu
Pneumatic connection accessories						
A selection of possible fittings, blanking plugs, silencers and other pneumatic accessories can be found in the chapter Accessories → page 153 or on the Internet via the individual search terms: Internet → connection technology, silencer, blanking plug						

Valve terminals VTSA/VTSA-F, NPT

Technical data – Control block with safety function

-  - Flow rate on valve terminal: 830 l/min
-  - Solenoid valve width 26 mm
-  - Voltage 24 V DC
-  - Operating pressure 3 ... 10 bar

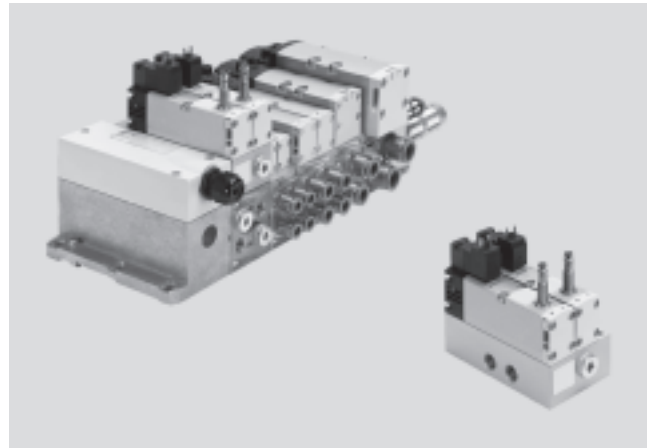

Description

The control block is designed for two-channel actuation of pneumatic drive components such as double-acting linear cylinders, for example, and can be used to realise the following protective measures:

- Protection against unexpected start-up (EN 1037)
- Reversing hazardous movements, provided the reversing motion will not result in further hazards

The control attributes of the control block enable Performance Level e to be achieved for the safety measures. The control block has been developed and manufactured in accordance with the basic and proven safety principles of EN ISO 13849-1 and EN ISO 13849-2.

The requirements of EN ISO 13849-1 and EN ISO 13849-2 (e.g. CCF, DC) must be taken into consideration for implementation and operation of the component and for use in higher categories (2 to 4). When using this product in machines or systems subject to specific C standards, the requirements specified in these standards must be observed.

The control block with safety function is designed for installation in machines and automation systems and must only be used in industrial applications (high-demand mode). The control block with safety function is suitable for use as a press safety valve to EN 962.

More information and technical data
 → Internet: manual

Version for valve terminal VTSA/VTSA-F

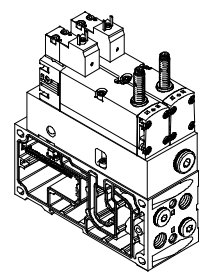

The valves with integrated piston position sensing on manifold sub-base for valve terminal VTSA/VTSA-F can be used regardless of the type of electrical actuation (individual, multi-pin plug or fieldbus/control block connection).

The electrical connection for the solenoid valves is established separately via a standardised square plug to EN 175301-803, type C. The piston position sensing feature of

the inductive PNP or NPN proximity sensor is realised using a push-in connector in the size M8x1 to EN 61076-2-104.

- - Note

The control block with safety function (VOFA) is also available as a decentralised individual connection variant with electrical and pneumatic

individual connection. For information see:
 → Internet: vofa

Valve terminals VTSA/VTSA-F, NPT

Technical data – Control block with safety function

Pneumatic/electrical interlinking

Function

The safety function is achieved through two-channel pneumatic interlinking of two single solenoid 5/2-way valves within the control block: port (4) is only fed with compressed air if both solenoid valves are switched to switching position (14).

Port (2) is always fed with compressed air if at least one of the two solenoid

valves is in normal position. The valve is reset via a mechanical spring.

The switching operation of the solenoid valves can be monitored by sensing via the proximity sensors at the solenoid valves (switching position sensing).

This is done by linking the control

signal and signal change of the proximity sensor so that it is possible to check whether the piston spoils of the solenoid valves are reaching or leaving the normal position (expectations).

The piston spoils of the solenoid valves are designed so that pneumatic

short circuits between ports (2) and (4) are ruled out (freedom from overlap).

The two solenoid valves must be actuated via two separate channels to achieve the desired category 4 (performance level e, to EN ISO 13849-1).

Circuit symbol¹⁾

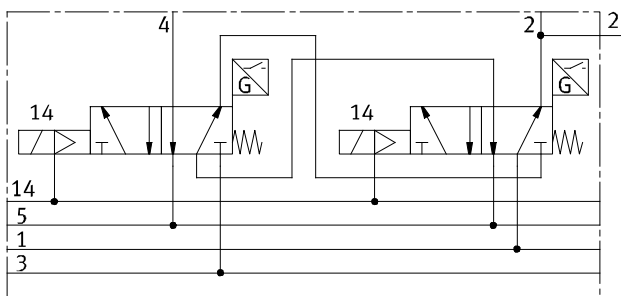

For the control block with safety function VOFA-B26-T52-... for the valve terminal, there is two-channel pneumatic interlinking of two 5/2-way solenoid

valves, width 26 mm, with the intermediate plate as vertical stacking (output 2 is switched in parallel, output 4 is switched in series).

1) The circuit symbol represents a valve with a proximity sensor with switching output signal with an N/O contact. In accordance with ISO 1219-1, this symbol applies to both N/O contacts as well as N/C contacts. The switching element function of the sensors used here is designed as an N/C contact.

Safety characteristics

Conforms to standard	EN 13849-1
Safety function	Protection against manipulation, prevention of unexpected start-up
	Reversing a movement
Performance level (PL)	Protection against manipulation, prevention of unexpected start-up (up to category 4, performance level e)
	Reversing a movement/to category 4, performance level e
Proven component	Yes
Note on forced checking procedure	Switching frequency min. 1/week
Certificate issuing authority	IFA 1001179
CE marking (see declaration of conformity)	To EU EMC Directive ¹⁾
	To EC Machinery Directive
Max. positive test pulse with 0 signal	1,000 [μs]
Max. negative test pulse with 1 signal	800 [μs]
Shock resistance	Shock test with severity level 2, to EN 60068-2-27
Vibration resistance	Transport application test with severity level 2, to EN 60068-2-6

1) For information about the applicability of the component see the manufacturer's EC declaration of conformity at: www.festo.com → Support → User documentation.
If the component is subject to restrictions on usage in residential, office or commercial environments or small businesses, further measures to reduce the emitted interference may be necessary.

Valve terminals VTSA/VTSA-F, NPT

Technical data – Control block with safety function

General technical data	
Design	Piston spool valve
Standard nominal flow rate [l/min]	830
Reset method	Mechanical spring
Sealing principle	Soft
Exhaust function	With flow control
Actuation type	Electric
Non-overlapping	Yes
Type of control	Piloted
Direction of flow	Non-reversible
Exhaust function	With flow control
Suitability for vacuum	–
Nominal size [mm]	9
Pilot air supply	Via valve terminal
Type of mounting	Via through-hole, on manifold sub-base
Mounting position	Any
Manual override	–
Valve switching status display	Via accessories
Pneumatic connections	
Supply port 1	Via the manifold sub-base of the valve terminal
Exhaust port 3/5	
Working ports 2/4	
Pilot air supply 14	
Pressure gauge	G $\frac{1}{4}$

Operating and environmental conditions	
Operating medium	Compressed air to ISO 8573-1:2010 [7:4:4]
Pilot medium	Compressed air to ISO 8573-1:2010 [7:4:4]
Note about the operating/pilot medium	Lubricated operation possible (required during subsequent operation)
Operating pressure [bar]	0 ... 10
Operating pressure for valve terminal with internal pilot air supply [bar]	3 ... 10
Pilot pressure [bar]	3 ... 10
Noise level LpA [dB(A)]	85
Ambient temperature [°C]	–5 ... +50
Temperature of medium [°C]	–5 ... +50
Corrosion resistance class CRC	0
CE marking (see declaration of conformity)	To EU EMC Directive ¹⁾ To EC Machinery Directive
Fire protection classification to UL 94	HB

1) For information about the applicability of the component see the manufacturer's EC declaration of conformity at: www.festo.com → Support → User documentation.
If the component is subject to restrictions on usage in residential, office or commercial environments or small businesses, further measures to reduce the emitted interference may be necessary.

Valve terminals VTSA/VTSA-F, NPT

Technical data – Control block with safety function

FESTO

Electrical data – Control block		
Electrical connection		Plug to EN 175301-803, type C, without protective earth conductor
Nominal operating voltage	[V DC]	24
Permissible voltage fluctuations	[%]	-15/+10
Surge resistance	[kV]	2.5
Degree of contamination		3
Power consumption	[W]	1.8
Max. magnetic disruption field	[mT]	60
Piston position sensing		Normal position via sensor
Duty cycle	[%]	100
Protection class to EN 60529		IP65, NEMA 4 (for all types of signal transmission in assembled state)
Protection against direct and indirect contact		PELV (Protective Extra-Low Voltage) Protected to EN 60950/IEC 950
Valve switching time	On [ms]	22
	Off [ms]	59
Valve sensor switching time ¹⁾	On [ms]	60
	Off [ms]	11

- 1) Valve sensor switching time off: period of time from coil being energised to sensor being switched off when using a PNP sensor.
Valve sensor switching time on: period of time from coil being de-energised to 0-L edge at the sensor when using a PNP sensor.



Note

With a duty cycle of 100%, the control block must be de-energised once per week.

Electrical data – Sensor (to EN-60947-5-2)		
Electrical connection		Cable, 3-wire
		Plug M8x1, 3-pin
Cable length	[m]	2.5
Switching output		PNP or NPN
Switching element function		N/C contact
Switching status display		Yellow LED
Operating voltage range	[V DC]	10 ... 30
Residual ripple	[%]	±10
Sensor idle current	[mA]	Max. 10
Max. output current	[mA]	200
Voltage drop	[V]	Max. 2
Max. switching frequency	[Hz]	5,000
Protection against short circuit		Pulsed
Protection against polarity reversal for sensor		For all electrical connections
Measuring principle		Inductive

Materials	
Sub-base/manifold sub-base	Wrought aluminium alloy
Valve	Die-cast aluminium, polyamide
Seals	Nitrile rubber, fluoro elastomer
Screws	Galvanised steel
Sensor housing	High-alloy stainless steel
Sensor cable sheath	Polyurethane (PUR)
Note on materials	Contains PWIS (paint-wetting impairment substances), RoHS-compliant

Valve terminals VTSA/VTSA-F, NPT

Technical data – Control block with safety function

FESTO

Dimensions

Download CAD data → www.festo.com

Version for valve terminal VTSA/VTSA-F

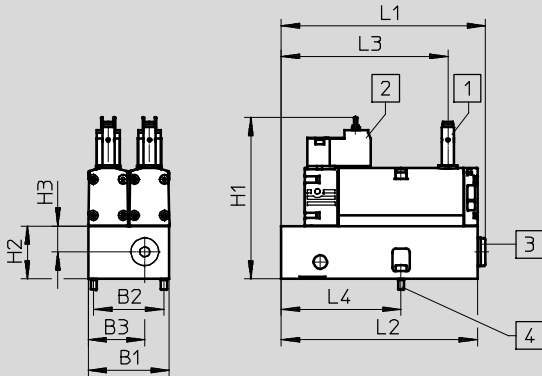

1 Proximity sensor PNP or NPN, size M8x1, plug connection to EN 61076-2-104

2 Electrical connection to EN 175301-803, type C

3 Pneumatic connection G1/4 sealed with blanking plug

4 2x screw with internal hex (2.5 A/F), M4x12 (included in the scope of delivery)

Type	B1	B2	B3	H1	H2	H3	L1	L2	L3	L4
VOFA-B26-T52-M-1C1-APP	53	46	37	105.8	34.6	17	133.7	128.5	109.2	78.5
VOFA-B26-T52-M-1C1-ANP										

Ordering data

	Valve function	Code	Switching output	Width [mm]	Weight [g]	Part No.	Type
Control block, version for valve terminal VTSA/VTSA-F							
	5/2-way valve, single solenoid, mechanical spring return, with switching position sensing via inductive sensor and 3-pin sensor push-in connector M8, mounted on intermediate plate for pneumatic interlinking	SP ²⁾	PNP	53	1,112	- ¹⁾	VOFA-B26-T52-M-1C1-APP
		SN ²⁾	NPN	53	1,112	- ¹⁾	VOFA-B26-T52-M-1C1-ANP

- 1) The control block with safety function can only be ordered via the valve terminal configurator and therefore does not have a separate part number.
 2) Code letter within the order code for a valve terminal configuration.



- - Note

The sensors contained in the valves must not be replaced. Incorrect assembly can result in

malfunctions or damage to the valve. Please contact Festo in the event of a malfunction.

Valve terminals VTSA/VTSA-F, NPT

Accessories – Control block with safety function

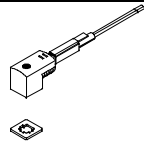
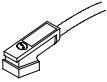
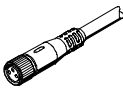
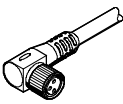
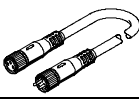
Ordering data				
	Code	Description	Part No.	Type
Plug socket for electrical connection of individual valves, type C				
	-	<ul style="list-style-type: none"> Angled socket, type C, 3-pin Straight plug, PG7 230 V AC 	151687	MSSD-EB
	-	<ul style="list-style-type: none"> Angled socket, type C, 3-pin Straight plug, M12x1 	539712	MSSD-EB-M12
Illuminating seal for plug pattern to EN 175301-803, type C				Technical data → Internet: meb-ld
	-	For plug socket MSSD, 12 ... 24 V DC	151717	MEB-LD-12-24DC
Connecting cable for electrical connection of individual valves, type C				
	GG	<ul style="list-style-type: none"> Angled socket, type C, 3-pin, with LED Open end, 3-wire 	2.5 m	151688 KMEB-1-24-2,5-LED
	GH	<ul style="list-style-type: none"> 24 V DC, PVC 	5 m	151689 KMEB-1-24-5-LED
	GJ		10 m	193457 KMEB-1-24-10-LED
	-	<ul style="list-style-type: none"> Angled socket, type C, 4-pin, with LED Open end, 3-wire 24 V DC, polyurethane (PUR) 	2.5 m	174844 KMEB-2-24-2,5-LED
			5 m	174845 KMEB-2-24-5-LED
Connecting cable for electrical connection of sensors for switching position sensing				
	GM	<ul style="list-style-type: none"> Straight socket, M8x1, 3-pin Open end, 3-wire 	2.5 m	541333 NEBU-M8G3-K-2,5-LE3
	GN	<ul style="list-style-type: none"> Straight socket, M8x1, 3-pin Open end, 3-wire 	5 m	541334 NEBU-M8G3-K-5-LE3
	GO	<ul style="list-style-type: none"> Angled socket, M8x1, 3-pin Open end, 3-wire 	2.5 m	541338 NEBU-M8W3-K-2,5-LE3
	GP	<ul style="list-style-type: none"> Angled socket, M8x1, 3-pin Open end, 3-wire 	5 m	541341 NEBU-M8W3-K-5-LE3
	-	<ul style="list-style-type: none"> Angled socket, rotatable, M8x1, 3-pin Open end, 3-wire 	2.5 m	8001660 NEBU-M8R3-K-2,5-LE3
	-	<ul style="list-style-type: none"> Angled socket, rotatable, M8x1, 3-pin Open end, 3-wire 	5 m	8001661 NEBU-M8R3-K-5-LE3
	GQ	<ul style="list-style-type: none"> Straight socket, M8x1, 3-pin Straight plug, M8x1, 4-pin 	2.5 m	554037 NEBU-M8G3-K-2,5-M8G4
	-	Modular system for connecting cables	-	- NEBU-... → Internet: nebu
Pneumatic connection accessories				
<p>A selection of possible fittings, blanking plugs, silencers and other pneumatic accessories can be found in the chapter Accessories → page or on the Internet via the individual search terms:</p> <p>Internet → connection technology, silencer, blanking plug</p>				

Valve terminals VTSA/VTSA-F, NPT

Technical data – Pilot air switching valve, width 18 mm, 26 mm

Function¹⁾

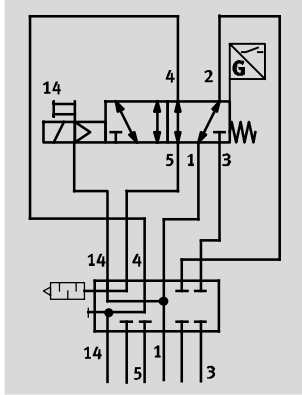

- - Flow rate
150 l/min (18 mm)
450 l/min (26 mm)
- - Valve width
18 mm
26 mm
- - Voltage
24 V DC
- - Operating pressure
-0.9 ... 10 bar

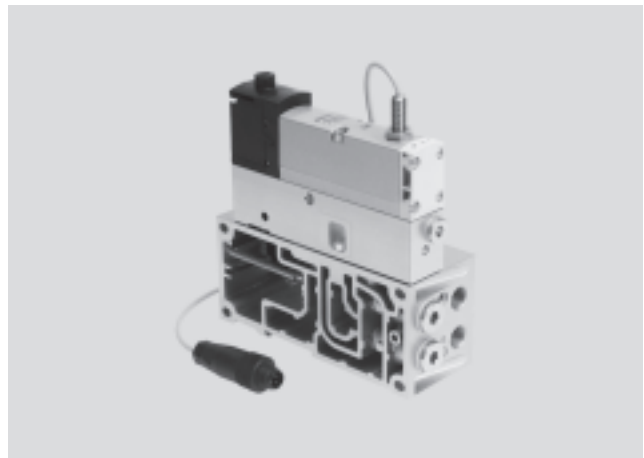

Description

The pilot air switching valve is essentially a combination of a 5/2-way solenoid valve with switching position sensing and the intermediate plate VABF-S4-...-S. It enables verifiable switching on and off (sensor function) of the pilot air supply from duct 1 to 14 for the entire pressure zone or

valve terminal. This valve is not a safety component in accordance with the Machinery Directive 2006/42/EC. When used in higher categories, the sensor signal from the valve must be evaluated by the control system.

This valve is suitable for use in safety-related parts of control systems to EN ISO 13849-1. This valve is designed for installation in machines and automation systems and must

only be used in industrial applications (high-demand mode). More information and technical data
➔ Internet: manual

Alternative switching position sensing with pressure switch

As an alternative to the sensor function in the solenoid valve, a pressure switch can be mounted (instead of the

blanking plug) in the intermediate plate VABF-S4-...-S. This pressure switch enables verifiable switching on

and off (sensor function) of the pilot air supply. An ISO solenoid valve can therefore be mounted on the

intermediate plate without a sensor for the same function.
➔ Internet: spba

- - Note

The pilot air switching valve can only be operated on the valve terminal VTSA/VTSA-F in combination with a right-hand end plate for external

pilot air type VABE-S6-1RZ-... . Port 14 on the right-hand end plate must be sealed for this.

Vertical stacking variant for valve terminal VTSA/VTSA-F, width 18 mm, 26 mm

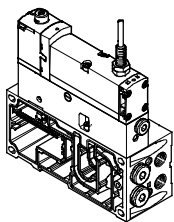

The valves with integrated piston position sensing in plug-in design for valve terminal VTSA/VTSA-F can be used regardless of the type of electrical actuation (individual, multi-pin plug or fieldbus/control block connection).

This module is supplied pre-assembled together with the valve terminal VTSA/VTSA-F. No other assembly steps are required before installation. The piston position sensing feature is realised by means of an inductive PNP proximity sensor with cable and

push-in connector in the size M12x1 to EN 61076-2-104.

Alternatively, combinations with the pressure switch in the intermediate plate and ISO solenoid valves are possible.

- - Note

All VSVA solenoid valves to ISO 15407-1 can be used.

➔ Internet: vsva

1) The circuit symbol represents a valve with a proximity sensor with switching output signal with an N/O contact. In accordance with ISO 1219-1, this symbol applies to both N/O contacts as well as N/C contacts. The switching element function of the sensors used here is designed as an N/C contact.

Valve terminals VTSA/VTSA-F, NPT

Technical data – Pilot air switching valve, width 18 mm, 26 mm

Function – Pneumatic/electrical interlinking

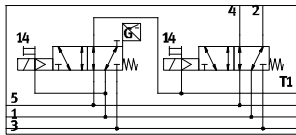

The function for switching off the pilot air is essentially achieved by combining the intermediate plate type VABF-S4-...-S with the single solenoid 5/2-way valve type VSVA-B-M52-MZD-...-1T1L-APX-0,5. The valve terminal is not supplied with any pilot air via the right-hand end plate type VABE-S6-1 (ident. code XS, external pilot air). Port 14 on the end plate is sealed.

The pilot air for the valve is branched from duct (1) in the intermediate plate and redirected to the pilot air duct

(14) of the valve terminal when the valve is in the switching position. Ports (2) and (4) of the manifold sub-base are sealed with blanking plugs. The switching operation of the solenoid valve can be monitored by sensing via the proximity sensor in the solenoid valve (or pressure switch in the intermediate plate VABF...).

This is done by linking the control signal and signal change of the proximity sensor so that it is possible to check whether the piston spools of the

solenoid valves are reaching or leaving the normal position (expectations).

The piston spool of the solenoid valve is designed so that pneumatic short circuits between ports (2) and (4) are ruled out (freedom from overlap).

Alternatively, combinations with the pressure switch in the intermediate plate and ISO solenoid valves are possible.



Note

A valve from the VTSA/VTSA-F modular system can be planned or configured to the right of the valve

with piston position sensing on the intermediate plate of the pilot air switching valve.

Pilot air switching valve with integrated piston position sensing

The pilot air switching valve is a combination of a 5/2-way solenoid valve with switching position sensing and the intermediate plate VABF-S4-...-S.

Alternative switching position sensing with pressure switch

As an alternative to the pilot air switching valve with integrated piston position sensing, a combination of ISO solenoid valve and pressure switch in the intermediate plate is possible.

Various 5/2-way solenoid valves are available in combination with a pressure switch SPBA-... for this purpose.

General technical data		
	Intermediate plate type VABF-S4-2-S and solenoid valve type VSVA-B-M52-MZD-A2-1T1L-APX-0,5 mounted on valve terminal VTSA/VTSA-F	Intermediate plate type VABF-S4-1-S and solenoid valve type VSVA-B-M52-MZD-A1-1T1L-APX-0,5
Width	18 mm	26 mm
Design	Piston spool valve	
Sealing principle	Soft	
Actuation type	Electric	
Type of control	Piloted	
Type of mounting: Solenoid valve on intermediate plate Intermediate plate on manifold sub-base	M3 M3x12 (captive)	M4 M4x12 (captive)
Mounting position	Any	
Pneumatic connections		
Supply port	1	Via the manifold sub-base of the valve terminal
Exhaust port	3/5	Via the manifold sub-base of the valve terminal
Working ports	2/4	Sealed with blanking plug type B-1/4
Pilot air supply	14	Via the manifold sub-base of the valve terminal
Pressure gauge/pressure switch		G $\frac{1}{8}$

Valve terminals VTSA/VTSA-F, NPT

Technical data – Pilot air switching valve, width 18 mm, 26 mm

Operating and environmental conditions	
Operating medium	Compressed air to ISO 8573-1:2010 [7:4:4]
Note about the operating/ pilot medium	Lubricated operation possible (required during subsequent operation)
Operating pressure [bar]	3 ... 10
Noise level LpA [dB(A)]	85
Ambient temperature [°C]	-5 ... +50
Temperature of medium [°C]	-5 ... +50
Fire protection classification to UL94	HB
Note on materials	Contains PWIS (paint-wetting impairment substances), RoHS-compliant
Certification	cULus recognized (OL), only Part Nos.: 560723, 560724, 560742, 560743, 570850, 573201, 573202, 573203
	C-Tick, no Part Nos.: 539159, 539185
	CSA (OL), only Part Nos.: 560723, 560724, 560742, 560743, 570850, 573201, 573202, 573203

Switching times [ms]				
Width	18 mm	26 mm		
Valve type	5/2-way	5/2-way		
Identifier	MZD-A2	MZD-A1	MZ-A1	
Valve switching time	On	12	20	21
	Off	38	54	41
Valve sensor switching time ¹⁾	On	32	60	60
	Off	9	11	11

1) Valve sensor switching time off: period of time from coil being energised to sensor being switched off when using a PNP sensor.
Valve sensor switching time on: period of time from coil being de-energised to 0-L edge at the sensor when using a PNP sensor.

Protective circuit

Each VSVA solenoid coil is protected with a spark arresting protective circuit as well as against polarity reversal.

24 V DC version

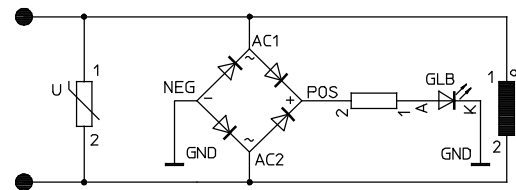

Valve terminals VTSA/VTSA-F, NPT

Technical data – Pilot air switching valve, width 18 mm, 26 mm

Peripherals overview

Pilot air switching valve with piston position sensing

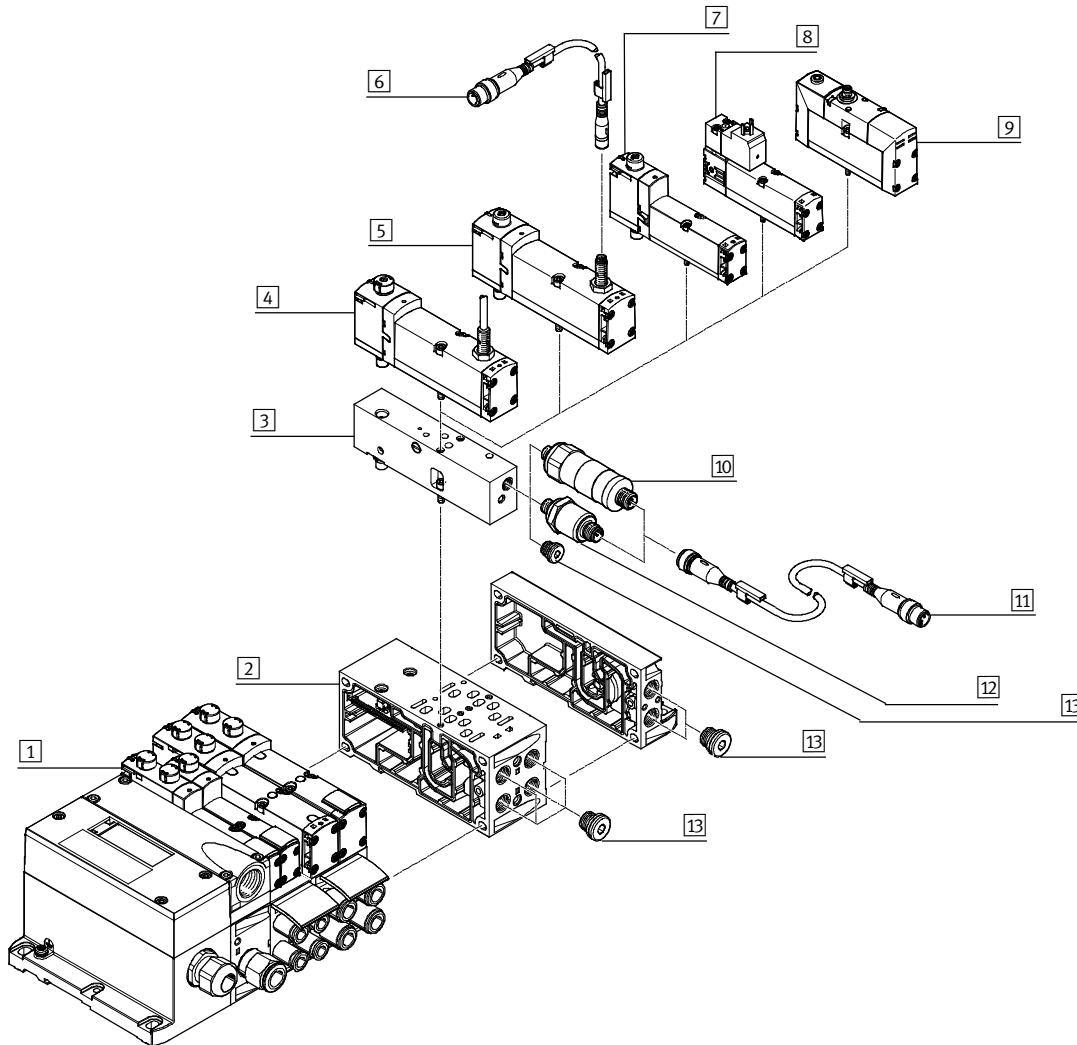

Peripherals overview – Pilot air switching valve			
	Brief description	→ Page/Internet	
1	Valve terminal VTSA/VTSA-F	Valve terminal with multi-pin plug interface	vtsa
2	Manifold sub-base VABF-...	Width 18 mm or 26 mm	116
3	Intermediate plate VABF-S4-...	For pilot air switching valve	116
4	Solenoid valve VSVA-B-M52-...	Width 18 mm or 26 mm, with sensor and integrated cable 0.5 m	116
5	Solenoid valve VSVA-B-M52-...	Width 18 mm or 26 mm, with sensor for external connecting cable	116
6	Connecting cable NEBU-M8 ...	For connection to sensor	117
7	Solenoid valve VSVA-B-M52-...	Width 18 mm or 26 mm ¹⁾	116
8	Solenoid valve VSVA-B-M52-...	Width 18 mm or 26 mm, with plug to EN 175301, type C ¹⁾	116
9	Solenoid valve VSVA-B-M52-...	Width 18 mm or 26 mm, with round plug ¹⁾	vsva
10	Pressure switch SPBA-...	Mechanically actuated	117
11	Connecting cable NEBU-M12G5-...	For connection to pressure switch	117
12	Pressure switch SPBA-...	Solenoid actuated	117
13	Blanking plug	–	153

1) The switching position sensing function is performed with pressure switches when using solenoid valves without integrated sensor. The pressure switch is screwed into the intermediate plate instead of the blanking plug.

Valve terminals VTSA/VTSA-F, NPT

FESTO

Technical data – Pilot air switching valve, width 18 mm, 26 mm

Electrical data – Pilot air switching valve		
Nominal operating voltage	[V DC]	24
Permissible voltage fluctuations	[%]	±10
Surge resistance	[kV]	2.5
Degree of contamination		3
Power consumption	[W]	1.6
Max. magnetic disruption field	[mT]	60
Piston position sensing		Normal position via sensor
Duty cycle	[%]	100
Protection class		IP65, NEMA 4 (for all types of signal transmission in assembled state)

Electrical data – Sensor						
Sensor identifier		APP	ANP	APC	ANC	APX
Switching output		PNP	NPN	PNP	NPN	PNP
Sensor connection		Plug, M8x1, 3-pin		With fixed cable and open end		With fixed cable and plug M12x1, 4-pin
Cable length	[m]	0.5 (with socket M8x1, plug M12x1)		2.5	0.5	
Switching element function		N/C contact				
Switching status display		Yellow LED (on sensor)				
Operating voltage range	[V DC]	10 ... 30				
Residual ripple	[%]	±10				
Rated operating voltage	[V DC]	24				
Max. idle current	[mA]	10				
Max. output current	[mA]	200				
Max. voltage drop	[V]	2				
Max. switching frequency	[Hz]	5,000				
Protection against short circuit		Pulsed				
Reverse polarity protection		For all electrical connections				
Measuring principle		Inductive				
Piston position sensing		Valve normal position via sensor				

Valve terminals VTSA/VTSA-F, NPT

Technical data – Pilot air switching valve, width 18 mm, 26 mm

Materials	
Sub-base/manifold sub-base	Die-cast aluminium
Valve	Die-cast aluminium, reinforced polyamide
Seals	Nitrile rubber, elastomer (support made of steel)
Screws	Galvanised steel
Sensor housing	High-alloy stainless steel
Sensor cable sheath	Polyurethane (PUR)

Product weight		
Width	18 mm	26 mm
5/2-way solenoid valve type...		
VSVA-B-M52-MZD-A1-1T1L-APC	–	307 g
VSVA-B-M52-MZD-A1-1T1L-APP	–	264 g
VSVA-B-M52-MZ-A1-1C1-APC	–	332 g
VSVA-B-M52-MZ-A1-1C1-APP	–	289 g
VSVA-B-M52-MZD-A1-1T1L-ANC	–	307 g
VSVA-B-M52-MZD-A1-1T1L-ANP	–	264 g
VSVA-B-M52-MZ-A1-1C1-ANC	–	332 g
VSVA-B-M52-MZ-A1-1C1-ANP	–	289 g
VSVA-B-M52-MZD-A1-1T1L-APX-0.5	–	281 g
VSVA-B-M52-MZD-A2-1T1L-APX-0.5	157 g	–
VSVA-B-M52-MZD-A2-1T1L-APP	140 g	–
VSVA-B-M52-MZD-A2-1T1L-ANP	140 g	–
VSVA-B-M52-MZD-A1-1T1L	–	293 g
VSVA-B-M52-MZD-A2-1T1L	163 g	–
Intermediate plate		
VABF-S4-2-S	203.5 g	–
VABF-S4-1-S	–	295 g

Valve terminals VTSA/VTSA-F, NPT

FESTO

Ordering data – Pilot air switching valve, width 18 mm, 26 mm

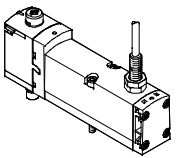
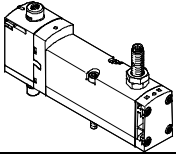
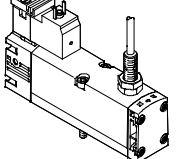
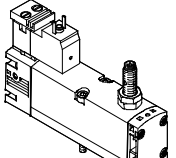
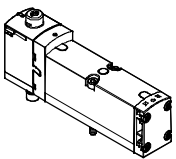
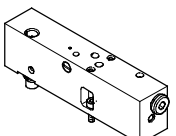
Ordering data						
	Code	Valve function	Part No.	Type		
5/2-way solenoid valve, 24 V DC, plug-in design for valve terminal VTSA/VTSA-F with proximity sensor						
	SS	5/2-way valve, single solenoid, mechanical spring return, with 0.5 m connecting cable and 4-pin sensor push-in connector M12x1	PNP	18 mm	573201	VSVA-B-M52-MZD-A2-1T1L-APX-0,5
				26 mm	570850	VSVA-B-M52-MZD-A1-1T1L-APX-0,5
	-	5/2-way valve, single solenoid, mechanical spring return, with 2.5 m connecting cable	PNP	26 mm	560723	VSVA-B-M52-MZD-A1-1T1L-APC
			NPN	26 mm	560742	VSVA-B-M52-MZD-A1-1T1L-ANC
	-	5/2-way valve, single solenoid, mechanical spring return, with 3-pin sensor push-in connector M8x1	PNP	18 mm	573202	VSVA-B-M52-MZD-A2-1T1L-APP
				26 mm	560724	VSVA-B-M52-MZD-A1-1T1L-APP
	-	5/2-way valve, single solenoid, mechanical spring return, with plug to EN 175301, type C, with 2.5 m connecting cable	PNP	18 mm	573203	VSVA-B-M52-MZD-A2-1T1L-ANP
				26 mm	560743	VSVA-B-M52-MZD-A1-1T1L-ANP
	-	5/2-way valve, single solenoid, mechanical spring return, with plug to EN 175301, type C, with 2.5 m connecting cable	PNP	26 mm	560725	VSVA-B-M52-MZ-A1-1C1-APC
			NPN	26 mm	560745	VSVA-B-M52-MZ-A1-1C1-ANP
	-	5/2-way valve, single solenoid, mechanical spring return, with plug to EN 175301, type C, with 3-pin sensor push-in connector M8x1	PNP	26 mm	560726	VSVA-B-M52-MZ-A1-1C1-APP
			NPN	26 mm	560744	VSVA-B-M52-MZ-A1-1C1-ANC
5/2-way solenoid valve, 24 V DC, plug-in design for valve terminal VTSA/VTSA-F						
	-	5/2-way valve, single solenoid, mechanical spring return		26 mm	539159	VSVA-B-M52-MZD-A1-1T1L
				18 mm	539185	VSVA-B-M52-MZD-A2-1T1L
Intermediate plate for pilot air switching valve for valve terminal VTSA/VTSA-F						
	ZO	Intermediate plate, for switching the pilot air from duct 1 to 14		18 mm	573200	VABF-S4-2-S
				26 mm	570851	VABF-S4-1-S





 Note

The sensors contained in the valves must not be replaced. Incorrect assembly can result in malfunctions or damage to the valve. Please contact Festo in the event of a malfunction.

Valve terminals VTSA/VTSA-F, NPT

Ordering data – Pilot air switching valve, width 18 mm, 26 mm

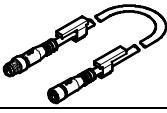
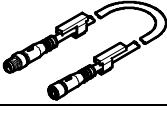
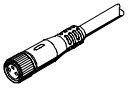
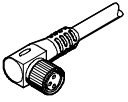
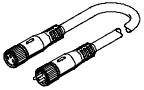
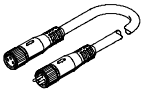
FESTO

Ordering data				
	Code	Description	Part No.	Type
Pressure switch for intermediate plate for pilot air switching valve				
	WL	Mechanical pressure switch for switchable pilot air supply (only in combination with intermediate plate ZO), with plug M12x1, 4-pin	8000033	SPBA-P2R-G18-W-M12-0,25X
	WH	Electrical pressure switch for switchable pilot air supply, switching output 2xPNP (only in combination with intermediate plate ZO), with plug M12x1, 4-pin	8000210	SPBA-P2R-G18-2P-M12-0,25X
Connecting cable for connection of pressure switches				
	–	<ul style="list-style-type: none"> • Straight socket, M12x1, 5-pin • Straight plug, M12x1, 4-pin 	0.5 m	8000208 NEBU-M12G5-K-0.5-M12G4
Connecting cable for electrical connection of sensors for switching position sensing				
	–	<ul style="list-style-type: none"> • Straight socket, M8x1, 3-pin • Straight plug, M12x1, 3-pin 	0.5 m	8000209 NEBU-M8G3-K-0.5-M12G3
	GM	<ul style="list-style-type: none"> • Straight socket, M8x1, 3-pin • Open end, 3-wire 	2.5 m	541333 NEBU-M8G3-K-2,5-LE3
	GN	<ul style="list-style-type: none"> • Straight socket, M8x1, 3-pin • Open end, 3-wire 	5 m	541334 NEBU-M8G3-K-5-LE3
	GO	<ul style="list-style-type: none"> • Angled socket, M8x1, 3-pin • Open end, 3-wire 	2.5 m	541338 NEBU-M8W3-K-2,5-LE3
	GP	<ul style="list-style-type: none"> • Angled socket, M8x1, 3-pin • Open end, 3-wire 	5 m	541341 NEBU-M8W3-K-5-LE3
	–	<ul style="list-style-type: none"> • Angled socket, rotatable, M8x1, 3-pin • Open end, 3-wire 	2.5 m	8001660 NEBU-M8R3-K-2.5-LE3
	–	<ul style="list-style-type: none"> • Angled socket, rotatable, M8x1, 3-pin • Open end, 3-wire 	5 m	8001661 NEBU-M8R3-K-5-LE3
	GQ	<ul style="list-style-type: none"> • Straight socket, M8x1, 3-pin • Straight plug, M8x1, 4-pin 	2.5 m	554037 NEBU-M8G3-K-2,5-M8G4
	–	Modular system for connecting cables	–	NEBU-... → Internet: nebu
Cover				
	–	Cover cap for manual override, non-detenting	10 pieces	541010 VAMC-S6-CH

Valve terminals VTSA/VTSA-F, NPT



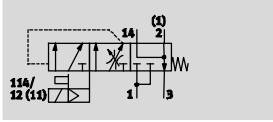

Technical data – Soft-start valve, width 43 mm

Function without sensor

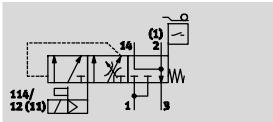

with sensor



-  - Flow rate
Pressurisation: 3,000 l/min
Exhaust: 3,300 l/min
-  - Module width
43 mm
-  - Temperature range
-5 ... +50 °C
-  - Operating pressure
2 ... 12 bar

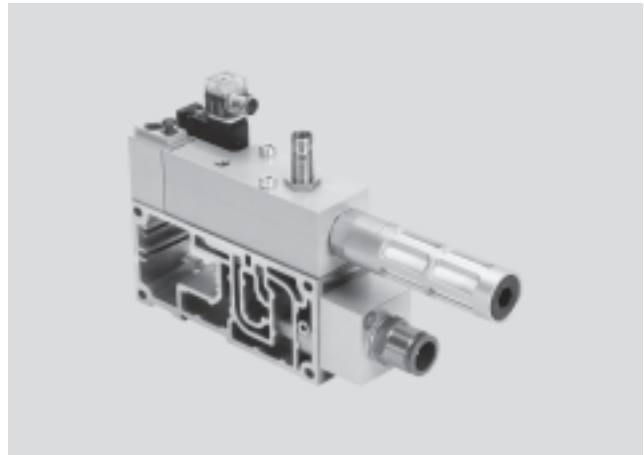

Description

Function

The purpose of the soft-start valve is to slowly and safely build up the supply pressure in duct 1 of the valve terminal or to quickly vent it.

Switch-on takes place in two stages:

- First the working pressure provided for duct 1 gradually increases (the speed can be adjusted using a flow control screw).

- Once the working pressure in duct 1 reaches a previously set value, the soft-start valve switches the full operating pressure at duct 1 of the valve terminal.

The switching point for full operating pressure is set to 4 bar at the factory, but can be changed using an adjusting screw.

The full operating pressure is applied to duct 14 (pilot air) at all times. This pressure causes the valves on the valve terminal to immediately move to the required switching position.

Duct 1 of the valve terminal is exhausted via the soft-start valve's exhaust port only in the normal

position, when the valve is not switched. The exhaust air can optionally be ducted with a QS fitting or using a silencer.

A detenting manual override with self-reset via an electrical control signal is available for maintenance and service purposes.

Note

When using "Protection against unexpected start-up":
Protection against unexpected

activation of the manual override (MO) must be guaranteed in all operating modes.

Diagnostics

The piston position of the soft-start valve can be monitored by a sensor with integrated LED display. This sensor registers whether the valve has

switched and thus whether the valve terminal is being supplied with air. Pressure sensing via a pressure gauge (optional) is also possible.

The soft-start valve can alternatively be ordered with a sensor. Due to the calibration that is required, it is not intended for subsequent retrofitting of

a sensor. Connecting cables with integrated LED display are provided for displaying the signal status.

Pilot air supply

The valve terminal can either be supplied with internal pilot air via the soft-start valve or with internal or external pilot air via the various end

plate variants. The type of pilot air supply is determined by the seal of the soft-start valve.

The scope of delivery of the soft-start valve includes both the seal for internal pilot air supply (with hole)

and the seal for external pilot air supply (without hole).

Creation of pressure zones with a soft-start valve

The soft-start valve can be used for the pneumatic compressed air supply of the valve terminal or of a pressure zone. The soft-start valve may only be used as the single compressed air supply component on valve terminals with a pressure zone or within a

pressure zone. If a soft-start valve in combination with a right-hand end plate (code XP3) is chosen for a pressure zone, a supply plate with a blanking plug in duct 1 (code W) is required in this pressure zone.

When using a soft-start valve, a supply plate (with blanking plug in duct 1) is generally also required for this pressure zone for removal of the exhaust air (duct 3/5).

A supply plate is not required if the exhaust air (duct 3/5) in a pressure zone with soft-start valve can be removed via the right-hand end plate.

Valve terminals VTSA/VTSA-F, NPT

Technical data – Soft-start valve, width 43 mm

Restrictions			
Compressed air supply	Exhaust air	Pilot air supply	Reverse operation
There must be no other elements supplying compressed air in the pressure zone in which the soft-start valve is being operated.	Exhaust air cannot be expelled via the soft-start valve. If it is being operated in a pressure zone with duct 3/5 separated, an exhaust plate is required.	If internal pilot air supply (duct 14) via the soft-start valve is chosen, there must be no other pilot air supply within the valve terminal.	The soft-start valve is not approved for reverse operation.



Note

Setting options as well as drawings with descriptions of the components for the soft-start valve can be found in the manual. The adjusting screws are freely accessible in the built-in state.

General technical data	
Design	Piston spool valve
Actuation type	Electric
Sealing principle	Soft
Type of mounting	On sub-base, ISO size 1 to ISO 5599-2
Mounting position	Any
Valve function	Soft-start function
Manual override	Detenting, self-resetting via electrical control signal, normal position on top
Reset method	Mechanical spring
Type of control	Piloted
Pilot air supply	Internal, external
Direction of flow	Non-reversible
Piston position sensing	Switching position via sensor

Standard nominal flow rate [l/min]	
Pressurisation	3,000
Exhaust	3,300

Operating and environmental conditions		
Type	VABF-S6-1-P5A4-...-1	VABF-S6-1-P5A4-...-2A
Operating medium	Compressed air to ISO 8573-1:2010 [7:4:4]	
Note about the operating/pilot medium	Lubricated operation possible (required during subsequent operation)	
Operating pressure [bar]	2 ... 12	2 ... 10
Switchover pressure [bar] presetting	4	
Ambient temperature [°C]	-5 ... +50	
Note on materials	Conforms to RoHS	
CE marking (see declaration of conformity)	-	To EU Low Voltage Directive

Valve terminals VTSA/VTSA-F, NPT

FESTO

Technical data – Soft-start valve, width 43 mm

Valve switching times [ms]		
Valve switching time	On	17
	Off	50

Electrical data – Soft-start valve		
Type	VABF-S6-1-P5A4-...-1	VABF-S6-1-P5A4-...-2A
Electrical connection	Plug type C to EN 175301-803, square design	
Nominal operating voltage [V]	24 DC	110 AC
Operating voltage range [V]	24 DC $\pm 10\%$	110 AC $\pm 10\%$
Coil characteristics	24 V DC: 2.5 W	
	110/120 V AC: 50/60 Hz, 3.0 VA pull 110/120 V AC: 50/60 Hz, 2.4 VA hold	
Protection class to EN 60529	IP65, NEMA 4 (for all types of signal transmission in assembled state)	

Electrical data – Sensor		
Type	SIEN-M12B-PS-S-L	SIEN-M12B-NS-S-L
Electrical connection	Plug M12x1 to EN 60947-5-2, 4-pin	
Switching output	PNP	NPN
Switching element function	N/O contact	
Switching status display	Yellow LED	
Operating voltage range [V DC]	10 ... 30	
Residual ripple [%]	± 10	
Rated operating voltage [V DC]	24	
Sensor idle current [mA]	10	
Max. output current [mA]	200	
Max. voltage drop [V]	2	
Max. switching frequency [Hz]	3,000	
Protection against short circuit	Pulsed	
Protection against polarity reversal for sensor	For all electrical connections	
Measuring principle	Inductive	
Piston position sensing	Switching position via sensor	

Materials – Soft-start valve	
Housing	Wrought aluminium alloy
Seals	Nitrile rubber
Screws	Galvanised steel

Valve terminals VTSA/VTSA-F, NPT

Technical data – Soft-start valve, width 43 mm

Example 1: Pressure zone with soft-start valve and pilot air supply

Internal, external pilot air supply

Requirements

- Compressed air supply via soft-start valve
- Right-hand end plate¹⁾: blanking plug in duct 1

For internal pilot air supply:

- Seal (soft-start valve - manifold sub-base) with pilot air supply hole "open" and
- Right-hand end plate: blanking plug in duct 14

For external pilot air supply:

- Seal (soft-start valve - manifold sub-base) with pilot air supply hole "closed" and
- Pilot air supply via duct 14 in the right-hand end plate

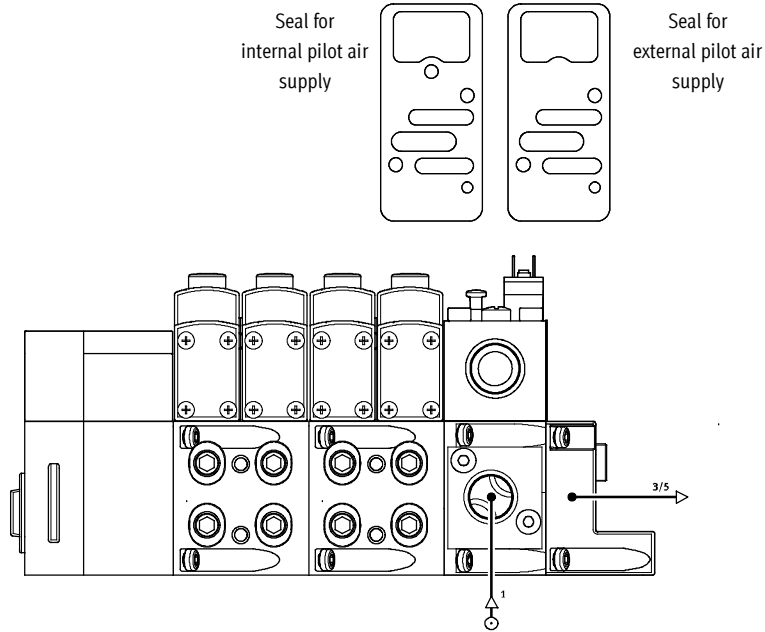

1) With this configuration, a right-hand end plate with pilot air selector is not possible, as it does not allow the removal of exhaust air

Example 2: Pressure zone with soft-start valve, supply plate and pilot air supply

Internal, external pilot air supply

Requirements

- Compressed air supply via soft-start valve
- Supply plate: blanking plug in duct 1
- Right-hand end plate: blanking plug in duct 1, 3, 5 or
- Right-hand end plate with pilot air selector

For internal pilot air supply:

- Seal (soft-start valve - manifold sub-base) with pilot air supply hole "open" and
- Right-hand end plate: blanking plug in duct 14 or
- End plate with coding (position 2, internal pilot air supply)

For external pilot air supply:

- Seal (soft-start valve - manifold sub-base) with pilot air supply hole "closed" and
- Pilot air supply via duct 14 in the right-hand end plate or
- End plate with coding (position 1, external pilot air supply)

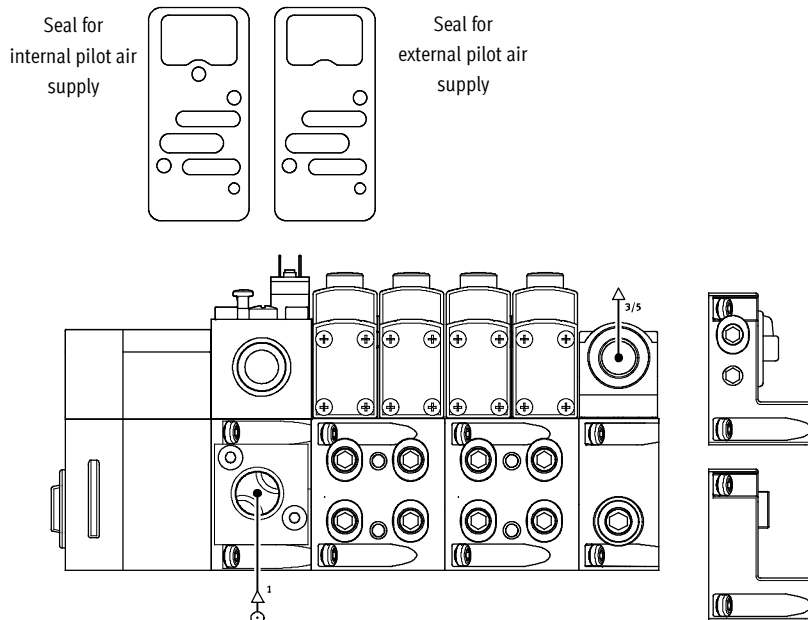

Valve terminals VTSA/VTSA-F, NPT

Technical data – Soft-start valve, width 43 mm

Dimensions Download CAD data → www.festo.com

Soft-start valve

1 Soft-start valve (port pattern to ISO 5599-2) 2 Manifold sub-base with connecting adapter (ducts 2 and 4), pneumatic connection 1/2NPT

3 Soft-start valve optionally with sensor or protective cap 4 Normal position (unactuated) 5 Switching position (actuated)

Type	B1	B2	B3	B4	B5	D1	L1	L2	L3	L4	L5	L6	L7
VABF-S6-1-P5A4-N12-4- ...	43	36.5	28	11.2	12.6	M12x1	142	30	67.3	29.3	41	27	20.8

Type	H1	H2	H3	H4	H5	H6	H7	H8	H9	H10	H11
VABF-S6-1-P5A4-N12-4- ...	78.9	65.5	56.4	55.9	51.5	44	41.2	3.5	68.3	39.5	1

Seal¹⁾ between soft-start valve and manifold sub-base

1 Hole, internal pilot air supply 1 No hole, external pilot air supply

Type	H1	L1
VABD-S6- ...	40	84.8

1) Seals included with the manifold sub-base

Valve terminals VTSA/VTSA-F, NPT

FESTO



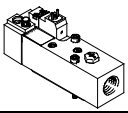
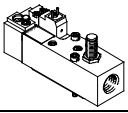
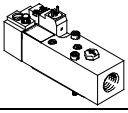
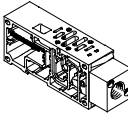



Technical data – Soft-start valve, width 43 mm

Ordering data				
	Description	Weight [g]	Part No.	Type
Soft-start valve, 24 V DC				
	Without sensor output, pneumatic connection 1/2" NPT	590	558231	VABF-S6-1-P5A4-N12-4-1
	With sensor output PNP, pneumatic connection 1/2" NPT	605	558232	VABF-S6-1-P5A4-N12-4-1-P
	With sensor output NPN, pneumatic connection 1/2" NPT	605	558234	VABF-S6-1-P5A4-N12-4-1-N
Soft-start valve, 110 V AC				
	Without sensor output, pneumatic connection 1/2" NPT	590	558229	VABF-S6-1-P5A4-N12-4-2A
Manifold sub-base				
	Prepared for mounting of a soft-start valve (ports for ducts 2 and 4 combined), pneumatic connection 1/2" NPT	570	556988	VABV-S6-1Q-N12

Valve terminals VTSA/VTSA-F, NPT

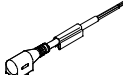
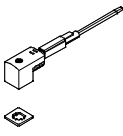

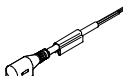
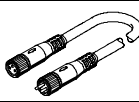

FESTO

Accessories – Soft-start valve, width 43 mm

Ordering data				
Designation	Code	Description	Part No.	Type
Protective cap				
	-	M12, for sealing the sensor opening	10 pieces	165592 ISK-M12
Electrical connection of the soft-start valve				
	P1	<ul style="list-style-type: none"> Angled socket, type C, 2-pin, with LED Straight plug, M12x1, 2-pin 24 V DC 		188024 MSSD-EB-M12-MONO
	GB	<ul style="list-style-type: none"> Straight socket, M12x1, 5-pin Open end, 4-wire 	5 m	541328 NEBU-M12G5-K-5-LE4
	-	<ul style="list-style-type: none"> Angled socket, M12x1, 5-pin Open end, 3-wire 	5 m	541329 NEBU-M12W5-K-5-LE4
	GG	<ul style="list-style-type: none"> Angled socket, type C, 3-pin, with LED 	2.5 m	151688 KMEB-1-24-2,5-LED
	GH	<ul style="list-style-type: none"> Open end, 3-wire 	5 m	151689 KMEB-1-24-5-LED
	GJ	<ul style="list-style-type: none"> 24 V DC, PVC 	10 m	193457 KMEB-1-24-10-LED
	GK	<ul style="list-style-type: none"> Angled socket, type C, 3-pin 	2.5 m	151690 KMEB-1-230AC-2,5
	GL	<ul style="list-style-type: none"> Open end, 3-wire 230 V AC, PVC 	5 m	151691 KMEB-1-230AC-5
Connecting cable for electrical connection of the proximity sensor				
	-	<ul style="list-style-type: none"> Straight socket, M12x1, 5-pin Open end, 4-wire 	5 m	541328 NEBU-M12G5-K-5-LE4
	GC	<ul style="list-style-type: none"> Angled socket, M12x1, 5-pin Open end, 3-wire 	5 m	541329 NEBU-M12W5-K-5-LE4
	-	Modular system for connecting cables	-	NEBU-... → Internet: nebu
Pressure gauge				
	-	0 ... 10 bar, pneumatic connection M5		526323 MA-27-10-M5
Silencer				
	-	Connecting thread NPT	1/2" NPT	12741 U-1/2-B-NPT
Pneumatic connection accessories				
A selection of possible fittings, blanking plugs, silencers and other pneumatic accessories can be found in the chapter Accessories → page or on the Internet via the individual search terms: Internet → connection technology, silencer, blanking plug				

Valve terminals VTSA/VTSA-F, NPT

Adaptation to width 65 mm

-  - Valve width 65 mm
ISO size 3
-  - Flow rate
Up to 4,000 l/min
-  - Operating pressure
-0.9 ... 10 bar
-  - Voltage
24 V DC
-  - Temperature range
-5 ... +50 °C

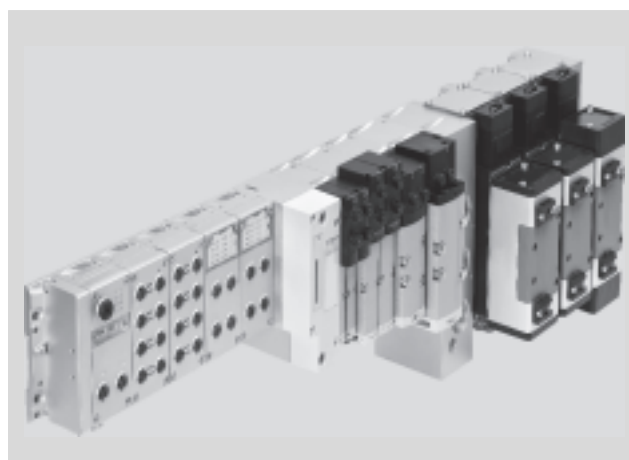

Description

Function

The adaptation of valves, regulator and flow control plates of width 65 mm, ISO size 3 in type 04

technology further expands the scope of application of the valve terminal VTSA/VTSA-F:

- 5 valve sizes with pneumatic function integration on a valve terminal VTSA/VTSA-F
- Max. flow rate up to 4,000 l/min
- Max. 26 solenoid coils of width 65 mm, ISO size 3 can be adapted to the valve terminal VTSA/VTSA-F. The total number of solenoid coils of all widths must not exceed 32.

Restrictions

End plate with pilot air selector

If components of ISO size 3 are used, the end plate with pilot air selector is not available for selection.

Pilot air supply via adapter plate

If no pneumatic components are installed on the left-hand side of the adapter plate (electrical components only), ducts 12 and 14 of the adapter plate must be sealed with blanking plugs.

Pressure zones

Max. 2 pressure zones are possible with ISO size 3.

Valve terminals VTSA/VTSA-F, NPT

Key features – Adaptation to width 65 mm

Equipment options

Valve functions for width 65 mm, ISO size 3

- 5/2-way valve
 - Single solenoid, pneumatic spring/mechanical spring
 - Double solenoid
 - Double solenoid with dominant signal
- 5/3-way valve
 - Mid-position pressurised
 - Mid-position closed
 - Mid-position exhausted

Special features

Fieldbus connection/CPX terminal

- Max. 32 valve positions/
max. 32 solenoid coils
- Any compressed air supply
- Any number of pressure zones

Multi-pin plug connection

- Max. 32 valve positions/
max. 32 solenoid coils
- Parallel modular valve linking
- Any compressed air supply
- Any number of pressure zones

AS-interface

- 1 to 8 valve positions/max. 8 solenoid coils. Auxiliary power supply is required.

Combinable

- Width 65 mm: valve flow rate up to 4,000 l/min
- Width 18 mm, 26 mm, 42 mm and 52 mm can be combined on a single valve terminal. Width 65 mm is mounted at the end of the VTSA/VTSA-F configuration via adapter VABA



Note
The total number of solenoid coils of all widths must not exceed 32.

Valve terminal configurator

➔ Internet: www.festo.com

A valve terminal configurator is available to help you select a suitable VTSA/VTSA-F valve terminal. This makes it much easier to order the right product.

The valve terminals are fully assembled according to your order specification and are individually tested. This reduces assembly and installation time to a minimum.

You order a valve terminal VTSA using the order code:

Ordering system for VTSA
➔ Internet: vtsa

Ordering system for CPX
➔ Internet: cpx

You order a valve terminal VTSA-F using the order code:

Ordering system for VTSA-F
➔ Internet: vtsa-f

Ordering system for CPX
➔ Internet: cpx



Note
Please note that despite the basic configuration for ISO size 3 valves

- The manual override is always non-detenting.
- Exhaust air 3/5 of the adapter plate for ISO size 3 is always routed separately.
- There is no option for 90° connection plate, outlet at bottom.
- There is no option for sintered silencers.
- There is no option for pneumatic accessories.

Valve terminals VTSA/VTSA-F, NPT

Peripherals – Pneumatic components

FESTO

Overview of modules for width 65 mm, ISO size 3

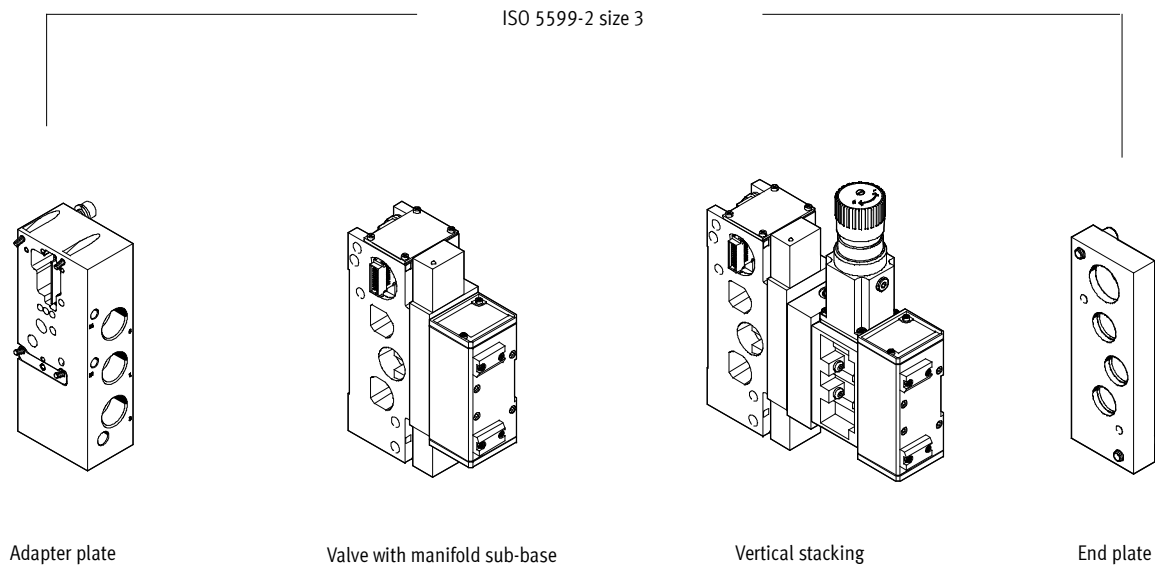

Pneumatic components

Pneumatic modules	Vertical stacking	Additional modules
<ul style="list-style-type: none"> Manifold sub-base for ISO valves Size 3: (1/2" NPT) 4,000 l/min <p>Adapter plate</p> <ul style="list-style-type: none"> Pressure supply connection duct 1 Exhaust connection duct 3/5 (separated) External pilot air supply connection (optional) for pneumatic components on the left-hand side <p>Pneumatic modules</p> <ul style="list-style-type: none"> Manifold sub-base for one ISO valve Pilot control via intermediate solenoid plate ISO size 3 	<ul style="list-style-type: none"> Valves Flow control plates Intermediate pressure regulator plates Pressure gauge Creation of pressure zones with 10 bar or vacuum (with external pilot air supply only) <p>Information on valve activation for ISO size 3</p> <ul style="list-style-type: none"> All intermediate solenoid plates feature a non-detenting manual override Valve terminals with internal pilot air supply: restricted pressure range Valve terminals with external pilot air supply: pressure zones up to 10 bar or vacuum operation possible. In this case, the pilot air supply must be regulated and supplied externally. 	<ul style="list-style-type: none"> Flow control plates: one-way flow control valves can be mounted between the manifold sub-base and the valve so that the speed of travel can be set separately for single and double-acting cylinders Pressure regulators: intermediate pressure regulator plates for setting the contact pressure of a cylinder, either separately on duct 1, 2 or 4, or shared by 2 and 4 Pressure gauge on pressure regulator <p>Flexible compressed air supply</p> <ul style="list-style-type: none"> Compressed air supply via the adapter plate or the right-hand end plate With large valve terminals, compressed air can be supplied at both sides <ul style="list-style-type: none"> Creation of pressure zones: maximum of 2 pressure zones, up to 10 bar as well as for vacuum, are possible for all valve sizes. Compressed air supply at both sides is essential in this case Regulated external pilot air supply should be used for pressures < 3 bar <p>Options</p> <ul style="list-style-type: none"> Vacant positions for subsequent extensions All pneumatic connections can also be supplied with a G thread

Valve terminals VTSA/VTSA-F, NPT

Peripherals – Pneumatic components

FESTO

Pneumatic components of width 65 mm, ISO size 3

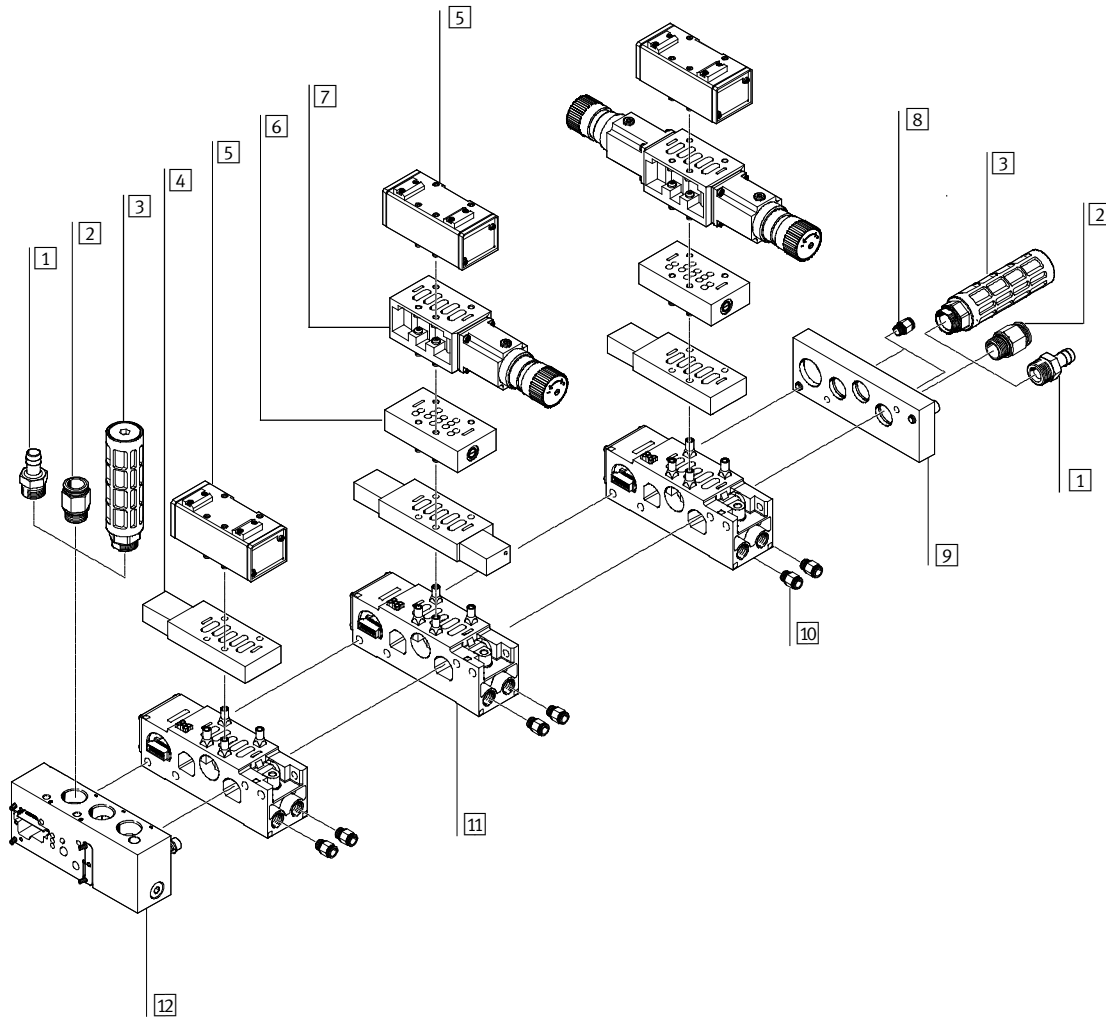

	Brief description	→ Page/Internet
1	Female hose connector 1"	–
2	Fitting	For compressed air supply
3	Silencer	For exhaust air
4	Intermediate solenoid plate	For pneumatically actuated standard valves
5	Valve	Pneumatically actuated standard valve
6	Flow control plate	For exhaust air flow control
7	Intermediate pressure regulator plate	–
8	Fitting	For pilot air
9	End plate	Right-hand end plate
10	Fitting	For supply air (QS 16, QS 12)
11	Manifold sub-base	For linking the valve terminal
12	Adapter plate VABA ...	For adaptation of ISO size 3 components to valve terminal VTSA/VTSA-F

Valve terminals VTSA/VTSA-F, NPT

Key features – Pneumatic components

Key features – Pneumatic components

Adapter plate VABA ...

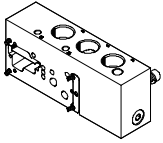

The adapter plate VABA ... is used for adaptation of valves of width 65 mm ISO size 3 to valve terminal VTSA/VTSA-F. Connections for supply/exhaust air and pilot air supply are

available. The external pilot air used here supplies the valve terminal with valves of width 18 ... 52 mm on the left-hand

side of the adapter. The external pilot air supply for the valves with a width of 65 mm, ISO size 3 is provided via the end plate IEPR

Blanking plates

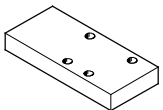

Blanking plates are used to seal off vacant valve positions. No intermediate solenoid plate is

mounted underneath the blanking plate. This depends on the valve used and must be ordered with the valve if

the terminal is expanded at a later date.

Valves and pilot control

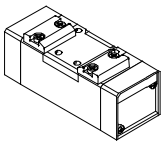

The valves used are pneumatically actuated standard valves that are controlled by means of an intermediate solenoid plate.

Valves and flow lines

The selection of pilot air supply is made at the intermediate solenoid plate by configuring two plugs. Air can

be taken from the supply air, or from a separate air supply. A separate pilot air supply is required in principle if

supply pressure is less than 3 bar (including vacuum). In this case it is advisable to restrict

the pilot air supply to max. 10 bar with a suitable regulator.

Valve terminals VTSA/VTSA-F, NPT

Key features – Pneumatic components

Valve function			
Code	Circuit symbol	Width 65 mm	Description
O		■	5/2-way valve, single solenoid <ul style="list-style-type: none"> • With intermediate solenoid plate • Mechanical spring
-		■	5/2-way valve, single solenoid <ul style="list-style-type: none"> • With intermediate solenoid plate • Pneumatic spring
M		■	5/2-way valve, single solenoid <ul style="list-style-type: none"> • With intermediate solenoid plate • Pneumatic spring, external pilot air supply
J		■	5/2-way valve, double solenoid <ul style="list-style-type: none"> • With intermediate solenoid plate
D		■	5/2-way valve, double solenoid <ul style="list-style-type: none"> • With intermediate solenoid plate • Dominant signal
G		■	5/3-way valve <ul style="list-style-type: none"> • With intermediate solenoid plate • Mid-position closed
E		■	5/3-way valve <ul style="list-style-type: none"> • With intermediate solenoid plate • Mid-position exhausted
B		■	5/3-way valve <ul style="list-style-type: none"> • With intermediate solenoid plate • Mid-position pressurised
L		■	Blanking plate

- - Note

A filter must be installed upstream of the valves operated in vacuum mode. This prevents any foreign matter in

the intake air getting into the valve (e.g. when operating a suction cup).

Valve terminals VTSA/VTSA-F, NPT

Key features – Pneumatic components

Vertical stacking, width 65 mm

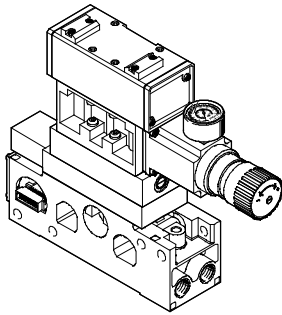

Additional components can be added to each ISO size 3 valve position between the sub-base (manifold sub-base) and the valve. These functions

are known as vertical stacking modules and enable special functioning or control of an individual valve position.

Vertical stacking components

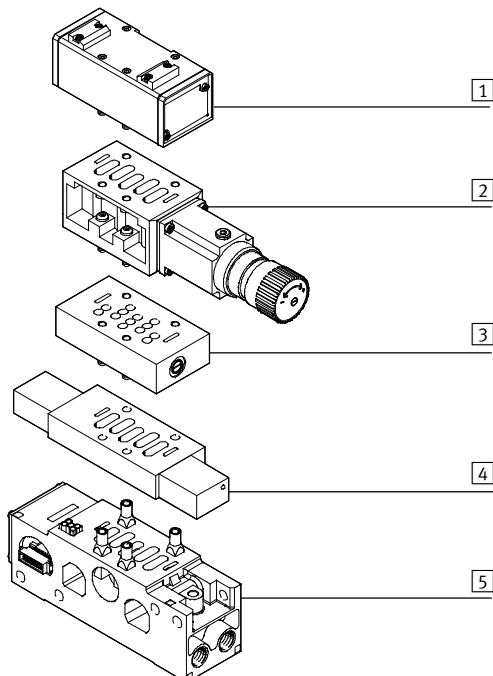

- 1 Valve ISO size 3
- 2 Intermediate pressure regulator plate
- 3 Flow control plate
- 4 Intermediate solenoid plate
- 5 Manifold sub-base with port pattern to DIN ISO 5599-2

 Note

Certain combinations are not possible due to the design of the individual vertical stacking components.

Valve terminals VTSA/VTSA-F, NPT

Key features – Pneumatic components

Flow control plate, width 65 mm

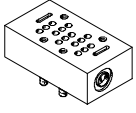

Intermediate plate with integrated exhaust air flow control valves at ports 3 and 5 for regulating cylinder speed.

Intermediate pressure regulator plate and pressure gauge, for width 65 mm

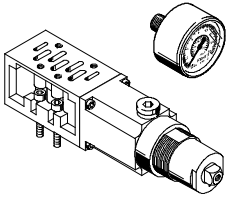





Intermediate plate with integrated pressure regulator for regulating pressure at

- ports 2 and 4 (B, A)
- port 4 (A)
- port 2 (B)
- port 1 (P)

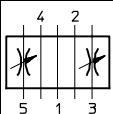
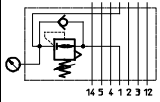
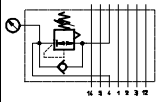
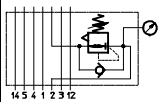
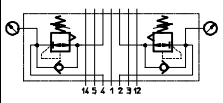
Easy pressure adjustment

Pressure gauges can be screwed directly into the intermediate pressure regulator plate to adjust the pressure.

Functions			
Code	Circuit symbol	Width 65 mm	Description
X		■	Flow control plate (with two one-way flow control valves for exhaust air flow control)
ZA		■	Intermediate pressure regulator plate, port 1
ZB		■	Intermediate pressure regulator plate, port 4
ZC		■	Intermediate pressure regulator plate, port 2
ZD		■	Intermediate pressure regulator plate, ports 2 and 4
S T R		■	Isolating disc for creating pressure zones Duct separation 1, 3, 5 Duct separation 1 Duct separation 3, 5
T		-	Pressure gauge for regulator, max. 10 bar
-		-	Pressure gauge for regulator, max. 16 bar

Valve terminals VTSA/VTSA-F, NPT

Key features – Pneumatic components

Manifold sub-base for valves, width 65 mm

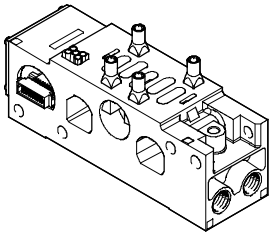

Adaptation to size 65 mm ISO size 3 is based on a modular system which consists of manifold sub-bases and valves. The manifold sub-bases contain a duct seal and an electrical inter-linking module, are screwed together and thus form the support system for the valves. Inside the manifold

sub-bases are the connection ducts for supplying compressed air to and venting from the valves on the terminal as well as the working lines for the pneumatic cylinders for each valve. Each manifold sub-base is connected to the next using two screws.

Individual valve terminal sections can be isolated and further manifold sub-bases inserted by loosening these screws. This ensures that the valve terminal can be rapidly and reliably extended, even for width 65 mm, ISO size 3.

Port pattern to ISO 5599-2 of the manifold sub-base for valves with width 65 mm

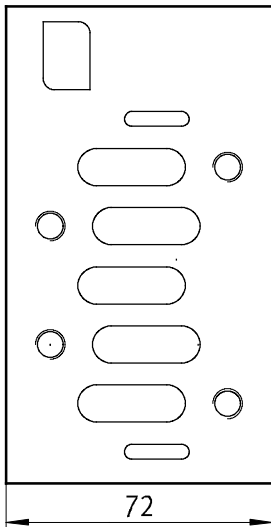

Valve terminals VTSA/VTSA-F, NPT

Key features – Pneumatic components

Compressed air supply and venting

Right-hand end plate

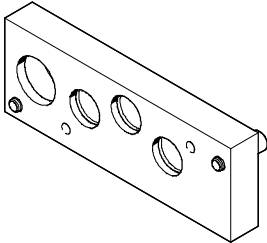

With the adaptation to width 65 mm ISO size 3, compressed air is supplied via the right-hand end plate and/or the adapter plate VABA

Venting is via silencers or ports for ducted exhaust air on the adapter plate VABA ... and/or on the right-hand end plate.

The external pilot air supply for the valves with a width of 65 mm, ISO size 3 is provided via the end plate IEPR

Pilot air supply

When using valves with a width of 65 mm, the internal/external pilot air supply for the valves with a width of 18 ... 52 mm is provided via the adapter plate VABA-....
The external pilot air supply for the valves with a width of 65 mm is provided via the right-hand end plate IEPR

Internal pilot air supply

Internal pilot air supply can be selected if the working pressure is between 3 ... 10 bar.
The pilot air supply is then branched from the compressed air supply 1 using an internal connection. Ports 12 and 14 on the right-hand end plate are sealed with a blanking plug.

External pilot air supply

If the working pressure is not within the range from 3 ... 10 bar, you must operate the valves with a width of 65 mm, ISO size 3 using external pilot air supply. The pilot air supply is then supplied via ports 12 and 14 on the right-hand end plate.



Note

If a gradual pressure build-up is required in the system by means of an external soft-start valve, then external pilot air should be selected whereby the pilot pressure is already applied at the point of switch-on.

Creating pressure zones

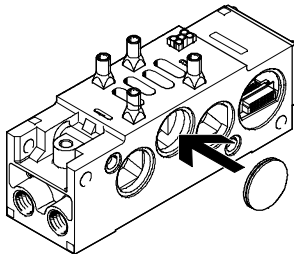

Different supply pressures are possible in the area containing the valves with a width of 65 mm by installing isolating discs between two connection blocks. When doing this it should

be noted that the isolating disc is inserted into the manifold sub-base from the right. The supply and exhaust is effected on the left-hand side via the adapter plate VABA ... and via the

right end plate. Usually, only duct 1 has to be isolated. In special cases, isolating discs may also be inserted into exhaust ducts 3 and 5.

Manual override (MO)

MO with automatic reset (non-detenting)

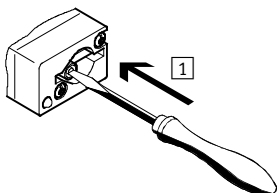

- 1 Press in the stem of the manual override using a pointed object or screwdriver. Valve is in switching position.

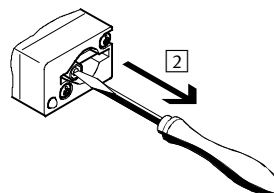

- 2 Remove the pointed object or screwdriver. Spring force pushes the stem of the manual override back. Valve returns to its initial position (not with double solenoid valve code J, D).

Valve terminals VTSA/VTSA-F, NPT

Key features – Electrical components

Electrical connection concept

Replacing the solenoid coil fuse

Each solenoid coil is protected with a (fast-blowing) 0.315 A fuse. These fuses are located behind the cover of

each manifold sub-base on the printed circuit board. Each single solenoid manifold sub-base has one fuse, while

each double solenoid manifold sub-base has two fuses.



Note

Make sure that there is sufficient clearance for maintenance purposes.

Changing the solenoid coil fuse

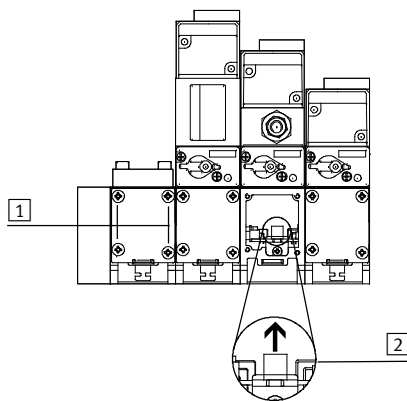

- 1 Loosen the fastening screws in the cover
- 2 Carefully remove the fuse from its base.
Right fuse for valve solenoid 14.
Left fuse for valve solenoid 12.

Valve terminals VTSA/VTSA-F, NPT

Key features – Assembly

Rear side mounting

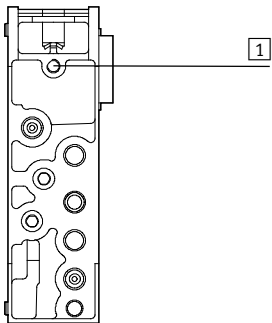

1 Blind hole for rear side mounting

The rear side of the manifold sub-bases has holes (blind holes) for mounting the valve terminal on machines or metal racks (rear side mounting).

M8 threads need to be cut for this purpose.

Wall mounting in the area of the adaptation to width 65 mm, ISO size 3

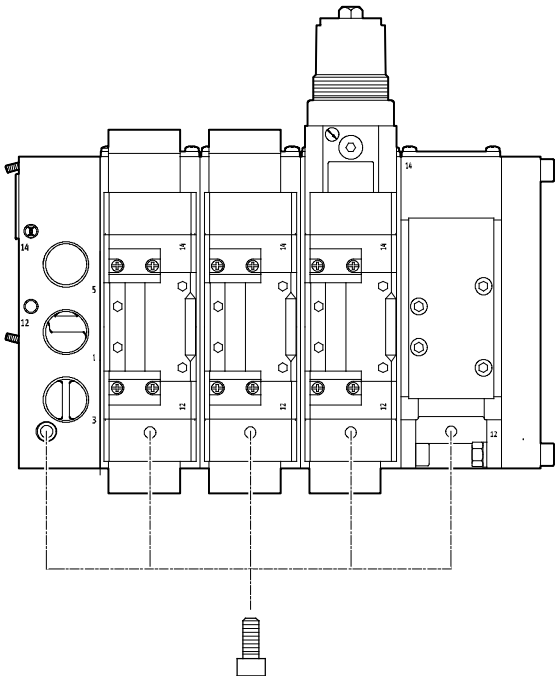

- With screws M8 on the adapter plate and the manifold sub-bases
- Holes (blind holes) on the underside of the manifold sub-bases
- Hole (through-hole) in the adapter plate

 Note

The mounting holes of every second manifold sub-base must be used for the wall mounting of a valve terminal VTSA-ASI in size ISO 3.

Valve terminals VTSA/VTSA-F, NPT

Technical data – General technical data

General technical data for valve functions		
Design		Piston spool valve
• Valves		
• Intermediate pressure regulator plate		Pressure regulator with secondary venting
Width	[mm]	65
Nominal size	[mm]	14.5
Type of mounting		
• Valves		With through-holes on the manifold sub-base
• Flow control plate		With through-holes on the manifold sub-base
• Intermediate pressure regulator plate		With through-holes on the manifold sub-base
Mounting position		Any
Manual override		Non-detenting
Pneumatic connections – NPT connection		
Supply air	1	1" NPT
Exhaust air	3/5	1" NPT
Working ports	2/4	1/2" NPT
Pilot air supply	12/14	1/8" NPT

Standard nominal flow rate		
Valves		
Flow rate of valve	[l/min]	4,500
Flow rate of valve on valve terminal	[l/min]	4,000
Intermediate pressure regulator plate		
Flow rate	[l/min]	1,800

Operating and environmental conditions	
Valve functions, adapter plate	
Operating medium	Compressed air to ISO 8573-1:2010 [7:4:4]
Note about the operating/pilot medium	Lubricated operation possible (required during subsequent operation)
Operating pressure	[bar] -0.9 ... +10
Operating pressure	[bar] 3 ... 10 (for valve terminal with internal pilot air supply)
Pilot pressure	[bar] 3 ... 10
Pressure regulation range	[bar] 0 ... 12 (for intermediate pressure regulator plate)
Ambient temperature	[°C] -5 ... +50
Temperature of medium	[°C] -5 ... +50
Storage temperature	[°C] -20 ... +40 (for long-term storage)
Mounting position	Any
Certification	BIA (for characteristic SP and/or SN only) C-Tick
CE mark (see declaration of conformity)	To EU EMC Directive ¹⁾ (for intermediate plate MUH...)
Relative air humidity	[%] 90

1) For information about the applicability of the component see the manufacturer's EC declaration of conformity at: www.festo.com → Support → User documentation.
If the component is subject to restrictions on usage in residential, office or commercial environments or small businesses, further measures to reduce the emitted interference may be necessary.

Pneumatic characteristic data							
Valve function order code	O	M	J	D	G	E	B
Reset method							
Pneumatic spring	-	■	■	■	-	-	-
Mechanical spring	■	-	-	-	■	■	■

Valve terminals VTSA/VTSA-F, NPT

FESTO

Technical data – General technical data

Valve switching times								
Valve function order code	O	M	J	D	G	E	B	
Width 65 mm, nominal operating voltage 24 V DC								
Switching times [ms]	On	13	29	–	–	17	18	16
	Off	43	36	–	–	61	63	60
	Change-over	–	–	8	–	–	–	–

Electrical data – Solenoid coil	
Protection against electric shock (protection against direct and indirect contact to EN 60204-1/IEC 204)	By means of PELV power supply unit
Operating voltage [V]	24 DC $\pm 10\%$
Electrical power consumption per coil [W]	3.1 (130 mA at 24 V DC)
Duty cycle	100% (50% concurrence)
Protection class to EN 60529	IP65 (in assembled state)
Relative air humidity [%]	90% at 40 °C, non-condensing

Electrical data – Adapter plate	
Width	60 mm
Operating voltage [V]	24 DC $\pm 10\%$
Max. acceptable current load per signal [mA]	500
Duty cycle	100%
Protection class to EN 60529	IP65 and NEMA 4 (for all types of signal transmission in assembled state)

Materials	
Valves	Die-cast aluminium, steel
Adapter plate	Wrought aluminium alloy
Seals	Nitrile rubber
Flow control plate	Anodised aluminium, brass
Intermediate pressure regulator plate	Die-cast aluminium, steel
Screws	Galvanised steel
Note on materials	RoHS-compliant

Product weight	
Approx. weight [g]	
Adapter plate	2,600
Manifold sub-base	1,120
Right-hand end plate	1,120
Intermediate solenoid plate	500
Valves	
• Single solenoid, double solenoid	760
• Mid-position	840
Blanking plate	180
Flow control plate	850
Intermediate pressure regulator plate	
• P, B, A	1,120
• A/B	1,770

1) Including manifold sub-base, intermediate solenoid plate and valve

Valve terminals VTSA/VTSA-F, NPT

Technical data – Adaptation to width 65 mm

Dimensions

Download CAD data → www.festo.com

Adapter plate with components, width 65 mm

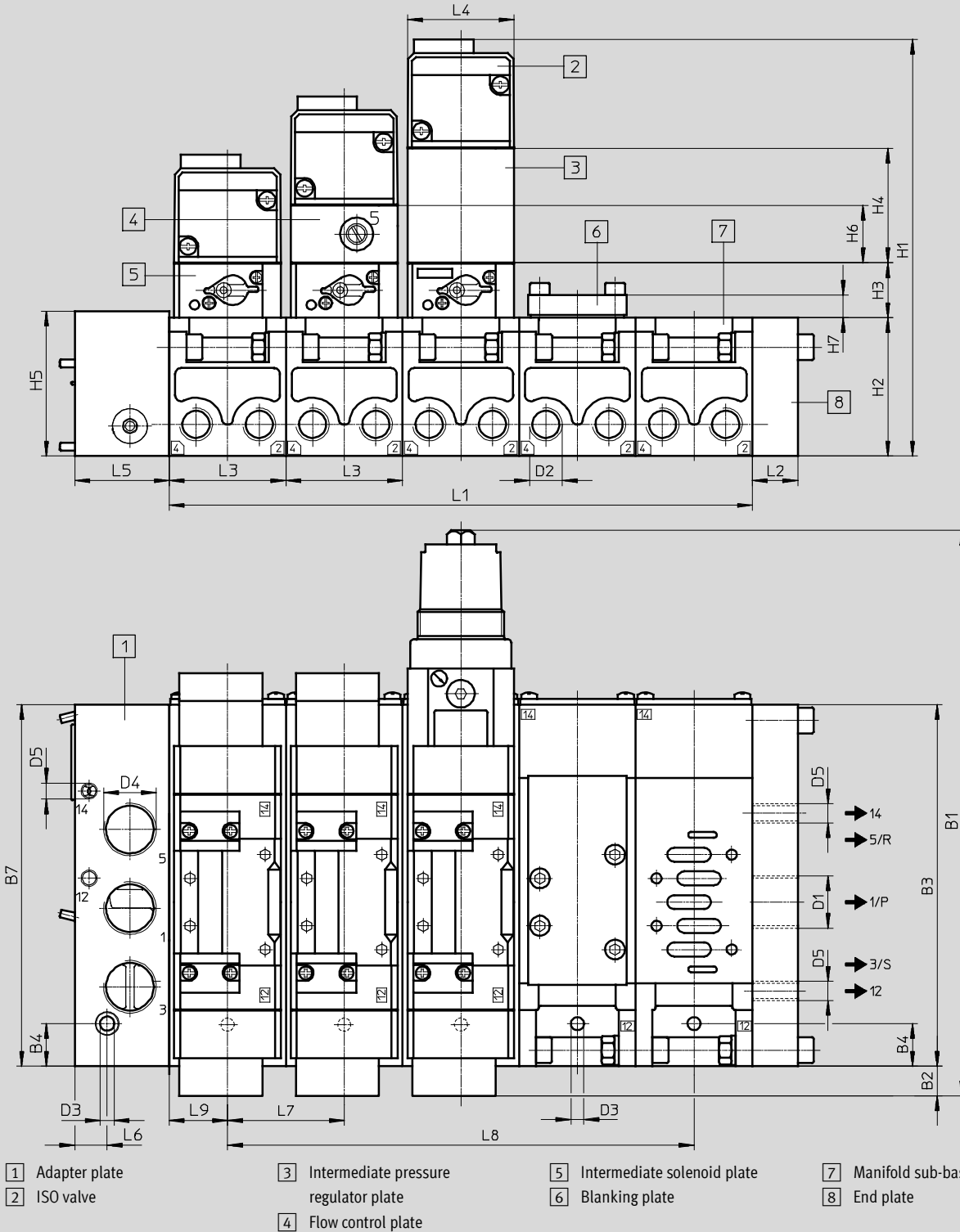

Type		~B1	B2	B3	B4	B7	D1	D2	D3	D4	D5						
VABA-S6-7-S2-3-P...	[mm]	315	6	230	27	230	1" NPT	1/2" NPT	9	1" NPT	1/8" NPT						
Type		H1	H2	H3	H4	H5	H6	H7	L1 ¹⁾	L2	L3	L4	L5	L6	L7	L8 ¹⁾	L9
VABA-S6-7-S2-3-P...	[mm]	235	82	28	63	92	29	21.5	nx72	28	72	70	40	20.5	72	(n-1)x72	36

1) n = number of valves

Valve terminals VTSA/VTSA-F, NPT

Technical data – Dimensions

FESTO

Dimensions

Download CAD data → www.festo.com

Manifold sub-bases for valves with width 65 mm

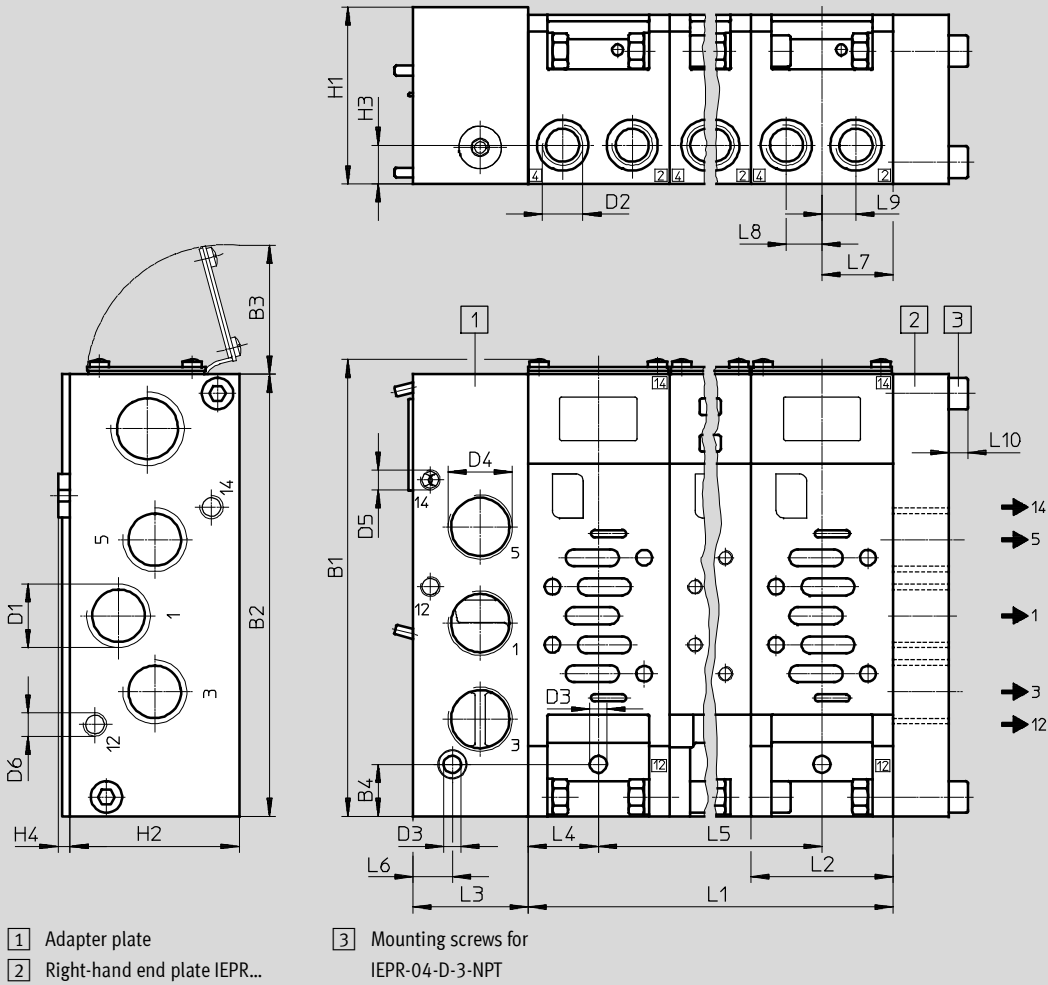

Type	-B1	B2	B3	B4	D1	D2	D3	D4	D5	D6	
VIGI/VIGK-04-D-3-NPT	[mm]	max. 237	230	max. 64	27	G1	½" NPT	9.0	1" NPT	⅜" NPT	G¼

Type	H1	H2	H3	H4	L1 ¹⁾	L2	L3	L4	L5 ¹⁾	L6	L7	L8	L9	L10	
VIGI/VIGK-04-D-3-NPT	[mm]	92	82	20	5	nx72	72	60	36	(n-1)x72	20.5	36	18	18	10

1) n = number of valves

Valve terminals VTSA/VTSA-F, NPT

Technical data – Dimensions

Dimensions

Download CAD data → www.festo.com

Intermediate pressure regulator plate

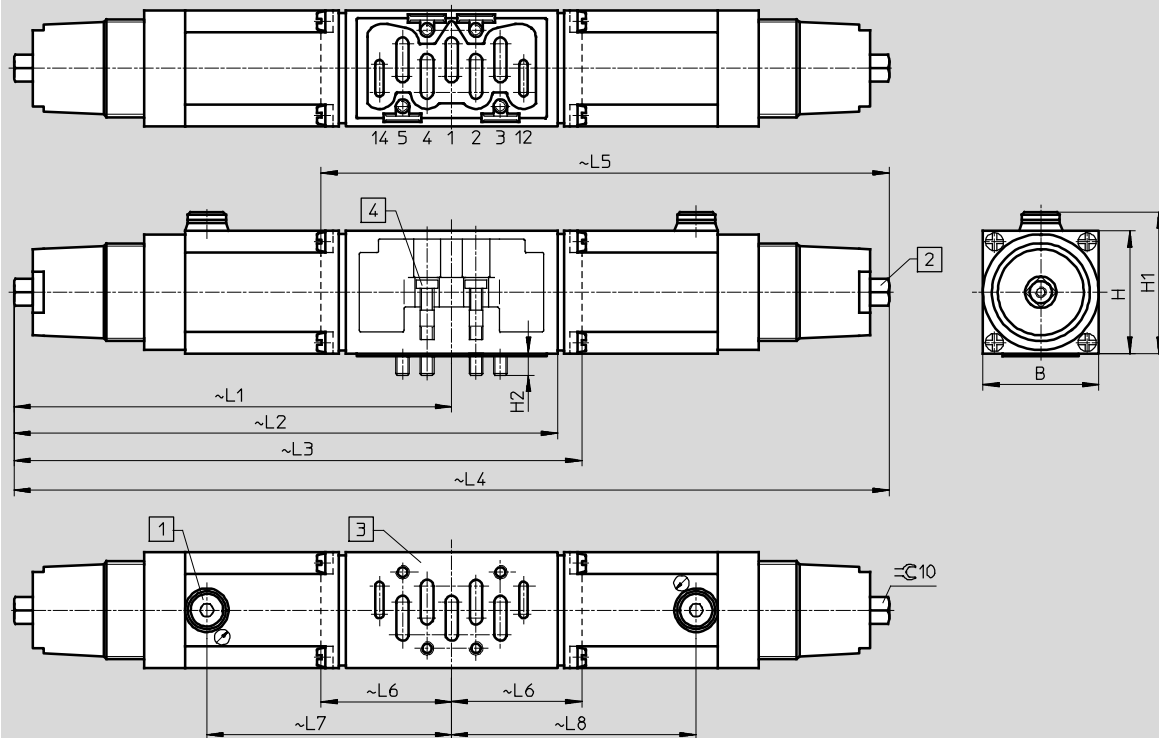

- 1 Pressure gauge connection G $\frac{1}{8}$
- 2 Adjusting screw
- 3 Port pattern to ISO 5599-1
- 4 Captive socket head screw

Type		B	H	H1	H2	L1	L2	L3	L4	L5	L6	L7	L8
LR-ZP-A-D-3	[mm]	70	63	65	14	201.5	–	274	–	–	–	119	–
LR-ZP-B-D-3	[mm]	70	63	65	14	201.5	–	–	–	274	72.5	–	119
LR-ZP-A/B-D-3	[mm]	70	63	65	14	201.5	–	–	403	–	–	119	119
LR-ZP-P-D-3	[mm]	70	63	65	14	201.5	260	–	–	–	–	119	–

Flow control plate

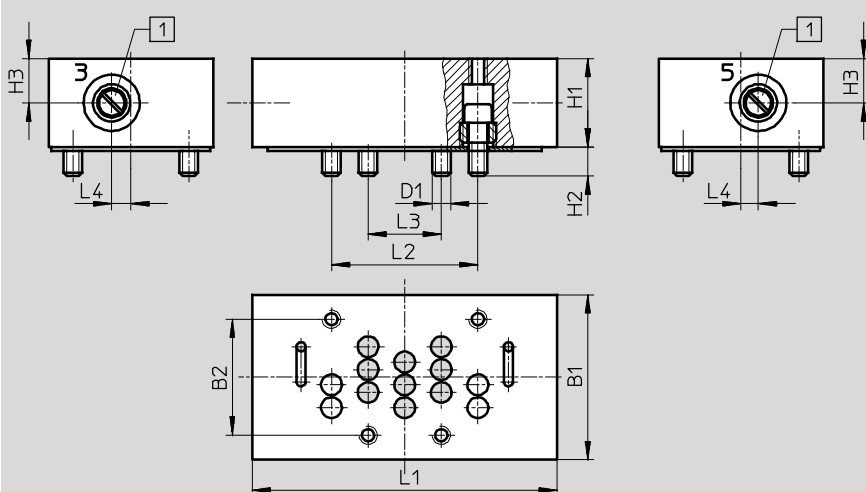

- 1 Adjusting screw for flow control valve

Type		B1	B2	D1	H1	H2	H3	L1	L2	L3	L4
GRO-ZP-3-ISO-B	[mm]	70	48	M8	33	12	16.5	132	64	32	7

Valve terminals VTSA/VTSA-F, NPT

FESTO

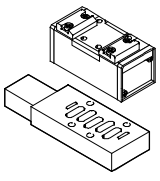
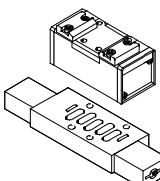
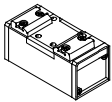
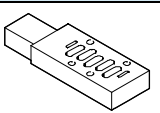
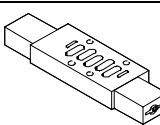

Ordering data – Individual valve 24 V DC

Ordering data				
Designation	Code	Description	Part No.	Type
Set comprising pneumatic valve and intermediate solenoid plate				
	O	<ul style="list-style-type: none"> 5/2-way valve, single solenoid, mechanical spring return With intermediate solenoid plate 	120362	MUH-5/2-D-3-FRC-VI
	-	<ul style="list-style-type: none"> 5/2-way valve, single solenoid, pneumatic spring return With intermediate solenoid plate 	120361	MUH-5/2-D-3C-VI
	M	<ul style="list-style-type: none"> 5/2-way valve, single solenoid, pneumatic spring return, external pilot air supply With intermediate solenoid plate 	119669	MUH-5/2-D-3-L-SC-VI
	J	<ul style="list-style-type: none"> 5/2-way valve, double solenoid With intermediate solenoid plate 	120366	JMUH-5/2-D-3C-VI
	D	<ul style="list-style-type: none"> 5/2-way valve, double solenoid, dominant signal With intermediate solenoid plate 	120367	JDMUH-5/2-D-3C-VI
	G	<ul style="list-style-type: none"> 5/3-way valve, mid-position closed With intermediate solenoid plate 	120363	MUH-5/3G-D-3C-VI
	E	<ul style="list-style-type: none"> 5/3-way valve, mid-position exhausted With intermediate solenoid plate 	120364	MUH-5/3E-D-3C-VI
	B	<ul style="list-style-type: none"> 5/3-way valve, mid-position pressurised With intermediate solenoid plate 	120365	MUH-5/3B-D-3C-VI
	Pneumatic valve (can be ordered individually)			
	-	5/2-way valve, single solenoid (for Code O), mechanical spring return	151863	VL-5/2-D-3-FR-C
	-	5/2-way valve, single solenoid, pneumatic spring return	151864	VL-5/2-D-3-C
	-	5/2-way valve, double solenoid (for Code J, D, G, E, B)	151865	J-5/2-D-3-C
	-	5/2-way valve, double solenoid (for Code J, D, G, E, B, M), dominant signal	151866	JD-5/2-D-3-C
	-	5/3-way valve, mid-position closed (for Code J, D, G, E, B)	151867	VL-5/3G-D-3-C
	-	5/3-way valve, mid-position exhausted (for Code J, D, G, E, B)	151868	VL-5/3E-D-3-C
	-	5/3-way valve, mid-position pressurised (for Code J, D, G, E, B)	151869	VL-5/3B-D-3-C
Intermediate solenoid plate for pneumatic valve (can be ordered individually)				
	-	For actuation of a single solenoid, pneumatically actuated directional control valve (for Code O, M)	34934	MUH-ZP-D-3-24G
	-	For actuation of a single solenoid, pneumatically actuated directional control valve (for Code O, M), external pilot air supply	151715	MUH-ZP-D-3-L-24G
	-	For actuation of double solenoid, pneumatically actuated directional control valves or 5/3-way valves (for Code J, D, G, E, B)	34935	MUHX2-ZP-D-3-24G

Valve terminals VTSA/VTSA-F, NPT

FESTO

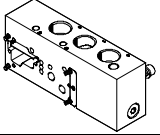
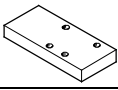
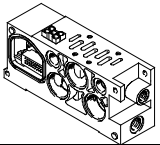
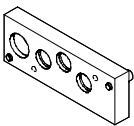
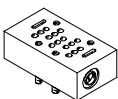
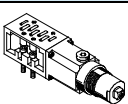
Accessories – Adaptation to width 65 mm

Ordering data – Accessories				
Designation	Code	Description	Part No.	Type
Adapter plate				
	-	Adapter plate for adaptation of ISO size 3 components to valve terminal VTSA/VTSA-F (external pilot air)	1302085	VABA-S6-7-S2-3-P-N1
	-	Adapter plate for adaptation of ISO size 3 components to valve terminal VTSA/VTSA-F (internal pilot air)	1302091	VABA-S6-7-S2-3-P-B-N1
Blanking plate				
	L	Blanking plate for vacant position	36121	IAP-04-D-3
Manifold sub-base, port pattern to ISO 5599-2				
	M	1 valve position, 2 addresses, for double solenoid valves (with QS 16)	18842	VIGI-04-D-3-NPT
	MK	1 valve position, 2 addresses, for double solenoid valves (with QS 12)		
	N	1 valve position, 1 address, for single solenoid valves (with QS 16)	18836	VIGM-04-D-3-NPT
	NK	1 valve position, 1 address, for single solenoid valves (with QS 12)		
Right-hand end plate				
	-	With supply air/exhaust air, internal/external pilot air supply (internal/external pilot air is regulated via MUH plate (solenoid valve))	18881	IEPR-04-D-3-NPT
Flow control plate				
	X	Flow control plate (with two one-way flow control valves for exhaust air flow control)	119674	GRO-ZP-3-ISO-B
Intermediate pressure regulator plate				
	ZA	Port 1	35968	LR-ZP-P-D-3
	ZB	Port 4	35971	LR-ZP-A-D-3
	ZC	Port 2	35426	LR-ZP-B-D-3
	ZD	Ports 2 and 4	35429	LR-ZP-A/B-D-3
Isolating disc				
	T	Duct separation 1	18910	NSC-04-D-3
	R	Duct separation 3, 5		
	S	Duct separation 1, 3, 5		
Pressure gauge				
	T	For regulator, max. 10 bar	162835	MA-40-10-1/8-EN
	-	For regulator, max. 16 bar	529046	MA-40-16-1/8-EN-DPA

Valve terminals VTSA/VTSA-F, NPT

FESTO

Technical data – Valves on individual sub-base

-  - Valve width to ISO 15407-2
- 18 mm
 - 26 mm
- to ISO 5599-2
- 42 mm (ISO 1)
 - 52 mm (ISO 2)

-  - Voltage
- 24 V DC
 - 110 V AC

-  - Flow rate
- Width 18 mm: up to 600 l/min
 - Width 26 mm: up to 1,200 l/min
 - Width 42 mm: up to 1,500 l/min
 - Width 52 mm: up to 3,400 l/min

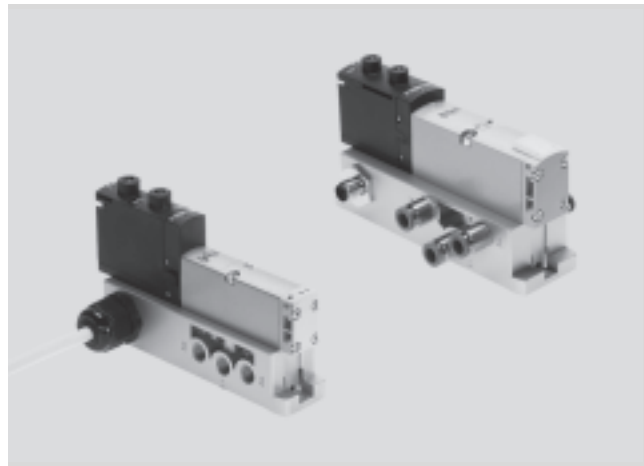

General technical data					
Design	Piston spool valve				
Sealing principle	Soft				
Actuation type	Electric				
Type of control	Piloted				
Exhaust function, with flow control	Via individual sub-base				
Lubrication	Lubricated for life				
Type of mounting	<ul style="list-style-type: none"> • Valve: Screwed onto sub-base • Individual sub-base: Screwed via through-hole 				
Mounting position	Any				
Manual override	Detenting, non-detenting, covered				
Pneumatic connections – NPT thread					
Width	18 mm	26 mm	42 mm	52 mm	
Pneumatic connection	Via sub-base				
Supply port	1	1/8" NPT	1/4" NPT	3/8" NPT	1/2" NPT
Exhaust port	3/5	1/8" NPT	1/4" NPT	3/8" NPT	1/2" NPT
Working ports	2/4	1/8" NPT	1/4" NPT	3/8" NPT	1/2" NPT
External pilot air supply port	14	10-32UNF-2B	1/8" NPT	1/8" NPT	1/8" NPT
Pilot exhaust air port	12	10-32UNF-2B	1/8" NPT	1/8" NPT	1/8" NPT

Valve terminals VTSA/VTSA-F, NPT

Technical data – Valves on individual sub-base

Standard nominal flow rate [l/min]																		
Valve function order code	VC	VV	N	K	H	P	Q	R	M	O	J	D	B	E	G	SA	SB	VG
Type code	T22C	T22CV	T32U	T32C	T32H	T32F	T32N	T32W	M52-AZD	M52-MZD	B52	D52	P53U	P53E	P53C	P53ED	P53AD	P53F
Width 18 mm																		
Flow rate of valve	700		600					750					700 ¹⁾ 330 ²⁾		-	-	-	
Flow rate of valve on individual sub-base	500		500					600					500 ¹⁾ 330 ²⁾		550	-	-	-
Width 26 mm																		
Flow rate of valve	1,350		1,250					1,400					1,400 ¹⁾ 700 ²⁾		1,400 ¹⁾ 700 ²⁾	700	-	
Flow rate of valve on individual sub-base	1,100		1,100					1,200					1,200 ¹⁾ 700 ²⁾		1,200 ¹⁾ 700 ²⁾	700	-	
Width 42 mm																		
Flow rate of valve	1,600		1,600					2,000					1,900 ¹⁾ 950 ²⁾		-	-	1,700 ¹⁾ 800 ²⁾	
Flow rate of valve on individual sub-base	1,400		1,200					1,500					1,400 ¹⁾ 800 ²⁾		-	-	1,200 ¹⁾ 700 ²⁾	
Width 52 mm																		
Flow rate of valve	4,000	-	3,000					4,000					3,600 ¹⁾ 1,700 ²⁾		-	-	-	
Flow rate of valve on individual sub-base	3,400	-	2,600					3,400					3,200 ¹⁾ 1,700 ²⁾		-	-	-	

1) Switching position

2) Mid-position

Operating and environmental conditions	
Operating medium	Compressed air to ISO 8573-1:2010 [7:4:4]
Note about the operating/pilot medium	Lubricated operation possible (required during subsequent operation)
Operating pressure [bar]	-0.9 ... +10
Ambient temperature [°C]	-5 ... +50
Certification	cULus recognized (OL)
CE marking (see declaration of conformity)	In accordance with EU Low Voltage Directive (not for variants with round plug M12, VABS-S4...R3)
Protection class	IP65, NEMA 4 (for all types of signal transmission in assembled state)

Valve terminals VTSA/VTSA-F, NPT

Technical data – Valves on individual sub-base

Pneumatic characteristic data																		
Valve function order code	VC	VV	N	K	H	P	Q	R	M	O	J	D	B	G	E	SA	SB	VG
Direction of flow																		
Any	-	■	-	-	-	-	-	-	■	■	■	■	■	■	■	-	■	■
Reversible only	-	-	-	-	-	■	■	■	-	-	-	-	-	-	-	-	-	-
Non-reversible	■	-	■	■	■	-	-	-	-	-	-	-	-	-	-	■	-	-
Reset method																		
Pneumatic spring	■	■	■	-	■	■	■	■	■	-	-	-	-	-	-	■	■	-
Mechanical spring	-	-	-	■	-	-	-	-	-	■	-	-	■	■	■	-	-	■

Valve switching times																		
Valve function order code ¹⁾	VC	VV	N	K	H	P	Q	R	M	O	J	D	B	G	E	SA	SB	VG
Width 18 mm, nominal operating voltage 24 V DC/110 V AC																		
Switching times [ms]	On	12	12	12	12	12	25	25	25	22	12	-	-	15	15	15	-	-
	Off	30	30	30	30	30	12	12	12	28	38	-	-	44	44	44	-	-
	Change-over	-	-	-	-	-	-	-	-	-	-	11	13	-	-	-	-	-
Width 26 mm, nominal operating voltage 24 V DC/110 V AC																		
Switching times [ms]	On	20	20	20	20	20	32	32	32	25	20	-	-	22	22	22	9/22	9/19
	Off	38	38	38	38	38	30	30	30	45	65	-	-	65	65	65	49	36
	Change-over	-	-	-	-	-	-	-	-	-	-	18	21	-	-	-	33	32
Width 42 mm, nominal operating voltage 24 V DC																		
Switching times [ms]	On	20	20	20	20	20	34	34	34	27	22	-	-	22	22	22	-	-
	Off	38	38	38	38	38	28	28	28	45	60	-	-	65	65	65	-	-
	Change-over	-	-	-	-	-	-	-	-	-	-	16	19	-	-	-	-	-
Width 42 mm, nominal operating voltage 110 V AC																		
Switching times [ms]	On	22	22	22	22	22	34	34	34	20	20	-	-	22	22	22	-	-
	Off	46	46	46	46	46	38	38	38	55	55	-	-	68	68	68	-	-
	Change-over	-	-	-	-	-	-	-	-	-	-	16	19	-	-	-	-	-
Width 52 mm, nominal operating voltage 24 V DC with holding current reduction																		
Switching times [ms]	On	14	-	20	20	20	30	30	30	40	20	-	-	23	23	23	-	-
	Off	35	-	35	35	35	30	30	30	45	60	-	-	60	60	60	-	-
	Change-over	-	-	-	-	-	-	-	-	-	-	18	18	30	30	30	-	-
Width 52 mm, nominal operating voltage 110 V AC																		
Switching times [ms]	On	35	-	35	35	35	50	50	50	70	25	-	-	30	30	30	-	-
	Off	70	-	70	70	70	65	65	65	90	110	-	-	100	100	100	-	-
	Change-over	-	-	-	-	-	-	-	-	-	-	35	35	-	-	-	-	-

1) Not for individual sub-base with round plug type VABS ...B-R3
 2) Order code SA, switching time 22 ms for control side 12, 9 ms for control side 14
 Order code SB, switching time 19 ms for control side 12, 9 ms for control side 14

Valve terminals VTSA/VTSA-F, NPT

Technical data – Valves on individual sub-base

FESTO

Electrical data	
Acceptable current load [A] at 40 °C	2 (1 A per coil)
Protection class to EN 60529	IP65, NEMA 4 (for all types of signal transmission in assembled state)
Variants with cable connector	
Operating voltage range [V AC]	110 ±10% (50 ... 60 Hz) (with variants with cable and spring-loaded terminal VABS-...-K1/C1)
Surge resistance [kV]	4
Degree of contamination	3
Duty cycle [ED]	100%

-  - Note

A cable connector is needed to ensure the IP protection class and to protect against tensile load, twisting and bending.

Materials				
Width	18 mm	26 mm	42 mm	52 mm
Sub-base	Die-cast aluminium			Gravity die-cast aluminium
Valve	Die-cast aluminium, reinforced polyamide			
Seals	Nitrile rubber, elastomer (support made of steel)			

Product weight [g]				
Width	18 mm	26 mm	42 mm	52 mm
Valves				
5/3-way solenoid valve (code: B, G, E)	191	320	456	780
5/3-way solenoid valve (code: SA, SB)	–	301	–	–
5/3-way valve, single solenoid (code: VG)	–	–	456	780
5/2-way valve, single solenoid (code: M, O)	163	293	426	702
5/2-way solenoid valve, double solenoid (code: J, D)	172	276	439	732
2x 3/2-way solenoid valve (code: N, K, H, P, Q, R)	190	335	442	740
2x 2/2-way solenoid valve (code: VC, VV)	190	335	442	740
Individual connection				
Individual sub-base	192	302	386	815

Valve terminals VTSA/VTSA-F, NPT

Technical data – Valves on individual sub-base

Dimensions

Download CAD data → www.festo.com

Individual sub-base with cable terminals, width 18 mm

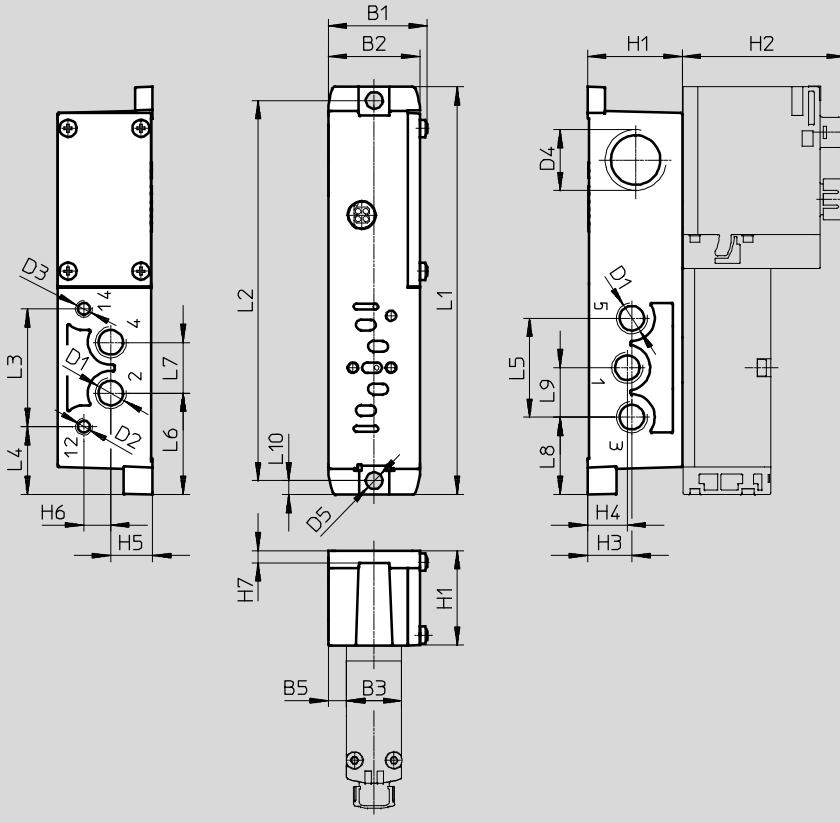

Type	B1	B2	B3	B5	D1	D2	D3	D4	D5 Ø	H1	H2	H3	H4	H5	H6	H7
VABS-S4-2S-N18-K2 ¹⁾	32.4	30	18	6	1/8" NPT	10-32UNF-2B	10-32UNF-2B	M20x1.5	5.5	31	53.4	14.5	13	13.7	8.8	4
VABS-S4-2S-N18-B-K2 ²⁾							-									

Type	L1	L2	L3	L4	L5	L6	L7	L8	L9	L10
VABS-S4-2S-N18-K2 ¹⁾	133.5	124.5	38.6	22.2	32.4	33.2	16.6	25.3	16.2	4.5
VABS-S4-2S-N18-B-K2 ²⁾										

- 1) External pilot air supply
- 2) Internal pilot air supply

• Note: This product conforms to ISO 1179-1 and to ISO 228-1

Valve terminals VTSA/VTSA-F, NPT

Technical data – Valves on individual sub-base

Dimensions

Download CAD data → www.festo.com

Individual sub-base with cable terminals, width 26 mm

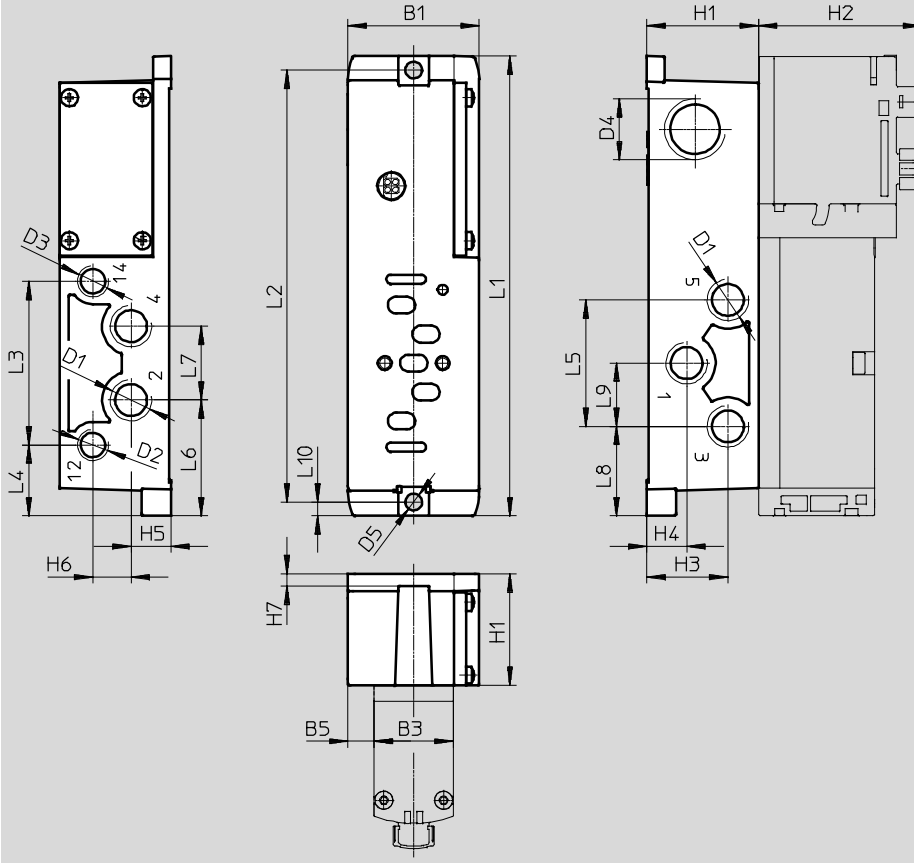

Type	B1	B3	B5	D1	D2	D3	D4	D5 Ø	H1	H2	H3	H4	H5	H6	H7
VABS-S4-1S-G14-K2 ¹⁾	43	26	8.5	¼" NPT	⅛" NPT	⅛" NPT	M20x1.5	5.5	36.5	53.5	26.5	13	13	12.5	4
VABS-S4-1S-G14-B-K2 ²⁾						-									

Type	L1	L2	L3	L4	L5	L6	L7	L8	L9	L10
VABS-S4-1S-G14-K2 ¹⁾	150.6	141.5	53.6	23.2	41.4	37.9	24.2	29.3	20.7	4.5
VABS-S4-1S-G14-B-K2 ²⁾										

- 1) External pilot air supply
- 2) Internal pilot air supply

– † – Note: This product conforms to ISO 1179-1 and to ISO 228-1

Valve terminals VTSA/VTSA-F, NPT

Technical data – Valves on individual sub-base

Dimensions

Download CAD data → www.festo.com

Individual sub-base with spring-loaded terminal or for self-assembly, width 42 mm

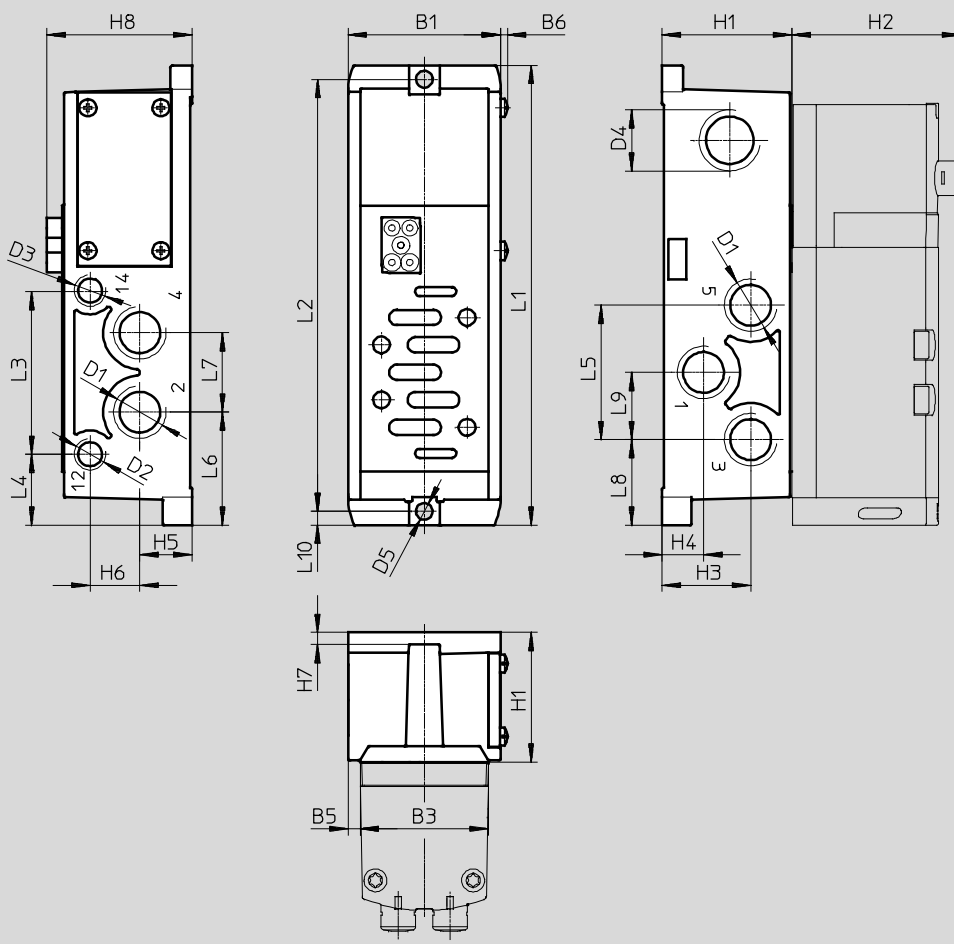

Type	B1	B3	B5	B6	D1	D2	D3	D4	D5	H1	H2	H3	H4	H5	H6	H7	H8
VABS-S2-1S-N38-K1 ¹⁾	50	42	4	2.2	3/8" NPT	1/8" NPT	1/8" NPT	M20x1.5	5.5	42.5	55.3	29	13.6	17.1	16.3	4	47.5
VABS-S2-1S-N38-C1 ¹⁾																	
VABS-S2-1S-N38-B-K1 ²⁾							-										
VABS-S2-1S-N38-B-C1 ²⁾																	

Type	L1	L2	L3	L4	L5	L6	L7	L8	L9	L10
VABS-S2-1S-N38-K1 ¹⁾	150.6	141.5	53.6	23.2	44	37	26	28	22	4.5
VABS-S2-1S-N38-C1 ¹⁾										
VABS-S2-1S-N38-B-K1 ²⁾										
VABS-S2-1S-N38-B-C1 ²⁾										

- 1) External pilot air supply
- 2) Internal pilot air supply

• - Note: This product conforms to ISO 1179-1 and to ISO 228-1

-  - Note

Electrical connection

- VABS-...-K1: open end
- VABS-...-C1: spring-loaded terminal

Valve terminals VTSA/VTSA-F, NPT

Technical data – Valves on individual sub-base

Dimensions

Download CAD data → www.festo.com

Individual sub-base with spring-loaded terminal or for self-assembly, width 52 mm

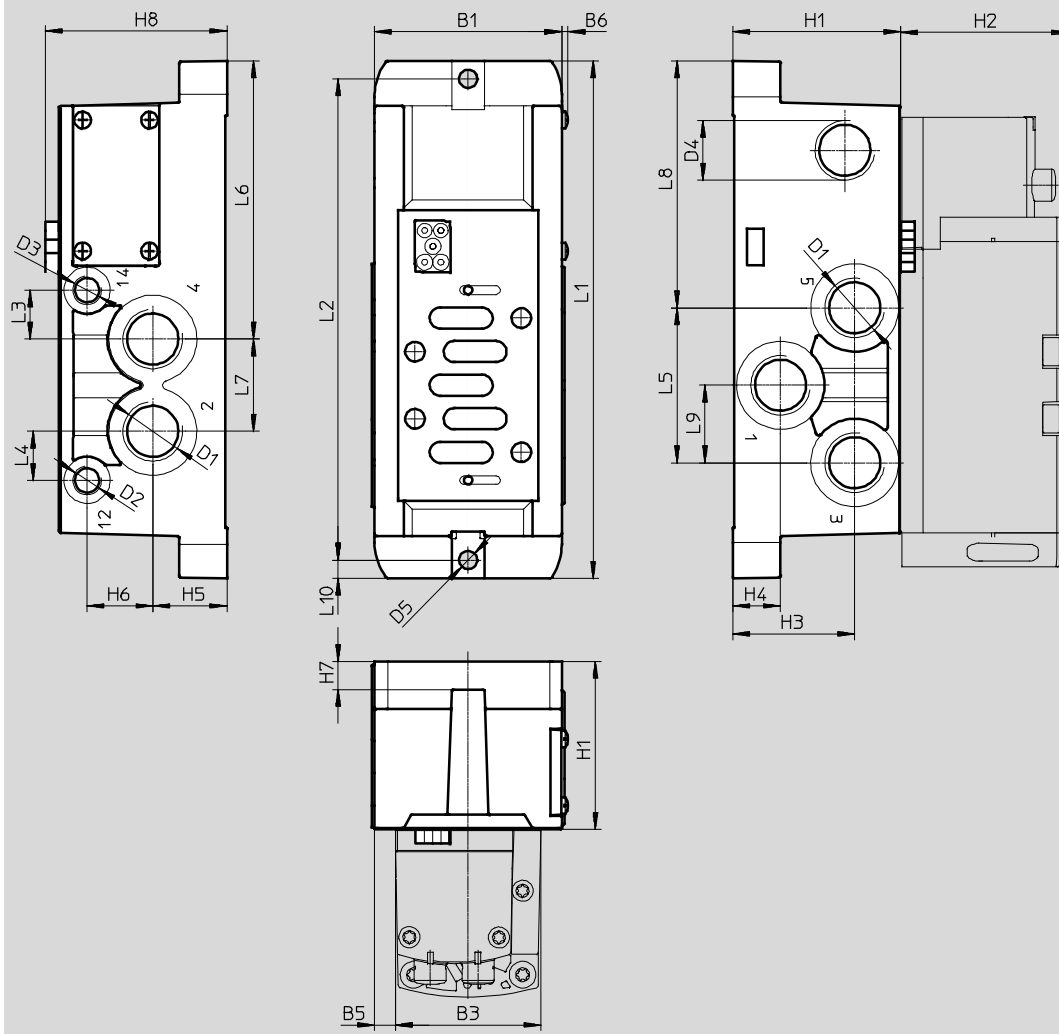

Type	B1	B3	B5	B6	D1	D2	D3	D4	D5 Ø	H1	H2	H3	H4	H5	H6	H7	H8
VABS-S2-2S-N12-K1 ¹⁾	67	52	7.5	2.2	1/2" NPT	1/8" NPT	1/8" NPT	M20x1.5	6.5	60	60	43.5	17	26.5	23.5	10	65
VABS-S2-2S-N12-C1 ¹⁾																	
VABS-S2-2S-N12-B-K1 ²⁾							-										
VABS-S2-2S-N12-B-C1 ²⁾																	

Type	L1	L2	L3	L4	L5	L6	L7	L8	L9	L10
VABS-S2-2S-N12-K1 ¹⁾	185	172	17.5	17.5	55.4	99.5	33	88.3	27.7	6.5
VABS-S2-2S-N12-C1 ¹⁾										
VABS-S2-2S-N12-B-K1 ²⁾										
VABS-S2-2S-N12-B-C1 ²⁾										

- 1) External pilot air supply
- 2) Internal pilot air supply

• Note: This product conforms to ISO 1179-1 and to ISO 228-1

-  - Note

Electrical connection

- VABS-...-K1: open end
- VABS-...-C1: spring-loaded terminal

Valve terminals VTSA/VTSA-F, NPT

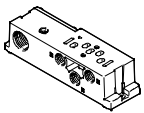
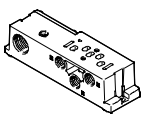
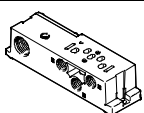
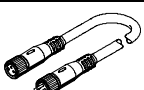

Accessories – Individual connection

Ordering data					
	Description		Width	Part No.	Type
Individual sub-base, electrical connection via cable terminals					
	Threaded connection, internal pilot air supply	Connections 1/8" NPT	18 mm	541068	VABS-S4-2S-N18-B-K2
		Connections 1/4" NPT	26 mm	541066	VABS-S4-1S-N14-B-K2
	Threaded connection, external pilot air supply	Connections 1/8" NPT	18 mm	539724	VABS-S4-2S-N18-K2
		Connections 1/4" NPT	26 mm	539726	VABS-S4-1S-N14-K2
Individual sub-base, electrical connection via spring-loaded terminal					
	Threaded connection, internal pilot air supply	Connections 3/8" NPT	42 mm	546763	VABS-S2-1S-N38-B-C1
		Connections 1/2" NPT	52 mm	555644	VABS-S2-2S-N12-B-C1
	Threaded connection, external pilot air supply	Connections 3/8" NPT	42 mm	546761	VABS-S2-1S-N38-C1
		Connections 1/2" NPT	52 mm	555639	VABS-S2-2S-N12-C1
Individual sub-base, electrical connection via cable (open end)					
	Threaded connection, internal pilot air supply	Connections 3/8" NPT	42 mm	546103	VABS-S2-1S-N38-B-K1
		Connections 1/2" NPT	52 mm	555642	VABS-S2-2S-N12-B-K1
	Threaded connection, external pilot air supply	Connections 3/8" NPT	42 mm	546100	VABS-S2-1S-N38-K1
		Connections 1/2" NPT	52 mm	555637	VABS-S2-2S-N12-K1
Connecting cable for electrical connection of individual valves at the individual electrical connection					
	Modular system for connecting cables			-	NEBU-... → Internet: nebu
Pneumatic connection accessories					
<p>A selection of possible fittings, blanking plugs, silencers and other pneumatic accessories can be found in the chapter Accessories → page 153 or on the Internet via the individual search terms:</p> <p>Internet → connection technology, silencer, blanking plug</p>					

Valve terminals VTSA/VTSA-F, NPT

Accessories

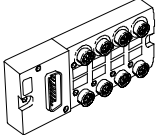
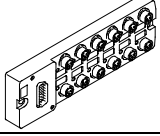
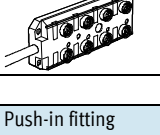
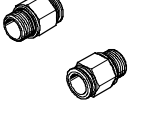
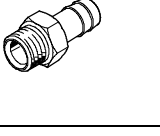
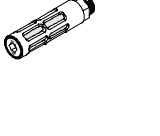
FESTO

Ordering data					
	Description		Part No.	Type	PU ¹⁾
Multi-pin plug distributor					
	15-pin Sub-D socket/8x 3-pin M8 plugs	8 I/Os	177669	MPV-E/A08-M8	1
	15-pin Sub-D socket/12x 3-pin M8 plugs	12 I/Os	177670	MPV-E/A12-M8	1
	15-pin cable/8x 5-pin M12 plugs	8 I/Os	177671	MPV-E/A08-M12	1
Push-in fitting					
	Connecting thread 1/4" NPT for tubing O.D.	1/2"	567771	QB-1/4-1/2-U	10
		3/8"	533278	QB-1/4-3/8-U	10
		5/16"	533277	QB-1/4-5/16-U	10
	Connecting thread 1/8" NPT for tubing O.D.	3/8"	567773	QB-1/8-3/8-U	10
		1/4"	533273	QB-1/8-1/4-U	10
		5/16"	533274	QB-1/8-5/16-U	10
	Connecting thread 3/8" NPT for tubing O.D.	1/2"	533282	QB-3/8-1/2-U	5
		3/8"	533281	QB-3/8-3/8-U	5
	Connecting thread 1/2" NPT for tubing O.D.	5/8"	190682	QS-1/2-5/8-U	1
		1/2"	533284	QB-1/2-1/2-U	5
Female hose connector					
	For right-hand end plate (connecting thread NPT)	3/4"	564848	N-3/4-P-19-NPT	1
		R1	572243	N-1-P-19-NPT	1
	For adapter plate (connecting thread NPT)	R1			1
Silencer					
	Connecting thread NPT	1/8"	12638	U-1/8-B-NPT	1
		1/4"	12639	U-1/4-B-NPT	1
		1/2"	12741	U-1/2-B-NPT	1
		3/4"	566823	U-3/4-B-NPT	1
		1"	571280	U-1-B-NPT	1
Blanking plug					
	Connecting thread NPT	1/8"	173985	B-1/8-NPT	1
		1/4"	174165	B-1/4-NPT	1
		1/2"	31785	B-1/2-NPT	1
		3/4"	31786	B-3/4-NPT	1
		1"	31787	B-1-NPT	1
Other pneumatic connection accessories					
A selection of possible fittings, blanking plugs and silencers can be found on the Internet via the individual search terms: Internet → connection technology, silencer, blanking plug					

1) Packaging unit