

Valve terminals CDVI, Clean Design



Valve terminals CDVI, Clean Design

Key features

FESTO

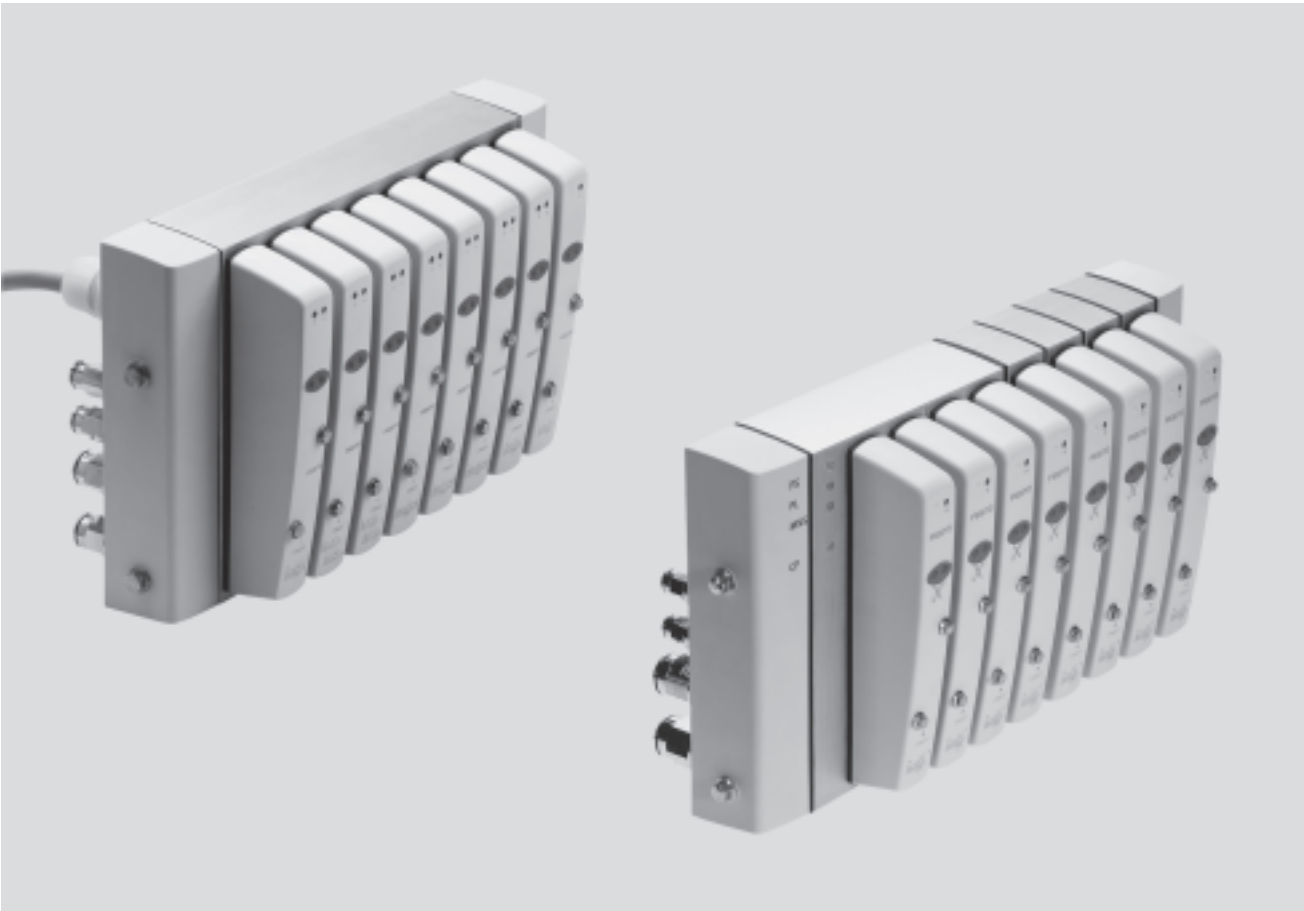

Innovative

- Proven valve technology combined with a highly resistant polymer material
- Modular structure with 4 or 8-valve basic block
- Extension modules with 1 and 2 valve positions
- Extension modules with 1 and 2 valve positions with separate electrical (fieldbus only) and/or pneumatic additional supply
- Multi-pin plug connection
- Fieldbus connection
- Additional valve terminals and I/O modules can be connected via a CP string extension.

Additional information

➔ Internet: ctec

Versatile

- 4 ... 16 valve positions
- Max. 24 solenoid coils
- Standardised from the individual valve up to multi-pin plug and fieldbus connections
- Flow rates from 300 ... 650 l/min
- Valve width 24 mm
- 1 ... 9 electrical voltage zones
- 1 ... 9 pneumatic pressure zones

Reliable

Developed with practical considerations in mind

- Hygienic
- Corrosion resistant
- Easy to clean

Easy to mount

As is the case with all Festo products, all CDVI and CDSV are fully pre-assembled and equipped according to customer requirements

- With QS...-F fittings on the working lines and end plates
- Tested for electrical and pneumatic functions

Valve terminals CDVI, Clean Design

Key features

FESTO

CDVI – The requirements



The food industry has stricter hygiene requirements than any other sector. There can therefore be no compromise when it comes to easy cleaning and corrosion resistance.

Result: the CDVI. Developed in close consultation with leading names from the food and packaging industry, the CDVI represents a totally new valve terminal solution for splash zones. The Clean Design valve terminal CDVI has a revolutionary corrosion-resistant and easy-to-clean design that makes it stand out from its competitors.

CDVI – The solution

The new Clean Design

Valve terminal CDVI – simply a neat solution

Apart from reduced cleaning times, the CDVI also takes less time to install and assemble. Stainless steel control cabinets have become a thing of the past and the electrical connection is now established using the pre-fitted, ready to connect cable. The valve terminal is, of course, supplied fully assembled and in particular tested ex works to IP65, IP66, IP67 and NEMA 4.

This results in minimal installation time.

The valve terminal includes common supply ports and exhausts for all

valves. The common lines are connected to the end plates.

The CDVI is available with four or eight valve positions in the basic designs and can optimally be extended up to 16 valve positions in grids of one or two, taking into consideration the maximum number of coils. Appropriate expansion blocks are used for this.

Individual sub-base

An individual sub-base for Clean Design valves (Clean Design Single Valve – CDSV) rounds off the lower end of the product range so that even upstream machines and system components can be incorporated into the Clean Design concept.

Clean in theory and practice – the CDVI

The requirements for the hygienic design of machine components to DIN EN 1672-2 and DIN ISO 14159 have been implemented in the CDVI. They are easy to clean thanks to:

- no sharp edges
- no small radii
- no crevices where dirt can gather
- space between the valves for easy cleaning
- corrosion-resistant materials

The CDVI can be cleaned using special cleaning agents that are compatible with aluminium, available from the following manufacturers

- Henkel
- Ecolab
- Johnson Diversy
- Kärcher

Certified cleanliness

The CDVI is certified to HACCP.



Valve terminals CDVI, Clean Design

Key features

Reduced downtimes:

On-the-spot diagnostics via LEDs

Width 24 mm

Simple electrical connections:

- Multi-pin plug connection with pre-assembled cable
- Fieldbus connection, operating voltage and CP string extension

Functional:

Robust metal thread or pre-assembled QS-F fittings

Fast assembly

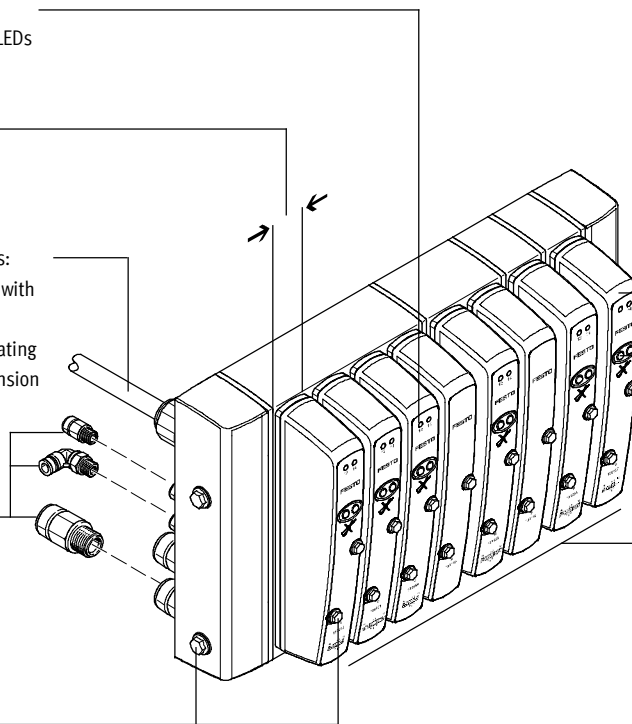

Flexible:

- Max. 16 valve positions with max. 24 solenoid coils
- 1 ... 9 electrical voltage zones
- 1 ... 9 pneumatic pressure zones

Comprehensive range of valve functions

Reliable operation:

Non-detenting manual override

Modular:

- Creation of pressure zones
- Extension modules with 1 and 2 valve positions also with separate electrical (fieldbus only) and/or pneumatic additional supply

Equipment options

Valve functions

- | | | | |
|--|--|--|--|
| <ul style="list-style-type: none"> • 2/2-way valve, normally closed • 2/2-way valve, normally open • 3/2-way valve, normally closed • 3/2-way valve, normally open | <ul style="list-style-type: none"> • 2x 3/2-way valve, normally closed • 2x 3/2-way valve, normally open • 2x 3/2-way valve, 1x normally open, 1x normally closed | <ul style="list-style-type: none"> • 5/2-way valve, single solenoid • 5/2-way valve, double solenoid | <ul style="list-style-type: none"> • 5/3-way valve, mid-position closed • 5/3-way valve, mid-position pressurised • 5/3-way valve, mid-position exhausted |
|--|--|--|--|

Special features

Individual valve

- Electrical connection via multi-pin cable

Multi-pin terminal

- Max. 16 valve positions
- Max. 24 solenoid coils
- Compressed air supply possible via both end plates as well as power supply module
- 1 ... 9 pressure zones
- Detergent resistant PVC cable already assembled
- Cable length 5 m or 10 m

Fieldbus terminal

- Max. 16 valve positions
- Max. 24 solenoid coils
- Compressed air supply possible via both end plates as well as power supply module
- 1 ... 9 pressure zones
- 1 ... 9 voltage zones
- Enhanced diagnostic function
- Easy to clean connections at the rear

CP string extension

- Additional valve terminals or
 - Electrical I/O modules.
- Additional information
➔ Internet: ctec

Valve terminals CDVI, Clean Design

Key features

The features

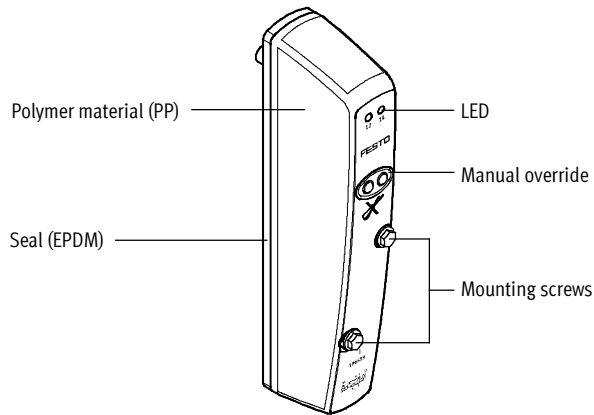

The ideal range for the food industry

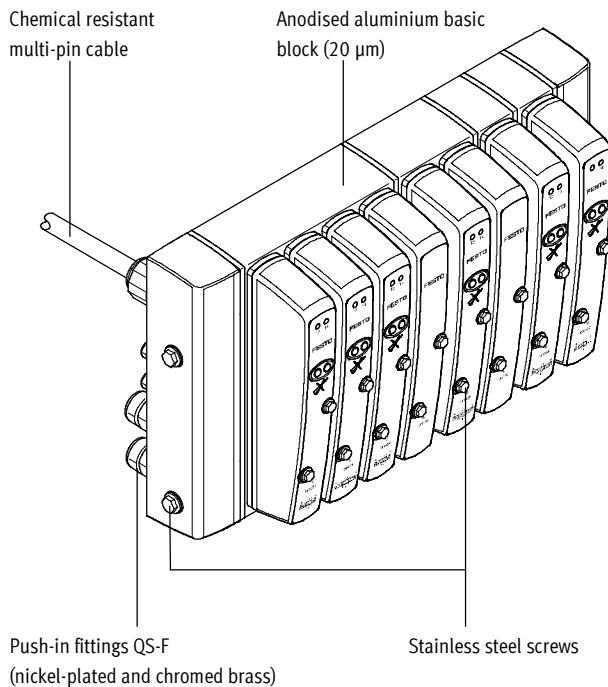

Choose from

- a wide range comprising actuators to accessories in corrosion resistant designs that are easy to clean,
- as well as valves,
- stainless steel fittings and flow control valves and
- tubing approved for use in the food industry.

All have been tested using cleaning agents from leading manufacturers.

The accessories

Tubing PLN



Push-in fitting QS-F/QSL-F...

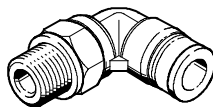
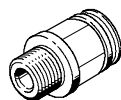

You should only use accessories that have been suggested by Festo. This is the only way of ensuring optimum performance from the CDVI in the following areas:

- Resilience
- Corrosion resistance class
- Ease of cleaning

Valve terminals CDVI, Clean Design

Key features

Individual connection

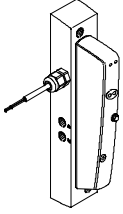

Valves can also be used on individual sub-bases for actuators further away from the valve terminal.

The electrical connection is established via a 10 m pre-assembled PVC cable.

Multi-pin plug connection

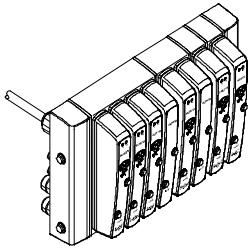

Control signals from the controller to the valve terminal are transmitted via a pre-assembled multi-wire cable or a self-assembly multi-pin plug connection, which substantially reduces installation time.

Valve terminals with multi-pin plug connections can be equipped with 4 to 16 valve positions with max. 24 solenoid coils.

Designs

- Multi-pin cable, 5 m long, pre-assembled with open wire ends
- Multi-pin cable, 10 m long, pre-assembled with open wire ends

Fieldbus connection

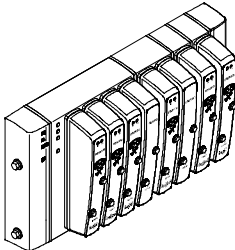

An integrated fieldbus node manages the communication connection to a higher-order PLC. This enables a space-saving pneumatic and electronic solution.

Valve terminals with fieldbus interfaces can be equipped with 4 to 16 valve positions with max. 24 solenoid coils.

Designs

- DeviceNet connection 2x M12
- Ethernet Powerlink on request

 Note

The basic blocks of the valve terminals can be extended by a maximum of 8 valve positions. The extension modules used are of no relevance here.

Valve terminals CDVI, Clean Design

Key features

CP string extension

The optional string extension enables an additional valve terminal and I/O modules to be connected to Fieldbus Direct. A CP string of the CPI installation system is integrated in the fieldbus node as an extension. Different input and output modules as well as CPV and CPA valve terminals can be connected.

The maximum length of the CP string extension is 10 metres, which means that the extension modules can be mounted directly on-site. All of the required electrical signals are transmitted via the CP cable, which in turn means that no further installation is needed on the extension module.

The CP string interface offers:

- 16 input signals
- 16 output signals for output modules 24 V DC or solenoid coils
- Logic and sensor supply for the input modules
- Load voltage supply for the valve terminals
- Logic supply for the output module

Additional information

→ Internet: ctec

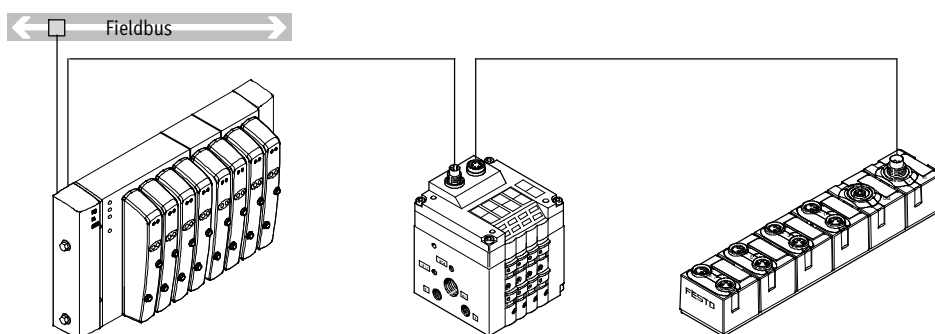

- - Note

Valve terminals can be ordered quickly and easily online.

The convenient product configurator can be found on:

→ Internet: cdvi

Valve terminals CDVI, Clean Design

Peripherals overview

FESTO

Overview – Clean Design valve terminal

Individual sub-base

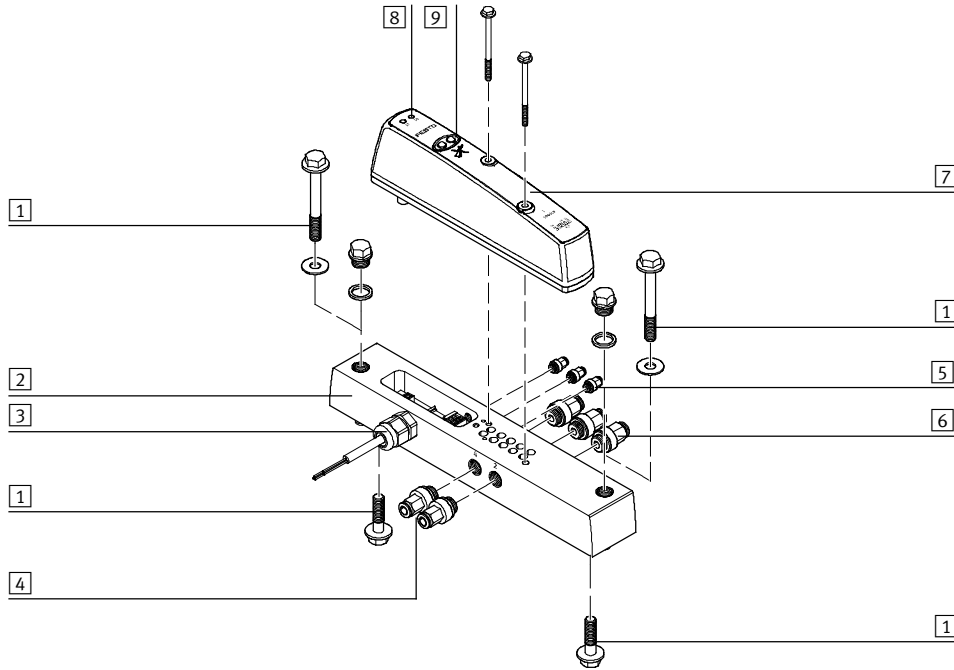

	Brief description	→ Page/Internet	
1	Mounting kit	Mounting from above or below	35
2	Sub-base for individual valve	–	32
3	Individual electrical connection	–	–
4	Push-in fitting	For working lines	35
5	Push-in fitting	For pilot air supply and venting, venting hole	35
6	Push-in fitting	For compressed air supply and venting	35
7	Valve	–	32
8	LED display	–	–
9	Manual override	For each solenoid coil, non-detenting	–

All valves on the valve terminal CDVI can be assembled on the individual sub-base CDSV. The individual sub-base CDSV has a connection for external pilot air supply, is pre-assembled with valve and 10 m PVC cable and is fully inspected before shipment.

Assembled push-in fittings included on request. A Clean Design mounting kit comprising two screws (18 mm and 40 mm) and two stainless steel blanking plugs permits mounting from above or below. If you have included fittings with your order, the pressure

compensation hole is also equipped with a QS fitting. The collected exhaust air from the pilot solenoid coils of the valves is drawn off via the pressure compensation hole (venting hole) on the rear side.

 Note
All ports and mounting holes that are not required must be sealed with a blanking plug.
Exception: venting hole

Valve terminals CDVI, Clean Design

Peripherals overview

Overview – Clean Design valve terminal

Valve terminal with multi-pin plug connection

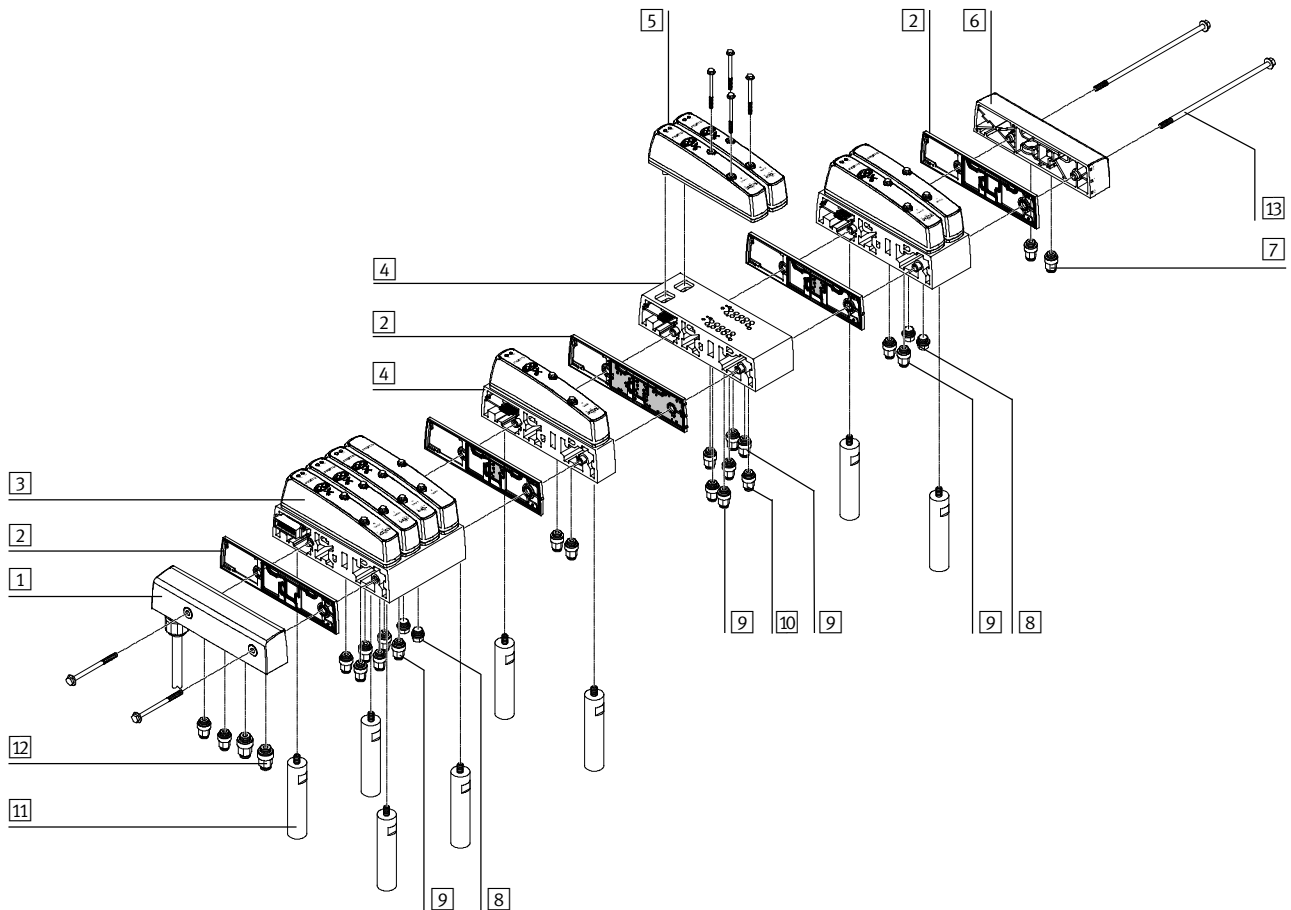

	Brief description	→ Page/Internet
1	Left-hand end plate With multi-pin plug connection	34
2	Separator plate	34
3	4/8-valve basic block	33
4	Extension module/power supply module	33
5	Valves	32
6	Right-hand end plate	34
7	Push-in fitting	For right-hand end plate
8	Blanking plug	35
9	Push-in fitting	For working lines
10	Push-in fitting	For power supply module
11	Spacer bolt	35
12	Push-in fitting	For left-hand end plate
13	Screw kit	For attaching the extension modules to the basic block

The collected exhaust air from the pilot solenoid coils of the valves is drawn off via the pressure compensation hole (venting hole) on the rear side.

If you have included fittings with your order, the pressure compensation hole is also equipped with a QS fitting.

If extension modules are added to the valve terminal later, the appropriate screw kit must be ordered (page 35).

 Note
All ports and mounting holes that are not required must be sealed with a blanking plug.
Exception: venting hole

Valve terminals CDVI, Clean Design

Peripherals overview

FESTO

Overview – Clean Design valve terminal

Valve terminal with fieldbus connection

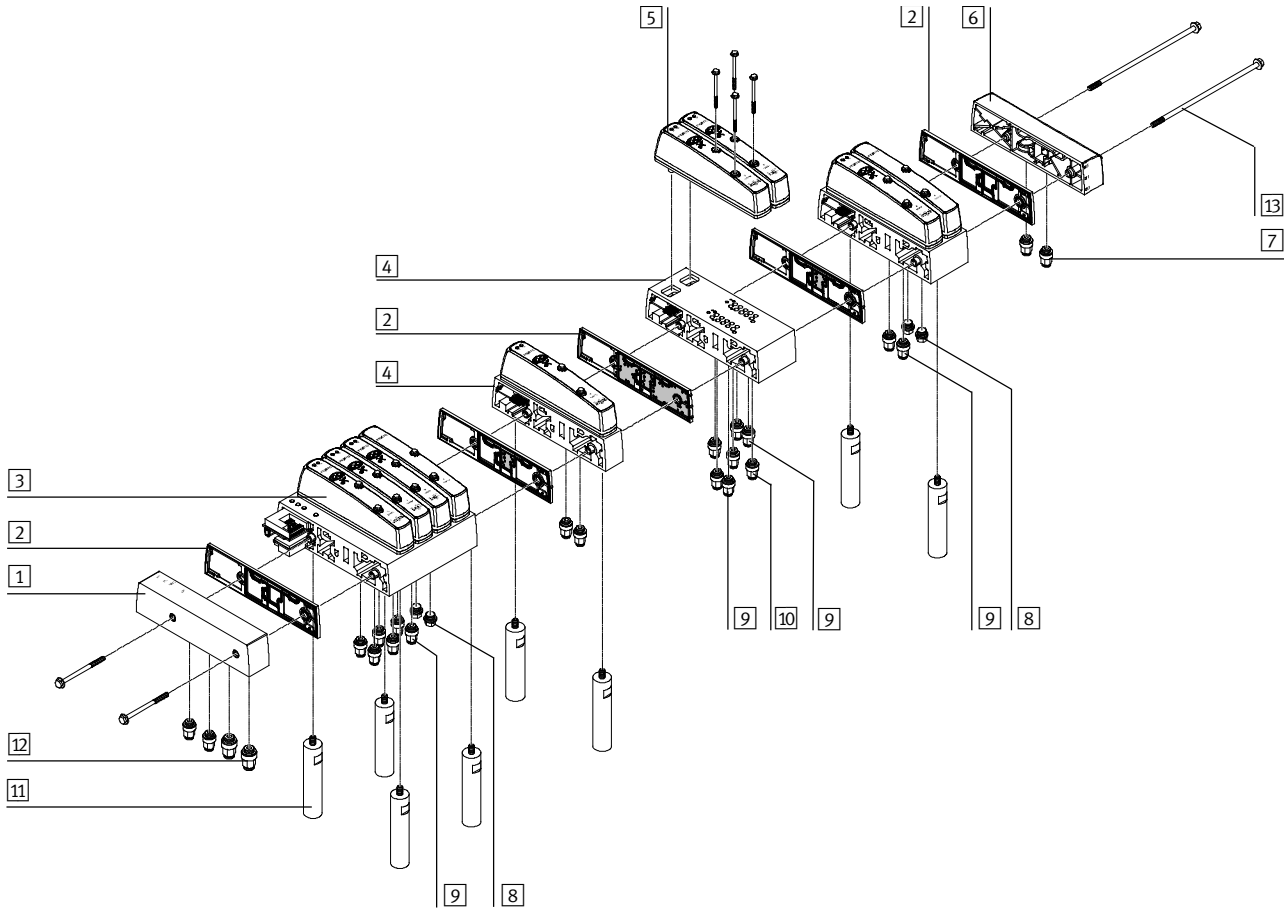

	Brief description	→ Page/Internet
1	Left-hand end plate With fieldbus connection	34
2	Separator plate	34
3	4/8-valve basic block	33
4	Extension module/power supply module	33
5	Valves	32
6	Right-hand end plate	34
7	Push-in fitting	For right-hand end plate
8	Blanking plug	35
9	Push-in fitting	For working lines
10	Push-in fitting	For power supply module
11	Spacer bolt	35
12	Push-in fitting	For left-hand end plate
13	Screw kit	For attaching the extension modules to the basic block

The collected exhaust air from the pilot solenoid coils of the valves is drawn off via the pressure compensation hole (venting hole) on the rear side.

If you have included fittings with your order, the pressure compensation hole is also equipped with a QS fitting.

If extension modules are added to the valve terminal later, the appropriate screw kit must be ordered (page 35).



Note

All ports and mounting holes that are not required must be sealed with a blanking plug.
Exception: venting hole

Valve terminals CDVI, Clean Design

Key features – Pneumatic components

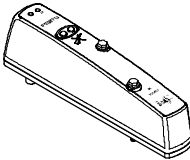
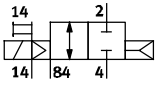
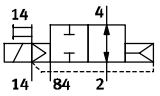
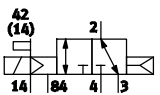
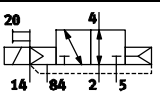
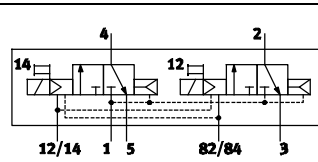
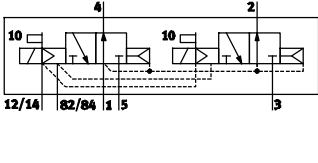
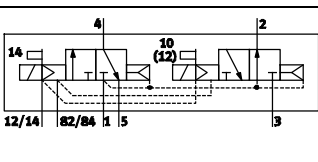
Valves			
	Code	Circuit symbol	Description
	R		2/2-way single solenoid valve <ul style="list-style-type: none"> • Normally closed • Pneumatic spring return • Suitable for vacuum • Supplied externally with supply air
	S		2/2-way single solenoid valve <ul style="list-style-type: none"> • Normally open • Pneumatic spring return • Suitable for vacuum • Supplied externally with supply air
	X		3/2-way single solenoid valve <ul style="list-style-type: none"> • Normally closed • Pneumatic spring return • Suitable for vacuum • Supplied externally with supply air
	W		3/2-way single solenoid valve <ul style="list-style-type: none"> • Normally open • Pneumatic spring return • Suitable for vacuum • Supplied externally with supply air
	K		2x 3/2-way single solenoid valve <ul style="list-style-type: none"> • Normally closed • Pneumatic spring return • Not suitable for vacuum
	N		2x 3/2-way single solenoid valve <ul style="list-style-type: none"> • Normally open • Pneumatic spring return • Not suitable for vacuum
	H		2x 3/2-way single solenoid valve <ul style="list-style-type: none"> • 1x normally closed, 1x normally open • Pneumatic spring return • Not suitable for vacuum

-  - Note

A filter must be installed upstream of valves operated in vacuum mode. This prevents any foreign matter in the intake air getting into the valve (e.g. when operating a suction cup).

Valve terminals CDVI, Clean Design

Key features – Pneumatic components

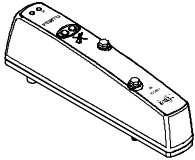
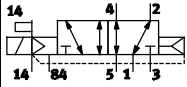
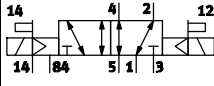
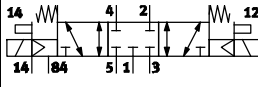
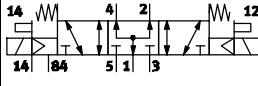
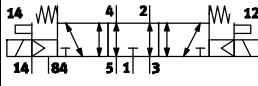
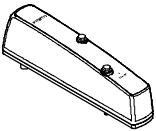
Valves and cover			
	Code	Circuit symbol	Description
	M		5/2-way single solenoid valve <ul style="list-style-type: none"> • Pneumatic spring return • Suitable for vacuum
	J		5/2-way double solenoid valve <ul style="list-style-type: none"> • Suitable for vacuum
	G		5/3-way valve <ul style="list-style-type: none"> • Mid-position closed • Mechanical spring return • The piston rod side of the cylinder remains under pressure in the normal valve position • Suitable for vacuum
	B		5/3-way valve <ul style="list-style-type: none"> • Mid-position pressurised • Mechanical spring return • The piston rod of the cylinder advances when the valve is in the normal position due to the differential piston areas • Suitable for vacuum
	E		5/3-way valve <ul style="list-style-type: none"> • Mid-position exhausted • Mechanical spring return • In the normal valve position, the piston rod can be moved freely • Suitable for vacuum
	A	Cover for valve position	For valve terminal only

Valve terminals CDVI, Clean Design

Key features – Pneumatic components

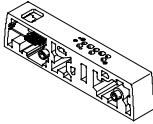
1-valve extension modules (valve terminal only)			
	Code	Designation	Description
	B1	Extension module for 1 valve position	Without additional pneumatic supply
	D1	Extension module for 1 valve position	Duct 1 separated with separating seal on left for creating a pressure zone with separate supply air
	F1	Extension module for 1 valve position	Ducts 3 and 5 separated with separating seal on left
	H1	Extension module for 1 valve position	Ducts 1, 3 and 5 separated with separating seal on left for creating a pressure zone with separate supply and exhaust air
	T	Only one solenoid coil per valve position	

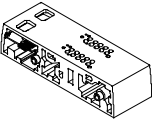
2-valve extension modules (valve terminal only)			
	Code	Designation	Description
	B	Extension module for 2 valve positions	Without additional pneumatic supply
	D	Extension module for 2 valve positions	Duct 1 separated with separating seal on left for creating a pressure zone with separate supply air
	F	Extension module for 2 valve positions	Ducts 3 and 5 separated with separating seal on left
	H	Extension module for 2 valve positions	Ducts 1, 3 and 5 separated with separating seal on left for creating a pressure zone with separate supply and exhaust air
	K	Extension module for 2 valve positions	Duct 1 separated with separating seal on left with separate supply port for creating pressure zones
	I	Extension module for 2 valve positions	Ducts 1, 3 and 5 separated with separating seal on left with separate supply and exhaust ports for creating pressure zones
	T	Only one solenoid coil per valve position	

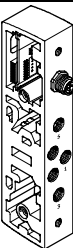
Additional function for 1 and 2-valve extension modules (valve terminal only)			
	Code	Designation	Description
	V	Extension module with separate electrical power supply	Only in combination with fieldbus
	P	Extension module with separate supply and exhaust ports	–
	C	Extension module with separate electrical power supply as well as separate supply and exhaust ports	Only in combination with fieldbus

- Note

The structure of the valve terminal with extension modules and their additional functions can be conveniently defined using the product configurator. You can find it on:

→ Internet: cdvi

Valve terminals CDVI, Clean Design

Key features – Pneumatic components



Modularity

Consistently modular valve terminal in a grid of 4 ... 16 valve positions/ 8 ... 24 solenoid coils. See sample representation on right.

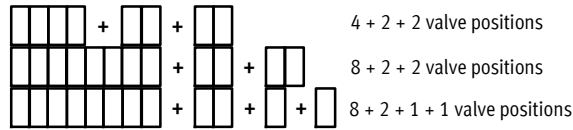

Pilot air supply

The valves used are pneumatically piloted solenoid valves. The ports on the valve terminal differ for the following pilot air supply types:

- internal pilot air supply
- external pilot air supply

The pilot air supply duct 12/14 is supplied from the duct 1 supply air (internal pilot air supply) or via a separate pilot air supply in the left-hand end plate (external pilot air supply).

A separate pilot air supply is required in any event if supply pressure is less than 3 bar or greater than 8 bar. In this case it is advisable to restrict the pilot air supply to max. 8 bar with a suitable regulator.

The pilot air supply is selected by including a corresponding code letter in the order code (end plates/ compressed air supply code U, V, Y, Z).

Pneumatic pressure zones

CDVI offers a number of options for creating pressure zones, if different working pressures are required.

Pressure zones are created by isolating the internal supply ducts between the basic block and extension module or by using extension modules with separate supply ports with an appropriate separator plate.

A maximum of two different pressure zones can be created on valve terminals with one extension module without separate supply port. The compressed air is supplied at both ends through the end plates. Up to three different pressure zones can be created on valve terminals with two extension modules. In this case, the compressed air is supplied via the two end plates as well as via the first extension module with separate supply port.

If more than three pressure zones are required, extension modules with a separate supply port must be used. Up to nine pressure zones are possible taking into consideration the maximum valve positions and number of coils. In this case, the compressed air is supplied via the two end plates as well as via the separate supply ports of the respective extension modules.

Separator plates are integrated ex-works as per your order. Separator plates can be distinguished through their coding, even when the valve terminal is assembled. A label on the right-hand end plate makes it easier to allocate the separator plates when the valve terminal is assembled.

Separator plates		
Pictorial examples	Coding	Notes
		Separator plate No duct separation
		Separator plate Duct 1 separated Ducts 3 and 5 open
		Separator plate Duct 1 open Ducts 3 and 5 separated
		Separator plate Ducts 1, 3 and 5 separated

- - Note
Normally only duct 1 is closed.
Ducts 3 and 5 or 1, 3 and 5 can also be closed for special applications.

Valve terminals CDVI, Clean Design

Key features – Pneumatic components

Examples: Compressed air supply and pilot air supply

Internal pilot air supply

Code U, Y

The diagram opposite shows an example of the configuration and connection of the compressed air supply with internal pilot air supply. Port 12/14 on the left-hand end plate is tightly sealed. The pilot air is supplied internally via the right-hand end plate.

Separator plates can be used optionally to create pressure zones.

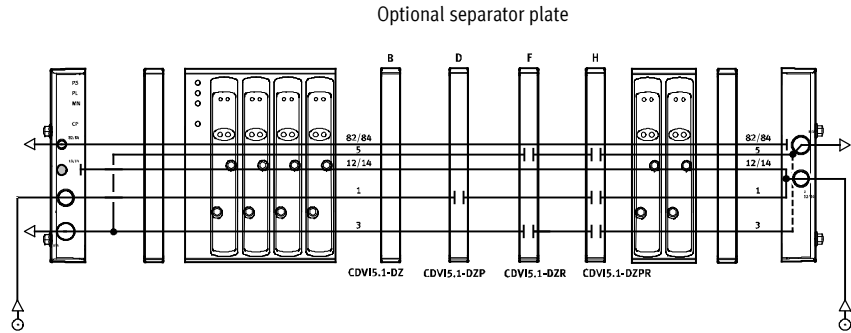

External pilot air supply

Code V, Z

The diagram opposite shows an example of the configuration and connection of the compressed air supply with external pilot air supply. Port 12/14 on the left-hand end plate is equipped with a fitting for this purpose.

Separator plates can be used optionally to create pressure zones. In this case it is advisable to restrict the pilot air supply to max. 8 bar with a suitable regulator.

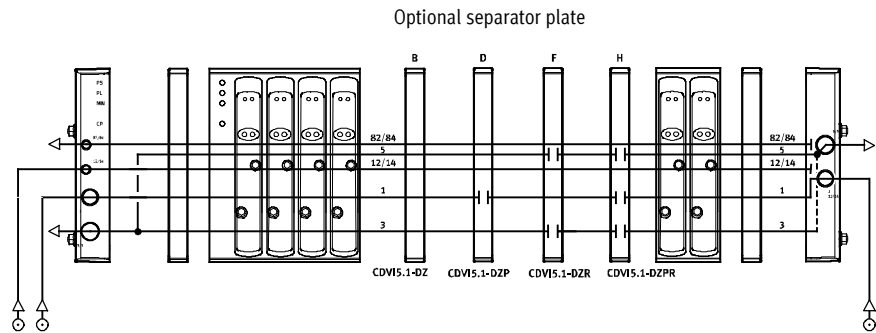

Creation of pressure zones

The CDVI facilitates the creation of up to 9 pressure zones. The diagram opposite shows an example of the configuration and connection of three pressure zones using separator plates with an external pilot air supply of 3 ... 8 bar.

Note

Particular attention must be paid to the assembly of the right-hand end plate when converting a valve terminal from internal to external pilot air supply.

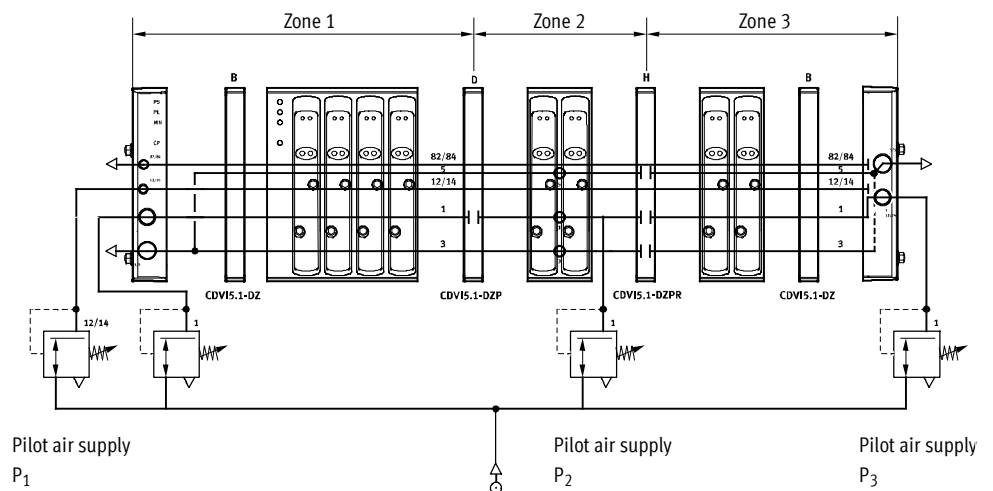

Valve terminals CDVI, Clean Design

Key features – Pneumatic components

Mounting

Individual sub-base

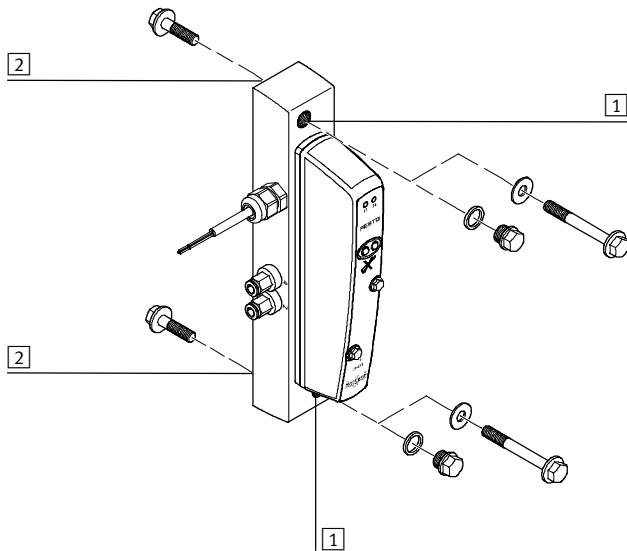

- 1 Hole for front mounting (CDSV) using M6 screws; the hole can be covered with blanking plug G1/8 if not required
- 2 Hole for rear mounting (CDSV) using M6 screws

Valve terminal

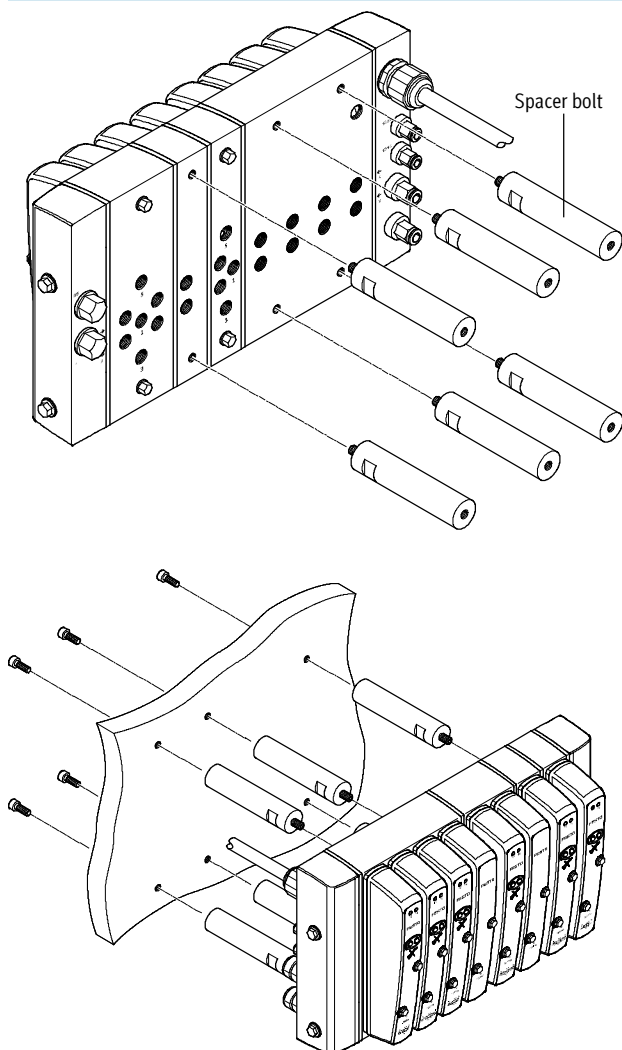

The CDVI can be mounted directly on earthed mounting surfaces using the four threaded holes in the basic block and the spacer bolts ordered via the order code (accessories order code Y).

The CDVI can be mounted in any position. However, the selected mounting position should allow for the cleaning off of dirt and the draining of cleaning agent.

 Note

If extension modules are added to the valve terminal at a later stage, the following points must be observed:

- Basic block:
Always attach using 4 spacer bolts
- Extension modules:
After the second module, max. 4 extension modules between 2 attachment points
- Appropriate screw kit for attaching the extension modules to the basic block (page 35)

Valve terminals CDVI, Clean Design

Key features – Pneumatic components

Manual override (MO)

Manual override with automatic return (non-detenting)

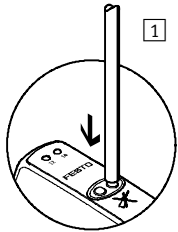

- 1 Press in the stem of the manual override with a pointed object. Valve is then actuated.

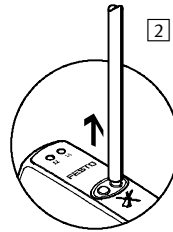

- 2 Remove the pointed object. Mechanical force pushes the stem of the manual override back. Valve returns to initial position (not with 5/2-way double solenoid valve, code J).

Display and control elements

Individual sub-base

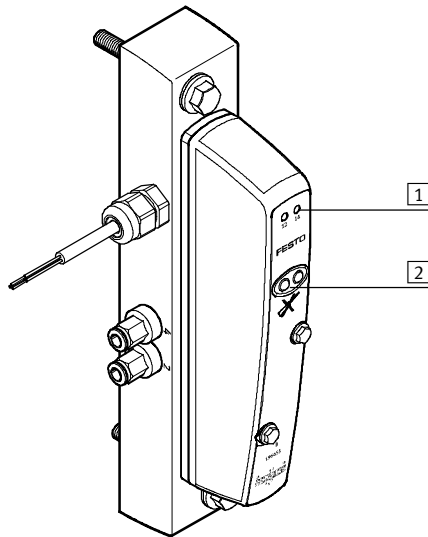

- 1 Yellow LEDs (one per solenoid coil)
- 2 Non-detenting manual override (per solenoid coil)

Valve terminal

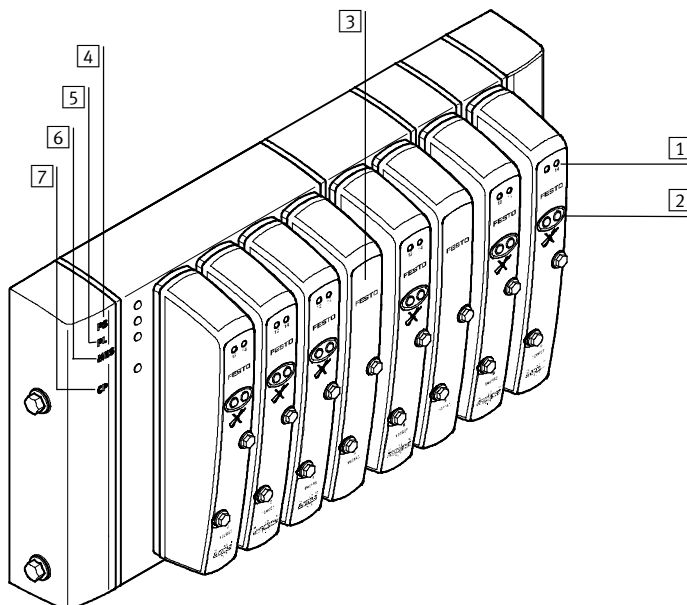

- 1 Yellow LEDs (one per solenoid coil)
- 2 Non-detenting manual override (per solenoid coil)
- 3 Vacant valve position with blanking plate

With fieldbus:

- 4 Green PS LED
"Power System"
Operating voltage of electronics
- 5 Green PL LED
"Power Load"
Load voltage of valves
- 6 Green/red MNS LED
"Module/Network Status"
- 7 Green/red CP LED
"Compact Performance"
CP extension modules

Valve terminals CDVI, Clean Design

Key features – Pneumatic components



Connections

Individual sub-base

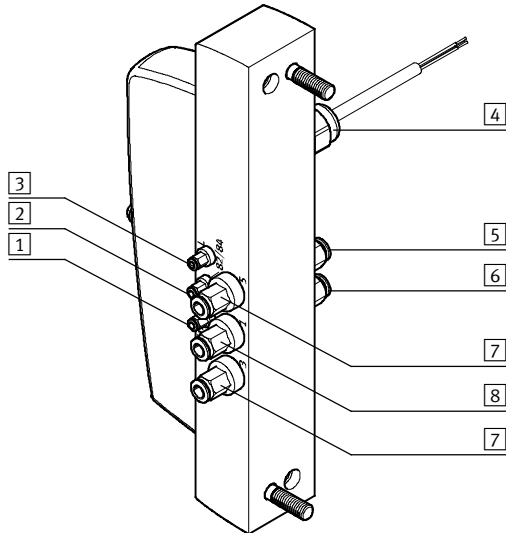

- 1 Pilot air supply port 12/14
- 2 Pilot exhaust port 82/84
- 3 Pressure compensation port/venting hole
- 4 Electrical connection
- 5 Working line 4 per valve
- 6 Working line 2 per valve
- 7 Exhaust port 3/5
- 8 Supply port 1

Valve terminal

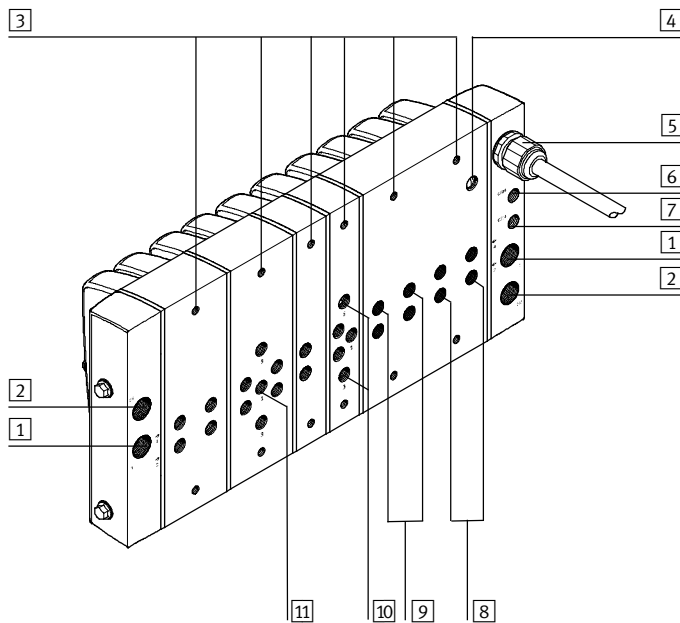

- 1 Supply port 1
- 2 Exhaust port 3/5
- 3 Threaded holes for spacer bolts (top and bottom)
- 4 Pressure compensation port/venting hole
- 5 Electrical multi-pin plug connection
- 6 Pilot exhaust port 82/84
- 7 Pilot air supply port 12/14
- 8 Working line 2 per valve
- 9 Working line 4 per valve
- 10 Exhaust ports 3 + 5 with extension module
- 11 Supply port 1 with extension module

Line		Port code (ISO 5599)	Connection size (ISO 228)	Connector fitting ¹⁾
Supply air/vacuum	1	1	G $\frac{3}{8}$	In the left-hand/right-hand end plate
	11	1	G $\frac{1}{8}$	In the extension module with additional supply
Exhaust air	2	3/5	G $\frac{3}{8}$	In the left-hand/right-hand end plate
	10	3, 5	G $\frac{1}{8}$	In the extension module with additional supply
Pressure compensation	4	–	G $\frac{1}{8}$	In the basic block
Pilot exhaust air	6	82/84	G $\frac{1}{8}$	In the left-hand end plate
Pilot air supply	7	12/14	G $\frac{1}{8}$	In the left-hand end plate
Working line/vacuum	8	2, 4	G $\frac{1}{8}$	In the basic block
	9	2, 4	G $\frac{1}{8}$	In the extension module with additional supply

1) The CDVI valve terminal can be pre-equipped with QS-F push-in fittings depending on the order.

Valve terminals CDVI, Clean Design

Key features – Electrical components

Electrical power as a result of current reduction

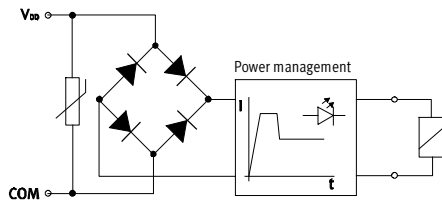

Each solenoid coil is protected with a spark arresting protective circuit as well as against polarity reversal. All valve types are also equipped with

integrated current reduction.

Advantages:

- Lower power consumption
- Lower temperature rise

Terminal allocation – Cable for individual sub-base CDSV

Core colour	Allocation
Brown	Solenoid coil 14
Black	Solenoid coil 12 (not on 5/2-way single solenoid valve)
Blue	com ¹⁾

1) 0 V for positive switching valves; 24 V can be connected for negative switching control signals

Terminal allocation – Multi-pin cable¹⁾

Pin	Address	Valve position/solenoid coil		Wire colour ²⁾
		4-valve basic block	8-valve basic block	
A01	0	0/14	0/14	WH
A02	1	0/12	0/12	GN
B01	2	1/14	1/14	YE
B02	3	1/12	1/12	GY
C01	4	2/14	2/14	PK
C02	5	2/12	2/12	BU
A03	6	3/14	3/14	RD
A04	7	3/12	3/12	VT
B03	8	–	4/14	GY PK
B04	9	–	4/12	RD BU
C03	10	–	5/14	WH GN
C04	11	–	5/12	BN GN
A05	12	–	6/14	WH YE
A06	13	–	6/12	YE BN
B05	14	–	7/14	WH GY
B06	15	–	7/12	GY BN
C05	16	–	–	WH PK
C06	17	–	–	PK BN
A07	18	–	–	WH BU
A08	19	–	–	BN BU
B07	20	–	–	WH RD
B08	21	–	–	BN RD
C07	22	–	–	WH BK
C08	23	–	–	BN BK
B10	com	0 V ³⁾	0 V ³⁾	BN
C10	com	0 V ³⁾	0 V ³⁾	BK
–	–	–	–	GY GN ⁴⁾

1) Max. 24 solenoid coils

2) To IEC 757

3) 0 V for positive switching control signals; connect 24 V for negative switching control signals; mixed operation is not permitted.

4) This core is not used and can be cut off.

Valve terminals CDVI, Clean Design

Key features – Electrical components



Address allocation – Valves with multi-pin plug

A valve position on the CDVI valve terminal always occupies 2 addresses on the basic block, even if one of these is equipped with a blanking plate.

Addresses should be assigned in ascending consecutive order. The numbering goes from left to right.

A valve terminal extension occupies 2 addresses on an extension module for 1 valve position and 4 addresses for an extension module for 2 valve positions.

If the extension module is additionally configured with the option T (only one solenoid coil per valve position), only one address is occupied per valve position.

Example: Address allocation for a CDVI valve terminal with a basic block with 8 valves and 2 extension modules for 2 valve positions

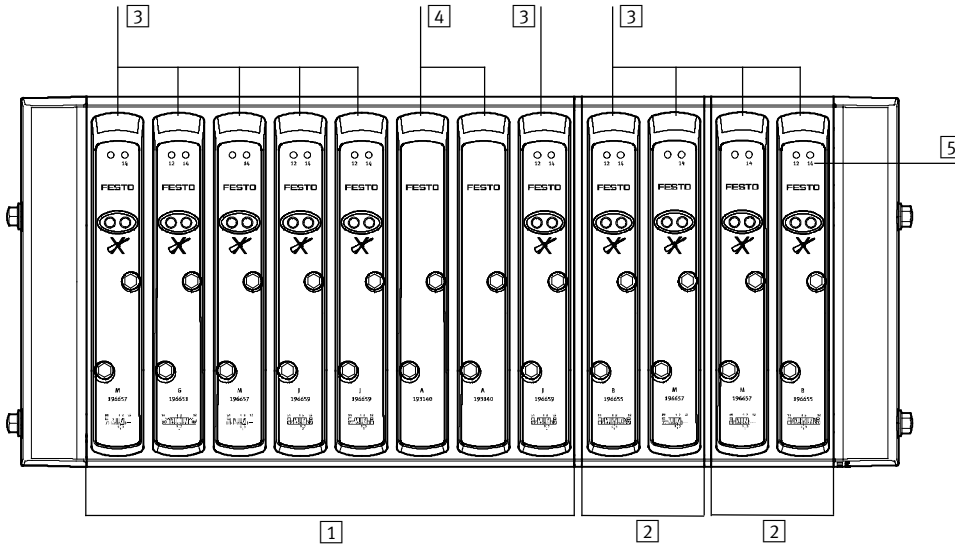

- 1 Basic block with 8 valve positions: 16 addresses
- 2 Extension module for 2 valve positions: 4 addresses
=> 24 addresses (coils)
- 3 Valves
- 4 Vacant positions
- 5 Number of the solenoid coil

Addressing order for valves with fieldbus

The CDVI valve terminal occupies 8, 16 or, depending on the extension, up to 24 addresses, regardless of the number of solenoid coils.

A 4-valve basic block occupies 8 addresses and an 8-valve basic block 16 addresses, while the 1-valve and 2-valve extension modules occupy 2 and 4 addresses respectively.

If a valve position is equipped with a valve with 2 pilot solenoid coils, the following allocation applies:

- Pilot solenoid coil 14 occupies the less significant address
- Pilot solenoid coil 12 occupies the more significant address

The more significant address is not used in valves with only one pilot solenoid coil.

The addresses of the CDVI valve terminal are allocated from left to right, while the addresses of the individual valve positions are allocated from right (pilot solenoid coil 14) to left (pilot solenoid coil 12).

Note
If the extension module is additionally configured with the option T (only one solenoid coil per valve position), only one address is occupied per valve position.

Example: Addressing order for a basic block with 4 valve positions and two extension modules for 2 valve positions

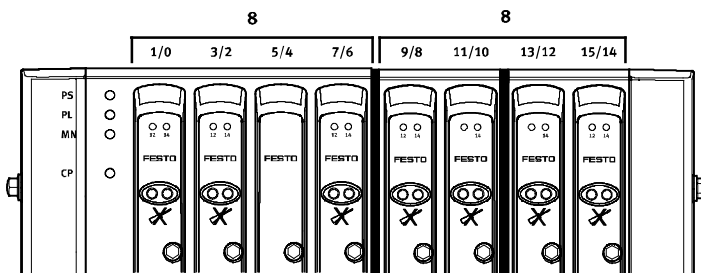

Note
Address shifts can occur if one expansion block is replaced by another type of expansion block. For example, replacing a 2-valve bi expansion block with a 2-valve mono expansion block shifts the address allocation to the right by 2 addresses.

Valve terminals CDVI, Clean Design

Key features – Electrical components

Fieldbus Direct

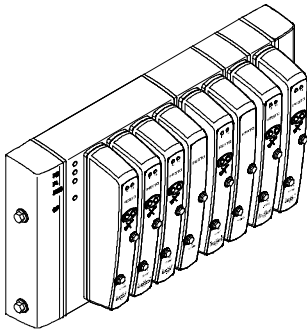

Fieldbus Direct is a system for the compact connection of a valve terminal of various sizes to different fieldbus standards.

The CP string extension option allows the functions and components of the CPI installation system to be used.

The I/O modules and cables for the CP string extension are ordered using the order code for the CPI installation system.

Additional information

➔ Internet: ctec

Enhanced fieldbus diagnostics

Enhanced diagnostics (supplied load voltage) is only possible with new basic blocks and new expansion blocks with additional electrical power supply (code C and V).

These new blocks can be identified by the 16-pin terminal strip (old = 12-pin) as well as the designation printed on the PCB. The green "Power Loss" LED on

the basic block flashes in the case of undervoltage/voltage failure of the additional power supply at the extension module (code C and V).



Note

Enhanced diagnostics is not possible with combinations of old and new expansion blocks.

Electrical voltage zones

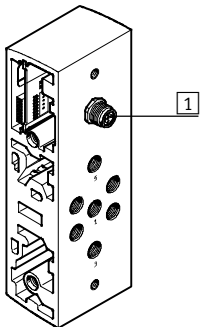

Up to 9 electrical voltage zones can be created with the help of extension modules with separate electrical power supply (code V and C), taking into consideration the maximum valve positions and number of coils.

By using an extension module with separate electrical power supply, the solenoid coils following to the right including the coils of the extension module are supplied separately with electrical power or disconnected separately.

1 Connection of separate electrical power supply

Valve terminals CDVI, Clean Design

Configuration and ident. code

Valve terminal configurator

Online via: → www.festo.com

A valve terminal configurator is available online to help you select a suitable CDVI valve terminal.

Like all valve terminals, the CDVI is ordered using an ident. code. This ident. code specifies the valve functions, the number of valves, vacant positions as well as the additional functions and the type of compressed air supply.

As is the case with all Festo products, all CDVI and CDSV are supplied:

- fully pre-assembled
- fitted with QS...-F fittings on the working lines and end plates on request
- tested for electrical function
- tested for pneumatic function

- securely packaged
- manuals can be downloaded free of charge

Ordering system for CDVI
→ Internet: cdvi

Example of an ident. code

15P - K10 - 4A - UR - 3MJ-B-JG - E + Y

Valve terminal family		15P	K10	4A	UR	3MJ-B-JG	E	+	Y
15P	CDVI								
Electrical connection			K10						
K10	Multi-pin plug, cable 10 m								
Valve positions/type of connection				4A					
4	Valves on basic block								
A	Straight push-in fittings, QS-8								
Pneumatic supply/type of seal					UR				
U	Supply at left, internal pilot air supply								
R	Resistant to cleaning agents								
Selected valve equipment...									
	...basic block (position 0 ... 3)								
3M	5/2-way single solenoid valve								
J	5/2-way double solenoid valve								
	...additional valves (position 4 and 5)								
B	Extension module for 2 valve positions								
J	5/2-way double solenoid valve								
G	5/3-way valve, mid-position closed								
Manual									
E	Manual in English								
Type of mounting									
Y	Spacer bolt, length 1								

Valve terminals CDVI, Clean Design

Instructions for use

FESTO

Equipment

Operate system equipment with unlubricated compressed air if possible. Festo valves and cylinders are designed so that, if used as designated, they will not require additional lubrication and will still achieve a long service life.

The quality of compressed air downstream from the compressor must correspond to that of unlubricated compressed air. If possible, do not operate all of your system equipment with lubricated compressed air. The lubricators should, where possible, always be installed directly upstream of the consuming actuator.

Incorrect additional oil and too high an oil content in the compressed air reduces the service life of a valve terminal.

Use Festo special oil OFSW-32 or the alternatives listed in the Festo catalogue (as specified in DIN 51524 HLP32; basic oil viscosity 32 CST at 40 °C).

Bio-oils

When using bio-oils (oils which are based on synthetic or native ester, e.g. rapeseed oil methyl ester), the maximum residual oil content of 0.1 mg/m³ must not be exceeded (see ISO 8573-1 Class 2).

Mineral oils

When using mineral oils (e.g. HLP oils to DIN 51524, parts 1 through 3) or similar oils based on poly-alpha-olefins (PAO), the maximum residual oil content of 5 mg/m³ must not be exceeded (see ISO 8573-1 Class 4). A higher residual oil content irrespective of the compressor oil cannot be permitted, as the basic lubricant would be flushed out over time.

Valve terminals CDVI, Clean Design

Technical data

-  - Flow rate
300 ... 650 l/min

-  - Valve width
24 mm

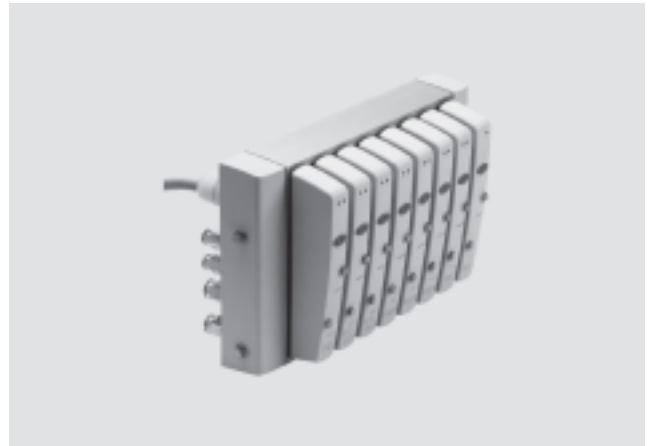

General technical data												
Valve function order code	R	S	X	W	K	N	H	M	J	G	B	E
Valve function	2/2-way solenoid valves		3/2-way solenoid valves		2x 3/2-way solenoid valves			5/2-way solenoid valves		5/3-way solenoid valves		
Reset method	Pneumatic spring		Pneumatic spring		Pneumatic spring			Pneumatic spring		Mechanical spring		
Direction of flow	Reversible		Reversible		Non-reversible			Reversible		Reversible		
Exhaust function	With flow control		With flow control		No flow control			With flow control		With flow control		
b value	0.34		0.34		0.14			0.38		0.5	0.37	0.5
c value [l/sbar]	2.05		2.05		1.4			2.75		2.55	3.2	1.54
Standard nominal flow rate [l/min]	500	300	500		300			650		650	650	400
Constructional design	Piston spool valve											
Actuation type	Electrical											
Sealing principle	Soft											
Width [mm]	24											
Nominal diameter [mm]	5											
Tightening torque of valve/blanking plate [Nm]	0.8											
Mounting position	Any											
Manual override	Non-detenting											
Max. number of valve locations	16 (max. 24 solenoid coils)											
Type of mounting												
Valves and end plate	Via 2 screws (DIN 6921)											
Valve terminal	Via spacer bolts											
Pneumatic connections												
Supply	1	G $\frac{3}{8}$ (G $\frac{1}{8}$ on extension module CDVI5.0-EBX and CDSV)										
Exhaust	3/5	G $\frac{3}{8}$ (G $\frac{1}{8}$ on extension module CDVI5.0-EBX and CDSV)										
Working lines	2/4	G $\frac{1}{8}$										
Pilot air supply	12/14	G $\frac{1}{8}$ (M5 on CDSV)										
Pilot exhaust air	82/84	G $\frac{1}{8}$ (M5 on CDSV)										
Pressure compensation	G $\frac{1}{8}$ (M5 on CDSV)											

Valve terminals CDVI, Clean Design

Technical data

Valve switching times [ms]													
Valve function order code		R	S	X	W	K	N	H	M	J	G	B	E
Switching times	on	10	10	10	10	10	10	10	12	–	12	12	12
	off	14	14	14	14	22	22	22	22	–	25	25	25
	change-over	–	–	–	–	–	–	–	–	10	17	17	17

Operating and environmental conditions													
Valve function order code		R	S	X	W	K	N	H	M	J	G	B	E
Operating medium		Compressed air in accordance with ISO 8573-1:2010 [7:4:4]											
Note on operating/pilot medium		Operation with lubricated medium possible (in which case lubricated operation will always be required)											
Operating pressure [bar]		–0.9 ... +10				3 ... 10 ²⁾			–0.9 ... +10				
Operating pressure for valve terminal with internal pilot air supply [bar]		3 ... 8 (not available on the CDSV)											
Pilot pressure [bar]		3 ... 8											
Storage temperature [°C]		–20 ... +40											
Operating temperature [°C]		–5 ... +50											
Temperature of medium [°C]		–5 ... +50											
CE mark (see declaration of conformity)		To EU EMC Directive											
Food industry approval		DIN EN ISO 14159											
Corrosion resistance class CRC ¹⁾		3											

- 1) Corrosion resistance class 3 as per Festo standard 940 070
Components subject to higher corrosion stress. Externally visible parts with primarily decorative surface requirements which are in direct contact with a normal industrial environment or media such as solvents and cleaning agents.
- 2) 2x 3/2-way valves not suitable for vacuum

Pilot pressure with external pilot air supply

Switch-on pilot pressure of 5/2-way and 5/3-way valves and 3/2-way valves with external air supply (EXT)

Switch-on pilot pressure of 3/2-way valves

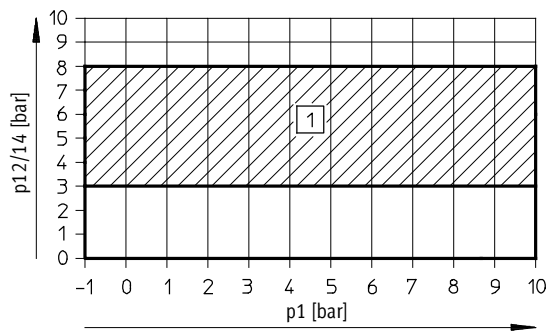

1) Permissible pressure range

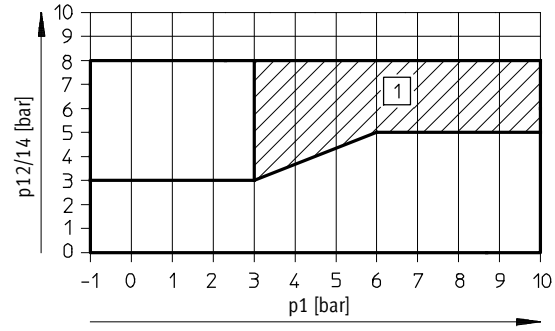

1) Permissible pressure range

Valve terminals CDVI, Clean Design

Technical data

Electrical data	
Electromagnetic compatibility	Interference immunity tested to EN 61000-6-2
Nominal operating voltage [V DC]	24, reverse polarity protected
Permissible voltage fluctuation [%]	±10
Residual ripple [Vss]	4
Switch-on current consumption	
• per solenoid coil at 24 V (with LEDs) [mA]	Typ. 120
• total at 24 V and max. number of solenoid coils (with LEDs) [A]	Typ. 2.88
Current consumption during operation	
• per solenoid coil at 24 V (with LEDs) [mA]	Min. 26
• total at 24 V and max. number of solenoid coils (with LEDs) [A]	Typ. 0.62
Electrical power consumption per solenoid coil (with LED) [W]	3.1
Duty cycle	100%
Protection class to EN 60529	IP65, IP66, IP67, NEMA 4 (fully assembled)

Multi-pin cable	
Cable design [mm ²]	25x0.34
Bending radius during flexible use	Min. 15x cable Ø
Outer Ø [mm]	Approx. 11.4

Materials													
Valve function order code	R	S	X	W	K	N	H	M	J	G	B	E	
Blanking plate	Polypropylene (PP), thermoplastic rubber (TPE), polyamide (PA)												
Manifold sub-base	Aluminium (anodised min. 20 µm)												
Blanking plug	Polybutylene terephthalate (material no.: 1.4303 or 1.4301)												
End plate	Polypropylene												
Screws	Polybutylene terephthalate (material no.: 1.4303 or 1.4301)												
Spacer bolt	Aluminium (anodised min. 20 µm)												
Valve	Aluminium, polyacetate (POM), polyphenylene sulphide (PPS), polyamide (PA), nitrile rubber (NBR), brass (Ms), steel (St), polycarbonate (PC), polypropylene (PP)												
Note on materials	RoHS-compliant												

Nominal flow rate [l/min]													
Valve function order code	R	S	X	W	K	N	H	M	J	G	B	E	
Pressurised	500	300	500	500	300	300	300	650	650	650	650	400	
Exhausted	500	300	500	500	300	300	300	650	650	650	400	650	
Mid-position	–	–	–	–	–	–	–	–	–	–	150	150	

Valve terminals CDVI, Clean Design

Technical data

Weight [g]	CDVI multi-pin plug	CDVI fieldbus
Basic block with 4 valve positions ¹⁾	1,050	1,320
Basic block with 8 valve positions ¹⁾	2,090	2,360
Extension module for 1 valve position with/without additional supply ²⁾	255	255
Extension module for 2 valve positions with/without additional supply ²⁾	510	510
Valve	185 ... 210	
Blanking plate	85	
Left-hand/right-hand end plate	120	
Separator plate	30-40	
CDSV individual sub-base ³⁾	690	
Spacer bolt (2 pieces)	160	
Connecting cable per metre	168	

- 1) Basic block, without: separator plates, right-hand and left-hand end plates, pneumatic fittings, cables, valves and cover plates.
 2) Extension module, without: separator plate, pneumatic fittings, valves and cover plates.
 3) Individual sub-base, without: pneumatic fittings and valve.

Dimensions Download CAD data → www.festo.com

Individual sub-base

1) Choice of single solenoid or double solenoid valve
 2) Manifold sub-base
 3) Manual override
 4) Cable connector M20x1.5
 5) For mounting from below:
 2x screw M6x18-A2-80
 2x sealing ring CRO-M6
 2x blanking plug G¹/₈
 2x sealing ring G¹/₈
 6) For mounting from above:
 2x screw M6x40-A2-80
 2x sealing ring CRO-M6

Type	B1	B2	B3	B4	D1	D2	H1	H2	H3	H4	H5	H6	H7	H8
CDSV	34	21	11.5	12	G ¹ / ₈	M5	67.6	41.9	37.5	27	18	21	9	15

Type	L1	L2	L3	L4	L5	L6	L7	L8	L9	L10	L11	L12	L13	L14	L15
CDSV	207	181	158	140.9	130.6	114.5	102.1	122.6	110.6	104.4	97.1	83.6	61.4	41	13

Valve terminals CDVI, Clean Design

Technical data

Type	B1	B2	B3	B4	B5	B6	B7	B8	B9	B10	B11	B12	B13	B14	B15	B16	B17	B18	B19	B20
CDVI5.0-...-MP	170	158	143	113.5	140	95.5	97	95	84.1	89	68.5	75	67.5	55	41	40	29.5	27.5	18	15

Type	D1	D2	D3	D4	H1	H2	H3	H4	T1	T2
CDVI5.0-...-MP	20	G3/8	G1/8	M6	170	80	41.9	37.5	12	9.5

Type		Number of valve locations												
		1 ... 4	5	6	7	8	9	10	11	12	13	14	15	16
Valve terminal with CDVI5.0-GB4-MP	L1	190.8	220.3	249.8	279.3	308.8	338.3	367.8	397.3	426.8	456.3	485.8	515.3	544.8

Type		Number of valve locations								
		1 ... 8	9	10	11	12	13	14	15	16
Valve terminal with CDVI5.0-GB8-MP	L1	302.8	332.3	361.8	391.3	420.8	450.3	479.8	509.3	538.8

Type	L2	L3	L4	L5	L6	L7	L8	L9	L10	L11	L12	L13	L14	L15	L16	L17	L18	L19
Valve terminal with CDVI5.0-GB4-MP	56	118	56	39.4	33	28	47	26.5	18.3	15	14	13.3	13	12	9.5	6.8	6.4	3
Valve terminal with CDVI5.0-GB8-MP	168																	

Valve terminals CDVI, Clean Design

Technical data

FESTO

Dimensions

Download CAD data → www.festo.com

Basic block with 4 valve positions and extension modules, design with fieldbus connection

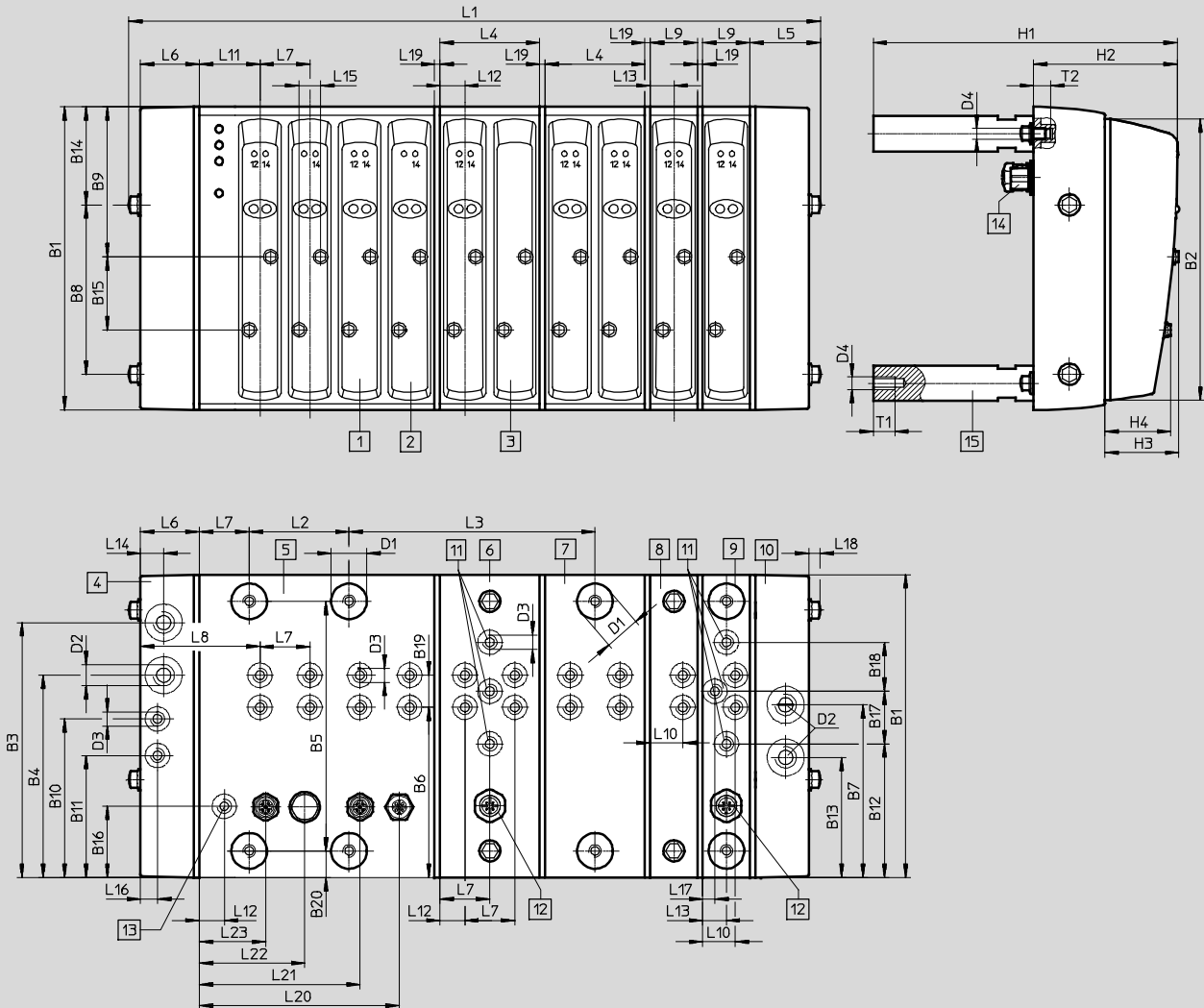

- | | | | |
|----------------------------------|---|---|--|
| 1 Double solenoid valve | 6 2-valve extension module, optionally with additional electrical and/or pneumatic power supply | 10 Right-hand end plate | 15 Threaded pin required after every second extension module. An extension module may protrude without attachment. |
| 2 Single solenoid valve | 7 2-valve extension module | 11 Port for further pressure zones or additional pneumatic power supply | |
| 3 Blanking plate | 8 1-valve extension module | 12 Port for further electrical voltage zones M12, 4-pin | |
| 4 Left-hand end plate | 9 1-valve extension module, optionally with additional electrical and/or pneumatic power supply | 13 Venting hole | |
| 5 4-valve or 8-valve basic block | | 14 Bus connection | |

Valve terminals CDVI, Clean Design

Technical data

Type	B1	B2	B3	B4	B5	B6	B7	B8	B9	B10	B11	B12	B13	B14	B15	B16	B17	B18	B19	B20
CDVI5.0-...-DN	170	158	143	113.5	140	95.5	97	95	84.1	89	68.5	75	67.5	55	41	40	29.5	27.5	18	15

Type	D1	D2	D3	D4	H1	H2	H3	H4	T1	T2
CDVI5.0-...-DN	20	G3/8	G1/8	M6	170	80	41.9	37.5	12	9.5

Type		Number of valve locations												
		1 ... 4	5	6	7	8	9	10	11	12	13	14	15	16
Valve terminal with CDVI5.0-GB4-DN	L1	210.8	240.3	269.8	299.3	328.8	358.3	367.8	417.3	446.8	476.3	505.8	535.3	564.8

Type		Number of valve locations								
		1 ... 8	9	10	11	12	13	14	15	16
Valve terminal with CDVI5.0-GB8-DN	L1	322.8	352.3	381.8	411.3	440.8	470.3	499.8	529.3	558.3

Type	L2	L3	L4	L5	L6	L7	L8	L9	L10	L11	L12
Valve terminal with CDVI5.0-GB4-DN	56	138	56	39.4	33	28	67	26.5	18.3	34	14
Valve terminal with CDVI5.0-GB8-DN	168										

Type	L13	L14	L15	L16	L17	L18	L19	L20	L21	L22	L23
Valve terminal with CDVI5.0-GB4-DN	13.3	13	12	9.5	6.8	6.4	3	112.2	90.2	59.2	37.2
Valve terminal with CDVI5.0-GB8-DN											

Valve terminals CDVI, Clean Design



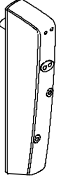
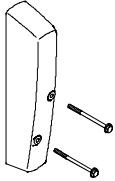
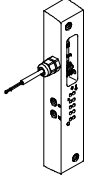

FESTO

Accessories

Ordering data				
	Code	Description	Part No.	Type
Individual sub-base valve				
	R	2/2-way single solenoid valve, single solenoid normally closed, external supply air	556379	CDVI5.0-MT2H-1X2GLS-EXT
	S	2/2-way single solenoid valve, single solenoid normally open, external supply air	556380	CDVI5.0-MT2H-1X2OLS-EXT
	X	3/2-way valve, single solenoid normally closed, external supply air	547013	CDVI5.0-MT2H-1X3GLS-EXT
	W	3/2-way valve, single solenoid normally open, external supply air	547014	CDVI5.0-MT2H-1X3OLS-EXT
	K	2x 3/2-way valve, single solenoid normally closed	196661	CDVI5.0-MT2H-2x3GLS
	N	2x 3/2-way valve, single solenoid normally open	196663	CDVI5.0-MT2H-2x3OLS
	H	2x 3/2-way valve, single solenoid 1x normally open, 1x normally closed	196665	CDVI5.0-MT2H-3OLS-3GLS
	M	5/2-way valve, single solenoid	196657	CDVI5.0-MT2H-5LS
	J	5/2-way valve, double solenoid	196659	CDVI5.0-MT2H-5JS
	G	5/3-way valve, mid-position closed	196651	CDVI5.0-MT2H-5/3GS
	B	5/3-way valve, mid-position pressurised	196655	CDVI5.0-MT2H-5/3BS
	E	5/3-way valve, mid-position exhausted	196653	CDVI5.0-MT2H-5/3ES
	A	Blanking plate for vacant valve position Valve terminal only	193140	CDVI5.0-A-P-2
Sub-bases				
	1	Sub-base, individual connection	534434	CDSV5.0-AS-1/8

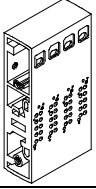
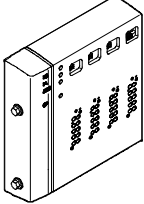
Valve terminals CDVI, Clean Design

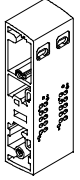



Accessories

Ordering data				
	Code	Description	Part No.	Type
Basic block for multi-pin plug				
	4	With 4 valve positions	196714	CDV15.0-GB4-MP
	8	With 8 valve positions	196690	CDV15.0-GB8-MP
Basic block for fieldbus				
	4	With 4 valve positions	535840	CDV15.0-GB4-DN
	8	With 8 valve positions	535839	CDV15.0-GB8-DN
Extension modules for 1 valve position, multi-pin plug				
	B1, D1, F1, H1	Single solenoid	548422	CDV15.0-EB1-MP-MO
	B1, D1, F1, H1	Double solenoid	548423	CDV15.0-EB1-MP-BI
	P	With separate supply and exhaust ports, single solenoid	548430	CDV15.0-EB1X-MP-MO
	P	With separate supply and exhaust ports, double solenoid	548431	CDV15.0-EB1X-MP-BI
Extension modules for 2 valve positions, multi-pin plug				
	B, D, F, H	Single solenoid	548428	CDV15.0-EB2-MP-MO
	B, D, F, H	Double solenoid	554369	CDV15.0-EB2-MP-BI
	-	Double solenoid, with screw kit for 2 and 4 valve positions	196710	CDV15.0-EB
	P	With separate supply and exhaust ports, single solenoid	548436	CDV15.0-EB2X-MP-MO
	P	With separate supply and exhaust ports, double solenoid	554370	CDV15.0-EB2X-MP-BI
	-	With separate supply and exhaust ports, double solenoid, with screw kit for 2 and 4 valve positions	528609	CDV15.0-EBX
	Extension modules for 1 valve position, fieldbus			
	B1, D1, F1, H1	Single solenoid	548424	CDV15.0-EB1-DN-MO
	B1, D1, F1, H1	Double solenoid	548426	CDV15.0-EB1-DN-BI
	V	With separate electrical additional supply, single solenoid	548425	CDV15.0-EB1Z-DN-MO
	V	With separate electrical additional supply, double solenoid	548427	CDV15.0-EB1Z-DN-BI
	P	With separate supply and exhaust ports, single solenoid	548432	CDV15.0-EB1X-DN-MO
	P	With separate supply and exhaust ports, double solenoid	548434	CDV15.0-EB1X-DN-BI
	C	With separate electrical additional supply as well as separate supply and exhaust ports, single solenoid	548433	CDV15.0-EB1XZ-DN-MO
	C	With separate electrical additional supply as well as separate supply and exhaust ports, double solenoid	548435	CDV15.0-EB1XZ-DN-BI

Valve terminals CDVI, Clean Design

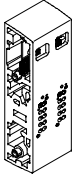
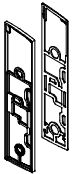
FESTO

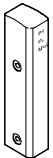
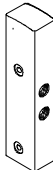





Accessories

Ordering data				
	Code	Description	Part No.	Type
Extension modules for 2 valve positions, fieldbus				
	B, D, F, H	Single solenoid	548429	CDVI5.0-EB2-DN-MO
	B, D, F, H	Double solenoid	554371	CDVI5.0-EB2-DN-BI
	–	Double solenoid, with screw kit for 2 and 4 valve positions	536813	CDVI5.0-EB-DN
	V	With separate electrical additional supply, single solenoid	549616	CDVI5.0-EB2Z-DN-MO
	V	With separate electrical additional supply, double solenoid	549619	CDVI5.0-EB2Z-DN-BI
	P	With separate supply and exhaust ports, single solenoid	548437	CDVI5.0-EB2X-DN-MO
	P	With separate supply and exhaust ports, double solenoid	554372	CDVI5.0-EB2X-DN-BI
	–	With separate supply and exhaust ports, double solenoid, with screw kit for 2 and 4 valve positions	536815	CDVI5.0-EBX-DN
	C	With separate electrical additional supply as well as separate supply and exhaust ports, single solenoid	549617	CDVI5.0-EB2XZ-DN-MO
	C	With separate electrical additional supply as well as separate supply and exhaust ports, double solenoid	548438	CDVI5.0-EB2XZ-DN-BI
Separator plates				
	B	No duct separation	196700	CDVI5.0-DZ
	D	Duct 1 separated Ducts 3 and 5 open	196702	CDVI5.0-DZP
	F	Duct 1 open Ducts 3 and 5 separated	196704	CDVI5.0-DZR
	H	Ducts 1, 3 and 5 separated	196706	CDVI5.0-DZPR
Left-hand end plate				
	K05	Electrical multi-pin plug, cable length 5 m	196692	CDVI5.0-EPL-MP-K05
	K10	Electrical multi-pin plug, cable length 10 m	196694	CDVI5.0-EPL-MP-K10
	F11	DeviceNet fieldbus connection	535838	CDVI5.0-EPL-DN-LI
Right-hand end plate				
	–	Internal pilot air supply	196696	CDVI5.0-EPR
	–	External pilot air supply	196698	CDVI5.0-EPR-S
Bus connection				
	–	DeviceNet plug socket/Micro Style connection, M12, 5-pin, straight socket (A-coded), IP65, Pg9	18324	FBSD-GD-9-5POL
	–	DeviceNet plug/power supply/Micro Style connection, M12, 5-pin, straight plug (A-coded), IP65, Pg9	175380	FBS-M12-5GS-PG9

Valve terminals CDVI, Clean Design

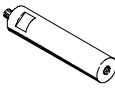
Accessories

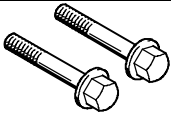
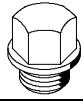
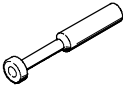
FESTO

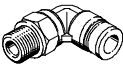
Ordering data					
	Code	Description		Part No.	Type
Valve terminal connection					
	-	Connecting cable WS-WD, angled plug-angled socket	0.25 m	540327	KVI-CP-3-WS-WD-0,25
			0.5 m	540328	KVI-CP-3-WS-WD-0,5
			2 m	540329	KVI-CP-3-WS-WD-2
			5 m	540330	KVI-CP-3-WS-WD-5
			8 m	540331	KVI-CP-3-WS-WD-8
	-	Connecting cable GS-GD, straight plug-straight socket	2 m	540332	KVI-CP-3-GS-GD-2
			5 m	540333	KVI-CP-3-GS-GD-5
			8 m	540334	KVI-CP-3-GS-GD-8
Input and output modules					
	-	Input and output modules, CPI system → Internet: ctec			
Mounting attachments					
	Y	Spacer bolt (2 pieces)		196718	CDVI5.0-STB
	-	Mounting kit		534436	CDSV5.0
	-	Screw kit for attaching the extension modules to the basic block (2 pieces)	for 1 valve position	548442	CDVI5.0-ZA-EB1
			for 2 valve positions	548443	CDVI5.0-ZA-EB2
			for 3 valve positions	548444	CDVI5.0-ZA-EB3
			for 4 valve positions	548445	CDVI5.0-ZA-EB4
			for 5 valve positions	548446	CDVI5.0-ZA-EB5
			for 6 valve positions	548447	CDVI5.0-ZA-EB6
			for 7 valve positions	548448	CDVI5.0-ZA-EB7
for 8 valve positions	548449	CDVI5.0-ZA-EB8			
Blanking plug					
	-	Blanking plug	G $\frac{3}{8}$ for end plates	196712	CDVI-5.0-B-G $\frac{3}{8}$
	-		G $\frac{1}{8}$ for end plates	196720	CDVI-5.0-B-G $\frac{1}{8}$
	-		for spacer bolt thread	532476	CDVI5.0-B-M6
Plug					
	-	Blanking plug	for tubing O.D. 6 mm	153268	QSC-6H
	-		for tubing O.D. 8 mm	153269	QSC-8H
	-		for tubing O.D. 10 mm	153270	QSC-10H
	-		for tubing O.D. 12 mm	153271	QSC-12H
Push-in fittings (10 pieces)					
	-	Straight, connecting thread M5 for tubing O.D. 4 mm		533844	QS-F-M5-4
	B	Straight, connecting thread G $\frac{1}{8}$ for tubing O.D. 6 mm		193409	QS-F-G $\frac{1}{8}$ -6
	A	Straight, connecting thread G $\frac{1}{8}$ for tubing O.D. 8 mm		193410	QS-F-G $\frac{1}{8}$ -8
	-	Straight, connecting thread G $\frac{3}{8}$ for tubing O.D. 12 mm		8002795	QS-F-G $\frac{3}{8}$ -12-B
	-	Angled, connecting thread M5 for tubing O.D. 4 mm		533849	QSL-F-M5-4
	D	Angled, connecting thread G $\frac{1}{8}$ for tubing O.D. 6 mm		193419	QSL-F-G $\frac{1}{8}$ -6
	C	Angled, connecting thread G $\frac{1}{8}$ for tubing O.D. 8 mm		193420	QSL-F-G $\frac{1}{8}$ -8
	-	Angled, connecting thread G $\frac{3}{8}$ for tubing O.D. 12 mm		197486	QSL-F-G $\frac{3}{8}$ -12

Valve terminals CDVI, Clean Design

Accessories



Ordering data					
	Code	Description		Part No.	Type
Manual					
	D	Pneumatic components – CDVI	German	197361	P.BE-CDVI-DE
	E		English	197363	P.BE-CDVI-EN
	I		Italian	197369	P.BE-CDVI-IT
	S		Spanish	197367	P.BE-CDVI-ES
	V		Swedish	197371	P.BE-CDVI-SV
	D		Electrical components – CDVI-DN	German	539044
	E	English		539045	P.BE-CDVI-DN-EN
	I	Italian		539048	P.BE-CDVI-DN-IT
	S	Spanish		539046	P.BE-CDVI-DN-ES
	V	Swedish		539049	P.BE-CDVI-DN-SV