

End position controllers SPC11



End position controllers SPC11

Key features

Key features at a glance

Fast travel between two fixed stops with electronically controlled end position cushioning and up to two freely selectable intermediate positions.

- Up to 30% faster cycle rates
- Significantly reduced system vibration
- Simple conversion of existing systems
- Optimum operating behaviour is maintained even with weight/load fluctuations of up to 30% of the total moving mass
- Less expensive than electromechanical drives
- Reduced noise level
- Fast problem-free commissioning, no specialists required

Individual components

End position controller

Integrated functions:

- For determining system characteristic values of the connected components.
- Storage of the desired end positions or intermediate positions.

- Comparison of setpoint and actual position, and position control through appropriate actuation of the proportional 5/3-way valve (status control).
- Internal or external teach-in function.

SPC11



Analogue displacement encoders

Analogue displacement encoder based on a conductive-plastic linear potentiometer. The system measures absolute values. It is connected alongside a pneumatic drive. Mounting kits are

available as accessories for the mechanical coupling. The displacement encoder is available in fixed stroke lengths ranging from 100 ... 2000 mm.

MLO-POT...-TLF



MLO-POT...-LWG



Digital displacement encoders

Digital displacement encoders, magnetostrictive, contactless method of measurement. The system measures absolute values. It is connected alongside a pneumatic linear

drive. Mounting kits are available as accessories for the mechanical coupling. The displacement encoder is available in fixed stroke lengths ranging from 100 ... 2000 mm.

MME-MTS...-AIF



Pneumatic drives

Pneumatic drives ensure an easy-to-operate system. The stroke length operating range depends on the selected drive. The range extends from 225 ... 2000 mm. The swivel angle with DSMI ranges from 0° ... 270°.

 Note

The linear drives DGP/DGPL with compressed air supply connections at both ends (D2) should be used for effective cylinder strokes above 600 mm.

DGCI



DGPL, DGPIL



DNC



DNCI



DSMI



Proportional 5/3-way valves

Valve actuation is via the end position controller. The valve controls the volume of air supplied to the drive. The extremely short switching time of the valve makes the Smart Soft Stop solution package highly dynamic.

 Note

Use a 5 µm filter for compressed air preparation. The compressed air supply must be unlubricated.

MPYE-5...-010B

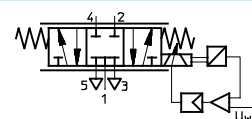

End position controllers SPC11

Key features

Possible combinations

with external displacement encoder

End position controller

Displacement encoder

Drive

SPC11
with I/O interface
→ 10



MLO-POT-...-TLF



MME-MTS-...-AIF



MLO-POT-...-LWG



DGP/DGPL



DNC



with external/integrated displacement encoder

End position controller

Drive with displacement encoder

SPC11
with I/O interface
→ 10



DGCI



DNCI



DGPI/DGPIL



DSMI



End position controllers SPC11

Key features

Conventional solution

Previously you needed to

- Harmonise individual components.
- Install additional shock absorbers and possibly replace/exchange existing shock absorbers.
- Fit proximity sensors for position detection.
- Adjust the compressed air supply by means of flow control valves in order to optimise the system.

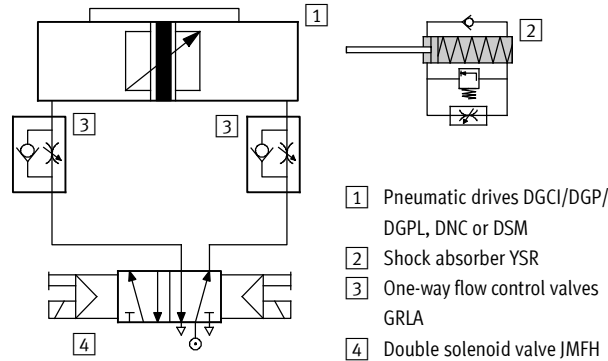

Until now, to create intermediate positions you had to

- Construct a complex mechanical solution using stopper cylinders, for example.
- Harmonise a large number of individual components.
- Perform extensive programming.

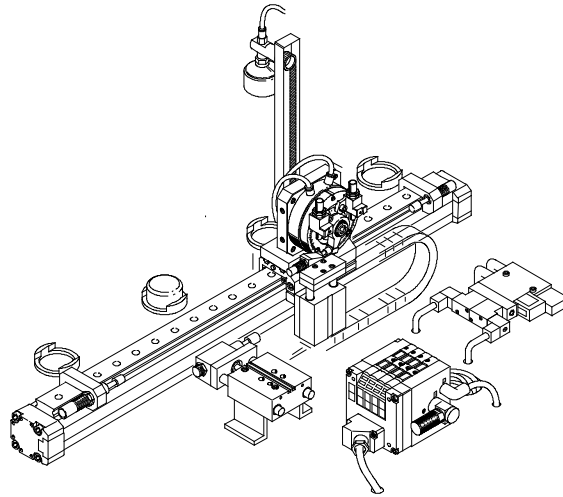

Solution with end position controller SPC11

Fast travel between two fixed stops with up to two freely selectable intermediate positions

The Smart Soft Stop system with end position controller SPC11 facilitates travel between two fixed mechanical stops as well as travel to up to two freely selectable intermediate positions. The level of accuracy of the intermediate positions is $\pm 0.25\%$ of the

displacement encoder length, and no less than ± 2 mm. The level of accuracy of the intermediate positions is $\pm 2^\circ$ for the swivel module DSMI. Typical applications for the intermediate positions are rest or ejector positions, where a low-cost solution is more

important than achieving high levels of accuracy. The intermediate positions also have sensor functionality. This means that when the relevant intermediate position is passed, a 50 ms pulse is produced at the corresponding output.

End position controllers SPC11

Key features

The Festo solution package

Smart Soft Stop with end position controller SPC11

In an application with up to two intermediate positions you can now:

- Use the Festo solution package with a small number of harmonised components.
- Dispense with complex constructions using stopper cylinders.
- Approach the intermediate positions from both sides.
- Let optimisation be carried out by the learning system itself.

The Smart Soft Stop system with SPC11 has a remote input, which allows all three pushbuttons to be allocated to a master controller:

- All system parameters can be defined and changed externally.
- A signal at the remote input disables all pushbuttons on the end position controller SPC11.

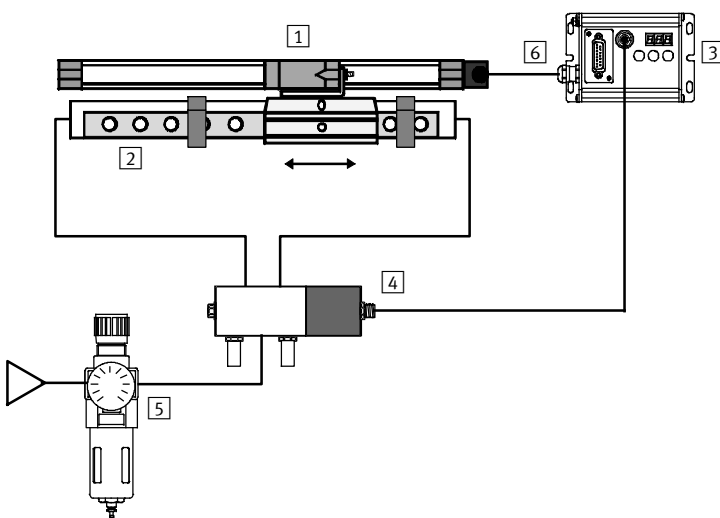

- 1 Displacement encoder
 Digital:
 – MME-MTS-...-AIF
 – integrated in case of DGPI/DGPIL
 – integrated in case of DNCI
 Analogue:
 – MLO-POT-...-TLF
 – MLO-POT-...-LWG
 – integrated in case of DSMI

- 2 Pneumatic drives
 DGCI/DGP/DGPL, DGPI/DGPIL,
 DNC, DNCI or DSMI

- 3 End position controller
 SPC11-POT-TLF,
 SPC11-POT-LWG or
 SPC11-MTS-AIF
 SPC11-INC

- 4 Proportional 5/3-way valve
 MPYE-5-...-010B

- 5 Service unit (without lubricator,
 with 5 µm filter), supply
 pressure 5 to 7 bar

- 6 Operating voltage connection
 and master controller

End position controllers SPC11

Key features

The solution package

Individual components

- Pneumatic drives
DGCI/DGP/DGPL, DGPI/DGPIL, DNC, DNCI or DSMI
- Proportional 5/3-way valve
MPYE-5-...-010B
- Displacement encoder
MLO-POT-...-TLF,
MLO-POT-...-LWG or
MME-MTS-...-AIF

- End position controller
SPC11
- Valve cable
KMPYE
- Controller cable
KMPV-...
- Manual

Solution packages are uniquely defined, i.e. all components are harmonised for optimum performance. For details of this unique allocation please see → 19 or 33 or
→ Smart Soft Stop software tool:
www.festo.com/en/engineering

Accessories available on separate order (fittings, tubing, etc.) can be found in the respective solution packages. An example of an order is shown on → 18 or 32.

PPV = Open the internal cushioning 100%

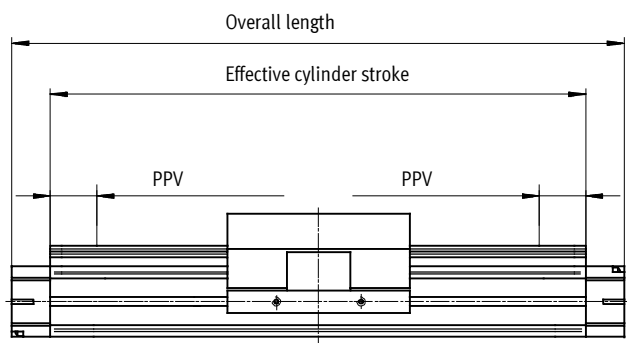

Symmetrical

The desired travel distance should not therefore exceed the relevant effective cylinder stroke.

The following thus applies:
travel distance ≤ effective cylinder stroke.

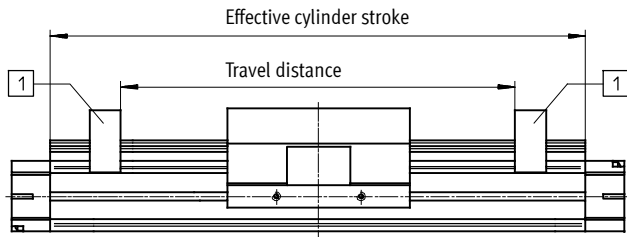

1 Fixed stops, mounted on drive or externally

Asymmetrical

The desired travel distance within the effective cylinder stroke must be limited by means of fixed stops. The same applies to the pneumatic drives DGCI/DNC, DNCI, DNCM and DSMI.

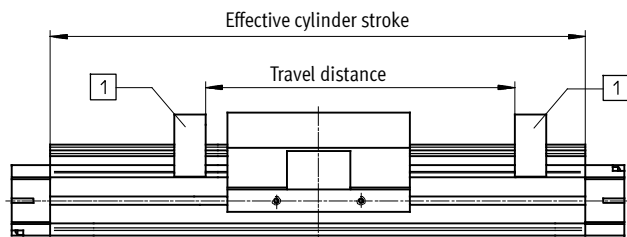

1 Fixed stops, mounted on drive or externally

Note

External limit stops are required in order to realise the effective stroke (or effective swivel angle in the case

of DSMI) when using the pneumatic drives DGCI, DNC, DNCI and DSMI with the Smart Soft Stop system.

End position controllers SPC11

Key features

The solution package

Advantages

- Up to 30% faster cycle rates
- Significantly reduced system vibration
- Optimum operating behaviour is maintained even with weight/load fluctuations of up to 30% of the total moving mass
- Simple conversion of existing systems
- Considerably reduced noise level
- Fast problem-free commissioning, no specialists required
- Less expensive than electromechanical drives

The graphs apply to the following example:

- DGPL-25-1250-PPV-A-KF-B-GK...-D2,
- Moving load: 12 kg
- Horizontal mounting position

Note
The shape of the curve is identical for the pneumatic drives DGCI, DNC, DNCI, DSMI and DGPIL.

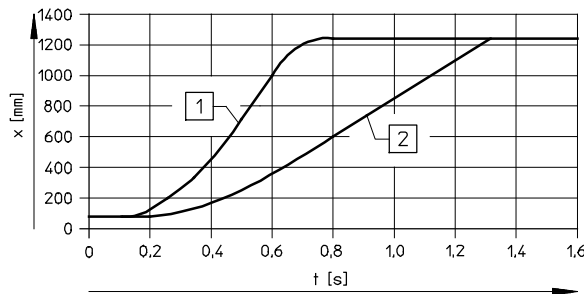

- 1 = Drive with electronic end position controller SPC11
- 2 = Drive with shock absorber

x = Travel distance
t = Time

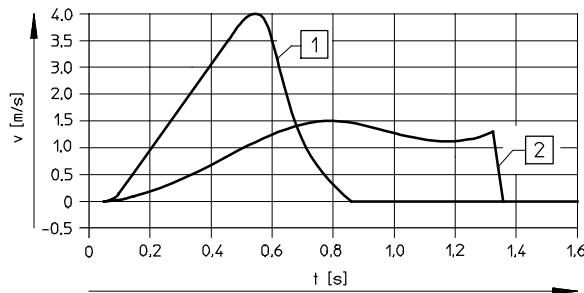

- 1 = Drive with electronic end position controller SPC11
- 2 = Drive with shock absorber

v = Velocity
t = Time

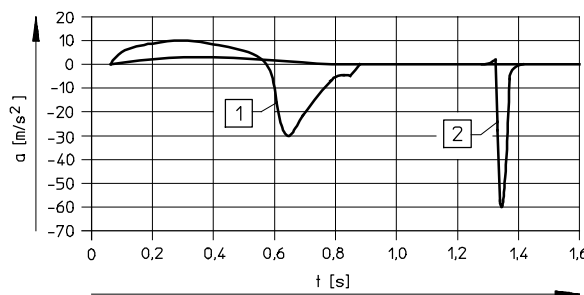

- 1 = Drive with electronic end position controller SPC11
- 2 = Drive with shock absorber

a = Acceleration
t = Time

Festo plug & work = Commissioning in just a few steps

- 1 Assemble the system components:
Moving mass must be attached backlash-free.
- 2 Set up the pneumatic and electrical system connections.
- 3 Switch on the compressed air and supply voltage.
- 4 Start the teaching process by means of a button. The system learns autonomously and is ready for operation after 3 minutes.
- 5 Approach and save intermediate positions by means of buttons.

End position controllers SPC11

Peripherals overview

FESTO

Variant with drive DGPII

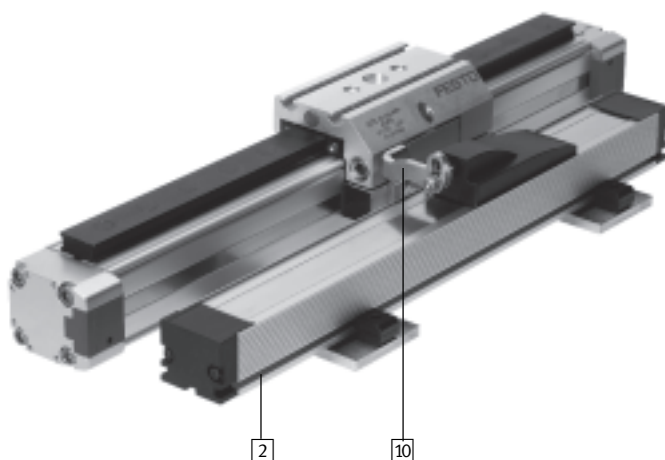
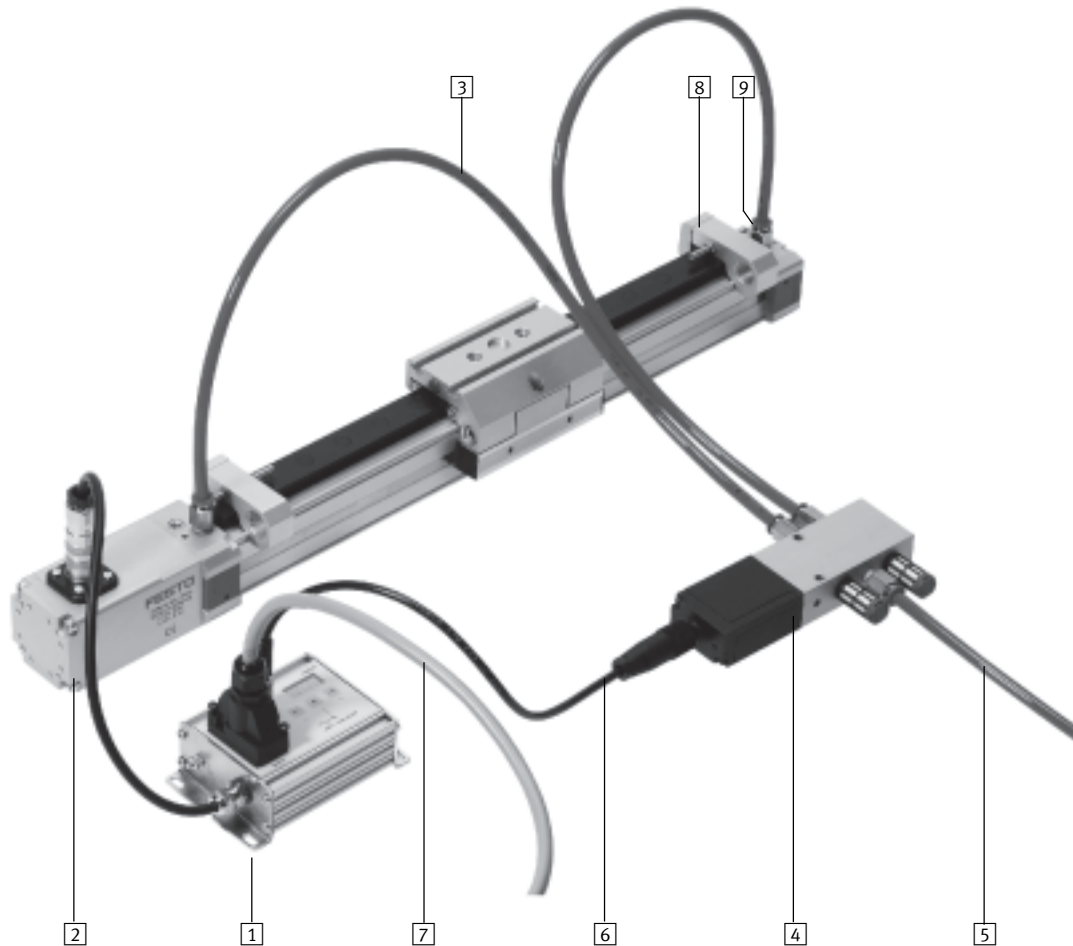

-  - Note

The same components are required for the drive DGPL as for the drive DGPII.

The integrated digital displacement encoder of the DGPII is replaced by an externally mounted displacement encoder (either digital or potentiometric).

End position controllers SPC11

Peripherals overview



Individual components						
Brief description	Pneumatic drives					
	DGCI	DGP/DGPL	DGPI/DGPIL	DNC	DNCI	DSMI
1 End position controller SPC11	■	■	■	■	■	■
1 End position controller SPC11-ASI	-	■	■	■	-	■
2 Analogue displacement encoder MLO-POT-...-TLF	-	■	-	-	-	-
2 Analogue displacement encoder MLO-POT-...-LWG	-	-	-	■	-	-
2 Digital displacement encoder MME-MTS-...-AIF	-	■	-	-	-	-
3 Air supply lines (laid symmetrically)	■	■	■	■	■	■
4 Proportional 5/3-way valve MPYE	■	■	■	■	■	■
5 Compressed air supply	■	■	■	■	■	■
6 Connecting cable KMPYE to proportional 5/3-way valve	■	■	■	■	■	■
7 Connecting cable to controller	■	■	■	■	■	■
8 Fixed stop	■	■	■	1)	1)	■
9 Push-in connector QS (preferably straight)	■	■	■	■	■	■
10 Displacement encoder mounting kit	-	■	-	-	-	-
Solution packages →	12	18	18	24	28	32

1) External limit stops are required with the DNC and DNCI to limit the travel distance within the effective stroke.

Allocation of end position controller SPC11 to drive and displacement encoder					
End position controller	SPC11-POT-TLF SPC11-POT-TLF-ASI	SPC11-POT-LWG SPC11-POT-LWG-ASI	SPC11-MTS-AIF SPC11-MTS-AIF-ASI	SPC11-INC	SPC11-MTS-AIF-2
Drive					
DGCI	-	-	-	-	■
DGPI/DGPIL	-	-	■	-	-
DNCI	-	-	-	■	-
DSMI	-	■	-	-	-
Displacement encoder					
MLO-POT-TLF	■	-	-	-	-
MLO-POT-LWG	-	■	-	-	-
MME-MTS-AIF	-	-	■	-	-

End position controllers SPC11

Technical data

Teach-in function

- SPC11-POT-TLF
- SPC11-POT-LWG
- SPC11-MTS-AIF
- SPC11-INC
- SPC11-MTS-AIF-2

The teach-in travel (to determine the system data and end positions) can be started via a button on the end position controller SPC11 or via an external output which is connected through the control cable (e.g. the PLC).



General technical data								
End position controller SPC11-...		Type	...-POT-TLF	...-POT-LWG	...-MTS-AIF	...-INC	...-MTS-AIF-2	
Operating voltage		[V DC]	24 (-25 ... +25%)					
Current consumption	with valve	[A]	1.3					1.1
	without valve	[mA]	70		170	80	70	
Residual ripple		[%]	Max. 5					
Digital inputs	Number		8					
	Input voltage	[V DC]	24					
	Input current	[mA]	4 (at 24 V DC)					
	Duty cycle	[ms]	min. 20					
	Signal voltage	[V DC]	0 ... 5 (for logic 0) 15 ... 30 (for logic 1)					
Digital outputs (short circuit proof)	Number		5					
	Output voltage		min. V_b ... V_b : -3 V DC (at 0.1 A)					
	Output current	[A]	Max. 0.1					
	Max. tripping current	[mA]	500					
Displacement encoder input MLO-POT-...	Operating voltage	[V DC]	+10			-		
	Input voltage	[V DC]	0 ... +10			-		
Displacement encoder input MME-MTS-...	Operating voltage	[V DC]	-		24	-		
	Communication		-		CAN fieldbus (1 Mbaud)	-		
Standard cylinder input DNCl	Operating voltage	[V DC]	-			5	-	
	Communication		-			sin/cos	-	
Linear drive input DGCl	Operating voltage	[V DC]	-				24	
	Communication		-				CAN fieldbus (1 Mbaud)	
Valve output	Operating voltage	[V DC]	24					
Valve output	Output voltage	[V DC]	0 ... +10					
Relative air humidity		[%]	95 (non-condensing)					
Weight		[g]	Approx. 400					

Operating and environmental conditions								
End position controller SPC11-...		Type	...-POT-TLF	...-POT-LWG	...-MTS-AIF	...-INC	...-MTS-AIF-2	
Temperature range		[°C]	0 ... +50					
Protection class to IEC 60529			IP65					
Vibration resistance, tested to DIN/IEC 68, Part 2-6			Severity level 2					
Shock resistance, tested to DIN/IEC 68, Part 2-27			Severity level 2					
CE mark (see declaration of conformity)			In accordance with EU EMC directive					

End position controllers SPC11

Technical data

Dimensions

Download CAD data → www.festo.com

SPC11-POT-TLF, SPC11-POT-LWG, SPC11-MTS-AIF

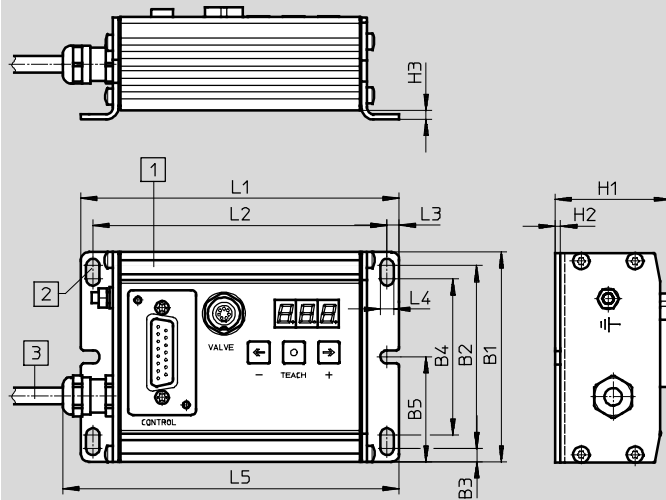

- 1 Slot for inscription labels:
18182 IBS-9x20
18576 IBS-6x10
- 2 Mounting options for M4 screws
- 3 Connecting cable (length approx. 335 mm)

SPC11-INC, SPC11-MTS-AIF-2

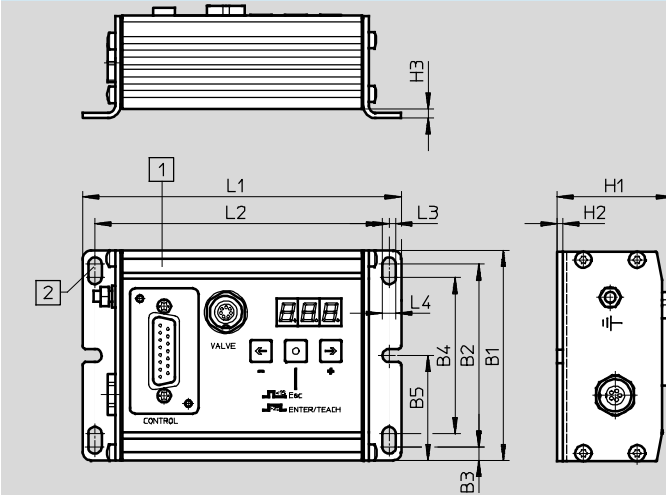

- 1 Slot for inscription labels:
18182 IBS-9x20
18576 IBS-6x10
- 2 Mounting options for M4 screws

Type	B1	B2	B3	B4	B5	H1	H2	H3	L1	L2	L3	L4	L5
SPC11-POT-...						43		4.5					125
SPC11-MTS-AIF	78	68	5	58	39		2		118.1	109.1	4.5	5	
SPC11-MTS-AIF-2						42.6		4.2					
SPC11-INC													

Ordering data

Description	Part No.	Type
For analogue displacement encoder MLO-POT-...-TLF	192216	SPC11-POT-TLF
For analogue displacement encoder MLO-POT-...-LWG, swivel module DSM1	192217	SPC11-POT-LWG
For digital displacement encoder MME-MTS-...-AIF	192218	SPC11-MTS-AIF
For standard cylinder DNCl	537321	SPC11-INC
For linear drive DGCl	548129	SPC11-MTS-AIF-2

End position controllers SPC11

Technical data

Order example
For pneumatic linear drives DGCI

A workpiece weighing 3 kg is to be moved horizontally on a loading station. A workpiece gripper attached

to the slide of the linear drive weighs 14 kg. The total weight to be moved is therefore 17 kg. The desired travel

distance is 1,100 mm. The travel time is to be < 1.5 seconds.

 - Note
Sizing software
Smart Soft Stop and ProDrive
→www.festo.com

 - Note
Remember when selecting the drive mounting components that some of these are not backlash-free and therefore cannot be used with the Smart Soft Stop system. The drives must be mounted directly.

 - Note
Check that the loads placed on the drive by a gripper during movement do not exceed permissible limits. To carry out simulation quickly and easily, use the Smart Soft Stop software tool and ProDrive.

Step 1:
Selecting the cylinder stroke
For a travel distance of 1,100 mm, use the table on → 13 to select the next-largest effective cylinder stroke of 1,250 mm. This column has a grey background.

Step 2:
Specifying the drive
For a total weight of 17 kg to be moved horizontally, there is a choice of piston diameters of 25, 32 and 40 mm (see data for max. total weight to be moved).
For the purposes of our example, the drive DGCI-32-1250-KF-..., part no. 544 427 has been selected.

Step 3:
Specifying a proportional 5/3-way valve
The appropriate proportional 5/3-way valve is shown at the intersection of the grey column used in step 1 and the line for the selected linear drive DGCI-32-... in the "Proportional 5/3-way valve" section of the table. For the purposes of our example, the proportional 5/3-way valve MPYE-5-1/4-010B, part no. 151 694 has been selected.

Step 4:
Completing the order information
To order a complete system you must add the data for the end position controller, valve and controller cables and manual (if required). The complete ordering data for our example can be found on → 13. A manual should normally be ordered. If you already have one, leave the appropriate box blank, indicating that you do not want a manual.

Step 5:
Determining the travel time
To calculate the travel time use the "Smart Soft Stop" software tool. The travel time for the order example is 1.16 seconds.

 - Note
For vertical travel, t_{up} and t_{down} are the two different travel times.

Ordering data					
Pneumatic linear drive		Proportional 5/3-way valve		End position controller	
Part No.	Type	Part No.	Type	Part No.	Type
544427	DGCI-32-1250-KF-...	151694	MPYE-5-1/4-010B	548129	SPC11-MTS-AIF-2
Valve cable		Controller cable			
Part No.	Type	Part No.	Type		
170238	KMPYE-AIF-1-GS-GD-2	177674	KMPV-SUB-D-15-10		

End position controllers SPC11

Technical data

Step 1 and 2:		DGCI-... ¹⁾ -... ²⁾ -KF-...													
Pneumatic linear drives/Type															
Effective cylinder stroke	[mm]	100	160	225	300	360	450	500	600	750	1,000	1,250	1,500	1,750	2,000
Max. overall mass to be moved horizontally/vertically by \varnothing	18	15/5													
	25	30/10													
	32	45/15													
	40	70/25													
Part No. for \varnothing	18	544 425													
	25	544 426													
	32	544 427													
	40	544 428													

Step 3:		Proportional 5/3-way valves ³⁾													
Part No./Type		1 = 154 200 MPYE-5-M5-010-B							3 = 151 693 MPYE-5-1/8-HF-010-B						
		2 = 151 692 MPYE-5-1/8-LF-010-B							4 = 151 694 MPYE-5-1/4-010-B						
Effective cylinder stroke	[mm]	100	160	225	300	360	450	500	600	750	1,000	1,250	1,500	1,750	2,000
Horizontal/vertical for \varnothing	18	1/1	1/1	1/1	1/1	2/2	2/2	2/2	2/2	2/2	2/2	2/2	2/2	2/2	3/3
	25	2/2	2/2	2/2	2/2	3/2	3/2	3/2	3/2	3/2	3/3	3/3	3/3	3/3	3/3
	32	2/2	3/2	3/2	3/2	3/3	3/3	3/3	3/3	3/3	4/3	4/3	4/3	4/3	4/4
	40	3/2	3/2	3/2	3/3	3/3	3/3	3/3	4/3	4/3	4/3	4/4	4/4	4/4	4/4

Step 5:		Part No.	Type	Brief description
End position controller	SPC11	548129	SPC11-MTS-AIF-2	
Cable	Valve	170238	KMPYE-AIF-1-GS-GD-2	Cable length 2 m
		170239	KMPYE-AIF-1-GS-GD-0,3	Cable length 0.3 m
	SPC11/PLC	177673	KMPV-SUB-D-15-5	Cable length 5 m
		177674	KMPV-SUB-D-15-10	Cable length 10 m

 Note
Manuals → 37

- 1) Indicate piston \varnothing . Technical data and dimensions → www.festo.com.
- 2) Indicate piston \varnothing . Technical data and dimensions → www.festo.com.
- 2) Indicate calculated effective stroke of cylinder.
- 3) Technical data and dimensions → Internet: mpye.
- 5) Technical data and dimensions → www.festo.com.
(not needed for DGPI/DGPIL, has integrated displacement encoder).
- 6) Technical data and dimensions → www.festo.com.

End position controllers SPC11

Technical data

FESTO

Accessories for the solution package for DGCI horizontally mounted

For effective cylinder stroke 100 ... 2,000 mm

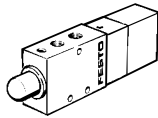
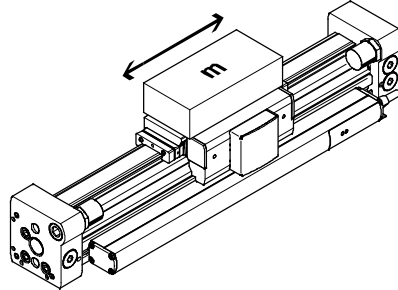

Ordering data									
Effective cylinder stroke DGCI-... [mm]	Proportional 5/3-way valve Type	Fittings ¹⁾				Compressed air tubing		Silencer ²⁾	
		For MPYE-5-...		For DGCI		Part No.	Type	Part No.	Type
		Part No.	Type	Part No.	Type				
Ø 18 mm									
100 ... 160	MPYE-5-M5-010-B	153306	QSM-M5-6	153306	QSM-M5-6	152586	PUN-6x1-SI	165003	UC-M5
225 ... 300	MPYE-5-M5-010-B								
360 ... 1,750	MPYE-5-1/8-LF-010-B	153002	QS-1/8-6	153306	QSM-M5-6	152586	PUN-6x1-SI	2307	U-1/8
2,000	MPYE-5-1/8-HF-010-B								
Ø 25 mm									
100 ... 160	MPYE-5-1/8-LF-010-B	153002	QS-1/8-6	153002	QS-1/8-6	152586	PUN-6x1-SI	2307	U-1/8
225 ... 300	MPYE-5-1/8-LF-010-B	153004	QS-1/8-8	153004	QS-1/8-8	152587	PUN-8x1,25-SI	2307	U-1/8
360 ... 2,000	MPYE-5-1/8-HF-010-B								
Ø 32 mm									
100	MPYE-5-1/8-LF-010-B	153002	QS-1/8-6	153002	QS-1/8-6	152586	PUN-6x1-SI	2307	U-1/8
160 ... 1,000	MPYE-5-1/8-HF-010-B	153004	QS-1/8-8	153004	QS-1/8-8	152587	PUN-8x1,25-SI		
1,250 ... 2,000	MPYE-5-1/4-010-B	153005	QS-1/4-8					2316	U-1/4
Ø 40 mm									
100 ... 160	MPYE-5-1/8-HF-010-B	153004	QS-1/8-8	153005	QS-1/4-8	152587	PUN-8x1,25-SI	2307	U-1/8
225 ... 500	MPYE-5-1/8-HF-010-B								
600 ... 750	MPYE-5-1/4-010-B	153005	QS-1/4-8	153005	QS-1/4-8	152587	PUN-8x1,25-SI	2316	U-1/4
1,000 ... 2,000	MPYE-5-1/4-010-B	153007	QS-1/4-10	153007	QS-1/4-10	152588	PUN-10x1,5-SI	2316	U-1/4

1) Fittings sold only in packs of 10.

2) 2 pieces are required.

End position controllers SPC11

Technical data

FESTO

Accessories for the solution package for DGCI horizontally mounted

For effective cylinder stroke 100 ... 2,000 mm

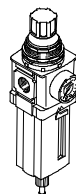
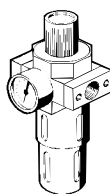

Ordering data								
Effective cylinder stroke DGCI... [mm]	Filter regulator, D series with filter cartridge 5 µm		Filter cartridge 5 µm D series		Filter regulator, MS series with filter cartridge 5 µm		Filter cartridge 5 µm MS series	
	Part No.	Type	Part No.	Type	Part No.	Type	Part No.	Type
Ø 18 mm								
100 ... 2,000	162719	LFR-¼-D-5M-MINI	159640	LFP-D-MINI-5M	529152	MS4-LFR-¼-D7-CRM-AS	534501	MS4-LFP-C
Ø 25 mm								
100 ... 2,000	162719	LFR-¼-D-5M-MINI	159640	LFP-D-MINI-5M	529152	MS4-LFR-¼-D7-CRM-AS	534501	MS4-LFP-C
Ø 32 mm								
100 ... 1,000	162719	LFR-¼-D-5M-MINI	159640	LFP-D-MINI-5M	529152	MS4-LFR-¼-D7-CRM-AS	534501	MS4-LFP-C
1,250 ... 2,000	162721	LFR-⅜-D-5M-MIDI	159594	LFP-D-MIDI-5M	529204	MS6-LFR-¼-D7-CRM-AS	534499	MS6-LFP-C
Ø 40 mm								
100 ... 500	162719	LFR-¼-D-5M-MINI	159640	LFP-D-MINI-5M	529152	MS4-LFR-¼-D7-CRM-AS	534501	MS4-LFP-C
600 ... 2,000	162721	LFR-⅜-D-5M-MIDI	159594	LFP-D-MIDI-5M	529204	MS6-LFR-¼-D7-CRM-AS	534499	MS6-LFP-C

End position controllers SPC11

Technical data

FESTO

Accessories for the solution package for DGCI vertically mounted

For effective cylinder stroke 100 ... 2,000 mm

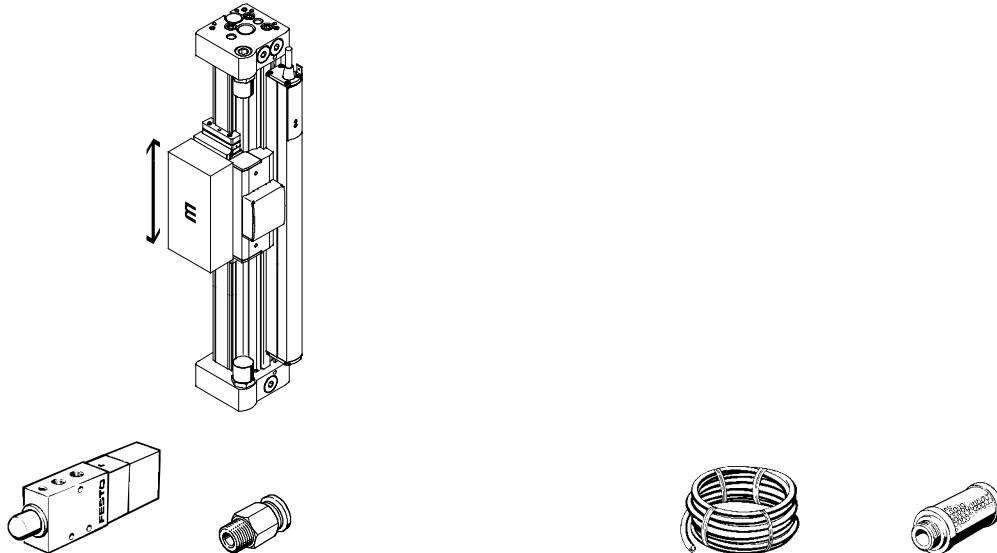

Ordering data									
Effective cylinder stroke DGCI [mm]	Proportional 5/3-way valve Type	Fittings ¹⁾				Compressed air tubing		Silencer ²⁾	
		For MPYE-5-...		DGCI		Part No.	Type	Part No.	Type
		Part No.	Type	Part No.	Type	Part No.	Type	Part No.	Type
∅ 18 mm									
100 ... 300	MPYE-5-M5-010-B	153306	QSM-M5-6	153306	QSM-M5-6	152586	PUN-6x1-SI	165003	UC-M5
360 ... 1,750	MPYE-5-1/8-LF-010-B	153002	QS-1/8-6					2307	U-1/8
2,000	MPYE-5-1/8-HF-010-B								
∅ 25 mm									
100 ... 160	MPYE-5-1/8-LF-010-B	153002	QS-1/8-6	153002	QS-1/8-6	152586	PUN-6x1-SI	2307	U-1/8
225 ... 750	MPYE-5-1/8-LF-010-B	153004	QS-1/8-8	153004	QS-1/8-8	152587	PUN-8x1,25-SI		
1,000 ... 2,000	MPYE-5-1/8-HF-010-B								
∅ 32 mm									
100	MPYE-5-1/8-LF-010-B	153002	QS-1/8-6	153002	QS-1/8-6	152586	PUN-6x1-SI	2307	U-1/8
160 ... 300	MPYE-5-1/8-LF-010-B	153004	QS-1/8-8	153004	QS-1/8-8	152587	PUN-8x1,25-SI	2307	U-1/8
360 ... 1,750	MPYE-5-1/8-HF-010-B								
2,000	MPYE-5-1/4-010-B	153005	QS-1/4-8					2316	U-1/4
∅ 40 mm									
100 ... 225	MPYE-5-1/8-LF-010-B	153004	QS-1/8-8	153005	QS-1/4-8	152587	PUN-8x1,25-SI	2307	U-1/8
300 ... 750	MPYE-5-1/8-HF-010-B								
1,000	MPYE-5-1/8-HF-010-B	190643	QS-1/8-10	153007	QS-1/4-10	152588	PUN-10x1,5-SI		
1,250 ... 2,000	MPYE-5-1/4-010-B	153007	QS-1/4-10					2316	U-1/4

1) Fittings sold only in packs of 10.

2) 2 pieces are required.

End position controllers SPC11

Technical data

FESTO

Accessories for the solution package for DGCI vertically mounted

For effective cylinder stroke 100 ... 2,000 mm

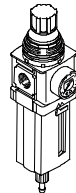
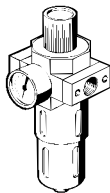

Ordering data								
Effective cylinder stroke DGCI [mm]	Filter regulator, D series with filter cartridge 5 µm		Filter cartridge 5 µm D series		Filter regulator, MS series with filter cartridge 5 µm		Filter cartridge 5 µm MS series	
	Part No.	Type	Part No.	Type	Part No.	Type	Part No.	Type
Ø 18 mm								
100 ... 2,000	162719	LFR-¼-D-5M-MINI	159640	LFP-D-MINI-5M	529152	MS4-LFR-¼-D7-CRM-AS	534501	MS4-LFP-C
Ø 25 mm								
100 ... 2,000	162719	LFR-¼-D-5M-MINI	159640	LFP-D-MINI-5M	529152	MS4-LFR-¼-D7-CRM-AS	534501	MS4-LFP-C
Ø 32 mm								
100 ... 1,000	162719	LFR-¼-D-5M-MINI	159640	LFP-D-MINI-5M	529152	MS4-LFR-¼-D7-CRM-AS	534501	MS4-LFP-C
1,250 ... 2,000	162721	LFR-⅜-D-5M-MIDI	159594	LFP-D-MIDI-5M	529204	MS6-LFR-¼-D7-CRM-AS	534499	MS6-LFP-C
Ø 40 mm								
100 ... 500	162719	LFR-¼-D-5M-MINI	159640	LFP-D-MINI-5M	529152	MS4-LFR-¼-D7-CRM-AS	534501	MS4-LFP-C
600 ... 2,000	162721	LFR-⅜-D-5M-MIDI	159594	LFP-D-MIDI-5M	529204	MS6-LFR-¼-D7-CRM-AS	534499	MS6-LFP-C

End position controllers SPC11

Technical data

Order example

For pneumatic linear drives DGP/DGPL, DGPI/DGPIL

A workpiece weighing 3 kg is to be moved horizontally on a loading station. A workpiece gripper attached

to the slide of the linear drive weighs 14 kg. The total weight to be moved is therefore 17 kg. The desired travel

distance is 1,100 mm. The travel time is to be < 1.5 seconds.

Step 1:

Selecting the cylinder stroke

For a travel distance of 1,100 mm, use the table on → 19 to select the next-largest effective cylinder stroke of 1,250 mm. This column has a grey background.

Step 2:

Specifying the drive

For a total weight of 17 kg to be moved horizontally, there is a choice of piston diameters of 25, 32, 40, 50 and 63 mm (see data for max. total weight to be moved).

For the purposes of our example, the drive DGPL-32-1250-PPV-A-B-KF-GK-...-D2, part no. 175 135 has been selected.

Step 3:

Specifying the displacement encoder

The appropriate length of the displacement encoder is governed by the effective cylinder stroke.

The column with the grey background in the "Displacement encoder" section of the table shows Part No. 152 633 for this example.

Alternatively, the digital displacement encoder MME-MTS-...-AIF can be used.

Step 4:

Specifying a proportional 5/3-way valve

The appropriate proportional 5/3-way valve is shown at the intersection of the grey column used in step 1 and the line for the selected linear drive DGPL-32-... in the "Proportional 5/3-way valve" section of the table. For the purposes of our example, the proportional 5/3-way valve MPYE-5-1/4-010B, part no. 151 694 has been selected.

Step 5:

Completing the order information

To order a complete system you must add the data for the end position controller, valve and controller cables and manual (if required). The complete ordering data for our example can be found on → 19. A manual should normally be ordered. If you already have one, leave the appropriate box blank, indicating that you do not want a manual.

Step 6:

Determining the travel time

To calculate the travel time use the "Smart Soft Stop" software tool.

The travel time for the order example is 1.16 seconds.



Note

Sizing software
Smart Soft Stop and ProDrive
→www.festo.com



Note

Remember when selecting the drive mounting components that some of these are not backlash-free and therefore cannot be used with the Smart Soft Stop system. The drives must be mounted directly.



Note

Check that the loads placed on the drive by a gripper during movement do not exceed permissible limits. To carry out simulation quickly and easily, use the Smart Soft Stop software tool and ProDrive.



Note

The moment compensator FKP is not backlash-free. It must not therefore be used in combination with linear drives DGP/DGPI.



Note

For vertical travel, t_{up} and t_{down} are the two different travel times.

Ordering data

Pneumatic linear drive		Displacement encoder		Proportional 5/3-way valve		End position controller	
Part No.	Type	Part No.	Type	Part No.	Type	Part No.	Type
175135	DGPL-32-1250-PPV-A-B-KF-GK-...-D2	152633	MLO-POT-1250-TLF	151694	MPYE-5-1/4-010B	192216	SPC11-POT-TLF

Valve cable		Controller cable	
Part No.	Type	Part No.	Type
170238	KMPYE-AIF-1-GS-GD-2	177674	KMPV-SUB-D-15-10

End position controllers SPC11

Technical data

Step 1 and 2:													
Pneumatic linear drives/Type		DGP-... ¹⁾ -... ³⁾ -PPV-A-B-D2						DGPI-... ²⁾ -... ³⁾ -PPV-A-B-D2					
		DGPL-... ¹⁾ -... ³⁾ -PPV-A-KF-B-GK-...-D2						DGPIIL-... ²⁾ -... ³⁾ -PPV-A-B-KF-...-D2					
Effective cylinder stroke	[mm]	225	300	360	450	500	600	750	1,000	1,250	1,500	1,750	2,000
Max. overall mass to be moved horizontally/vertically by Ø	25	30/10 kg											
	32	45/15 kg											
	40	70/25 kg											
	50	120/40 kg											
	63	180/60 kg											
Part No. for Ø	25	175 134											
	32	175 135											
	40	175 136											
	50	175 137											
	63	175 138											

Step 3:													
Displacement encoder ⁵⁾		MLO-POT-...-TLF MME-MTS-...-AIF											
Effective cylinder stroke	[mm]	225	300	360	450	500	600	750	1,000	1,250	1,500	1,750	2,000
Potentiometer length	[mm]	225	300	360	450	500	600	750	1,000	1,250	1,500	1,750	2,000
Part No.	MLO-POT-...-TLF	152 625	152 626	152 627	152 628	152 629	152 630	152 631	152 632	152 633	152 634	152 635	152 636
	MME-MTS-...-AIF	178 310	178 309	178 308	178 307	178 306	178 305	178 304	178 303	178 302	178 301	178 300	178 299

Step 4:													
Proportional 5/3-way valves ⁶⁾		1 = 151 692 MPYE-5-3/8-LF-010-B						3 = 151 694 MPYE-5-1/4-010-B					
Part No./Type		2 = 151 693 MPYE-5-3/8-HF-010-B						4 = 151 695 MPYE-5-3/8-010-B					
Effective cylinder stroke	[mm]	225	300	360	450	500	600	750	1,000	1,250	1,500	1,750	2,000
Horizontal/vertical for Ø	25	1/ ⁴⁾	1/1	2/1	2/1	2/1	2/2	2/2	2/3	2/3	2/3	2/3	2/3
	32	1/ ⁴⁾	2/1	2/1	2/1	2/1	2/1	3/2	3/3	3/3	3/3	3/3	3/3
	40	2/1	2/1	2/1	2/1	2/2	3/3	3/4	3/4	3/4	3/4	3/4	3/4
	50	1/1	2/1	2/2	3/2	3/3	4/3	4/4	4/4	4/4	4/4	4/4	4/4
	63	2/1	2/2	3/3	3/3	4/4	4/4	4/4	4/4	4/4	4/4	4/4	4/4

Step 5:		Part No.		Type	Brief description
End position controller	SPC11	192216	192218	SPC11-POT-TLF SPC11-MTS-AIF	
Cable	Valve	170238	170239	KMPYE-AIF-1-GS-GD-2 KMPYE-AIF-1-GS-GD-0,3	Cable length 2 m Cable length 0.3 m
	SPC11/PLC	177673	177674	KMPV-SUB-D-15-5 KMPV-SUB-D-15-10	Cable length 5 m Cable length 10 m

 Note
Manuals → 37

- 1) Indicate piston Ø. Technical data and dimensions → www.festo.com.
- 2) Indicate piston Ø. Technical data and dimensions → www.festo.com.
- 3) Indicate calculated effective stroke of cylinder.
- 4) On request
- 5) Technical data and dimensions → www.festo.com. (not needed for DGPI/DGPIIL, has integrated displacement encoder).
- 6) Technical data and dimensions → www.festo.com.

End position controllers SPC11

Technical data

FESTO

Accessories for the solution package for DGP/DGPL, DGPI/DGPIL horizontally mounted

For effective cylinder stroke 225 ... 2,000 mm

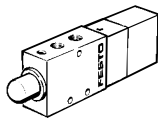
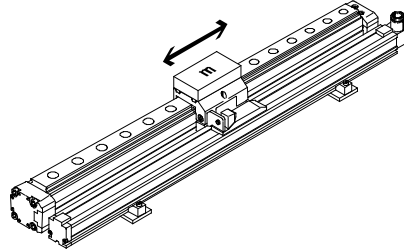

Ordering data									
Effective cylinder stroke DGP/L, DGPI/L-... [mm]	Proportional 5/3-way valve Type	Fittings ¹⁾				Compressed air tubing		Silencer ²⁾	
		For MPYE-5-...		DGP/L, DGPI/L		Part No.	Type	Part No.	Type
		Part No.	Type	Part No.	Type			Part No.	Type
Ø 25 mm									
225 ... 300	MPYE-5-1/8-LF-010-B	153004	QS-1/8-8	153004	QS-1/8-8	152587	PUN-8x1,25	2307	U-1/8
360 ... 2,000	MPYE-5-1/8-HF-010-B								
Ø 32 mm									
225	MPYE-5-1/8-LF-010-B	153004	QS-1/8-8	153004	QS-1/8-8	152587	PUN-8x1,25	2307	U-1/8
300 ... 600	MPYE-5-1/8-HF-010-B								
750 ... 2,000	MPYE-5-1/4-010-B	153005	QS-1/4-8	153004	QS-1/8-8	152587	PUN-8x1,25	2316	U-1/4
Ø 40 mm									
225 ... 500	MPYE-5-1/8-HF-010-B	153004	QS-1/8-8	153005	QS-1/4-8	152587	PUN-8x1,25	2307	U-1/8
600 ... 2,000	MPYE-5-1/4-010-B	153007	QS-1/4-10	153007	QS-1/4-10	152588	PUN-10x1,5	2316	U-1/4
Ø 50 mm									
225	MPYE-5-1/8-LF-010-B	153004	QS-1/8-8	153005	QS-1/4-8	152587	PUN-8x1,25	2307	U-1/8
300 ... 360	MPYE-5-1/8-HF-010-B								
450 ... 500	MPYE-5-1/4-010-B	153007	QS-1/4-10	153007	QS-1/4-10	152588	PUN-10x1,5	2316	U-1/4
600 ... 2,000	MPYE-5-3/8-010-B	153008	QS-3/8-10					2309	U-3/8
Ø 63 mm									
225 ... 300	MPYE-5-1/8-HF-010-B	153004	QS-1/8-8	153006	QS-3/8-8	152587	PUN-8x1,25	2307	U-1/8
360 ... 450	MPYE-5-1/4-010-B	153007	QS-1/4-10	153008	QS-3/8-10	152588	PUN-10x1,5	2316	U-1/4
500 ... 2,000	MPYE-5-3/8-010-B	153009	QS-3/8-12	153009	QS-3/8-12	152589	PUN-12x2	2309	U-3/8

1) Fittings sold only in packs of 10.

2) 2 pieces are required.

End position controllers SPC11

Technical data

FESTO

Accessories for the solution package for DGP/DGPL, DGPI/DGPIL horizontally mounted

For effective cylinder stroke 225 ... 2,000 mm

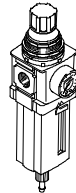
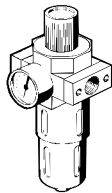

Ordering data								
Effective cylinder stroke DGP/L, DGPI/L-... [mm]	Filter regulator, D series with filter cartridge 5 µm		Filter cartridge 5 µm D series		Filter regulator, MS series with filter cartridge 5 µm		Filter cartridge 5 µm MS series	
	Part No.	Type	Part No.	Type	Part No.	Type	Part No.	Type
Ø 25 mm								
225 ... 2,000	162719	LFR-¼-D-5M-MINI	159640	LFP-D-MINI-5M	529152	MS4-LFR-¼-D7-CRM-AS	534501	MS4-LFP-C
Ø 32 mm								
225 ... 600	162719	LFR-¼-D-5M-MINI	159640	LFP-D-MINI-5M	529152	MS4-LFR-¼-D7-CRM-AS	534501	MS4-LFP-C
750 ... 2,000	162721	LFR-⅜-D-5M-MIDI	159594	LFP-D-MIDI-5M	529204	MS6-LFR-¼-D7-CRM-AS	534499	MS6-LFP-C
Ø 40 mm								
225 ... 500	162719	LFR-¼-D-5M-MINI	159640	LFP-D-MINI-5M	529152	MS4-LFR-¼-D7-CRM-AS	534501	MS4-LFP-C
600 ... 2,000	162721	LFR-⅜-D-5M-MIDI	159594	LFP-D-MIDI-5M	529204	MS6-LFR-¼-D7-CRM-AS	534499	MS6-LFP-C
Ø 50 mm								
225 ... 360	162719	LFR-¼-D-5M-MINI	159640	LFP-D-MINI-5M	529152	MS4-LFR-¼-D7-CRM-AS	534501	MS4-LFP-C
450 ... 500	162721	LFR-⅜-D-5M-MIDI	159594	LFP-D-MIDI-5M	529204	MS6-LFR-¼-D7-CRM-AS	534499	MS6-LFP-C
600 ... 2,000	162724	LFR-¾-D-5M-MAXI	159641	LFP-D-MAXI-5M	529224	MS6-LFR-⅜-D7-CRM-AS	534499	MS6-LFP-C
Ø 63 mm								
225 ... 300	162719	LFR-¼-D-5M-MINI	159640	LFP-D-MINI-5M	529152	MS4-LFR-¼-D7-CRM-AS	534501	MS4-LFP-C
360 ... 450	162721	LFR-⅜-D-5M-MIDI	159594	LFP-D-MIDI-5M	529204	MS6-LFR-¼-D7-CRM-AS	534499	MS6-LFP-C
500 ... 2,000	162724	LFR-¾-D-5M-MAXI	159641	LFP-D-MAXI-5M	529224	MS6-LFR-⅜-D7-CRM-AS	534499	MS6-LFP-C

End position controllers SPC11

Technical data

FESTO

Accessories for the solution package for DGP/DGPL, DGPI/DGPIL vertically mounted

For effective cylinder stroke 225 ... 2,000 mm

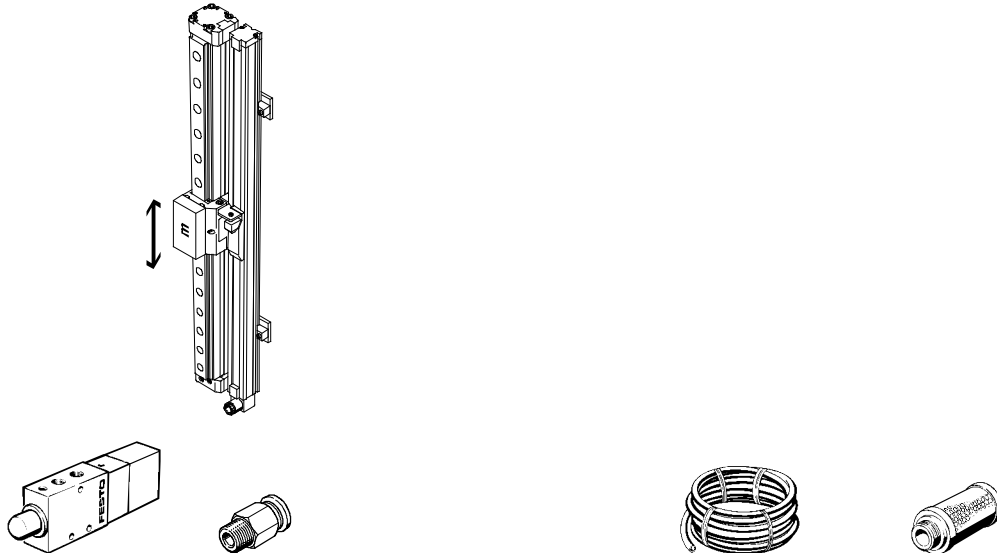

Ordering data									
Effective cylinder stroke DGP/L, DGPI/L [mm]	Proportional 5/3-way valve Type	Fittings ¹⁾				Compressed air tubing		Silencer ²⁾	
		For MPYE-5-...		DGP/L, DGPI/L		Part No.	Type	Part No.	Type
		Part No.	Type	Part No.	Type			Part No.	Type
Ø 25 mm									
225 ... 500	MPYE-5-1/8-LF-010-B	153004	QS-1/8-8	153004	QS-1/8-8	152587	PUN-8x1,25	2307	U-1/8
600 ... 750	MPYE-5-1/8-HF-010-B								
1,000 ... 2,000	MPYE-5-1/4-010-B	153005	QS-1/4-8					2316	U-1/4
Ø 32 mm									
225 ... 600	MPYE-5-1/8-LF-010-B	153004	QS-1/8-8	153004	QS-1/8-8	152587	PUN-8x1,25	2307	U-1/8
750	MPYE-5-1/8-HF-010-B								
1,000 ... 2,000	MPYE-5-1/4-010-B	153005	QS-1/4-8					2316	U-1/4
Ø 40 mm									
225 ... 450	MPYE-5-1/8-LF-010-B	153004	QS-1/8-8	153005	QS-1/4-8	152587	PUN-8x1,25	2307	U-1/8
500	MPYE-5-1/8-HF-010-B			153005	QS-1/4-8				
600	MPYE-5-1/4-010-B	153007	QS-1/4-10	153007	QS-1/4-10	152588	PUN-10x1,5	2316	U-1/4
750 ... 2,000	MPYE-5-3/8-010-B	153008	QS-3/8-10					2309	U-3/8
Ø 50 mm									
225 ... 300	MPYE-5-1/8-LF-010-B	153004	QS-1/8-8	153005	QS-1/4-8	152587	PUN-8x1,25	2307	U-1/8
360 ... 450	MPYE-5-1/8-HF-010-B								
500 ... 600	MPYE-5-1/4-010-B	153007	QS-1/4-10	153007	QS-1/4-10	152588	PUN-10x1,5	2316	U-1/4
750 ... 2,000	MPYE-5-3/8-010-B	153008	QS-3/8-10					2309	U-3/8
Ø 63 mm									
225	MPYE-5-1/8-LF-010-B	153004	QS-1/8-8	153006	QS-3/8-8	152587	PUN-8x1,25	2307	U-1/8
300	MPYE-5-1/8-HF-010-B								
360 ... 450	MPYE-5-1/4-010-B	153007	QS-1/4-10	153008	QS-3/8-10	152588	PUN-10x1,5	2316	U-1/4
500 ... 2,000	MPYE-5-3/8-010-B	153009	QS-3/8-12	153009	QS-3/8-12	152589	PUN-12x2	2309	U-3/8

1) Fittings sold only in packs of 10.

2) 2 pieces are required.

End position controllers SPC11

Technical data

FESTO

Accessories for the solution package for DGP/DGPL, DGPI/DGPIL vertically mounted

For effective cylinder stroke 225 ... 2,000 mm

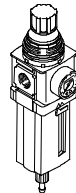
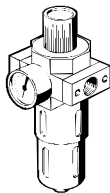

Ordering data								
Effective cylinder stroke DGP/L, DGPI/L [mm]	Filter regulator, D series with filter cartridge 5 µm		Filter cartridge 5 µm D series		Filter regulator, MS series with filter cartridge 5 µm		Filter cartridge 5 µm MS series	
	Part No.	Type	Part No.	Type	Part No.	Type	Part No.	Type
Ø 25 mm								
225 ... 750	162719	LFR-¼-D-5M-MINI	159640	LFP-D-MINI-5M	529152	MS4-LFR-¼-D7-CRM-AS	534501	MS4-LFP-C
1,000 ... 2,000	162721	LFR-¾-D-5M-MIDI	159594	LFP-D-MIDI-5M	529204	MS6-LFR-¼-D7-CRM-AS	534499	MS6-LFP-C
Ø 32 mm								
225 ... 750	162719	LFR-¼-D-5M-MINI	159640	LFP-D-MINI-5M	529152	MS4-LFR-¼-D7-CRM-AS	534501	MS4-LFP-C
1,000 ... 2,000	162721	LFR-¾-D-5M-MIDI	159594	LFP-D-MIDI-5M	529204	MS6-LFR-¼-D7-CRM-AS	534499	MS6-LFP-C
Ø 40 mm								
225 ... 500	162719	LFR-¼-D-5M-MINI	159640	LFP-D-MINI-5M	529152	MS4-LFR-¼-D7-CRM-AS	534501	MS4-LFP-C
600	162721	LFR-¾-D-5M-MIDI	159594	LFP-D-MIDI-5M	529204	MS6-LFR-¼-D7-CRM-AS	534499	MS6-LFP-C
750 ... 2,000	162724	LFR-¾-D-5M-MAXI	159641	LFP-D-MAXI-5M	529224	MS6-LFR-¾-D7-CRM-AS		
Ø 50 mm								
225 ... 300	162719	LFR-¼-D-5M-MINI	159640	LFP-D-MINI-5M	529152	MS4-LFR-¼-D7-CRM-AS	534501	MS4-LFP-C
360 ... 600	162721	LFR-¾-D-5M-MIDI	159594	LFP-D-MIDI-5M	529204	MS6-LFR-¼-D7-CRM-AS	534499	MS6-LFP-C
750 ... 2,000	162724	LFR-¾-D-5M-MAXI	159641	LFP-D-MAXI-5M	529224	MS6-LFR-¾-D7-CRM-AS		
Ø 63 mm								
225 ... 300	162719	LFR-¼-D-5M-MINI	159640	LFP-D-MINI-5M	529152	MS4-LFR-¼-D7-CRM-AS	534501	MS4-LFP-C
360 ... 450	162721	LFR-¾-D-5M-MIDI	159594	LFP-D-MIDI-5M	529204	MS6-LFR-¼-D7-CRM-AS	534499	MS6-LFP-C
500 ... 2,000	162724	LFR-¾-D-5M-MAXI	159641	LFP-D-MAXI-5M	529224	MS6-LFR-¾-D7-CRM-AS		

End position controllers SPC11

Technical data

Order example

For the pneumatic drive DNC with displacement encoder LWG

A workpiece weighing 55 kg is to be moved horizontally on a loading station. The workpiece gripper attached to the piston rod of the drive weighs 40 kg. The total weight to be moved is therefore 95 kg. The desired

travel distance is 300 mm. The travel time is to be < 1.5 seconds.

Step 1: Selecting the cylinder stroke

For a travel distance of 300 mm, use the table on → 25 to select the next-largest standard stroke of 320 mm or the effective cylinder stroke of 291 ... 350 mm. This column has a grey background.

Step 2: Specifying the drive

For a total weight of 95 kg to be moved horizontally, there is a choice of piston diameters of 50, 63 and 80 mm (see data for max. total weight to be moved). For the purposes of our example, the drive DNC-50-320-PPV-A, part no. 163 378 has been selected.

Step 3: Specifying the displacement encoder

The appropriate length of the displacement encoder is governed by the effective cylinder stroke. The column with the grey background in the "Displacement encoder" section of the table shows Part No. 152 647 for this example.

 - Note

Sizing software
Smart Soft Stop and ProDrive
→ www.festo.com

 - Note

Remember when selecting the drive mounting components that some of these are not backlash-free and therefore cannot be used with the Smart Soft Stop system. The drives must be mounted directly.

 - Note

Check that the loads placed on the drive by a gripper during movement do not exceed permissible limits. To carry out simulation quickly and easily, use the Smart Soft Stop software tool.

 - Note

The self-aligning rod coupler FK is not backlash-free. It must therefore be used in combination with standard cylinder DNC.

 - Note

The linear potentiometer is supplied separately and must be mounted by the user.

Step 4: Specifying a proportional 5/3-way valve

The appropriate proportional 5/3-way valve is shown at the intersection of the grey column used in step 1 and the line for the selected pneumatic drive DNC-50... in the "Proportional 5/3-way valve" section of the table. For the purposes of our example, the proportional 5/3-way valve MPYE-5-1/8- HF-010B, part no. 151 693 has been selected.

Step 5: Completing the order information

To order a complete system you must add the data for the end position controller, valve and controller cables and manual (if required). The complete ordering data for our example can be found on → 25. A manual should normally be ordered. If you already have one, leave the appropriate box blank, indicating that you do not want a manual.

Step 6: Determining the travel time

To calculate the travel time use the "Smart Soft Stop" software tool. The travel time for the order example is 0.96 seconds.

Ordering data							
Pneumatic drive		Displacement encoder		Proportional 5/3-way valve		End position controller	
Part No.	Type	Part No.	Type	Part No.	Type	Part No.	Type
163378	DNC-50-320-PPV-A	152647	MLO-POT-360-LWG	151693	MPYE-5-1/8-HF-010B	192217	SPC11-POT-LWG

Valve cable		Controller cable	
Part No.	Type	Part No.	Type
170238	KMPYE-AIF-1-GS-GD-2	177674	KMPV-SUB-D-15-10

End position controllers SPC11

Technical data

Step 1 and 2:											
Standard cylinders/Type		DNC-... ¹⁾ ... ²⁾ -PPV-A									
Max. effective cylinder stroke	[mm]	100	150	150	225	225	300	360	450	600	750
Effective cylinder stroke (standard stroke)	[mm]	80	100	125	160	200	250	320	400	500	650
Max. overall mass to be moved horizontally by \varnothing	32	45 kg									
	40	75 kg									
	50	120 kg									
	63	180 kg									
	80	300 kg									
Part No. for \varnothing	32	163 308	163 309	163 310	163 311	163 312	163 313	163 314	163 315	163 316	163 304
	40	163 340	163 341	163 342	163 343	163 344	163 345	163 346	163 347	163 348	163 336
	50	163 372	163 373	163 374	163 375	163 376	163 377	163 378	163 379	163 380	163 368
	63	163 404	163 405	163 406	163 407	163 408	163 409	163 410	163 411	163 412	163 400
	80	163 436	163 437	163 438	163 439	163 440	163 441	163 442	163 443	163 444	163 432

Step 3:											
Displacement encoder ³⁾		MLO-POT-...-LWG									
Max. effective cylinder stroke	[mm]	100	150	150	225	225	300	360	450	600	750
Potentiometer length	[mm]	100	150	150	225	225	300	360	450	600	750
Part No.		192 213	192 214	192 214	152 645	152 645	152 646	152 647	152 648	152 650	152 651

Step 4:											
Proportional 5/3-way valves ⁴⁾		1 = 151 692 MPYE-5-1/8-LF-010-B					3 = 151 694 MPYE-5-1/4-010-B				
Part No./Type		2 = 151 693 MPYE-5-1/8-HF-010-B					4 = 151 695 MPYE-5-3/8-010-B				
Max. effective cylinder stroke	[mm]	100	150	150	225	225	300	360	450	600	750
Horizontal for \varnothing	32	1	1	1	1	1	1	1	1	2	2
	40	1	1	1	1	1	1	2	2	3	3
	50	1	1	1	1	1	1	2	2	3	3
	63	1	1	1	1	2	2	2	3	3	4
	80	1	1	2	2	3	3	3	3	4	4

Step 5:				
End position controllers and accessories	Part No.	Type	Brief description	
End position controller	192217	SPC11-POT-LWG		
Cable	Valve	170238	KMPYE-AIF-1-GS-GD-2	Cable length 2 m
		170239	KMPYE-AIF-1-GS-GD-0,3	Cable length 0.3 m
	SPC11/PLC	177673	KMPV-SUB-D-15-5	Cable length 5 m
		177674	KMPV-SUB-D-15-10	Cable length 10 m

 Note
Manuals → 37

- 1) Indicate piston \varnothing . Technical data and dimensions → www.festo.com.
- 2) Indicate calculated effective stroke of cylinder.
- 3) Technical data and dimensions → www.festo.com.
- 4) Technical data and dimensions → www.festo.com.

End position controllers SPC11

Technical data

FESTO

Accessories for the solution package for DNC horizontally mounted

For effective cylinder stroke 80 ...750 mm

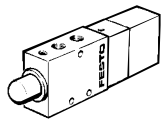
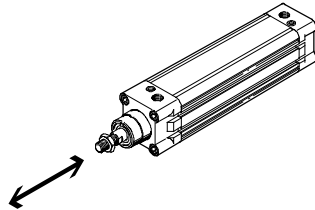

Ordering data									
Effective cylinder stroke DNC-... [mm]	Proportional 5/3-way valve Type	Fittings ¹⁾				Compressed air tubing		Silencer ²⁾	
		For MPYE-5-...		DNC		Part No.	Type	Part No.	Type
		Part No.	Type	Part No.	Type	Part No.	Type	Part No.	Type
Ø 32 mm									
80 ... 440	MPYE-5-1/8-LF-010-B	153004	QS-1/8-8	153004	QS-1/8-8	152587	PUN-8x1,25	2307	U-1/8
441 ... 735	MPYE-5-1/8-HF-010-B								
Ø 40 mm									
80 ... 290	MPYE-5-1/8-LF-010-B	153004	QS-1/8-8	153005	QS-1/4-8	152587	PUN-8x1,25	2307	U-1/8
291 ... 440	MPYE-5-1/8-HF-010-B			153005	QS-1/4-8				
441 ... 735	MPYE-5-1/4-010-B	153007	QS-1/4-10	153007	QS-1/4-10	152588	PUN-10x1,5	2316	U-1/4
Ø 50 mm									
80 ... 290	MPYE-5-1/8-LF-010-B	153004	QS-1/8-8	153005	QS-1/4-8	152587	PUN-8x1,25	2307	U-1/8
291 ... 440	MPYE-5-1/8-HF-010-B								
441 ... 735	MPYE-5-1/4-010-B	153007	QS-1/4-10	153007	QS-1/4-10	152588	PUN-10x1,5	2316	U-1/4
Ø 63 mm									
80 ... 175	MPYE-5-1/8-LF-010-B	153004	QS-1/8-8	153006	QS-3/8-8	152587	PUN-8x1,25	2307	U-1/8
176 ... 350	MPYE-5-1/8-HF-010-B			153006	QS-3/8-8				
351 ... 590	MPYE-5-1/4-010-B	153007	QS-1/4-10	153008	QS-3/8-10	152588	PUN-10x1,5	2316	U-1/4
591 ... 735	MPYE-5-3/8-010-B	153009	QS-3/8-12	153009	QS-3/8-12	152589	PUN-12x2	2309	U-3/8
Ø 80 mm									
80 ... 115	MPYE-5-1/8-LF-010-B	153004	QS-1/8-8	153006	QS-3/8-8	152587	PUN-8x1,25	2307	U-1/8
116 ... 175	MPYE-5-1/8-HF-010-B			153006	QS-3/8-8				
176 ... 440	MPYE-5-1/4-010-B	153007	QS-1/4-10	153008	QS-3/8-10	152588	PUN-10x1,5	2316	U-1/4
441 ... 735	MPYE-5-3/8-010-B	153009	QS-3/8-12	153009	QS-3/8-12	152589	PUN-12x2	2309	U-3/8

1) Fittings sold only in packs of 10.

2) 2 pieces are required.

End position controllers SPC11

Technical data

FESTO

Accessories for the solution package for DNC horizontally mounted

For effective cylinder stroke 80 ...750 mm

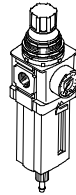
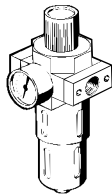

Ordering data								
Effective cylinder stroke DNC-... [mm]	Filter regulator, D series with filter cartridge 5 µm		Filter cartridge 5 µm D series		Filter regulator, MS series with filter cartridge 5 µm		Filter cartridge 5 µm MS series	
	Part No.	Type	Part No.	Type	Part No.	Type	Part No.	Type
Ø 32 mm								
80 ... 735	162719	LFR-¼-D-5M-MINI	159640	LFP-D-MINI-5M	529152	MS4-LFR-¼-D7-CRM-AS	534501	MS4-LFP-C
Ø 40 mm								
80 ... 440	162719	LFR-¼-D-5M-MINI	159640	LFP-D-MINI-5M	529152	MS4-LFR-¼-D7-CRM-AS	534501	MS4-LFP-C
441 ... 735	162721	LFR-⅜-D-5M-MIDI	159594	LFP-D-MIDI-5M	529204	MS6-LFR-¼-D7-CRM-AS	534499	MS6-LFP-C
Ø 50 mm								
80 ... 440	162719	LFR-¼-D-5M-MINI	159640	LFP-D-MINI-5M	529152	MS4-LFR-¼-D7-CRM-AS	534501	MS4-LFP-C
441 ... 735	162721	LFR-⅜-D-5M-MIDI	159594	LFP-D-MIDI-5M	529204	MS6-LFR-¼-D7-CRM-AS	534499	MS6-LFP-C
Ø 63 mm								
80 ... 350	162719	LFR-¼-D-5M-MINI	159640	LFP-D-MINI-5M	529152	MS4-LFR-¼-D7-CRM-AS	534501	MS4-LFP-C
351 ... 590	162721	LFR-⅜-D-5M-MIDI	159594	LFP-D-MIDI-5M	529204	MS6-LFR-¼-D7-CRM-AS	534499	MS6-LFP-C
591 ... 735	162724	LFR-¾-D-5M-MAXI	159641	LFP-D-MAXI-5M	529224	MS6-LFR-⅜-D7-CRM-AS	534499	MS6-LFP-C
Ø 80 mm								
80 ... 175	162719	LFR-¼-D-5M-MINI	159640	LFP-D-MINI-5M	529152	MS4-LFR-¼-D7-CRM-AS	534501	MS4-LFP-C
176 ... 440	162721	LFR-⅜-D-5M-MIDI	159594	LFP-D-MIDI-5M	529204	MS6-LFR-¼-D7-CRM-AS	534499	MS6-LFP-C
441 ... 735	162724	LFR-¾-D-5M-MAXI	159641	LFP-D-MAXI-5M	529224	MS6-LFR-⅜-D7-CRM-AS	534499	MS6-LFP-C

End position controllers SPC11

Technical data

Order example

For pneumatic standard drive DNCI with integrated displacement encoder

A workpiece weighing 55 kg is to be moved horizontally on a loading station. The workpiece gripper

attached to the piston rod of the drive weighs 40 kg. The total weight to be moved is therefore 95 kg. The desired

travel distance is 300 mm. The travel time is to be < 1.5 seconds.

Step 1: Selecting the cylinder stroke

For a travel distance of 300 mm, use the table on → 29 to select the next-largest standard stroke of 320 mm or the effective cylinder stroke of 320 mm. This column has a grey background.

Step 2: Specifying the drive

For a total weight of 95 kg to be moved horizontally, there is a choice of piston diameters of 50 and 63 mm (see data for max. total weight to be moved).

For the purposes of our example, the drive DNCI-50-320-P-A, part no. 535 413 has been selected.

Step 3: Specifying a proportional 5/3-way valve

The appropriate proportional 5/3-way valve is shown at the intersection of the grey column used in step 1 and the line for the selected pneumatic drive DNCI-50-... in the "Proportional 5/3-way valve" section of the table. For the purposes of our example, the proportional-5/3-way valve MPYE-5-1/8-HF-010B, part no. 151 693 has been selected.

Step 4: Completing the order information

To order a complete system you must add the data for the end position controller, valve and controller cables and manual (if required). The complete ordering data for our example can be found on → 29. A manual should normally be ordered. If you already have one, leave the appropriate box blank, indicating that you do not want a manual.

Step 5: Determining the travel time

To calculate the travel time use the "Smart Soft Stop" software tool. The travel time for the order example is 0.92 seconds.

-  - Note
Sizing software
Smart Soft Stop and ProDrive
→ www.festo.com

-  - Note
Remember when selecting the drive mounting components that some of these are not backlash-free and therefore cannot be used with the Smart Soft Stop system. The drives must be mounted directly.

-  - Note
Check that the loads placed on the drive by a gripper during movement do not exceed permissible limits. To carry out simulation quickly and easily, use the Smart Soft Stop software tool.

-  - Note
The self-aligning rod coupler FK is not backlash-free. It must not therefore be used in combination with standard cylinder DNCI.

Ordering data					
Pneumatic drive		Proportional 5/3-way valve		End position controller	
Part No.	Type	Part No.	Type	Part No.	Type
535413	DNCI-50-320-P-A	151693	MPYE-5-1/8-HF-010B	537321	SPC11-INC

Valve cable		Controller cable	
Part No.	Type	Part No.	Type
170238	KMPYE-AIF-1-GS-GD-2	177674	KMPV-SUB-D-15-10

End position controllers SPC11

Technical data

Step 1 and 2:		DNCI-... ¹⁾ -... ²⁾ -P-A						
Standard cylinders/Type								
Effective cylinder stroke (standard stroke)	[mm]	100	160	200	250	320	400	500
Max. overall mass to be moved horizontally by \varnothing	32	45 kg						
	40	75 kg						
	50	120 kg						
	63	180 kg						
Part No. for \varnothing	32	535 411						
	40	535 412						
	50	535 413						
	63	535 414						

Step 3:		1 = 151 692 MPYE-5-1/8-LF-010-B 3 = 151 694 MPYE-5-1/4-010-B						
Proportional 5/3-way valves ³⁾		2 = 151 693 MPYE-5-1/8-HF-010-B						
Part No./Type								
Effective cylinder stroke (standard stroke)	[mm]	100	160	200	250	320	400	500
Horizontal for \varnothing	32	1	1	1	1	1	1	2
	40	1	1	1	1	2	2	2
	50	1	1	1	1	2	2	3
	63	1	1	2	2	2	3	3

Step 4:		Part No.	Type	Brief description
End position controllers and accessories				
End position controller	SPC11	537321	SPC11-INC	
Cable	Valve	170238	KMPYE-AIF-1-GS-GD-2	Cable length 2 m
		170239	KMPYE-AIF-1-GS-GD-0,3	Cable length 0.3 m
	SPC11/PLC	177673	KMPV-SUB-D-15-5	Cable length 5 m
		177674	KMPV-SUB-D-15-10	Cable length 10 m

 Note
Manuals → 37

- 1) Indicate piston \varnothing . Technical data and dimensions → www.festo.com.
- 2) Indicate calculated effective stroke of cylinder.
- 3) Technical data and dimensions → www.festo.com.

End position controllers SPC11

Technical data

FESTO

Accessories for the solution package for DNCI horizontally mounted

For effective cylinder stroke 100 ...500 mm

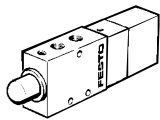
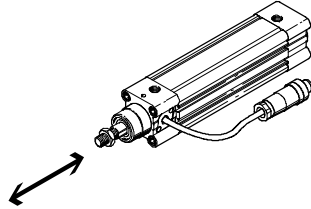

Ordering data									
Effective cylinder stroke DNCI-... [mm]	Proportional 5/3-way valve Type	Fittings ¹⁾				Compressed air tubing		Silencer ²⁾	
		For MPYE-5-...		DNCI		Part No.	Type	Part No.	Type
		Part No.	Type	Part No.	Type	Part No.	Type	Part No.	Type
Ø 32 mm									
100 ... 400	MPYE-5-1/8-LF-010-B	153004	QS-1/8-8	153004	QS-1/8-8	152587	PUN-8x1,25	2307	U-1/8
500	MPYE-5-1/8-HF-010-B								
Ø 40 mm									
100 ... 250	MPYE-5-1/8-LF-010-B	153004	QS-1/8-8	153005	QS-1/4-8	152587	PUN-8x1,25	2307	U-1/8
320 ... 500	MPYE-5-1/8-HF-010-B			153005	QS-1/4-8				
Ø 50 mm									
100 ... 250	MPYE-5-1/8-LF-010-B	153004	QS-1/8-8	153005	QS-1/4-8	152587	PUN-8x1,25	2307	U-1/8
320 ... 400	MPYE-5-1/8-HF-010-B								
500	MPYE-5-1/4-010-B	153007	QS-1/4-10	153007	QS-1/4-10	152588	PUN-10x1,5	2316	U-1/4
Ø 63 mm									
100 ... 160	MPYE-5-1/8-LF-010-B	153004	QS-1/8-8	153006	QS-3/8-8	152587	PUN-8x1,25	2307	U-1/8
200 ... 320	MPYE-5-1/8-HF-010-B			153006	QS-3/8-8				
400 ... 500	MPYE-5-1/4-010-B	153007	QS-1/4-10	153008	QS-3/8-10	152588	PUN-10x1,5	2316	U-1/4

1) Fittings sold only in packs of 10.

2) 2 pieces are required.

End position controllers SPC11

Technical data

FESTO

Accessories for the solution package for DNCI horizontally mounted

For effective cylinder stroke 100 ...500 mm

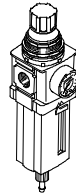
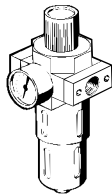

Ordering data								
Effective cylinder stroke DNCI-... [mm]	Filter regulator, D series with filter cartridge 5 µm		Filter cartridge 5 µm D series		Filter regulator, MS series with filter cartridge 5 µm		Filter cartridge 5 µm MS series	
	Part No.	Type	Part No.	Type	Part No.	Type	Part No.	Type
Ø 32 mm								
100 ... 500	162719	LFR-¼-D-5M-MINI	159640	LFP-D-MINI-5M	529152	MS4-LFR-¼-D7-CRM-AS	534501	MS4-LFP-C
Ø 40 mm								
100 ... 400	162719	LFR-¼-D-5M-MINI	159640	LFP-D-MINI-5M	529152	MS4-LFR-¼-D7-CRM-AS	534501	MS4-LFP-C
500	162721	LFR-⅜-D-5M-MIDI	159594	LFP-D-MIDI-5M	529204	MS6-LFR-¼-D7-CRM-AS	534499	MS6-LFP-C
Ø 50 mm								
100 ... 400	162719	LFR-¼-D-5M-MINI	159640	LFP-D-MINI-5M	529152	MS4-LFR-¼-D7-CRM-AS	534501	MS4-LFP-C
500	162721	LFR-⅜-D-5M-MIDI	159594	LFP-D-MIDI-5M	529204	MS6-LFR-¼-D7-CRM-AS	534499	MS6-LFP-C
Ø 63 mm								
100 ... 320	162719	LFR-¼-D-5M-MINI	159640	LFP-D-MINI-5M	529152	MS4-LFR-¼-D7-CRM-AS	534501	MS4-LFP-C
400 ... 500	162721	LFR-⅜-D-5M-MIDI	159594	LFP-D-MIDI-5M	529204	MS6-LFR-¼-D7-CRM-AS	534499	MS6-LFP-C

End position controllers SPC11

Technical data

Order example for swivel module DSMI

A workpiece with a mass moment of inertia of $400 \text{ kgm}^2 \times 10^{-4}$ is to be moved on an unloading station. The workpiece gripper attached to the

shaft of the swivel module has a mass moment of inertia of $230 \text{ kgm}^2 \times 10^{-4}$. The total mass moment of inertia to be moved is therefore $630 \text{ kgm}^2 \times 10^{-4}$.

The swivel angle is 250° . The travel time is to be < 1 second.

-  - Note
Sizing software
Smart Soft Stop and ProDrive
→ www.festo.com

Step 1: Specifying the swivel angle

The maximum swivel angle of the swivel modules DSMI-25-270 and DSMI-40-270 is 270° and can be fully exploited. The integrated displacement encoder is appropriately designed.

Step 2: Specifying the drive

DSMI-40-270 must be used for the total mass moment of inertia of $630 \text{ kgm}^2 \times 10^{-4}$ to be moved horizontally
→ 33.

Step 3: Specifying a proportional 5/3-way valve

As can be seen from the table → 33, the proportional 5/3-way valve MPYE-5-1/8-LF-010B is generally required for swivel module DSMI-40-270.

-  - Note
Remember when selecting the drive mounting components that some of these are not backlash-free and therefore cannot be used with the Smart Soft Stop system. The drives must be mounted directly.

Step 4: Completing the order information

To order a complete system you must add the data for the end position controller, valve and controller cables and manual (if required). The complete ordering data for our example can be found on → 33. A manual should normally be ordered. If you already have one, leave the appropriate box blank, indicating an express waiver of a manual.

Step 5: Determining the travel time

To calculate the travel time use the "Smart Soft Stop" software tool. The travel time for the order example is 0.89 seconds.

-  - Note
Check that the loads placed on the drive by a gripper during the movement process do not exceed permissible limits. To carry out simulation quickly and easily, use the Smart Soft Stop software tool.

Ordering data					
Swivel module		Proportional 5/3-way valve		End position controller	
Part No.	Type	Part No.	Type	Part No.	Type
561691	DSMI-40-270-A-B	151692	MPYE-5-1/8-LF-010B	192217	SPC11-POT-LWG
Valve cable			Controller cable		
Part No.	Type	Part No.	Type		
170238	KMPYE-AIF-1-GS-GD-2	177674	KMPV-SUB-D-15-10		

End position controllers SPC11

Technical data

Step 1 and 2:		
Swivel module with integrated displacement encoder	DSMI-25-270-A-B	DSMI-40-270-A-B
Swivel angle	270°	
Max. permissible mass moment of inertia, horizontal	300 kgm ² x10 ⁻⁴	1,200 kgm ² x10 ⁻⁴
Part No.	561690	561691

Step 3				
Proportional 5/3-way valves ¹⁾	Part No.	Type	Part No.	Type
	154200	MPYE-5-M5-010B	151692	MPYE-5-1/8-LF-010B

Step 4				
End position controllers and accessories	Part No.	Type	Brief description	
End position controller SPC11	192217	SPC11-POT-LWG		
Cable	Valve	170238	KMPYE-AIF-1-GS-GD-2	Cable length 2 m
		170239	KMPYE-AIF-1-GS-GD-0,3	Cable length 0.3 m
	SPC11/PLC	177673	KMPV-SUB-D-15-5	Cable length 5 m
		177674	KMPV-SUB-D-15-10	Cable length 10 m

-  - Note
Manuals → 37

1) Technical data and dimensions → www.festo.com.

End position controllers SPC11

Technical data

FESTO

Accessories for the solution package for DSMI horizontally mounted

For swivel angle 0° ... 270°

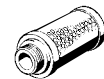
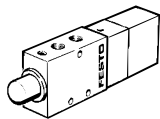
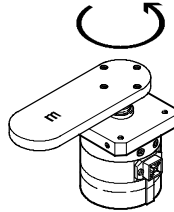

Ordering data									
Swivel angle DSMI	Proportional 5/3-way valve Type	Fittings ¹⁾				Compressed air tubing		Silencer ²⁾	
		For MPYE-5-...		DSMI		Part No.	Type	Part No.	Type
		Part No.	Type	Part No.	Type	Part No.	Type	Part No.	Type
Ø 25 mm									
0° ... 270°	MPYE-5-M5-010-B	153306	QSM-M5-6	153306	QSM-M5-6	152586	PUN-6x1	4645	U-M5
Ø 40 mm									
0° ... 270°	MPYE-5-1/8-LF-010-B	153004	QS-1/8-8	153004	QS-1/8-8	152587	PUN-8x1,25	2307	U-1/8

1) Fittings sold only in packs of 10.

2) 2 pieces are required.

End position controllers SPC11

Technical data

FESTO

Accessories for the solution package for DSMI horizontally mounted

For swivel angle 0° ... 270°

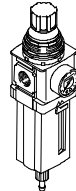
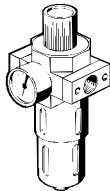

Ordering data								
Swivel angle DSMI	Filter regulator, D series with filter cartridge 5 µm		Filter cartridge 5 µm D series		Filter regulator, MS series with filter cartridge 5 µm		Filter cartridge 5 µm MS series	
	Part No.	Type	Part No.	Type	Part No.	Type	Part No.	Type
Ø 25 mm								
0° ... 270°	162719	LFR-¼-D-5M-MINI	159640	LFP-D-MINI-5M	529152	MS4-LFR-¼-D7-CRM-AS	534501	MS4-LFP-C
Ø 40 mm								
0° ... 270°	162719	LFR-¼-D-5M-MINI	159640	LFP-D-MINI-5M	529152	MS4-LFR-¼-D7-CRM-AS	534501	MS4-LFP-C

End position controllers SPC11

Technical data

Mass moment of inertia calculation with the aid of Festo software

Software tool: Mass moment of inertia



No matter whether you have discs, blocks, push-on flanges, grippers, etc: This tool does the job of calculating all mass moments of inertia for you. Just save, send, or print – and you're finished.

-  - Note
Sizing software
Inertia calculations
➔ www.festo.com

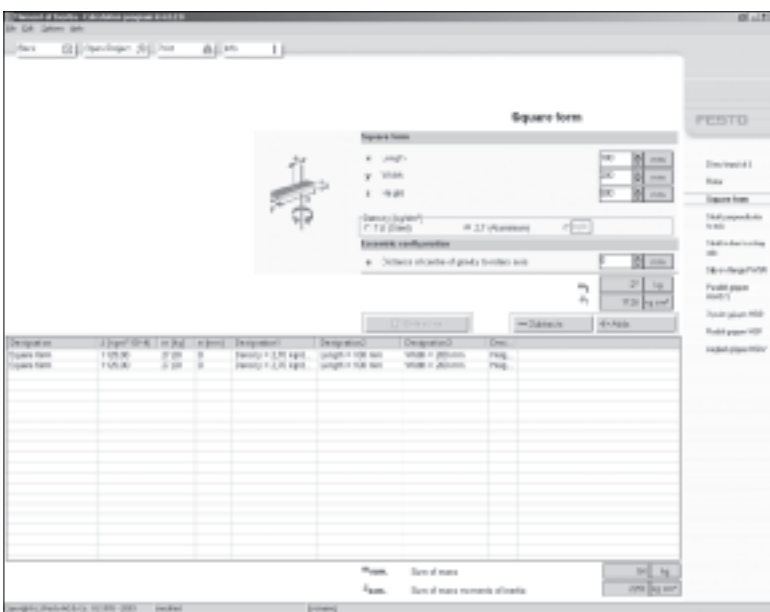

End position controllers SPC11

Technical data

Ordering data – Manuals							
		Part No.	Type		Part No.	Type	
System description – End position controllers							
SPC11	German	196723	P.BE-SPC11-SYS-DE				
	English	196724	P.BE-SPC11-SYS-EN				
	French	196727	P.BE-SPC11-SYS-FR				
	Italian	196726	P.BE-SPC11-SYS-IT				
	Swedish	196728	P.BE-SPC11-SYS-SV				
	Spanish	196725	P.BE-SPC11-SYS-ES				
Drive-specific supplement							
For DGCI				For DGP/DGPL/DGPI/DGPIL			
SPC11	German	549166	P.BE-SPC11-DGCI-DE	SPC11	German	196729	P.BE-SPC11-DGP-DE
	English	549167	P.BE-SPC11-DGCI-EN		English	196730	P.BE-SPC11-DGP-EN
	French	549169	P.BE-SPC11-DGCI-FR		French	196733	P.BE-SPC11-DGP-FR
	Italian	549170	P.BE-SPC11-DGCI-IT		Italian	196732	P.BE-SPC11-DGP-IT
	Swedish	549171	P.BE-SPC11-DGCI-SV		Swedish	196734	P.BE-SPC11-DGP-SV
	Spanish	549168	P.BE-SPC11-DGCI-ES		Spanish	196731	P.BE-SPC11-DGP-ES
For DNC				For DNCI			
SPC11	German	196735	P.BE-SPC11-DNC-DE	SPC11	German	539888	P.BE-SPC11-DNCI-DE
	English	196736	P.BE-SPC11-DNC-EN		English	539889	P.BE-SPC11-DNCI-EN
	French	196739	P.BE-SPC11-DNC-FR		French	539891	P.BE-SPC11-DNCI-FR
	Italian	196738	P.BE-SPC11-DNC-IT		Italian	539892	P.BE-SPC11-DNCI-IT
	Swedish	196740	P.BE-SPC11-DNC-SV		Swedish	539893	P.BE-SPC11-DNCI-SV
	Spanish	196737	P.BE-SPC11-DNC-ES		Spanish	539890	P.BE-SPC11-DNCI-ES
For DSMI							
SPC11	German	196741	P.BE-SPC11-DSMI-DE				
	English	196742	P.BE-SPC11-DSMI-EN				
	French	196745	P.BE-SPC11-DSMI-FR				
	Italian	196744	P.BE-SPC11-DSMI-IT				
	Swedish	196746	P.BE-SPC11-DSMI-SV				
	Spanish	196743	P.BE-SPC11-DSMI-ES				

End position controllers SPC11

Technical data



Converting existing systems

What are the points to note when converting existing systems that use the pneumatic drives DGP/DGPL or DNC?	Optimum system behaviour is guaranteed by Festo's uniquely specified solution packages, in which	all components are harmonised. When converting existing systems, observe the following points:
Where could system behaviour possibly change when an existing system is converted?	In normal cases, the entire cylinder stroke is used, including the internal	cushioning length (PPV); no stroke reserve is available.
What should be noted when installing the pneumatics?	<ul style="list-style-type: none"> Make sure that the system configuration is symmetrical, i.e. that the tubing used to connect the compressed air supply to each end of the cylinder is of identical length. 	<ul style="list-style-type: none"> No flow controls between the valve and cylinder. Open the end-position cushioning (PPV) 100%. <p>Accessories and tubing diameters can be found in the description for the respective solution package.</p>
What should be noted when installing the electrics?	As far as the electrical actuation is concerned, the Smart Soft Stop system behaves like a standard pneumatic	<p>system with a double solenoid valve and two proximity sensors.</p> <p>For further information see the manual System description: SPC11-... → 37.</p>
Does the control program need to be adapted?	Existing systems which have provision for two digital inputs/outputs can be	converted without adaptation of the control program.
What proportional 5/3-way valve should be selected for the conversion project?	Exactly the same valve as specified in the solution packages on → 19 or 25.	

What end position controller is suitable for each drive or displacement encoder?

End position controller	Drive	Displacement encoder
SPC11-POT-TLF	DGP/DGPL	MLO-POT-...-TLF
SPC11-POT-LWG	DNC	MLO-POT-...-LWG
	DSMI	Integrated
SPC11-MTS-AIF	DGP/DGPL	MME-MTS-...-AIF
	DGPI/DGPIL	Integrated
SPC11-INC	DNCI	Integrated
SPC11-MTS-AIF-2	DGCI	Adapted