

Electrical adapters NEFU, universal

Technical data

Cable socket NEFU-X2

- Cable socket for branching the AS-interface network at any desired point
- Reconnection from AS-interface flat cable to 5-pin M12 socket
- Reverse polarity protected

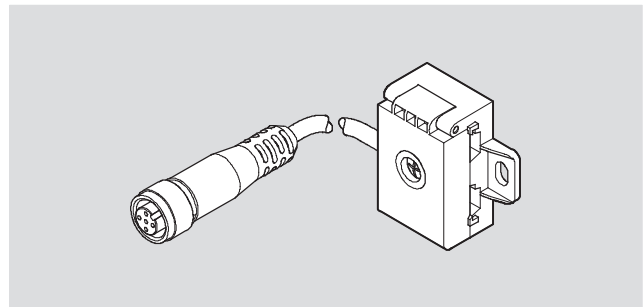

General technical data			
Type	NEFU-X22F-M12G4	NEFU-X24F-1-M12G4	NEFU-X24F-M12G4
Fieldbus interface	Socket, 4-pin, M12x1, A-coded		
Nominal operating voltage, [V DC] AS-interface	26.5		
Operating voltage, [V DC] AS-interface	26.5 ... 31.6		
Nominal operating voltage, [V DC] load voltage	-	24	24
Operating voltage, [V DC] load voltage	-	20.4 ... 26.4	20.4 ... 26.4
Type of mounting	Via through-hole		
Max. tightening torque [Nm]	1.65		
Protection class to EN 60529	IP65 (assembled)		

Materials	
Housing	PA
Cover	PA
Note on materials	RoHS-compliant

Operating and environmental conditions	
Ambient temperature [°C]	-25 ... +75
Storage temperature [°C]	-25 ... +85
CE marking (see declaration of conformity)	To EU EMC Directive ¹⁾

1) For information about the applicability of the component see the manufacturer's EC declaration of conformity at: www.festo.com → Support → User documentation.
If the component is subject to restrictions on usage in residential, office or commercial environments or small businesses, further measures to reduce the emitted interference may be necessary.

Dimensions Download CAD data → www.festo.com

NEFU-X22F-M12G4 and NEFU-X24F-M12G4

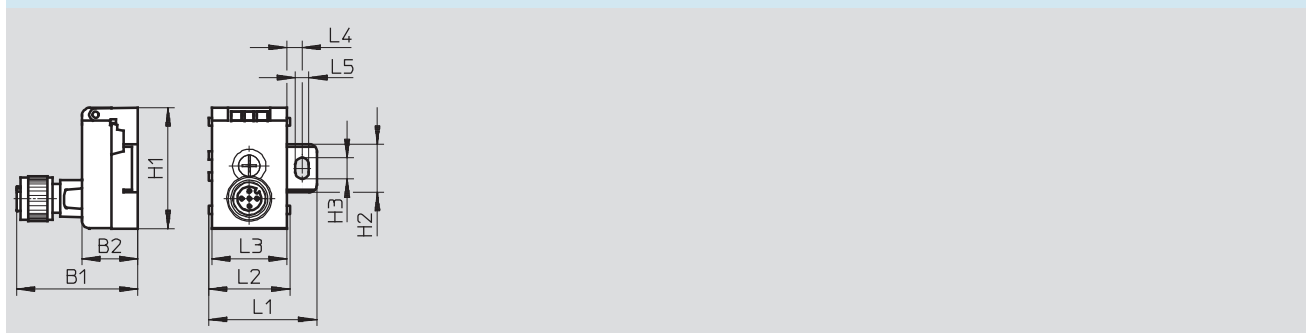

Type	B1	B2	H1	H2	H3	L1	L2	L3	L4	L5
NEFU-X22F-M12G4	40	19	40	16	7	36	26	25	5	4
NEFU-X24F-M12G4										

Electrical adapters NEFU, universal

Technical data

Dimensions

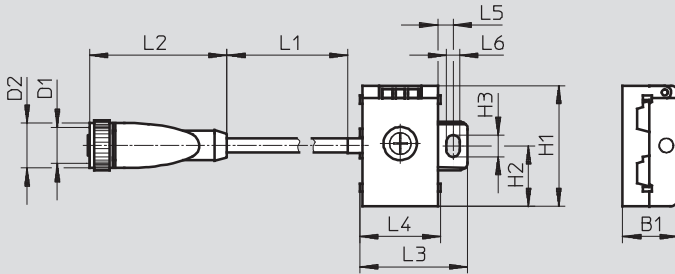

Download CAD data → www.festo.com

NEFU-X24F-1-M12G4



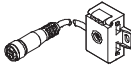

Type	B1	D1	D2	H1	H2	H3	L1	L2	L3	L4	L5	L6
NEFU-X24F-1-M12G4	19	M12	15	40	20	7	1000	45	36	26	5	4

Ordering data

	AS-interface connection	Weight	Cable length	Part No.	Type
	Without load voltage supply	30 g	–	572225	NEFU-X22F-M12G4
	With load voltage supply	30 g	–	572226	NEFU-X24F-M12G4
	With load voltage supply	60 g	1 m	572227	NEFU-X24F-1-M12G4

Ordering data – Accessories

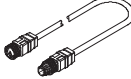
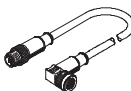
	Designation		Part No.	Type
	Straight sensor plug for cable Ø 2.5 mm	M12, 4-pin	192008	SEA-4GS-7-2,5
	Straight sensor plug	M12, 4-pin, PG7	18666	SEA-GS-7
		M12, PG9, 4-pin	18778	SEA-GS-9
	Plug M12 for 2 connecting cables	4-pin, PG11	18779	SEA-GS-11-DUO
	Connecting cable, straight plug, straight socket	M12, 4-pin/5-pin, 0.2 m	542129	NEBU-M12G5-F-0.2-M12G4
		M12, 4-pin, 2.5 m	18684	KM12-M12-GSGD-2,5
		M12, 4-pin, 5 m	18686	KM12-M12-GSGD-5
	Connecting cable, straight plug, angled socket	M12, 4-pin, 1 m	185499	KM12 M12-GSWD-1-4