









Pressure gauges



Pressure gauges

Product range overview

FESTO

Type	Pneumatic connection	Nominal size							Display unit			Red/green range	→ Page/Internet
		15	23	26	27	40	50	63	bar	MPa	psi		
Pressure gauge MA-...-EN	 R $\frac{1}{8}$, R $\frac{1}{4}$, G $\frac{1}{4}$	-	-	-	-	■	■	■	■	-	■	-	3
Pressure gauge with red/green range MA-...-RG	 R $\frac{1}{8}$, R $\frac{1}{4}$	-	-	-	-	■	■	■	■	■	■	■	6
Pressure gauge MA	 M5, R $\frac{1}{8}$, G $\frac{1}{8}$, G $\frac{1}{4}$	■	■	-	■	■	■	■	■	■	■	-	9
Precision pressure gauge MAP	 R $\frac{1}{8}$	-	-	-	-	■	-	-	■	-	■	-	13
Pressure gauge MA-...-QS	 QS-4, QS-6, QS-8	■	-	-	-	-	-	-	■	-	-	-	14
Flanged pressure gauge FMA-...-EN	 G $\frac{1}{4}$	-	-	-	-	■	■	■	■	-	■	-	15
Flanged pressure gauge FMA	 G $\frac{1}{4}$	-	-	-	-	-	-	■	■	-	■	-	17
Precision flanged pressure gauge FMAP	 G $\frac{1}{4}$	-	-	-	-	-	-	■	■	-	■	-	18
Pressure gauge PAGN	 For QSP10	-	-	■	-	■	-	-	■	■	■	-	20

Pressure gauges MA-EN

Technical data

Function



 - Temperature range
 -20 ... +60 °C



Technical data					
Nominal size	40			50	63
Pneumatic connection	R $\frac{1}{8}$	R $\frac{1}{4}$	G $\frac{1}{4}$	G $\frac{1}{4}$	G $\frac{1}{4}$
Operating medium	Inert gases Neutral liquids				
Note on operating/pilot medium	No oxygen No acetylene				
Design	Bourdon tube pressure gauge				
Conforms to	EN 837-1				
Type of mounting	Inline installation				
Connection position	Centred, rear side				
Ambient temperature [°C]	-20 ... +60				
Temperature of medium [°C]	-20 ... +60 ¹⁾				
Measurement accuracy class	2.5				
Continuous load factor	0.75				
Intermittent load factor	0.66				
Protection class	IP43				
For MS series service units	MS4	MS4/MS6/MS9/MS12		-	-
Weight [g]	60	70	70	70	80

1) With a media temperature below 0 °C, the operating medium should be dry.

Materials					
Nominal size	40			50	63
Pneumatic connection	R $\frac{1}{8}$	R $\frac{1}{4}$	G $\frac{1}{4}$	G $\frac{1}{4}$	G $\frac{1}{4}$
Housing	Acrylic butadiene styrene (colour: black)				
Inspection window	Polystyrene				
Threaded plug	Brass				
Materials in contact with the medium	Brass				
Note on materials	RoHS-compliant				

Display range					
Nominal size	40			50	63
Pneumatic connection	R $\frac{1}{8}$	R $\frac{1}{4}$	G $\frac{1}{4}$	G $\frac{1}{4}$	G $\frac{1}{4}$
[bar]	[psi]				
0 ... 1	0 ... 14.5	-	-	-	■
0 ... 2.5	0 ... 36	-	-	■	■
0 ... 6	0 ... 87	-	■	■	-
0 ... 10	0 ... 145	■	■	■	■
0 ... 16	0 ... 232	-	■	■	■
0 ... 25	0 ... 360	■	■	-	-

Pressure gauges MA-EN

Technical data

FESTO

Dimensions

Download CAD data → www.festo.com

MA-40, R¹/₈

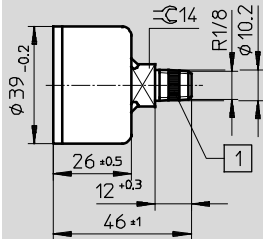

1 PTFE seal with
MA-40-25-1/8-EN

MA-40, R¹/₄

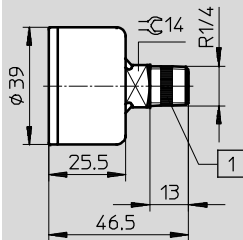

1 PTFE seal

MA-40, G¹/₄

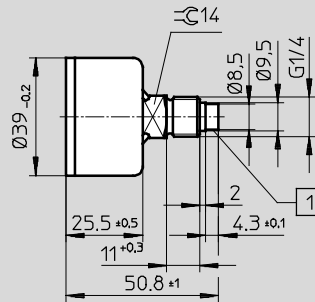

1 With pre-assembled PTFE
sealing ring

MA-50/63, G¹/₄

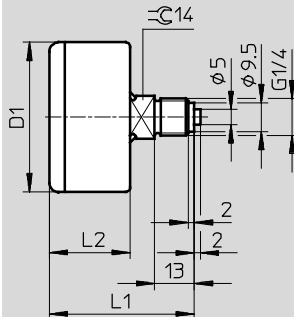





Type	D1 Ø	L1	L2
MA-50	49	47.5	26.5
MA-63	61.5	48.5	27.5

 Type discontinued
Available up until 2014

Pressure gauges MA-EN

Technical data

FESTO

Ordering data						
Nominal size	Pneumatic connection	Operating pressure	Display range		Part No.	Type
			[bar]	[psi]		
40	R $\frac{1}{8}$	0 ... 10 bar	0 ... 10	0 ... 145	162835	MA-40-10- $\frac{1}{8}$ -EN
		0 ... 25 bar	0 ... 25	0 ... 360	526167	MA-40-25- $\frac{1}{8}$ -EN
	R $\frac{1}{4}$	0 ... 6 bar	0 ... 6	0 ... 87	187078	MA-40-6-R $\frac{1}{4}$ -EN
		0 ... 10 bar	0 ... 10	0 ... 145	187079	MA-40-10-R $\frac{1}{4}$ -EN
		0 ... 16 bar	0 ... 16	0 ... 232	187080	MA-40-16-R $\frac{1}{4}$ -EN
		0 ... 25 bar	0 ... 25	0 ... 360	187081	MA-40-25-R $\frac{1}{4}$ -EN 
	G $\frac{1}{4}$	0 ... 6 bar	0 ... 6	0 ... 87	183899	MA-40-6-G $\frac{1}{4}$ -EN
		0 ... 10 bar	0 ... 10	0 ... 145	183900	MA-40-10-G $\frac{1}{4}$ -EN
		0 ... 16 bar	0 ... 16	0 ... 232	183901	MA-40-16-G $\frac{1}{4}$ -EN
50	G $\frac{1}{4}$	0 ... 2.5 bar	0 ... 2.5	0 ... 36	162837	MA-50-2,5- $\frac{1}{4}$ -EN
		0 ... 10 bar	0 ... 10	0 ... 145	162838	MA-50-10- $\frac{1}{4}$ -EN
		0 ... 16 bar	0 ... 16	0 ... 232	162839	MA-50-16- $\frac{1}{4}$ -EN
63	G $\frac{1}{4}$	0 ... 1 bar	0 ... 1	0 ... 14.5	162844	MA-63-1- $\frac{1}{4}$ -EN
		0 ... 2.5 bar	0 ... 2.5	0 ... 36	162845	MA-63-2,5- $\frac{1}{4}$ -EN 
		0 ... 10 bar	0 ... 10	0 ... 145	162840	MA-63-10- $\frac{1}{4}$ -EN 
		0 ... 16 bar	0 ... 16	0 ... 232	162841	MA-63-16- $\frac{1}{4}$ -EN 

Pressure gauges MA-RG, with red/green range

Technical data

Function



-  - Temperature range
-20 ... +60 °C



The adjustable red/green range provides additional safety when monitoring compressed air.

With the two red segments above the pressure gauge scale along with the printed green segment it is possible to

individually limit the desired pressure range. This coloured demarcation enables you to recognise immediately

whether or not the pressure is in the permitted tolerance range.

Technical data			
Nominal size	40	50	63
Pneumatic connection	R $\frac{1}{8}$	R $\frac{1}{4}$	R $\frac{1}{4}$
Operating medium	Inert gases		
	Neutral liquids		
Note on operating/pilot medium	No oxygen		
	No acetylene		
Design	Bourdon tube pressure gauge		
Conforms to	EN 837-1		
Type of mounting	Inline installation		
Connection position	Centred, rear side		
Ambient temperature [°C]	-20 ... +60		
Temperature of medium [°C]	-20 ... +60 ¹⁾		
Measurement accuracy class	2.5		
Continuous load factor	0.75		
Intermittent load factor	0.66		
Protection class	IP43		
For MS series service units	MS4	MS4/MS6/MS9/MS12	-
Weight [g]	60	75	90

1) With a media temperature below 0 °C, the operating medium should be dry.

Materials	
Housing	Acrylic butadiene styrene (colour: black)
Inspection window	Polymethyl methacrylate
Threaded plug/ materials in contact with the medium	Brass
Note on materials	RoHS-compliant

Pressure gauges MA-RG, with red/green range

Technical data

Display range			
Nominal size	40	50	63
Pneumatic connection	R $\frac{1}{8}$	R $\frac{1}{4}$	R $\frac{1}{4}$
[bar]			
0 ... 2.5	■	■	■
0 ... 10	■	■	■
0 ... 16	■	■	■
[MPa]			
0 ... 0.25	-	■	■
0 ... 1	■	■	■
0 ... 1.6	■	■	■
[psi]			
0 ... 36	-	■	■
0 ... 145	■	■	■
0 ... 232	■	■	■

Dimensions Download CAD data → www.festo.com

MA-...-E-RG

The drawing shows a side view of the gauge with the following dimensions: D1 (total diameter), D2 (thread diameter), L1 (total length), L2 (length to the start of the thread), and L3 (thread length). A note indicates the thread is coated with thread sealing compound.









Type	D1 ∅ ±0.5	D2	L1 ±1	L2 ±0.5	L3
MA-40-...-E-RG	39	R $\frac{1}{8}$	46	28	10
MA-50-...-E-RG	49	R $\frac{1}{4}$	49	28	13
MA-63-...-E-RG	61.5	R $\frac{1}{4}$	50.5	29.5	13

 Type discontinued
Available up until 2014

Pressure gauges MA-RG, with red/green range

FESTO

Technical data

Ordering data					
Nominal size	Pneumatic connection	Operating pressure	Display range	Part No.	Type
Display unit [bar]					
40	R $\frac{1}{8}$	0 ... 2.5 bar	0 ... 2.5	546963	MA-40-2,5-R $\frac{1}{8}$ -E-RG
		0 ... 10 bar	0 ... 10	525725	MA-40-10-R $\frac{1}{8}$ -E-RG
		0 ... 16 bar	0 ... 16	525726	MA-40-16-R $\frac{1}{8}$ -E-RG
50	R $\frac{1}{4}$	0 ... 2.5 bar	0 ... 2.5	525727	MA-50-2,5-R $\frac{1}{4}$ -E-RG
		0 ... 10 bar	0 ... 10	525728	MA-50-10-R $\frac{1}{4}$ -E-RG
		0 ... 16 bar	0 ... 16	525729	MA-50-16-R $\frac{1}{4}$ -E-RG
63	R $\frac{1}{4}$	0 ... 2.5 bar	0 ... 2.5	525730	MA-63-2,5-R $\frac{1}{4}$ -E-RG 
		0 ... 10 bar	0 ... 10	525731	MA-63-10-R $\frac{1}{4}$ -E-RG 
		0 ... 16 bar	0 ... 16	525732	MA-63-16-R $\frac{1}{4}$ -E-RG 
Display unit [MPa]					
40	R $\frac{1}{8}$	0 ... 1 MPa	0 ... 1	526778	MA-40-1,0-R $\frac{1}{8}$ -MPA-E-RG
		0 ... 1.6 MPa	0 ... 1.6	526779	MA-40-1,6-R $\frac{1}{8}$ -MPA-E-RG
50	R $\frac{1}{4}$	0 ... 0.25 MPa	0 ... 0.25	526780	MA-50-0,25-R $\frac{1}{4}$ -MPA-E-RG
		0 ... 1 MPa	0 ... 1	526781	MA-50-1,0-R $\frac{1}{4}$ -MPA-E-RG
		0 ... 1.6 MPa	0 ... 1.6	526782	MA-50-1,6-R $\frac{1}{4}$ -MPA-E-RG
63	R $\frac{1}{4}$	0 ... 0.25 MPa	0 ... 0.25	526783	MA-63-0,25-R $\frac{1}{4}$ -MPA-E-RG 
		0 ... 1 MPa	0 ... 1	526784	MA-63-1,0-R $\frac{1}{4}$ -MPA-E-RG 
		0 ... 1.6 MPa	0 ... 1.6	526785	MA-63-1,6-R $\frac{1}{4}$ -MPA-E-RG 
Display unit [psi]					
40	R $\frac{1}{8}$	0 ... 145 psi	0 ... 145	526786	MA-40-145-R $\frac{1}{8}$ -PSI-E-RG
		0 ... 232 psi	0 ... 232	526787	MA-40-232-R $\frac{1}{8}$ -PSI-E-RG
50	R $\frac{1}{4}$	0 ... 36 psi	0 ... 36	526788	MA-50-36-R $\frac{1}{4}$ -PSI-E-RG
		0 ... 145 psi	0 ... 145	526789	MA-50-145-R $\frac{1}{4}$ -PSI-E-RG
		0 ... 232 psi	0 ... 232	526790	MA-50-232-R $\frac{1}{4}$ -PSI-E-RG
63	R $\frac{1}{4}$	0 ... 36 psi	0 ... 36	526791	MA-63-36-R $\frac{1}{4}$ -PSI-E-RG 
		0 ... 145 psi	0 ... 145	526792	MA-63-145-R $\frac{1}{4}$ -PSI-E-RG 
		0 ... 232 psi	0 ... 232	526793	MA-63-232-R $\frac{1}{4}$ -PSI-E-RG 

Pressure gauges MA

Technical data

FESTO

Function



Temperature range
-20 ... +60 °C



Technical data									
Nominal size	15	23	27	40	50	63			
Pneumatic connection	M5	R $\frac{1}{8}$	M5	R $\frac{1}{8}$	G $\frac{1}{8}$	G $\frac{1}{4}$	G $\frac{1}{4}$	G $\frac{1}{4}$	G $\frac{1}{4}$
Operating medium	Inert gases							Gaseous media	
	Neutral liquids							Fluid media	
Note on operating/pilot medium	No oxygen								
	No acetylene								
Design	Bourdon tube pressure gauge without measuring mechanism	Bourdon tube pressure gauge						Capsule pressure gauge	
Conforms to	EN 837-1							EN 837-3	
Type of mounting	Inline installation								
Connection position	Centred, rear side								
Ambient temperature [°C]	-20 ... +60		0 ... +60		-20 ... +60		-20 ... +60		
Temperature of medium [°C]	-20 ... +60 ¹⁾		0 ... +60		-20 ... +60 ¹⁾		-20 ... +80 ¹⁾		
Measurement accuracy class	5		4		2.5		1.6		
Continuous load factor	0.75		0.75				0.75		
Intermittent load factor	0.66	0.6	0.66				0.9		
Protection class	IP53	IP44	IP43				IP43		
For D series service units	-	-	MICRO	-	MINI	-	MIDI/MAXI	-	
Weight [g]	10	27	11	8	60	70	70	180	

1) With a media temperature below 0 °C, the operating medium should be dry.

Materials									
Nominal size	15	23	27	40	50	63			
Pneumatic connection	M5	R $\frac{1}{8}$	M5	R $\frac{1}{8}$	G $\frac{1}{8}$	G $\frac{1}{4}$	G $\frac{1}{4}$	G $\frac{1}{4}$	G $\frac{1}{4}$
Housing	Steel (colour: black)	Brass (colour: black)	Polyamide (colour: black)		Acrylic butadiene styrene (colour: black)		Steel		
Inspection window	Polycarbonate		Polystyrene		Polystyrene		Polymethyl methacrylate		
Threaded plug/ materials in contact with the medium	Brass		Brass	Reinforced polyamide	Brass		Brass		
Note on materials	RoHS-compliant								

Pressure gauges MA

Technical data

Display range									
Nominal size		15	23	27		40		50	63
Pneumatic connection		M5	R $\frac{1}{8}$	M5	R $\frac{1}{8}$	G $\frac{1}{8}$	G $\frac{1}{4}$	G $\frac{1}{4}$	G $\frac{1}{4}$
[bar]	[psi]								
0 ... 0.25	0 ... 3.6	-	-	-	-	-	-	-	■
0 ... 6	0 ... 87	-	■	-	-	-	-	-	-
0 ... 10	0 ... 145	-	■	-	-	■	-	■	-
0 ... 16	0 ... 232	-	■	-	■	■	-	■	-
0 ... 25	0 ... 360	-	-	-	■	-	-	-	-
[bar]									
0 ... 10		■	-	■	-	-	-	-	-
[MPa]									
0 ... 0.6		-	-	-	-	-	■	-	-
0 ... 1		-	-	■	-	■	■	■	-
0 ... 1.6		-	-	-	-	■	■	■	-
0 ... 2.5		-	-	-	-	-	■	-	-
[psi]									
0 ... 145		■	-	-	-	-	-	-	-
0 ... 160		-	-	■	-	-	-	-	-

Dimensions Download CAD data → www.festo.com

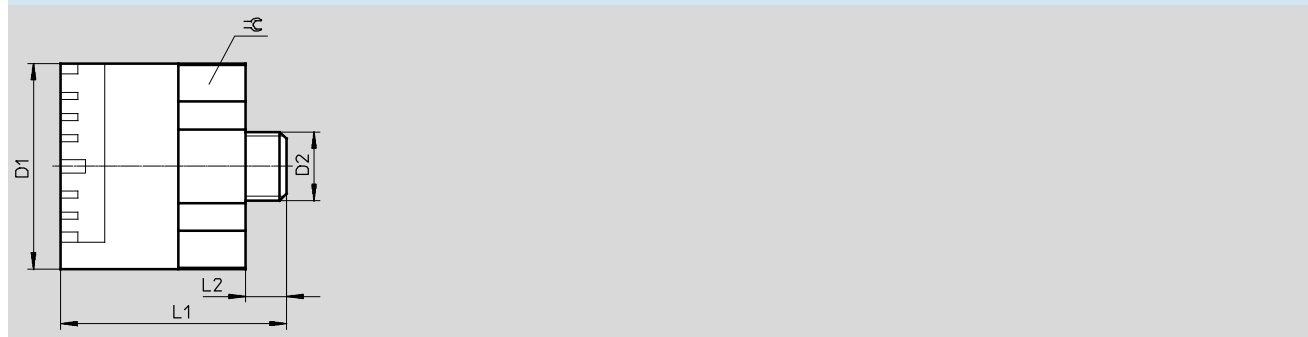

Type	D1 ∅	D2	L1	L2	☉
MA-15	15	M5	16.5	3	14

Pressure gauges MA

Technical data

FESTO

Dimensions

Download CAD data → www.festo.com

MA-23

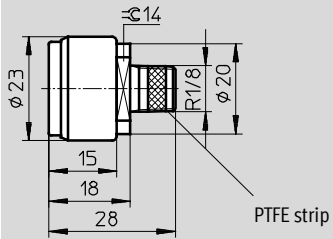

MA-27, M5

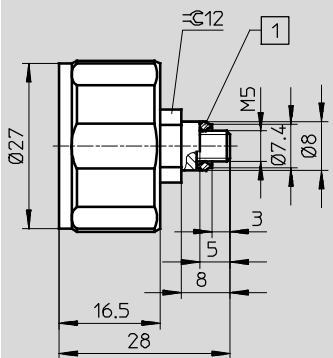

1 With pre-assembled polyamide sealing ring

MA-27, R1/8

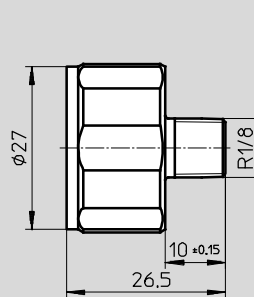

MA-40, G1/8

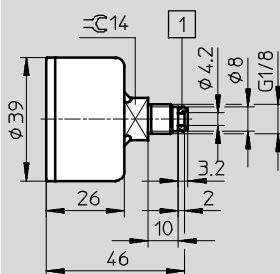

1 With pre-assembled aluminium sealing ring with MA-40-...-G1/8

MA-40, G1/4

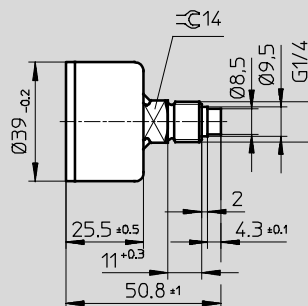

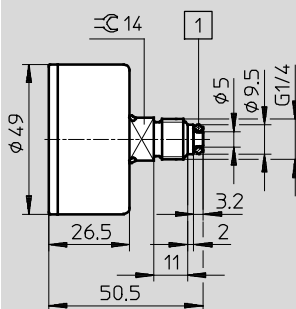

MA-50

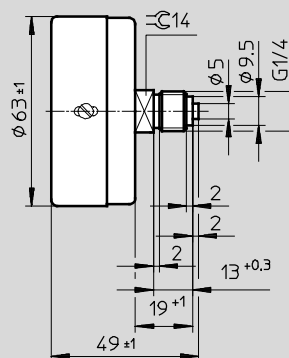

1 With pre-assembled aluminium sealing ring with MA-50-...-G1/4

MA-63



 Type discontinued
Available up until 2014

FESTO

Pressure gauges MA

Technical data

Ordering data						
Nominal size	Pneumatic connection	Operating pressure	Display range		Part No.	Type
			[bar]	[psi]		
23	R $\frac{1}{8}$	0 ... 6 bar	0 ... 6	0 ... 87	183896	MA-23-6-R $\frac{1}{8}$
		0 ... 10 bar	0 ... 10	0 ... 145	183897	MA-23-10-R $\frac{1}{8}$
		0 ... 16 bar	0 ... 16	0 ... 232	183898	MA-23-16-R $\frac{1}{8}$
27	R $\frac{1}{8}$	0 ... 16 bar	0 ... 16	0 ... 232	541733	MA-27-16-R $\frac{1}{8}$
		0 ... 25 bar	0 ... 25	0 ... 360	541734	MA-27-25-R $\frac{1}{8}$
40	G $\frac{1}{8}$	0 ... 10 bar	0 ... 10	0 ... 145	359874	MA-40-10- $\frac{1}{8}$
		0 ... 16 bar	0 ... 16	0 ... 232	345395	MA-40-16- $\frac{1}{8}$
50	G $\frac{1}{4}$	0 ... 10 bar	0 ... 10	0 ... 145	359873	MA-50-10- $\frac{1}{4}$
		0 ... 16 bar	0 ... 16	0 ... 232	356759	MA-50-16- $\frac{1}{4}$
63	G $\frac{1}{4}$	0 ... 0.25 bar	0 ... 0.25	0 ... 3.6	7169	MA-63-0,25

Ordering data						
Nominal size	Pneumatic connection	Operating pressure	Display range		Part No.	Type
			[bar]	[psi]		
Display unit [bar]						
15	M5	0 ... 10 bar	0 ... 10		132340	MA-15-10-M5
27	M5	0 ... 10 bar	0 ... 10		526323	MA-27-10-M5
Display unit [MPa]						
27	M5	0 ... 1 MPa	0 ... 1		526324	MA-27-1,0-M5-MPA
40	G $\frac{1}{8}$	0 ... 1 MPa	0 ... 1		192732	MA-40-1-G $\frac{1}{8}$ -MPA
		0 ... 1.6 MPa	0 ... 1.6		192733	MA-40-1,6-G $\frac{1}{8}$ -MPA
	G $\frac{1}{4}$	0 ... 0.6 MPa	0 ... 0.6		184285	MA-40-0,6-G $\frac{1}{4}$ -MPA
		0 ... 1 MPa	0 ... 1		184286	MA-40-1,0-G $\frac{1}{4}$ -MPA
		0 ... 1.6 MPa	0 ... 1.6		184287	MA-40-1,6-G $\frac{1}{4}$ -MPA
50	G $\frac{1}{4}$	0 ... 1 MPa	0 ... 1		192734	MA-50-1-G $\frac{1}{4}$ -MPA
		0 ... 1.6 MPa	0 ... 1.6		192735	MA-50-1,6-G $\frac{1}{4}$ -MPA
Display unit [psi]						
15	M5	0 ... 145 psi	0 ... 145		132341	MA-15-145-M5-PSI
27	M5	0 ... 160 psi	0 ... 160		527405	MA-27-160-M5-PSI

Precision pressure gauges MAP

Technical data

Function



Temperature range
-20 ... +60 °C



Technical data	
Nominal size	40
Pneumatic connection	R1/8
Operating medium	Inert gases Neutral liquids
Note on operating/pilot medium	No oxygen No acetylene
Design	Bourdon tube pressure gauge
Conforms to	EN 837-1
Type of mounting	Inline installation
Connection position	Centred, rear side
Ambient temperature [°C]	-20 ... +60
Temperature of medium [°C]	-20 ... +60 ¹⁾
Measurement accuracy class	1.6
Continuous load factor	0.75
Intermittent load factor	0.66
Protection class	IP43
Weight [g]	60

1) With a media temperature below 0 °C, the operating medium should be dry.

Materials	
Housing	Acrylic butadiene styrene (colour: black)
Inspection window	Polystyrene
Threaded plug/ materials in contact with the medium	Brass
Note on materials	RoHS-compliant

Dimensions Download CAD data → www.festo.com

Ordering data						
Nominal size	Pneumatic connection	Operating pressure	Display range		Part No.	Type
			[bar]	[psi]		
40	R1/8	0 ... 1 bar	0 ... 1	0 ... 15	161126	MAP-40-1-1/8-EN
		0 ... 4 bar	0 ... 4	0 ... 58	162842	MAP-40-4-1/8-EN
		0 ... 6 bar	0 ... 6	0 ... 87	161127	MAP-40-6-1/8-EN
		0 ... 16 bar	0 ... 16	0 ... 232	161128	MAP-40-16-1/8-EN

Pressure gauges MA-QS

FESTO

Technical data

Function



Temperature range
-20 ... +60 °C



Technical data			
Nominal size	15		
Pneumatic connection	QS-4	QS-6	QS-8
Operating medium	Inert gases		
	Neutral liquids		
Note on operating/pilot medium	No oxygen		
	No acetylene		
Design	Bourdon tube pressure gauge without measuring mechanism		
Conforms to	EN 837-1		
Type of mounting	Inline installation		
Connection position	Centred, rear side		
Ambient temperature [°C]	-20 ... +60		
Temperature of medium [°C]	-20 ... +60		
Measurement accuracy class	5		
Continuous load factor	0.75		
Intermittent load factor	0.66		
Protection class	IP53		
Weight [g]	10		

Materials	
Housing	Steel (colour: black)
Inspection window	Polycarbonate
Threaded plug/ materials in contact with the medium	Brass
Note on materials	RoHS-compliant

Dimensions Download CAD data → www.festo.com

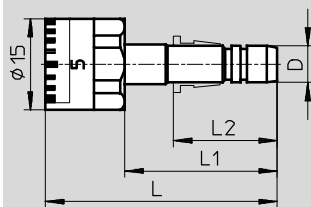

Dimensions and ordering data								
Nominal size	Pneumatic connection D	L	L1	L2	Operating pressure	Display range	Part No.	Type
						[bar]		
15	QS-4	36	23	15	0 ... 10 bar	0 ... 10	153383	MA-15-10-QS-4
	QS-6	38	25	17	0 ... 10 bar	0 ... 10	153384	MA-15-10-QS-6
	QS-8	34	21	18.5	0 ... 10 bar	0 ... 10	153385	MA-15-10-QS-8

Flanged pressure gauges FMA-EN

Technical data

Function



 - Temperature range
 -20 ... +60 °C



Technical data			
Nominal size	40	50	63
Pneumatic connection	G $\frac{1}{4}$	G $\frac{1}{4}$	G $\frac{1}{4}$
Operating medium	Inert gases Neutral fluids		
Note on operating/pilot medium	No oxygen No acetylene		
Design	Bourdon tube pressure gauge		
Conforms to	EN 837-1		
Type of mounting	Front panel mounting		
Connection position	Centred, rear side		
Ambient temperature [°C]	-20 ... +60		
Temperature of medium [°C]	-20 ... +60 ¹⁾		
Measurement accuracy class	2.5		
Continuous load factor	0.75		
Intermittent load factor	0.66		
Protection class	IP43		
Weight [g]	80	100	120

1) With a media temperature below 0 °C, the operating medium should be dry.

Materials	
Housing	Acrylic butadiene styrene (colour: black)
Inspection window	Styrene acrylonitrile copolymer
Mounting ring	Steel
Threaded plug/ materials in contact with the medium	Brass
Note on materials	RoHS-compliant

Display range			
Nominal size	40	50	63
Pneumatic connection	G $\frac{1}{4}$	G $\frac{1}{4}$	G $\frac{1}{4}$
[bar]	[psi]		
0 ... 2.5	0 ... 36	-	■
0 ... 10	0 ... 145	■	■
0 ... 16	0 ... 232	■	■

Flanged pressure gauges FMA-EN

Technical data

FESTO

Dimensions

Download CAD data → www.festo.com

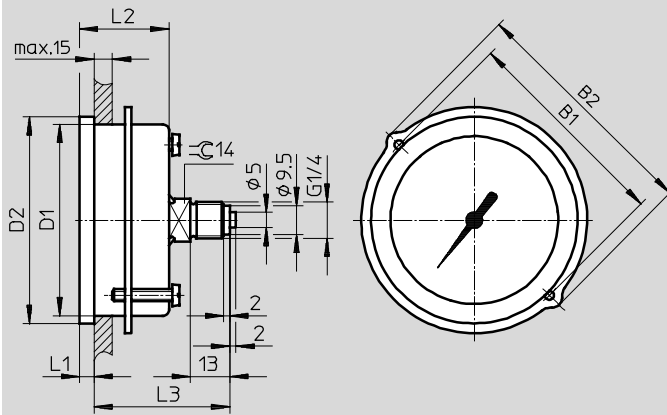

Type	B1	B2	D1 Ø	D2 Ø	L1	L2	L3
FMA-40	48	56	40	45	4.5	26.5	43
FMA-50	57	66	49.5	54	4.5	26.8	43.3
FMA-63	70	79	63	68	4.8	29.5	42.5

Ordering data						
Nominal size	Pneumatic connection	Operating pressure	Display range		Part No.	Type
			[bar]	[psi]		
40	G1/4	0 ... 10 bar	0 ... 10	0 ... 145	159596	FMA-40-10-1/4-EN
		0 ... 16 bar	0 ... 16	0 ... 232	159597	FMA-40-16-1/4-EN
50	G1/4	0 ... 2.5 bar	0 ... 2.5	0 ... 36	159598	FMA-50-2,5-1/4-EN
		0 ... 10 bar	0 ... 10	0 ... 145	159599	FMA-50-10-1/4-EN
		0 ... 16 bar	0 ... 16	0 ... 232	159600	FMA-50-16-1/4-EN
63	G1/4	0 ... 2.5 bar	0 ... 2.5	0 ... 36	159601	FMA-63-2,5-1/4-EN
		0 ... 10 bar	0 ... 10	0 ... 145	159602	FMA-63-10-1/4-EN
		0 ... 16 bar	0 ... 16	0 ... 232	159603	FMA-63-16-1/4-EN

Flanged pressure gauges FMA

FESTO

Technical data

Function



Temperature range
-20 ... +60 °C



Technical data	
Nominal size	63
Pneumatic connection	G1/4
Operating medium	Gaseous media
	Fluid media
Note on operating/pilot medium	No oxygen
	No acetylene
Design	Capsule pressure gauge
Conforms to	EN 837-3
Type of mounting	Front panel mounting
Connection position	Centred, rear side
Ambient temperature [°C]	-20 ... +60
Temperature of medium [°C]	-20 ... +80
Measurement accuracy class	1.6
Continuous load factor	0.75
Intermittent load factor	0.9
Protection class	IP43
Weight [g]	120

Materials	
Housing	Steel
Inspection window	Polymethyl methacrylate
Mounting ring/screws	Steel
Threaded plug	Brass

Dimensions Download CAD data → www.festo.com

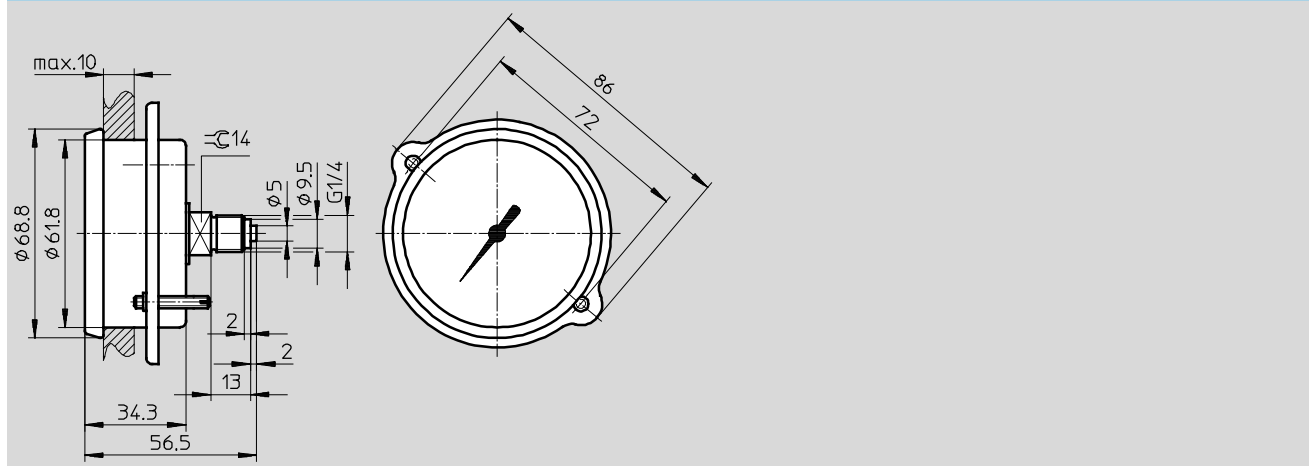

Ordering data					
Nominal size	Pneumatic connection	Operating pressure	Display range		Part No. Type
			[bar]	[psi]	
63	G1/4	0 ... 0.25 bar	0 ... 0.25	0 ... 3.6	225783 FMA-63-0,25-C

Precision flanged pressure gauges FMAP

FESTO

Technical data

Function



 Temperature range
 -20 ... +60 °C



Technical data	
Nominal size	63
Pneumatic connection	G $\frac{1}{4}$
Operating medium	Inert gases Neutral liquids
Note on operating/pilot medium	No oxygen No acetylene
Design	Bourdon tube pressure gauge
Conforms to	EN 837-1
Type of mounting	Front panel mounting
Connection position	Centred, rear side
Ambient temperature [°C]	-20 ... +60
Temperature of medium [°C]	-20 ... +60 ¹⁾
Measurement accuracy class	1.0
Continuous load factor	0.75
Intermittent load factor	0.66
Protection class	IP43
Weight [g]	120

1) With a media temperature below 0 °C, the operating medium should be dry.

Materials	
Housing	Acrylic butadiene styrene (colour: black)
Inspection window	Styrene acrylonitrile copolymer
Mounting ring	Steel
Threaded plug/ materials in contact with the medium	Brass
Note on materials	RoHS-compliant

Dimensions Download CAD data → www.festo.com

Precision flanged pressure gauges FMAP

Technical data

Ordering data						
Nominal size	Pneumatic connection	Operating pressure	Display range		Part No.	Type
			[bar]	[psi]		
63	G ¹ / ₄	0 ... 1 bar	0 ... 1	0 ... 15	161129	FMAP-63-1- ¹ / ₄ -EN
		0 ... 4 bar	0 ... 4	0 ... 58	162843	FMAP-63-4- ¹ / ₄ -EN
		0 ... 6 bar	0 ... 6	0 ... 87	161130	FMAP-63-6- ¹ / ₄ -EN
		0 ... 16 bar	0 ... 16	0 ... 232	161131	FMAP-63-16- ¹ / ₄ -EN

Pressure gauges PAGN

FESTO

Technical data

Function



-  - Temperature range
-20 ... +60 °C



Technical data		
Nominal size	26	40
Pneumatic connection	For QSP10	For QSP10
Operating medium	Inert gases	
	Neutral liquids	
Note on operating/pilot medium	No oxygen	
	No acetylene	
Design	Bourdon tube pressure gauge	
Conforms to	EN 837-1	
Type of mounting	Inline installation	
Connection position	Centred, rear side	
Ambient temperature [°C]	-20 ... +60	
Temperature of medium [°C]	-20 ... +60 ¹⁾	
Measurement accuracy class	4.0	2.5
Continuous load factor	0.75	
Intermittent load factor	0.66	
Protection class	IP43	
	NEMA 4	
Weight [g]	15	50

1) With a media temperature below 0 °C, the operating medium should be dry.

Materials		
Housing	Polyamide (colour: black)	Acrylic butadiene styrene (colour: black)
Inspection window	Polystyrene	
Threaded plug/ materials in contact with the medium	Brass	
Note on materials	RoHS-compliant	

Dimensions

Download CAD data → www.festo.com

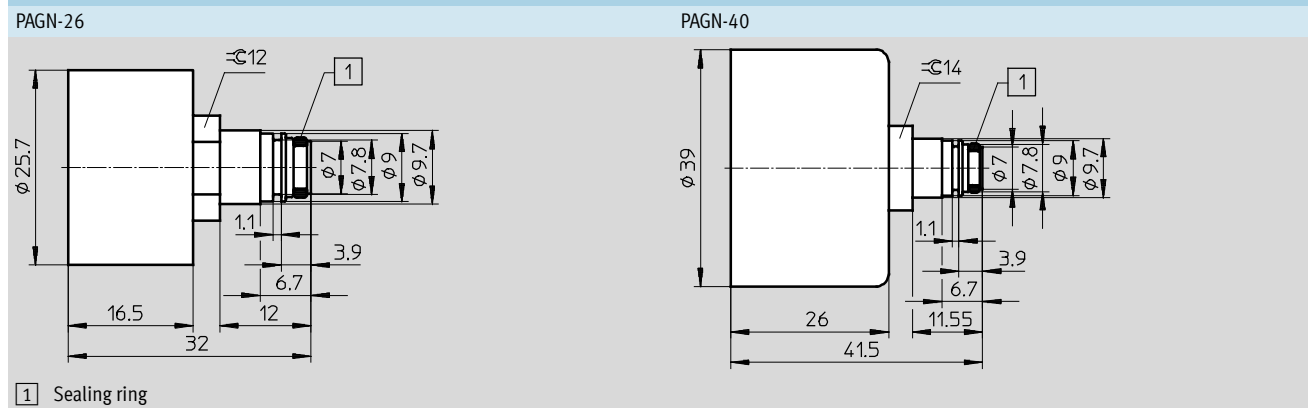

Pressure gauges PAGN

Technical data

FESTO

Ordering data						
Nominal size	Pneumatic connection	Operating pressure	Display range		Part No.	Type
			Outer scale	Inner scale		
Outer scale in bar, inner scale in psi						
26	For QSP10	0 ... 10 bar	0 ... 10 bar	0 ... 145 psi	543488	PAGN-26-10-P10
		0 ... 16 bar	0 ... 16 bar	0 ... 232 psi	543487	PAGN-26-16-P10
40	For QSP10	0 ... 10 bar	0 ... 10 bar	0 ... 145 psi	548009	PAGN-40-10-P10
		0 ... 16 bar	0 ... 16 bar	0 ... 232 psi	548010	PAGN-40-16-P10
Outer scale in psi, inner scale in bar						
26	For QSP10	0 ... 145 psi	0 ... 145 psi	0 ... 10 bar	563732	PAGN-26-145P-P10
		0 ... 232 psi	0 ... 232 psi	0 ... 16 bar	563731	PAGN-26-232P-P10
40	For QSP10	0 ... 145 psi	0 ... 145 psi	0 ... 10 bar	563734	PAGN-40-145P-P10
		0 ... 232 psi	0 ... 232 psi	0 ... 16 bar	563733	PAGN-40-232P-P10
Outer scale in MPa						
26	For QSP10	0 ... 1 MPa	0 ... 1 MPa	–	563736	PAGN-26-1M-P10
		0 ... 1.6 MPa	0 ... 1.6 MPa	–	563735	PAGN-26-1.6M-P10
40	For QSP10	0 ... 1 MPa	0 ... 1 MPa	–	563738	PAGN-40-1M-P10
		0 ... 1.6 MPa	0 ... 1.6 MPa	–	563737	PAGN-40-1.6M-P10