

Solenoid valves, to ISO 5599-1



Solenoid valves, to ISO 5599-1

Key features

FESTO

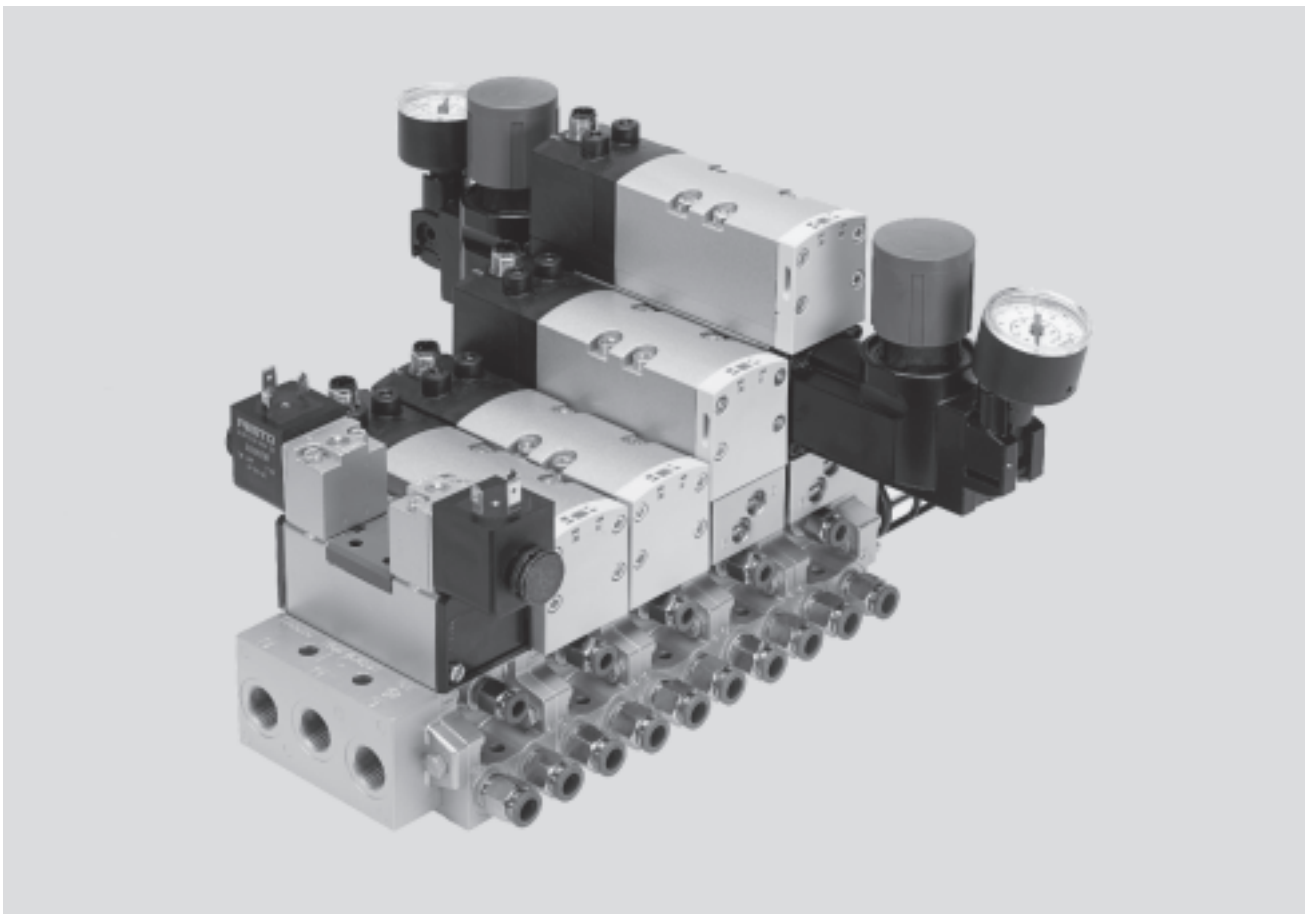

Innovative

- High-performance valves in sturdy metal housing
- Individual electrical connection via square plug sockets or centrally for each valve via round plug sockets
- Valve replacement under pressure possible using vertical pressure shut-off plate
- Reverse operation
- Vacuum operation

Versatile

- Modular system offering a range of configuration options
- Conversions and extensions are possible at any time
- Integration of innovative function modules possible
 - Pressure regulator plate
 - Flow control plate
 - Vertical pressure shut-off plate
 - Vertical supply plate
- Vertical supply plates permit a flexible air supply and variable pressure zones
- Wide range of valve functions
- Extensive operating voltage range from 12 V DC to 230 V AC

Reliable

- Sturdy and durable metal components
 - Valves
 - Horizontal stacking plates
 - Vertical stacking plates
- Fast troubleshooting thanks to LED in the plug socket or illuminating seal
- LED integrated in the valve with the round plug variant
- Reliability of service thanks to valves that can be replaced quickly and easily
- Manual override
- Durable thanks to tried-and-tested piston spool valves

Easy to mount

- Plug-in pressure gauges on the pressure regulator plate

Solenoid valves, to ISO 5599-1

Key features

FESTO

Individual valve manifold

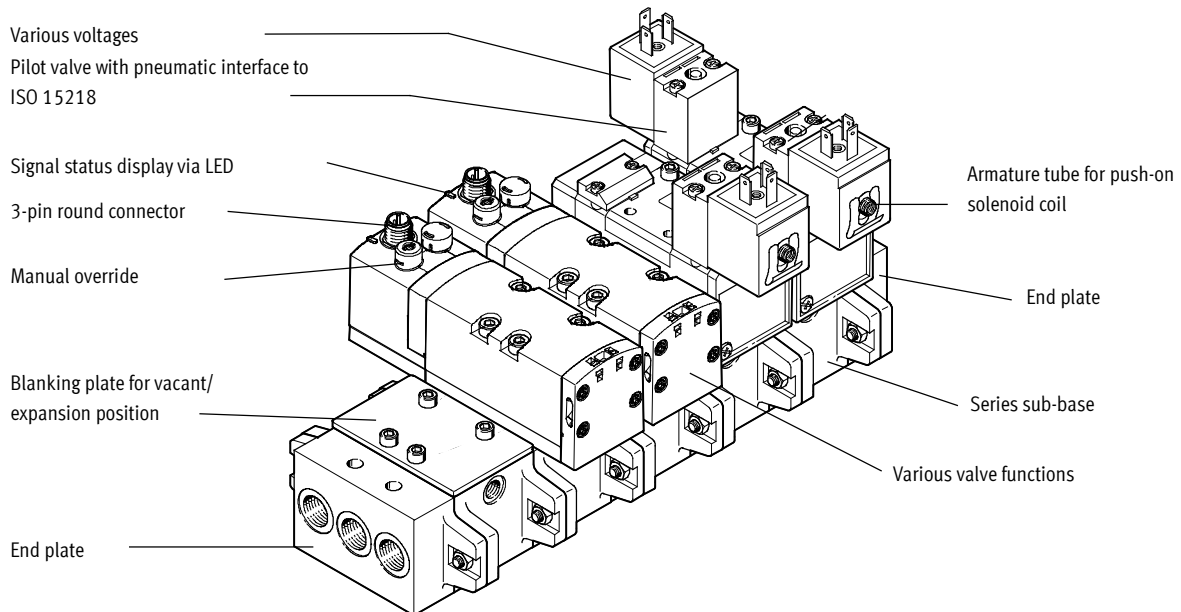

Equipment options

2x 2/2-way valve, single solenoid

- Normally closed
- Normally closed, vacuum operation possible at ports 3 and 5

2x 3/2-way valve, single solenoid

- Normally open
- Normally closed
- 1x normally open, 1x normally closed
- Reverse operation possible (→12)

5/2-way valve

- Single solenoid, mechanical or pneumatic spring return
- Double solenoid
- Double solenoid, with dominant signal at port 14

5/3-way valve

- Mid-position pressurised
- Mid-position closed
- Mid-position exhausted

Special features

Operation with external pilot air

- For vacuum applications
- For working pressures lower than 3 bar
- For significant pressure fluctuations in the power section. Power section and pneumatic control section are decoupled
- For heavily lubricated air in the power section
- For manifolds if the pressure zones are created via ducts 3 and 5 (not possible with 2x 3/2)
- For manifolds or pressure zones that are equipped with reversible 2x 3/2-way valves (valves on request)

Operation with internal pilot air

- For small pressure fluctuations in the power section
- For using pressure regulator plates in a vertical stacking construction, also in reverse operation
- As a low-cost solution

Reverse operation with pressure supply via ducts 3 and 5

- Pressure zone separation via ducts 3 and 5
 - Example: duct 3 vacuum, duct 5 ejector pulse
 - Example: duct 3 high pressure for advancing the piston rod of a double-acting cylinder. Duct 5 low pressure for retracting the piston rod with low energy consumption
- 2x 3/2-way valves used as 5/4-way valve with controllable overlapping and pressure zone separation with the reversible variant

Reverse operation with a pressure regulator plate, compressed air supply via duct 1

- Reversible pressure regulator combined with a reversible 2x 3/2-way valve regulates outputs 2 and 4
 - AB regulator for outputs 2 and 4
 - A regulator for output 4
 - B regulator for output 2
- Reversible pressure regulators are in the control position immediately after the power supply is switched on
 - Adjustment possible at all times
 - Dynamic response characteristics
 - Reduced regulator load because the supply pressure is maintained when the valve is switched
 - Venting not via the regulator

Solenoid valves, to ISO 5599-1

Key features

FESTO

Valve manifold with vertical stacking

Solenoid valve with individual pilot valves and pneumatic interface to ISO 15218. Can be connected using square plug sockets

Solenoid valve with central round plug

Flow control plate for adjusting the speed of the drive

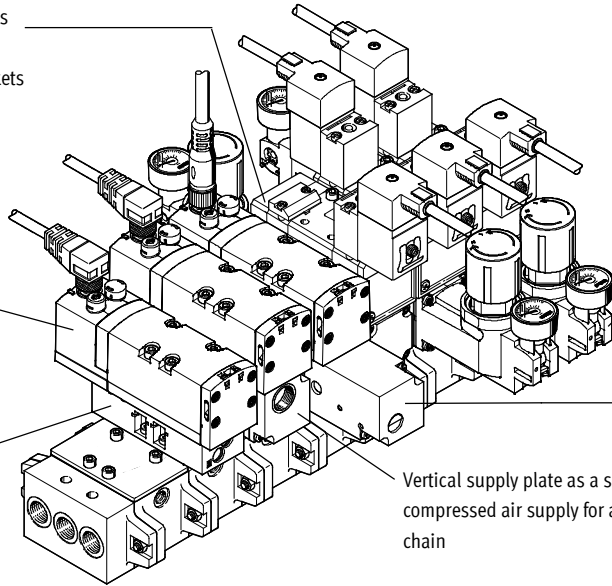

Pressure regulator for adjusting the force of the actuated drive

Vertical pressure shut-off plate for replacing solenoid valves during operation

Vertical supply plate as a separate compressed air supply for a control chain

Vertical stacking function

Pressure regulator plate

- Single variant to regulate the pressure at output 4(A) or 2(B) or at input 1(P)
- Dual variant to regulate the pressure at output 4(A) and 2(B) individually
- Reverse variant for the outputs so that the regulator is in the control position
- With pressure gauge connection

Flow control plate

- Designed with two flow control valves at which the exhaust air flow rate at exhausts 5 or 3 can be adjusted. This enables the movement of the drive to be initiated and the desired speed to be set at the manifold using the manual override.

Vertical pressure shut-off plate

- Equipped with a switch via which the compressed air supply can be shut off. This enables a directional control valve or subsequent vertical stacking plate to be replaced without switching off the overall air supply
- If the control chain has a redundant connection, the cycle can continue in the case of a cyclical control system

Vertical supply plate

- As additional air supply for one valve
- To supply an additional pressure zone

Individual connection with square plug

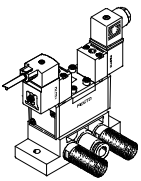

The directional control valve has a pilot control to ISO 15218. The solenoid coil pushed onto the armature tube can be chosen in different designs and operating voltages.

Individual connection with central round plug

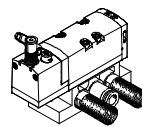

The electrical connection is established via a standardised M12 socket 24 V DC (EN 61076-2-101).

Solenoid valves, to ISO 5599-1

Key features

FESTO

Pressure regulator plate with one pressure regulator

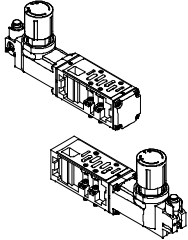

Versions

- For pressure regulation at supply input 1 (P). Set pressure is the same for outputs 2 and 4
- For pressure regulation at working port 4 (A)
 - The pressure regulator for reverse operation is supplied via port 1 of the sub-base and supplies port 5 on the directional control valve
 - The directional control valve vents via port 1 to ports 3 and 5 of the sub-base
- For pressure regulation at working port 2 (B)
 - Input 3 is supplied here in reverse operation

Pressure regulator plate with two pressure regulators

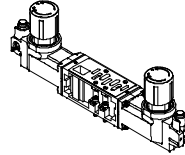

Versions

- For pressure regulation at working ports 4 (A) and 2 (B)
 - The pressure regulators for reverse operation are supplied via port 1 of the sub-base and supply inputs 5 and 3 on the directional control valve
 - The directional control valve vents via port 1 to ports 3 and 5 of the sub-base

Vertical supply plate

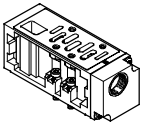

Versions

- As intermediate supply
 - For one valve
 - To supply an additional pressure zone
- Can be equipped with a directional control valve

Flow control plate

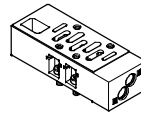

Versions

- Exhaust air restrictors in ducts 3 and 5
 - The flow control plates function as supply air restrictors for pressure zones that are formed via ducts 3 and 5

Vertical pressure shut-off plate

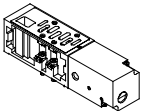

Versions

- A switch activated with a slotted head screwdriver shuts off duct 1
 - The overlying flow control plates, pressure regulator plates or directional control valves can be replaced
 - Other components of the control chain such as drives, for example, can be replaced following venting via the directional control valve

Pressure gauge



Version

- Can be connected to the pressure regulator plates

Solenoid valves, to ISO 5599-1

Key features

Port pattern on sub-base to ISO 5599-1

Defined interface between valve and sub-base

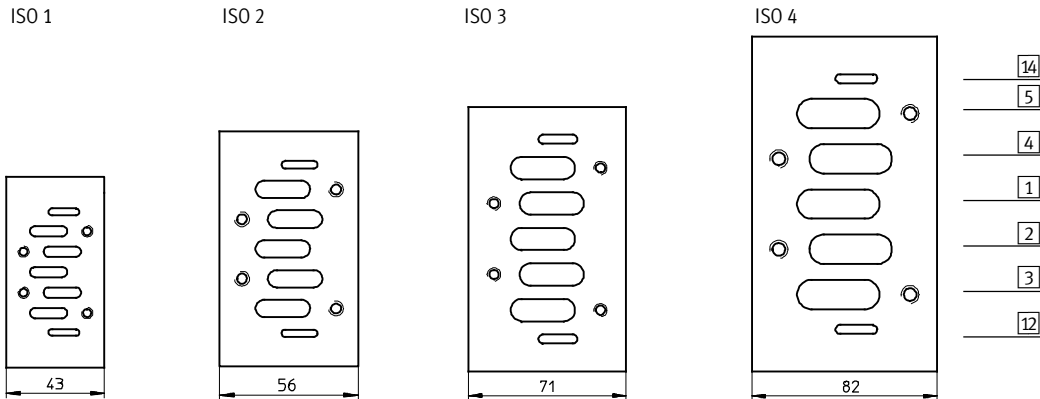

Sub-base port designations

Sub-base port designations		Solenoid valves
14	Control section	External pilot air supply for pilot valves 12 and 14
5	Power section	Exhaust port 5
4	Power section	Working port 4
1	Power section	Working air supply connection 1
2	Power section	Working port 2
3	Power section	Exhaust port 3
12	Control section	Exhaust port for pilot air from 12 and 14

VSVA

Conversion of pilot air venting

VSVA valve manifolds are supplied with unducted venting of the pilot air. By turning the seal between the valve

and manifold block, exhaust air (pilot air) can be diverted into pilot duct 12

and can thus be contained and silenced (see illustration).

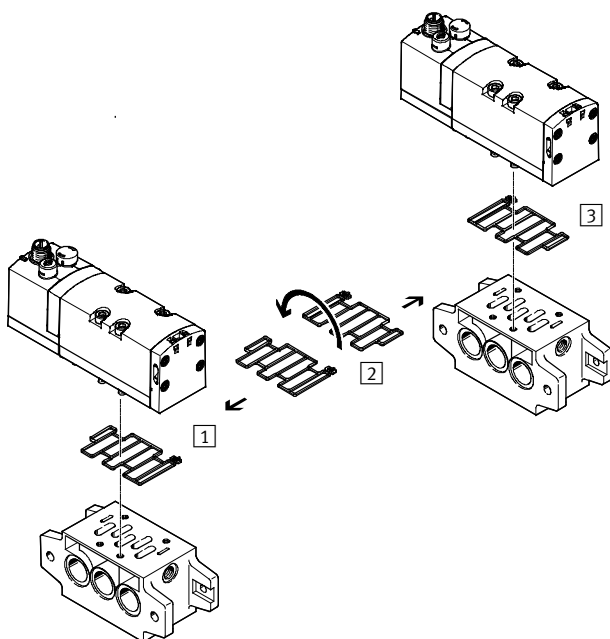

- 1 Ducted pilot air venting
- 2 Turning seal by 180°
- 3 Unducted pilot air venting (as supplied)

Solenoid valves, to ISO 5599-1

Key features

Use of 2x 3/2-way valve as 5/4-way valve																			
Code	Circuit symbol	Value table	Equivalent circuit symbol	Function															
K		<table border="1"> <thead> <tr> <th>Y1</th> <th>Y2</th> <th>A</th> </tr> </thead> <tbody> <tr> <td>0</td> <td>0</td> <td></td> </tr> <tr> <td>0</td> <td>1</td> <td></td> </tr> <tr> <td>1</td> <td>0</td> <td></td> </tr> <tr> <td>1</td> <td>1</td> <td></td> </tr> </tbody> </table>	Y1	Y2	A	0	0		0	1		1	0		1	1			<ul style="list-style-type: none"> • Normally exhausted • The double-acting drive connected to outputs 2 and 4 is unpressurised when the valve is in the normal position and can be moved by an external force • If there is a signal present at Y1(14) and Y2(12), there is pressure at outputs 2 and 4
Y1	Y2	A																	
0	0																		
0	1																		
1	0																		
1	1																		
		<table border="1"> <thead> <tr> <th>Y1</th> <th>Y2</th> <th>A</th> </tr> </thead> <tbody> <tr> <td>0</td> <td>0</td> <td></td> </tr> <tr> <td>0</td> <td>1</td> <td></td> </tr> <tr> <td>1</td> <td>0</td> <td></td> </tr> <tr> <td>1</td> <td>1</td> <td></td> </tr> </tbody> </table>	Y1	Y2	A	0	0		0	1		1	0		1	1			<ul style="list-style-type: none"> • Normally closed (by combining directional control valve code K and two piloted non-return valves) • The piloted non-return valves connected to outputs 2 and 4 are unpressurised when the valve is in the normal position and the pressures in the drive close the non-return valves leak-tight • The drive stops when the forces are in equilibrium • Leakages can only occur via the drive seals • If there is a signal present at Y1(14) and Y2(12), the same pressure is present at outputs 2 and 4
Y1	Y2	A																	
0	0																		
0	1																		
1	0																		
1	1																		
N		<table border="1"> <thead> <tr> <th>Y1</th> <th>Y2</th> <th>A</th> </tr> </thead> <tbody> <tr> <td>0</td> <td>0</td> <td></td> </tr> <tr> <td>0</td> <td>1</td> <td></td> </tr> <tr> <td>1</td> <td>0</td> <td></td> </tr> <tr> <td>1</td> <td>1</td> <td></td> </tr> </tbody> </table>	Y1	Y2	A	0	0		0	1		1	0		1	1			<ul style="list-style-type: none"> • Normally open • The double-acting drive connected to outputs 2 and 4 is supplied with the same compressed air at both ends when the valve is in the normal position and stops when the forces are in equilibrium • If there is a signal present at Y1(10) and Y2(10), outputs 2 and 4 are exhausted, the drive is unpressurised and can be moved by an external force
Y1	Y2	A																	
0	0																		
0	1																		
1	0																		
1	1																		
H		<table border="1"> <thead> <tr> <th>Y1</th> <th>Y2</th> <th>A</th> </tr> </thead> <tbody> <tr> <td>0</td> <td>0</td> <td></td> </tr> <tr> <td>0</td> <td>1</td> <td></td> </tr> <tr> <td>1</td> <td>0</td> <td></td> </tr> <tr> <td>1</td> <td>1</td> <td></td> </tr> </tbody> </table>	Y1	Y2	A	0	0		0	1		1	0		1	1			<ul style="list-style-type: none"> • Normally open after output 2 • The double-acting drive connected to outputs 2 and 4 is supplied with compressed air via output 2 when the valve is in the normal position. Output 4 is exhausted. The drive is thus in a clearly defined position in the initial position of the system, as would also be the case with a single solenoid 5/2-way valve • If there is a signal present at Y1(14) and Y2(10), output 2 is exhausted and there is pressure at output 4. The drive leaves the initial position • A closed circuit can be created with this 2x 3/2-way valve by combining it with piloted non-return valves. However, this is then selected by an active signal at Y2(10)
Y1	Y2	A																	
0	0																		
0	1																		
1	0																		
1	1																		

Solenoid valves, to ISO 5599-1

Product range overview

FESTO

ISO size/ width	Function	Solenoid coil → Page/Internet						
		N1 ¹⁾	F1 ¹⁾	VSVA	D ²⁾	EB		
1/42 mm	Operating voltage 12 V DC							
	5/2-way valve	Single solenoid, pneumatic spring	-	27	-	-	-	
		Single solenoid, mechanical spring	-	27	-	-	-	
		Double solenoid	-	27	-	-	-	
		Double solenoid, dominant signal at 14	-	27	-	-	-	
	5/3-way valve	Mid-position closed	-	27	-	-	-	
		Mid-position pressurised	-	27	-	-	-	
		Mid-position exhausted	-	27	-	-	-	
	Operating voltage 24 V AC							
	5/2-way valve	Single solenoid, pneumatic spring	-	27	-	-	-	
		Single solenoid, mechanical spring	-	27	-	-	-	
		Double solenoid	-	27	-	-	-	
		Double solenoid, dominant signal at 14	-	27	-	-	-	
	5/3-way valve	Mid-position closed	-	27	-	-	-	
		Mid-position pressurised	-	27	-	-	-	
		Mid-position exhausted	-	27	-	-	-	
	Operating voltage 24 V DC							
	2x2/2-way valve	2x closed	-	-	35	-	-	
	2x3/2-way valve	2x closed	-	-	35	-	-	
		2x open	-	-	35	-	-	
		1x closed, 1x open	-	-	35	-	-	
	5/2-way valve	Single solenoid, pneumatic spring	19	27	35	45	-	
		Single solenoid, mechanical spring	19	27	35	-	-	
		Double solenoid	19	27	35	45	-	
		Double solenoid, dominant signal at 14	19	27	35	45	-	
	5/3-way valve	Mid-position closed	19	27	35	45	-	
		Mid-position pressurised	19	27	-	45	53	
		Mid-position exhausted	19	27	35	45	-	
	Operating voltage 42 V AC							
	5/2-way valve	Single solenoid, pneumatic spring	-	27	-	-	-	
		Single solenoid, mechanical spring	-	27	-	-	-	
		Double solenoid	-	27	-	-	-	
		Double solenoid, dominant signal at 14	-	27	-	-	-	
	5/3-way valve	Mid-position closed	-	27	-	-	-	
		Mid-position pressurised	-	27	-	-	-	
		Mid-position exhausted	-	27	-	-	-	
	Operating voltage 42 V DC							
	5/2-way valve	Single solenoid, pneumatic spring	-	27	-	-	-	
		Single solenoid, mechanical spring	-	27	-	-	-	
		Double solenoid	-	27	-	-	-	
		Double solenoid, dominant signal at 14	-	27	-	-	-	
	5/3-way valve	Mid-position closed	-	27	-	-	-	
		Mid-position pressurised	-	27	-	-	-	
		Mid-position exhausted	-	27	-	-	-	
	1/42 mm	Operating voltage 48 V AC						
		5/2-way valve	Single solenoid, pneumatic spring	-	27	-	-	-
			Single solenoid, mechanical spring	-	27	-	-	-
			Double solenoid	-	27	-	-	-
Double solenoid, dominant signal at 14			-	27	-	-	-	
5/3-way valve		Mid-position closed	-	27	-	-	-	
		Mid-position pressurised	-	27	-	-	-	
		Mid-position exhausted	-	27	-	-	-	

1) Coil with required voltage must be ordered separately

2) Only with internal pilot air supply

Solenoid valves, to ISO 5599-1

Product range overview

ISO size/ width	Function	Solenoid coil → Page/Internet					
		N1 ¹⁾	F1)	VSVA	D	EB	
1/42 mm	Operating voltage 110 V AC						
	5/2-way valve	Single solenoid, pneumatic spring	19	27	-	-	-
		Single solenoid, mechanical spring	19	27	-	-	-
		Double solenoid	19	27	-	-	-
		Double solenoid, dominant signal at 14	19	27	-	-	-
	5/3-way valve	Mid-position closed	19	27	-	-	-
		Mid-position pressurised	19	27	-	-	-
		Mid-position exhausted	19	27	-	-	-
	Operating voltage 230 V AC						
	5/2-way valve	Single solenoid, pneumatic spring	19	27	-	-	-
		Single solenoid, mechanical spring	19	27	-	-	-
		Double solenoid	19	27	-	-	-
		Double solenoid, dominant signal at 14	19	27	-	-	-
	5/3-way valve	Mid-position closed	19	27	-	-	-
		Mid-position pressurised	19	27	-	-	-
		Mid-position exhausted	19	27	-	-	-
	Operating voltage 240 V AC						
	5/2-way valve	Single solenoid, pneumatic spring	-	27	-	-	-
		Single solenoid, mechanical spring	-	27	-	-	-
		Double solenoid	-	27	-	-	-
		Double solenoid, dominant signal at 14	-	27	-	-	-
	5/3-way valve	Mid-position closed	-	27	-	-	-
		Mid-position pressurised	-	27	-	-	-
		Mid-position exhausted	-	27	-	-	-

1) Coil with required voltage must be ordered separately

Solenoid valves, to ISO 5599-1

Product range overview

FESTO

ISO size/ width	Function	Solenoid coil → Page/Internet					
		N1 ¹⁾	F1)	VSVA	D ²⁾	EB	
2/52 mm	Operating voltage 12 V DC						
	5/2-way valve	Single solenoid, pneumatic spring	–	31	–	–	–
		Single solenoid, mechanical spring	–	31	–	–	–
		Double solenoid	–	31	–	–	–
		Double solenoid, dominant signal at 14	–	31	–	–	–
	5/3-way valve	Mid-position closed	–	31	–	–	–
		Mid-position pressurised	–	31	–	–	–
		Mid-position exhausted	–	31	–	–	–
	Operating voltage 24 V AC						
	5/2-way valve	Single solenoid, pneumatic spring	–	31	–	–	–
		Single solenoid, mechanical spring	–	31	–	–	–
		Double solenoid	–	31	–	–	–
		Double solenoid, dominant signal at 14	–	31	–	–	–
	5/3-way valve	Mid-position closed	–	31	–	–	–
		Mid-position pressurised	–	31	–	–	–
		Mid-position exhausted	–	31	–	–	–
	Operating voltage 24 V DC						
	2x2/2-way valve	2x closed	–	–	40	–	–
	2x3/2-way valve	2x closed	–	–	40	–	–
		2x open	–	–	40	–	–
		1x closed, 1x open	–	–	40	–	–
	5/2-way valve	Single solenoid, pneumatic spring	23	31	40	49	–
		Single solenoid, mechanical spring	23	31	40	–	–
		Double solenoid	23	31	40	49	–
		Double solenoid, dominant signal at 14	23	31	40	49	–
	5/3-way valve	Mid-position closed	23	31	40	49	–
		Mid-position pressurised	23	31	–	49	57
		Mid-position exhausted	23	31	40	49	–
	Operating voltage 42 V AC						
	5/2-way valve	Single solenoid, pneumatic spring	–	31	–	–	–
		Single solenoid, mechanical spring	–	31	–	–	–
		Double solenoid	–	31	–	–	–
		Double solenoid, dominant signal at 14	–	31	–	–	–
	5/3-way valve	Mid-position closed	–	31	–	–	–
		Mid-position pressurised	–	31	–	–	–
		Mid-position exhausted	–	31	–	–	–
	Operating voltage 42 V DC						
	5/2-way valve	Single solenoid, pneumatic spring	–	31	–	–	–
		Single solenoid, mechanical spring	–	31	–	–	–
		Double solenoid	–	31	–	–	–
		Double solenoid, dominant signal at 14	–	31	–	–	–
	5/3-way valve	Mid-position closed	–	31	–	–	–
Mid-position pressurised		–	31	–	–	–	
Mid-position exhausted		–	31	–	–	–	

1) Coil with required voltage must be ordered separately

2) Only with internal pilot air supply

Solenoid valves, to ISO 5599-1

Product range overview

FESTO

ISO size/ width	Function	Solenoid coil → Page/Internet					
		N1 ¹⁾	F1)	VSVA	D	EB	
2/52 mm	Operating voltage 48 V AC						
	5/2-way valve	Single solenoid, pneumatic spring	–	31	–	–	–
		Single solenoid, mechanical spring	–	31	–	–	–
		Double solenoid	–	31	–	–	–
		Double solenoid, dominant signal at 14	–	31	–	–	–
	5/3-way valve	Mid-position closed	–	31	–	–	–
		Mid-position pressurised	–	31	–	–	–
		Mid-position exhausted	–	31	–	–	–
	Operating voltage 110 V AC						
	5/2-way valve	Single solenoid, pneumatic spring	23	31	–	–	–
		Single solenoid, mechanical spring	23	31	–	–	–
		Double solenoid	23	31	–	–	–
		Double solenoid, dominant signal at 14	23	31	–	–	–
	5/3-way valve	Mid-position closed	23	31	–	–	–
		Mid-position pressurised	23	31	–	–	–
		Mid-position exhausted	23	31	–	–	–
	Operating voltage 230 V AC						
	5/2-way valve	Single solenoid, pneumatic spring	23	31	–	–	–
		Single solenoid, mechanical spring	23	31	–	–	–
		Double solenoid	23	31	–	–	–
		Double solenoid, dominant signal at 14	23	31	–	–	–
	5/3-way valve	Mid-position closed	23	31	–	–	–
		Mid-position pressurised	23	31	–	–	–
		Mid-position exhausted	23	31	–	–	–
	Operating voltage 240 V AC						
	5/2-way valve	Single solenoid, pneumatic spring	–	31	–	–	–
		Single solenoid, mechanical spring	–	31	–	–	–
		Double solenoid	–	31	–	–	–
		Double solenoid, dominant signal at 14	–	31	–	–	–
	5/3-way valve	Mid-position closed	–	31	–	–	–
		Mid-position pressurised	–	31	–	–	–
		Mid-position exhausted	–	31	–	–	–

1) Coil with required voltage must be ordered separately

Solenoid valves, to ISO 5599-1

Type codes for valves with round plug

FESTO

VSVA		-	B	-	T	32	C	-	A	Z	D	-	D1	-	1	R5	L	
Valve series																		
VSVA	Standard valves to ISO 5599-1																	
Valve type																		
B	Sub-base valve																	
Valve function																		
M	Single solenoid																	
B	Double solenoid																	
D	Double solenoid with dominant signal at 14																	
P	Double solenoid, mid-position																	
T	2 single solenoid valves in one housing																	
Ports/switching positions																		
22	2/2-way valve																	
32	3/2-way valve																	
52	5/2-way valve																	
53	5/3-way valve																	
Normal position/additional function																		
C	Closed																	
U	Open																	
E	Exhausted																	
H	T with 1x open, 1x closed, double solenoid valve																	
N	T, closed, reverse operation																	
F	T, open, reverse operation																	
W	T, exhausted, reverse operation																	
V	T22C, vacuum operation																	
Reset method																		
A	Pneumatic spring																	
M	Mechanical spring																	
Pilot air supply																		
Z	External																	
	Internal																	
Manual override																		
D	Non-detenting/detenting																	
Standard																		
D1	ISO size 1, width 42 mm																	
D2	ISO size 2, width 52 mm																	
Operating voltage																		
1	24 V DC																	
Electrical connection																		
R5	Central plug M12x1																	
Signal status display																		
L	LED (integrated)																	

Solenoid valves, to ISO 5599-1

Type codes for valves with square plug

MN1H		-	5/3	G	-	D-1	-		-		-		-	C
Type														
MN1H	Single solenoid, for N1 solenoid coil													
MFH	Single solenoid, for F solenoid coil													
MDH	Single solenoid, with D solenoid coil													
JMN1H	Double solenoid, for N1 solenoid coil													
JMN1DH	Double solenoid, for N1 solenoid coil, with dominant signal at 14													
JMFH	Double solenoid, for F solenoid coil													
JMFDH	Double solenoid, for F solenoid coil, with dominant signal at 14													
JMDH	Double solenoid, with D solenoid coil													
Valve function														
5/2	5/2-way valve													
5/3	5/3-way valve													
Normal position														
G	Closed													
E	Exhausted													
B	Pressurised													
Size														
D-1	ISO size 1, width 42 mm													
D-2	ISO size 2, width 52 mm													
D-3	ISO size 3, width 65 mm													
¾-D-4	ISO size 4, width 76 mm													
Electrical connection, operating voltage														
Plug, square design to EN 175301-803, type A														
24DC	24 V DC													
Pilot air supply														
	Internal													
S	External													
Reset method														
FR	Mechanical spring													
	Pneumatic spring													
Generation														
C	C series													

Solenoid valves, to ISO 5599-1

Type codes for valves with round plug

MDH - 5/3 G - D-1 - - - - - C

Type	
MDH	Single solenoid, with D solenoid coil
MEBH	Single solenoid, with EB solenoid coil
JMDH	Double solenoid, for D solenoid coil
JMDDH	Double solenoid, for D solenoid coil, with dominant signal at 14
JMEBH	Double solenoid, with EB solenoid coil
JMEBDH	Double solenoid, with EB solenoid coil, with dominant signal at 14

Valve function	
5/2	5/2-way valve
5/3	5/3-way valve

Normal position	
G	Closed
E	Exhausted
B	Pressurised

Size	
D-1	ISO size 1, width 42 mm
D-2	ISO size 2, width 52 mm
D-3	ISO size 3, width 65 mm

Electrical connection, operating voltage	
Central plug, round design, M12x1	
ZSR	24 V DC
Individual plug, round design, M12x1	
M12	24 V DC

Pin allocation	
	2-pin to VDMA
D	4-pin to Desina

Pilot air supply	
	Internal
S	External

Reset method	
FR	Mechanical spring
	Pneumatic spring

Generation	
C	C series

Solenoid valves, to ISO 5599-1

Peripherals overview

FESTO

Individual mounting with square plug or round plug

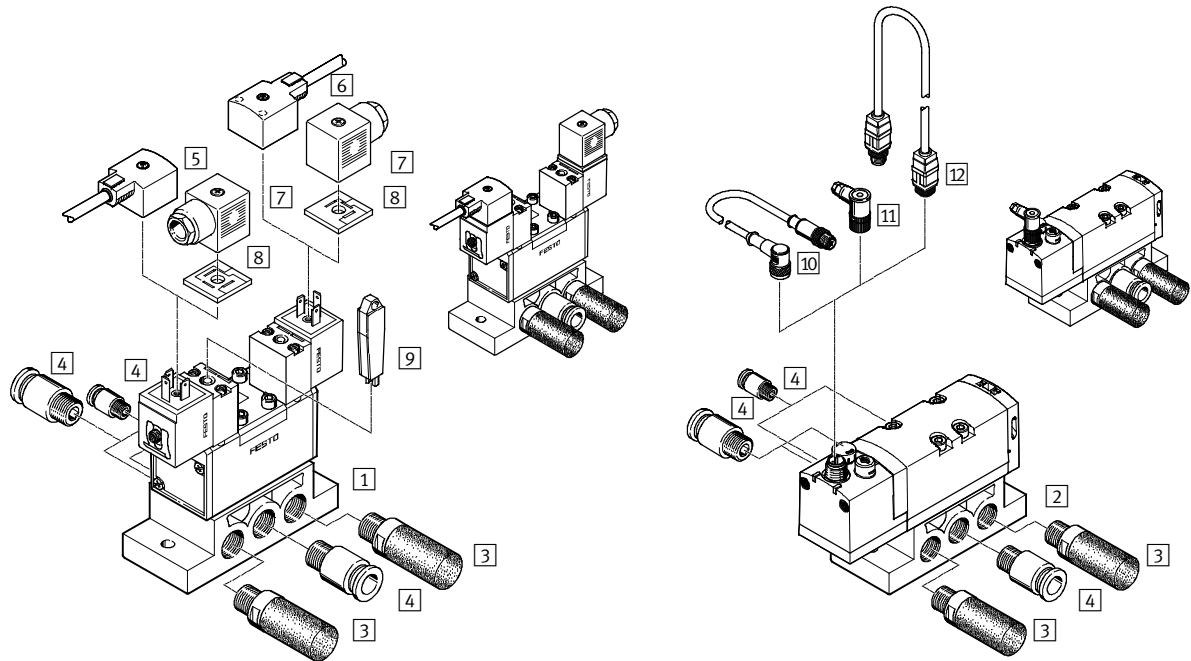

Component parts				
	Type	Brief description	→ Page/ Internet	
1	Solenoid valve on individual sub-base	MN1H-..., NAS	Port pattern to ISO 5599-1, corresponding solenoid coils → 72	61
2	Solenoid valve on individual sub-base	VSVA..., NAS	Port pattern to ISO 5599-1	
3	Silencer	U	For fitting in exhaust ports	u
4	Push-in fitting	QS	For connecting compressed air tubing with standard O.D.	qs
5	Plug socket with cable	KMC-...	Without LED	72
6	Plug socket with cable	KMC-...LED	With LED	
7	Plug socket	MSSD-C	For self-assembly	
8	Illuminating seal	M...-LD	For indicating the signal status	
9	Manual override	AHB	Tool for detenting manual override	
10	Connecting cable	NEBU	-	
11	Plug socket	SAE	For self-assembly	
12	Plug socket with cable	KM	-	

Variants

MN1H, JMN1H

MFH, JMFH

VSVA

MDH, JMDH

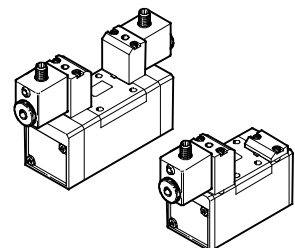
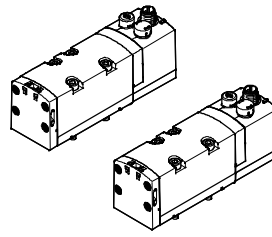
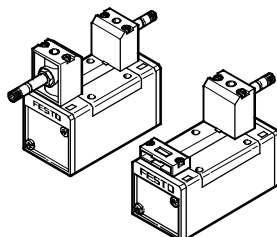
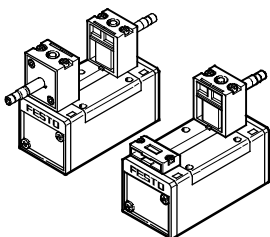

Solenoid valves, to ISO 5599-1

System overview

FESTO

Manifold assembly without vertical stacking

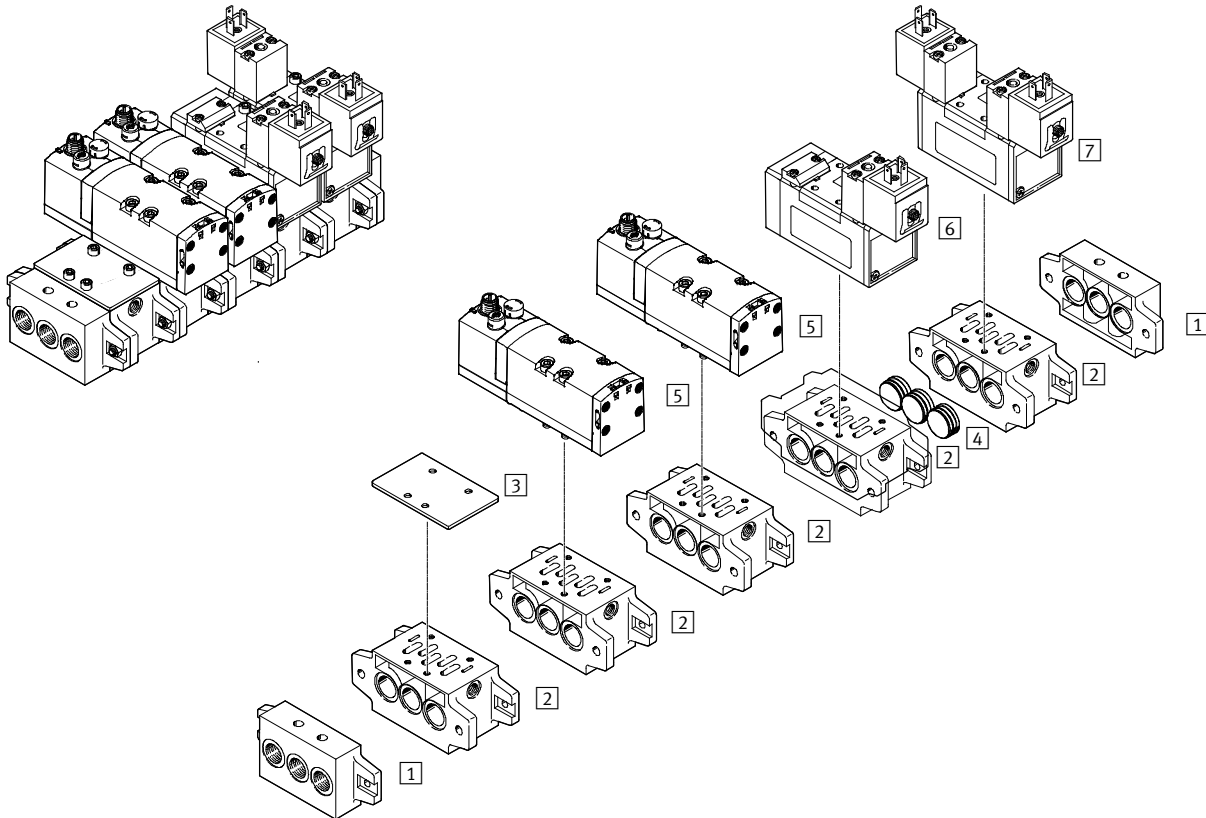

Component parts				
	Type	Brief description	→ Page/ Internet	
1	End plate kit	NEV	With ports for air supply 1 and exhausts 3 and 5	61
2	Manifold sub-base	NAV	With ports 2 and 4 underneath	
3	Blanking plate	NDV	For sealing unused manifold sub-bases	
4	Isolating disc	NSC	For sealing the common lines 1, 3, 5 between end plates and manifold sub-bases or between 2 manifold sub-bases, for example for different working pressures	
5	Solenoid valve	VSVA	Port pattern to ISO 5599-1, all functions	35
6	Solenoid valve	MN1H	Port pattern to ISO 5599-1, corresponding solenoid coils → 72	19
7	Solenoid valve	JMN1H		

Variants

MN1H, JMN1H

MFH, JMFH

VSVA

MDH, JMDH

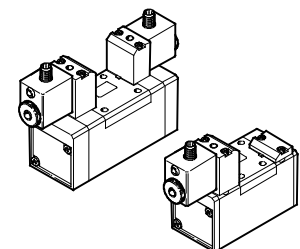
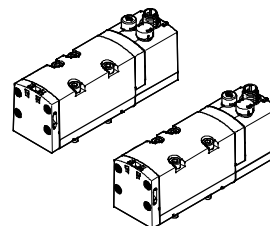
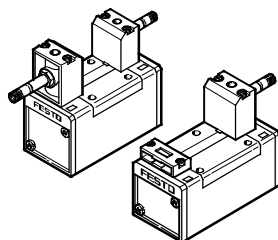
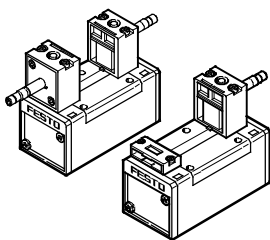

Solenoid valves, to ISO 5599-1

System overview

Manifold assembly with vertical stacking

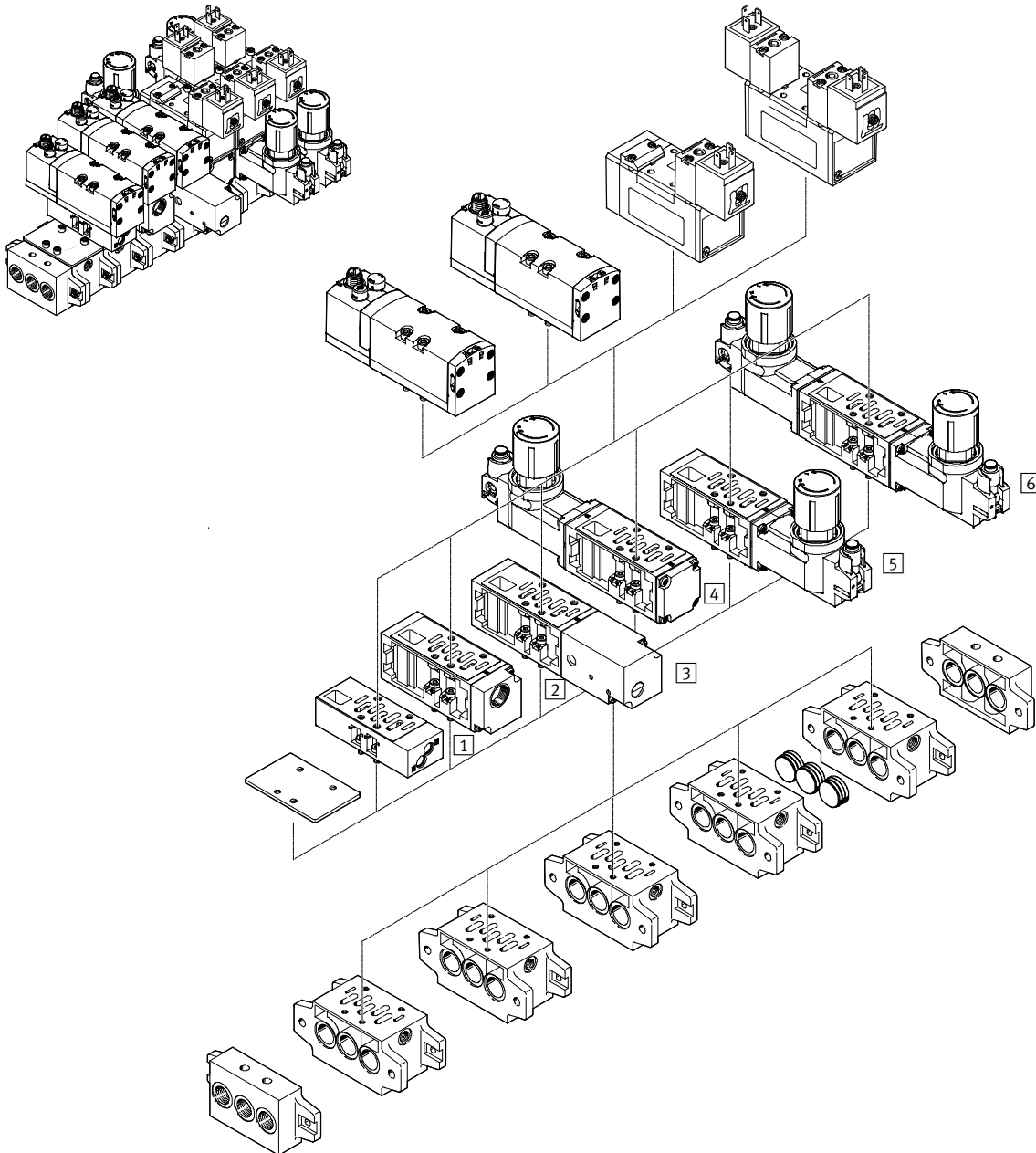

Component parts				
	Type	Brief description	→ Page/ Internet	
1	Flow control plate	VABF-S1-1-F1B1-C164	Controls the flow of exhaust air in 3 and 5	69
2	Vertical supply plate	VABF-S1-1-L1D1-C	Supplies the mounted valve with air	70
3	Vertical pressure shut-off plate	VABF-S1-1-P1A3-G38	Switch for shutting off the air supply 1 to the valve	71
4	Regulator plate P	VABF-S1-1-R1...	Regulates input 1	65
5	Regulator plate B	VABF-S1-1-R3...	Regulates output 2	
6	Regulator plate AB	VABF-S1-1-R4...	Regulates outputs 2 and 4 individually	

Solenoid valves, to ISO 5599-1

Peripherals overview

FESTO

Accessories

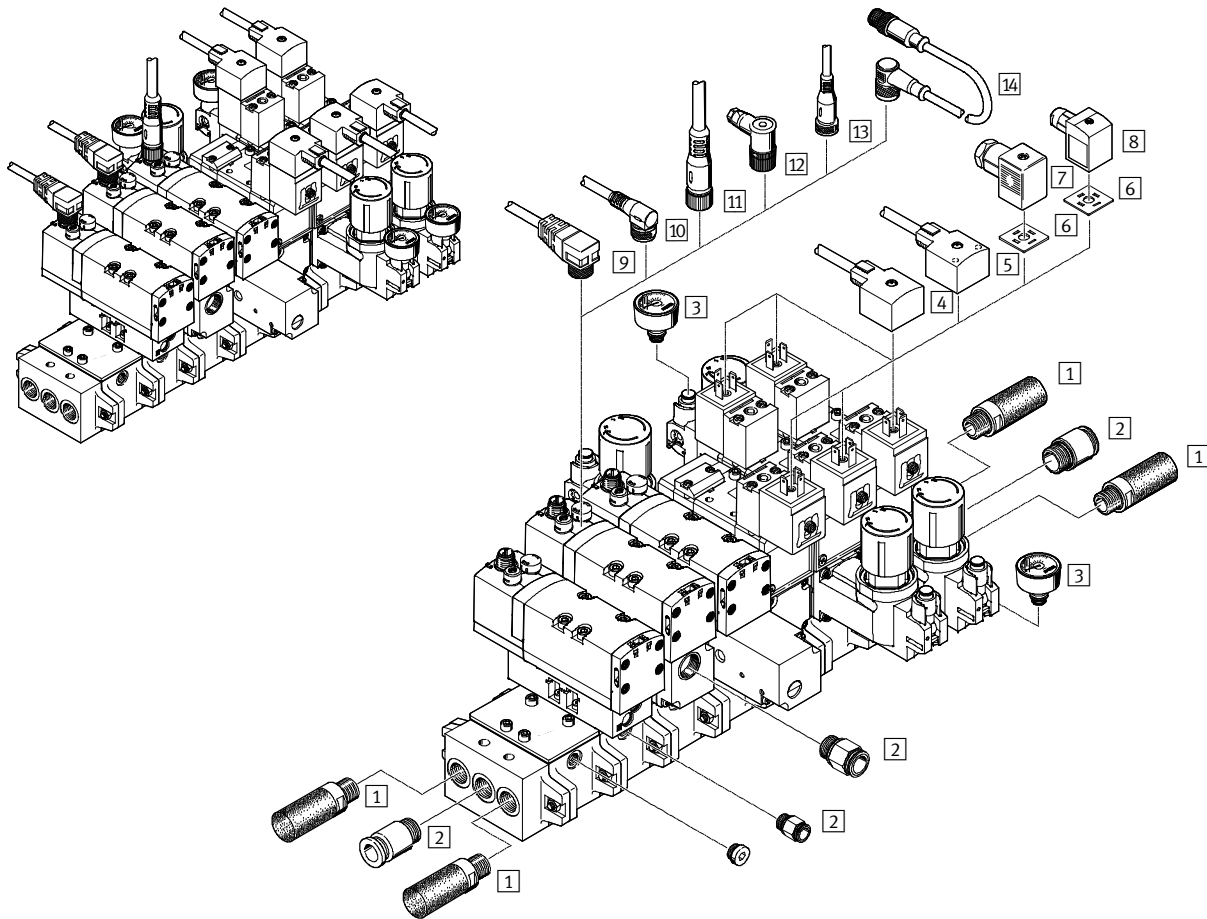



Component parts			
	Type	Brief description	→ Page/ Internet
1	U	For fitting in exhaust ports	u
2	QS	For connecting compressed air tubing with standard O.D.	qs
3	PAGN	With push-in connector	72
4	KMC...	Without LED	
5	KMC...LED	With LED	
6	M...LD	For indicating the signal status	
7	MSSD-C-M16	With screw terminal connection	
8	MSSD-C-S-M16	With insulation displacement connection	
9	NEBU	-	
10	NEBU	-	
11	NEBU	-	
12	SAE	For self-assembly	
13	NEBU	-	
14	KM-12-M12-GSWD-1-4	-	km

Solenoid valves MN1H, JMN1H, JMN1DH, to ISO 5599-1

FESTO

Technical data – Width 42 mm

-  - Flow rate
1,200 l/min

-  - Voltage
24 V DC
110, 230 V AC

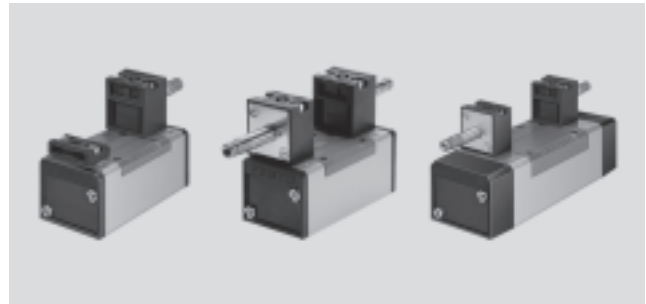

General technical data					
Valve function	5/2-way		5/3-way		
Normal position	–	–	G ¹⁾	B ²⁾	E ³⁾
Memory stability	Single solenoid	Double solenoid	Double solenoid		
Pneumatic spring reset method	Yes	–	No		
Mechanical spring reset method	Yes	–	Yes		
Design	Piston spool valve				
Sealing principle	Soft				
Actuation type	Electric				
Type of control	Piloted				
Pilot interface	To ISO 15218				
Pilot air supply	Internal or external				
Direction of flow	Reversible with external pilot air supply				
Exhaust function	Flow control				
Manual override	Non-detenting, detenting with tool				
Type of mounting	On sub-base				
Mounting position	Any				
Nominal size	[mm]	8			
Standard nominal flow rate	[l/min]	1,200			
Switching time on/off, pneumatic spring	[ms]	23/32	–	–	
Switching time on/off, mechanical spring	[ms]	17/39	–	20/44	20/46
Changeover time	[ms]	–	18	–	
Switching time with dominant signal at 14 (12/14)	[ms]	–	18/15	–	
Width	[mm]	42			
Grid dimension	[mm]	43			
Connection on the sub-base	1, 2, 3, 4, 5	G $\frac{1}{4}$			
	12, 14	M5			
Tightening torque for valve mounting	[Nm]	–			
Noise level	[dB (A)]	85			
Conforms to	ISO 5599-1 and ISO 15218 for pilot valve interface				
Certification	Germanischer Lloyd				
	c UL us Recognized (OL) (C series with internal pilot air supply only)				
Product weight	[g]	450	610	650	

- 1) G = Normally closed
2) B = Normally open
3) E = Normally exhausted

Solenoid valves MN1H, JMN1H, JMN1DH, to ISO 5599-1

FESTO

Technical data – Width 42 mm

Operating and environmental conditions			
Reset method		Pneumatic	Mechanical
Operating medium		Compressed air in accordance with ISO 8573-1:2010 [7:4:4]	
Pilot medium		Compressed air in accordance with ISO 8573-1:2010 [7:4:4]	
Note on operating/pilot medium		Operation with lubricated medium possible (in which case lubricated operation will always be required)	
Operating pressure	Internal pilot air supply [bar]	2 ... 10	3 ... 10
	External pilot air supply [bar]	-0.9 ... +16	-0.9 ... +16
Pilot pressure [bar]		2 ... 10	3 ... 10
Ambient temperature [°C]		-5 ... +50	
Temperature of medium [°C]		-5 ... +50	

Electrical data – N1 solenoid coil			
Electrical connection		Plug, square design to EN 175301-803, type A	
Operating voltage	DC voltage [V DC]	24	
	AC voltage [V AC]	110/230 (50 ... 60 Hz)	
Coil characteristics	DC voltage [W]	2.5	
	AC voltage [VA]	Pull: 7.5 Hold: 5	
Protection class to EN 60529		IP65	

Materials

Sectional view

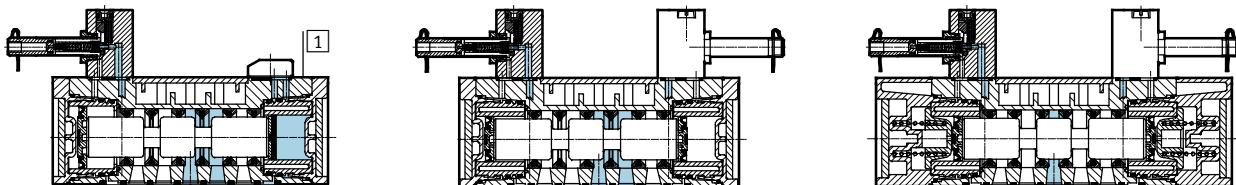

1	Housing	Die-cast aluminium
-	Seals	NBR (nitrile rubber)
Note on materials		RoHS-compliant

Solenoid valves MN1H, JMN1H, JMN1DH, to ISO 5599-1

Technical data – Width 42 mm

Dimensions

Download CAD data → www.festo.com

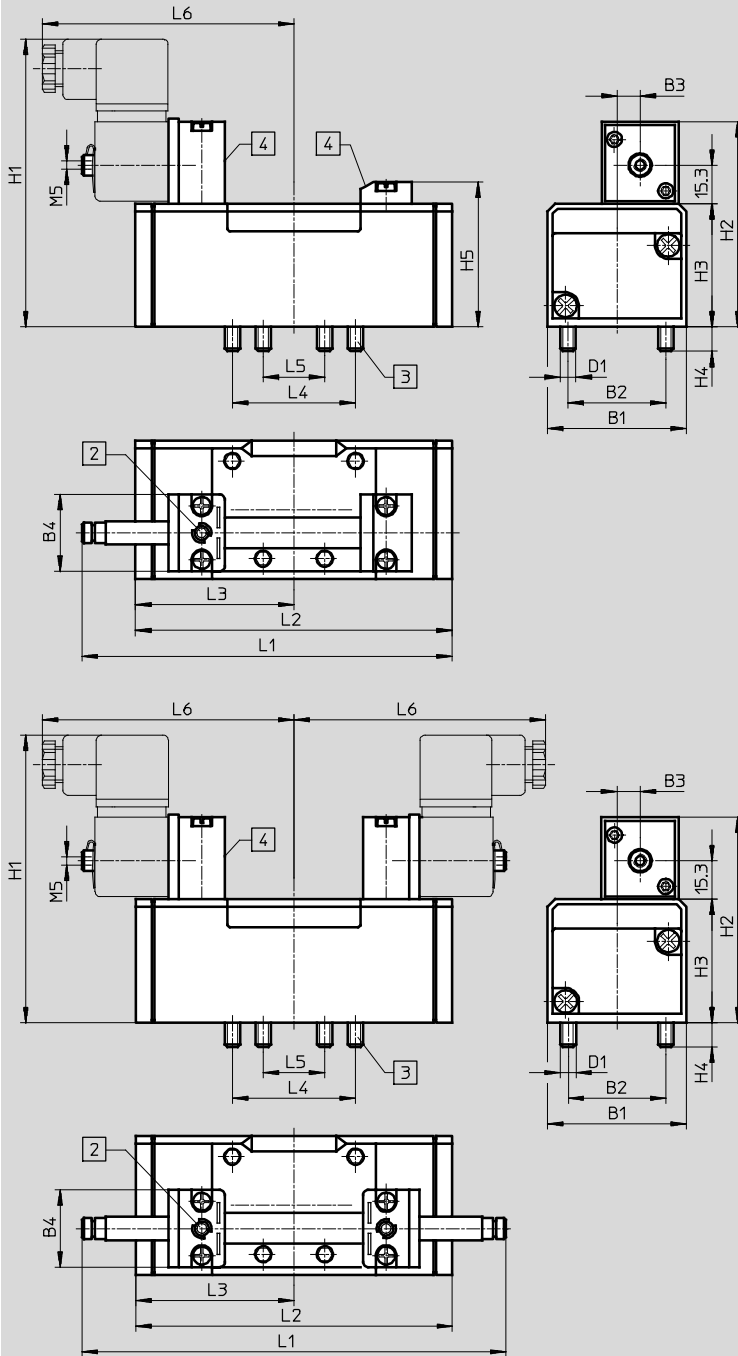

- 2 Manual override
- 3 Captive mounting screws
- 4 Slot for inscription label

Type	B1	B2	B3	B4	D1	H1	H2	H3	H4	H5	L1	L2	L3	L4	L5	L6
MN1H-5/2	42	28	6	30	M5	106	74	38	9	46.5	117.5	87.6	43.8	36	18	89
JMN1H-5/2											147.3	87.6				
MN1H-5/2-...-FR											128	98				
MN1H-5/3											147.3	108.4				

Solenoid valves MN1H, JMN1H, JMN1DH, to ISO 5599-1

FESTO

Ordering data – Width 42 mm

Ordering data – Solenoid valves without solenoid coil ¹⁾ , internal pilot air supply			
Circuit symbol	Description	Part No.	Type
5/2-way valve, single solenoid			
	Pneumatic reset method	159688	MN1H-5/2-D-1-C
	Mechanical reset method	159687	MN1H-5/2-D-1-FR-C
5/2-way valve, double solenoid			
	–	159690	JMN1H-5/2-D-1-C
	With dominant signal at 14	159691	JMN1DH-5/2-D-1-C
5/3-way valve, single solenoid			
	Normally closed	159681	MN1H-5/3G-D-1-C
	Normally exhausted	159683	MN1H-5/3E-D-1-C
	Normally open	159685	MN1H-5/3B-D-1-C

1) N1 solenoid coils → 72

Ordering data – Solenoid valves without solenoid coil ¹⁾ , external pilot air supply			
Circuit symbol	Description	Part No.	Type
5/2-way valve, single solenoid			
	Pneumatic reset method	159686	MN1H-5/2-D-1-S-C
	Mechanical reset method	159716	MN1H-5/2-D-1-FR-S-C
5/2-way valve, double solenoid			
	–	159689	JMN1H-5/2-D-1-S-C
	With dominant signal at 14	159717	JMN1DH-5/2-D-1-S-C
5/3-way valve, double solenoid			
	Normally closed	159680	MN1H-5/3G-D-1-S-C
	Normally exhausted	159682	MN1H-5/3E-D-1-S-C
	Normally open	159684	MN1H-5/3B-D-1-S-C

1) N1 solenoid coils → 72

Solenoid valves MN1H, JMN1H, JMN1DH, to ISO 5599-1

FESTO

Technical data – Width 52 mm

-  - Flow rate
2,300 l/min

-  - Voltage
24 V DC
110, 230 V AC

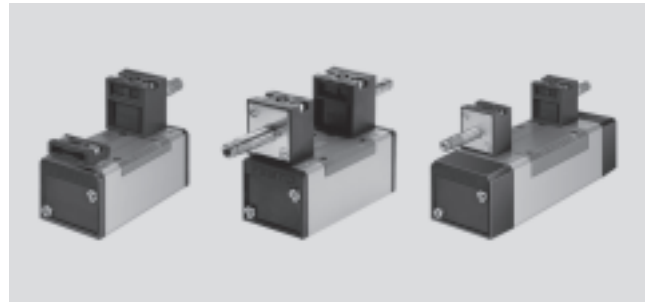

General technical data					
Valve function	5/2-way		5/3-way		
Normal position	–	–	G ¹⁾	B ²⁾	E ³⁾
Memory stability	Single solenoid	Double solenoid	Double solenoid		
Pneumatic spring reset method	Yes	–	No		
Mechanical spring reset method	Yes	–	Yes		
Design	Piston spool valve				
Sealing principle	Soft				
Actuation type	Electric				
Type of control	Piloted				
Pilot interface	To ISO 15218				
Pilot air supply	Internal or external				
Direction of flow	Reversible with external pilot air supply				
Exhaust function	Flow control				
Manual override	Non-detenting, detenting with tool				
Type of mounting	On sub-base				
Mounting position	Any				
Nominal size	[mm]	11			
Standard nominal flow rate	[l/min]	2,300			
Switching time on/off, pneumatic spring	[ms]	46/69	–	–	
Switching time on/off, mechanical spring	[ms]	24/62	–	33/82	35/78 36/84
Changeover time	[ms]	–	21	–	
Switching time with dominant signal at 14 (12/14)	[ms]	–	24/21	–	
Width	[mm]	42			
Grid dimension	[mm]	56			
Connection on the sub-base	1, 2, 3, 4, 5 12, 14	G $\frac{3}{8}$ M5			
Tightening torque for valve mounting	[Nm]	85			
Noise level	[dB (A)]	85			
Conforms to	ISO 5599-1 and ISO 15218 for pilot valve interface				
Certification	Germanischer Lloyd c UL us Recognized (OL) (C series with internal pilot air supply only)				
Product weight	[g]	710	880	940	

- 1) G = Normally closed
2) B = Normally open
3) E = Normally exhausted

Solenoid valves MN1H, JMN1H, JMN1DH, to ISO 5599-1

FESTO

Technical data – Width 52 mm

Operating and environmental conditions			
Reset method		Pneumatic	Mechanical
Operating medium		Compressed air in accordance with ISO 8573-1:2010 [7:4:4]	
Pilot medium		Compressed air in accordance with ISO 8573-1:2010 [7:4:4]	
Note on operating/pilot medium		Operation with lubricated medium possible (in which case lubricated operation will always be required)	
Operating pressure	Internal pilot air supply [bar]	2 ... 10	3 ... 10
	External pilot air supply [bar]	-0.9 ... +16	-0.9 ... +16
Pilot pressure [bar]		2 ... 10	3 ... 10
Ambient temperature [°C]		-5 ... +50	
Temperature of medium [°C]		-5 ... +50	

Electrical data – N1 solenoid coil			
Electrical connection		Plug, square design to EN 175301-803, type A	
Operating voltage	DC voltage [V DC]	24	
	AC voltage [V AC]	110/230 (50 ... 60 Hz)	
Coil characteristics	DC voltage [W]	2.5	
	AC voltage [VA]	Pull: 7.5 Hold: 5	
Protection class to EN 60529		IP65	

Materials

Sectional view

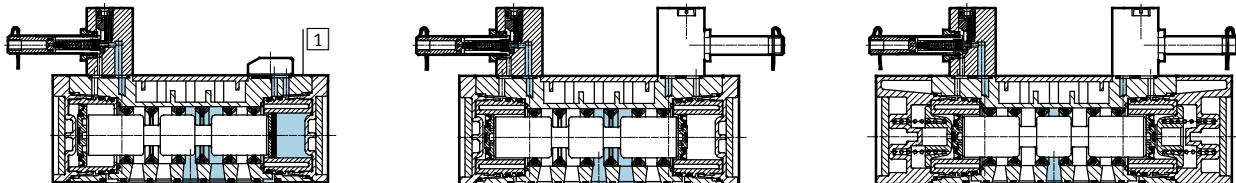

1	Housing	Die-cast aluminium
-	Seals	NBR (nitrile rubber)
	Note on materials	RoHS-compliant

Solenoid valves MN1H, JMN1H, JMN1DH, to ISO 5599-1

Technical data – Width 52 mm

Dimensions

Download CAD data → www.festo.com

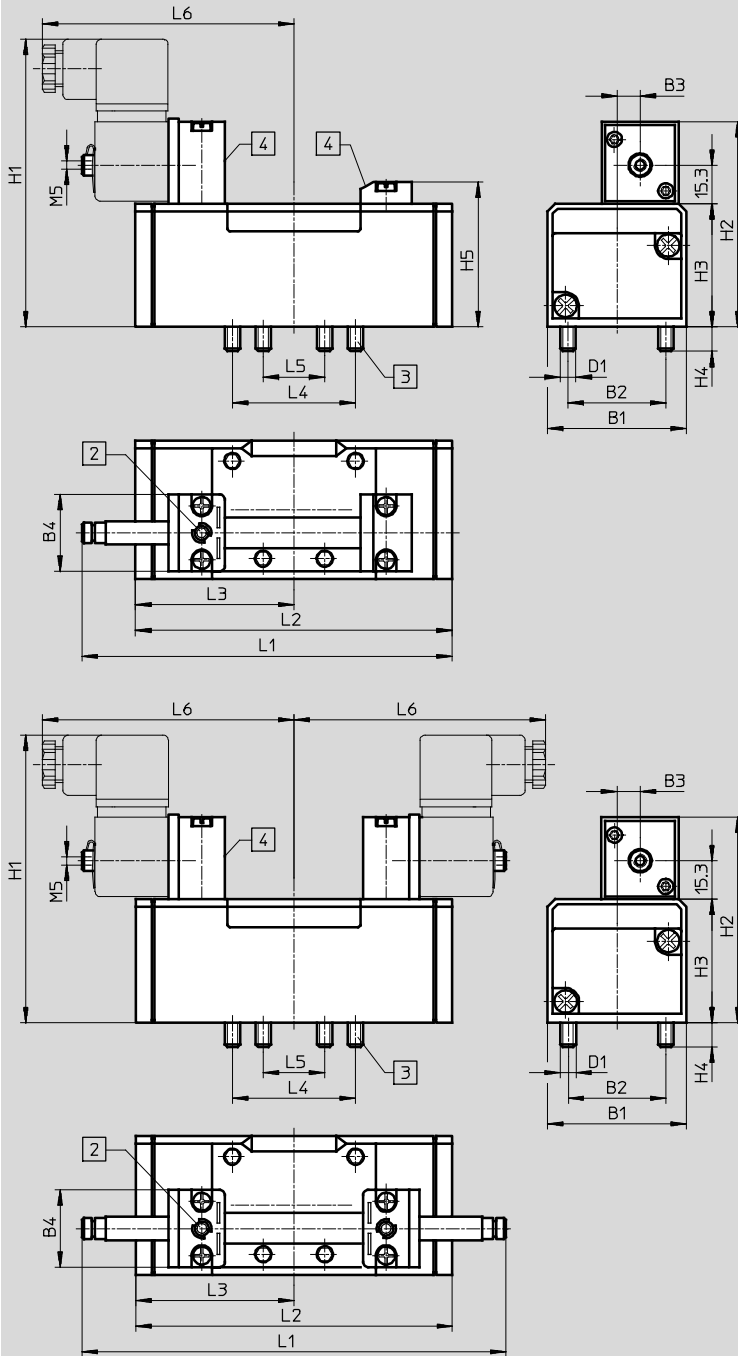

- 2 Manual override
- 3 Captive mounting screws
- 4 Slot for inscription label

Type	B1	B2	B3	B4	D1	H1	H2	H3	H4	H5	L1	L2	L3	L4	L5	L6
MN1H-5/2	54	38	9	30	M6	116	84	48	9.5	56.5	147.6	123.4	61.7	48	24	98
JMN1H-5/2											165	123.4	61.7			
MN1H-5/2-...-FR											161.5	140.7	61.7			
MN1H-5/3											165	158	79			

Solenoid valves MN1H, JMN1H, JMN1DH, to ISO 5599-1

FESTO

Ordering data – Width 52 mm

Ordering data – Solenoid valves without solenoid coil ¹⁾ , internal pilot air supply			
Circuit symbol	Description	Part No.	Type
5/2-way valve, single solenoid			
	Pneumatic reset method	159700	MN1H-5/2-D-2-C
	Mechanical reset method	159699	MN1H-5/2-D-2-FR-C
5/2-way valve, double solenoid			
	–	159702	JMN1H-5/2-D-2-C
	With dominant signal at 14	159703	JMN1DH-5/2-D-2-C
5/3-way valve, single solenoid			
	Normally closed	159693	MN1H-5/3G-D-2-C
	Normally exhausted	159695	MN1H-5/3E-D-2-C
	Normally open	159697	MN1H-5/3B-D-2-C

1) N1 solenoid coils → 72



Ordering data – Solenoid valves without solenoid coil ¹⁾ , external pilot air supply			
Circuit symbol	Description	Part No.	Type
5/2-way valve, single solenoid			
	Pneumatic reset method	159698	MN1H-5/2-D-2-S-C
	Mechanical reset method	159718	MN1H-5/2-D-2-FR-S-C
5/2-way valve, double solenoid			
	–	159701	JMN1H-5/2-D-2-S-C
	With dominant signal at 14	159719	JMN1DH-5/2-D-2-S-C
5/3-way valve, double solenoid			
	Normally closed	159692	MN1H-5/3G-D-2-S-C
	Normally exhausted	159694	MN1H-5/3E-D-2-S-C
	Normally open	159696	MN1H-5/3B-D-2-S-C

1) N1 solenoid coils → 72

Solenoid valves MFH, JMFH, JMFDH, to ISO 5599-1

FESTO

Technical data – Width 42 mm

-  Flow rate
1,200 l/min
-  Voltage
12, 24, 42, 48 V DC
24, 42, 48, 110, 230,
240 V AC

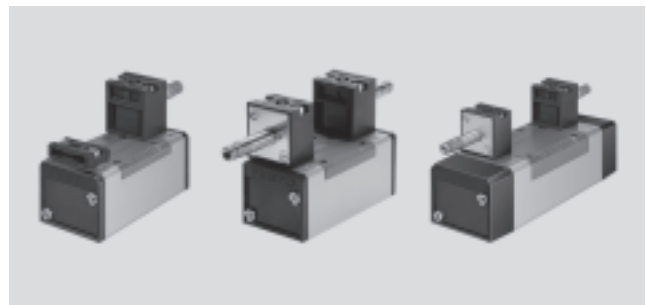

General technical data					
Valve function	5/2-way		5/3-way		
Normal position	–	–	G ¹⁾	B ²⁾	E ³⁾
Memory stability	Single solenoid	Double solenoid	Double solenoid		
Pneumatic spring reset method	Yes	–	No		
Mechanical spring reset method	Yes	–	Yes		
Design	Piston spool valve				
Sealing principle	Soft				
Actuation type	Electric				
Type of control	Piloted				
Pilot interface	To ISO 15218				
Pilot air supply	Internal or external				
Direction of flow	Reversible with external pilot air supply				
Exhaust function	Flow control				
Manual override	Non-detenting, detenting with tool				
Type of mounting	On sub-base				
Mounting position	Any				
Nominal size	[mm]	8			
Standard nominal flow rate	[l/min]	1,200			
Switching time on/off, pneumatic spring	[ms]	23/35	–	–	
Switching time on/off, mechanical spring	[ms]	16/45	–	18/35	18/36
Changeover time	[ms]	–	16	–	
Changeover time (dominant)	[ms]	–	13	–	
Width	[mm]	42			
Grid dimension	[mm]	43			
Connection on the sub-base	1, 2, 3, 4, 5	G $\frac{1}{4}$			
	12, 14	M5			
Noise level	[dB (A)]	85			
Conforms to	ISO 5599-1 and ISO 15218 for pilot valve interface				
Certification	Germanischer Lloyd				
Product weight	[g]	550	600	630	

- 1) G = Normally closed
- 2) B = Normally open
- 3) E = Normally exhausted

Solenoid valves MFH, JMFH, JMFDH, to ISO 5599-1

FESTO

Technical data – Width 42 mm

Operating and environmental conditions			
Reset method		Pneumatic	Mechanical
Operating medium		Compressed air in accordance with ISO 8573-1:2010 [7:4:4]	
Pilot medium		Compressed air in accordance with ISO 8573-1:2010 [7:4:4]	
Note on operating/pilot medium		Operation with lubricated medium possible (in which case lubricated operation will always be required)	
Operating pressure	Internal pilot air supply [bar]	2 ... 10	3 ... 10
	External pilot air supply [bar]	-0.9 ... +16	-0.9 ... +16
Pilot pressure [bar]		2 ... 10	3 ... 10
Ambient temperature [°C]		-5 ... +40	
Temperature of medium [°C]		-10 ... +60	

Electrical data – F solenoid coil			
Electrical connection		Plug vanes for plug sockets MSSD-F, KMF	
Operating voltage	DC voltage [V DC]	12, 24, 42, 48	
	AC voltage [V AC]	24, 42, 48, 110, 230, 240 (50 ... 60 Hz)	
Coil characteristics	DC voltage [W]	4.5	
	AC voltage [VA]	Pull: 7.5 Hold: 6	
Protection class to EN 60529		IP65	

Materials

Sectional view

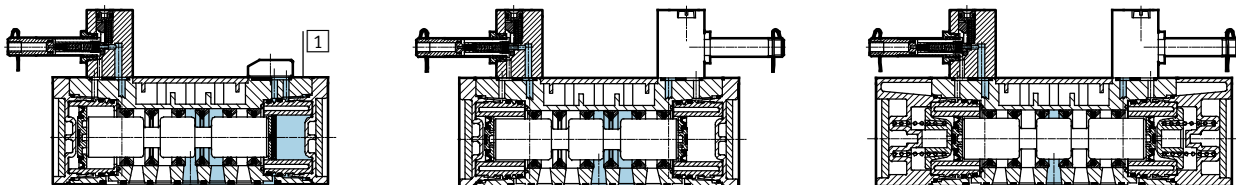

1	Housing	Die-cast aluminium
-	Seals	NBR (nitrile rubber)
Note on materials		RoHS-compliant

Solenoid valves MFH, JMFH, JMFDH, to ISO 5599-1

Technical data – Width 42 mm

Dimensions

Download CAD data → www.festo.com

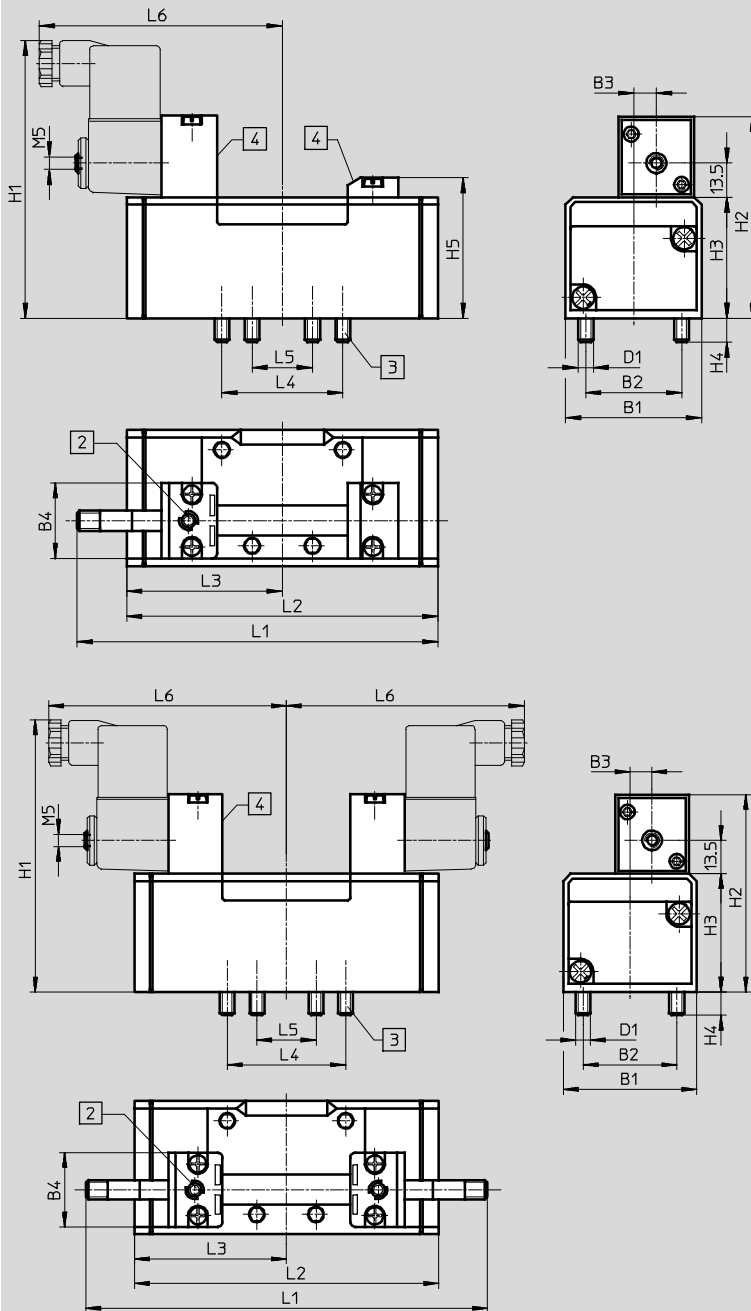

- 2 Manual override
- 3 Captive mounting screws
- 4 Slot for inscription label

Type	B1	B2	B3	B4	D1	H1	H2	H3	H4	H5	L1	L2	L3	L4	L5	L6
MFH-5/2-...	42	28	6	30	M5	100	70.3	38	9	46.5	115	87.6	43.8	36	18	89
JMFH-5/2-...										-	142.6	87.6	43.8			
MFH-5/2-...-FR										46.5	125.6	98	43.8			
MFH-5/3-...										-	142.6	108.4	54.2			

Solenoid valves MFH, JMFH, JMFDH, to ISO 5599-1

Ordering data – Width 42 mm

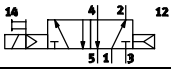
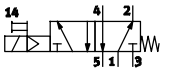
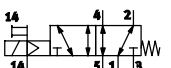
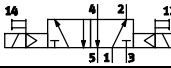
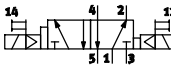
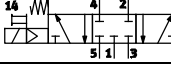
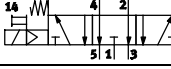
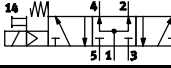
Ordering data – Solenoid valves without solenoid coil ¹⁾ , internal pilot air supply			
Circuit symbol	Description	Part No.	Type
5/2-way valve, single solenoid			
	Pneumatic reset method	150981	MFH-5/2-D-1-C
	Mechanical reset method	151016	MFH-5/2-D-1-FR-C
	Mechanical reset method, reversible	188510	MFH-5/2-D-1-FR-S-C
5/2-way valve, double solenoid			
	–	150980	JMFH-5/2-D-1-C
	With dominant signal at 14	151019	JMFDH-5/2-D-1-C
5/3-way valve, single solenoid			
	Normally closed	150982	MFH-5/3G-D-1-C
	Normally exhausted	150983	MFH-5/3E-D-1-C
	Normally open	150984	MFH-5/3B-D-1-C

1) F solenoid coils → 72

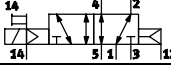
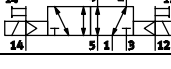
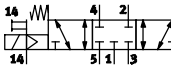
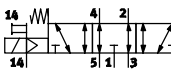
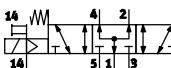
Ordering data – Solenoid valves without solenoid coil ¹⁾ , external pilot air supply			
Circuit symbol	Description	Part No.	Type
5/2-way valve, single solenoid			
	Pneumatic reset method	152562	MFH-5/2-D-1-S-C
5/2-way valve, double solenoid			
	–	152563	JMFH-5/2-D-1-S-C
5/3-way valve, double solenoid			
	Normally closed	152564	MFH-5/3G-D-1-S-C
	Normally exhausted	152565	MFH-5/3E-D-1-S-C
	Normally open	152566	MFH-5/3B-D-1-S-C

1) F solenoid coils → 72

Solenoid valves MFH, JMFH, JMFDH, to ISO 5599-1

FESTO

Technical data – Width 52 mm

-  Flow rate
2,300 l/min

-  Voltage
12, 24, 42, 48 V DC
24, 42, 48, 110, 230,
240 V AC

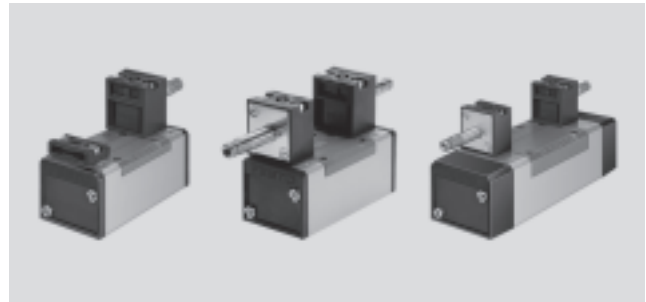

General technical data						
Valve function	5/2-way			5/3-way		
Normal position	–	–	–	G ¹⁾	B ²⁾	E ³⁾
Memory stability	Single solenoid	Double solenoid	–	Double solenoid		
Pneumatic spring reset method	Yes	–	–	No		
Mechanical spring reset method	Yes	–	–	Yes		
Design	Piston spool valve					
Sealing principle	Soft					
Actuation type	Electric					
Type of control	Piloted					
Pilot interface	To ISO 15218					
Pilot air supply	Internal or external					
Direction of flow	Reversible with external pilot air supply					
Exhaust function	Flow control					
Manual override	Non-detenting, detenting with tool					
Type of mounting	On sub-base					
Mounting position	Any					
Nominal size	[mm]	11				
Standard nominal flow rate	[l/min]	2,300				
Switching time on/off, pneumatic spring	[ms]	48/71	–	–		
Switching time on/off, mechanical spring	[ms]	27/73	–	33/63	35/69	35/67
Changeover time	[ms]	–	18	–		
Width	[mm]	52				
Grid dimension	[mm]	56				
Connection on the sub-base	1, 2, 3, 4, 5	G $\frac{3}{8}$				
	12, 14	M5				
Noise level	[dB (A)]	85				
Conforms to	ISO 5599-1 and ISO 15218 for pilot valve interface					
Certification	Germanischer Lloyd					
Product weight	[g]	650	750	820		

- 1) G = Normally closed
- 2) B = Normally open
- 3) E = Normally exhausted

Solenoid valves MFH, JMFH, JMFDH, to ISO 5599-1

FESTO

Technical data – Width 52 mm

Operating and environmental conditions			
Reset method		Pneumatic	Mechanical
Operating medium		Compressed air in accordance with ISO 8573-1:2010 [7:4:4]	
Pilot medium		Compressed air in accordance with ISO 8573-1:2010 [7:4:4]	
Note on operating/pilot medium		Operation with lubricated medium possible (in which case lubricated operation will always be required)	
Operating pressure	Internal pilot air supply [bar]	2 ... 10	3 ... 10
	External pilot air supply [bar]	-0.9 ... +16	-0.9 ... +16
Pilot pressure [bar]		2 ... 10	3 ... 10
Ambient temperature [°C]		-5 ... +40	
Temperature of medium [°C]		-10 ... +60	

Electrical data – F solenoid coil			
Electrical connection		Plug vanes for plug sockets MSSD-F, KMF	
Operating voltage	DC voltage [V DC]	12, 24, 42, 48	
	AC voltage [V AC]	24, 42, 48, 110, 230, 240 (50 ... 60 Hz)	
Coil characteristics	DC voltage [W]	4.5	
	AC voltage [VA]	Pull: 7.5 Hold: 6	
Protection class to EN 60529		IP65	

Materials

Sectional view

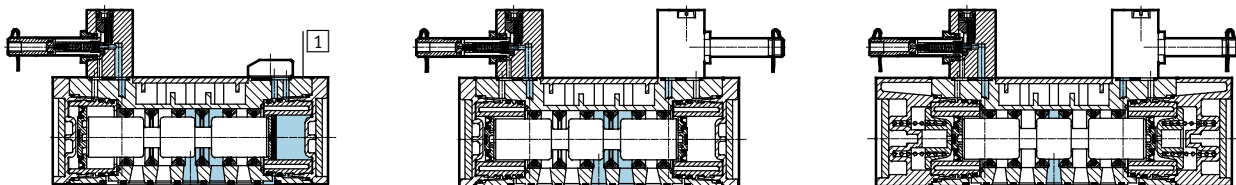

1	Housing	Die-cast aluminium
-	Seals	NBR (nitrile rubber)
Note on materials		RoHS-compliant

Solenoid valves MFH, JMFH, JMFDH, to ISO 5599-1

Technical data – Width 52 mm

Dimensions

Download CAD data → www.festo.com

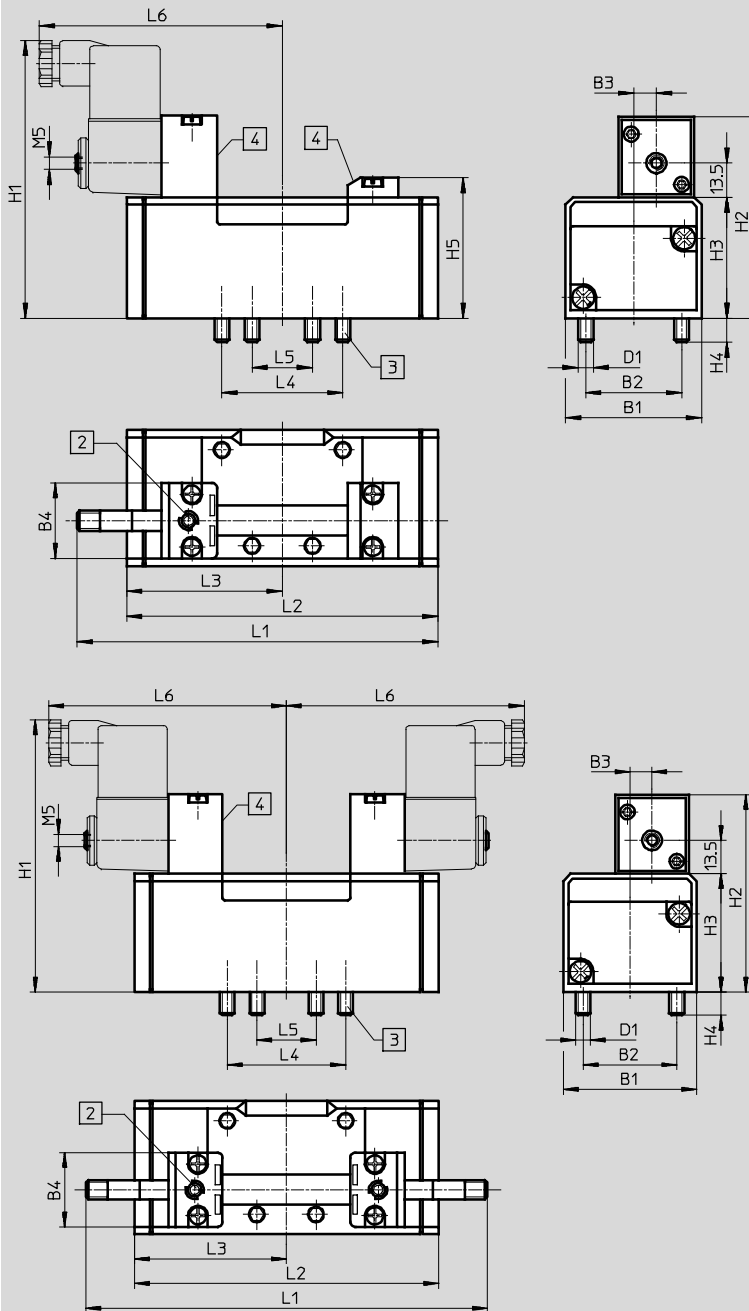

- 2 Manual override
- 3 Captive mounting screws
- 4 Slot for inscription label

Type	B1	B2	B3	B4	D1	H1	H2	H3	H4	H5	L1	L2	L3	L4	L5	L6
MFH-5/2	54	38	9	30	M6	110	80.3	48	9.5	56.5	142	123.4	61.7	48	24	98
MFH-5/2-...-FR										56.5	159.4	140.7	61.7			98
JMFH-5/2										-	160.4	123.4	61.7			97
MFH-5/3										-	160	158	79			98

Solenoid valves MFH, JMFH, JMFDH, to ISO 5599-1

Ordering data – Width 52 mm

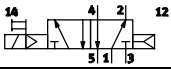
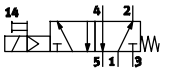
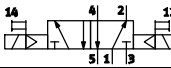
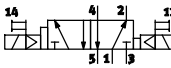
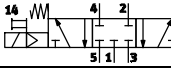
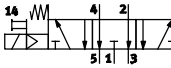
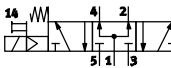
Ordering data – Solenoid valves without solenoid coil ¹⁾ , internal pilot air supply			
Circuit symbol	Description	Part No.	Type
5/2-way valve, single solenoid			
	Pneumatic reset method	151851	MFH-5/2-D-2-C
	Mechanical reset method	151709	MFH-5/2-D-2-FR-C
5/2-way valve, double solenoid			
	–	151852	JMFH-5/2-D-2-C
	With dominant signal at 14	151853	JMFDH-5/2-D-2-C
5/3-way valve, single solenoid			
	Normally closed	151854	MFH-5/3G-D-2-C
	Normally exhausted	151855	MFH-5/3E-D-2-C
	Normally open	151856	MFH-5/3B-D-2-C

1) F solenoid coils → 72

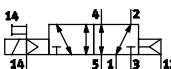
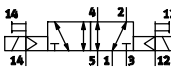
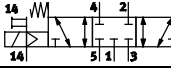
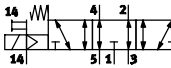
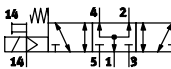
Ordering data – Solenoid valves without solenoid coil ¹⁾ , external pilot air supply			
Circuit symbol	Description	Part No.	Type
5/2-way valve, single solenoid			
	Pneumatic reset method	151022	MFH-5/2-D-2-S-C
5/2-way valve, double solenoid			
	–	151023	JMFH-5/2-D-2-S-C
5/3-way valve, double solenoid			
	Normally closed	151024	MFH-5/3G-D-2-S-C
	Normally exhausted	151025	MFH-5/3E-D-2-S-C
	Normally open	151026	MFH-5/3B-D-2-S-C

1) F solenoid coils → 72

Solenoid valves VSVA, to ISO 5599-1/central plug M12x1

FESTO

Technical data – Width 42 mm

-  - Flow rate
1,100 ... 1,300 l/min

-  - Voltage
24 V DC

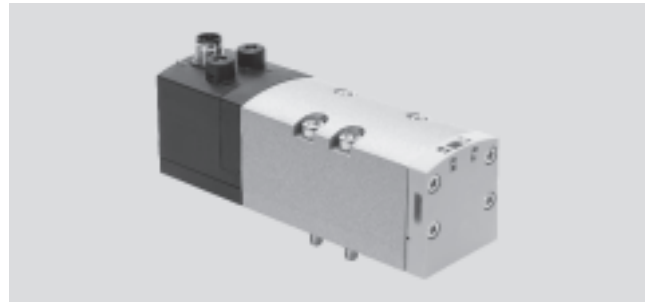

General technical data											
Valve function	2x 2/2-way			2x 3/2-way			5/2-way		5/3-way		
Normal position	C ¹⁾			C ¹⁾ U ²⁾ H ⁴⁾ C ¹⁾ U ²⁾ H ⁴⁾			-		C ¹⁾ U ²⁾ E ³⁾		
Memory stability	Single solenoid			Single solenoid			Double solenoid		Double solenoid		
Pneumatic spring reset method	Yes			Yes			Yes		-		
Mechanical spring reset method	No			No			Yes		-		
Design	Piston spool valve										
Sealing principle	Soft										
Actuation type	Electric										
Type of control	Piloted										
Pilot air supply	Internal or external			External			Internal or external				
Direction of flow	Reversible with external pilot air supply			Non-reversible			Reversible only		Reversible with external pilot air supply		
Exhaust function	Flow control, external or via vertically stacked flow control plate										
Manual override	Non-detenting, detenting										
Type of mounting	On sub-base										
Mounting position	Any										
Nominal size [mm]	11										
Flow rate of valve [l/min]	1,600			1,600			2,000		1,900		
Flow rate of valve on individual sub-base [l/min]	1,400			1,200			1,400		1,400		
Flow rate of pneumatically interlinked valve [l/min]	1,300			1,100			1,300		1,400		
Standard nominal flow rate [l/min]	1,300			1,100			1,300		1,300		
Switching time on/off, pneumatic spring [ms]	20/38			20/38			34/28		27/45		
Switching time on/off, mechanical spring [ms]	-			-			-		22/60		
Changeover time, dominant at 1st signal [ms]	-			-			-		16		
Changeover time, dominant at 14 [ms]	-			-			-		19		
Non-overlapping	Yes										
Width [mm]	42										
Grid dimension [mm]	43										
Connection on the sub-base	1, 2, 3, 4, 5 12, 14			G1/4, end plates G3/8 M5							
Pilot exhaust air	82/84										
Pilot exhaust air	Either ducted (12) or unducted (standard)										
Product weight [g]	442						426		439		
Product weight							426		439		
Product weight									456		
Conforms to	ISO 5599-1										

- 1) C = Normally closed
- 2) U = Normally open
- 3) E = Normally exhausted
- 4) H = 2x 3/2-way valve in one housing with 1x normally closed and 1x normally open

Solenoid valves VSVA, to ISO 5599-1/central plug M12x1

FESTO

Technical data – Width 42 mm

Operating and environmental conditions		2x 2/2-way	2x 3/2-way	2x 3/2-way reversible	5/2-way	5/3-way
Valve function						
Operating medium		Compressed air in accordance with ISO 8573-1:2010 [7:4:4]				
Pilot medium		Compressed air in accordance with ISO 8573-1:2010 [7:4:4]				
Note on operating/pilot medium		Operation with lubricated medium possible (in which case lubricated operation will always be required)				
Operating pressure	Internal pilot air supply [bar]	3 ... 10				
	External pilot air supply [bar]	3 ... 10	3 ... 10	-0.9 ... 10	-0.9 ... 10	
Pilot pressure ¹⁾ [bar]		3 ... 10				
Ambient temperature [°C]		-5 ... +50				
Materials	Seals	FPM, NBR				
	Housing	Die-cast aluminium, PA				
	Screws	Galvanised steel				
	Note	RoHS-compliant				

1) Minimum pilot pressure 50% of operating pressure

Electrical data		2x 2/2-way	2x 3/2-way	5/2-way	5/3-way	
Valve function						
Electrical connection to IEC 60 947-5-2		Central plug, round design M12x1, 3-pin				
Coil characteristics	Voltage [V DC]	24±10% = 21.6 ... 26.4				
	Power [W]	1.3	1.3	1.6	1.6	
Duty cycle %		100				
Protection class to EN 60529		IP65 to EN 60529 and NEMA4 (in combination with a plug socket)				
Protective circuit and LED		Integrated in the valve				

Dimensions Download CAD data → www.festo.com

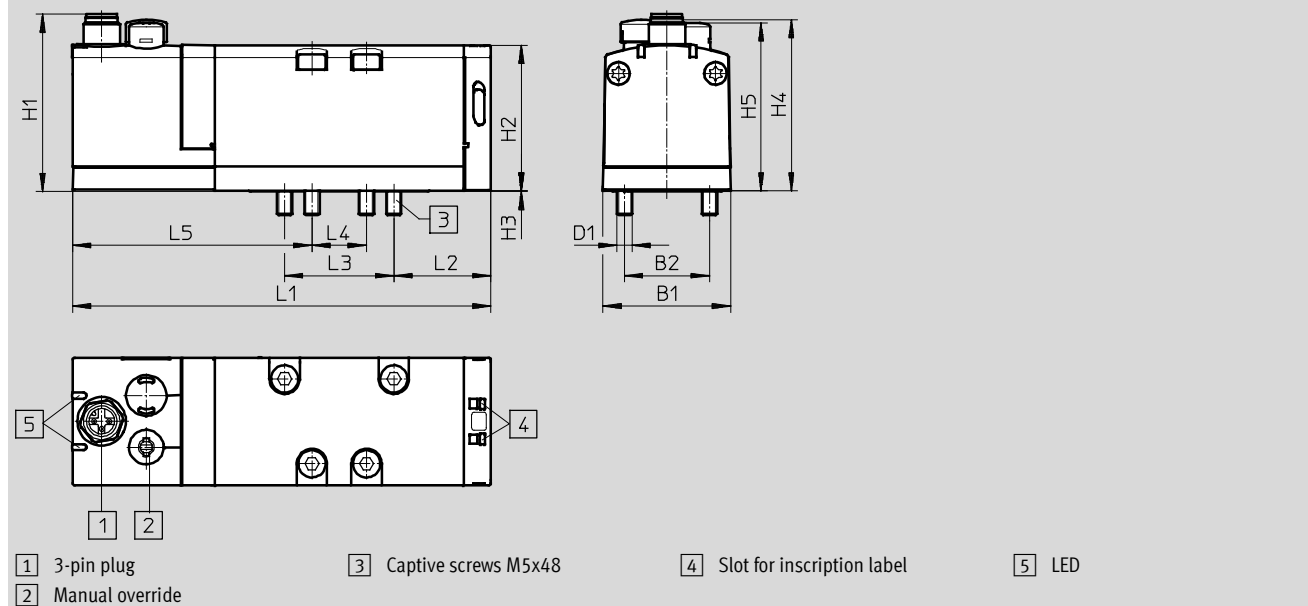

Type	B1	B2	D1	H1	H2	H3	H4	H5	L1	L2	L3	L4	L5
VSVA-B -...-D1-1R5L	42	28	M5	58.3	48	0.25	46.6	55.3	137.8	32	36	18	69.3

Solenoid valves VSVA, to ISO 5599-1/central plug M12x1

Technical data – Width 42 mm

Protective circuit

Each VSVA solenoid coil is protected with a spark arresting protective circuit as well as against polarity reversal.

24 V DC version (width 42 mm)

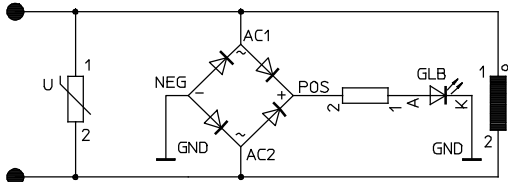

M12x1 – Pin allocation on the valve

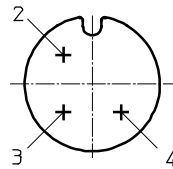

- 2 Signal (+) solenoid 12
- 3 com (-)
- 4 Signal (+) solenoid 14

Solenoid valves VSVA, to ISO 5599-1/central plug M12x1



Ordering data – Width 42 mm

Ordering data		Pilot air supply		Part No.	Type
2x 2/2-way valve					
	Normally 2x closed	Internal	24 V DC	Order via online configurator ➔ Internet: vsva	
	Normally 2x closed	External	24 V DC		
	Normally 2x closed Vacuum operation possible at 3 and 5	Internal	24 V DC		
2x 3/2-way valve					
	Normally 2x closed	Internal	24 V DC	561359	VSVA-B-T32C-AD-D1-1R5L
	Normally 2x open	Internal	24 V DC	561360	VSVA-B-T32U-AD-D1-1R5L
	Normally 1x closed, 1x open	Internal	24 V DC	561361	VSVA-B-T32H-AD-D1-1R5L
	Normally 2x closed	External	24 V DC	561369	VSVA-B-T32C-AZD-D1-1R5L
	Normally 2x open	External	24 V DC	561370	VSVA-B-T32U-AZD-D1-1R5L
	Normally 1x closed, 1x open	External	24 V DC	561371	VSVA-B-T32H-AZD-D1-1R5L
2x 3/2-way valve, reversible					
	Normally 2x closed	External	24 V DC	Order via online configurator ➔ Internet: vsva	
	Normally 2x open	External	24 V DC		
	Normally 1x closed, 1x open	External	24 V DC		

Solenoid valves VSVA, to ISO 5599-1/central plug M12x1

Ordering data – Width 42 mm

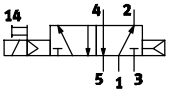
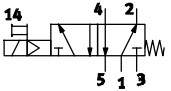
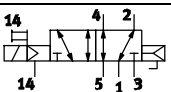
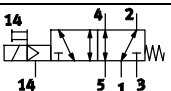
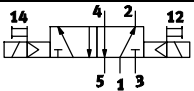
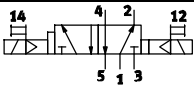
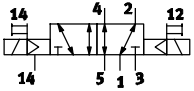
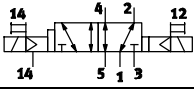
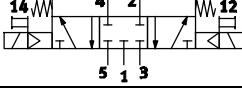
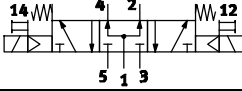
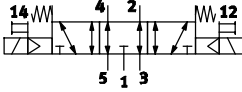
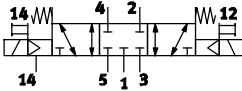
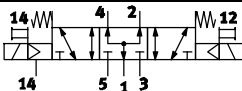
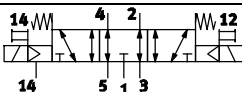
Ordering data		Pilot air supply		Part No.	Type
5/2-way valve, single solenoid					
	Pneumatic reset method	Internal	24 V DC	561362	VSVA-B-M52-AD-D1-1R5L
	Mechanical spring reset method	Internal	24 V DC	561363	VSVA-B-M52-MD-D1-1R5L
	Pneumatic reset method	External	24 V DC	561372	VSVA-B-M52-AZD-D1-1R5L
	Mechanical spring reset method	External	24 V DC	561373	VSVA-B-M52-MZD-D1-1R5L
5/2-way valve, double solenoid					
	Dominant: 1st signal	Internal	24 V DC	561364	VSVA-B-B52-D-D1-1R5L
	Dominant: at 14	Internal	24 V DC	561365	VSVA-B-D52-D-D1-1R5L
	Dominant: 1st signal	External	24 V DC	561374	VSVA-B-B52-ZD-D1-1R5L
	Dominant: at 14	External	24 V DC	561375	VSVA-B-D52-ZD-D1-1R5L
5/3-way valve					
	Normally closed	Internal	24 V DC	561366	VSVA-B-P53C-D-D1-1R5L
	Normally open	Internal	24 V DC	561368	VSVA-B-P53U-D-D1-1R5L
	Normally exhausted	Internal	24 V DC	561367	VSVA-B-P53E-D-D1-1R5L
	Normally closed	External	24 V DC	561376	VSVA-B-P53C-ZD-D1-1R5L
	Normally open	External	24 V DC	561378	VSVA-B-P53U-ZD-D1-1R5L
	Normally exhausted	External	24 V DC	561377	VSVA-B-P53E-ZD-D1-1R5L

Solenoid valves VSVA, to ISO 5599-1/central plug M12x1

FESTO

Technical data – Width 52 mm

-  Flow rate
2,200 ... 2,800 l/min

-  Voltage
24 V DC

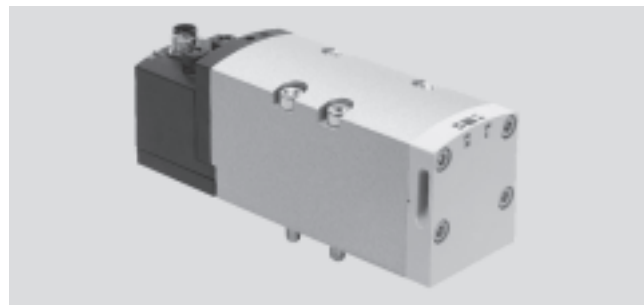

General technical data												
Valve function	2x 2/2-way			2x 3/2-way			5/2-way		5/3-way			
Normal position	C ¹⁾	C ¹⁾	U ²⁾	H ⁴⁾	C ¹⁾	U ²⁾	H ⁴⁾	–	–	C ¹⁾	U ²⁾	E ³⁾
Memory stability	Single solenoid	Single solenoid	Single solenoid	Single solenoid	Single solenoid	Single solenoid	Single solenoid	Double solenoid	Double solenoid	Double solenoid		
Pneumatic spring reset method	Yes	Yes	Yes	Yes	Yes	Yes	Yes	–	–	–		
Mechanical spring reset method	No	No	No	No	No	No	Yes	–	–	–		
Design	Piston spool valve											
Sealing principle	Soft											
Actuation type	Electric											
Type of control	Piloted											
Pilot air supply	Internal or external											
Direction of flow	Non-reversible	Non-reversible	Reversible only	Reversible only	Reversible	Reversible	Reversible	Reversible	Reversible	Reversible	Reversible	Reversible
Exhaust function	Via individual sub-base, with flow control, external or via vertically stacked flow control plate											
Manual override	Non-detenting, detenting											
Type of mounting	On sub-base											
Mounting position	Any											
Nominal size [mm]	15											
Flow rate of valve [l/min]	4,000	3,000	3,000	3,000	4,000	4,000	4,000	4,000	3,600	3,600		
Flow rate of valve on individual sub-base [l/min]	2,400	2,000	2,000	2,000	2,400	2,400	2,400	2,400	2,300	2,300		
Flow rate of pneumatically interlinked valve [l/min]	2,800	2,200	2,200	2,200	2,800	2,800	2,800	2,800	2,700	2,700		
Standard nominal flow rate [l/min]	2,800	2,200	2,200	2,200	2,800	2,800	2,800	2,800	2,700	2,700		
Switching time on/off, pneumatic spring [ms]	14/35	20/35	20/35	30/30	40/45	40/45	40/45	–	–	–		
Switching time on/off, mechanical spring [ms]	–	–	–	–	20/60	20/60	20/60	–	23/60	23/60		
Changeover time, dominant at 1st signal [ms]	–	–	–	–	–	–	–	18	–	–		
Changeover time, dominant at 14 [ms]	–	–	–	–	–	–	–	18	–	–		
Non-overlapping	Yes											
Width [mm]	52											
Grid dimension [mm]	59											
Connection on the sub-base	1, 2, 3, 4, 5			G ³ / ₈ , end plates G ¹ / ₂								
	12, 14			G ¹ / ₈								
Pilot exhaust air	82/84			Either ducted or unducted (standard)								
Product weight [g]	740	740	740	740	702	702	702	732	780	780		
Conforms to	ISO 5599-1											

- 1) C = Normally closed
- 2) U = Normally open
- 3) E = Normally exhausted
- 4) H = 2x 3/2-way valve in one housing with 1x normally closed and 1x normally open

Solenoid valves VSVA, to ISO 5599-1/central plug M12x1

Technical data – Width 52 mm

Operating and environmental conditions							
Valve function			2x 2/2-way	2x 3/2-way	2x 3/2-way reversible	5/2-way	5/3-way
Operating medium	Compressed air in accordance with ISO 8573-1:2010 [7:4:4]						
Pilot medium	Compressed air in accordance with ISO 8573-1:2010 [7:4:4]						
Note on operating/pilot medium	Operation with lubricated medium possible (in which case lubricated operation will always be required)						
Operating pressure	Internal pilot air supply	[bar]	3 ... 10				
	External pilot air supply	[bar]	3 ... 10	3 ... 10	-0.9 ... 10	-0.9 ... 10	
Pilot pressure ¹⁾		[bar]	3 ... 10				
Ambient temperature		[°C]	-5 ... +50				
Materials	Seals		FPM, HNBR, NBR				
	Housing		Die-cast aluminium, PA				
	Screws		Galvanised steel				
	Note		RoHS-compliant				

1) Minimum pilot pressure 50% of operating pressure

Electrical data			
Electrical connection to IEC 60947-5-2	Central plug, round design M12x1, 3-pin		
Coil characteristics	Voltage	[V DC]	24±10% = 21.6 ... 26.4
	Power	[W]	4.6
Nominal pull current per solenoid coil	[mA]	165	
Nominal current with current reduction	[mA]	35	
Time until current reduction	[ms]	30	
Duty cycle	%	100	
Protection class to EN 60529	IP65 to EN 60529 and NEMA4 (in combination with a plug socket)		
Protective circuit and LED	Integrated in the valve		
Certification	C-Tick		
CE mark (see declaration of conformity)	To EU EMC Directive ¹⁾		

1) For information about the applicability of the component see the manufacturer's EC declaration of conformity at: www.festo.com → Support → User documentation.
If the component is subject to restrictions on usage in residential, office or commercial environments or small businesses, further measures to reduce the emitted interference may be necessary.

Dimensions Download CAD data → www.festo.com

1 3-pin plug
 2 Manual override
 3 Captive screws M6x60
 4 Slot for inscription label
 5 LED

Type	B1	B2	D1	H1	H2	H3	H4	H5	L1	L2	L3	L4	L5
VSVA-B-...-D2-1R5L	52	38	M6	58.3	60	0.3	56.4	55.3	160.7	40.9	48	24	64.3

Solenoid valves VSVA, to ISO 5599-1/central plug M12x1

Technical data – Width 52 mm

FESTO

Protective circuit

Each VSVA solenoid coil is protected with a spark arresting protective circuit as well as against polarity reversal.

24 V DC version (width 52 mm)

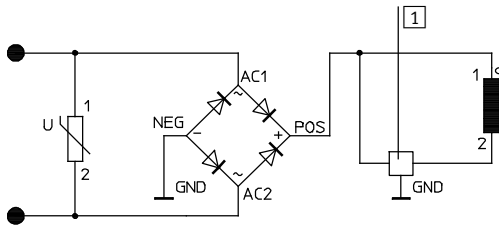

1 Holding current reduction

M12x1 – Pin allocation on valve

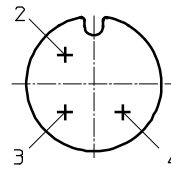

- 2 Signal (+) solenoid 12
- 3 com (-)
- 4 Signal (+) solenoid 14

Solenoid valves VSVA, to ISO 5599-1/central plug M12x1

Ordering data – Width 52 mm

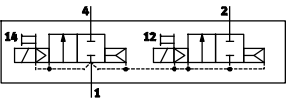
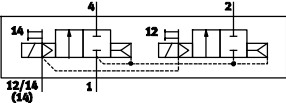
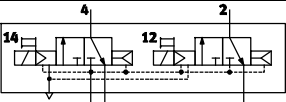
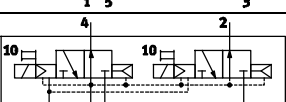
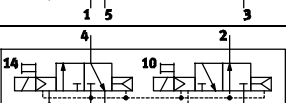
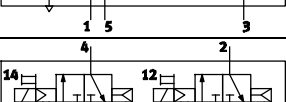
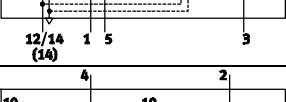
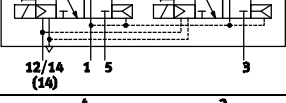
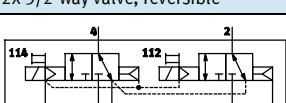
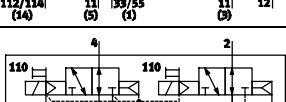
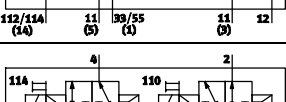
Ordering data		Pilot air supply		Part No.	Type
2x 2/2-way valve					
	Normally 2x closed	Internal	24 V DC	Order via online configurator ➔ Internet: vsva	
	Normally 2x closed	External	24 V DC		
2x 3/2-way valve					
	Normally 2x closed	Internal	24 V DC	566990	VSVA-B-T32C-AD-D2-1R5L
	Normally 2x open	Internal	24 V DC	566991	VSVA-B-T32U-AD-D2-1R5L
	Normally 1x closed, 1x open	Internal	24 V DC	566992	VSVA-B-T32H-AD-D2-1R5L
	Normally 2x closed	External	24 V DC	567000	VSVA-B-T32C-AZD-D2-1R5L
	Normally 2x open	External	24 V DC	567001	VSVA-B-T32U-AZD-D2-1R5L
	Normally 1x closed, 1x open	External	24 V DC	567002	VSVA-B-T32H-AZD-D2-1R5L
2x 3/2-way valve, reversible					
	Normally 2x closed	External	24 V DC	Order via online configurator ➔ Internet: vsva	
	Normally 2x open	External	24 V DC		
	Normally 1x closed, 1x open	External	24 V DC		

Solenoid valves VSVA, to ISO 5599-1/central plug M12x1



Ordering data – Width 52 mm

Ordering data		Pilot air supply		Part No.	Type
5/2-way valve, single solenoid					
	Pneumatic reset method	Internal	24 V DC	566993	VSVA-B-M52-AD-D2-1R5L
	Mechanical spring reset method	Internal	24 V DC	566994	VSVA-B-M52-MD-D2-1R5L
	Pneumatic reset method	External	24 V DC	567003	VSVA-B-M52-AZD-D2-1R5L
	Mechanical spring reset method	External	24 V DC	567004	VSVA-B-M52-MZD-D2-1R5L
5/2-way valve, double solenoid					
	Dominant: 1st signal	Internal	24 V DC	566995	VSVA-B-B52-D-D2-1R5L
	Dominant: at 14	Internal	24 V DC	566996	VSVA-B-D52-D-D2-1R5L
	Dominant: 1st signal	External	24 V DC	567005	VSVA-B-B52-ZD-D2-1R5L
	Dominant: at 14	External	24 V DC	567006	VSVA-B-D52-ZD-D2-1R5L
5/3-way valve					
	Normally closed	Internal	24 V DC	566997	VSVA-B-P53C-D-D2-1R5L
	Normally open	Internal	24 V DC	566999	VSVA-B-P53U-D-D2-1R5L
	Normally exhausted	Internal	24 V DC	566998	VSVA-B-P53E-D-D2-1R5L
	Normally closed	External	24 V DC	567007	VSVA-B-P53C-ZD-D2-1R5L
	Normally open	External	24 V DC	567009	VSVA-B-P53U-ZD-D2-1R5L
	Normally exhausted	External	24 V DC	567008	VSVA-B-P53E-ZD-D2-1R5L

Solenoid valves MDH, JMDH, JMDDH, to ISO 5599-1

FESTO

Technical data – Width 42 mm

 Flow rate
1,200 l/min

 Voltage
24 V DC

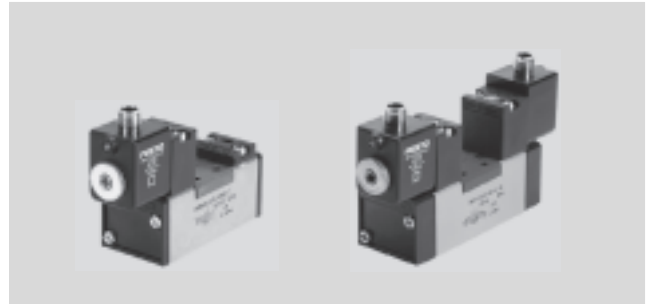

General technical data					
Valve function	5/2-way		5/3-way		
Normal position	–	–	G ¹⁾	B ²⁾	E ³⁾
Memory stability	Single solenoid	Double solenoid	Double solenoid		
Pneumatic spring reset method	Yes	–	No		
Mechanical spring reset method	Yes	–	Yes		
Design	Piston spool valve				
Sealing principle	Soft				
Actuation type	Electric				
Type of control	Piloted				
Pilot interface	To ISO 15218				
Pilot air supply	Internal or external				
Direction of flow	Reversible with external pilot air supply				
Exhaust function	Flow control				
Manual override	Non-detenting				
Type of mounting	On sub-base				
Mounting position	Any				
Nominal size	[mm]	8			
Standard nominal flow rate	[l/min]	1,200			
Switching time on/off, pneumatic spring	[ms]	25/36	–	–	
Switching time on/off, mechanical spring	[ms]	20/42	–	25/55	
Changeover time	[ms]	–	18	–	
Switching time with dominant signal at 14 (12/14)	[ms]	–	18	–	
Width	[mm]	42			
Grid dimension	[mm]	43			
Connection on the sub-base	1, 2, 3, 4, 5 12, 14	G ¹ / ₄ , end plates G ³ / ₈ M5			
Conforms to	ISO 5599-1 and ISO 15218 for pilot valve interface				
Product weight	[g]	420	550	580	

- 1) G = Normally closed
 2) B = Normally open
 3) E = Normally exhausted

Operating and environmental conditions					
Reset method		Pneumatic spring		Mechanical spring	
Operating medium		Compressed air in accordance with ISO 8573-1:2010 [7:4:4]			
Pilot medium		Compressed air in accordance with ISO 8573-1:2010 [7:4:4]			
Note on operating/pilot medium		Operation with lubricated medium possible (in which case lubricated operation will always be required)			
Operating pressure	Internal pilot air supply	[bar]	2 ... 10		3 ... 10
	External pilot air supply	[bar]	–0.9 ... +16		
Pilot pressure	[bar]	2 ... 10		3 ... 10	
Ambient temperature	[°C]	–10 ... +50			
Temperature of medium	[°C]	–10 ... +50			

Solenoid valves MDH, JMDH, JMDDH, to ISO 5599-1

FESTO

Technical data – Width 42 mm

Electrical data			
D solenoid coil with round plug M12x1			
Electrical connection	Design	M12X1	
Coil characteristics	DC voltage	[V DC]	21.6 ... 26.4
	Power	[W]	2.7
Duty cycle		[%]	100
Protection class to EN 60529			IP65

Materials

Sectional view

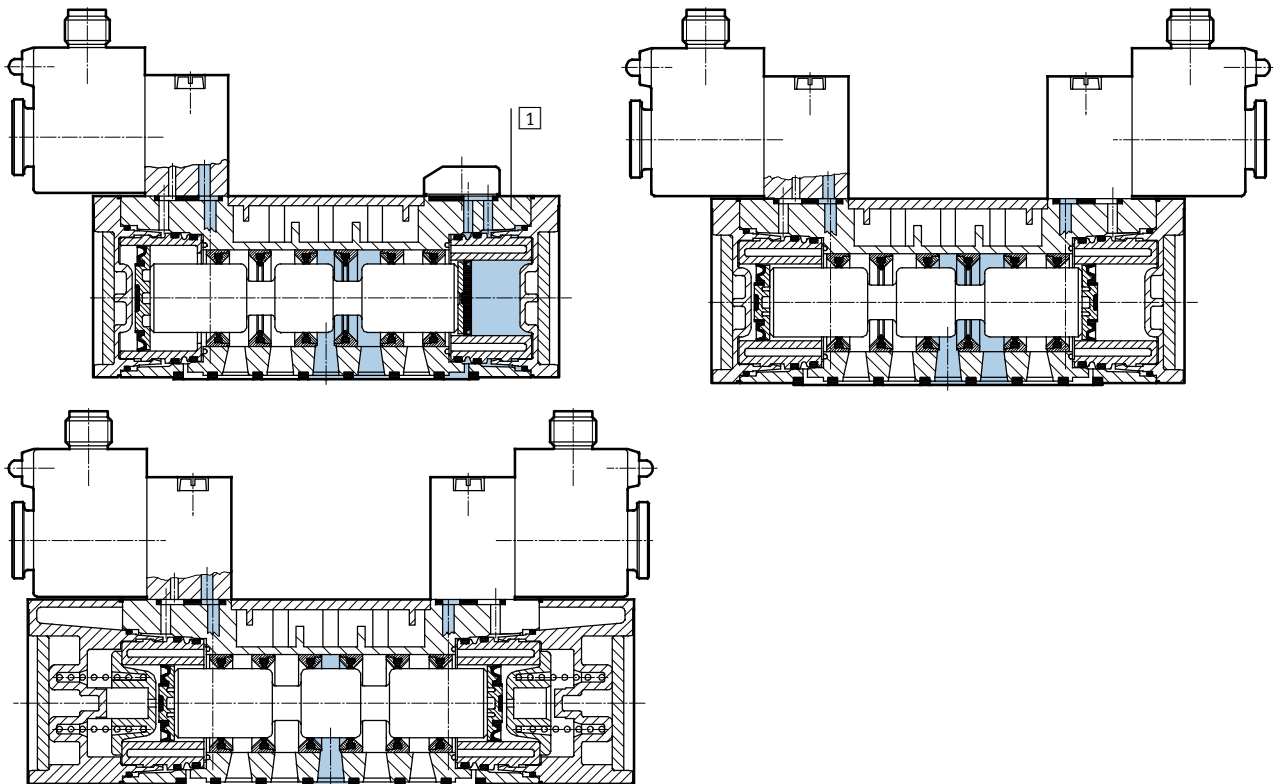

1	Housing	Die-cast aluminium, polyacetal
-	Seals	Nitrile rubber

Solenoid valves MDH, JMDH, JMDDH, to ISO 5599-1

Technical data – Width 42 mm

Dimensions

Download CAD data → www.festo.com

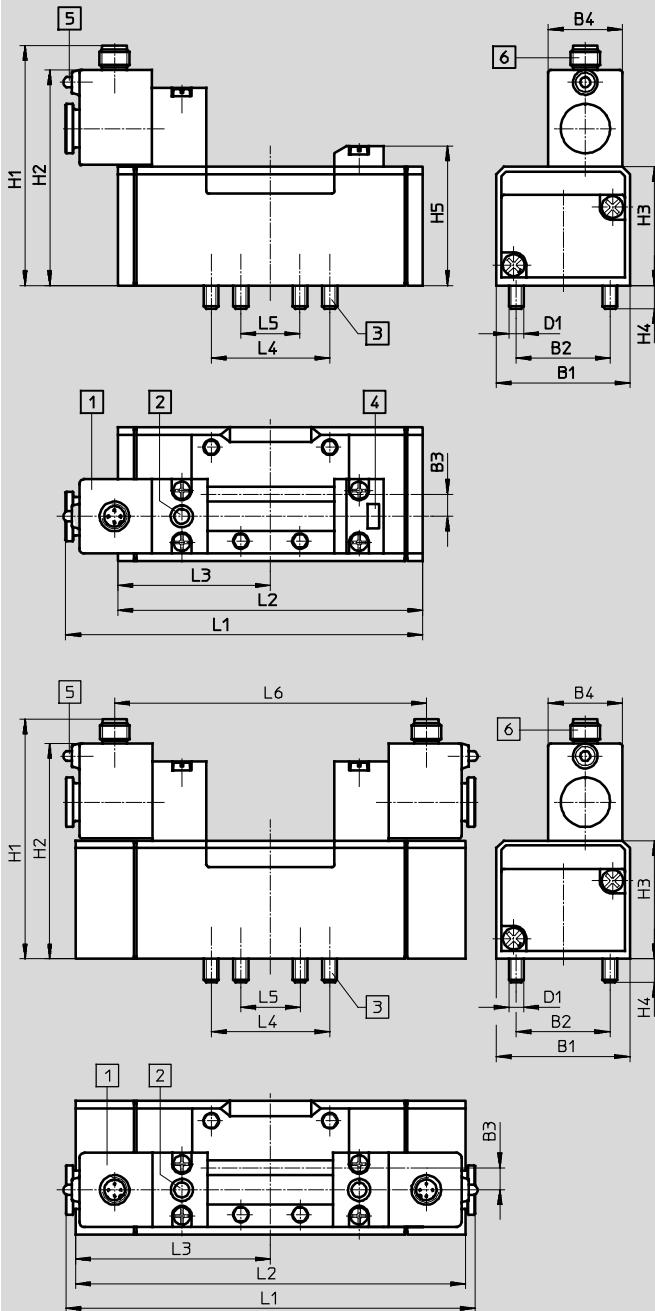

- 1 Solenoid coil can be repositioned by 90° regardless of manual override
- 2 Manual override
- 3 Captive mounting screws
- 4 Slot for inscription label
- 5 LED display
- 6 Device plug M12x1
Coil, 2-pin to VDMA
Coil, 4-pin to Desina

Type	B1	B2	B3	B4	D1	H1	H2	H3	H4	H5	L1	L2	L3	L4	L5	L6
MDH-5/2	42	28	6	30	M5	87.2	77.2	38	9	46.5	121.8	87.6	43.8	36	18	–
MDH-5/2-...-FR										46.5	132.2	98	43.8			–
JMDH-5/2											148	87.6	43.8			108.5
MDH-5/3											148	108.4	54.3			108.5

Solenoid valves MDH, JMDH, JMDDH, to ISO 5599-1

Ordering data – Width 42 mm

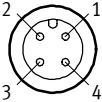
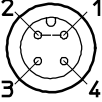
Pin allocation	
M12 plug – 2-pin to VDMA	M12 plug – 4-pin to Desina
	
1 Unused 2 Unused 3 com (-) 4 Signal (+)	1 Connected with 2 2 Connected with 1 3 com (-) 4 Signal (+)

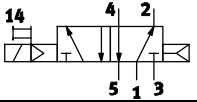
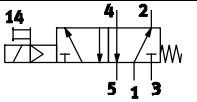
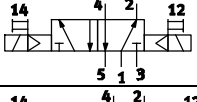
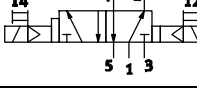
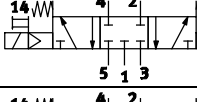
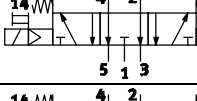
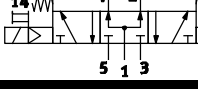
Ordering data – Solenoid valves, internal pilot air supply				
Circuit symbol	Description	Coil	Part No.	Type
5/2-way valve, single solenoid				
	Pneumatic spring	2-pin to VDMA	197125	MDH-5/2-D-1-M12-C
		4-pin to Desina	540803	MDH-5/2-D-1-M12D-C
	Mechanical reset method	2-pin to VDMA	533010	MDH-5/2-D-1-FR-M12-C
		4-pin to Desina	540804	MDH-5/2-D-1-FR-M12D-C
5/2-way valve, double solenoid				
	-	2-pin to VDMA	532687	JMDH-5/2-D-1-M12-C
		4-pin to Desina	540809	JMDH-5/2-D-1-M12D-C
	Dominant: signal at 14	2-pin to VDMA	539079	JMDDH-5/2-D-1-M12-C
		4-pin to Desina	540808	JMDDH-5/2-D-1-M12D-C
5/3-way valve, double solenoid				
	Normally closed	2-pin to VDMA	525307	MDH-5/3G-D-1-M12-C
		4-pin to Desina	540806	MDH-5/3G-D-1-M12D-C
	Normally exhausted	2-pin to VDMA	197126	MDH-5/3E-D-1-M12-C
		4-pin to Desina	540805	MDH-5/3E-D-1-M12D-C
	Normally open	2-pin to VDMA	533005	MDH-5/3B-D-1-M12-C
		4-pin to Desina	540807	MDH-5/3B-D-1-M12D-C

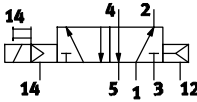
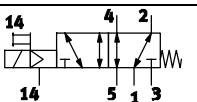
Ordering data – Solenoid valves, external pilot air supply				
Circuit symbol	Description	Coil	Part No.	Type
5/2-way valve, single solenoid				
	Pneumatic reset method	2-pin to VDMA	533332	MDH-5/2-D-1-S-M12-C
		4-pin to Desina	540810	MDH-5/2-D-1-S-M12D-C
	Mechanical reset method	2-pin to VDMA	533761	MDH-5/2-D-1S-FR-M12-C
		4-pin to Desina	540811	MDH-5/2-D-1S-FR-M12D-C

Solenoid valves MDH, JMDH, JMDDH, to ISO 5599-1

FESTO

Technical data – Width 52 mm

 Flow rate
2,300 l/min

 Voltage
24 V DC

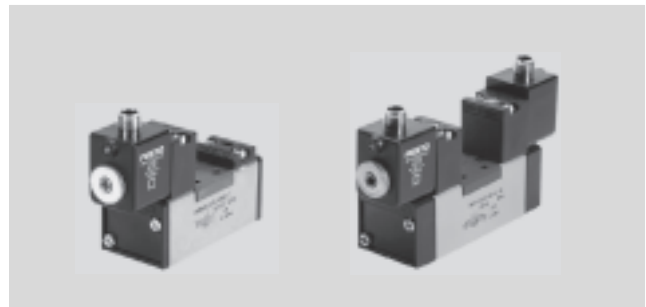

General technical data					
Valve function	5/2-way		5/3-way		
Normal position	–	–	G ¹⁾	B ²⁾	E ³⁾
Memory stability	Single solenoid	Double solenoid	Double solenoid		
Pneumatic spring reset method	Yes	–	No		
Mechanical spring reset method	Yes	–	Yes		
Design	Piston spool valve				
Sealing principle	Soft				
Actuation type	Electric				
Type of control	Piloted				
Pilot interface	To ISO 15218				
Pilot air supply	Internal				
Direction of flow	Non-reversible				
Exhaust function	Flow control				
Manual override	Non-detenting				
Type of mounting	On sub-base				
Mounting position	Any				
Nominal size	[mm]	11			
Standard nominal flow rate	[l/min]	2,300			
Switching time on/off, pneumatic spring	[ms]	45/60	–	–	
Switching time on/off, mechanical spring	[ms]	25/60	–	35/70	
Changeover time	[ms]	–	22	–	
Switching time with dominant signal at 14 (12/14)	[ms]	–	22	–	
Width	[mm]	52			
Grid dimension	[mm]	56			
Connection on the sub-base	1, 2, 3, 4, 5 12, 14	G $\frac{3}{8}$ M5			
Conforms to	ISO 5599-1 and ISO 15218 for pilot valve interface				
Product weight	[g]	810	810	880	

- 1) G = Normally closed
 2) B = Normally open
 3) E = Normally exhausted

Operating and environmental conditions					
Reset method		Pneumatic spring		Mechanical spring	
Operating medium		Compressed air in accordance with ISO 8573-1:2010 [7:4:4]			
Pilot medium		Compressed air in accordance with ISO 8573-1:2010 [7:4:4]			
Note on operating/pilot medium		Operation with lubricated medium possible (in which case lubricated operation will always be required)			
Operating pressure	Internal pilot air supply	[bar]	2 ... 10		3 ... 10
	External pilot air supply	[bar]	–0.9 ... +16		
Pilot pressure	[bar]	2 ... 10		3 ... 10	
Ambient temperature	[°C]	–10 ... +50			
Temperature of medium	[°C]	–10 ... +50			

Solenoid valves MDH, JMDH, JMDDH, to ISO 5599-1

Technical data – Width 52 mm

Electrical data – D solenoid coil with round plug M12x1		
Electrical connection	Design	M12x1
Coil characteristics	DC voltage [V DC]	21.6...26.4
	Power [W]	2.7
Duty cycle	[%]	100
Protection class to EN 60529		IP65

Materials

Sectional view

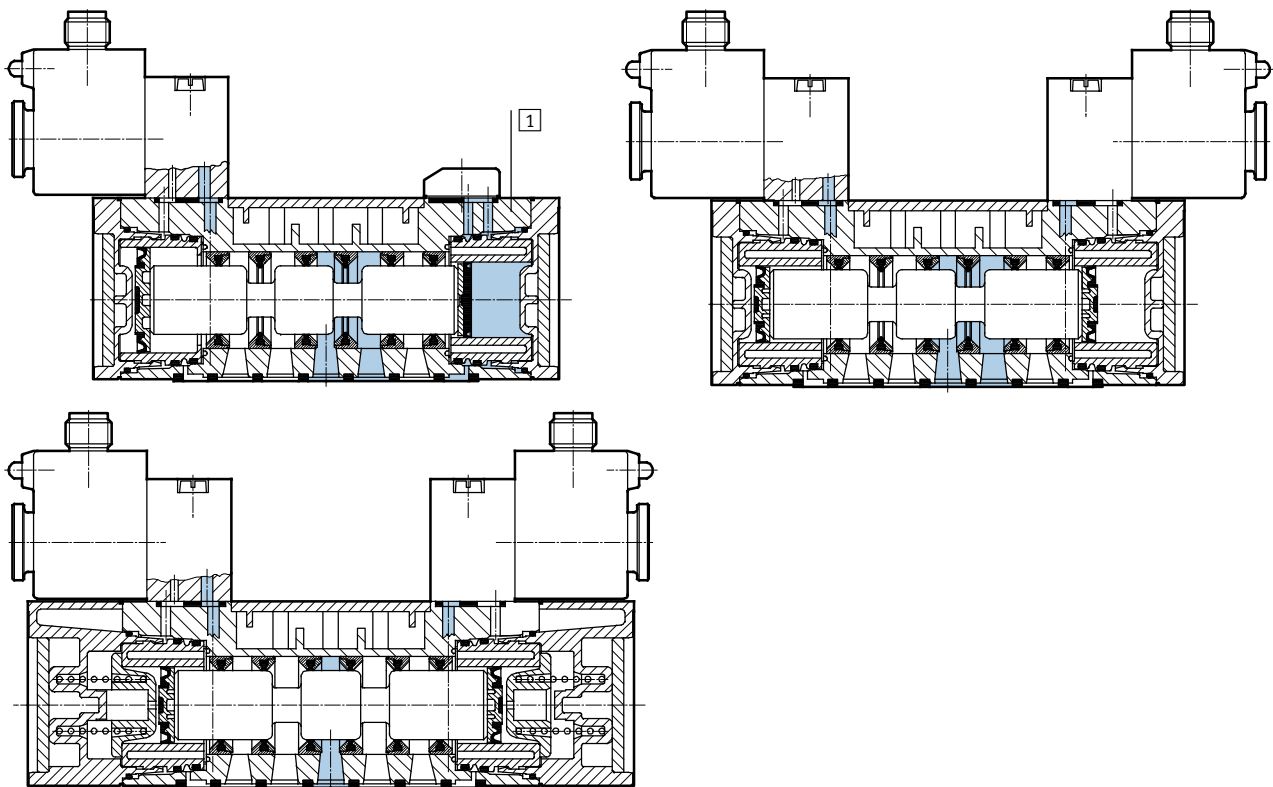

1	Housing	Die-cast aluminium, polyacetal
-	Seals	Nitrile rubber

Solenoid valves MDH, JMDH, JMDDH, to ISO 5599-1

Technical data – Width 52 mm

Dimensions

Download CAD data → www.festo.com

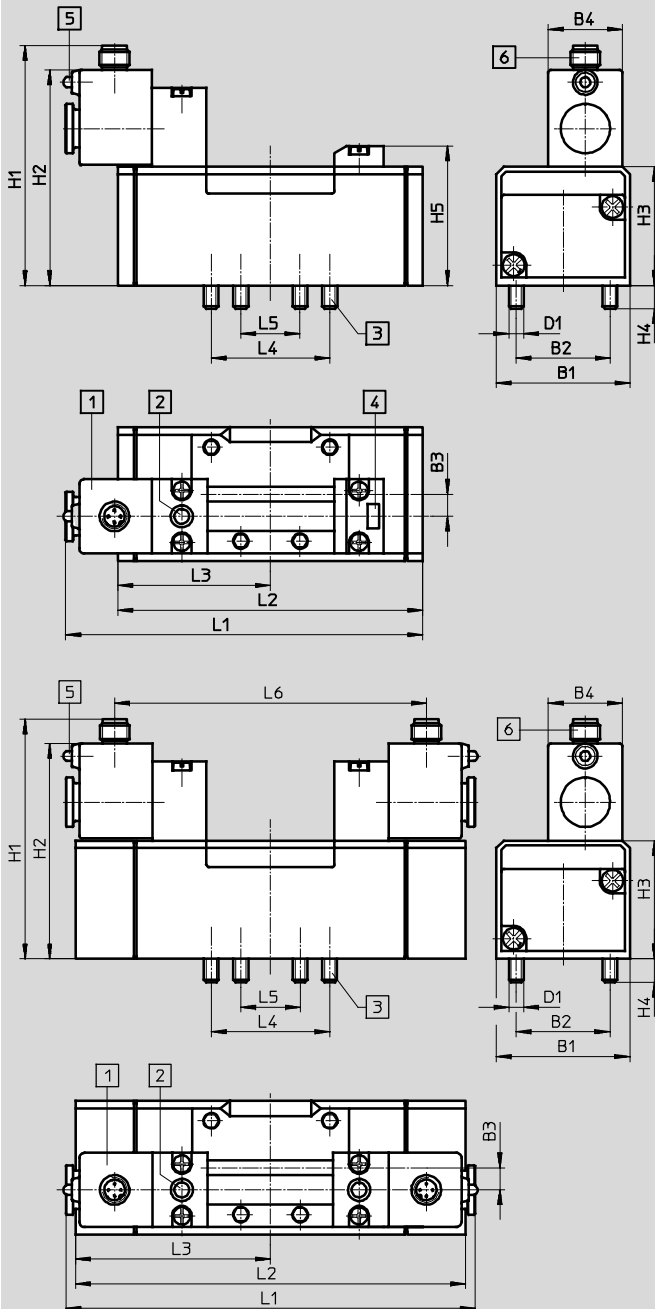

- 1 Solenoid coil can be repositioned by 90° regardless of manual override
- 2 Manual override
- 3 Captive mounting screws
- 4 Slot for inscription label
- 5 LED display
- 6 Device plug M12x1
Coil, 2-pin to VDMA
Coil, 4-pin to Desina

Type	B1	B2	B3	B4	D1	H1	H2	H3	H4	H5	L1	L2	L3	L4	L5	L6
MDH-5/2	54	38	9	30	M6	97.2	87.2	48	9.5	56.5	144.6	123.4	61.7	48	24	–
MDH-5/2-...-FR										56.5	161.9	140.6	61.7			–
JMDH-5/2										–	165.8	123.4	61.7			–
MDH-5/3										–	165.8	158	79			–

Solenoid valves MDH, JMDH, JMDDH, to ISO 5599-1

Ordering data – Width 52 mm

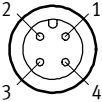
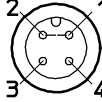
Pin allocation	
M12 plug – 2-pin to VDMA	M12 plug – 4-pin to Desina
	
<p>1 Unused 2 Unused 3 com (-) 4 Signal (+)</p>	<p>1 Connected with 2 2 Connected with 1 3 com (-) 4 Signal (+)</p>

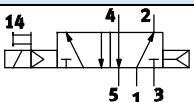
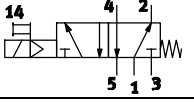
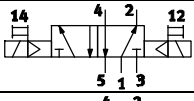
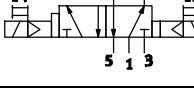
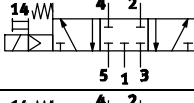
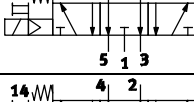
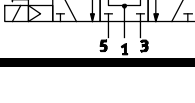
Ordering data				
Circuit symbol	Description	Coil	Part No.	Type
5/2-way valve, single solenoid				
	Pneumatic reset method	2-pin to VDMA	533008	MDH-5/2-D-2-M12-C
		4-pin to Desina	540812	MDH-5/2-D-2-M12D-C
	Mechanical reset method	2-pin to VDMA	533011	MDH-5/2-D-2-FR-M12-C
		4-pin to Desina	540813	MDH-5/2-D-2-FR-M12D-C
5/2-way valve, double solenoid				
	-	2-pin to VDMA	533013	JMDH-5/2-D-2-M12-C
		4-pin to Desina	540818	JMDH-5/2-D-2-M12D-C
	With dominant signal at 14	2-pin to VDMA	539077	JMDDH-5/2-D-2-M12-C
		4-pin to Desina	540817	JMDDH-5/2-D-2-M12D-C
5/3-way valve, double solenoid				
	Normally closed	2-pin to VDMA	539078	MDH-5/3G-D-2-M12-C
		4-pin to Desina	540815	MDH-5/3G-D-2-M12D-C
	Normally exhausted	2-pin to VDMA	533016	MDH-5/3E-D-2-M12-C
		4-pin to Desina	540814	MDH-5/3E-D-2-M12D-C
	Normally open	2-pin to VDMA	533006	MDH-5/3B-D-2-M12-C
		4-pin to Desina	540816	MDH-5/3B-D-2-M12D-C

Solenoid valves MEBH, JMEBH, to ISO 5599-1

FESTO

Technical data – Width 42 mm

-  Flow rate
1,200 l/min

-  Voltage
24 V DC

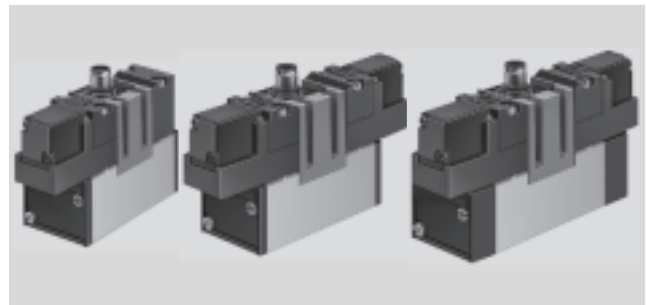

General technical data					
Valve function	5/2-way		5/3-way		
Normal position	–	–	G ¹⁾	B ²⁾	E ³⁾
Memory stability	Single solenoid	Double solenoid	Double solenoid		
Pneumatic spring reset method	Yes	–	No		
Mechanical spring reset method	Yes	–	Yes		
Design	Piston spool valve				
Sealing principle	Soft				
Actuation type	Electric				
Type of control	Piloted				
Pilot air supply	Internal				
Direction of flow	Non-reversible				
Exhaust function	Flow control				
Manual override	Detenting via accessory				
Type of mounting	Via through-hole				
Mounting position	Any				
Nominal size	[mm]	8			
Standard nominal flow rate	[l/min]	1,200			
Switching time on/off, pneumatic spring	[ms]	20/33	–	–	
Switching time on/off, mechanical spring	[ms]	15/50	–	19/68	
Changeover time	[ms]	–	12	–	
Switching time with dominant signal at 14 (12/14)	[ms]	–	13	–	
Width	[mm]	42			
Grid dimension	[mm]	43			
Connection on the sub-base	1, 2, 3, 4, 5 12, 14	G1/4 M5			
Product weight	[g]	550	600	630	

- 1) G = Normally closed
- 2) B = Normally open
- 3) E = Normally exhausted

Operating and environmental conditions					
Reset method		Pneumatic spring		Mechanical spring	
Operating medium		Compressed air in accordance with ISO 8573-1:2010 [7:4:4]			
Pilot medium		Compressed air in accordance with ISO 8573-1:2010 [7:4:4]			
Note on operating/pilot medium		Operation with lubricated medium possible (in which case lubricated operation will always be required)			
Operating pressure	Internal pilot air supply	[bar]	2 ... 10		3 ... 10
	External pilot air supply	[bar]	–0.9 ... +16		
Pilot pressure	[bar]	2 ... 10		3 ... 10	
Ambient temperature	[°C]	–5 ... +50			
Temperature of medium	[°C]	–5 ... +50			

Solenoid valves MEBH, JMEBH, to ISO 5599-1

Technical data – Width 42 mm

Electrical data – EB solenoid coil with round plug M12x1		
Electrical connection	Design	M12x1
Coil characteristics	DC voltage [V DC]	24
	Power [W]	2.5
Duty cycle	[%]	100
Protection class to EN 60529		IP65

Materials

Sectional view

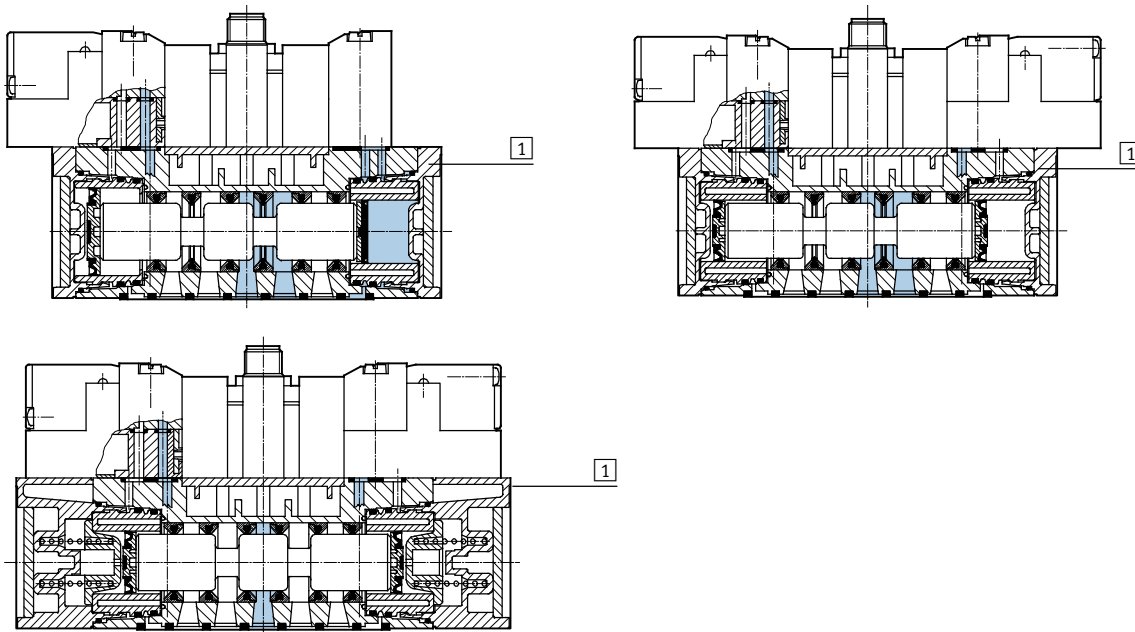

1	Housing	Die-cast aluminium
-	Seals	Nitrile rubber

Solenoid valves MEBH, JMEBH, to ISO 5599-1

Technical data – Width 42 mm

Dimensions

Download CAD data → www.festo.com

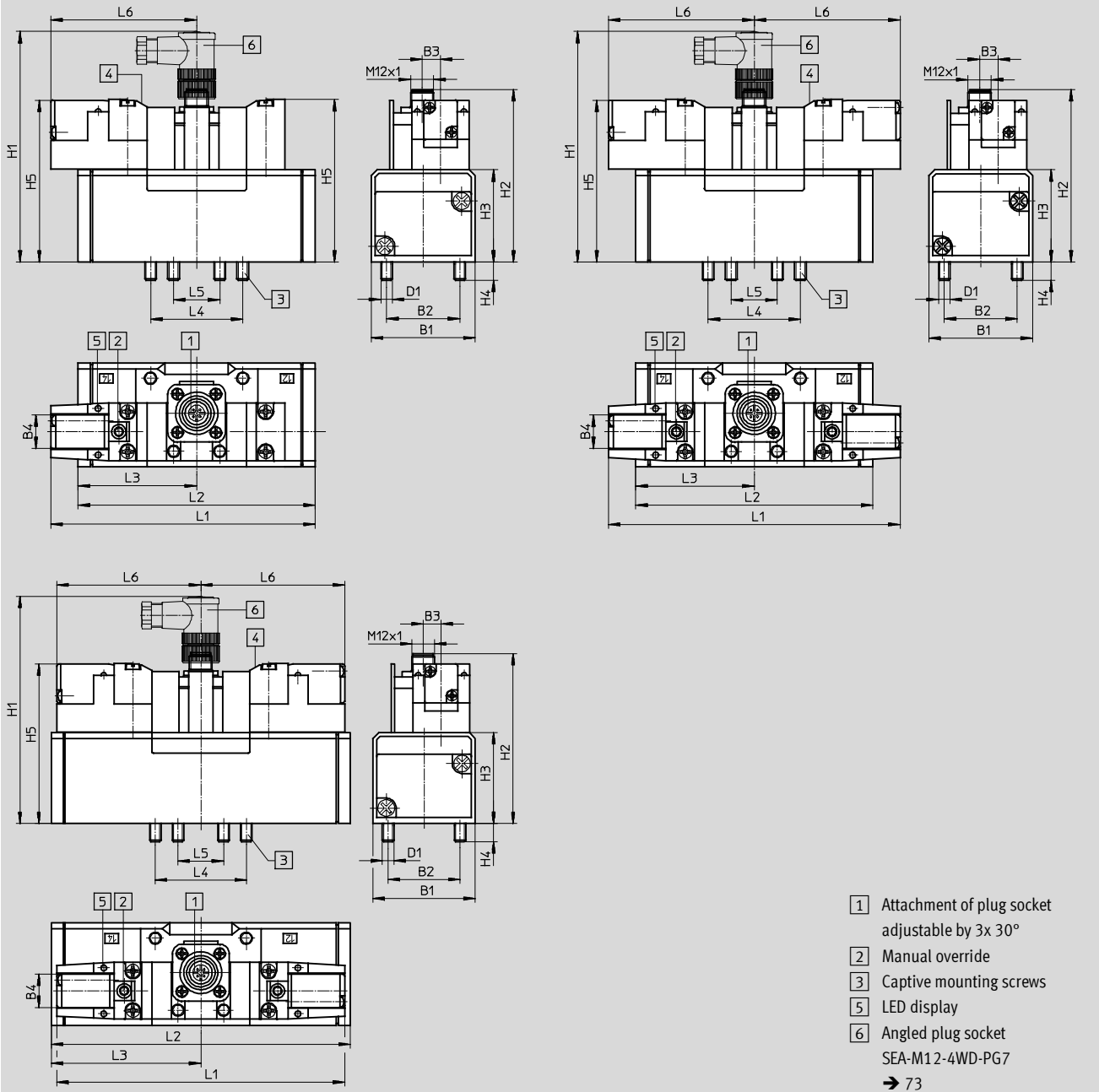



Type	B1	B2	B3	B4	D1	H1	H2	H3	H4	H5	L1	L2	L3	L4	L5	L6
MEBH-5/2	42	28	6	17.5	M5	110	80.3	38	9	74.7	110.8	87.6	43.8	36	18	67
MEBH-5/2-...-FR											121.3	98	43.8			
JMEB											134	87.6	43.8			
MEBH-5/3											134	108.4	54.2			

Solenoid valves MEBH, JMEBH, to ISO 5599-1

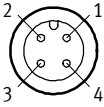
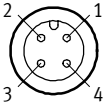
Ordering data – Width 42 mm

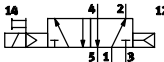
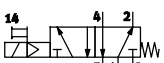
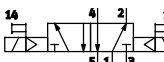
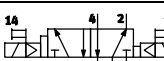
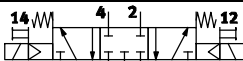
Central plug M12 – Pin allocation	
Connection for single solenoid	Connection for double solenoid
	
<ul style="list-style-type: none"> 1 Unused 2 Unused 3 com (-) 4 Signal (+) solenoid 14 	<ul style="list-style-type: none"> 1 Unused 2 Signal (+) solenoid 12 3 com (-) 4 Signal (+) solenoid 14

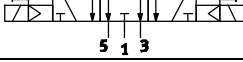
Ordering data			
Circuit symbol	Description	Part No.	Type
5/2-way valve, single solenoid			
	Pneumatic spring	184493	MEBH-5/2-D-1-ZSR-C
	Mechanical reset method	184494	MEBH-5/2-D-1-ZSR-FR-C
5/2-way valve, double solenoid			
	–	184495	JMEBH-5/2-D-1-ZSR-C
	Dominant: signal at 14	184496	JMEBDH-5/2-D-1-ZSR-C
5/3-way valve, double solenoid			
	Normally closed	184498	MEBH-5/3G-D-1-ZSR-C
	Normally exhausted	184497	MEBH-5/3E-D-1-ZSR-C
	Normally open	184499	MEBH-5/3B-D-1-ZSR-C

Solenoid valves MEBH, JMEBH, to ISO 5599-1

FESTO

Technical data – Width 52 mm

-  - Flow rate
2,300 l/min

-  - Voltage
24 V DC

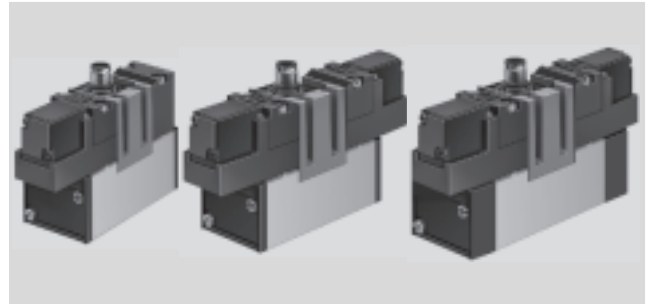

General technical data					
Valve function	5/2-way			5/3-way	
Normal position	-	-	-	G ¹⁾	B ²⁾ E ³⁾
Memory stability	Single solenoid	Double solenoid	Double solenoid		
Pneumatic spring reset method	Yes	-	-	No	
Mechanical spring reset method	Yes	-	-	Yes	
Design	Piston spool valve				
Sealing principle	Soft				
Actuation type	Electric				
Type of control	Piloted				
Pilot air supply	Internal				
Direction of flow	Non-reversible				
Exhaust function	Flow control				
Manual override	Detenting via accessory				
Type of mounting	Via through-hole				
Mounting position	Any				
Nominal size	[mm]	11			
Standard nominal flow rate	[l/min]	2,300			
Switching time on/off, pneumatic spring	[ms]	50/85	-	-	-
Switching time on/off, mechanical spring	[ms]	33/103	-	-	30/106
Changeover time	[ms]	-	15	-	-
Switching time with dominant signal at 14 (12/14)	[ms]	-	23	-	-
Width	[mm]	52			
Grid dimension	[mm]	56			
Connection on the sub-base	1, 2, 3, 4, 5 12, 14	G $\frac{3}{8}$ M5			
Product weight	[g]	700	770	800	

- 1) G = Normally closed
- 2) B = Normally open
- 3) E = Normally exhausted

Operating and environmental conditions					
Reset method			Pneumatic spring	Mechanical spring	
Operating medium			Compressed air in accordance with ISO 8573-1:2010 [7:4:4]		
Pilot medium			Compressed air in accordance with ISO 8573-1:2010 [7:4:4]		
Note on operating/pilot medium			Operation with lubricated medium possible (in which case lubricated operation will always be required)		
Operating pressure	Internal pilot air supply	[bar]	2 ... 10		3 ... 10
	External pilot air supply	[bar]	-0.9 ... +16		
Pilot pressure		[bar]	2 ... 10		3 ... 10
Ambient temperature		[°C]	-5 ... +50		
Temperature of medium		[°C]	-5 ... +50		

Solenoid valves MEBH, JMEBH, to ISO 5599-1

Technical data – Width 52 mm

Electrical data – EB solenoid coil with round plug M12x1		
Electrical connection	Design	M12x1
Coil characteristics	DC voltage [V DC]	24
	Power [W]	2.5
Duty cycle	[%]	100
Protection class to EN 60529		IP65

Materials

Sectional view

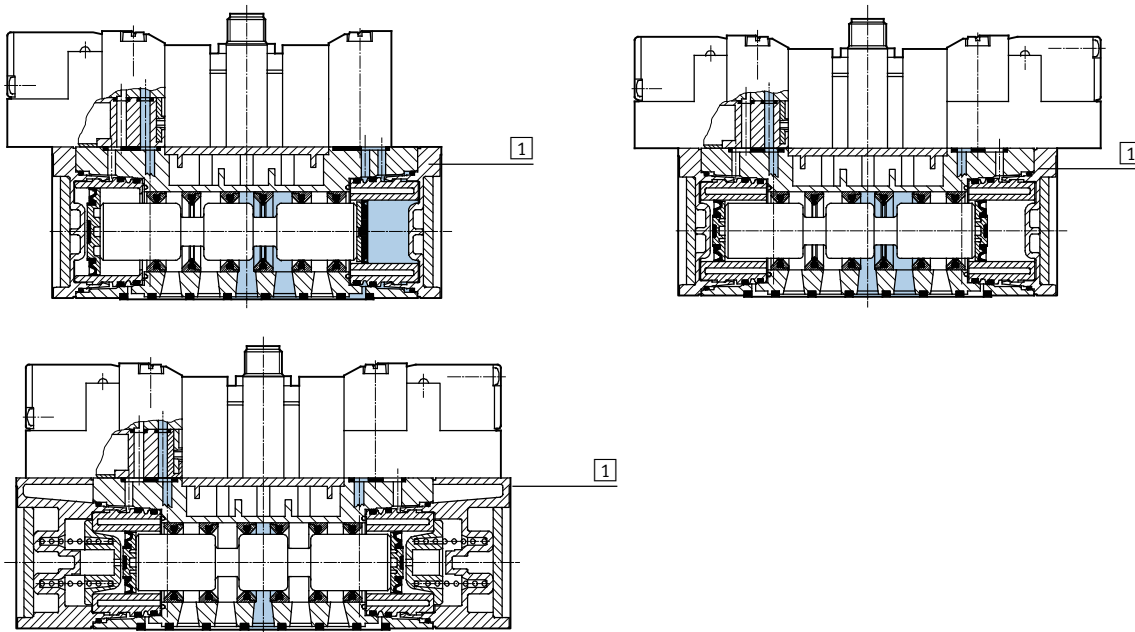

1	Housing	Die-cast aluminium
-	Seals	Nitrile rubber

Solenoid valves MEBH, JMEBH, to ISO 5599-1

Technical data – Width 52 mm

Dimensions

Download CAD data → www.festo.com

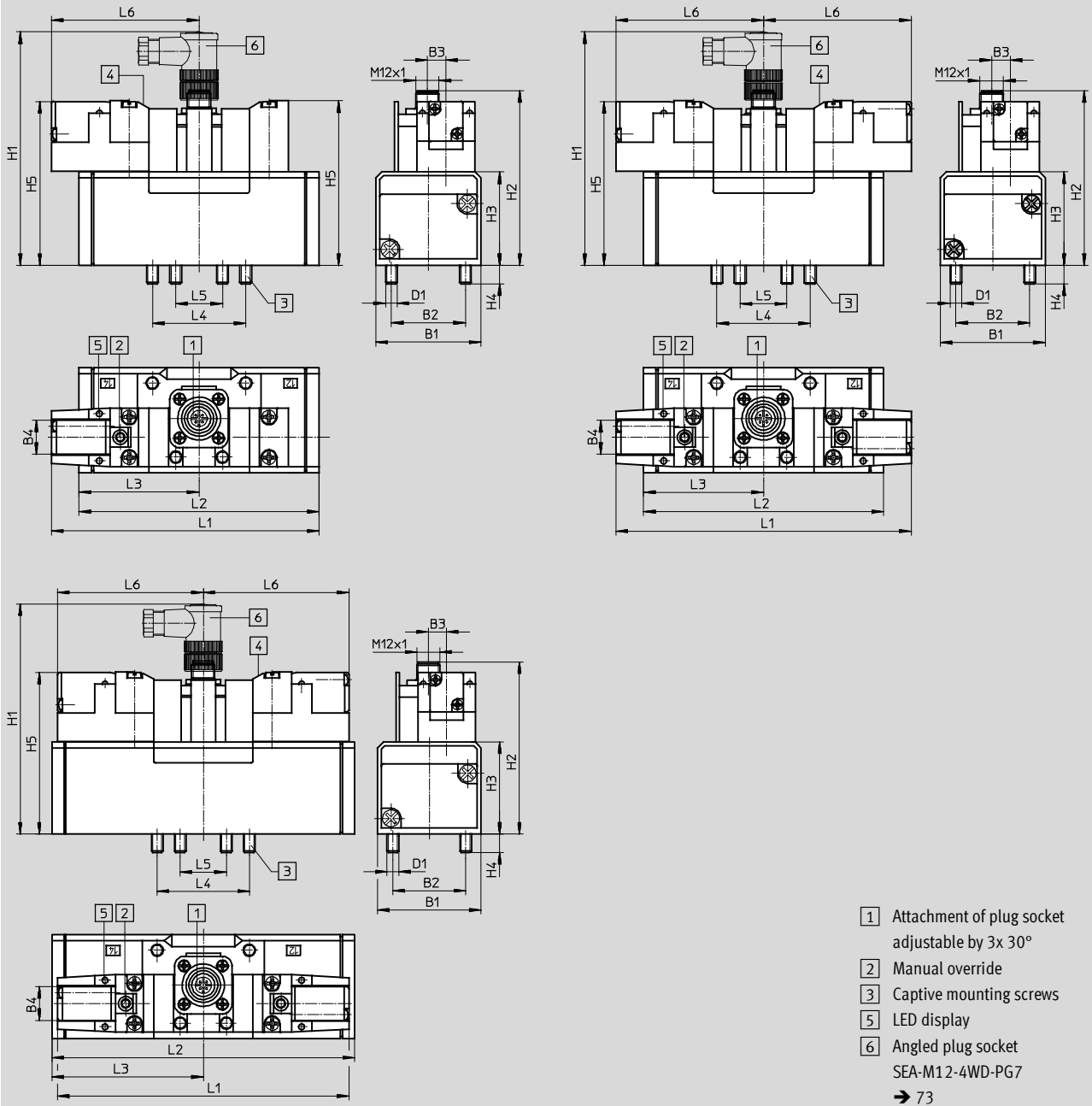

- 1 Attachment of plug socket adjustable by 3x 30°
 - 2 Manual override
 - 3 Captive mounting screws
 - 5 LED display
 - 6 Angled plug socket SEA-M12-4WD-PG7
- 73

Type	B1	B2	B3	B4	D1	H1	H2	H3	H4	H5	L1	L2	L3	L4	L5	L6
MEBH-5/2	54	38	9	17.5	M6	120	90.1	48	9.5	84.2	137.6	123.4	61.7	48	24	75.9
MEBH-5/2-...-FR											154.9	140.7	61.7			
JMEB											151.8	123.4	61.7			
MEBH-5/3											151.8	158	79			

Solenoid valves MEBH, JMEBH, to ISO 5599-1

Ordering data – Width 52 mm

Central plug M12 – Pin allocation			
Connection for single solenoid		Connection for double solenoid	
	<ul style="list-style-type: none"> 1 Unused 2 Unused 3 com (-) 4 Signal (+) solenoid 14 		<ul style="list-style-type: none"> 1 Unused 2 Signal (+) solenoid 12 3 com (-) 4 Signal (+) solenoid 14

Ordering data			
Circuit symbol	Description	Part No.	Type
5/2-way valve, single solenoid			
	Pneumatic spring	184500	MEBH-5/2-D-2-ZSR-C
	Mechanical reset method	184501	MEBH-5/2-D-2-ZSR-FR-C
5/2-way valve, double solenoid			
	-	184502	JMEBH-5/2-D-2-ZSR-C
	Dominant: signal at 14	184503	JMEBDH-5/2-D-2-ZSR-C
5/3-way valve, double solenoid			
	Normally closed	184505	MEBH-5/3G-D-2-ZSR-C
	Normally exhausted	184504	MEBH-5/3E-D-2-ZSR-C
	Normally open	184506	MEBH-5/3B-D-2-ZSR-C

Manifold components, to ISO 5599-1

Horizontal stacking

Individual sub-base NAS

Ports at side

Material:

Die-cast aluminium

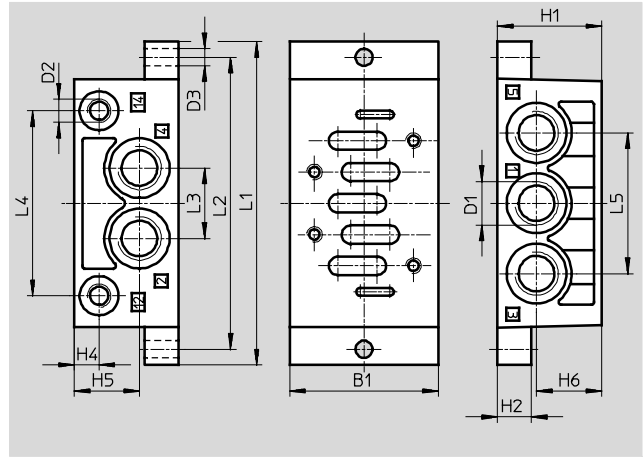

Dimensions and ordering data																	
ISO size/width	B1	D1	D2	D3 ∅	H1	H2	H4	H5	H6	L1	L2	L3	L4	L5	Weight [g]	Part No.	Type
1/42 mm	48	G $\frac{1}{4}$	G $\frac{1}{8}$	5.5	32	10	9	20.3	20.3	110	98	23	60	46	190	9484	NAS-1/4-1A-ISO ¹⁾
2/52 mm	57	G $\frac{3}{8}$	G $\frac{1}{8}$	6.6	40	13	9	25	25	124	112	27	71	54	300	11310	NAS-3/8-2A-ISO ¹⁾

1) Free of copper and PTFE

Individual sub-base NAU

Ports underneath

Material:

Die-cast aluminium

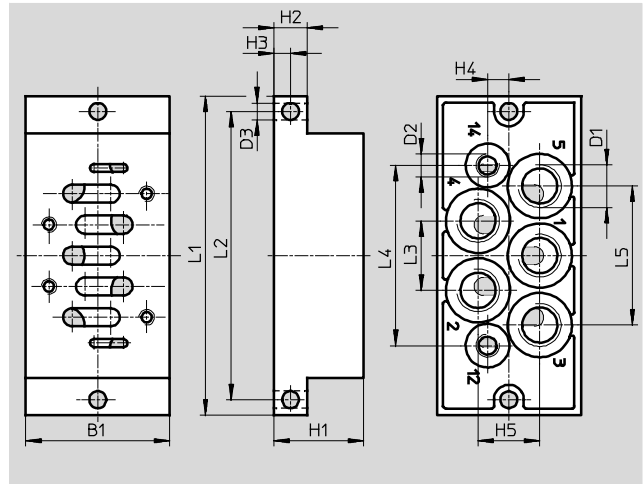

Dimensions and ordering data																	
ISO size/width	B1	D1	D2	D3 ∅	H1	H2	H3	H4	H5	L1	L2	L3	L4	L5	Weight [g]	Part No.	Type
1/42 mm	46	G $\frac{1}{4}$	G $\frac{1}{8}$	5.5	30	10	5	7.5	20	110	98	23	60.7	46	280	9485	NAU-1/4-1B-ISO ¹⁾
2/52 mm	56	G $\frac{3}{8}$	G $\frac{1}{8}$	6.6	35	13	6.5	8.3	24	124	112	27	70	54	450	11416	NAU-3/8-2B-ISO ¹⁾

1) Free of copper and PTFE

Manifold components, to ISO 5599-1

Horizontal stacking

FESTO

Manifold sub-base NAV

Ports underneath

Material:
Die-cast aluminium



Ordering data					
ISO size/ width	Pneumatic connection		Weight [g]	Part No.	Type
	1, 2, 3, 4, 5	12, 14			
1/42 mm	G1/4	G1/8	240	10173	NAV-1/4-1C-ISO
2/52 mm	G3/8	G1/8	400	11305	NAV-3/8-2C-ISO

Dimensions → 64

90° connection plate NAW

Ports at side and underneath

Material:
Die-cast aluminium



Ordering data					
ISO size/ width	Pneumatic connection		Weight [g]	Part No.	Type
	1, 2, 3, 4, 5	12, 14			
1/42 mm	G1/4	G1/8	360	11304	NAW-1/4-1E-ISO ¹⁾
2/52 mm	G3/8	G1/8	600	11307	NAW-3/8-2E-ISO ¹⁾

Dimensions → 64

1) Free of copper and PTFE

Manifold sub-base with 90° connections NAVW

Ports at side and underneath

Material:
Die-cast aluminium



Ordering data					
ISO size/ width	Pneumatic connection		Weight [g]	Part No.	Type
	1, 2, 3, 4, 5	12, 14			
1/42 mm	G1/4	G1/8	320	152789	NAVW-1/4-1-ISO
2/52 mm	G3/8	G1/8	550	152790	NAVW-3/8-2-ISO

Dimensions → 64

End plate kit NEV

Material:
Die-cast aluminium

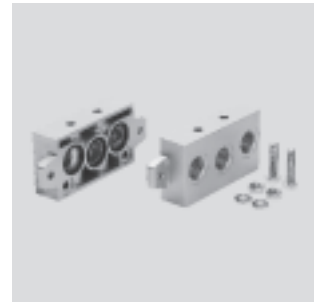

Ordering data					
ISO size/ width	Pneumatic connection		Weight [g]	Part No.	Type
	1, 2, 3, 4, 5	12, 14			
1/42 mm	G3/8	–	280	10174	NEV-1DA/DB-ISO ¹⁾
2/52 mm	G1/2	–	450	11306	NEV-2DA/DB-ISO ¹⁾

Dimensions → 64

1) Free of copper and PTFE

- | - Note: This product conforms to ISO 1179-1 and to ISO 228-1

Manifold components, to ISO 5599-1

Horizontal stacking



Blanking plate NDV

Material:
Steel



Isolating disc NSC

Material:
Wrought aluminium alloy

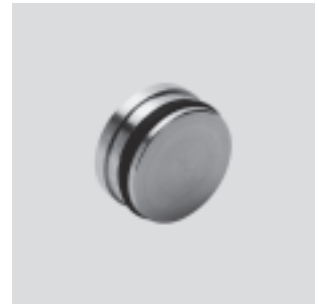

Ordering data			
ISO size/ width	Weight [g]	Part No.	Type
2/52 mm	166	11308	NDV-2-ISO

Dimensions → 64

Ordering data					
ISO size/ width	Pneumatic connection		Weight [g]	Part No.	Type
	1, 2, 3	12, 14			
1/42 mm	1/4	–	6	11550	NSC-1/4-1-ISO¹⁾
2/52 mm	3/8	–	9.2	11908	NSC-3/8-2-ISO¹⁾

Dimensions → 64

1) Free of copper and PTFE

Manifold components, to ISO 5599-1

Horizontal stacking

Dimensions – Manifold assembly

Download CAD data → www.festo.com/en/engineering

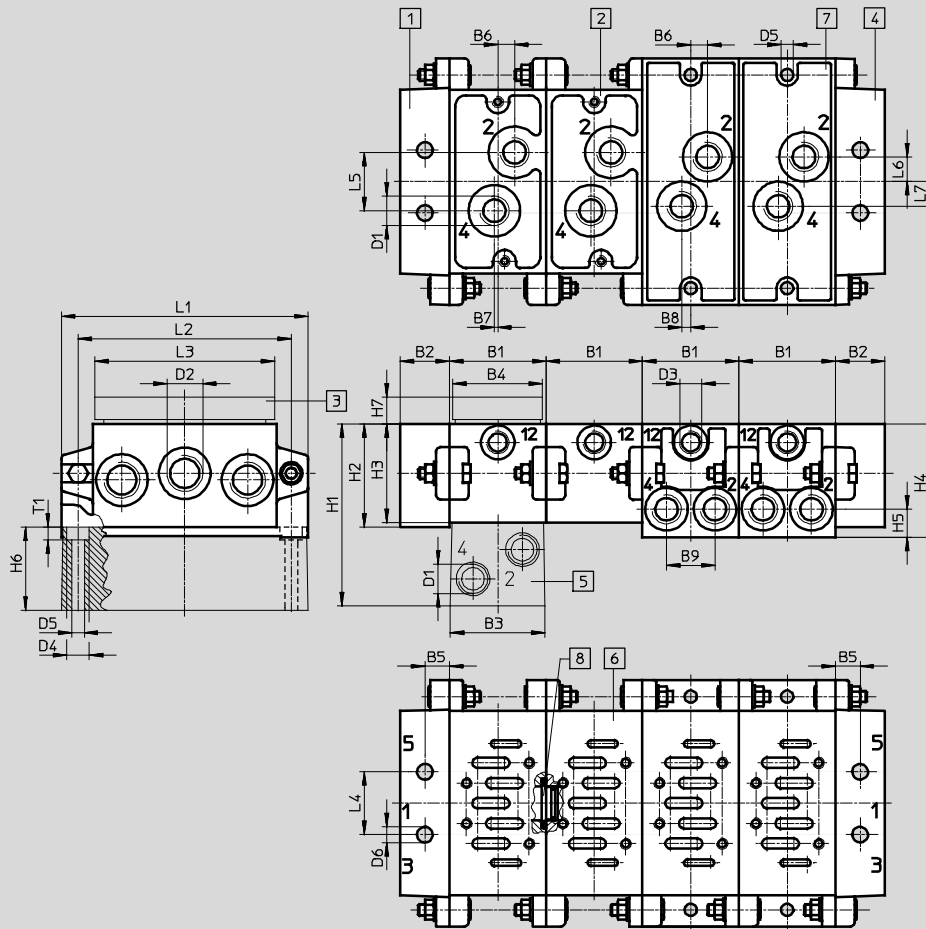

- 1 Left-hand end plate
- 2 Manifold sub-base NAV
- 3 Blanking plate NDV
- 4 Right-hand end plate
- 5 90° connection plate NAW
- 6 Port pattern to ISO 5599-1
- 7 Manifold sub-base with 90° connections NAVW
- 8 Isolating disc NSC



ISO size/width															
1/42 mm	B1	B2	B3	B4	B5	B6	B7	B8	B9	D1	D2	D3	D4	D5	D6
	43	22	42	40	11	7.5	1.5	4	21.6	G $\frac{1}{4}$	G $\frac{3}{8}$	G $\frac{1}{8}$	10	5.5	7
	H1	H2	H3	H4	H5	H6	H7	L1	L2	L3	L4	L5	L6	L7	T1
	81	46	44	50.5	12.5	37	5	110	95	80	28	26	11	11	5.7
2/52 mm	B1	B2	B3	B4	B5	B6	B7	B8	B9	D1	D2	D3	D4	D5	D6
	56	26	55	50	13	6	5	6	27	G $\frac{3}{8}$	G $\frac{1}{2}$	G $\frac{1}{8}$	11	6.6	9
	H1	H2	H3	H4	H5	H6	H7	L1	L2	L3	L4	L5	L6	L7	T1
	85	47	45	60	15	40	5	135	115	96	35	30	15	14	6.8

Note: This product conforms to ISO 1179-1 and to ISO 228-1

Manifold components, to ISO 5599-1

Vertical stacking

Regulator plate
VABF-S1-...-R

-  Temperature range
-5 ... +50 °C
-  Input pressure
0,5 ... 10 bar

Pressure regulating ranges:
0.5 ... 6 bar, 0.5 ... 10 bar
Output pressure constant
with secondary venting

Materials:
Housing: Die-cast aluminium
Control section: PA

Note on materials:
RoHS-compliant

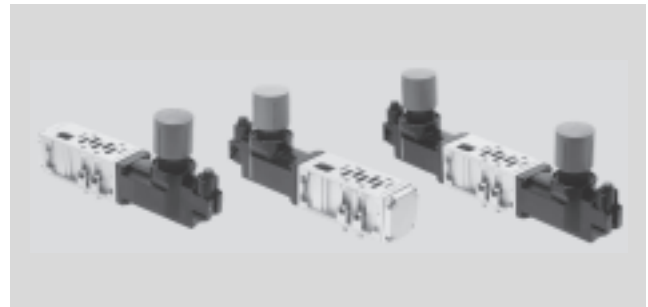

Dimensions

Download CAD data → www.festo.com/en/engineering

Regulator plate: A regulator, B regulator, AB regulator, P regulator

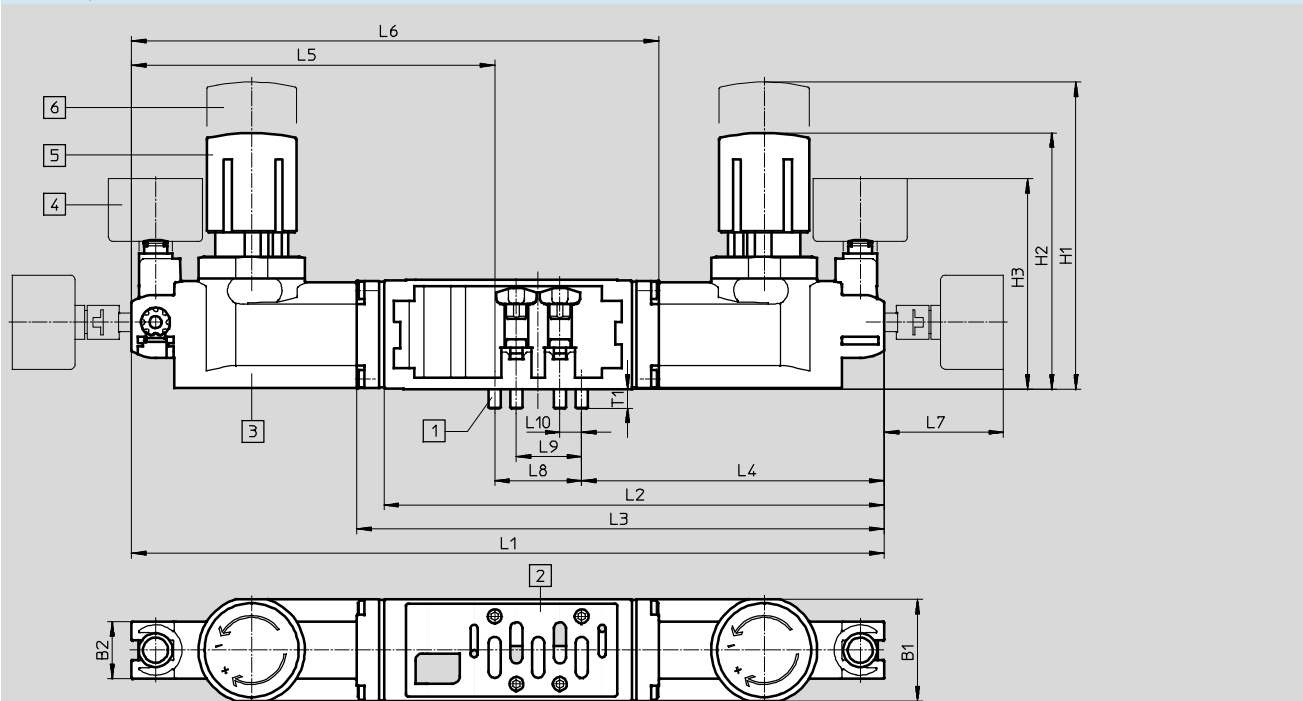

- 1 Captive screws M5x25
(width 42 mm) or M6x30
(width 52 mm)
- 2 Port pattern to ISO 5599-1
- 3 Regulator
- 4 Pressure gauge
- 5 Regulator head in the locked state
- 6 Regulator head with pressure adjustment

Type	B1	B2	H1	H2	H3	L1	L2	L3	L4	L5	L6	L7	L8	L9	L10	T1	Weight [g]
Width 42 mm																	
VABF-S1-1-R1	42.1	23.6	127.2	106.1	87.1	-	207.1	-	125.3	-	-	49.4	36	27	9	7.9	640
VABF-S1-1-R4(5)						311.6	-	-	-	-	-						920
VABF-S1-1-R3(7)						-	-	-	125.3	150.3	216.1						640
VABF-S1-1-R2(6)						-	-	216.2	125.3	-	-						640
Width 52 mm																	
VABF-S1-2-R1	54	23.6	183.5	161.9	94.4	-	250.2	-	152.2	-	-	49.4	48	36	12	10	1,190
VABF-S1-2-R4(5)						380.4	-	-	-	-	-						1,990
VABF-S1-2-R3(7)						-	-	-	152.2	180.2	264.2						1,230
VABF-S1-2-R2(6)						-	-	264.2	152.2	-	-						1,230

Manifold components, to ISO 5599-1

Vertical stacking

Dimensions

Download CAD data → www.festo.com/en/engineering

Regulator plate with manifold sub-base and solenoid valve

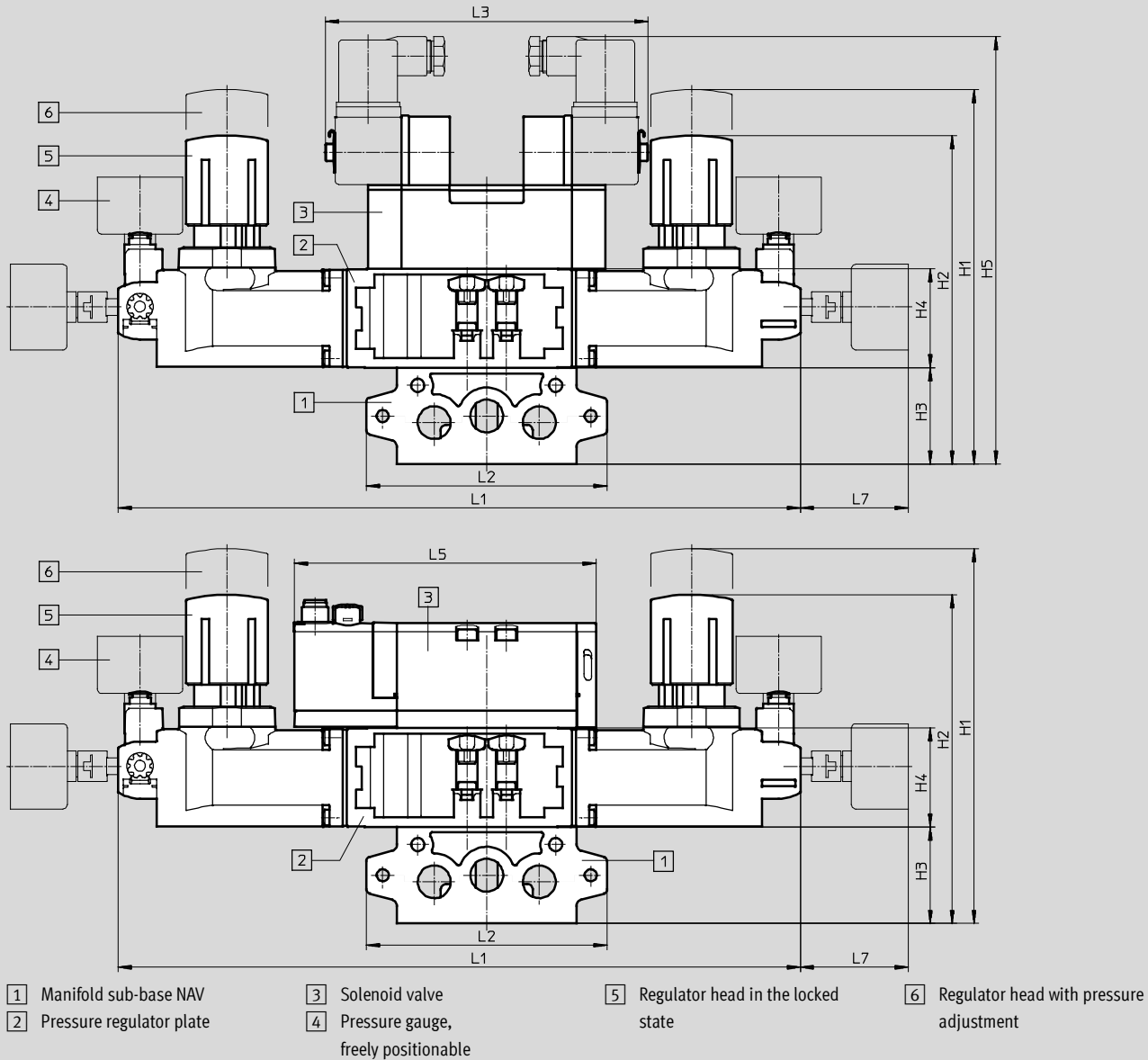

Type	H1	H2	H3	H4	H5	L1	L2	L3	L5	L7
VABF-S1-1-R	171.2	150.1	44	45.3	195.3	311.6	110	147.3	137.8	49.4
VABF-S1-2-R	228.5	206.9	45	58.9	219.9	380.4	135	165	160.7	49.4

Manifold components, to ISO 5599-1

Vertical stacking

Dimensions

Download CAD data → www.festo.com/en/engineering

Regulator plate with manifold sub-base and solenoid valve

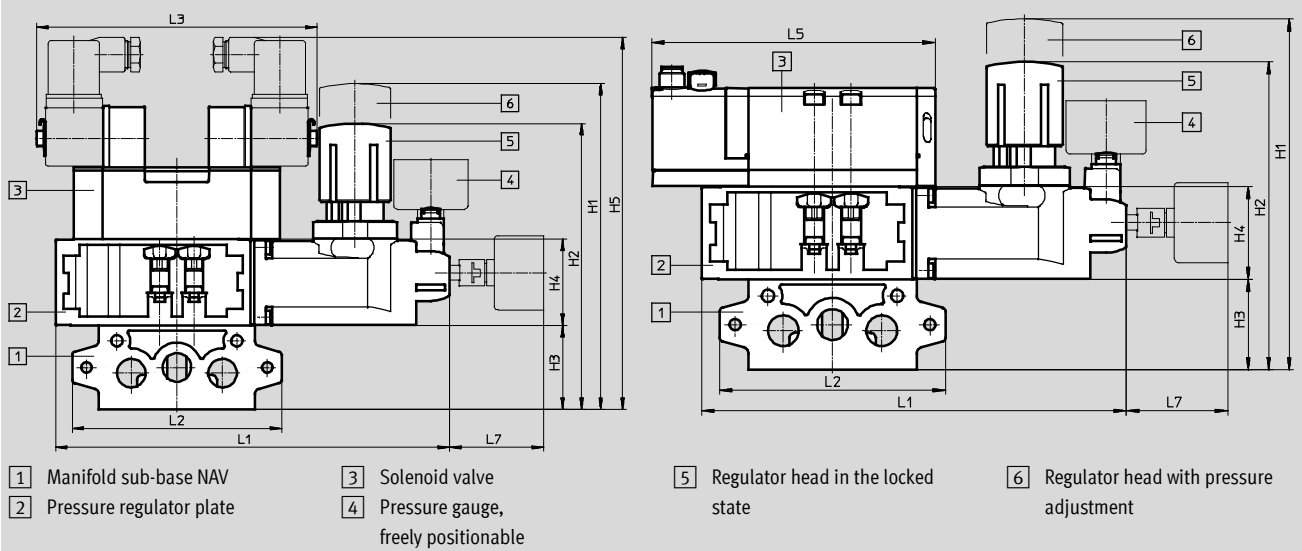

Type	H1	H2	H3	H4	H5	L1	L2	L3	L5	L7
VABF-S1-1-R	171.2	150.1	44	45.3	195.3	207.1	110	147.3	137.8	49.4
VABF-S1-2-R	228.5	206.9	45	58.9	219.9	250.2	135	165	160.7	49.4

Manifold components, to ISO 5599-1

FESTO

Vertical stacking

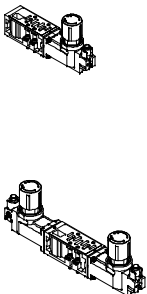
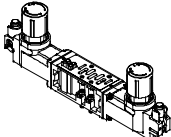

Ordering data					
	For port	Regulator	Regulation range	Part No.	Type
Regulator plate, width 42 mm					
	1	P	0.5 ... 10 bar	546818	VABF-S1-1-R1C2-C-10
	1	P	0.5 ... 6 bar	546817	VABF-S1-1-R1C2-C-6
	2	B	0.5 ... 10 bar	546822	VABF-S1-1-R2C2-C-10
	2	B	0.5 ... 6 bar	546821	VABF-S1-1-R2C2-C-6
	4	A	0.5 ... 10 bar	546820	VABF-S1-1-R3C2-C-10
	4	A	0.5 ... 6 bar	546819	VABF-S1-1-R3C2-C-6
	2 and 4	AB	0.5 ... 10 bar	546824	VABF-S1-1-R4C2-C-10
	2 and 4	AB	0.5 ... 6 bar	546823	VABF-S1-1-R4C2-C-6
	2 and 4, reversible	AB	0.5 ... 10 bar	546826	VABF-S1-1-R5C2-C-10
	2 and 4, reversible	AB	0.5 ... 6 bar	546825	VABF-S1-1-R5C2-C-6
	2, reversible	B	0.5 ... 10 bar	546828	VABF-S1-1-R6C2-C-10
	2, reversible	B	0.5 ... 6 bar	546827	VABF-S1-1-R6C2-C-6
	4, reversible	A	0.5 ... 10 bar	546830	VABF-S1-1-R7C2-C-10
	4, reversible	A	0.5 ... 6 bar	546829	VABF-S1-1-R7C2-C-6
Regulator plate, width 52 mm					
	1	P	0.5...10 bar	555758	VABF-S1-2-R1C2-C-10
	1	P	0.5...6 bar	555757	VABF-S1-2-R1C2-C-6
	2	B	0.5...10 bar	555760	VABF-S1-2-R2C2-C-10
	2	B	0.5...6 bar	555759	VABF-S1-2-R2C2-C-6
	4	A	0.5...10 bar	555762	VABF-S1-2-R3C2-C-10
	4	A	0.5...6 bar	555761	VABF-S1-2-R3C2-C-6
	2 and 4	AB	0.5...10 bar	555764	VABF-S1-2-R4C2-C-10
	2 and 4	AB	0.5...6 bar	555763	VABF-S1-2-R4C2-C-6
	2 and 4, reversible	AB	0.5...10 bar	555766	VABF-S1-2-R5C2-C-10
	2 and 4, reversible	AB	0.5...6 bar	555765	VABF-S1-2-R5C2-C-6
	2, reversible	B	0.5...10 bar	555768	VABF-S1-2-R6C2-C-10
	2, reversible	B	0.5...6 bar	555767	VABF-S1-2-R6C2-C-6
	4, reversible	A	0.5...10 bar	555770	VABF-S1-2-R7C2-C-10
	4, reversible	A	0.5...6 bar	555769	VABF-S1-2-R7C2-C-6

Manifold components, to ISO 5599-1

Vertical stacking

Flow control plate
VABF-S1-...-F1B1-C

Material:
 Housing: Die-cast aluminium

-  Temperature range
 -5 ... +50 °C
-  Pressure
 -0,9 ... 10 bar

Note on materials:
 RoHS-compliant



Dimensions

Download CAD data → www.festo.com/en/engineering

Flow control plate

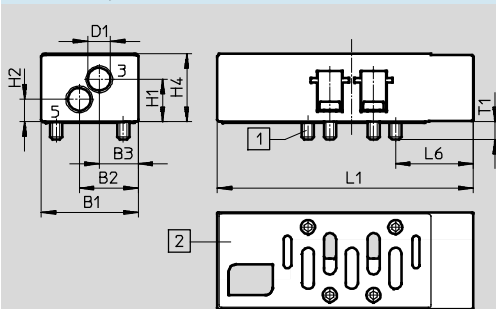

- 1 Captive screws M5x12 (width 42 mm) or M6x16 (width 52 mm)
- 2 Port pattern to ISO 5599-1

Flow control plate with manifold sub-base and solenoid valve

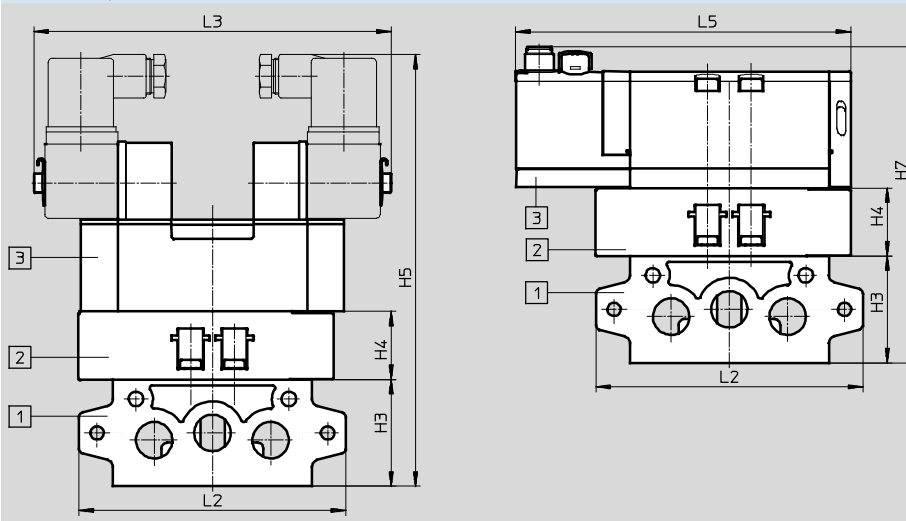

- 1 Manifold sub-base NAV
- 2 Flow control plate
- 3 Solenoid valve

Type	B1	B2	B3	∅D1	H1	H2	H3	H4	H5	H7	L1	L2	L3	L5	L6	T1
VABF-S1-1-F1B1-C	39.9	24.3	16.1	9.3	17.5	9.2	44	28	178	130.3	105.3	110	147.3	137.8	32	7.3
VABF-S1-2-F1B1-C	52	32.5	22.5	13.4	29.5	13.5	45	45	206	148.3	131	135	165	160.7	40.9	10

Ordering data

Description	Width	Standard nominal flow rate [l/min]	Weight [g]	Part No.	Type
For exhaust air flow control in ports 3 and 5 of the valve	42 mm	1,100	220	549102	VABF-S1-1-F1B1-C
	52 mm	-	565	555788	VABF-S1-2-F1B1-C



Manifold components, to ISO 5599-1

Vertical stacking

FESTO

Vertical supply plate
VABF-S1-...-P1A3

Material:
Housing: Die-cast aluminium

-  Temperature range
-5 ... +50 °C
-  Pressure
-0,9 ... 10 bar

Note on materials:
RoHS-compliant



Dimensions

Download CAD data → www.festo.com/en/engineering

Vertical supply plate

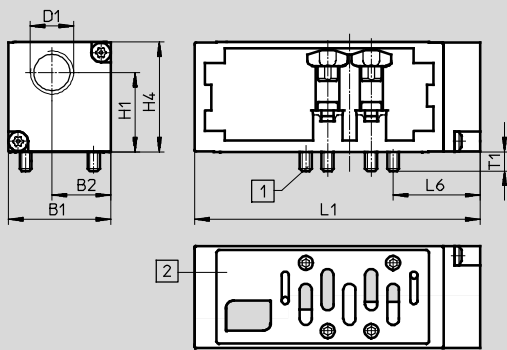

- 1 Captive screws M5x25
(width 42 mm) or M6x30
(width 52 mm)
- 2 Port pattern to ISO 5599-1

Vertical supply plate with manifold sub-base and solenoid valve

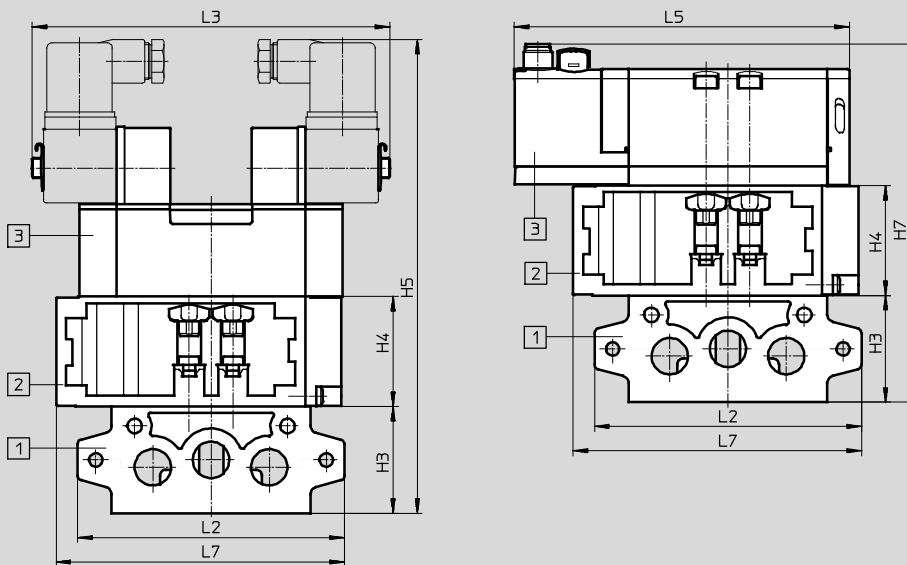

- 1 Manifold sub-base NAV
- 2 Vertical supply plate
- 3 Solenoid valve

Type	B1	B2	D1	H1	H3	H4	H5	H7	L1	L2	L3	L5	L6	L7	T1
VABF-S1-1-P1A3-G38	42.1	24.2	G3/8	32.7	44	45.3	195.3	147.6	117.6	110	147.3	137.8	35.8	118.8	7.9
VABF-S1-2-P1A3-G12	54	31	G1/2	42.4	45	58.9	219.9	162.2	136	135	165	160.7	38	141.5	10

Ordering data



Description	Width	Standard nominal flow rate [l/min]	Weight [g]	Part No.	Type
For independently supplying working air to a valve	42 mm	1,300	340	549100	VABF-S1-1-P1A3-G38
	52 mm	2,800	605	555785	VABF-S1-2-P1A3-G12

Manifold components, to ISO 5599-1

Vertical stacking

Vertical pressure shut-off plate
VABF-S1-...-L1D1-C

Material:
 Housing: Die-cast aluminium

-  Temperature range
 -5 ... +50 °C
-  Pressure
 -0,9 ... 10 bar

Note on materials:
 RoHS-compliant



Dimensions

Download CAD data → www.festo.com/en/engineering

Vertical pressure shut-off plate

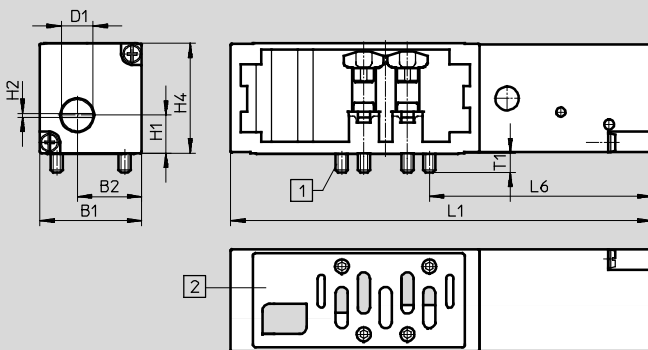

- 1 Captive screws M5x25 (width 42 mm) or M6x30 (width 52 mm)
- 2 Port pattern to ISO 5599-1

Vertical pressure shut-off plate with manifold sub-base and solenoid valve

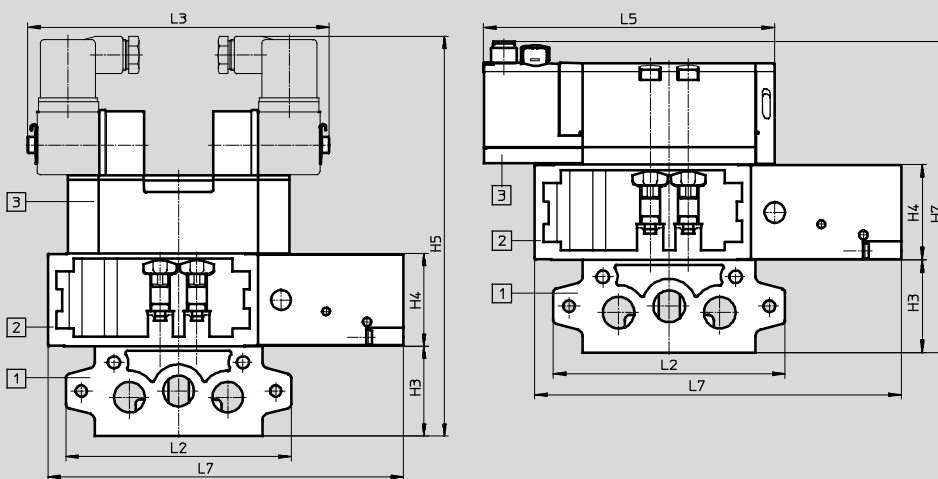

- 1 Manifold sub-base NAV
- 2 Vertical pressure shut-off plate
- 3 Solenoid valve

Type	B1	B2	D1	H1	H2	H3	H4	H5	H7	L1	L2	L3	L5	L6	L7	T1
VABF-S1-1-L1D1-C	42.1	26.7	12.8	15.6	1.6	44	45.3	195.3	147.6	173.8	110	147.3	137.8	92	173.8	7.9
VABF-S1-2-L1D1-C	54	32.6	14	21.3	1.6	45	58.7	219.7	162	191.2	135	165	160.7	93.2	191.2	10







Ordering data

Description	Width	Standard nominal flow rate [l/min]	Weight [g]	Part No.	Type
For shutting off a valve from the supply pressure	42 mm	1,200	600	549103	VABF-S1-1-L1D1-C
	52 mm	1,950	1,030	555790	VABF-S1-2-L1D1-C

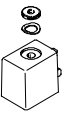
Solenoid valves, to ISO 5599-1

Accessories

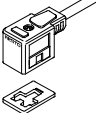

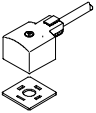





FESTO

Ordering data					
Description			Part No.	Type	
Solenoid coils					
	Type F for valves MFH, JMFH	12 V DC	34410	MSFG-12DC-OD	
		24 V DC and 42 V AC, 50 ... 60 Hz	34411	MSFG-24/42-50/60-OD	
		42 V DC	34413	MSFG-42DC-OD	
		24 V AC	34415	MSFG-24AC-OD	
		48 V AC, 50 ... 60 Hz	34418	MSFW-48AC-OD	
		110 V AC, 50 ... 60 Hz and 120 V AC, 60 Hz	34420	MSFW-110AC-OD	
		230 V AC, 50 ... 60 Hz and 240 V AC, 60 Hz	34422	MSFW-230AC-OD	
		240 V AC, 50 ... 60 Hz	34424	MSFW-240AC-OD	
	Type N1 for valves MN1H, JMN1H	24 V DC	123060	MSN1G-24DC-OD	
		12 V DC and 24 V AC, 50 ... 60 Hz	170152	MSN1W-24AC/12DC	
		110 V AC, 50 ... 60 Hz	123061	MSN1W-110AC-OD	
		230 V AC, 50 ... 60 Hz	123062	MSN1W-230AC-OD	
Plug sockets, plug sockets with cable for F solenoid coils					
	Plug socket		34431	MSSD-F	
			59710	MSSD-F-M16	
	Plug socket with insulation displacement technology		192746	MSSD-F-S-M16	
	Plug socket with cable	24 V DC, switching status display via LED	Cable length 2.5 m	30935	KMF-1-24DC-2,5-LED
			Cable length 5 m	30937	KMF-1-24DC-5-LED
			Cable length 10 m	193458	KMF-1-24DC-10-LED
		Up to 240 V, without switching status display	Cable length 2.5 m	30936	KMF-1-230AC-2,5
			Cable length 5 m	30938	KMF-1-230AC-5
Plug sockets, plug sockets with cable for N1 and D solenoid coils					
	Plug socket		34583	MSSD-C	
	Plug socket without cable with insulation displacement technology		192748	MSSD-C-S-M16	
	Plug socket with cable	24 V DC, switching status display via LED	Cable length 2.5 m	30931	KMC-1-24DC-2,5-LED
			Cable length 5 m	30933	KMC-1-24DC-5-LED
			Cable length 10 m	193459	KMC-1-24DC-10-LED
		Up to 230 V, without switching status display	Cable length 2.5 m	30932	KMC-1-230AC-2,5
			Cable length 5 m	30934	KMC-1-230AC-5

Solenoid valves, to ISO 5599-1

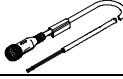
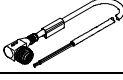
Accessories

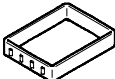
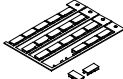
FESTO

Ordering data			
	Description	Part No.	Type
Illuminating seal			
	For F solenoid coils	12 ... 24 V DC	19143 MF-LD-12-24DC
		230 V DC/V AC	19144 MF-LD-230AC
	For N1 solenoid coils	12 ... 24 V DC	19145 MC-LD-12-24DC
		230 V DC/V AC	19146 MC-LD-230AC
Plug sockets, connecting cables for VSVA			
	Angled socket 4-pin M12x1	185498	SEA-M12-4WD-PG7
	Connecting cable, straight plug 4-pin M12x1, angled socket 4-pin	1 m	185499 KM-12-M12-GSWD-1-4
	Connecting cable, straight socket 5-pin M12x1, open end 4-wire	2.5 m	550326 NEBU-M12G5-K-2,5-LE4
		5 m	541328 NEBU-M12G5-K-5-LE4
	Connecting cable, angled socket 5-pin M12x1, open end 4-wire	2.5 m	550325 NEBU-M12W5-K-2,5-LE4
		5 m	541329 NEBU-M12W5-K-5-LE4
Pressure gauge			
	With cartridge connection for regulator	10 bar	543487 PAGN-26-16-P10
		6 bar	543488 PAGN-26-10-P10
Seal			
	Enables the VSVA valves to be assembled on sub-bases of the valve terminal VTSA (2 included in the scope of delivery)	571343	VABD-S2-1-S-C
Inscription label			
	Inscription label for valves VSVA (24 in frames included in scope of delivery)	18182	IBS-9x20
	Clip-on inscription label holder for valve cap (5 included in scope of delivery)	540888	ASCF-T-S6
Manual override			
	Tool for manual override for MN1H/MFH valves	157651	AHB-MD/MF/MV