

Parallel grippers HGPT-B, heavy-duty

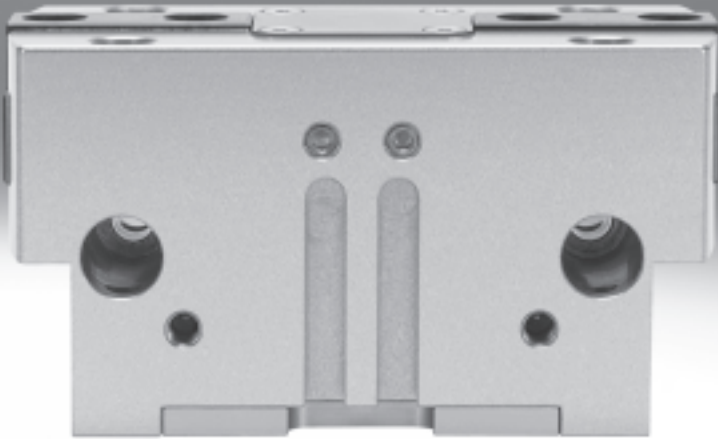

Parallel grippers HGPT-B, heavy-duty

Key features

Advantages compared with the parallel gripper HGPT

- Space-optimised:**
 Choice of shorter housing without gripping force retention or longer housing with gripping force retention
- Increased gripping force/ high-force variant:**
 Gripping force increased by 30% by means of oval piston. High-force variant also available: half the stroke, twice the force
- Reduced weight:**
 Systematic use of lighter and higher performance materials
- 4 sensor slots:**
 Proximity sensors no longer project past the bottom of the housing. Up to four positions can be sensed with the proximity sensors

At a glance

General information

Sturdy and precise kinematic system for maximum torque absorption and long service life. The force generated by the linear motion is translated into the gripper jaw movement via a wedge mechanism

with guided motion sequence. This also guarantees synchronous movement of the gripper jaws. The virtually backlash-free plain-bearing guide is realised using ground-in gripper jaws.

Flexible range of applications

A wide range of uses:

- Can be used as either a double-acting or single-acting gripper
- Compression spring for supplementary or retaining gripping forces
- Suitable for external and internal gripping
- Centring either via centring pins or centring sleeves

The technology in detail

Gripper closed

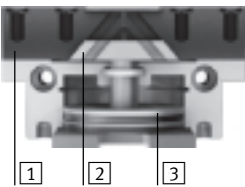

Gripper open



- 1 Gripper jaw
- 2 Wedge with restricted guidance
- 3 Piston with magnet

Additional connections

For sealing air

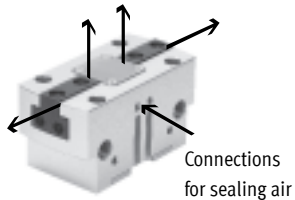

Compressed air flows past the gripper jaw when sealing air (max. 0.5 bar) is connected. This prevents, for example, dust particles from entering the gripper jaw guides.

For lubrication

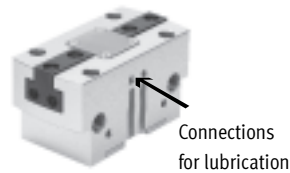

The connections can also be used for relubricating the guide.

Position sensing/force control

With position transmitter SMAT-8M



Infinite position sensing possible

- Analogue output 0 ... 10 V

With proportional pressure regulator VPPM



Infinite adjustment of the gripping force possible

- Setpoint input
 - 0 ... 10 V
 - 4 ... 20 mA

With proximity sensor SMT-8G/-10G



Multiple positions can be sensed:

- Open
- Closed
- Workpiece gripped

Parallel grippers HGPT-B, heavy-duty

Key features

Wide range of supply ports

Direct
From the front

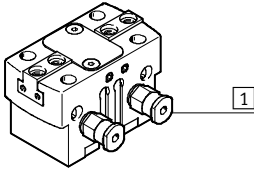

Via adapter plate
From underneath

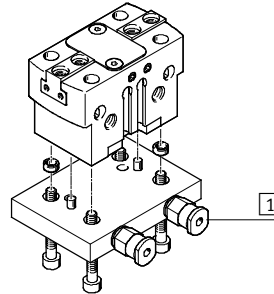

1 Supply ports

Mounting options

Direct mounting
From above

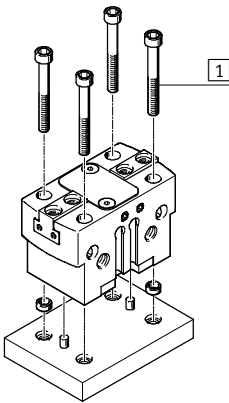

From underneath or from the side

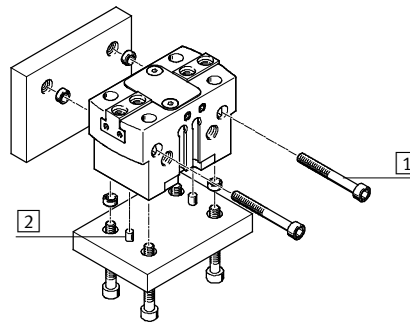

1 Mounting screws
2 Centring pins, centring sleeves

Note
These grippers are not suitable or are of limited suitability for the following application examples:

Not suitable for:

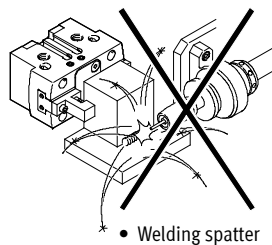

- Welding spatter

Of limited suitability for:

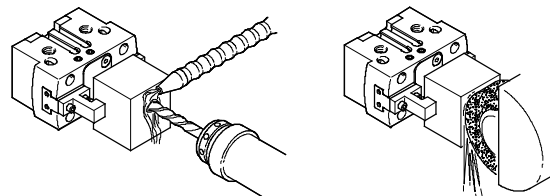

- Machining with sealing air possible
- Aggressive media only possible after consultation with Festo

Parallel grippers HGPT-B, heavy-duty

Key features

FESTO

System product for handling and assembly technology

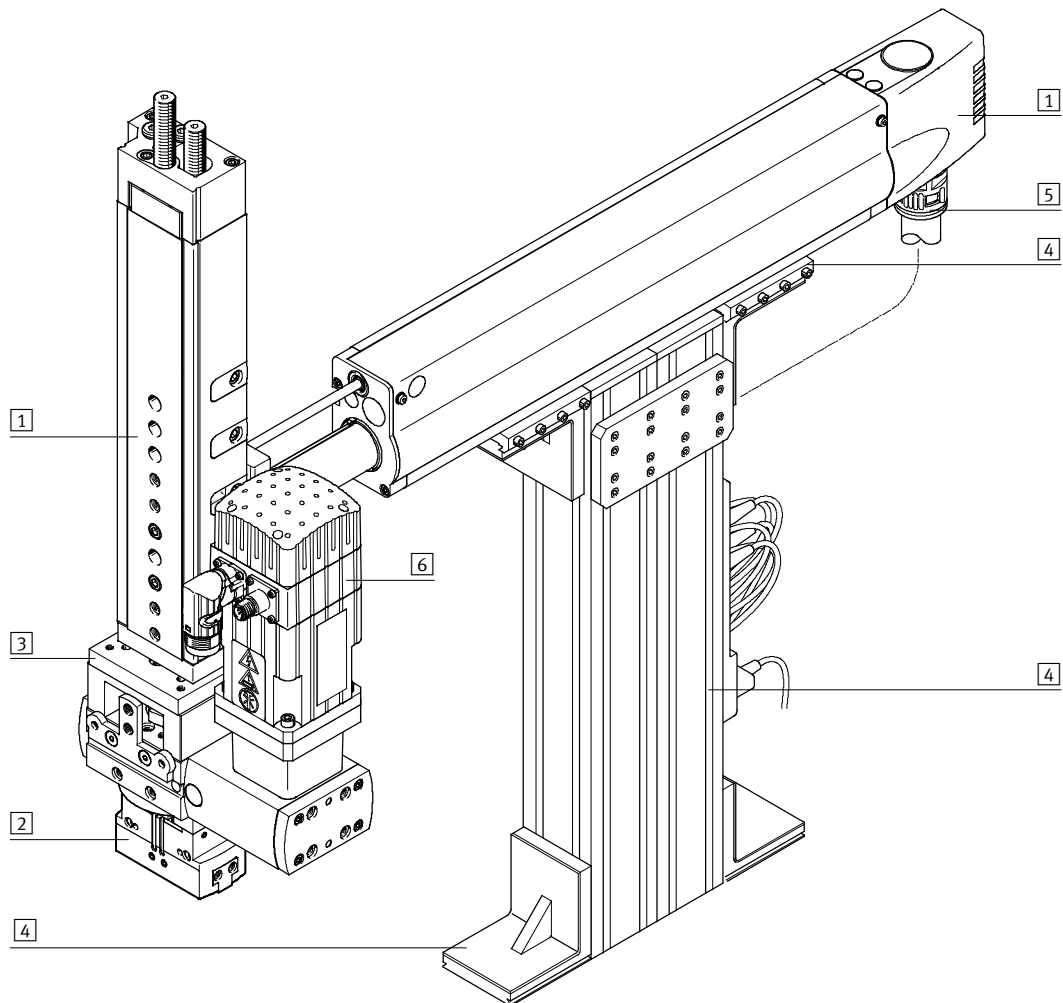

System components and accessories		
	Brief description	→ Page/Internet
1	Drives	Wide range of combinations possible within handling and assembly technology drive
2	Grippers	Wide range of variations possible within handling and assembly technology gripper
3	Adapters	For drive/drive and drive/gripper connections adapter kit
4	Basic components	Profiles and profile connections as well as profile/drive connections basic component
5	Installation components	For a clear, safe layout of electrical cables and tubing installation component
6	Motors	Servo and stepper motors, with or without gearing motor
-	Axes	Wide range of combinations possible within handling and assembly technology axis

Parallel grippers HGPT-B, heavy-duty

Peripherals overview

FESTO

Peripherals overview

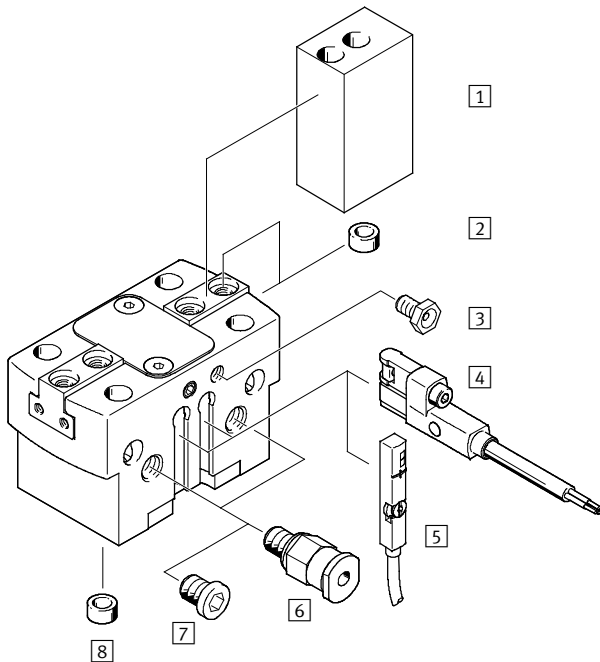

System product for handling and assembly technology

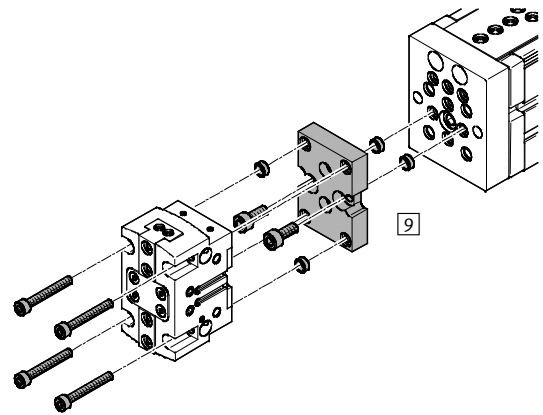

Proportional pressure regulator VPPM

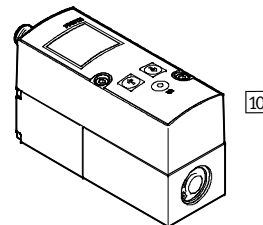

Accessories			
Type	Brief description	→ Page/Internet	
1	Gripper jaw blank BUB-HGPT	Blank specially matched to the gripper jaws for custom production of gripper fingers	22
2	Centring sleeve ZBH	<ul style="list-style-type: none"> For centring gripper jaw blanks/gripper fingers on the gripper jaws Centring sleeves are included in the scope of delivery of the gripper 	23
3	Lubrication nipple	Included in the scope of delivery of the gripper	-
4	Proximity sensor SMT-8G/-10G	<ul style="list-style-type: none"> For sensing the piston position The proximity sensor is flush with the housing at the bottom 	23
5	Position transmitter SMAT-8M	<ul style="list-style-type: none"> Continuously senses the position of the piston. It has an analogue output with an output signal that is proportional to the piston position. For size 40 ... 80 	24
6	Push-in fitting QS	For connecting compressed air tubing with standard O.D.	quick star
7	Blanking plug B	For sealing the supply ports when using the lower supply ports	23
8	Centring sleeve ZBH	For centring the gripper during mounting	23
9	Adapter kit HMSV, HAPG	Drive/gripper connections	19
10	Proportional pressure regulator VPPM	For infinite adjustment of the gripping force	vppm

Parallel grippers HGPT-B, heavy-duty

Type codes

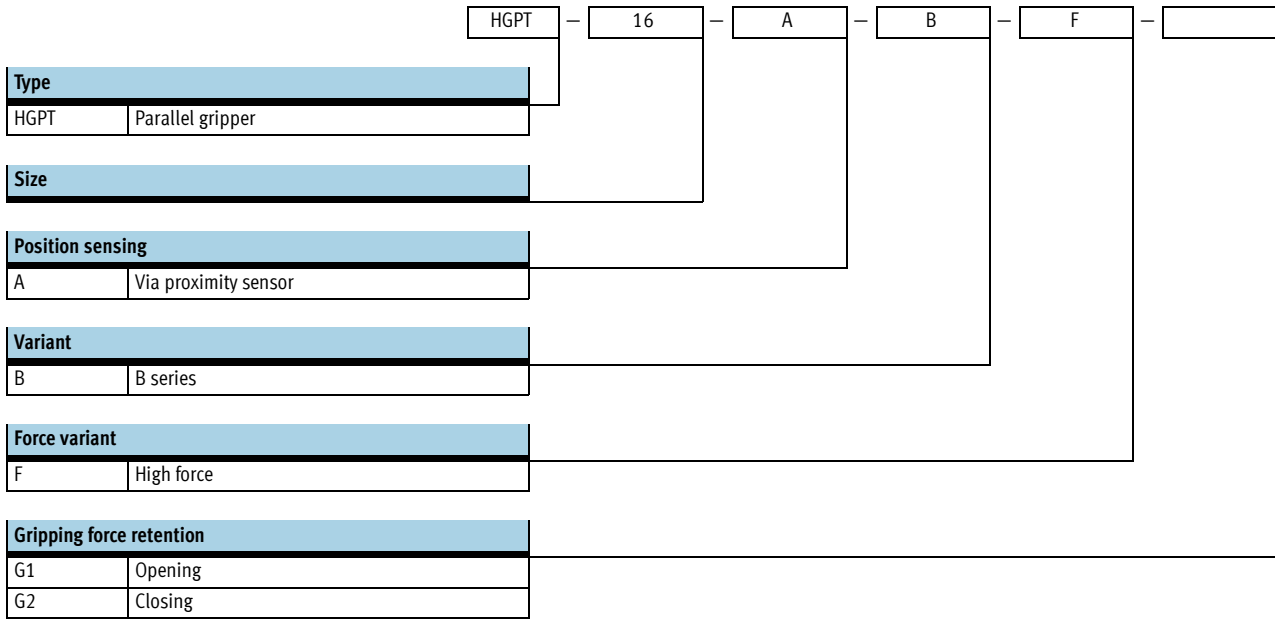

Parallel grippers HGPT-B, heavy-duty

Technical data

Function

Double-acting

HGPT-...

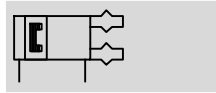

⌀ - Size
16 ... 80 mm

— Total stroke
3 ... 50 mm

Function – Variants

Single-acting or
with gripping force retention ...

... opening HGPT-...-G1



... closing HGPT-...-G2

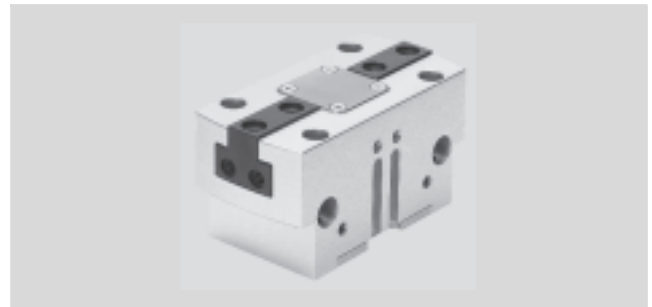

General technical data										
Size	16	20	25	35	40	50	63	80		
Design	Wedge mechanism									
	Guided motion sequence									
Mode of operation	Double-acting									
Gripper function	Parallel									
Number of gripper jaws	2									
Max. load per external gripper finger ¹⁾	[g]	40	50	110	180	310	640	1,260	1,830	
Stroke per gripper jaw	HGPT-...-A	[mm]	3	4	6	8	10	12	16	25
	HGPT-...-A-F	[mm]	1.5	2	3	4	5	6	8	12.5
Pneumatic connection		M5	M5	M5	M5	M5	G ¹ / ₈	G ¹ / ₈	G ¹ / ₄	
Pneumatic connection, sealing air		M3	M3	M5	M5	M5	M5	M5	M5	
Repetition accuracy ²⁾	[mm]	±0.01	±0.02	±0.025						
Max. interchangeability	[mm]	0.2								
Max. operating frequency	[Hz]	3				2				
Rotational symmetry	[mm]	< Ø 0.2								
Position sensing		Via proximity sensor, position transmitter								
Type of mounting		Via through-hole and locating pin/centring sleeve								
		Via female thread and locating pin/centring sleeve								
Mounting position		Any								

1) Valid for unthrottled operation

2) End-position drift under constant conditions of use with 100 consecutive strokes in the direction of movement of the gripper jaws

- | - Note: This product conforms to ISO 1179-1 and to ISO 228-1

Operating and environmental conditions			
Min. operating pressure	HGPT-...-A	[bar]	3
	HGPT-...-A-G	[bar]	4
Max. operating pressure		[bar]	8
Operating pressure, sealing air		[bar]	0 ... 0.5
Operating medium	Compressed air in accordance with ISO 8573-1:2010 [7:4:4]		
Note on operating/pilot medium	Operation with lubricated medium possible (in which case lubricated operation will always be required)		
Ambient temperature ¹⁾		[°C]	+5 ... +60
Corrosion resistance class CRC ²⁾	2		

1) Note operating range of proximity sensors.

2) Corrosion resistance class 2 according to Festo standard 940 070

Components subject to moderate corrosion stress. Externally visible parts with primarily decorative surface requirements which are in direct contact with a normal industrial environment or media such as coolants or lubricating agents.

Parallel grippers HGPT-B, heavy-duty

Technical data

Weight [g]								
Size	16	20	25	35	40	50	63	80
HGPT-...-A	85	135	266	490	821	1,400	2,712	4,745
HGPT-...-A-F	85	135	266	490	821	1,400	2,712	4,745
HGPT-...-A-G	100	155	353	567	1,075	1,832	3,562	6,287

Materials

Sectional view

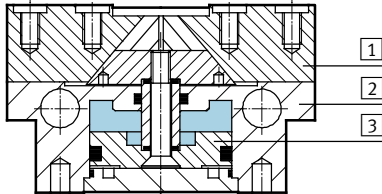

Parallel gripper	
1 Gripper jaw	Hardened steel
2 Housing	Hard anodised wrought aluminium alloy
3 Piston	Hard anodised aluminium
- Seals	Nitrile rubber
- Note on materials	Free of copper, PTFE and silicone
	RoHS-compliant

Gripping force [N] at 6 bar

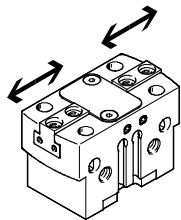

Size		16	20	25	35	40	50	63	80
Gripping force per gripper jaw									
HGPT-...-A	Opening	60	82	133	245	355	570	896	1,613
	Closing	53	77	124	229	331	535	851	1,551
HGPT-...-A-F	Opening	108	172	238	500	723	1,185	1,885	3,275
	Closing	96	161	221	467	674	1,113	1,791	3,150
Total gripping force									
HGPT-...-A	Opening	120	162	266	490	710	1,140	1,792	3,226
	Closing	106	154	248	458	662	1,070	1,702	3,102
HGPT-...-A-F	Opening	216	344	476	1,000	1,446	2,370	3,770	6,550
	Closing	192	322	442	934	1,328	2,226	3,522	6,300

Parallel grippers HGPT-B, heavy-duty

Technical data

Characteristic load values at the gripper jaws

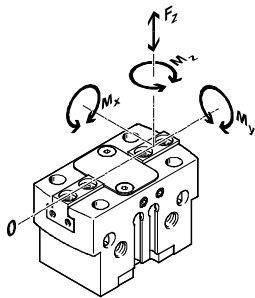

The indicated permissible forces and torques apply to a single gripper jaw. They include the lever arm, additional applied loads due to the workpiece or gripper fingers and acceleration

forces occurring during movement. The zero co-ordinate line (gripper jaw guide) must be taken into consideration for the calculation of torques.

Size		16	20	25	35	40	50	63	80
Max. permissible force F_z	[N]	200	700	1,200	1,800	2,500	3,200	5,000	7,000
Max. permissible torque M_x	[Nm]	10	15	50	80	100	120	160	180
Max. permissible torque M_y	[Nm]	12	15	45	60	90	120	180	220
Max. permissible torque M_z	[Nm]	6	8	35	50	75	100	140	170

Mass moment of inertia [$\text{kgm}^2 \times 10^{-4}$]

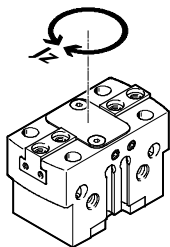

Mass moment of inertia of the parallel gripper in relation to the central axis, without external gripper fingers, without load.

Size		16	20	25	35	40	50	63	80
HGPT...-A		0.141	0.344	0.983	2.807	7.277	19.488	60.903	150.515
HGPT...-A-G		0.163	0.445	1.479	3.974	10.990	29.423	93.034	238.336

Gripper jaw backlash

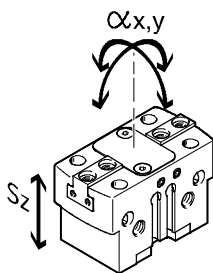

With grippers, backlash occurs between the gripper jaws and the housing due to the plain-bearing guide. The backlash values listed in the table have been calculated based on the traditional accumulative tolerance method.

Size		16	20	25	35	40	50	63	80
Max. gripper jaw backlash S_z	[mm]	0.02							
Max. gripper jaw angular backlash α_x, α_y	[°]	0.1							

Parallel grippers HGPT-B, heavy-duty

Technical data



Opening and closing times [ms] at 6 bar

Without external gripper fingers

With external gripper fingers

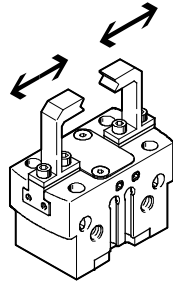
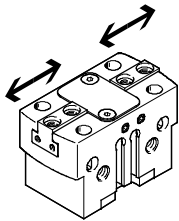

The indicated opening and closing times [ms] have been measured at room temperature at an operating pressure of 6 bar with horizontally mounted gripper without additional

gripper fingers. The grippers must be throttled for greater loads [g]. Opening and closing times must then be adjusted accordingly.

Size		16	20	25	35	40	50	63	80	
Without external gripper fingers										
Standard	HGPT-...-A	Opening	9	22	26	36	56	80	150	214
		Closing	11	30	32	67	60	85	156	213
	HGPT-...-A-G1	Opening	13	13	24	37	67	70	146	182
		Closing	31	25	48	114	135	153	328	353
	HGPT-...-A-G2	Opening	22	35	40	69	122	151	294	379
		Closing	15	18	28	87	71	77	185	176
High force	HGPT-...-A-F	Opening	8	28	25	33	60	83	143	212
		Closing	10	31	32	70	64	82	152	211
	HGPT-...-A-F-G1	Opening	19	13	24	35	71	70	145	180
		Closing	30	25	45	115	143	143	315	340
	HGPT-...-A-F-G2	Opening	33	38	36	63	120	137	308	362
		Closing	17	14	28	72	72	80	154	178
With external gripper fingers (as a function of the load)										
HGPT-...	50 g	10	-	-	-	-	-	-	-	
	100 g	15	30	-	-	-	-	-	-	
	200 g	21	42	35	-	-	-	-	-	
	300 g	-	52	42	42	-	-	-	-	
	400 g	-	-	49	49	63	-	-	-	
	500 g	-	-	-	55	71	-	-	-	
	600 g	-	-	-	-	78	-	-	-	
	800 g	-	-	-	-	90	90	-	-	
	1,000 g	-	-	-	-	-	95	-	-	
	1,200 g	-	-	-	-	-	100	-	-	
	1,500 g	-	-	-	-	-	-	164	-	
	1,800 g	-	-	-	-	-	-	179	-	
	2,000 g	-	-	-	-	-	-	189	223	
	2,200 g	-	-	-	-	-	-	-	234	
	2,400 g	-	-	-	-	-	-	-	244	

Parallel grippers HGPT-B, heavy-duty

Technical data

Gripping force F_H per gripper jaw as a function of operating pressure and lever arm x

The gripping forces as a function of operating pressure and lever arm can be determined from the following graphs.

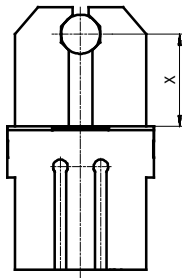

- 3 bar
- - - 6 bar
- · - 8 bar

Note

Gripper selection sizing software

→ www.festo.com

External gripping (closing)

Standard

HGPT-16-A

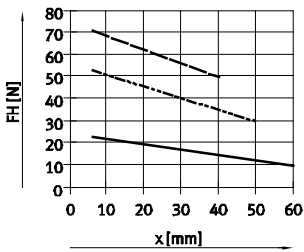

HGPT-20-A

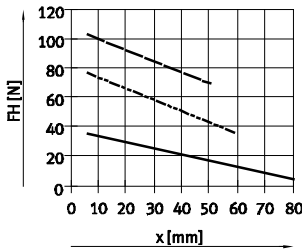

HGPT-25-A

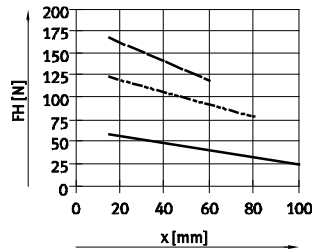

HGPT-35-A

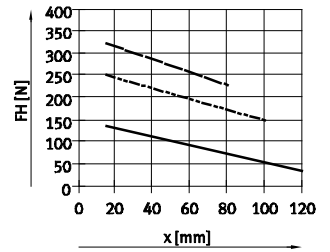

HGPT-40-A

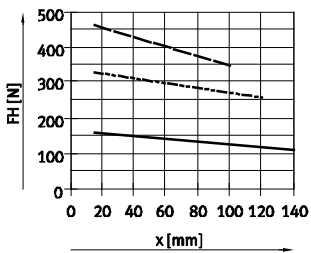

HGPT-50-A

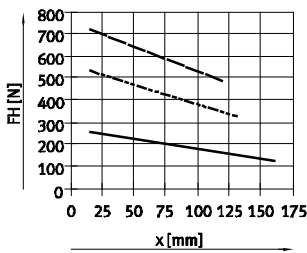

HGPT-63-A

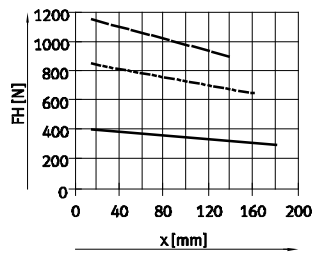

HGPT-80-A

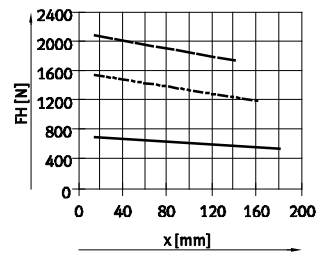

High force

HGPT-16-A-F

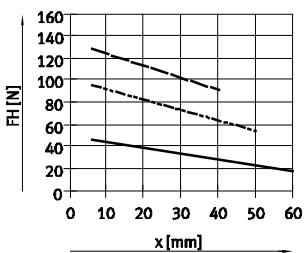

HGPT-20-A-F

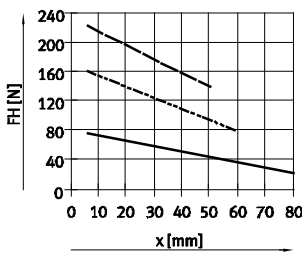

HGPT-25-A-F

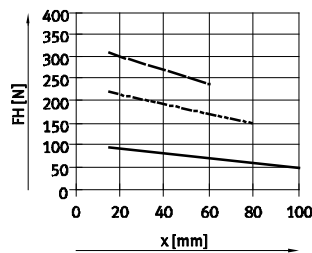

HGPT-35-A-F

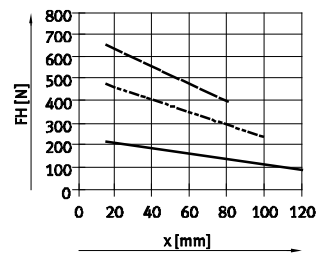

HGPT-40-A-F

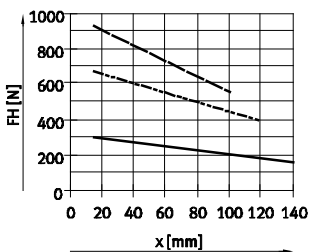

HGPT-50-A-F

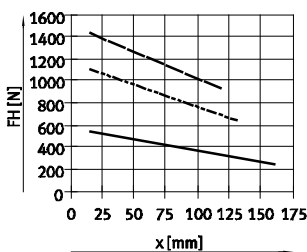

HGPT-63-A-F

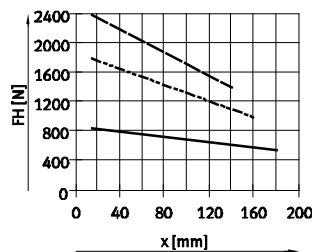

HGPT-80-A-F

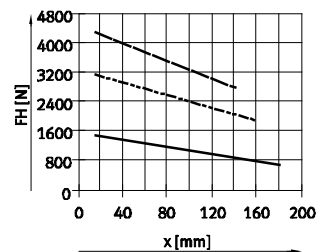

Parallel grippers HGPT-B, heavy-duty

Technical data

Gripping force F_H per gripper jaw at 6 bar as a function of lever arm x and eccentricity a and b

The following formula must be used to calculate the lever arm x with eccentric gripping:

$$x = \sqrt{a^2 + b^2}$$

The gripping force F_H can then be read from the graphs (→ from 11) using the calculated value x .

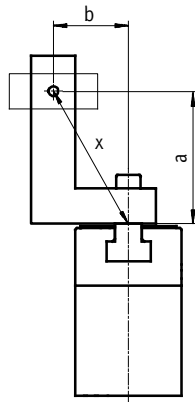

Calculation example

Given:

Distance $a = 45$ mm

Distance $b = 40$ mm

To be calculated:

The gripping force at 6 bar, with an HGPT-25, used as an external gripper

Procedure:

Calculate the lever arm x

$$x = \sqrt{45^2 + 40^2}$$

$x = 60$ mm

The graph (→ 11) gives a value of $F_H = 89$ N for the gripping force.

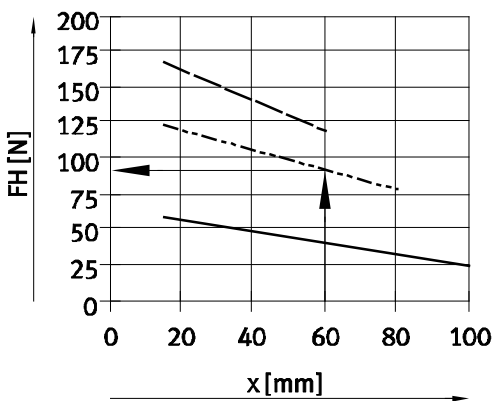

Parallel grippers HGPT-B, heavy-duty

Technical data

Spring force F_f as a function of size, gripper jaw stroke l

Gripping force retention for HGPT-...-G...

The spring forces F_f as a function of gripper jaw stroke l can be determined from the following graph.

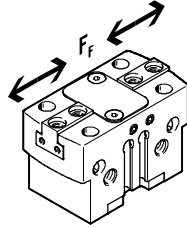

Standard

HGPT-...-A-G

Size 16 ... 35

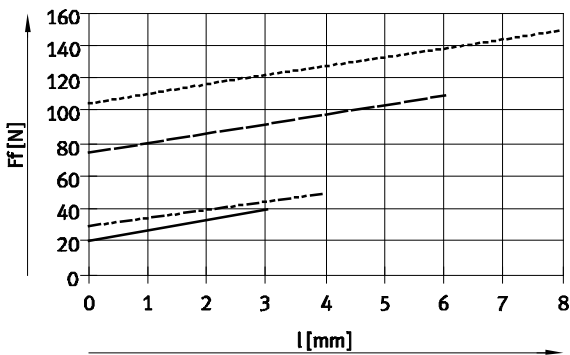

- HGPT-16-A-G
- - - HGPT-20-A-G
- HGPT-25-A-G
- - - HGPT-35-A-G

High force

HGPT-...-A-F-G

Size 16 ... 35

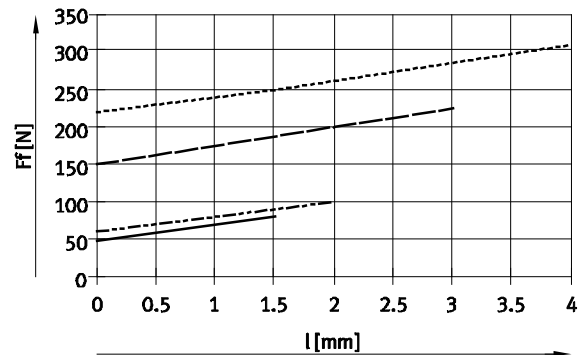

- HGPT-16-A-F-G
- - - HGPT-20-A-F-G
- HGPT-25-A-F-G
- - - HGPT-35-A-F-G

Size 40 ... 80

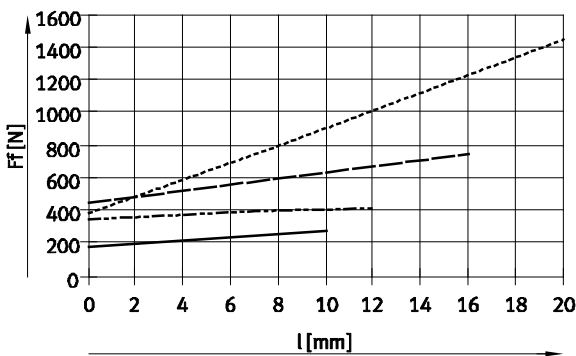

- HGPT-40-A-G
- - - HGPT-50-A-G
- HGPT-63-A-G
- - - HGPT-80-A-G

Size 40 ... 80

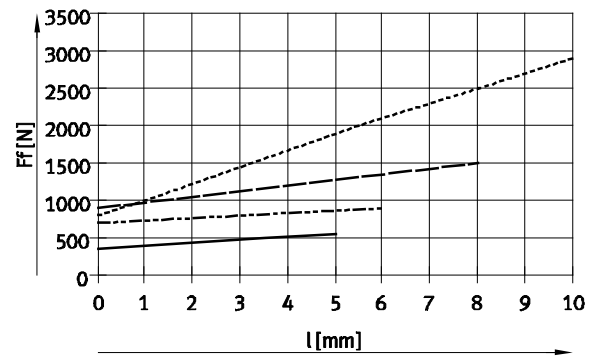

- HGPT-40-A-F-G
- - - HGPT-50-A-F-G
- HGPT-63-A-F-G
- - - HGPT-80-A-F-G

Parallel grippers HGPT-B, heavy-duty

Technical data

Spring force F_F as a function of size, gripper jaw stroke l and lever arm x per gripper finger

The lever arm x must be taken into consideration when determining the actual spring force F_{Ftotal} .
The formulae for calculating the spring force are provided in the table below.

Standard – HGPT-...-A-G

Gripping force retention	Size	$F_{Ftotal} =$	Gripping force retention	Size	$F_{Ftotal} =$
G1	16	$-0.1 * x + 0.7 * F_F$	G2	16	$-0.2 * x + 0.7 * F_F$
	20	$-0.05 * x + 0.9 * F_F$		20	$-0.65 * x + 0.9 * F_F$
	25	$-0.7 * x + 0.7 * F_F$		25	$-0.55 * x + 0.7 * F_F$
	35	$-0.65 * x + 0.7 * F_F$		35	$-0.05 * x + 0.7 * F_F$
	40	$-1.05 * x + 0.8 * F_F$		40	$-1.05 * x + 0.8 * F_F$
	50	$-0.75 * x + 0.8 * F_F$		50	$-1.4 * x + 0.8 * F_F$
	63	$-2 * x + 0.8 * F_F$		63	$-1.2 * x + 0.8 * F_F$
	80	$-1.4 * x + 0.6 * F_F$		80	$-0.6 * x + 0.6 * F_F$

High force – HGPT-...-A-F-G

Gripping force retention	Size	$F_{Ftotal} =$	Gripping force retention	Size	$F_{Ftotal} =$
G1	16	$-0.6 * x + 0.6 * F_F$	G2	16	$-0.4 * x + 0.6 * F_F$
	20	$-0.7 * x + 0.75 * F_F$		20	$-0.95 * x + 0.75 * F_F$
	25	$-0.85 * x + 0.9 * F_F$		25	$-0.5 * x + 0.9 * F_F$
	35	$-0.4 * x + 0.55 * F_F$		35	$-0.4 * x + 0.55 * F_F$
	40	$-1.9 * x + 0.75 * F_F$		40	$-2.3 * x + 0.75 * F_F$
	50	$-2.5 * x + 0.7 * F_F$		50	$-1 * x + 0.7 * F_F$
	63	$-5.5 * x + 0.7 * F_F$		63	$-1 * x + 0.7 * F_F$
	80	$-5.65 * x + 0.8 * F_F$		80	$-0.5 * x + 0.8 * F_F$

Determination of the actual gripping forces F_{Gr} for HGPT-...-G1 and HGPT-...-G2 as a function of the application

The parallel grippers with integrated spring type HGPT-...-G1 (opening gripping force retention) and HGPT-...-G2 (closing gripping force retention) can be used as:

- single-acting grippers

- grippers with supplementary gripping force and
- grippers with gripping force retention depending on requirements.

In order to calculate available gripping forces F_{Gr} (per gripper jaw),

the gripping force (F_H) and spring force (F_{Ftotal}) must be combined accordingly.

Application

Single-acting	Supplementary gripping force	Gripping force retention
<ul style="list-style-type: none"> • Gripping with spring force: $F_{Gr} = F_{Ftotal}$ 	<ul style="list-style-type: none"> • Gripping with pressure and spring force: $F_{Gr} = F_H + F_{Ftotal}$ 	<ul style="list-style-type: none"> • Gripping with spring force: $F_{Gr} = F_{Ftotal}$
<ul style="list-style-type: none"> • Gripping with pressure force: $F_{Gr} = F_H - F_{Ftotal}$ 		

Parallel grippers HGPT-B, heavy-duty

Technical data

FESTO

Dimensions

Download CAD data → www.festo.com

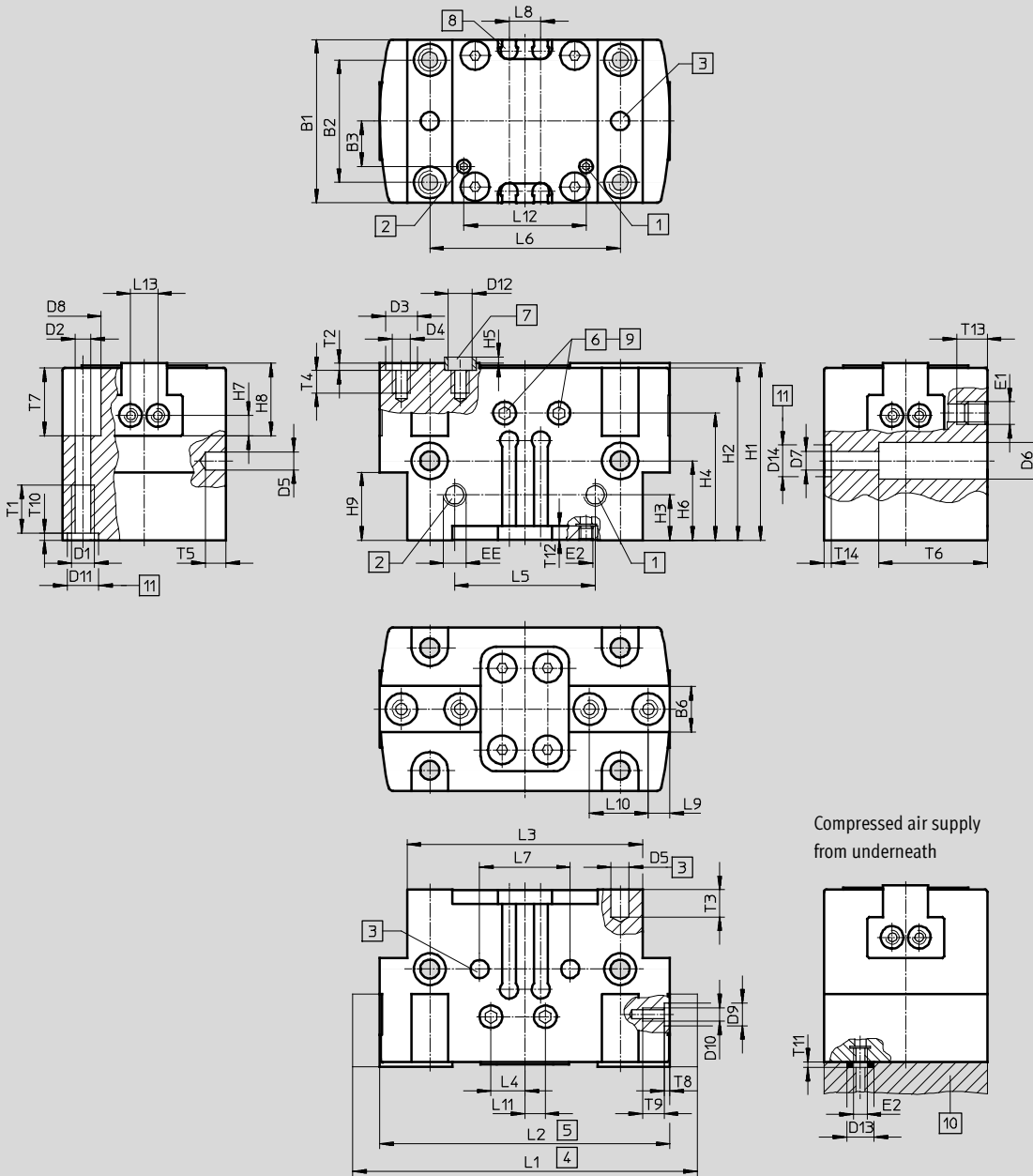

- 1 Supply port opening, either on the side or underneath (bottom port sealed on delivery)
- 2 Supply port closing, either on the side or underneath (bottom port sealed on delivery)

- 3 Hole for dowel pin (not included in the scope of delivery)
- 4 Gripper jaw open
- 5 Gripper jaw closed
- 6 Sealing air port (sealed on delivery)
- 7 Centring sleeves ZBH (4 included in the scope of delivery)

- 8 Slot for proximity sensor
- 9 Lubrication nipple (sealed on delivery)
- 10 O-ring for parallel gripper HGPT-16 ... 40: \varnothing 3x1.5 HGPT-50 ... 80: \varnothing 5x1.5
- 11 Hole for centring sleeve ZBH

Compressed air supply from underneath

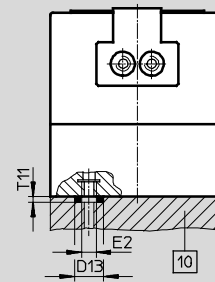

Parallel grippers HGPT-B, heavy-duty

Technical data

Size [mm]	B1 ±0.05	B2 ¹⁾	B3 ±0.1	B6 -0.05 -0.1	D1	D2 ∅	D3 ∅ H8/h7	D4	D5 ∅ H8	D6 ∅ ±0.1	D7 ∅	D8 ∅ +0.3	D9 ∅ H8	D10	D11 ∅ H8	D12 ∅
16	24	17	4	6	M3	2.6	5	M3	2	4.6	2.6	4.6	-	M2	5	3.2
20 ²⁾	28	22	8.7	6.5	M4	3.3	5	M3	3	6	3.2	6	5	M3	5	3.2
25	36	27	11	10	M5	4.2	7	M4	4	8	4.2	8	5	M3	7	5.3
35	42	32	13	12	M5	4.2	9	M5	4	9.2	5.3	8	7	M5	7	6.4
40	50	38	17	14	M6	5.1	9	M6	5	11	6.4	9	7	M5	9	6.4
50	60	45	20	15.5	M8	6.8	9	M6	6	13.5	8.4	11	7	M5	12	6.4
63	72	56	24.5	20	M8	6.8	12	M10	6	13.5	8.4	11	7	M5	12	10.3
80	100	70	39.5	22	M10	8.5	15	M12	8	16.5	10.2	13.5	9	M6	12	12.4

Size [mm]	D13 ∅	D14 ∅ H8/h7	EE	E1	E2	H1		H2		H3		H4		H5 -0.3	H6 ¹⁾	
						±0.05	-G ±0.05	±0.05	-G ±0.05	±0.1	-G ±0.1		-G			-G
16	6	-	M5	M3	M3	29	37	28	36	12	12	23.7	31.7	1.2	17.5	25.5
20	6	-	M5	M3	M3	31	38	30	37	10	15	23	30	1.2	14.5	21.5
25	6	7	M5	M5	M3	39	57	38	56	10	20	28	46	1.4	17.5	35.5
35	6	7	M5	M5	M3	49	67	48	66	12	30	36	54	1.9	20	38
40	6	9	M5	M5	M3	55	81	54	80	15	36	41	67	1.9	25	51
50	8	12	G½	M5	M5	63	93	62	92	15	30	47	77	1.9	30	60
63	8	12	G½	M5	M5	77	117	76	116	18	26	56	96	2.4	28	68
80	8	12	G¼	M5	M5	91	133	90	132	22	33	65	107	2.9	34	76

Size [mm]	H7 ¹⁾	H8 -0.02	H9		L1		L2 ±0.5	L3 ±0.1	L4 ±0.5	L5 ±0.1	L6 ¹⁾	L7 ¹⁾	L8 +0.1	L9 ¹⁾	L10 ¹⁾	L11 ±0.5
			±0.1	-G ±0.1	±0.5	-F ±0.5										
16	2.25	8.5	15	23	50	47	44	36	5.5	20	29	20	6	3	8	1
20	3	12	15	22	64	60	56	44	2.5	24	35	24	6	3.25	12	2.5
25	4.5	16	15	33	76	70	64	52	3.5	31	42	20	7	4.75	13	3.5
35	5.5	19	20	38	96	88	80	64	5.5	40	52	40	7	5.5	16	5.5
40	5.5	22	24	50	120	110	100	80	5.5	49	66	50	10	6.5	20	5.5
50	7.5	25.5	26	56	149	137	125	100	5.5	63	82	60	10	8	24	5.5
63	9	32	32	72	192	176	160	125	5.5	74	100	76	10	9.5	32	5.5
80	11	39	34	77	230	205	180	154	5.5	82	130	100	10	12	40	5.5

Size [mm]	L12 ±0.1	L13 ¹⁾	T1 min.	T2 +0.1	T3 min.	T4 min.	T5 min.	T6	T7		T8 +0.1	T9	T10 +0.1	T11	T12 min.	T13 min.	T14 +0.1
									+0.2	-G +0.2							
16	22	6	5.5	1.3	4	5	4	15	14	22	-	3	1.3	1.2	3	5.5	-
20	22.6	6	6.5	1.3	5	5.5	4	19	11	11	1.3	6	1.3	1.2	3	5.5	-
25	29	6	8.5	1.6	6	6.5	4.5	24	15	15	1.3	6	1.6	1.2	3	6.7	1.6
35	39	13	8.5	2.1	6	8.5	4.5	16	19	19	1.6	9	1.6	1.2	3	6.5	1.6
40	47.4	13	10.5	2.1	6	10.5	6	33	20	20	1.6	9	2.1	1.2	4	6.5	2.1
50	61	13	12.5	2.1	8	10.5	6	43	23	23	1.6	9	2.6	1.2	4	6.5	2.6
63	75	13	12.5	2.6	8	15.5	7	55	35	35	1.6	9	2.6	1.2	5	6.5	2.6
80	82	20	15	3.1	10	20	10	70	44	44	2.1	10	2.6	1.2	5.5	5	2.6

1) Tolerance for centring hole ±0.02 mm

Tolerance for thread ±0.1 mm

2) Dowel pins [3] must be used when mounted from below.

-|- Note: This product conforms to ISO 1179-1 and to ISO 228-1

Parallel grippers HGPT-B, heavy-duty

Technical data

Ordering data						
Size [mm]	Double-acting without compression spring		Single-acting or with gripping force retention			
	Part No.	Type	Opening		Closing	
	Part No.	Type	Part No.	Type	Part No.	Type
Standard						
16	560192	HGPT-16-A-B	560193	HGPT-16-A-B-G1	560194	HGPT-16-A-B-G2
20	560198	HGPT-20-A-B	560199	HGPT-20-A-B-G1	560200	HGPT-20-A-B-G2
25	560204	HGPT-25-A-B	560205	HGPT-25-A-B-G1	560206	HGPT-25-A-B-G2
35	560210	HGPT-35-A-B	560211	HGPT-35-A-B-G1	560212	HGPT-35-A-B-G2
40	560216	HGPT-40-A-B	560217	HGPT-40-A-B-G1	560218	HGPT-40-A-B-G2
50	560222	HGPT-50-A-B	560223	HGPT-50-A-B-G1	560224	HGPT-50-A-B-G2
63	560228	HGPT-63-A-B	560229	HGPT-63-A-B-G1	560230	HGPT-63-A-B-G2
80	560234	HGPT-80-A-B	560235	HGPT-80-A-B-G1	560236	HGPT-80-A-B-G2
High force						
16	560195	HGPT-16-A-B-F	560196	HGPT-16-A-B-F-G1	560197	HGPT-16-A-B-F-G2
20	560201	HGPT-20-A-B-F	560202	HGPT-20-A-B-F-G1	560203	HGPT-20-A-B-F-G2
25	560207	HGPT-25-A-B-F	560208	HGPT-25-A-B-F-G1	560209	HGPT-25-A-B-F-G2
35	560213	HGPT-35-A-B-F	560214	HGPT-35-A-B-F-G1	560215	HGPT-35-A-B-F-G2
40	560219	HGPT-40-A-B-F	560220	HGPT-40-A-B-F-G1	560221	HGPT-40-A-B-F-G2
50	560225	HGPT-50-A-B-F	560226	HGPT-50-A-B-F-G1	560227	HGPT-50-A-B-F-G2
63	560231	HGPT-63-A-B-F	560232	HGPT-63-A-B-F-G1	560233	HGPT-63-A-B-F-G2
80	560237	HGPT-80-A-B-F	560238	HGPT-80-A-B-F-G1	560239	HGPT-80-A-B-F-G2

Parallel grippers HGPT-B, heavy-duty



Accessories

FESTO

Adapter kit
DHAA, HAPG

Material:
Wrought aluminium alloy
Free of copper and PTFE
RoHS-compliant

 Note
The kit includes the individual mounting interface as well as the necessary mounting material.

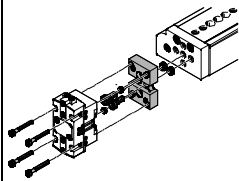
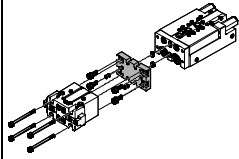
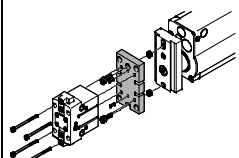
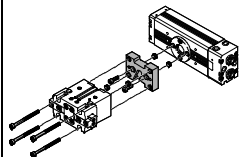
Permissible drive/gripper combinations with adapter kit					Download CAD data → www.festo.com	
Combination	Drive	Gripper	Mounting option		Adapter kit	
					CRC ¹⁾	Part No. Type
	DGSL	HGPT-B			DHAA, HAPG	
	8, 10	16, 20	■	■	2	564957 DHAA-G-G6-8-B8-16
	12, 16	16, 20	■	■		564954 DHAA-G-G6-16-B8-16
	12, 16	25	■	■		564952 DHAA-G-G6-16-B8-25
	20, 25	25, 35	■	■		537175 HAPG-79
	20, 25	40	■	■		564951 DHAA-G-G6-20-B8-40
	SLT	HGPT-B			DHAA, HAPG	
	6	16	■	–	2	537168 HAPG-74
	10	16, 20	■	–		564957 DHAA-G-G6-8-B8-16
	16	16, 20	■	–		564954 DHAA-G-G6-16-B8-16
	16	25	■	–		564952 DHAA-G-G6-16-B8-25
	20	25, 35	■	–		537175 HAPG-79
	25	35	■	–		564953 DHAA-G-H2-20-B8-35
	25	40	■	–		564951 DHAA-G-G6-20-B8-40
	HMP	HGPT-B			DHAA, HAPG	
	16	25	–	■	2	537178 HAPG-81
	20, 25	35	–	■		564953 DHAA-G-H2-20-B8-35
	20, 25	40	–	■		537182 HAPG-84
	25, 32	50	–	■		537185 HAPG-86
	32	63	–	■		537187 HAPG-87
	DRQD-...	HGPT-B			DHAA, HAPG	
	12, 16	16	■	■	2	564958 DHAA-G-Q5-12-B8-16
	12, 16	20	■	■		564955 DHAA-G-Q5-16-B8-20
	16, 20	25	■	■		537181 HAPG-SD2-25
	20, 25	35	■	■		537173 HAPG-SD2-23
	25, 32	40	■	■		537184 HAPG-SD2-26
	32, 40	50	■	■		564956 DHAA-G-Q5-32-B8-50
	40, 50	63	■	■		537188 HAPG-SD2-28
	DRQD-E422	HGPT-B			DHAA, HAPG	
	16	16, 20	■	■	2	564959 DHAA-G-Q5-16-B8-16
	16, 20	25	■	■		544642 HAPG-SD2-48
	20	35	■	■		544642 HAPG-SD2-48
	DRQD-E444	HGPT-B			HAPG	
32	50	■	■	2	544643 HAPG-SD2-49	

1) Corrosion resistance class 2 according to Festo standard 940 070
Components subject to moderate corrosion stress. Externally visible parts with primarily decorative surface requirements which are in direct contact with a normal industrial environment or media such as coolants or lubricating agents.

Parallel grippers HGPT-B, heavy-duty



Accessories



Adapter kit
DHAA, HAPG

Material:
Wrought aluminium alloy
Free of copper and PTFE
RoHS-compliant

 Note
The kit includes the individual mounting interface as well as the necessary mounting material.

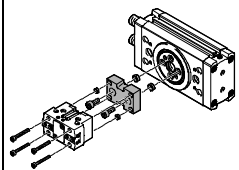
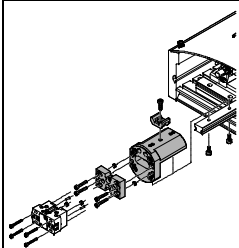
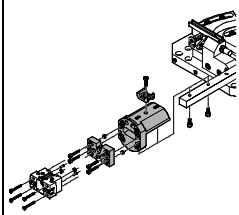
Permissible drive/gripper combinations with adapter kit						Download CAD data → www.festo.com	
Combination	Drive Size	Gripper Size	Mounting option		Adapter kit		
					CRC ¹⁾	Part No.	Type
DRRD/HGPT-B	DRRD	HGPT-B			DHAA		
	16	16	■	■	2	2091740	DHAA-G-Q11-16-B8-16
	16	20	■	■		2091577	DHAA-G-Q11-16-B8-20
	16	25	■	■		2090543	DHAA-G-Q11-16-B8-25
	20	25	■	■		2088114	DHAA-G-Q11-20-B8-25
	20	35	■	■		2087524	DHAA-G-Q11-20-B8-35
	25	35	■	■		1731604	DHAA-G-Q11-25-B8-35
	25	40	■	■		1731735	DHAA-G-Q11-25-B8-40
	32	40	■	■		2092070	DHAA-G-Q11-32-B8-40
	35	40	■	■		2114241	DHAA-G-Q11-35-B8-40
	32	50	■	■		2118750	DHAA-G-Q11-32-B8-50
	35, 40	50	■	■		2124990	DHAA-G-Q11-35/40-B8-50
	40	63	■	■		2125264	DHAA-G-Q11-40-B8-63
	HSP/HGPT-B	HSP	HGPT-B				DHAA, HAPG
	12	16	■	-	2	564957	DHAA-G-G6-8-B8-16
	16	16, 20	■	-		540881	HAPG-70-B
						564957	DHAA-G-G6-8-B8-16
	25	16, 20	■	-		540882	HAPG-71-B
				564957	DHAA-G-G6-8-B8-16		
				540883	HAPG-72-B		
HSW/HGPT-B	HSW	HGPT-B			DHAA, HAPG		
	12	16	■	-	2	564957	DHAA-G-G6-8-B8-16
	16	16, 20	■	-		540882	HAPG-71-B
						564957	DHAA-G-G6-8-B8-16
				540882	HAPG-71-B		

1) Corrosion resistance class 2 according to Festo standard 940 070
Components subject to moderate corrosion stress. Externally visible parts with primarily decorative surface requirements which are in direct contact with a normal industrial environment or media such as coolants or lubricating agents.

Parallel grippers HGPT-B, heavy-duty



Accessories

FESTO

Adapter kit
DHAA, HAPG

Material:
Wrought aluminium alloy
Free of copper and PTFE
RoHS-compliant

 Note
The kit includes the individual mounting interface as well as the necessary mounting material.

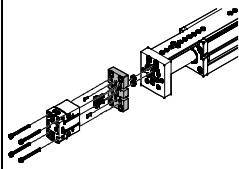
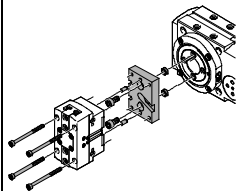
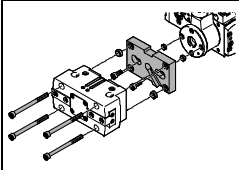
Permissible drive/gripper combinations with adapter kit						Download CAD data → www.festo.com	
Combination	Drive Size	Gripper Size	Mounting option		Adapter kit		
					CRC ¹⁾	Part No.	Type
EGSL/HGPT-B	EGSL	HGPT-B				DHAA, HAPG	
	45, 55	25	■	■	2	564952	DHAA-G-G6-16-B8-25
	75	40	■	■		564951	DHAA-G-G6-20-B8-40
	75	25, 35	■	■		537175	HAPG-79
ERMB/HGPT-B	ERMB	HGPT-B				DHAA, HAPG	
	20	25	■	■	2	537181	HAPG-SD2-25
	20, 25	35	■	■		537173	HAPG-SD2-23
	25, 32	40	■	■		537184	HAPG-SD2-26
	32	50	■	■		564956	DHAA-G-Q5-32-B8-50
EHMB/HGPT-B	EHMB	HGPT-B				DHAA, HAPG	
	20	40	■	■	2	537184	HAPG-SD2-26
	20, 25, 32	50	■	■		564956	DHAA-G-Q5-32-B8-50
	25, 32	63	■	■		537188	HAPG-SD2-28

1) Corrosion resistance class 2 according to Festo standard 940 070
Components subject to moderate corrosion stress. Externally visible parts with primarily decorative surface requirements which are in direct contact with a normal industrial environment or media such as coolants or lubricating agents.

Parallel grippers HGPT-B, heavy-duty

Accessories

Gripper jaw blank BUB-HGPT
(scope of delivery: 2 pieces)

Material:
Aluminium

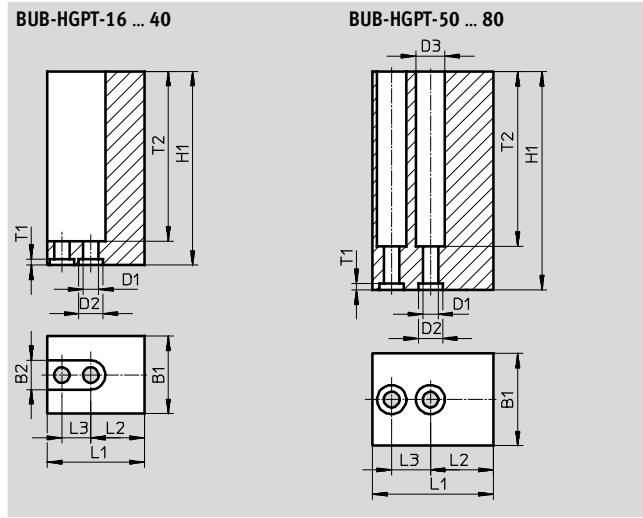

Dimensions and ordering data							
For size	B1	B2	D1	D2	D3	H1	L1
[mm]	±0.05	H13	∅ H13	∅ H8	∅ H13	±0.05	±0.05
16	16	6	3.2	5	-	40	21
20	19	6	3.2	5	-	45	27
25	24	8	4.3	7	-	60	31
35	28	10	5.3	9	-	70	39
40	34	11	6.4	9	-	75	49
50	40	-	6.4	9	11	100	61
63	50	-	10.3	12	17	120	79
80	58	-	12.4	15	20	140	88



For size	L2 ¹⁾	L3 ¹⁾	T1	T2	Weight per blank [g]	Part No.	Type
[mm]			+0.1				
16	10	8	1.3	35	29	560244	BUB-HGPT-16-B
20	11.75	12	1.3	36	53	560245	BUB-HGPT-20-B
25	13.25	13	1.6	51	98	560246	BUB-HGPT-25-B
35	17.5	16	2.1	61	161	560247	BUB-HGPT-35-B
40	22.5	20	2.1	66.5	280	560248	BUB-HGPT-40-B
50	29	24	2.1	91	622	560249	BUB-HGPT-50-B
63	37.5	32	2.6	110	1,213	560250	BUB-HGPT-63-B
80	36	40	3.1	125	1,738	560251	BUB-HGPT-80-B

1) Tolerance for centring hole ±0.02 mm
Tolerance for thread ±0.1 mm

Parallel grippers HGPT-B, heavy-duty

Accessories

FESTO

Ordering data						
	For size [mm]	Description	Weight [g]	Part No.	Type	PU ¹⁾
Centring sleeve ZBH			Technical data → Internet: zbh			
	16, 20	For centring gripper jaw blanks/gripper fingers on the gripper jaws	1	189652	ZBH-5	10
	25		1	186717	ZBH-7	
	35, 40, 50		1	150927	ZBH-9	
	63		1	189653	ZBH-12	
	80		3	191409	ZBH-15	
	20, 25	For lateral centring of gripper fingers on the gripper jaws	1	189652	ZBH-5	
	35, 40, 50, 63		1	186717	ZBH-7	
	80		1	150927	ZBH-9	
	16, 20	For centring the gripper during mounting	1	189652	ZBH-5	
	25, 35		1	186717	ZBH-7	
	40		1	150927	ZBH-9	
	50, 63, 80		1	189653	ZBH-12	
Connecting sleeve ZBV			Technical data → Internet: zbv			
	–	For compensating different centring diameters	1	571033	ZBV-6-5	1
			1	571034	ZBV-8-7	
			1	560253	ZBV-9-8	
			2	571035	ZBV-12-10	
			2	560255	ZBV-14-12	
Blanking plug B			Technical data → Internet: blanking plug			
	16, 20	For sealing the supply ports	1	30979	B-M3-S9	10
	25, 35, 40		1	174308	B-M5-B	
	50, 63		5	3568	B-1/8	
	80		15	3569	B-1/4	

1) Packaging unit

Proximity sensors for size 16 ... 35						
Ordering data – Proximity sensors for C-slot, magneto-resistive						Technical data → Internet: smt
	Type of mounting	Electrical connection, connection direction	Switching output	Cable length [m]	Part No.	Type
N/O contact						
	Insertable in the slot lengthwise	Cable, 3-wire, lateral	PNP	2.5	547862	SMT-10G-PS-24V-E-2,5Q-OE
		Plug M8x1, 3-pin, lateral		0.3	547863	SMT-10G-PS-24V-E-0,3Q-M8D

Proximity sensors for size 40 ... 80						
Ordering data – Proximity sensors for T-slot, magneto-resistive						Technical data → Internet: smt
	Type of mounting	Electrical connection, connection direction	Switching output	Cable length [m]	Part No.	Type
N/O contact						
	Insertable in the slot lengthwise	Cable, 3-wire, lateral	PNP	2.5	547859	SMT-8G-PS-24V-E-2,5Q-OE
		Plug M8x1, 3-pin, lateral		0.3	547860	SMT-8G-PS-24V-E-0,3Q-M8D

Parallel grippers HGPT-B, heavy-duty

Accessories

FESTO

Proximity sensors for size 40 ... 80

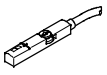
Ordering data – Position transmitters for T-slot					Technical data → Internet: smat	
	Type of mounting	Analogue output [V]	Electrical connection, connection direction	Cable length [m]	Part No.	Type
	Insertable in the slot from above	0 ... 10	Plug M8x1, 3-pin, in-line	0.3	553744	SMAT-8M-U-E-0,3-M8D

-  - Note

Mode of operation:

The position transmitter continuously senses the position of the piston. It has an analogue output with an output signal that is proportional to the piston position.



Measuring range:

Measurement is possible across the entire stroke with the sizes 40 and 50.
A stroke of 13 mm (with the high-force variant 6.5 mm) can be measured with the sizes 63 and 80.

Two position transmitters are required for sensing longer strokes.

Projection:

The position transmitter projects past the housing with the sizes 40 and 50.

Ordering data – Connecting cables				Technical data → Internet: nebu	
	Electrical connection, left	Electrical connection, right	Cable length [m]	Part No.	Type
	Straight socket, M8x1, 3-pin	Cable, open end, 3-wire	2.5	541333	NEBU-M8G3-K-2.5-LE3
			5	541334	NEBU-M8G3-K-5-LE3
	Angled socket, M8x1, 3-pin	Cable, open end, 3-wire	2.5	541338	NEBU-M8W3-K-2.5-LE3
			5	541341	NEBU-M8W3-K-5-LE3