

Software FluidDraw®

FESTO



Product features			
Version	FluidDraw version		
	4 ¹⁾	S5	P5
General			
CD-ROM incl. one licence	■	■	-
USB licence dongle with or without RAM	-	-	■
Network-compatible	■	■	■
File format	CT	CIRC	CIRC
Miniature view/preview in Windows Explorer and file dialogues	-	■	■
Automatic and evaluation functions			
Parts lists, optionally via project or selected sheets	□	■	■
Circuit creation for Festo modular products	□	■	■
Text translation, optionally for project or selected sheets	-	-	■
Electrical terminal diagram, cable diagram, cable list	-	-	■
Electrical contact image	-	-	■
Collecting "unpositioned objects", e.g. electrical coils for inserted valves	-	-	■
Renumbering identifiers	-	-	■
Project management			
Straightforward list management	■	■	-
Project tree	-	□	■
Libraries and symbols			
Pneumatic components and Festo symbols according to ISO 1219-1	■	■	■
User-specific libraries	■	■	■
Creation of user-specific symbols	□	■	■
Electrical symbols according to EN 60617	-	-	■
Product data			
Festo product catalogue	■	■	■
User-specific product databases	-	-	■
Circuit editor			
Cutting, pasting, grouping, copying, deleting	■	■	■
Aligning highlighted drawing elements and symbols	■	■	■
Rotating, scaling, mirroring	□	■	■
Order: bringing to front or sending to back	-	■	■
Macro objects	-	■	■
User-friendly navigation between the symbol representations for equipment	-	□	■
Equipment identification when inserting symbols	-	-	■
Customisable rules for equipment identification and cross-reference representation	-	-	■
Reversal of direction for electrical terminals and cable cores	-	-	■
Setting electrical bridges	-	-	■
Circuit testing			
Open connections, overlapping objects, duplicate cross-reference markers	■	■	■
Missing link targets	-	■	■
Missing or ambiguous assignments (terminals, cables, etc.)	-	-	■

- Product feature included.
 - Product feature with restrictions.
 - Product feature not included.
- 1) No longer available.

Product features			
Version	FluidDraw version		
	4 ¹⁾	S5	P5
User interface			
Circuit editor	■	■	■
Library window	■	■	■
Function diagram editor	■	■	■
Customisation of the file paths (version 4: INI file only)	□	■	■
Switching program language (version 4: only with installation or in INI file)	□	■	■
Switching catalogue language (version 4: program language = catalogue language)	□	■	■
Overview window: preview and navigation windows	-	■	■
Project tree window (version S5: single-level project tree)	-	□	■
Drawing and function elements			
Text, graphic	■	■	■
Function diagram	■	■	■
Parts list	■	■	■
Drawing frame	□	■	■
Line, square, circle, arc, ellipse	□	■	■
Attribute linking	-	■	■
Dimensioning, polyline, polygon, T-connectors	-	-	■
Termination points, electrical cables and terminals	-	-	■
Contact images and cross-references	-	-	■
Line thicknesses	8	9	9
Line styles	4	4	4
Line colours (version 4: line colour of the drawing layer only)	8	all	all
Line ends	1	7	7
Fill colours	16	all	all
Drawing aids			
Grid and snap function for connection points	■	■	■
Snap function for drawing elements	-	■	■
Temporary display of auxiliary lines for aligning connection points	-	■	■
Data points for connecting lines	-	■	■
Ruler	-	-	■
Separate object and grid snap	-	-	■
Automatic connection of aligned connection points	-	-	■
Automatic integration of symbols into connecting cables	-	-	■
Drawing layers			
User-specific description text, toggle for display and editing	■	■	■
Option "Include invisible objects in parts lists"	-	■	■
Number	8	255	255
Line thicknesses	8	9	9
Colours	1	16	all
Interfaces (export/import)			
Direct access to the baskets of the Festo product catalogue (offline)	■	■	■
Parts list: TXT, CSV	■	■	■
Circuit graphic import: DXF	■	■	■
Circuit graphic export: BMP, DXF, JPG, GIF, WMF, PNG, TIF (version 4: DXF and TIF only)	□	■	■
Direct parts list transfer to Festo online shop	-	■	■
Circuit graphic export: PDF	-	-	■
Terminal strips, cable lists, translation tables, product data: TXT, CSV	-	-	■
Technical data → Page/Internet	-	4	6

- Product feature included.
 - Product feature with restrictions.
 - Product feature not included.
- 1) No longer available.

Faster pneumatic circuit diagrams

Description

FluidDraw provides you with access to an extensive library of pneumatic symbols.

The ISO standardised pneumatic symbols are categorised according to drives, valves, valve terminals, compressed air preparation, vacuum technology, flow control, non-return valves, etc.

You place the required symbols in the circuit by dragging and dropping or by using the search function.

You can save recurring symbols and circuits as macros and store them in your own libraries.

Importing a Festo parts list (e.g. shopping basket) places the associated symbols on the desktop. All that remains is to arrange them and add the connecting lines. The parts list generator collects all the attributes ascribed to the symbols such as part number, designation, type, etc. in the background. These attributes can be copied from the Festo catalogue or manually assigned. The relationships between the circuit symbol and parts list item are emphasised.

You can adapt the parts list layout displayed on the screen or sent to the printer as per your requirements.

The benefits to you

Direct access to ready-drawn symbols
Easy, user-friendly operator guidance
Interface to Festo products (catalogue, online shop)

Program components

- Comprehensive symbol library based on ISO 1219-1
- Easy creation of macros
- Automatic creation of circuits for valve terminals and service unit combinations
- Insertion of picture files
- BMP, DXF, GIF, JPG, PNG, TIF, WMF export of circuit diagrams
- DXF import of circuit graphic
- Simultaneous editing of multiple circuit diagrams
- Equipment identifiers
- Emphasising of symbol and associated parts list item
- Convenient printing functions
- Zoom, grid, clipboard, navigation window, etc.
- Online help

System requirements

Windows 2000/XP/VISTA/7
≥ 512 MB RAM (2000/XP)
≥ 1 GB RAM (VISTA/7)

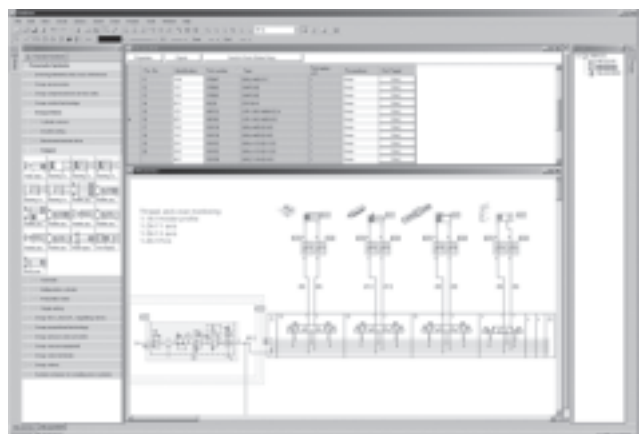
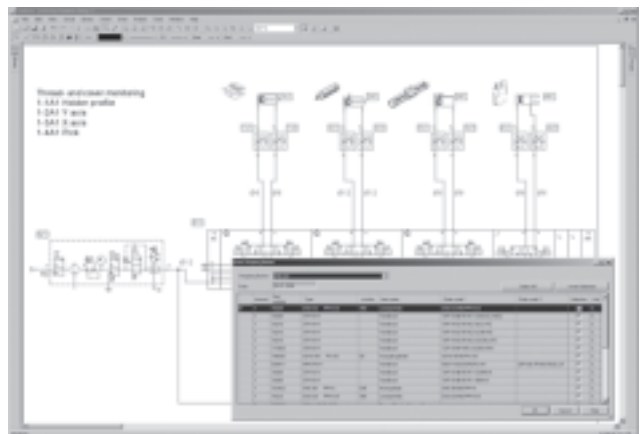

Functions			
Editing	Parts lists	General	
<ul style="list-style-type: none"> • Progressive rotation and scaling • Intelligent grid with automatic overlaying of auxiliary lines for aligning symbols • Improved automatic cable routing • Manual setting of interpolation points for connecting lines • New function to make drawing working lines easier • Multiple window views of a drawing page can be displayed and edited at the same time • Navigation window with selection of the page detail • Extended drawing functions • Simple drawing elements: lines with different arrowheads, rectangle, circle, ellipsis, text, graphic • Simultaneous editing of the geometric properties of highlighted objects • Extended undo/redo function • Free input and positioning of port identifications 	<ul style="list-style-type: none"> • New parts list representation • Extended functions for selecting the listed project files • Printing of long lists over multiple pages • Direct editing of attributes in the parts list • Search function for components associated with the respective list entry • Interface to the Festo online shopping basket 	<ul style="list-style-type: none"> • Greater drawing precision, greater zoom scale as a result (max. 10,000 %) • New file format in XML syntax • Extended administration functions for user-specific symbol libraries • More efficient storage of libraries (better performance in the network) • Consistent separation of program and user files (fewer problems with permissions in the network) • Explicit specification of folder paths (no hidden INI entries required) 	<ul style="list-style-type: none"> • Better utilisation of multi-processor systems through the use of background processes • All attribute values can be displayed at any position as text references • Support for up to 255 drawing levels • No internal restriction on the number of objects (support for more extensive circuits/larger projects) • Direct access to the databases of the Festo catalogue (avoids interface problems with xDKI) • More precise definition of the page boundaries when printing
	Projects		
	<ul style="list-style-type: none"> • Clearer representation of the project files • Improved administration of the project attributes • Copying of the globally defined drawing frame to new pages 		

Ordering data				
	Designation	Scope of delivery	Part No.	Type
	Software	Software 1 network licence	560858	GSWF-CD-FD-S5-L1-ML
	Manual	German manual	560859	GDCW-GSWF-FD-S5-DE
	Software	Software 1 network licence German manual	560860	GSWF-SP-FD-S5-L1-DE

FluidDraw P5® software

Technical data



Complete circuit documentation made easy

Description

FluidDraw P5 offers an intelligent drawing editor for circuits with the full functionality of FluidDraw S5.

FluidDraw P5 also includes a variety of other functions for complete circuit documentation.

These functions provide a convenient way of creating electrical circuits. Automatically generated lists such as terminal diagrams, cable diagrams and cable lists can be inserted anywhere in the project during the process.

The equipment identifiers are always up-to-date. A context menu enables quick and easy navigation between the various representations of equipment. Cross-references make them easier to find in the paper printouts.

FluidDraw P5 also enables easy creation and dimensioning of system diagrams or layout drawings for control cabinets and control consoles.

Another highlight is the Autoconnect function. This function enables FluidDraw P5 to automatically connect aligned connection points or integrate symbols into existing connecting cables.

Product assignment and identification of connecting cables are also possible.

The Auto-update function ensures that the FluidDraw P5 version is always up-to-date. Further options satisfy a wide range of user requirements, for example customisation of the identification rules, text sizes and folder paths.

You organise your various sheets in a multi-level project tree. Any mistakes you make when creating the circuit will trigger a warning.

Product databases

In FluidDraw P5 you can integrate your own product data and use it in the exact same way as the Festo product catalogue contained in the software.

You can also independently create, maintain and use product databases directly in FluidDraw P5.

Multilingual documents

Translation tables enable the project documentation to be output in a wide range of languages. A simple interface allows language texts to be exported/imported.

You can also "collect" all the texts used in the project in a translation table.

Translation tables can also be created, maintained and used directly in FluidDraw P5.

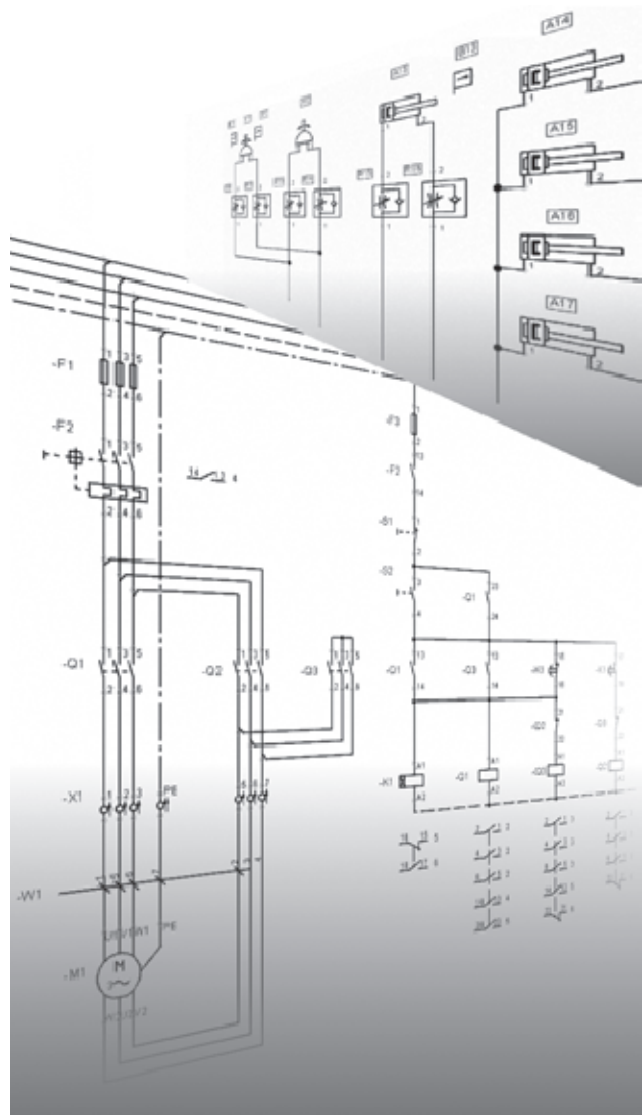

Symbol libraries

As well as pneumatic symbols, the FluidDraw P5 symbol library also contains a large number of electrical symbols according to EN 60617.

Standard symbols and macros as well as custom ones created in FluidDraw can be organised and used in user libraries.

Frequently used symbols are arranged in accordance with the function identifier according to EN 81346-2.

FluidDraw P5® software

Technical data

Complete circuit documentation made easy

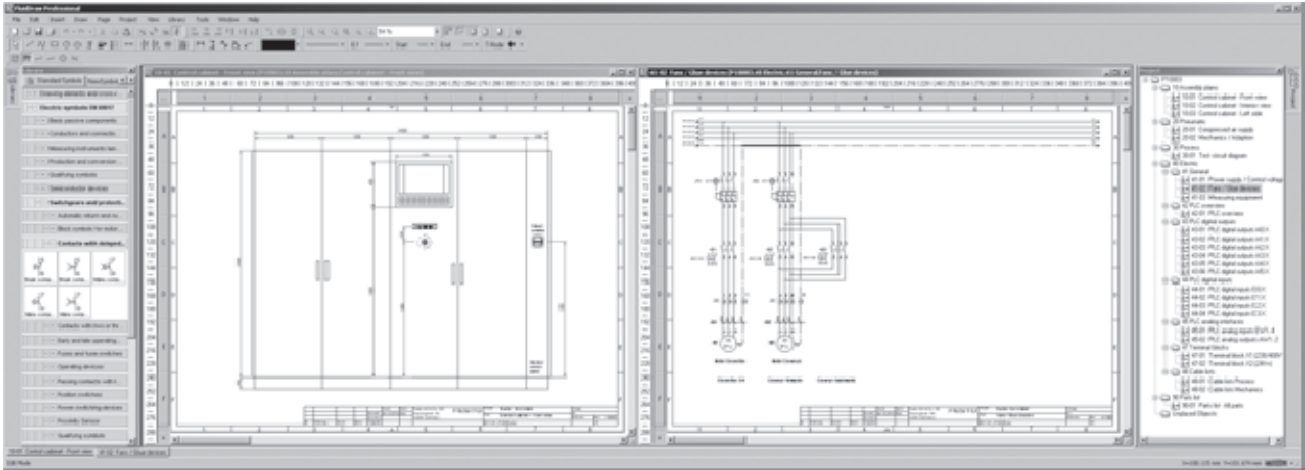

FluidDraw P5 with symbol library, layout sketch of control cabinet, electrical circuit diagram and project tree

Electrical functions

The following functions for electrical circuits guarantee complete documentation:

- Contact images
- Termination points
- Terminals
- Cables (including "distributed" cables)
- Terminal diagram
- Cable diagram
- Cable list

These evaluation lists are updated each time the user performs an action.

When using valves, the associated electrical coils are collected in "unpositioned objects" so that no electrical connections are forgotten.

Import/export formats

Circuit (graphic):

- BMP, DXF, GIF, JPG, PDF, PNG, TIF, WMF

Parts lists, product data and language tables:

- TXT, CSV

Festo products:

- Offline basket (import)
- Product catalogue
- Online basket (export)

Licence

FluidDraw P5 licences are supplied on a USB licence dongle, optionally with 2 GB RAM or without RAM. Further licences for existing dongles are possible.

With U2 licence dongles without RAM, the customer must download and install software.

With U1 licence dongles with RAM, FluidDraw can be launched directly from the dongle without being installed – "Software-to-go".

Licences purchased in conjunction with a dongle are network licences. The number of licences determines how many times FluidDraw P5 can be used simultaneously in a network.

System requirements

Windows 2000/XP/VISTA/7
 ≥ 512MB RAM (2000/XP)
 ≥ 1 GB RAM (VISTA/7)
 USB interface

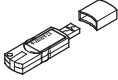
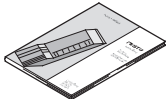
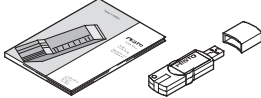
Ordering data				
	Designation	Scope of delivery	Part No.	Type
	Software	Software USB licence dongle with 2 GB RAM 1 network licence	570740	GSWF-U1-FD-P5-UN-1
	Manual	German manual	570746	GDCW-GSWF-FD-P5-DE
		English manual	570747	GDCW-GSWF-FD-P5-EN
	Software	Software USB licence dongle with 2 GB RAM 1 network licence German manual	570748	GSWF-SP-FD-P5-UN-1-DE

FluidDraw P5® software

Ordering data – Modular products

Ordering table		Condi- tions	Code	Enter code
M	Module No.	571731		
	Function	Software	GSWF	GSWF
	Medium	Software package		
		USB licence dongle with 2 GB RAM	-U1	
		USB licence dongle	-U2	
	Application	FluidDraw	-FD	-FD
	Software type	Professional	-P	-P
	Software version	Version 5	5	5
	Licence protection	USB dongle	-U	-U
	Licence	Network licence	N	
	Number of licences	1 ... 99	1 ¹ -...	
O	Manual language	None	-	
		German	2 -DE	
		English	2 -EN	

- ¹ ... The number is always 1 with SP.
- ² **DE, EN** Only in combination with SP, but then mandatory.

Transfer order code

571731 GSWF - SP - FD - P5 - UN - 1 - EN