



One-way flow control valves, NPT



One-way flow control valves, NPT

Product range overview



Version	Valve function	Type	Pneumatic connection								→ Page/ Internet
			Thread	Tubing Ø							
				1/8	5/32	3/16	1/4	5/16	3/8	1/2	
Standard											
	One-way flow control function for exhaust air	GRLA-...-QB	UNF 10/32	■	■	■	■	-	-	-	4
			1/8	-	■	■	■	■	-	-	
			1/4	-	■	■	■	■	■	-	
			3/8	-	-	■	■	■	■	■	
			1/2	-	-	-	-	■	■	■	
In-line installation											
	One-way flow control function	GR-QB	5/32	-	■	-	-	-	-	-	10
			3/16	-	-	■	-	-	-	-	
			1/4	-	-	-	■	-	-	-	
			5/16	-	-	-	-	■	-	-	
			3/8	-	-	-	-	-	■	-	
			1/2	-	-	-	-	-	-	■	

One-way flow control valves, NPT

Type codes

		GRLA	-	1/2	-	QB	-	3/8	-	U
Type										
Screw-in thread										
GRLA	One-way flow control valve for exhaust air									
Front panel and in-line mounting										
GR	One-way flow control valve									
Screw-in and connecting thread										
10-32-UNF	UNF thread									
1/8	NPT thread									
1/4	NPT thread									
3/8	NPT thread									
1/2	NPT thread									
Tube coupling Ø										
Type of connection										
QB	Push-in connector for standard O.D. tubing									
For tubing O.D.										
1/8, 5/32, 3/16, 1/4, 5/16, 3/8, 1/2										
Series										
U	U series									



One-way flow control valves GRLA, NPT

Technical data

FESTO

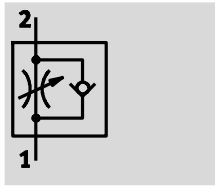
Function



-  - Temperature range
32 ... 140 °F
-  - Operating pressure
-13.8 ... +116 psi



- Push-in connector QB
- Swivel connection can be swivelled around installation axis after mounting

General technical data						
Type GRLA	10-32-UNF	1/8	1/4	3/8	1/2	
Pneumatic connection 1	QB-1/8	-	-	-	-	
	QB-5/32	QB-5/32	QB-5/32	-	-	
	QB-3/16	QB-3/16	QB-3/16	QB-3/16	-	
	QB-1/4	QB-1/4	QB-1/4	QB-1/4	-	
	-	QB-5/16	QB-5/16	QB-5/16	QB-5/16	QB-5/16
	-	-	QB-3/8	QB-3/8	QB-3/8	QB-3/8
	-	-	-	QB-1/2	QB-1/2	QB-1/2
Pneumatic connection 2	UNF10-32	NPT1/8-27	NPT1/4-18	NPT3/8-18	NPT1/2-14	
Valve function	One-way flow control function for exhaust air					
Actuation type	Manual					
Adjustment component	Slotted head screw					
Mounting position	Any					
Type of mounting	Screw-in					
	Via male thread					
Max. tightening torque	[ft-lbf]	1.1	5.2	8.9	16.2	20.7

Operating and environmental conditions	
Operating medium	Compressed air in accordance with ISO 8573-1:2010 [7:4:4]
Note on operating/pilot medium	Operation with lubricated medium possible (in which case lubricated operation will always be required)
Operating pressure [psi]	-13.8 ... +116
Ambient temperature [°F]	32 ... 140
Temperature of medium [°F]	32 ... 140

Materials	
Threaded plug	Nickel-plated brass
Seals	NBR
Hollow bolt	Nickel-plated brass
Release ring	POM
Knurled head	Nickel-plated brass
Regulating screw	Nickel-plated brass
Swivel connection	PBT-reinforced
Note on materials	Contains PWIS (paint wetting impairment substances)
	RoHS-compliant

One-way flow control valves GRLA, NPT

Technical data

Standard nominal flow rate q _{nN} [cfm] at 6 bar → 5 bar						
Type GRLA		10-32-UNF	1/8	1/4	3/8	1/2
QB-1/8	F ¹⁾	1.87	–	–	–	–
	N ²⁾	1.45 ... 1.91	–	–	–	–
QB-5/32	F ¹⁾	1.7	7.56	12	–	–
	N ²⁾	1.31 ... 1.73	5.83 ... 7.7	9.25 ... 12.25	–	–
QB-3/16	F ¹⁾	1.87	6.78	9.5	10.6	–
	N ²⁾	1.41 ... 1.911	5.23 ... 6.92	7.31 ... 9.68	8.1 ... 10.8	–
QB-1/4	F ¹⁾	2.26	8.44	16.6	19.7	–
	N ²⁾	1.73 ... 2.3	6.5 ... 8.62	12.78 ... 16.91	15.2 ... 20.1	–
QB-5/16	F ¹⁾	–	8.37	18.7	28.1	42.4
	N ²⁾	–	6.43 ... 8.55	14.37 ... 19.1	21.65 ... 28.7	32.6 ... 43.2
QB-3/8	F ¹⁾	–	–	17.13	29	41.8
	N ²⁾	–	–	13.2 ... 17.5	22.3 ... 29.5	32.2 ... 42.7
QB-1/2	F ¹⁾	–	–	–	30.7	48.1
	N ²⁾	–	–	–	23.6 ... 31.3	37.1 ... 49.1

- 1) F Flow control direction
- 2) N Non-return direction

Standard flow rate q _n [cfm] at 6 bar → 0 bar						
Type GRLA		10-32-UNF	1/8	1/4	3/8	1/2
QB-1/8	F ¹⁾	3.3	–	–	–	–
	N ²⁾	3.23 ... 3.4	–	–	–	–
QB-5/32	F ¹⁾	3	11.5	15.7	–	–
	N ²⁾	3 ... 3.14	11.4 ... 11.9	15.7 ... 16.4	–	–
QB-3/16	F ¹⁾	3.3	10.9	13.6	13.7	–
	N ²⁾	3.32 ... 3.43	10.9 ... 11.3	13.6 ... 14.2	13.7 ... 14.3	–
QB-1/4	F ¹⁾	3.9	13.8	25	28.1	–
	N ²⁾	3.92 ... 4.1	13.8 ... 14.3	25 ... 26	28.1 ... 29.2	–
QB-5/16	F ¹⁾	–	13.5	31.4	43.5	59.3
	N ²⁾	–	13.5 ... 14	31.4 ... 32.6	43.5 ... 45.2	59.6 ... 61.6
QB-3/8	F ¹⁾	–	–	28.5	45.8	59.7
	N ²⁾	–	–	28.5 ... 29.6	45.8 ... 47.6	59.7 ... 62.1
QB-1/2	F ¹⁾	–	–	–	50.5	76.1
	N ²⁾	–	–	–	50.5 ... 52.5	76.1 ... 79.1

- 1) F Flow control direction
- 2) N Non-return direction

One-way flow control valves GRLA, NPT

Technical data

FESTO

Standard nominal flow rate q_{nN} [l/min] at 6 bar \rightarrow 5 bar
as a function of turns of the flow control screw n

Pneumatic connection UNF10-32

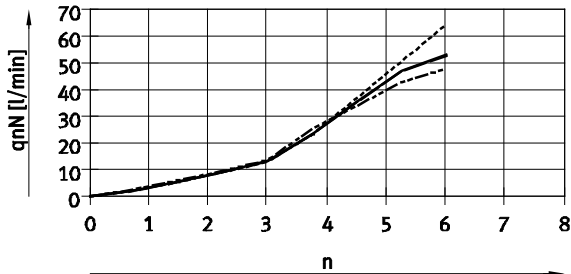

— QB-1/8
- - - QB-5/32
- - - QB-3/16
- - - QB-1/4

Standard flow rate q_n in non-return direction at 6 bar \rightarrow 0 bar
as a function of turns of the flow control screw n

Pneumatic connection UNF10-32

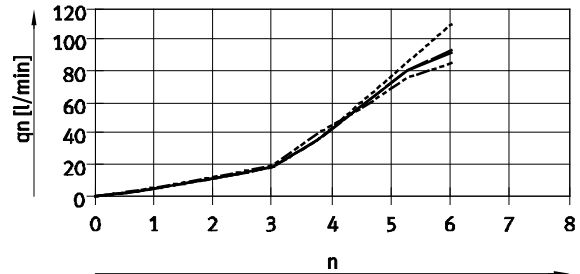

— QB-1/8
- - - QB-5/32
- - - QB-3/16
- - - QB-1/4

Pneumatic connection NPT1/8-27

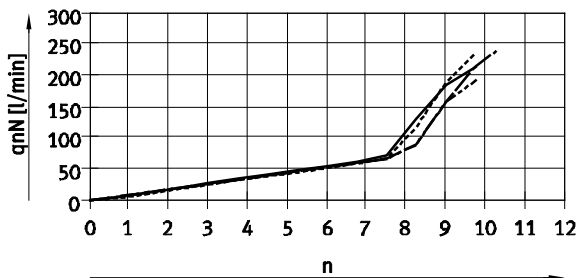

— QB-5/32
- - - QB-3/16
- - - QB-1/4
- - - QB-5/16

Pneumatic connection NPT1/8-27

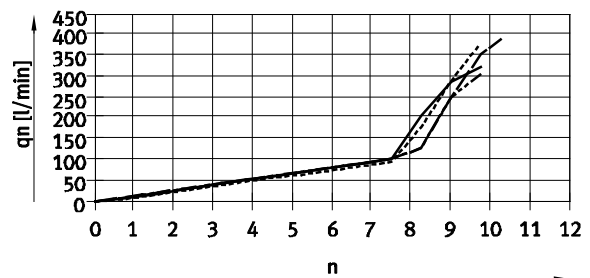

— QB-5/32
- - - QB-3/16
- - - QB-1/4
- - - QB-5/16

Pneumatic connection NPT1/4-18

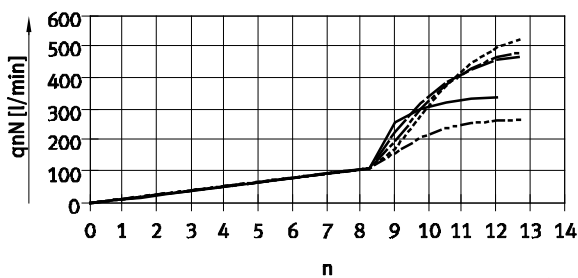

— QB-5/32
- - - QB-3/16
- - - QB-1/4
- - - QB-5/16
- - - QB-3/8

Pneumatic connection NPT1/4-18

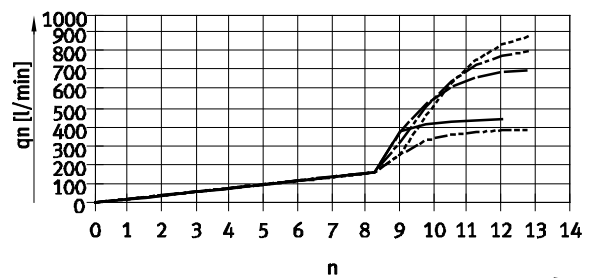

— QB-5/32
- - - QB-3/16
- - - QB-1/4
- - - QB-5/16
- - - QB-3/8

One-way flow control valves GRLA, NPT

Technical data

FESTO

Standard nominal flow rate q_{nN} [l/min] at 6 bar \rightarrow 5 bar
as a function of turns of the flow control screw n

Pneumatic connection NPT $\frac{3}{8}$ -18

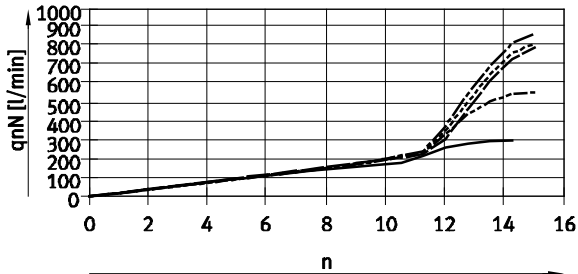

- QB-3/16
- QB-1/4
- QB-5/16
- QB-3/8
- QB-1/2

Standard flow rate q_n at 6 bar \rightarrow 0 bar
as a function of turns of the flow control screw n

Pneumatic connection NPT $\frac{3}{8}$ -18

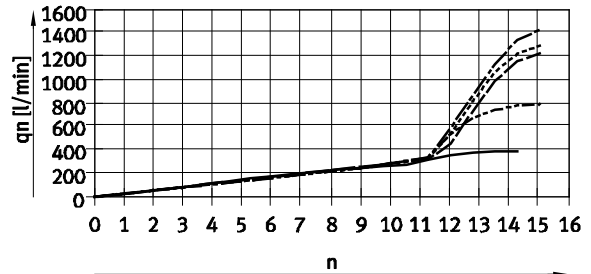

- QB-3/16
- QB-1/4
- QB-5/16
- QB-3/8
- QB-1/2

Pneumatic connection NPT $\frac{1}{2}$ -14

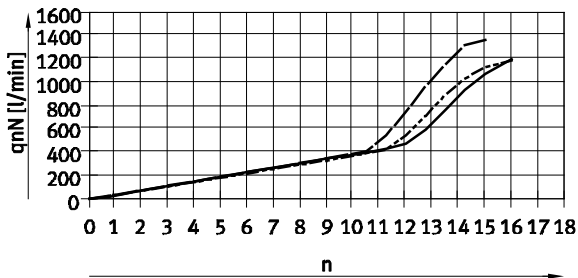

- QB-5/16
- QB-3/8
- QB-1/2

Pneumatic connection NPT $\frac{1}{2}$ -14

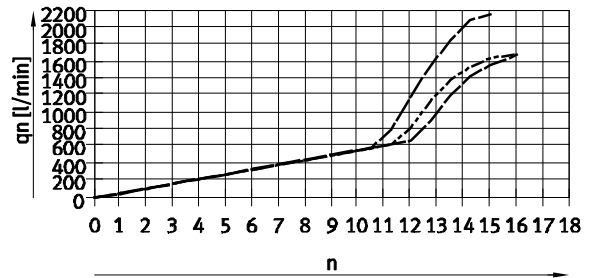

- QB-5/16
- QB-3/8
- QB-1/2

One-way flow control valves GRLA, NPT

Technical data

Dimensions Download CAD data → www.festo.com

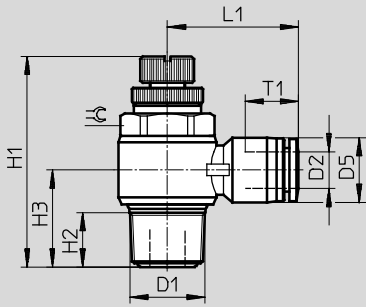

Type	Connection D1	Tubing O.D. D2	D5	H1		H2	H3	L1	T1	⌀	Weight [oz]
				min.	max.						
GRLA-10-32-UNF	UNF10/32	1/8	7.8	26.9	29.1	3.6	10.3	16.5	11.4	5/16	0.3
		5/32	10.5				10.3	20.3	14.9		0.35
		3/16	11.5				10.4	21.6	15.9		0.34
		1/4	13.0				10.6	23.7	16.8		0.38
GRLA-1/8	NPT1/8	5/32	10.5	34.9	39.8	8.2	15.1	23.7	14.9	7/16	0.66
		3/16	11.5				15.1	24.3	15.9		0.66
		1/4	13.0				15.2	24.9	16.8		0.7
		5/16	14.5				16.2	26.6	18.7		0.77
GRLA-1/4	NPT1/4	5/32	10.5	40.6	47.0	11.0	18.4	25.6	14.9	19/32	1.2
		3/16	11.5				18.4	26.2	15.9		1.2
		1/4	13.0				18.4	26.8	16.8		1.26
		5/16	14.5				19.2	28.5	18.7		1.33
		3/8	17.5				20.7	30.9	20.1		1.38
GRLA-3/8	NPT3/8	1/4	13.0	47.9	54.9	13.1	21.9	28.4	16.8	3/4	2.35
		3/16	11.5				21.9	27.8	15.9		2.31
		5/16	14.5				21.9	29.6	18.7		2.46
		3/8	17.5				22.6	30.7	20.1		2.48
		1/2	20.8				24.1	34.0	22.9		2.61
GRLA-1/2	NPT1/2	5/16	14.5	53.9	61.3	16.5	26.5	32.4	18.7	15/16	3.66
		3/8	17.5				26.5	33.2	20.1		3.85
		1/2	20.8				27.7	36.5	22.9		4.2

One-way flow control valves GRLA, NPT

Technical data

Ordering data				
Design	Pneumatic connection 2	Pneumatic connection 1	Part No.	Type
	UNF10-32	1/8	564839	GRLA-10-32-UNF-QB-1/8-U
		5/32	564840	GRLA-10-32-UNF-QB-5/32-U
		3/16	564841	GRLA-10-32-UNF-QB-3/16-U
		1/4	564842	GRLA-10-32-UNF-QB-1/4-U
	NPT1/8-27	5/32	534656	GRLA-1/8-QB-5/32-U
		3/16	534657	GRLA-1/8-QB-3/16-U
		1/4	534658	GRLA-1/8-QB-1/4-U
		5/16	534659	GRLA-1/8-QB-5/16-U
	NPT1/4-18	5/32	564843	GRLA-1/4-QB-5/32-U
		3/16	534660	GRLA-1/4-QB-3/16-U
		1/4	534661	GRLA-1/4-QB-1/4-U
		5/16	534662	GRLA-1/4-QB-5/16-U
		3/8	534663	GRLA-1/4-QB-3/8-U
	NPT3/8-18	1/4	534664	GRLA-3/8-QB-1/4-U
		3/16	564844	GRLA-3/8-QB-3/16-U
		5/16	534665	GRLA-3/8-QB-5/16-U
		3/8	534666	GRLA-3/8-QB-3/8-U
		1/2	534667	GRLA-3/8-QB-1/2-U
	NPT1/2-14	5/16	564845	GRLA-1/2-QB-5/16-U
		3/8	564846	GRLA-1/2-QB-3/8-U
		1/2	564847	GRLA-1/2-QB-1/2-U



One-way flow control valves GR, NPT

Technical data

FESTO

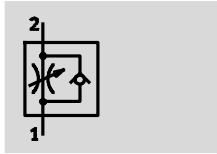
Function



-  - Temperature range
32 ... 140 °F
-  - Operating pressure
-13.8 ... +116 psi



- One-way flow control valve for in-line installation
- Adjustment via knurled screw
- Push-in connector QB for standard O.D. tubing QB- $\frac{5}{32}$, $\frac{3}{16}$, $\frac{1}{4}$, $\frac{5}{16}$, $\frac{3}{8}$, $\frac{1}{2}$

General technical data						
Type GR	QB- $\frac{5}{32}$	QB- $\frac{3}{16}$	QB- $\frac{1}{4}$	QB- $\frac{5}{16}$	QB- $\frac{3}{8}$	QB- $\frac{1}{2}$
Valve function	One-way flow control function					
Actuation type	Manual					
Adjustment component	Slotted head screw					
Mounting position	Any					
Type of mounting	In-line installation					
	Via through-hole					
Pneumatic connection 1 and 2	QB- $\frac{5}{32}$	QB- $\frac{3}{16}$	QB- $\frac{1}{4}$	QB- $\frac{5}{16}$	QB- $\frac{3}{8}$	QB- $\frac{1}{2}$

Operating and environmental conditions	
Operating medium	Compressed air in accordance with ISO 8573-1:2010 [7:4:4]
Note on operating/pilot medium	Operation with lubricated medium possible (in which case lubricated operation will always be required)
Operating pressure [psi]	-13.8 ... +116
Ambient temperature [°F]	32 ... 140
Temperature of medium [°F]	32 ... 140

Weight						
Type GR	QB- $\frac{5}{32}$	QB- $\frac{3}{16}$	QB- $\frac{1}{4}$	QB- $\frac{5}{16}$	QB- $\frac{3}{8}$	QB- $\frac{1}{2}$
Weight [oz]	0.4	1	1	1.5	2.7	4.2

Materials	
Housing	PBT-reinforced
Threaded plug	Nickel-plated brass
Seals	NBR
Release ring	POM
Knurled head	Nickel-plated brass
Regulating screw	Nickel-plated brass
Note on materials	Contains PWIS (paint wetting impairment substances)
	RoHS-compliant

One-way flow control valves GR, NPT

Technical data

Standard nominal flow rate q_{nN} [cfm] at 6 bar \rightarrow 5 bar						
Type GR	QB-5/32	QB-3/16	QB-1/4	QB-5/16	QB-3/8	QB-1/2
F ¹⁾	1.7	3.1	4.7	8	11.4	14
N ²⁾	0.6 ... 1.7	2.6 ... 3.1	5 ... 5.5	5.7 ... 8.1	8.1 ... 11.7	10.8 ... 12.7

- 1) F: Flow control direction
- 2) N: Non-return direction

Standard flow rate q_n [cfm] at 6 bar \rightarrow 0 bar						
Type GR	QB-5/32	QB-3/16	QB-1/4	QB-5/16	QB-3/8	QB-1/2
F ¹⁾	3	5.3	7.8	13.5	19	23.2
N ²⁾	2.4 ... 3.2	4.8 ... 5.1	10.6 ... 10.7	13.8 ... 13.9	20.5 ... 21.8	16.6 ... 20.2

- 1) F Flow control direction
- 2) N Non-return direction

Standard nominal flow rate q_{nN} at 6 bar \rightarrow 5 bar as a function of turns of the flow control screw n

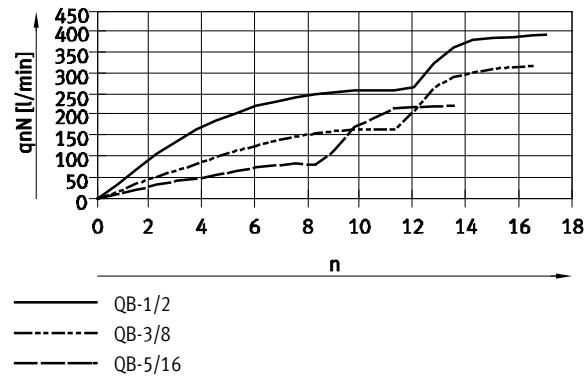

Standard flow rate q_n at 6 bar \rightarrow 0 bar as a function of turns of the flow control screw n

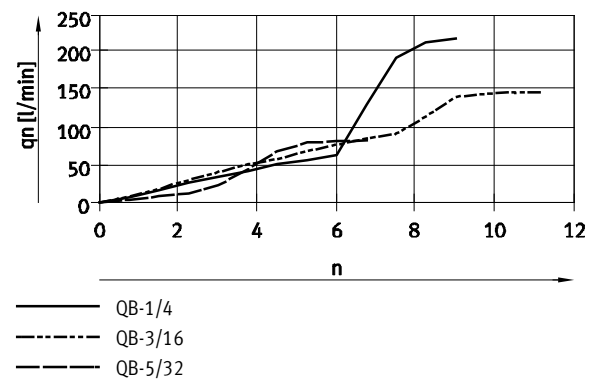
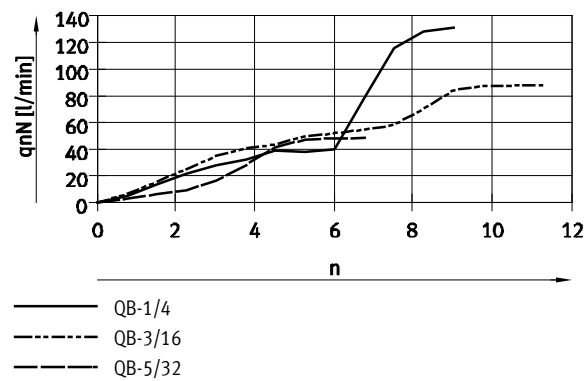
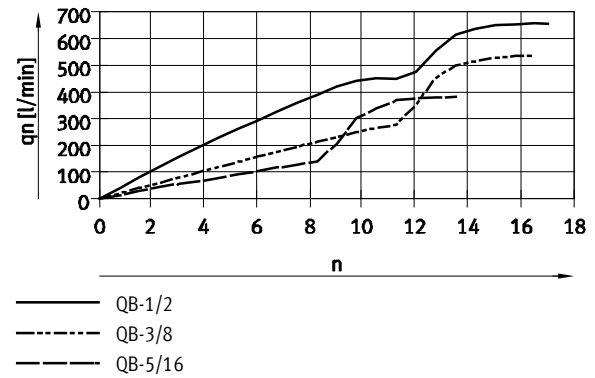

One-way flow control valves GR, NPT

Technical data

FESTO

Dimensions

Download CAD data → www.festo.com

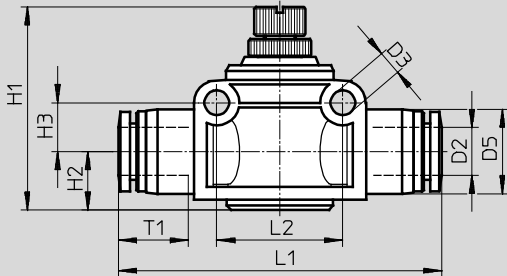

Type	Tubing O.D. D2	D3	D5	H1		H2	H3	L1	L2	T1
				min.	max.					
GR-QB-5/32-U	5/32	3.2	10.5	26.4	28.9	7.6	5.6	44.8	15.4	14.9
GR-QB-3/16-U	3/16	4.3	11.6	33.1	38.5	7.6	8.0	49.9	20.4	15.9
GR-QB-1/4-U	1/4	4.3	13.1	33.5	38.9	9.4	8.0	50.1	20.4	16.8
GR-QB-5/16-U	5/16	4.4	14.8	35.5	41.5	10.2	8.5	56.4	22.0	18.7
GR-QB-3/8-U	3/8	4.3	17.5	40.7	48.6	11.4	10.3	61.4	28.1	20.1
GR-QB-1/2-U	1/2	4.4	20.5	45.5	53.4	14.0	12.1	70.7	32.0	22.9

Ordering data

Design	Pneumatic connection 1	Pneumatic connection 2	Part No.	Type
	5/32	5/32	534680	GR-QB-5/32-U
	3/16	3/16	534681	GR-QB-3/16-U
	1/4	1/4	534682	GR-QB-1/4-U
	5/16	5/16	534683	GR-QB-5/16-U
	3/8	3/8	534684	GR-QB-3/8-U
	1/2	1/2	534685	GR-QB-1/2-U