

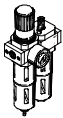

Service units FRC/FRCS, D series

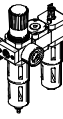
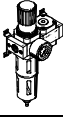
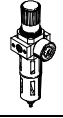
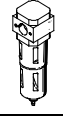
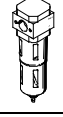
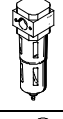

Service units FRC/FRCS, D series, metal design

Product range overview D series service units, metal design

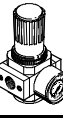
Type	Size	Pneumatic connection										Pressure regulation range [bar]			Grade of filtration [µm]			
		M5	M7	G1/8	G1/4	G3/8	G1/2	G3/4	G1	QS4	QS6	0.5 ...	0.5 ...	2.5 ...	0.01	1	5	40
Service units																		
FRC/FRCS 	Micro	■	■	■	-	-	-	-	-	■	■	■	-	-	-	-	■	-
	Mini	-	-	■	■	■	-	-	-	-	-	■	■	-	-	-	■	■
	Midi	-	-	-	■	■	■	■	-	-	-	■	■	-	-	-	■	■
	Maxi	-	-	-	-	-	■	■	■	-	-	■	■	-	-	-	■	■
Service unit combinations																		
FRC-K 	Micro	-	-	-	-	-	-	-	-	-	-	-	-	-	-	-	-	
	Mini	-	-	■	■	-	-	-	-	-	-	-	■	■	-	-	-	■
	Midi	-	-	-	■	■	■	-	-	-	-	-	■	■	-	-	-	■
	Maxi	-	-	-	-	-	■	■	-	-	-	-	■	■	-	-	-	■
LFR-K LFRS-K 	Micro	-	-	-	-	-	-	-	-	-	-	-	-	-	-	-	-	
	Mini	-	-	■	■	-	-	-	-	-	-	-	■	■	-	-	-	■
	Midi	-	-	-	■	■	■	-	-	-	-	-	■	■	-	-	-	■
	Maxi	-	-	-	-	-	■	■	-	-	-	-	■	■	-	-	-	■
Individual devices																		
Filter regulators LFR/LFRS 	Micro	■	■	■	-	-	-	-	-	■	■	■	-	-	-	-	■	-
	Mini	-	-	■	■	■	-	-	-	-	-	■	■	-	-	-	■	■
	Midi	-	-	-	■	■	■	■	-	-	-	■	■	-	-	-	■	■
	Maxi	-	-	-	-	-	■	■	■	-	-	■	■	-	-	-	■	■
Filters LF 	Micro	■	■	■	-	-	-	-	-	■	■	-	-	-	-	-	■	-
	Mini	-	-	■	■	■	-	-	-	-	-	-	-	-	-	-	■	■
	Midi	-	-	-	■	■	■	■	-	-	-	-	-	-	-	-	■	■
	Maxi	-	-	-	-	-	■	■	■	-	-	-	-	-	-	-	■	■
Fine and micro filters LFMA/LFMB 	Micro	-	-	-	-	-	-	-	-	-	-	-	-	-	-	-	-	
	Mini	-	-	■	■	■	-	-	-	-	-	-	-	-	■	■	-	-
	Midi	-	-	-	■	■	■	■	-	-	-	-	-	-	■	■	-	-
	Maxi	-	-	-	-	-	■	■	■	-	-	-	-	-	■	■	-	-
Active carbon filters LFX 	Micro	-	-	-	-	-	-	-	-	-	-	-	-	-	-	-	-	
	Mini	-	-	■	■	■	-	-	-	-	-	-	-	-	-	-	-	-
	Midi	-	-	-	■	■	■	■	-	-	-	-	-	-	-	-	-	-
	Maxi	-	-	-	-	-	■	■	■	-	-	-	-	-	-	-	-	-
Filter combinations LFMBA 	Micro	-	-	-	-	-	-	-	-	-	-	-	-	-	-	-	-	
	Mini	-	-	■	■	■	-	-	-	-	-	-	-	-	■	■	-	-
	Midi	-	-	-	■	■	■	■	-	-	-	-	-	-	■	■	-	-
	Maxi	-	-	-	-	-	■	■	■	-	-	-	-	-	■	■	-	-
Pressure regulators LRS/LRS 	Micro	■	■	■	-	-	-	-	-	■	■	■	-	-	-	-	-	-
	Mini	-	-	■	■	■	-	-	-	-	-	■	■	-	-	-	-	-
	Midi	-	-	-	■	■	■	■	-	-	-	■	■	-	-	-	-	-
	Maxi	-	-	-	-	-	■	■	■	-	-	■	■	-	-	-	-	-



Service units FRC/FRCS, D series, metal design

Product range overview D series service units, metal design

Type	Size	Bowl guard		Condensate drain			Pressure indication		Actuator lock		Supply voltage			Options			→ Page/ Internet
		Metal bowl guard	Plastic bowl	Manual rotary	Semi-automatic	Fully automatic	With pressure gauge	Without pressure gauge	Rotary knob with detent	Rotary knob with integrated lock	24 V DC	110 V AC	230 V AC	Directly actuated pressure regulator with integrated return flow function	Pilot actuated pressure regulator with integrated return flow function	Differential pressure indicator	
Service units																	
FRC/FRCS	Micro	-	■	■	■	-	■	■	■	-	-	-	-	-	-	-	6
	Mini	■	-	■	-	■	■	■	■	■	-	-	-	-	-	-	
	Midi	■	-	■	-	■	■	■	■	■	-	-	-	-	-	-	
	Maxi	■	-	■	-	■	■	■	■	■	-	-	-	■	■	-	
Service unit combinations																	
FRC-K	Micro	-	-	-	-	-	-	-	-	-	-	-	-	-	-	-	frc
	Mini	■	-	■	-	■	■	-	■	-	■	-	-	-	-	-	
	Midi	■	-	■	-	■	■	-	■	-	■	-	-	-	-	-	
	Maxi	■	-	■	-	■	■	-	■	-	■	-	-	■	■	-	
LFR-K LFRS-K	Micro	-	-	-	-	-	-	-	-	-	-	-	-	-	-	-	lfr
	Mini	■	-	■	-	■	■	-	■	■	■	-	-	-	-	-	
	Midi	■	-	■	-	■	■	-	■	■	■	-	-	-	-	-	
	Maxi	■	-	■	-	■	■	-	■	■	■	-	-	■	■	-	
Individual devices																	
Filter regulators LFR/LFRS	Micro	-	■	■	■	-	■	■	■	-	-	-	-	-	-	-	lfr
	Mini	■	-	■	-	■	■	■	■	■	-	-	-	-	-	-	
	Midi	■	-	■	-	■	■	■	■	■	-	-	-	-	-	-	
	Maxi	■	-	■	-	■	■	■	■	■	-	-	-	■	■	-	
Filters LF	Micro	-	■	■	■	-	-	-	-	-	-	-	-	-	-	-	lf
	Mini	■	-	■	-	■	-	-	-	-	-	-	-	-	-	-	
	Midi	■	-	■	-	■	-	-	-	-	-	-	-	-	-	-	
	Maxi	■	-	■	-	■	-	-	-	-	-	-	-	-	-	-	
Fine and micro filters LFMA/LFMB	Micro	-	-	-	-	-	-	-	-	-	-	-	-	-	-	-	lfma, lfmb
	Mini	■	-	■	-	■	-	-	-	-	-	-	-	-	-	■	
	Midi	■	-	■	-	■	-	-	-	-	-	-	-	-	-	■	
	Maxi	■	-	■	-	■	-	-	-	-	-	-	-	-	-	■	
Active carbon filters LFX	Micro	-	-	-	-	-	-	-	-	-	-	-	-	-	-	-	lfx
	Mini	■	-	-	-	-	-	-	-	-	-	-	-	-	-	-	
	Midi	■	-	-	-	-	-	-	-	-	-	-	-	-	-	-	
	Maxi	■	-	-	-	-	-	-	-	-	-	-	-	-	-	-	
Filter combinations LFMBA	Micro	-	-	-	-	-	-	-	-	-	-	-	-	-	-	-	lfmba
	Mini	■	-	■	-	■	-	-	-	-	-	-	-	-	-	■	
	Midi	■	-	■	-	■	-	-	-	-	-	-	-	-	-	■	
	Maxi	■	-	■	-	■	-	-	-	-	-	-	-	-	-	■	
Pressure regulators LR/LRS	Micro	-	-	-	-	-	■	■	■	-	-	-	-	-	-	-	lr
	Mini	-	-	-	-	-	■	■	■	■	-	-	-	■	-	-	
	Midi	-	-	-	-	-	■	■	■	■	-	-	-	■	-	-	
	Maxi	-	-	-	-	-	■	■	■	■	-	-	-	■	■	-	

Service units FRC/FRCS, D series, metal design

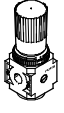
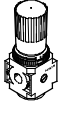
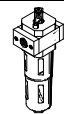
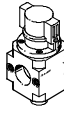
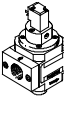
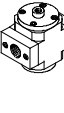
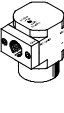
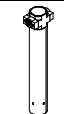
Product range overview D series service units, metal design

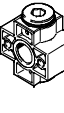
Type	Size	Pneumatic connection										Pressure regulation range [bar]		
		M5	M7	G1/8	G1/4	G3/8	G1/2	G3/4	G1	QS4	QS6	0.5 ... 7	0.5 ... 12	
Individual devices														
Pressure regulators LRB/LRBS		Micro	-											
		Mini	-	-	-	■	-	-	-	-	-	-	■	■
		Midi	-	-	-	-	■	-	-	-	-	-	■	■
		Maxi	-											
Pressure regulator combinations LRB-K		Micro	-											
		Mini	-	-	-	■	■	-	-	-	-	-	■	■
		Midi	-	-	-	-	■	■	-	-	-	-	■	■
		Maxi	-											
Lubricators LOE		Micro	■	■	■	-	-	-	-	-	■	■	-	-
		Mini	-	-	■	■	■	-	-	-	-	-	-	-
		Midi	-	-	-	■	■	■	■	-	-	-	-	-
		Maxi	-	-	-	-	-	■	■	■	-	-	-	-
On-off valves HE		Micro	-											
		Mini	-	-	■	■	■	-	-	-	-	-	-	-
		Midi	-	-	-	■	■	■	■	-	-	-	-	-
		Maxi	-	-	-	-	-	■	■	■	-	-	-	-
On-off valves, electrical HEE		Micro	-											
		Mini	-	-	■	■	■	-	-	-	-	-	-	-
		Midi	-	-	-	■	■	■	■	-	-	-	-	-
		Maxi	-	-	-	-	-	■	■	■	-	-	-	-
On-off valves, pneumatic HEP		Micro	-											
		Mini	-	-	■	■	■	-	-	-	-	-	-	-
		Midi	-	-	-	■	■	■	■	-	-	-	-	-
		Maxi	-	-	-	-	-	■	■	■	-	-	-	-
Soft-start valves HEL		Micro	-											
		Mini	-	-	■	■	■	-	-	-	-	-	-	-
		Midi	-	-	-	■	■	■	■	-	-	-	-	-
		Maxi	-	-	-	-	-	■	■	■	-	-	-	-
Membrane air dryers LDM1		Micro	-											
		Mini	-											
		Midi	-											
		Maxi	-	-	-	-	-	■	■	■	-	-	-	-
Branching modules FRM		Micro	-											
		Mini	-	-	■	■	■	-	-	-	-	-	-	-
		Midi	-	-	-	■	■	■	■	-	-	-	-	-
		Maxi	-	-	-	-	-	■	■	■	-	-	-	-
Distributor block FRZ		Micro	-											
		Mini	-	-	-	-	-	-	-	-	-	-	-	-
		Midi	-	-	-	-	-	-	-	-	-	-	-	-
		Maxi	-	-	-	-	-	-	-	-	-	-	-	-

Service units FRC/FRCS, D series, metal design

Product range overview D series service units, metal design

Type	Size	Bowl guard		Pressure indication		Actuator lock		Supply voltage			Options		→ Page/ Internet
		Metal bowl guard	Plastic bowl	With pressure gauge	Without pressure gauge	Rotary knob with detent	Rotary knob with integrated lock	24 V DC	110 V AC	230 V AC	Non-return function	Pressure switch	
Individual devices													
Pressure regulators LRB/LRBS	Micro	-	-	-	■	■	■	-	-	-	-	-	lrb
	Mini	-	-	-	■	■	■	-	-	-	-	-	
	Midi	-	-	-	■	■	■	-	-	-	-	-	
	Maxi	-	-	-	■	■	■	-	-	-	-	-	
Pressure regulator combinations LRB-K	Micro	-	-	-	■	■	-	-	-	-	-	-	lrb
	Mini	-	-	-	■	■	-	-	-	-	-	-	
	Midi	-	-	-	■	■	-	-	-	-	-	-	
	Maxi	-	-	-	■	■	-	-	-	-	-	-	
Lubricators LOE	Micro	-	■	-	■	-	-	-	-	-	-	-	loe
	Mini	■	-	-	■	-	-	-	-	-	-	-	
	Midi	■	-	-	■	-	-	-	-	-	-	-	
	Maxi	■	-	-	■	-	-	-	-	-	-	-	
On-off valves HE	Micro	-	-	-	■	■	-	-	-	-	-	-	he
	Mini	-	-	-	■	■	-	-	-	-	-	-	
	Midi	-	-	-	■	■	-	-	-	-	-	-	
	Maxi	-	-	-	■	■	-	-	-	-	-	-	
On-off valves, electrical HEE	Micro	-	-	-	■	-	-	■	■	■	-	-	hee
	Mini	-	-	-	■	-	-	■	■	■	-	-	
	Midi	-	-	-	■	-	-	■	■	■	-	-	
	Maxi	-	-	-	■	-	-	■	■	■	-	-	
On-off valves, pneumatic HEP	Micro	-	-	-	■	-	-	-	-	-	-	-	hep
	Mini	-	-	-	■	-	-	-	-	-	-	-	
	Midi	-	-	-	■	-	-	-	-	-	-	-	
	Maxi	-	-	-	■	-	-	-	-	-	-	-	
Soft-start valves HEL	Micro	-	-	-	■	-	-	-	-	-	-	-	hel
	Mini	-	-	-	■	-	-	-	-	-	-	-	
	Midi	-	-	-	■	-	-	-	-	-	-	-	
	Maxi	-	-	-	■	-	-	-	-	-	-	-	
Membrane air dryers LDM1	Micro	-	-	-	■	-	-	-	-	-	-	-	ldm1
	Mini	-	-	-	■	-	-	-	-	-	-	-	
	Midi	-	-	-	■	-	-	-	-	-	-	-	
	Maxi	■	-	-	■	-	-	-	-	-	-	-	
Branching modules FRM	Micro	-	-	-	■	-	-	-	-	-	■	■	frm
	Mini	-	-	-	■	-	-	-	-	-	■	■	
	Midi	-	-	-	■	-	-	-	-	-	■	■	
	Maxi	-	-	-	■	-	-	-	-	-	■	■	
Distributor block FRZ	Micro	-	-	-	■	-	-	-	-	-	-	-	frz
	Mini	-	-	-	■	-	-	-	-	-	-	-	
	Midi	-	-	-	■	-	-	-	-	-	-	-	
	Maxi	-	-	-	■	-	-	-	-	-	-	-	

Service units FRC/FRCS, D series, metal design

Peripherals overview

Micro

Service unit FRC with connection plates, connection size G $\frac{1}{8}$, QS4 or QS6

Service unit FRC without connection plates, connection size M5 or M7 in housing

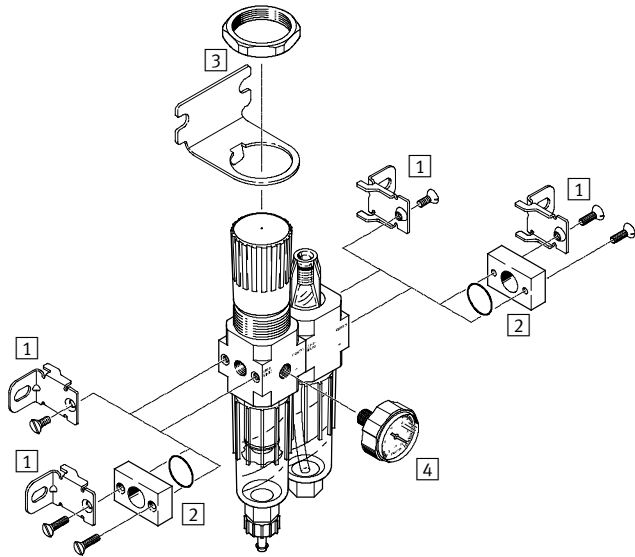
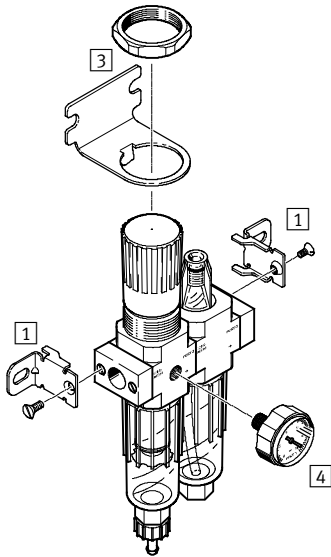

Mounting attachments and accessories			
	with connection plates	without connection plates	→ Page/ Internet
1 Mounting bracket HFOE	■	■	hfoe-d
2 Connecting plate kit PBL	-	■	pbl
3 Mounting bracket with hexagon nut HRS	■	■	hrs-d
4 Pressure gauge MA-27	■	■	31

Service units FRC/FRCS, D series, metal design

Peripherals overview

Mini/Midi/Maxi

Service unit FRC

Service unit FRCS, lockable

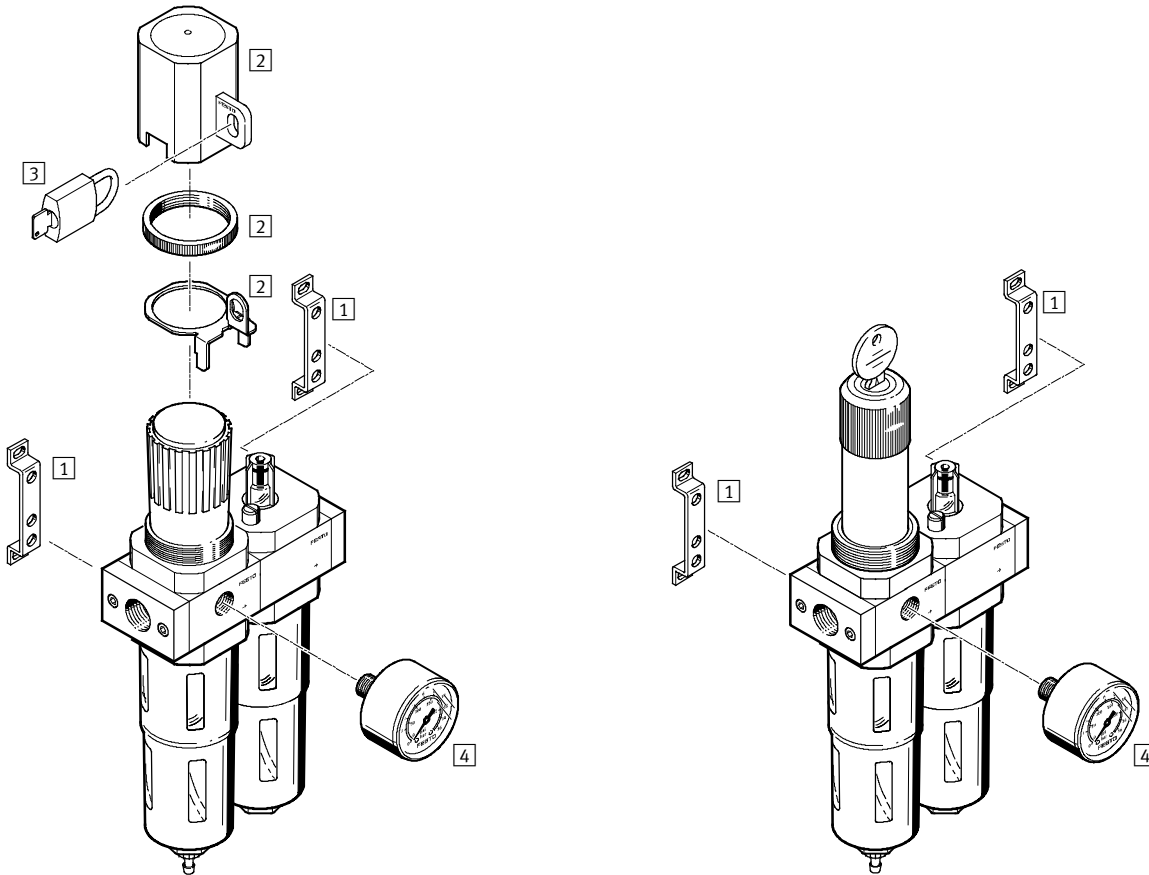

Mounting attachments and accessories				
	Rotary knob with detent	Rotary knob, lockable	→ Page/ Internet	
1	Mounting bracket HFOE	■	■	hfoe-d
2	Regulator lock LRVS	■	-	lrvs-d
3	Padlock LRVS-D	■	-	lrvs-d
4	Pressure gauge MA	■	■	31

Service units FRC/FRCS, D series, metal design

Type codes

FRC – 3/4 – D – – 5M – O – DI – MAXI – A

Basic function

FRC	Service unit
FRCS	Service unit, lockable

Pneumatic connection

M5	Thread M5
M7	Thread M7
QS4	Push-in fitting QS4
QS6	Push-in fitting QS6
1/8	Thread G1/8
1/4	Thread G1/4
3/8	Thread G3/8
1/2	Thread G1/2
3/4	Thread G3/4
1	Thread G1

Series

D	Series
---	--------

Pressure regulation range

	0.5 ... 12 bar
7	0.5 ... 7 bar

Grade of filtration

	40 µm
5M	5 µm

Pressure gauge

	With pressure gauge
O	Without pressure gauge

Function (FRC and MAXI size only)

DI	Directly actuated pressure regulator with integrated return flow function
----	---

Size

MICRO	Grid dimension 25 mm (without connecting plates)
MINI	Grid dimension 40 mm (without connecting plates)
MIDI	Grid dimension 55 mm (without connecting plates)
MAXI	Grid dimension 66 mm (without connecting plates)

Condensate drain

	Turned manually
H	Semi-automatic
A	Fully automatic

Service units FRC/FRCS, D series, metal design

Technical data

FRC/FRCS-...-MICRO/MINI/MIDI
Manual rotary condensate drain,
with pressure gauge

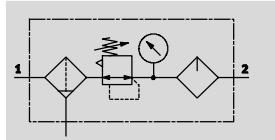

Semi or fully automatic condensate
drain, with pressure gauge

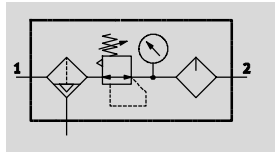

FRC/FRCS-...-MAXI
Manual rotary condensate drain,
with pressure gauge

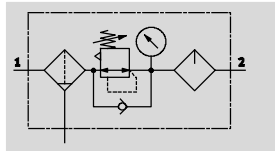

Fully automatic condensate drain,
with pressure gauge

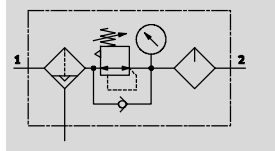

- Flow rate
80 ... 8700 l/min
- Temperature range
-10 ... +60 °C
- Operating pressure
1 ... 16 bar



- Filter, regulator and lubricator functions in a single unit
- High flow rate and highly efficient removal of contaminants
- Good regulating characteristics with minimal pressure hysteresis
- Setting values are secured by locking the rotary knob
- Lockable rotary knob
- Two pressure regulation ranges: 0.5 ... 7 bar and 0.5 ... 12 bar
- Two pressure gauge connections for different fitting options
- With manual, semi-automatic or fully automatic condensate drain
- Choice of filter cartridges: 5 µm or 40 µm
- New filter cartridges → 30

The following oils are recommended for Festo components:

Viscosity range to ISO 3448 class VG 32
32 mm²/s (cSt) at 40 °C

- Festo special oil → 31
- ARAL Vitam GF 32
- BP Energol HLP 32
- Esso Nuto H 32
- Mobil DTE 24
- Shell Tellus Oil DO 32

General technical data																
Size	Micro					Mini			Midi				Maxi			
Pneumatic connection 1, 2	M5	M7	G1/8	QS4	QS6	G1/8	G1/4	G3/8	G1/4	G3/8	G1/2	G3/4	G1/2	G3/4	G1	
Design	Filter regulator with/without pressure gauge															
	Proportional standard mist lubricator															
Type of mounting	Via accessories															
	In-line installation															
Assembly position	Vertical ±5°															
Grade of filtration [µm]	5					5 (air purity class at the output: compressed air in accordance with ISO 8573-1:2010 [6:8:-])										
	-					40 (air purity class at the output: compressed air in accordance with ISO 8573-1:2010 [7:8:-])										
Bowl guard	-					Metal bowl guard										
Condensate drain	Manual rotary															
	Semi-automatic					-										
	-					Fully automatic										
Regulator lock	Rotary knob with detent															
	-					Rotary knob with integrated lock										
Pressure regulation range [bar]	0.5 ... 7					0.5 ... 7			0.5 ... 12							
														0.4		
Max. hysteresis [bar]	0.3					0.2										
Pressure indication	Via pressure gauge															
	M5 prepared					G1/8 prepared			G1/4 prepared				G3/4 prepared			
Max. condensate volume [cm ³]	3					22			43				80 ¹⁾			

1) The max. condensate volume for the FRC-...-DI-MAXI is 43 cm³.
- Note: This product conforms to ISO 1179-1 and to ISO 228-1

Service units FRC/FRCS, D series, metal design

Technical data

Standard nominal flow rate ¹⁾ qnN [l/min]					
Connection	Female thread		Connecting plate		
	M5	M7	G½	QS4	QS6
Micro					
FRC/FRCS	80	170	160	100	160

- 1) Measured at p₁ = 10 bar, p₂ = 6 bar and Δp = 1 bar.
A minimum flow rate of 125 l/min is required for flawless functioning.

Standard nominal flow rate ¹⁾ qnN [l/min]						
Connection	G½	G¼	G¾	G½	G¾	G1
Mini						
FRC/FRCS-...-D-...(-A)	700	1,000	1,200	-	-	-
FRC/FRCS-...-D-7-...(-A)	800	1,300	1,500	-	-	-
FRC/FRCS-...-D-5M-...(-A)	600	850	1,050	-	-	-
Midi						
FRC/FRCS-...-D-...(-A)	-	1,500	2,000	2,600	2,600	-
FRC/FRCS-...-D-7-...(-A)	-	1,700	2,000	2,800	2,800	-
FRC/FRCS-...-D-5M-...(-A)	-	1,300	1,700	1,800	2,100	-
Maxi						
FRC/FRCS-...-D-...(-A)	-	-	-	7,600	8,300	8,500
FRC/FRCS-...-D-7-...(-A)	-	-	-	7,700	8,500	8,700
FRC/FRCS-...-D-5M-...(-A)	-	-	-	6,800	7,000	7,200
Maxi – Directly actuated pressure regulator with integrated return flow function						
FRC-...-D-...(-A)	-	-	-	3,300	3,800	4,000
FRC-...-D-7-...(-A)	-	-	-	4,500	5,000	5,200
FRC-...-D-5M-...(-A)	-	-	-	3,000	3,600	3,800

- 1) Measured at p₁ = 10 bar, p₂ = 6 bar and Δp = 1 bar.
A minimum flow rate of 125 l/min is required for flawless functioning.

Operating and environmental conditions				
Condensate drain	Manual rotary		Semi-automatic	Fully automatic
Size	Micro	Mini/Midi/Maxi	Micro	Mini/Midi/Maxi
Operating pressure [bar]	1 ... 10	1 ... 16	1 ... 10	2 ... 12
Operating medium	Compressed air in accordance with ISO 8573-1:2010 [:-:-:-]	Compressed air in accordance with ISO 8573-1:2010 [:-:9:-]	Compressed air in accordance with ISO 8573-1:2010 [:-:-:-]	Compressed air in accordance with ISO 8573-1:2010 [7:9:-]
	-	Inert gases	-	Inert gases
Note on operating/pilot medium	-	Operation with lubricated medium possible (in which case lubricated operation will always be required)	-	Operation with lubricated medium possible (in which case lubricated operation will always be required)
Ambient temperature [°C]	-10 ... +60			
Temperature of medium [°C]	-10 ... +60			
Storage temperature [°C]	-10 ... +60			
Corrosion resistance class CRC ¹⁾	2			
Certification	Germanischer Lloyd			

- 1) Corrosion resistance class 2 according to Festo standard 940 070
Components subject to moderate corrosion stress. Externally visible parts with primarily decorative surface requirements which are in direct contact with a normal industrial environment or media such as coolants or lubricating agents.

Service units FRC/FRCS, D series, metal design

Technical data

Weight [g]						
Size	Micro		Mini	Midi	Maxi	
	Female thread	Connecting plate			Connection G½, G¾	Connection G1
With pressure gauge						
FRC-...	113	149	660	1,440	2,390	2,520
FRC-...-DI	-	-	-	-	2,670	2,670
FRCS-...	-	-	760	1,680	2,490	2,620
Without pressure gauge						
FRC-...	103	139	600	1,350	2,280	2,460
FRC-...-DI	-	-	-	-	2,600	2,600
FRCS-...	-	-	700	1,590	2,380	2,560

Materials

Sectional view

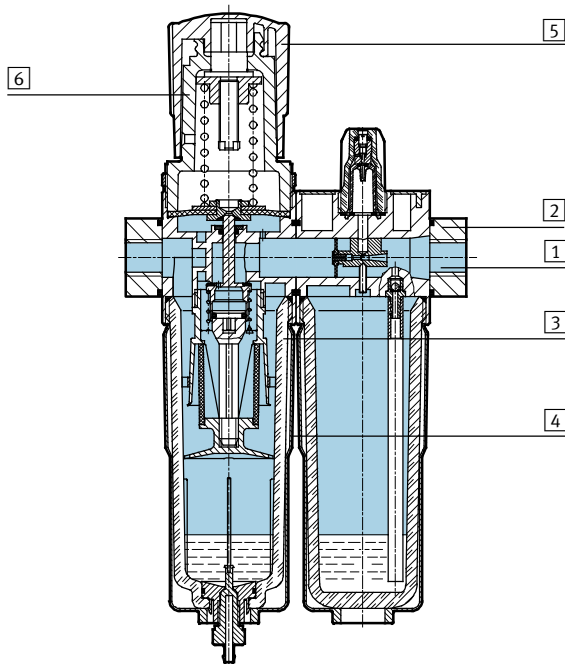

Service units	Micro	Mini/Midi/Maxi
1 Housing	Wrought aluminium alloy	Die-cast zinc/aluminium
2 Connecting plates	Wrought aluminium alloy	Die-cast zinc/aluminium
3 Bowl	PC	PC
4 Metal bowl guard	-	Aluminium
5 Regulating knob	POM	POM
6 Support	PC	-
- Seals	NBR	NBR
Note on materials	-	RoHS-compliant

Service units FRC/FRCS, D series, metal design

Technical data

Standard flow rate q_n as a function of the output pressure p_2

FRC-M5-...-MICRO

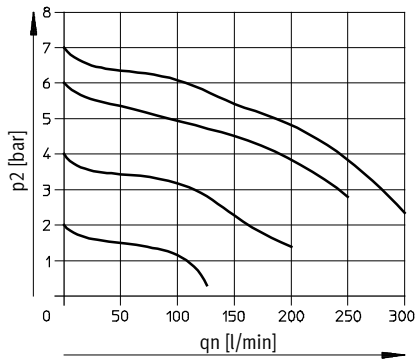

FRC-M7-...-MICRO B

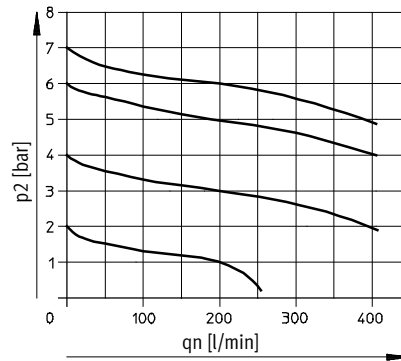

FRC-QS4-...-MICRO

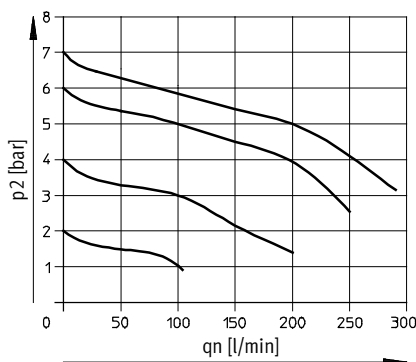

FRC-QS6-...-MICRO and FRC-1/8-...-MICRO

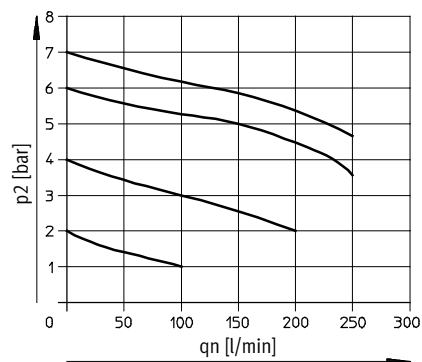

FRC/FRCS-1/4-D-MINI

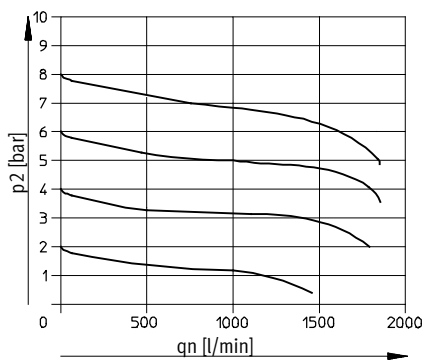

FRC/FRCS-1/2-D-MIDI

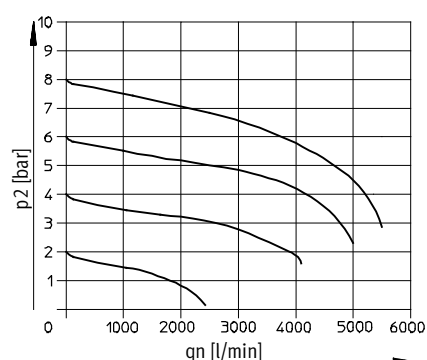

Primary pressure $p_1 = 10$ bar

Service units FRC/FRCS, D series, metal design

Technical data

Standard flow rate q_n as a function of the output pressure p_2

FRC/FRCS-1-D-MAXI

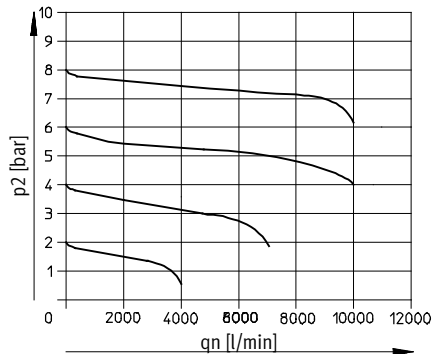

FRC-1-D-DI-MAXI

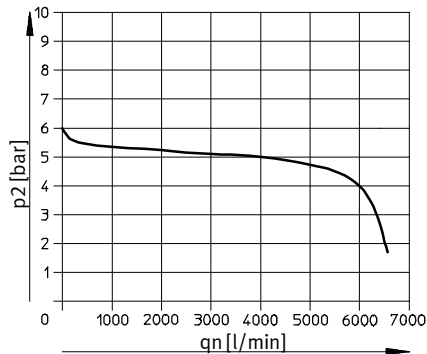

Primary pressure $p_1 = 10$ bar

Note

In order to improve control behaviour, primary-pressure dependent

internal air consumption is provided on the FRC/FRCS-...-MAXI.

Dimensions

Download CAD data → www.festo.com

Micro

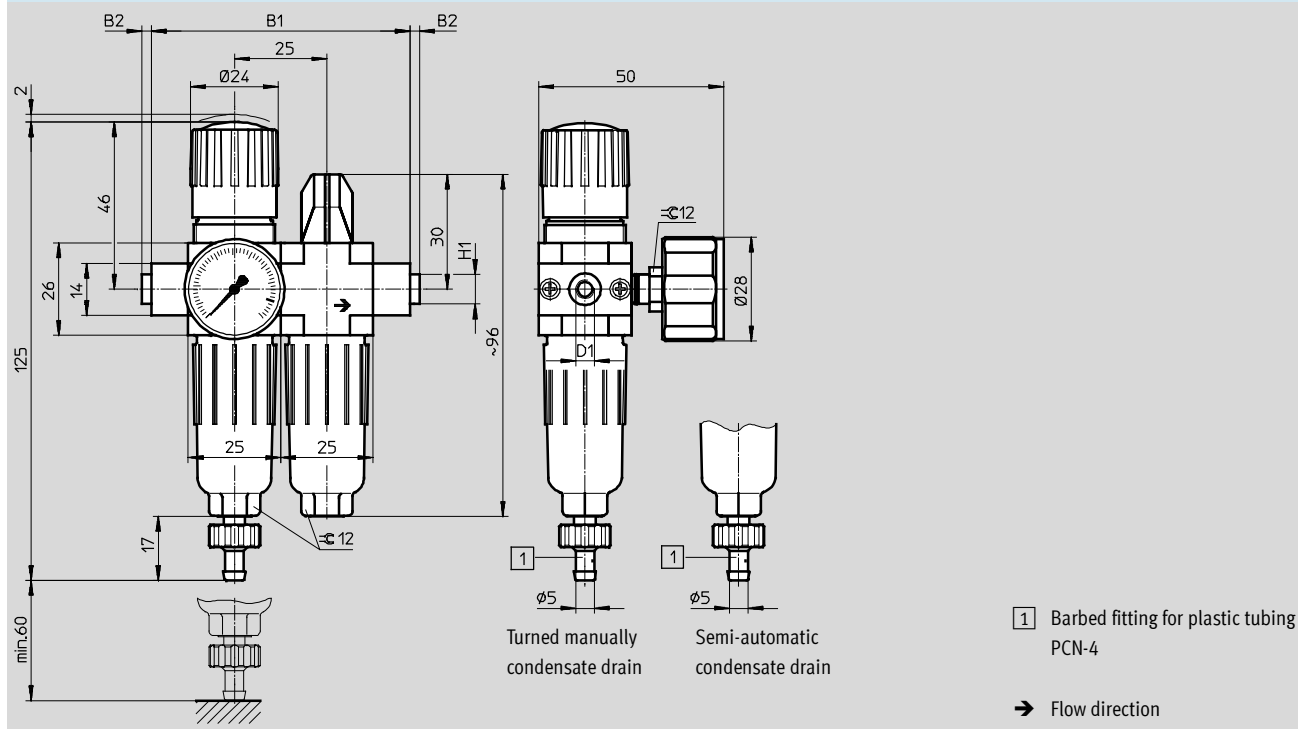

1 Barbed fitting for plastic tubing PCN-4

→ Flow direction

Type	B1	B2	D1	H1
FRC-M5-D-7-5M-MICRO (H)	50	-	M5	-
FRC-M7-D-7-5M-MICRO (H) B			M7	
FRC-1/8-D-7-5M-MICRO (H)			G1/8	
FRC-QS4-D-7-5M-MICRO (H)	70	~2.5	QS4	~8
FRC-QS6-D-7-5M-MICRO (H)			QS6	~10

Note: This product conforms to ISO 1179-1 and to ISO 228-1

Service units FRC/FRCS, D series, metal design

Technical data

Dimensions Download CAD data → www.festo.com

Mini/Midi/Maxi

lockable

Turned manually condensate drain

Fully automatic condensate drain

1 Barbed fitting for plastic tubing PCN-4
2 Metal bowl guard
3 Installation dimensions
4 Second pressure gauge connection
5 Bleed screw for oil reservoir
6 Oil adjusting screw

→ Flow direction

Type	B1	B2	B3	B4	D1	D2 ∅	D3	D4	D5 ∅	D6 ∅
Mini										
FRC/FRCS-1/8-D-MINI	104	92	40	76	G1/8	31	M4	M36x1.5	41	38
FRC/FRCS-1/4-D-MINI					G1/4					
FRC/FRCS-3/8-D-MINI					G3/8					
Midi										
FRC/FRCS-1/4-D-MIDI	140	125	55	95	G1/4	50	M5	M52x1.5	50	52
FRC/FRCS-3/8-D-MIDI					G3/8					
FRC/FRCS-1/2-D-MIDI					G1/2					
FRC/FRCS-3/4-D-MIDI					G3/4					
Maxi										
FRC/FRCS-1/2-D-MAXI	162	146	66	107	G1/2	31	M5	M36x1.5	50	65
FRC-1/2-D-DI-MAXI						49		M52x1.5		
FRC/FRCS-3/4-D-MAXI					31	M36x1.5				
FRC-3/4-D-DI-MAXI						49		M52x1.5		
FRC/FRCS-1-D-MAXI					182	157		G1		
FRC-1-D-DI-MAXI	49	M52x1.5								

— Note: This product conforms to ISO 1179-1 and to ISO 228-1

Service units FRC/FRCS, D series, metal design

Technical data

Type	H1	H2	L1	L2	L3	L4	L5	L6	L7	L8	L9	L10	T1	≈C 1	≈C 2	
Mini																
FRC/FRCS-1/8-D-MINI	20	11	193	169	60	69	100	98	60	15	19	3	7	14	22	
FRC/FRCS-1/4-D-MINI																
FRC/FRCS-3/8-D-MINI																
Midi																
FRC/FRCS-1/4-D-MIDI	32	22	250	204	80	99	120	130	60	15	19	3	8	14	24	
FRC/FRCS-3/8-D-MIDI																
FRC/FRCS-1/2-D-MIDI																
FRC/FRCS-3/4-D-MIDI																
Maxi																
FRC/FRCS-1/2-D-MAXI	32	22	252	228	90	82	150	111	60	15	19	3	8	14	24	
FRC-1/2-D-DI-MAXI			275			105		135								
FRC/FRCS-3/4-D-MAXI			252			82		111								
FRC-3/4-D-DI-MAXI			275			105		135								
FRC/FRCS-1-D-MAXI			40			252		82								111
FRC-1-D-DI-MAXI						275		105								135

Service units FRC/FRCS, D series, metal design

FESTO

Technical data

Ordering data			
Pressure regulation range 0.5 ... 7 bar			
Condensate drain	Size	Connection	Grade of filtration 5 µm
			Part No. Type
With pressure gauge			
Turned manually	Micro	Without threaded connecting plates, connecting thread in housing	
		M5	527860 FRC-M5-D-7-5M-MICRO
		M7	534189 FRC-M7-D-7-5M-MICRO-B
		With threaded connecting plates	
		G ¹ / ₈	527864 FRC- ¹ / ₈ -D-7-5M-MICRO
		With connecting plate and push-in fitting	
		QS4	527876 FRC-QS4-D-7-5M-MICRO
		QS6	527880 FRC-QS6-D-7-5M-MICRO
Semi-automatic	Micro	Without threaded connecting plates, connecting thread in housing	
		M5	527861 FRC-M5-D-7-5M-MICRO-H
		M7	534190 FRC-M7-D-7-5M-MICRO-H-B
		With threaded connecting plates	
		G ¹ / ₈	527865 FRC- ¹ / ₈ -D-7-5M-MICRO-H
		With connecting plate and push-in fitting	
		QS4	527877 FRC-QS4-D-7-5M-MICRO-H
		QS6	527881 FRC-QS6-D-7-5M-MICRO-H
Without pressure gauge			
Turned manually	Micro	Without threaded connecting plates, connecting thread in housing	
		M5	527862 FRC-M5-D-7-0-5M-MICRO
		M7	534191 FRC-M7-D-7-0-5M-MICRO-B
		With threaded connecting plates	
		G ¹ / ₈	527866 FRC- ¹ / ₈ -D-7-0-5M-MICRO
		With connecting plate and push-in fitting	
		QS4	527878 FRC-QS4-D-7-0-5M-MICRO
		QS6	527882 FRC-QS6-D-7-0-5M-MICRO
Semi-automatic	Micro	Without threaded connecting plates, connecting thread in housing	
		M5	527863 FRC-M5-D-7-0-5M-MICRO-H
		M7	534192 FRC-M7-D-7-0-5M-MICRO-H-B
		With threaded connecting plates	
		G ¹ / ₈	527867 FRC- ¹ / ₈ -D-7-0-5M-MICRO-H
		With connecting plate and push-in fitting	
		QS4	527879 FRC-QS4-D-7-0-5M-MICRO-H
		QS6	527883 FRC-QS6-D-7-0-5M-MICRO-H

Service units FRC/FRCS, D series, metal design

Technical data

Ordering data							
Pressure regulation range 0.5 ... 12 bar, metal bowl guard							
Condensate drain	Size	Connection	Grade of filtration 5 µm		Grade of filtration 40 µm		
			Part No.	Type	Part No.	Type	
With pressure gauge							
Turned manually	Mini	G1/8	162770	FRC-1/8-D-5M-MINI	159604	FRC-1/8-D-MINI	
		G1/4	162771	FRC-1/4-D-5M-MINI	159605	FRC-1/4-D-MINI	
		G3/8	162772	FRC-3/8-D-5M-MINI	162734	FRC-3/8-D-MINI	
	Midi	G1/4	186499	FRC-1/4-D-5M-MIDI	186497	FRC-1/4-D-MIDI	
		G3/8	162773	FRC-3/8-D-5M-MIDI	159588	FRC-3/8-D-MIDI	
		G1/2	162774	FRC-1/2-D-5M-MIDI	159590	FRC-1/2-D-MIDI	
		G3/4	162775	FRC-3/4-D-5M-MIDI	162735	FRC-3/4-D-MIDI	
	Maxi	G1/2	186507	FRC-1/2-D-5M-MAXI	186505	FRC-1/2-D-MAXI	
		G3/4	162776	FRC-3/4-D-5M-MAXI	159606	FRC-3/4-D-MAXI	
		G1	162777	FRC-1-D-5M-MAXI	159607	FRC-1-D-MAXI	
	Fully automatic						
	Fully automatic	Mini	G1/8	162778	FRC-1/8-D-5M-MINI-A	159608	FRC-1/8-D-MINI-A
G1/4			162779	FRC-1/4-D-5M-MINI-A	159609	FRC-1/4-D-MINI-A	
G3/8			162780	FRC-3/8-D-5M-MINI-A	162736	FRC-3/8-D-MINI-A	
Midi		G1/4	186502	FRC-1/4-D-5M-MIDI-A	186500	FRC-1/4-D-MIDI-A	
		G3/8	162781	FRC-3/8-D-5M-MIDI-A	159589	FRC-3/8-D-MIDI-A	
		G1/2	162782	FRC-1/2-D-5M-MIDI-A	159591	FRC-1/2-D-MIDI-A	
		G3/4	162783	FRC-3/4-D-5M-MIDI-A	162737	FRC-3/4-D-MIDI-A	
Maxi		G1/2	186510	FRC-1/2-D-5M-MAXI-A	186508	FRC-1/2-D-MAXI-A	
		G3/4	162784	FRC-3/4-D-5M-MAXI-A	159610	FRC-3/4-D-MAXI-A	
		G1	162785	FRC-1-D-5M-MAXI-A	159611	FRC-1-D-MAXI-A	
Without pressure gauge							
Turned manually		Mini	G1/8	192650	FRC-1/8-D-5M-O-MINI	162738	FRC-1/8-D-O-MINI
	G1/4		192651	FRC-1/4-D-5M-O-MINI	162739	FRC-1/4-D-O-MINI	
	G3/8		192652	FRC-3/8-D-5M-O-MINI	162740	FRC-3/8-D-O-MINI	
	Midi	G1/4	192653	FRC-1/4-D-5M-O-MIDI	186498	FRC-1/4-D-O-MIDI	
		G3/8	192654	FRC-3/8-D-5M-O-MIDI	162741	FRC-3/8-D-O-MIDI	
		G1/2	192655	FRC-1/2-D-5M-O-MIDI	162742	FRC-1/2-D-O-MIDI	
		G3/4	192656	FRC-3/4-D-5M-O-MIDI	162743	FRC-3/4-D-O-MIDI	
	Maxi	G1/2	192657	FRC-1/2-D-5M-O-MAXI	186506	FRC-1/2-D-O-MAXI	
		G3/4	192658	FRC-3/4-D-5M-O-MAXI	162744	FRC-3/4-D-O-MAXI	
		G1	192659	FRC-1-D-5M-O-MAXI	162745	FRC-1-D-O-MAXI	
	Fully automatic						
	Fully automatic	Mini	G1/8	192660	FRC-1/8-D-5M-O-MINI-A	162746	FRC-1/8-D-O-MINI-A
G1/4			192661	FRC-1/4-D-5M-O-MINI-A	162747	FRC-1/4-D-O-MINI-A	
G3/8			192662	FRC-3/8-D-5M-O-MINI-A	162748	FRC-3/8-D-O-MINI-A	
Midi		G1/4	192663	FRC-1/4-D-5M-O-MIDI-A	186501	FRC-1/4-D-O-MIDI-A	
		G3/8	192664	FRC-3/8-D-5M-O-MIDI-A	162749	FRC-3/8-D-O-MIDI-A	
		G1/2	192665	FRC-1/2-D-5M-O-MIDI-A	162750	FRC-1/2-D-O-MIDI-A	
		G3/4	192666	FRC-3/4-D-5M-O-MIDI-A	162751	FRC-3/4-D-O-MIDI-A	
Maxi		G1/2	192667	FRC-1/2-D-5M-O-MAXI-A	186509	FRC-1/2-D-O-MAXI-A	
		G3/4	192668	FRC-3/4-D-5M-O-MAXI-A	162752	FRC-3/4-D-O-MAXI-A	
		G1	192669	FRC-1-D-5M-O-MAXI-A	162753	FRC-1-D-O-MAXI-A	

Service units FRC/FRCS, D series, metal design

FESTO

Technical data

Ordering data				
Pressure regulation range 0.5 ... 7 bar, metal bowl guard				
Condensate drain	Size	Connection	Grade of filtration 40 µm	
			Part No.	Type
With pressure gauge				
Turned manually	Mini	G $\frac{1}{8}$	162754	FRC- $\frac{1}{8}$ -D-7-MINI
		G $\frac{1}{4}$	162755	FRC- $\frac{1}{4}$ -D-7-MINI
		G $\frac{3}{8}$	162756	FRC- $\frac{3}{8}$ -D-7-MINI
	Midi	G $\frac{1}{4}$	186503	FRC- $\frac{1}{4}$ -D-7-MIDI
		G $\frac{3}{8}$	162757	FRC- $\frac{3}{8}$ -D-7-MIDI
		G $\frac{1}{2}$	162758	FRC- $\frac{1}{2}$ -D-7-MIDI
		G $\frac{3}{4}$	162759	FRC- $\frac{3}{4}$ -D-7-MIDI
	Maxi	G $\frac{1}{2}$	186511	FRC- $\frac{1}{2}$ -D-7-MAXI
		G $\frac{3}{4}$	162760	FRC- $\frac{3}{4}$ -D-7-MAXI
G1		162761	FRC-1-D-7-MAXI	
Fully automatic				
Fully automatic	Mini	G $\frac{1}{8}$	162762	FRC- $\frac{1}{8}$ -D-7-MINI-A
		G $\frac{1}{4}$	162763	FRC- $\frac{1}{4}$ -D-7-MINI-A
		G $\frac{3}{8}$	162764	FRC- $\frac{3}{8}$ -D-7-MINI-A
	Midi	G $\frac{1}{4}$	186504	FRC- $\frac{1}{4}$ -D-7-MIDI-A
		G $\frac{3}{8}$	162765	FRC- $\frac{3}{8}$ -D-7-MIDI-A
		G $\frac{1}{2}$	162766	FRC- $\frac{1}{2}$ -D-7-MIDI-A
		G $\frac{3}{4}$	162767	FRC- $\frac{3}{4}$ -D-7-MIDI-A
	Maxi	G $\frac{1}{2}$	186512	FRC- $\frac{1}{2}$ -D-7-MAXI-A
		G $\frac{3}{4}$	162768	FRC- $\frac{3}{4}$ -D-7-MAXI-A
G1		162769	FRC-1-D-7-MAXI-A	
Without pressure gauge				
Turned manually	Mini	G $\frac{1}{8}$	192630	FRC- $\frac{1}{8}$ -D-7-O-MINI
		G $\frac{1}{4}$	192631	FRC- $\frac{1}{4}$ -D-7-O-MINI
		G $\frac{3}{8}$	192632	FRC- $\frac{3}{8}$ -D-7-O-MINI
	Midi	G $\frac{1}{4}$	192633	FRC- $\frac{1}{4}$ -D-7-O-MIDI
		G $\frac{3}{8}$	192634	FRC- $\frac{3}{8}$ -D-7-O-MIDI
		G $\frac{1}{2}$	192635	FRC- $\frac{1}{2}$ -D-7-O-MIDI
		G $\frac{3}{4}$	192636	FRC- $\frac{3}{4}$ -D-7-O-MIDI
	Maxi	G $\frac{1}{2}$	192637	FRC- $\frac{1}{2}$ -D-7-O-MAXI
		G $\frac{3}{4}$	192638	FRC- $\frac{3}{4}$ -D-7-O-MAXI
G1		192639	FRC-1-D-7-O-MAXI	
Fully automatic				
Fully automatic	Mini	G $\frac{1}{8}$	192640	FRC- $\frac{1}{8}$ -D-7-O-MINI-A
		G $\frac{1}{4}$	192641	FRC- $\frac{1}{4}$ -D-7-O-MINI-A
		G $\frac{3}{8}$	192642	FRC- $\frac{3}{8}$ -D-7-O-MINI-A
	Midi	G $\frac{1}{4}$	192643	FRC- $\frac{1}{4}$ -D-7-O-MIDI-A
		G $\frac{3}{8}$	192644	FRC- $\frac{3}{8}$ -D-7-O-MIDI-A
		G $\frac{1}{2}$	192645	FRC- $\frac{1}{2}$ -D-7-O-MIDI-A
		G $\frac{3}{4}$	192646	FRC- $\frac{3}{4}$ -D-7-O-MIDI-A
	Maxi	G $\frac{1}{2}$	192647	FRC- $\frac{1}{2}$ -D-7-O-MAXI-A
		G $\frac{3}{4}$	192648	FRC- $\frac{3}{4}$ -D-7-O-MAXI-A
G1		192649	FRC-1-D-7-O-MAXI-A	

Service units FRC/FRCS, D series, metal design

FESTO

Technical data

Ordering data						
Pressure regulation range 0.5 ... 12 bar, directly actuated pressure regulator with integrated return flow function, metal bowl guard						
Condensate drain	Size	Connection	Grade of filtration 5 µm		Grade of filtration 40 µm	
			Part No.	Type	Part No.	Type
With pressure gauge						
Turned manually	Maxi	G1/2	192406	FRC-1/2-D-5M-DI-MAXI	192404	FRC-1/2-D-DI-MAXI
		G3/4	192412	FRC-3/4-D-5M-DI-MAXI	192410	FRC-3/4-D-DI-MAXI
		G1	192418	FRC-1-D-5M-DI-MAXI	192416	FRC-1-D-DI-MAXI
Fully automatic	Maxi	G1/2	192424	FRC-1/2-D-5M-DI-MAXI-A	192422	FRC-1/2-D-DI-MAXI-A
		G3/4	192430	FRC-3/4-D-5M-DI-MAXI-A	192428	FRC-3/4-D-DI-MAXI-A
		G1	192436	FRC-1-D-5M-DI-MAXI-A	192434	FRC-1-D-DI-MAXI-A
Without pressure gauge						
Turned manually	Maxi	G1/2	192407	FRC-1/2-D-5M-O-DI-MAXI	192405	FRC-1/2-D-O-DI-MAXI
		G3/4	192413	FRC-3/4-D-5M-O-DI-MAXI	192411	FRC-3/4-D-O-DI-MAXI
		G1	192419	FRC-1-D-5M-O-DI-MAXI	192417	FRC-1-D-O-DI-MAXI
Fully automatic	Maxi	G1/2	192425	FRC-1/2-D-5M-O-DI-MAXI-A	192423	FRC-1/2-D-O-DI-MAXI-A
		G3/4	192431	FRC-3/4-D-5M-O-DI-MAXI-A	192429	FRC-3/4-D-O-DI-MAXI-A
		G1	192437	FRC-1-D-5M-O-DI-MAXI-A	192435	FRC-1-D-O-DI-MAXI-A

Ordering data						
Pressure regulation range 0.5 ... 7 bar, directly actuated pressure regulator with integrated return flow function, metal bowl guard						
Condensate drain	Size	Connection	Grade of filtration 5 µm		Grade of filtration 40 µm	
			Part No.	Type	Part No.	Type
With pressure gauge						
Turned manually	Maxi	G1/2	-	-	192408	FRC-1/2-D-7-DI-MAXI
		G3/4	-	-	192414	FRC-3/4-D-7-DI-MAXI
		G1	-	-	192420	FRC-1-D-7-DI-MAXI
Fully automatic	Maxi	G1/2	-	-	192426	FRC-1/2-D-7-DI-MAXI-A
		G3/4	-	-	192432	FRC-3/4-D-7-DI-MAXI-A
		G1	-	-	192438	FRC-1-D-7-DI-MAXI-A
Without pressure gauge						
Turned manually	Maxi	G1/2	-	-	192409	FRC-1/2-D-7-O-DI-MAXI
		G3/4	-	-	192415	FRC-3/4-D-7-O-DI-MAXI
		G1	-	-	192421	FRC-1-D-7-O-DI-MAXI
Fully automatic	Maxi	G1/2	-	-	192427	FRC-1/2-D-7-O-DI-MAXI-A
		G3/4	-	-	192433	FRC-3/4-D-7-O-DI-MAXI-A
		G1	-	-	192439	FRC-1-D-7-O-DI-MAXI-A

Service units FRC/FRCS, D series, metal design

Technical data

Ordering data							
Pressure regulation range 0.5 ... 12 bar, metal bowl guard, lockable							
Condensate drain	Size	Connection	Grade of filtration 5 µm		Grade of filtration 40 µm		
			Part No.	Type	Part No.	Type	
With pressure gauge							
Turned manually	Mini	G $\frac{1}{8}$	194860	FRCS- $\frac{1}{8}$ -D-5M-MINI	194852	FRCS- $\frac{1}{8}$ -D-MINI	
		G $\frac{1}{4}$	194872	FRCS- $\frac{1}{4}$ -D-5M-MINI	194864	FRCS- $\frac{1}{4}$ -D-MINI	
		G $\frac{3}{8}$	194884	FRCS- $\frac{3}{8}$ -D-5M-MINI	194876	FRCS- $\frac{3}{8}$ -D-MINI	
	Midi	G $\frac{1}{4}$	194896	FRCS- $\frac{1}{4}$ -D-5M-MIDI	194888	FRCS- $\frac{1}{4}$ -D-MIDI	
		G $\frac{3}{8}$	194908	FRCS- $\frac{3}{8}$ -D-5M-MIDI	194900	FRCS- $\frac{3}{8}$ -D-MIDI	
		G $\frac{1}{2}$	194920	FRCS- $\frac{1}{2}$ -D-5M-MIDI	194912	FRCS- $\frac{1}{2}$ -D-MIDI	
		G $\frac{3}{4}$	194932	FRCS- $\frac{3}{4}$ -D-5M-MIDI	194924	FRCS- $\frac{3}{4}$ -D-MIDI	
	Maxi	G $\frac{1}{2}$	194944	FRCS- $\frac{1}{2}$ -D-5M-MAXI	194936	FRCS- $\frac{1}{2}$ -D-MAXI	
		G $\frac{3}{4}$	194956	FRCS- $\frac{3}{4}$ -D-5M-MAXI	194948	FRCS- $\frac{3}{4}$ -D-MAXI	
		G1	194968	FRCS-1-D-5M-MAXI	194960	FRCS-1-D-MAXI	
	Fully automatic						
	Fully automatic	Mini	G $\frac{1}{8}$	194862	FRCS- $\frac{1}{8}$ -D-5M-MINI-A	194853	FRCS- $\frac{1}{8}$ -D-MINI-A
G $\frac{1}{4}$			194874	FRCS- $\frac{1}{4}$ -D-5M-MINI-A	194865	FRCS- $\frac{1}{4}$ -D-MINI-A	
G $\frac{3}{8}$			194886	FRCS- $\frac{3}{8}$ -D-5M-MINI-A	194877	FRCS- $\frac{3}{8}$ -D-MINI-A	
Midi		G $\frac{1}{4}$	194898	FRCS- $\frac{1}{4}$ -D-5M-MIDI-A	194889	FRCS- $\frac{1}{4}$ -D-MIDI-A	
		G $\frac{3}{8}$	194910	FRCS- $\frac{3}{8}$ -D-5M-MIDI-A	194901	FRCS- $\frac{3}{8}$ -D-MIDI-A	
		G $\frac{1}{2}$	194922	FRCS- $\frac{1}{2}$ -D-5M-MIDI-A	194913	FRCS- $\frac{1}{2}$ -D-MIDI-A	
		G $\frac{3}{4}$	194934	FRCS- $\frac{3}{4}$ -D-5M-MIDI-A	194925	FRCS- $\frac{3}{4}$ -D-MIDI-A	
Maxi		G $\frac{1}{2}$	194946	FRCS- $\frac{1}{2}$ -D-5M-MAXI-A	194937	FRCS- $\frac{1}{2}$ -D-MAXI-A	
		G $\frac{3}{4}$	194958	FRCS- $\frac{3}{4}$ -D-5M-MAXI-A	194949	FRCS- $\frac{3}{4}$ -D-MAXI-A	
		G1	194970	FRCS-1-D-5M-MAXI-A	194961	FRCS-1-D-MAXI-A	
Without pressure gauge							
Turned manually		Mini	G $\frac{1}{8}$	194861	FRCS- $\frac{1}{8}$ -D-5M-O-MINI	194854	FRCS- $\frac{1}{8}$ -D-O-MINI
	G $\frac{1}{4}$		194873	FRCS- $\frac{1}{4}$ -D-5M-O-MINI	194866	FRCS- $\frac{1}{4}$ -D-O-MINI	
	G $\frac{3}{8}$		194885	FRCS- $\frac{3}{8}$ -D-5M-O-MINI	194878	FRCS- $\frac{3}{8}$ -D-O-MINI	
	Midi	G $\frac{1}{4}$	194897	FRCS- $\frac{1}{4}$ -D-5M-O-MIDI	194890	FRCS- $\frac{1}{4}$ -D-O-MIDI	
		G $\frac{3}{8}$	194909	FRCS- $\frac{3}{8}$ -D-5M-O-MIDI	194902	FRCS- $\frac{3}{8}$ -D-O-MIDI	
		G $\frac{1}{2}$	194921	FRCS- $\frac{1}{2}$ -D-5M-O-MIDI	194914	FRCS- $\frac{1}{2}$ -D-O-MIDI	
		G $\frac{3}{4}$	194933	FRCS- $\frac{3}{4}$ -D-5M-O-MIDI	194926	FRCS- $\frac{3}{4}$ -D-O-MIDI	
	Maxi	G $\frac{1}{2}$	194945	FRCS- $\frac{1}{2}$ -D-5M-O-MAXI	194938	FRCS- $\frac{1}{2}$ -D-O-MAXI	
		G $\frac{3}{4}$	194957	FRCS- $\frac{3}{4}$ -D-5M-O-MAXI	194950	FRCS- $\frac{3}{4}$ -D-O-MAXI	
		G1	194969	FRCS-1-D-5M-O-MAXI	194962	FRCS-1-D-O-MAXI	
	Fully automatic						
	Fully automatic	Mini	G $\frac{1}{8}$	194863	FRCS- $\frac{1}{8}$ -D-5M-O-MINI-A	194855	FRCS- $\frac{1}{8}$ -D-O-MINI-A
G $\frac{1}{4}$			194875	FRCS- $\frac{1}{4}$ -D-5M-O-MINI-A	194867	FRCS- $\frac{1}{4}$ -D-O-MINI-A	
G $\frac{3}{8}$			194887	FRCS- $\frac{3}{8}$ -D-5M-O-MINI-A	194879	FRCS- $\frac{3}{8}$ -D-O-MINI-A	
Midi		G $\frac{1}{4}$	194899	FRCS- $\frac{1}{4}$ -D-5M-O-MIDI-A	194891	FRCS- $\frac{1}{4}$ -D-O-MIDI-A	
		G $\frac{3}{8}$	194911	FRCS- $\frac{3}{8}$ -D-5M-O-MIDI-A	194903	FRCS- $\frac{3}{8}$ -D-O-MIDI-A	
		G $\frac{1}{2}$	194923	FRCS- $\frac{1}{2}$ -D-5M-O-MIDI-A	194915	FRCS- $\frac{1}{2}$ -D-O-MIDI-A	
		G $\frac{3}{4}$	194935	FRCS- $\frac{3}{4}$ -D-5M-O-MIDI-A	194927	FRCS- $\frac{3}{4}$ -D-O-MIDI-A	
Maxi		G $\frac{1}{2}$	194947	FRCS- $\frac{1}{2}$ -D-5M-O-MAXI-A	194939	FRCS- $\frac{1}{2}$ -D-O-MAXI-A	
		G $\frac{3}{4}$	194959	FRCS- $\frac{3}{4}$ -D-5M-O-MAXI-A	194951	FRCS- $\frac{3}{4}$ -D-O-MAXI-A	
		G1	194971	FRCS-1-D-5M-O-MAXI-A	194963	FRCS-1-D-O-MAXI-A	



Service units FRC/FRCS, D series, metal design

Technical data

Ordering data				
Pressure regulation range 0.5 ... 7 bar, metal bowl guard, lockable				
Condensate drain	Size	Connection	Grade of filtration 40 µm	
			Part No.	Type
With pressure gauge				
Turned manually	Mini	G1/8	194856	FRCS-1/8-D-7-MINI
		G1/4	194868	FRCS-1/4-D-7-MINI
		G3/8	194880	FRCS-3/8-D-7-MINI
	Midi	G1/4	194892	FRCS-1/4-D-7-MIDI
		G3/8	194904	FRCS-3/8-D-7-MIDI
		G1/2	194916	FRCS-1/2-D-7-MIDI
		G3/4	194928	FRCS-3/4-D-7-MIDI
	Maxi	G1/2	194940	FRCS-1/2-D-7-MAXI
		G3/4	194952	FRCS-3/4-D-7-MAXI
		G1	194964	FRCS-1-D-7-MAXI
Fully automatic				
Fully automatic	Mini	G1/8	194858	FRCS-1/8-D-7-MINI-A
		G1/4	194870	FRCS-1/4-D-7-MINI-A
		G3/8	194882	FRCS-3/8-D-7-MINI-A
	Midi	G1/4	194894	FRCS-1/4-D-7-MIDI-A
		G3/8	194906	FRCS-3/8-D-7-MIDI-A
		G1/2	194918	FRCS-1/2-D-7-MIDI-A
		G3/4	194930	FRCS-3/4-D-7-MIDI-A
	Maxi	G1/2	194942	FRCS-1/2-D-7-MAXI-A
		G3/4	194954	FRCS-3/4-D-7-MAXI-A
		G1	194966	FRCS-1-D-7-MAXI-A
Without pressure gauge				
Turned manually	Mini	G1/8	194857	FRCS-1/8-D-7-O-MINI
		G1/4	194869	FRCS-1/4-D-7-O-MINI
		G3/8	194881	FRCS-3/8-D-7-O-MINI
	Midi	G1/4	194893	FRCS-1/4-D-7-O-MIDI
		G3/8	194905	FRCS-3/8-D-7-O-MIDI
		G1/2	194917	FRCS-1/2-D-7-O-MIDI
		G3/4	194929	FRCS-3/4-D-7-O-MIDI
	Maxi	G1/2	194941	FRCS-1/2-D-7-O-MAXI
		G3/4	194953	FRCS-3/4-D-7-O-MAXI
		G1	194965	FRCS-1-D-7-O-MAXI
Fully automatic				
Fully automatic	Mini	G1/8	194859	FRCS-1/8-D-7-O-MINI-A
		G1/4	194871	FRCS-1/4-D-7-O-MINI-A
		G3/8	194883	FRCS-3/8-D-7-O-MINI-A
	Midi	G1/4	194895	FRCS-1/4-D-7-O-MIDI-A
		G3/8	194907	FRCS-3/8-D-7-O-MIDI-A
		G1/2	194919	FRCS-1/2-D-7-O-MIDI-A
		G3/4	194931	FRCS-3/4-D-7-O-MIDI-A
	Maxi	G1/2	194943	FRCS-1/2-D-7-O-MAXI-A
		G3/4	194955	FRCS-3/4-D-7-O-MAXI-A
		G1	194967	FRCS-1-D-7-O-MAXI-A

Service units FRC, D series, polymer

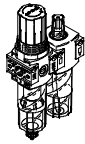
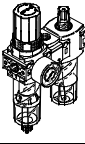
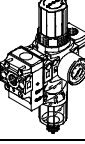
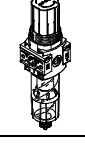
Product range overview D series service units, polymer

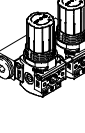
Type	Size	Pneumatic connection			Pressure regulation range [bar]	Grade of filtration [µm]		
		G1/8	G1/4	G1/2		5	40	
Service units								
FRC		Mini	■	■	-	■	■	■
Service unit combinations								
FRC-K		Mini	-	■	-	■	-	■
LFR-K		Mini	-	■	-	■	-	■
Individual devices								
Filter regulators LFR		Mini	■	■	-	■	■	■
Pressure regulators LR		Mini	■	■	-	■	-	-
Pressure regulator combinations LRB-K		Mini	-	-	■	■	-	-

Service units FRC, D series, polymer

Product range overview D series service units, polymer



Type	Size	Condensate drain		Pressure display		Actuator lock	Regulating functions		→ Page/ Internet
		Manual rotary	Semi-automatic	With pressure gauge	Without pressure gauge		With secondary venting	With return flow function	
Service units									
FRC	Mini	■	■	■	-	■	■	■	24
Service unit combinations									
FRC-K	Mini	■	-	■	-	■	■	■	frc
LFR-K	Mini	■	-	■	-	■	■	■	lfr
Individual devices									
Filter regulators LFR	Mini	■	■	■	■	■	■	■	lfr
Pressure regulators LR	Mini	-	-	■	■	■	■	■	lr
Pressure regulator combinations LRB-K	Mini	-	-	-	■	■	■	■	lrb

Service units FRC, D series, polymer

Peripherals overview

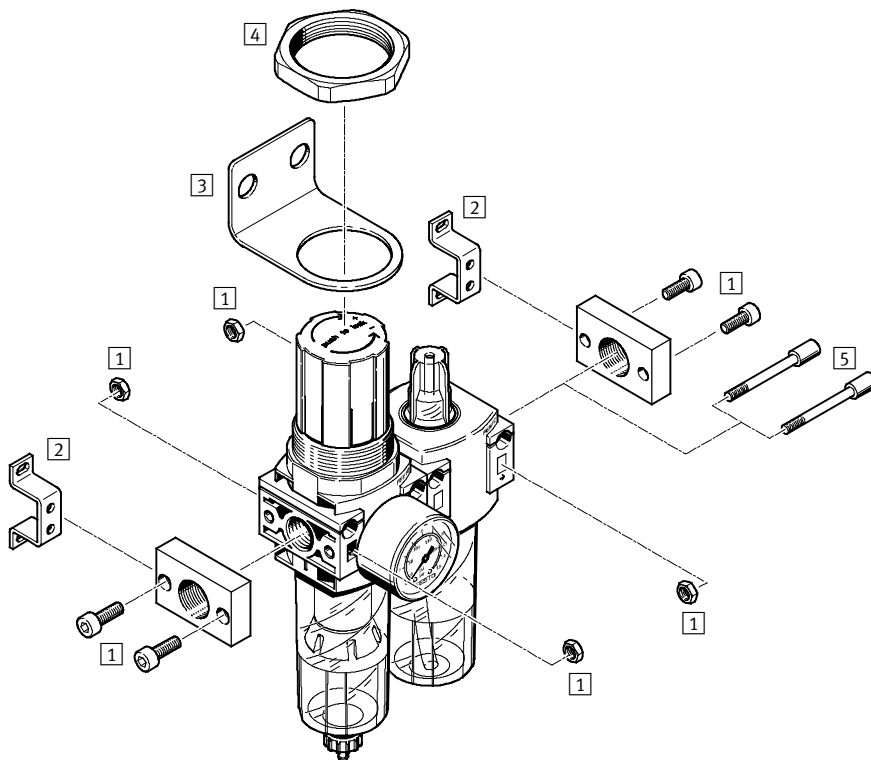

Mounting attachments and accessories		→ Page/ Internet
1	Connecting plate kit PBL	pbl
2	Mounting bracket HFOE	hfoe-d
3	Mounting bracket HR-D	hr-d
4	Hex nut HMR	hmr-d
5	Threaded pin FRB	frb-db

Service units FRC, D series, polymer

Type codes

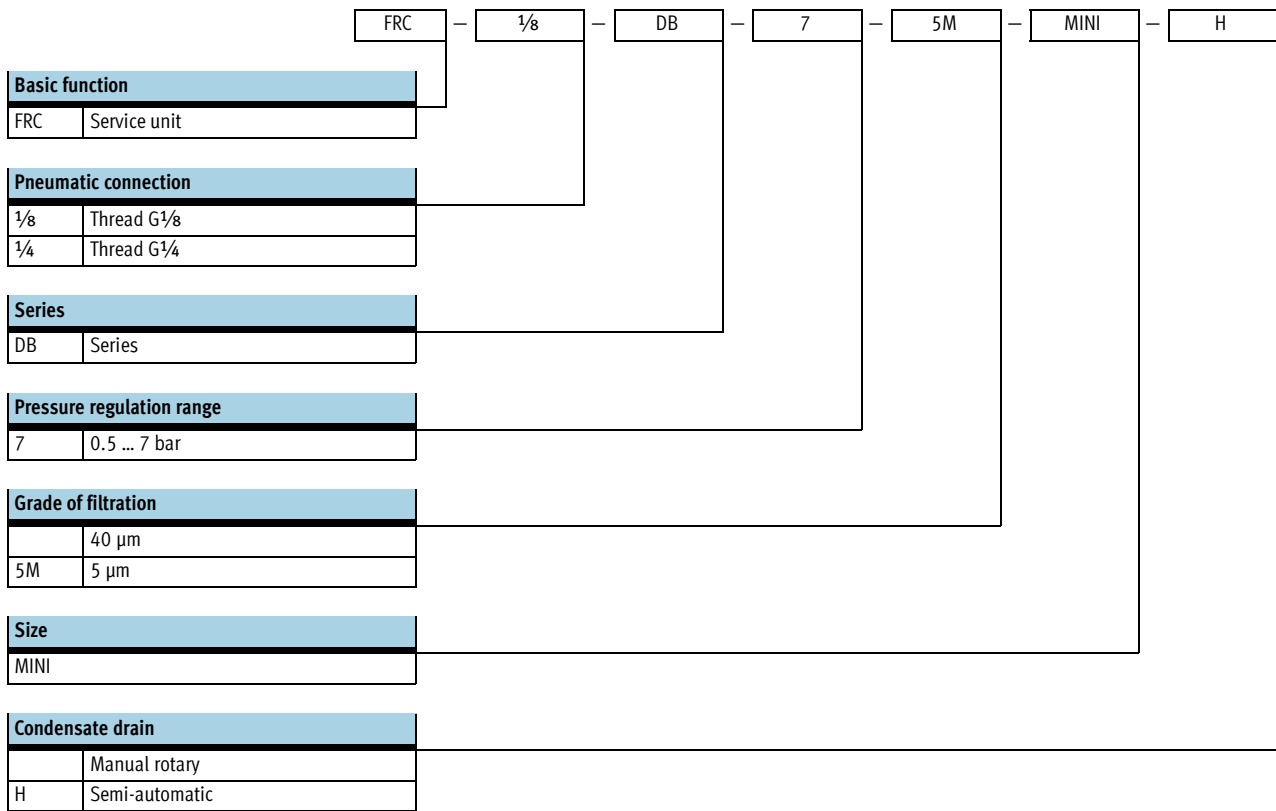

Service units FRC, D series, polymer

Technical data

FESTO

Manual rotary condensate drain

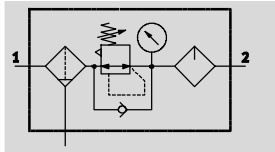

- - Flow rate
400 ... 650 l/min

- - Temperature range
-5 ... +50 °C

Semi-automatic condensate drain

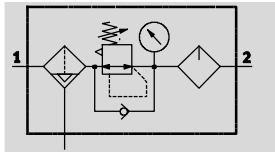

- - Operating pressure
1.5 ... 10 bar



- Filter, regulator and lubricator functions in a single unit
- High flow rate and highly efficient removal of contaminants
- Good regulating characteristics with minimal pressure hysteresis
- Setting values are secured by means of the rotary knob with detent
- With manual or semi-automatic condensate drain
- New filter cartridges → 30

The following oils are recommended for Festo components:

Viscosity range to ISO 3448 class VG 32
32 mm²/s (cSt) at 40 °C

- Festo special oil → 31
- ARAL Vitam GF 32
- BP Energol HLP 32
- Esso Nuto H 32
- Mobil DTE 24
- Shell Tellus Oil DO 32

General technical data	
Size	Mini
Pneumatic connection	G ³ / ₈ G ¹ / ₄
Design	Filter/regulator/lubricator
Regulating function	With return flow function, with secondary venting
Type of mounting	Inline installation Via through-holes Via mounting bracket
Assembly position	Vertical ±5°
Grade of filtration [µm]	5 40
Condensate drain	Manual rotary Semi-automatic
Regulator lock	Rotary knob with detent
Pressure regulation range [bar]	0.5 ... 7
Max. hysteresis [bar]	0.5
Pressure indication	Via pressure gauge
Pressure gauge connection	G ³ / ₈

Standard nominal flow rate ¹⁾ qnN [l/min]	
Pneumatic connection	G ³ / ₈ G ¹ / ₄
Mini	
Grade of filtration	5 µm ≥ 400 ≥ 550 40 µm ≥ 550 ≥ 650

1) Measured at p₁ = 10 bar, p₂ = 6 bar and Δp = 1 bar.

Service units FRC, D series, polymer

Technical data

Operating and environmental conditions	
Size	Mini
Operating pressure [bar]	1.5 ... 10
Operating medium	Compressed air in accordance with ISO 8573-1:2010 [-:-:-]
Ambient temperature [°C]	-5 ... +50
Temperature of medium [°C]	-5 ... +50
Storage temperature [°C]	-5 ... +50
Corrosion resistance class CRC ¹⁾	1

1) Corrosion resistance class 1 according to Festo standard 940 070
 Components requiring low corrosion resistance. Transport and storage protection. Parts that do not have primarily decorative surface requirements, e.g. in internal areas that are not visible or behind covers.

Weight [g]	
Size	Mini
Service unit	300

Materials

Sectional view

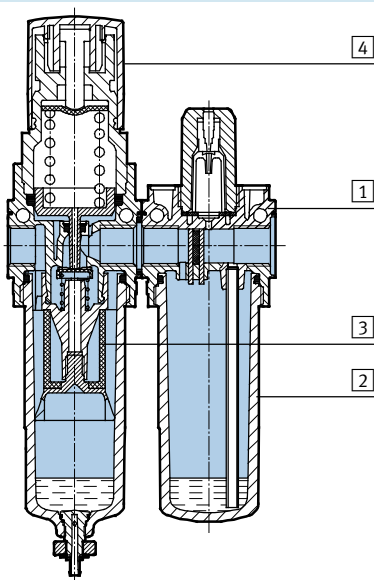

Service unit	Mini
1 Housing	PA, reinforced
2 Bowl	PC
3 Filter	PE
4 Rotary knob	POM
- Seals	NBR

Service units FRC, D series, polymer

Technical data



Standard flow rate q_n as a function of output pressure p_2

Pneumatic connection G $\frac{3}{8}$

Grade of filtration 5 μm

Grade of filtration 40 μm

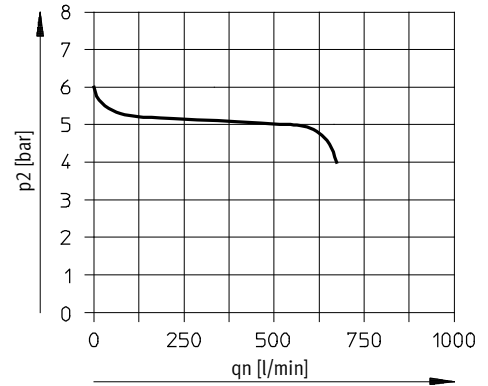
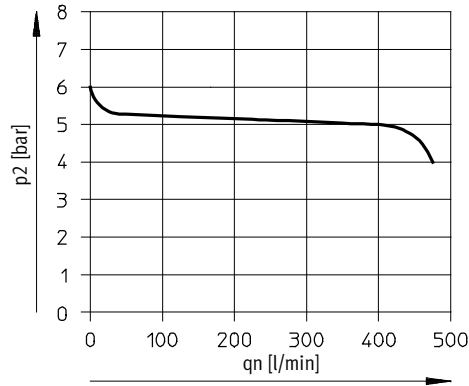

Pneumatic connection G $\frac{1}{4}$

Grade of filtration 5 μm

Grade of filtration 40 μm

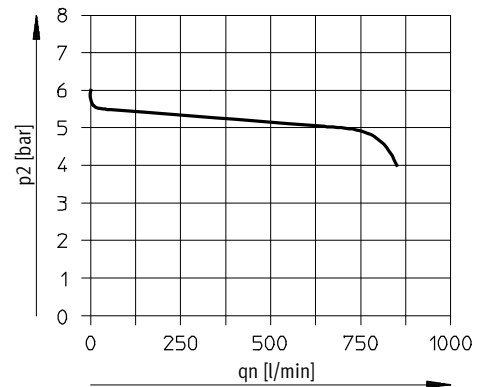
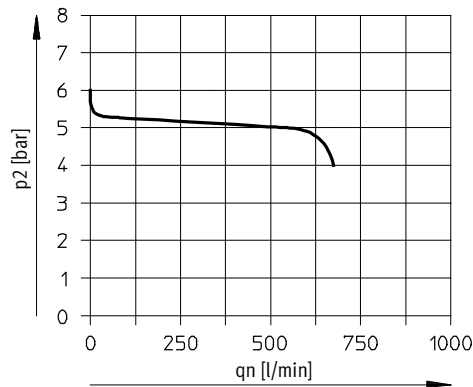

Primary pressure $p_1 = 10$ bar

-  - Note

Slight leakage at the output has been taken into account in the design. It improves the control behaviour of the non pre-pressure compensated controller.

In a few cases leakage may amount to 500 l/min.

Service units FRC, D series, polymer

Technical data

FESTO

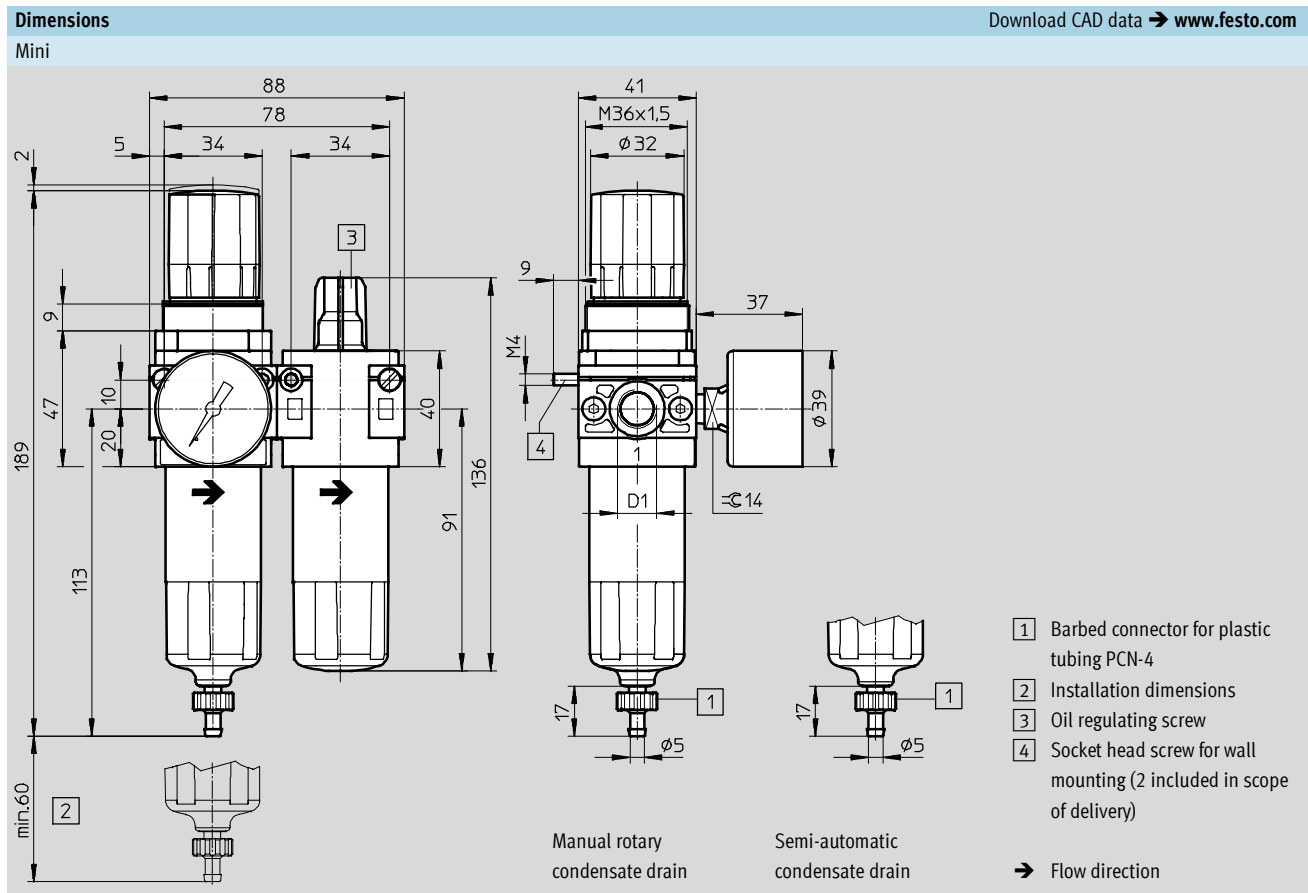

Type	D1
FRC-1/8-DB	G1/8
FRC-1/4-DB	G1/4

Ordering data						
Pressure regulation range 0.5 ... 7 bar						
Condensate drain	Size	Connection	Grade of filtration 5 µm		Grade of filtration 40 µm	
			Part No.	Type	Part No.	Type
With pressure gauge						
Manual rotary	Mini	G1/8	537659	FRC-1/8-DB-7-5M-MINI	537655	FRC-1/8-DB-7-MINI
		G1/4	537658	FRC-1/4-DB-7-5M-MINI	537654	FRC-1/4-DB-7-MINI
Semi-automatic	Mini	G1/8	537661	FRC-1/8-DB-7-5M-MINI-H	537657	FRC-1/8-DB-7-MINI-H
		G1/4	537660	FRC-1/4-DB-7-5M-MINI-H	537656	FRC-1/4-DB-7-MINI-H

Service units FRC/FRCS, D series

Accessories

FESTO

Filter cartridges, D series, metal design



Ordering data			
Size	Grade of filtration [µm]	Part No.	Type
Micro	5	526818	LFP-D-MICRO-5M
Mini	5 (colour: blue)	159640	LFP-D-MINI-5M
	40 (colour: white)	363665	LFP-D-MINI-40M
Midi	5 (colour: blue)	159594	LFP-D-MIDI-5M
	40 (colour: white)	363667	LFP-D-MIDI-40M
Maxi	5 (colour: blue)	159641	LFP-D-MAXI-5M
	40 (colour: white)	363664	LFP-D-MAXI-40M

Filter cartridges, D series, polymer



Ordering data			
Size	Grade of filtration [µm]	Part No.	Type
Mini	5	547957	LFP-DB-MINI-5M
	40	534502	MS4-LFP-E

Service units FRC/FRCS, D series

Accessories

FESTO

Special oil



Ordering data		
Scope of delivery	Part No.	Type
1 litre	152811	OFSW-32

Ordering data – Pressure gauge MA						
	Nominal size	Pneumatic connection	Indicating range		Part No.	Type
			[bar]	[psi]		
	Pressure gauge MA					Technical data → Internet: ma
	27	M5	0 ... 10	–	526323	MA-27-10-M5
	40	G1/8	0 ... 10	0 ... 145	359874	MA-40-10-1/4
			0 ... 16	0 ... 232	345395	MA-40-16-1/4
	50	G1/4	0 ... 10	0 ... 145	359873	MA-50-10-1/4
0 ... 16			0 ... 232	356759	MA-50-16-1/4	