

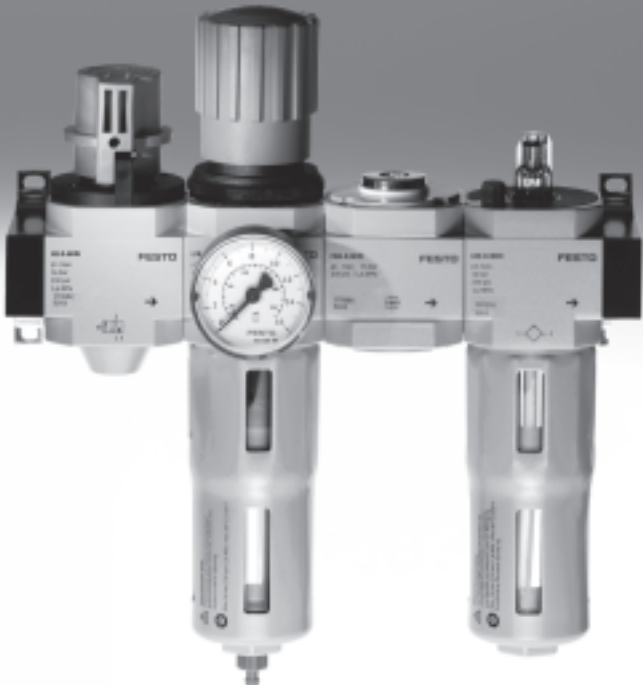

# Service unit combinations FRC-K, D series

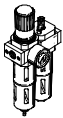
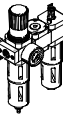
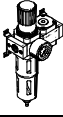
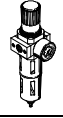
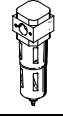
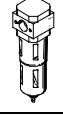
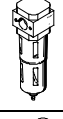

# Service unit combinations FRC-K, D series, metal design

Product range overview D series service units, metal design

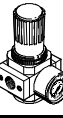
Type	Size	Pneumatic connection										Pressure regulation range [bar]			Grade of filtration [µm]				
		M5	M7	G1/8	G1/4	G3/8	G1/2	G3/4	G1	QS4	QS6	0.5 ...	0.5 ...	2.5 ...	0.01	1	5	40	
<b>Service units</b>																			
<b>FRC/FRCS</b> 	Micro	■	■	■	-	-	-	-	-	■	■	■	-	-	-	■	-		
	Mini	-	-	■	■	■	-	-	-	-	-	■	■	-	-	-	■	■	
	Midi	-	-	-	■	■	■	■	-	-	-	■	■	-	-	-	■	■	
	Maxi	-	-	-	-	-	■	■	■	-	-	■	■	-	-	-	■	■	
<b>Service unit combinations</b>																			
<b>FRC-K</b> 	Micro	-	-	-	-	-	-	-	-	-	-	-	-	-	-	-	-		
	Mini	-	-	■	■	-	-	-	-	-	-	■	■	-	-	-	-	■	
	Midi	-	-	-	■	■	■	-	-	-	-	■	■	-	-	-	-	■	
	Maxi	-	-	-	-	-	■	■	-	-	-	■	■	-	-	-	-	■	
<b>LFR-K LFRS-K</b> 	Micro	-	-	-	-	-	-	-	-	-	-	-	-	-	-	-	-		
	Mini	-	-	■	■	-	-	-	-	-	-	■	■	-	-	-	-	■	
	Midi	-	-	-	■	■	■	-	-	-	-	■	■	-	-	-	-	■	
	Maxi	-	-	-	-	-	■	■	-	-	-	■	■	-	-	-	-	■	
<b>Individual devices</b>																			
<b>Filter regulators LFR/LFRS</b> 	Micro	■	■	■	-	-	-	-	-	■	■	■	-	-	-	-	■	-	
	Mini	-	-	■	■	■	-	-	-	-	-	■	■	-	-	-	-	■	■
	Midi	-	-	-	■	■	■	■	-	-	-	■	■	-	-	-	-	■	■
	Maxi	-	-	-	-	-	■	■	■	-	-	■	■	-	-	-	-	■	■
<b>Filters LF</b> 	Micro	■	■	■	-	-	-	-	-	■	■	-	-	-	-	-	■	-	
	Mini	-	-	■	■	■	-	-	-	-	-	-	-	-	-	-	-	■	■
	Midi	-	-	-	■	■	■	■	-	-	-	-	-	-	-	-	-	■	■
	Maxi	-	-	-	-	-	■	■	■	-	-	-	-	-	-	-	-	■	■
<b>Fine and micro filters LFMA/LFMB</b> 	Micro	-	-	-	-	-	-	-	-	-	-	-	-	-	-	-	-	-	
	Mini	-	-	■	■	■	-	-	-	-	-	-	-	-	■	■	-	-	
	Midi	-	-	-	■	■	■	■	-	-	-	-	-	-	■	■	-	-	
	Maxi	-	-	-	-	-	■	■	■	-	-	-	-	-	■	■	-	-	
<b>Active carbon filters LFX</b> 	Micro	-	-	-	-	-	-	-	-	-	-	-	-	-	-	-	-	-	
	Mini	-	-	■	■	■	-	-	-	-	-	-	-	-	-	-	-	-	-
	Midi	-	-	-	■	■	■	■	-	-	-	-	-	-	-	-	-	-	-
	Maxi	-	-	-	-	-	■	■	■	-	-	-	-	-	-	-	-	-	-
<b>Filter combinations LFMBA</b> 	Micro	-	-	-	-	-	-	-	-	-	-	-	-	-	-	-	-	-	
	Mini	-	-	■	■	■	-	-	-	-	-	-	-	-	■	■	-	-	
	Midi	-	-	-	■	■	■	■	-	-	-	-	-	-	■	■	-	-	
	Maxi	-	-	-	-	-	■	■	■	-	-	-	-	-	■	■	-	-	
<b>Pressure regulators LR/LRS</b> 	Micro	■	■	■	-	-	-	-	-	■	■	■	-	-	-	-	-	-	
	Mini	-	-	■	■	■	-	-	-	-	-	■	■	-	-	-	-	-	-
	Midi	-	-	-	■	■	■	■	-	-	-	■	■	-	-	-	-	-	-
	Maxi	-	-	-	-	-	■	■	■	-	-	■	■	-	-	-	-	-	-



# Service unit combinations FRC-K, D series, metal design

Product range overview D series service units, metal design

Type	Size	Bowl guard		Condensate drain			Pressure indication		Actuator lock		Supply voltage			Options			→ Page/ Internet
		Metal bowl guard	Plastic bowl	Manual rotary	Semi-automatic	Fully automatic	With pressure gauge	Without pressure gauge	Rotary knob with detent	Rotary knob with integrated lock	24 V DC	110 V AC	230 V AC	Directly actuated pressure regulator with integrated return flow function	Pilot actuated pressure regulator with integrated return flow function	Differential pressure indicator	
<b>Service units</b>																	
FRC/FRCS	Micro	-	■	■	■	-	■	■	■	-	-	-	-	-	-	-	frc
	Mini	■	-	■	-	■	■	■	■	■	-	-	-	-	-	-	-
	Midi	■	-	■	-	■	■	■	■	■	-	-	-	-	-	-	-
	Maxi	■	-	■	-	■	■	■	■	■	-	-	-	■	■	-	-
<b>Service unit combinations</b>																	
FRC-K	Micro	-	-	-	-	-	-	-	-	-	-	-	-	-	-	-	6
	Mini	■	-	■	-	■	■	-	■	-	■	-	-	-	-	-	
	Midi	■	-	■	-	■	■	-	■	-	■	-	-	-	-	-	
	Maxi	■	-	■	-	■	■	-	■	-	■	-	-	■	■	-	
LFR-K LFRS-K	Micro	-	-	-	-	-	-	-	-	-	-	-	-	-	-	-	lfr
	Mini	■	-	■	-	■	■	-	■	■	■	-	-	-	-	-	
	Midi	■	-	■	-	■	■	-	■	■	■	-	-	-	-	-	
	Maxi	■	-	■	-	■	■	-	■	■	■	-	-	■	■	-	
<b>Individual devices</b>																	
Filter regulators LFR/LFRS	Micro	-	■	■	■	-	■	■	■	-	-	-	-	-	-	-	lfr
	Mini	■	-	■	-	■	■	■	■	■	-	-	-	-	-	-	
	Midi	■	-	■	-	■	■	■	■	■	-	-	-	-	-	-	
	Maxi	■	-	■	-	■	■	■	■	■	-	-	-	■	■	-	
Filters LF	Micro	-	■	■	■	-	-	-	-	-	-	-	-	-	-	-	lf
	Mini	■	-	■	-	■	-	-	-	-	-	-	-	-	-	-	
	Midi	■	-	■	-	■	-	-	-	-	-	-	-	-	-	-	
	Maxi	■	-	■	-	■	-	-	-	-	-	-	-	-	-	-	
Fine and micro filters LFMA/LFMB	Micro	-	-	-	-	-	-	-	-	-	-	-	-	-	-	-	lfma, lfmb
	Mini	■	-	■	-	■	-	-	-	-	-	-	-	-	-	■	
	Midi	■	-	■	-	■	-	-	-	-	-	-	-	-	-	■	
	Maxi	■	-	■	-	■	-	-	-	-	-	-	-	-	-	■	
Active carbon filters LFX	Micro	-	-	-	-	-	-	-	-	-	-	-	-	-	-	-	lfx
	Mini	■	-	-	-	-	-	-	-	-	-	-	-	-	-	-	
	Midi	■	-	-	-	-	-	-	-	-	-	-	-	-	-	-	
	Maxi	■	-	-	-	-	-	-	-	-	-	-	-	-	-	-	
Filter combinations LFMBA	Micro	-	-	-	-	-	-	-	-	-	-	-	-	-	-	-	lfmba
	Mini	■	-	■	-	■	-	-	-	-	-	-	-	-	-	■	
	Midi	■	-	■	-	■	-	-	-	-	-	-	-	-	-	■	
	Maxi	■	-	■	-	■	-	-	-	-	-	-	-	-	-	■	
Pressure regulators LR/LRS	Micro	-	-	-	-	-	■	■	■	-	-	-	-	-	-	-	lr
	Mini	-	-	-	-	-	■	■	■	■	-	-	-	■	-	-	
	Midi	-	-	-	-	-	■	■	■	■	-	-	-	■	-	-	
	Maxi	-	-	-	-	-	■	■	■	■	-	-	-	■	■	-	

# Service unit combinations FRC-K, D series, metal design

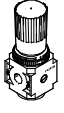
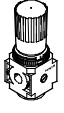
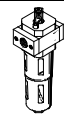
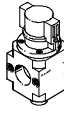
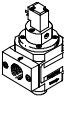
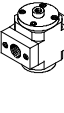
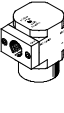
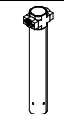
Product range overview D series service units, metal design

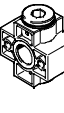
Type	Size	Pneumatic connection										Pressure regulation range [bar]		
		M5	M7	G1/8	G1/4	G3/8	G1/2	G3/4	G1	QS4	QS6	0.5 ... 7	0.5 ... 12	
<b>Individual devices</b>														
Pressure regulators <b>LRB/LRBS</b>		Micro	-											
		Mini	-	-	-	■	-	-	-	-	-	-	■	■
		Midi	-	-	-	-	■	-	-	-	-	-	■	■
		Maxi	-											
Pressure regulator combinations <b>LRB-K</b>		Micro	-											
		Mini	-	-	-	■	■	-	-	-	-	-	■	■
		Midi	-	-	-	-	■	■	-	-	-	-	■	■
		Maxi	-											
Lubricators <b>LOE</b>		Micro	■	■	■	-	-	-	-	-	■	■	-	-
		Mini	-	-	■	■	■	-	-	-	-	-	-	-
		Midi	-	-	-	■	■	■	■	-	-	-	-	-
		Maxi	-	-	-	-	-	■	■	■	-	-	-	-
On-off valves <b>HE</b>		Micro	-											
		Mini	-	-	■	■	■	-	-	-	-	-	-	-
		Midi	-	-	-	■	■	■	■	-	-	-	-	-
		Maxi	-	-	-	-	-	■	■	■	-	-	-	-
On-off valves, electrical <b>HEE</b>		Micro	-											
		Mini	-	-	■	■	■	-	-	-	-	-	-	-
		Midi	-	-	-	■	■	■	■	-	-	-	-	-
		Maxi	-	-	-	-	-	■	■	■	-	-	-	-
On-off valves, pneumatic <b>HEP</b>		Micro	-											
		Mini	-	-	■	■	■	-	-	-	-	-	-	-
		Midi	-	-	-	■	■	■	■	-	-	-	-	-
		Maxi	-	-	-	-	-	■	■	■	-	-	-	-
Soft-start valves <b>HEL</b>		Micro	-											
		Mini	-	-	■	■	■	-	-	-	-	-	-	-
		Midi	-	-	-	■	■	■	■	-	-	-	-	-
		Maxi	-	-	-	-	-	■	■	■	-	-	-	-
Membrane air dryers <b>LDM1</b>		Micro	-											
		Mini	-											
		Midi	-											
		Maxi	-	-	-	-	-	■	■	■	-	-	-	-
Branching modules <b>FRM</b>		Micro	-											
		Mini	-	-	■	■	■	-	-	-	-	-	-	-
		Midi	-	-	-	■	■	■	■	-	-	-	-	-
		Maxi	-	-	-	-	-	■	■	■	-	-	-	-
Distributor block <b>FRZ</b>		Micro	-											
		Mini	-											
		Midi	-											
		Maxi	-											

# Service unit combinations FRC-K, D series, metal design

Product range overview D series service units, metal design

Type	Size	Bowl guard		Pressure indication		Actuator lock		Supply voltage			Options		→ Page/ Internet
		Metal bowl guard	Plastic bowl	With pressure gauge	Without pressure gauge	Rotary knob with detent	Rotary knob with integrated lock	24 V DC	110 V AC	230 V AC	Non-return function	Pressure switch	
<b>Individual devices</b>													
Pressure regulators <b>LRB/LRBS</b>	Micro	-	-	-	■	■	■	-	-	-	-	-	lrb
	Mini	-	-	-	■	■	■	-	-	-	-	-	
	Midi	-	-	-	■	■	■	-	-	-	-	-	
	Maxi	-	-	-	■	■	■	-	-	-	-	-	
Pressure regulator combinations <b>LRB-K</b>	Micro	-	-	-	■	■	-	-	-	-	-	-	lrb
	Mini	-	-	-	■	■	-	-	-	-	-	-	
	Midi	-	-	-	■	■	-	-	-	-	-	-	
	Maxi	-	-	-	■	■	-	-	-	-	-	-	
Lubricators <b>LOE</b>	Micro	-	■	-	■	-	-	-	-	-	-	-	loe
	Mini	■	-	-	■	-	-	-	-	-	-	-	
	Midi	■	-	-	■	-	-	-	-	-	-	-	
	Maxi	■	-	-	■	-	-	-	-	-	-	-	
On-off valves <b>HE</b>	Micro	-	-	-	■	■	-	-	-	-	-	-	he
	Mini	-	-	-	■	■	-	-	-	-	-	-	
	Midi	-	-	-	■	■	-	-	-	-	-	-	
	Maxi	-	-	-	■	■	-	-	-	-	-	-	
On-off valves, electrical <b>HEE</b>	Micro	-	-	-	■	-	-	■	■	■	-	-	hee
	Mini	-	-	-	■	-	-	■	■	■	-	-	
	Midi	-	-	-	■	-	-	■	■	■	-	-	
	Maxi	-	-	-	■	-	-	■	■	■	-	-	
On-off valves, pneumatic <b>HEP</b>	Micro	-	-	-	■	-	-	-	-	-	-	-	hep
	Mini	-	-	-	■	-	-	-	-	-	-	-	
	Midi	-	-	-	■	-	-	-	-	-	-	-	
	Maxi	-	-	-	■	-	-	-	-	-	-	-	
Soft-start valves <b>HEL</b>	Micro	-	-	-	■	-	-	-	-	-	-	-	hel
	Mini	-	-	-	■	-	-	-	-	-	-	-	
	Midi	-	-	-	■	-	-	-	-	-	-	-	
	Maxi	-	-	-	■	-	-	-	-	-	-	-	
Membrane air dryers <b>LDM1</b>	Micro	-	-	-	■	-	-	-	-	-	-	-	ldm1
	Mini	-	-	-	■	-	-	-	-	-	-	-	
	Midi	-	-	-	■	-	-	-	-	-	-	-	
	Maxi	■	-	-	■	-	-	-	-	-	-	-	
Branching modules <b>FRM</b>	Micro	-	-	-	■	-	-	-	-	-	■	■	frm
	Mini	-	-	-	■	-	-	-	-	-	■	■	
	Midi	-	-	-	■	-	-	-	-	-	■	■	
	Maxi	-	-	-	■	-	-	-	-	-	■	■	
Distributor block <b>FRZ</b>	Micro	-	-	-	■	-	-	-	-	-	-	-	frz
	Mini	-	-	-	■	-	-	-	-	-	-	-	
	Midi	-	-	-	■	-	-	-	-	-	-	-	
	Maxi	-	-	-	■	-	-	-	-	-	-	-	

# Service unit combinations FRC-K, D series, metal design

Product range overview

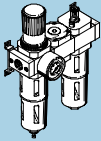
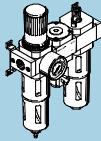
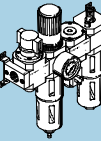
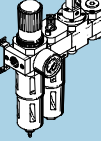
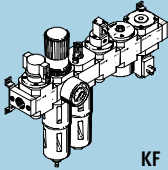
<b>FRC</b> Rotary knob with detent	 KA	 KB	 KC	 KE	 KF
<b>Individual devices</b>					
On-off valve manually actuated	-	-	■	-	■
Filter regulator with pressure gauge	■	■	■	■	■
Branching module	■	-	-	-	-
Branching module with pressure switch	-	■	■	-	■
Lubricator	■	■	■	■	■
On-off valve solenoid actuated, 24 V DC	-	-	-	■	■
Soft-start valve pneumatically actuated	-	-	-	■	■
Mounting bracket	■	■	■	■	■
➔ Page/Internet	9	12	15	18	21

# Service unit combinations FRC-K, D series, metal design

Peripherals overview

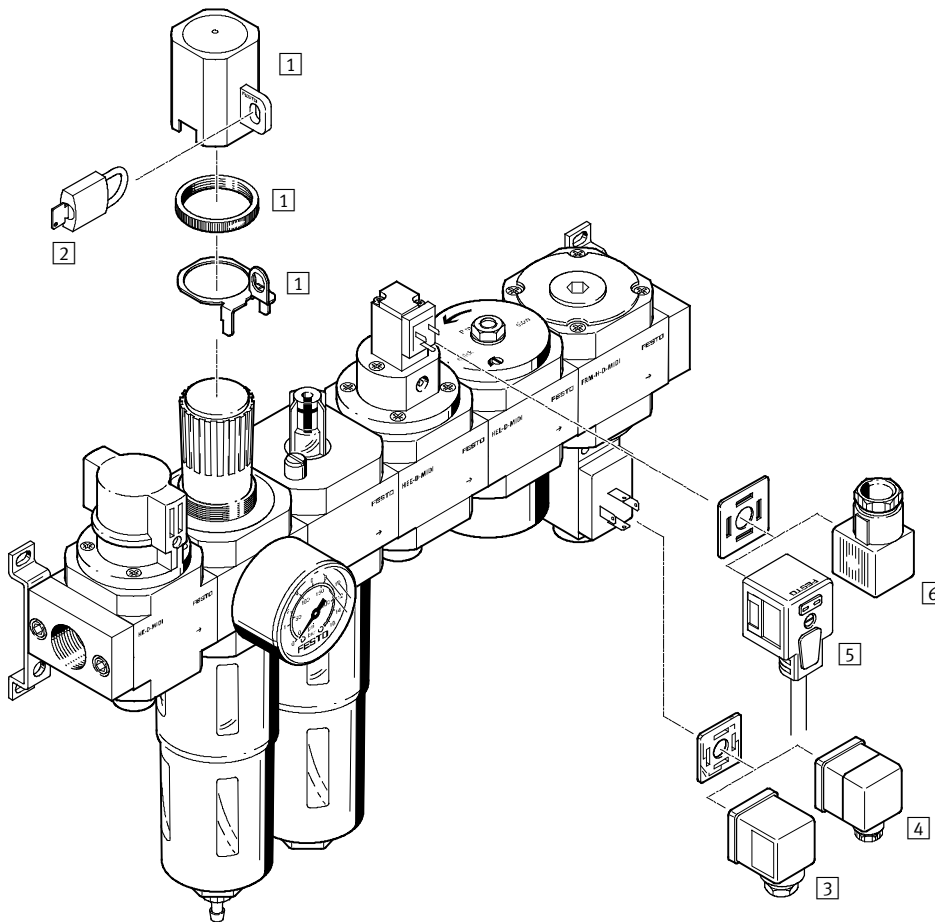

-  - Note

The choice of accessories depends on the selected service unit combination. The example shows the service unit combination FRC-KF.

Range of accessories  
 → Peripherals pages of the individual devices

Mounting attachments and accessories		→ Page/ Internet
1	Regulator lock LRVS	lrvs-d
2	Padlock LRVS	lrvs-d
3	Plug socket MSSD-C	35
4	Angled plug socket PEV-...-WD-LED	35
5	Plug socket with cable KMEB-1	35
6	Plug socket MSSD-EB	35
-	Filter cartridge LFP	34
-	Special oil OFSW	34

# Service unit combinations FRC-K, D series, metal design

Type codes

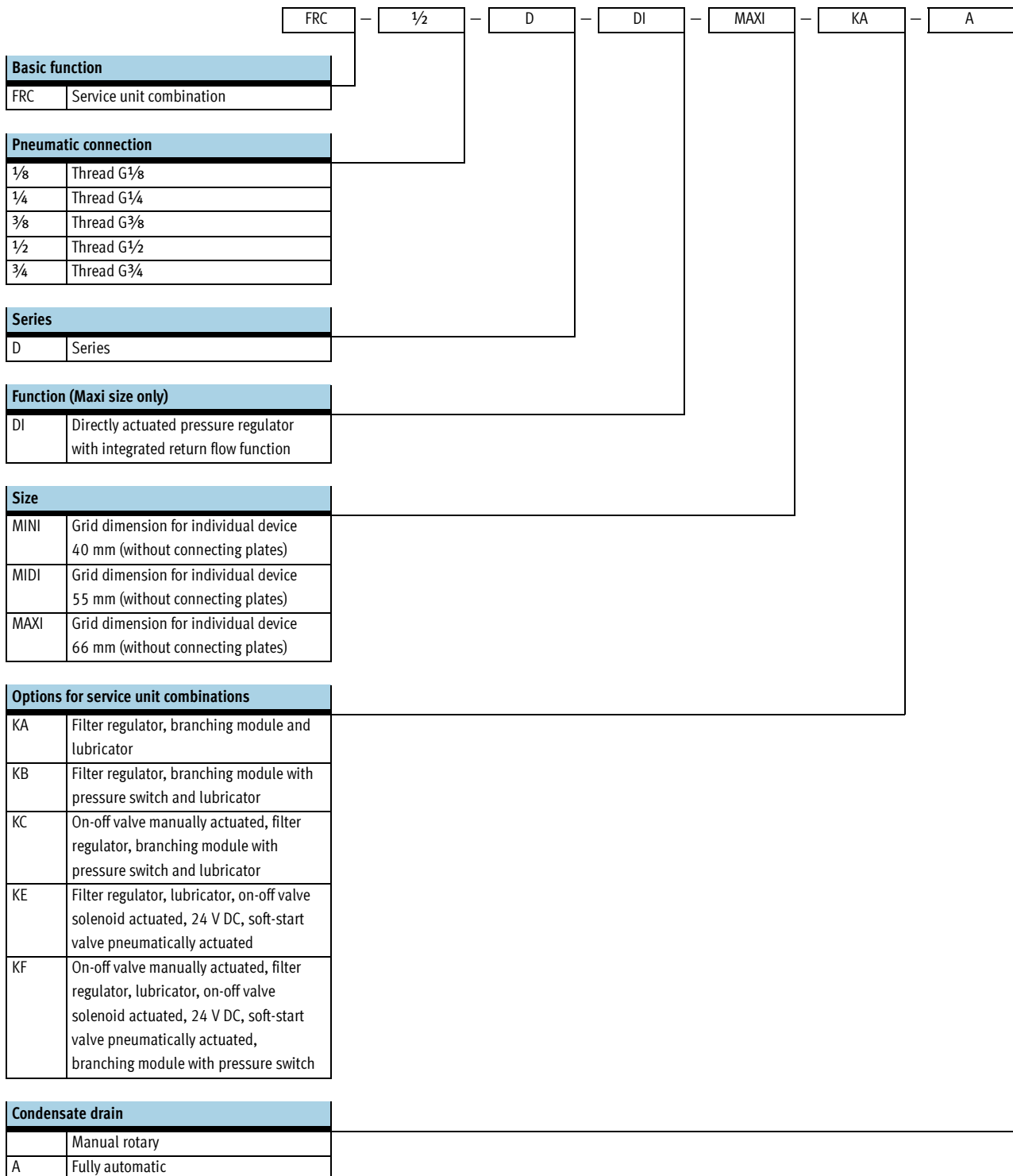



# Service unit combinations FRC-KA, D series, metal design

Technical data combination FRC-KA

**Function**

With condensate drain  
manual rotary

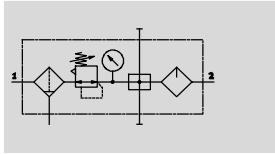

With condensate drain  
fully automatic

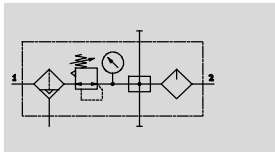

- Flow rate  
650 ... 8200 l/min
- Temperature range  
-10 ... +60 °C
- Operating pressure  
1 ... 16 bar



- Filter regulator LFR
- Branching module FRM
- Lubricator LOE
- Mounting accessories

- For lubricated and unlubricated compressed air
- Two connections for unlubricated compressed air supply
- One connection for lubricated compressed air supply
- New filter cartridges → 34

General technical data							
Size	Mini		Midi			Maxi	
Pneumatic connection 1, 2	G1/8	G1/4	G1/4	G3/8	G1/2	G1/2	G3/4
Type of mounting	Via accessories In-line installation						
Assembly position	Vertical ±5°						
Grade of filtration [µm]	40						
Bowl guard	Metal bowl guard						
Condensate drain	Manual rotary Fully automatic						
Actuator lock	Rotary knob with detent						
Pressure regulation range [bar]	0.5 ... 12						
Max. hysteresis [bar]	0.15	0.2	0.25	0.2	0.3	0.1	0.2
Pressure indication	Via pressure gauge						
Max. condensate volume [cm <sup>3</sup> ]	22		43			80 (43) <sup>1)</sup>	

1) For the FRC...-D-DI.

- | - Note: This product conforms to ISO 1179-1 and to ISO 228-1

Standard nominal flow rate $q_{nN}^{1)}$ [l/min]							
Connection	Mini		Midi			Maxi	
	G1/8	G1/4	G1/4	G3/8	G1/2	G1/2	G3/4
In main flow direction 1 → 2	650	980	1,400	2,100	2,500	7,500 (3,900) <sup>2)</sup>	8,200 (5,000) <sup>2)</sup>

1) Measured at p1 = 10 bar, p2 = 6 bar and Δp = 1 bar.

2) For the FRC...-D-DI.

# Service unit combinations FRC-KA, D series, metal design

Technical data combination FRC-KA

Operating and environmental conditions		
Condensate drain	Manual rotary	Fully automatic
Operating pressure [bar]	1 ... 16	2 ... 12
Operating medium	Compressed air in accordance with ISO 8573-1:2010 [-:-:-]	
Ambient temperature [°C]	-10 ... +60	
Temperature of medium [°C]	-10 ... +60	
Corrosion resistance class CRC <sup>1)</sup>	2	
Certification	Germanischer Lloyd	

1) Corrosion resistance class 2 according to Festo standard 940 070  
 Components subject to moderate corrosion stress. Externally visible parts with primarily decorative surface requirements which are in direct contact with a normal industrial environment or media such as coolants or lubricating agents.

Weight [g]			
Size	Mini	Midi	Maxi
FRC	1,000	2,400	3,500 (3,700) <sup>1)</sup>

1) For the FRC-...-D-DI.

 - Note  
 Materials → Technical data of the individual devices

## Standard flow rate qn as a function of the output pressure p2 FRC-1/2-D-DI-MAXI-KA(-A)

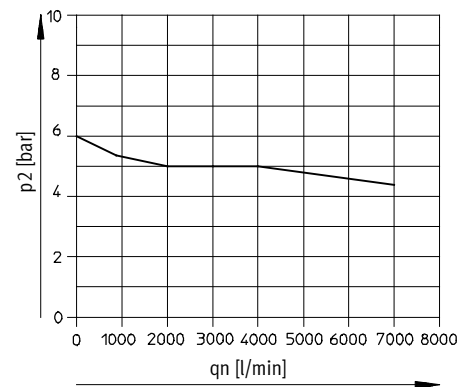

Primary pressure p1 = 10 bar

# Service unit combinations FRC-KA, D series, metal design

Technical data combination FRC-KA

**Dimensions** Download CAD data → [www.festo.com](http://www.festo.com)

FRC-...-KA

3 Installation dimensions → Flow direction

Type	B5	B6	D1	H1	H2	H3	L1	L2	L3	L4	L5	L8	L9	L10	T1	T2
<b>Mini</b>																
FRC-...-D-MINI-KA (-A)	144	132	4.3	43	17.5	17.5	193	124	60	68	100	15	19	3	39	95
<b>Midi</b>																
FRC-...-D-MIDI-KA (-A)	195	180	5.3	70	24.5	35.5	250	152	80	99	120	15	19	3	47	114
<b>Maxi</b>																
FRC-...-D-MAXI-KA (-A)	228	212	5.3	70	24.5	35.5	252	171	90	82	150	15	19	3	53	126
FRC-...-D-DI-MAXI-KA (-A)							275			105						

<b>Ordering data</b>					
Size	Connection	Condensate drain turned manually		Condensate drain fully automatic	
		Part No.	Type	Part No.	Type
Mini	G1/8	185791	FRC-1/8-D-MINI-KA	185792	FRC-1/8-D-MINI-KA-A
	G1/4	185793	FRC-1/4-D-MINI-KA	185794	FRC-1/4-D-MINI-KA-A
Midi	G1/4	185795	FRC-1/4-D-MIDI-KA	185796	FRC-1/4-D-MIDI-KA-A
	G3/8	185797	FRC-3/8-D-MIDI-KA	185798	FRC-3/8-D-MIDI-KA-A
	G1/2	185799	FRC-1/2-D-MIDI-KA	185800	FRC-1/2-D-MIDI-KA-A
Maxi	G1/2	186053	FRC-1/2-D-MAXI-KA	186054	FRC-1/2-D-MAXI-KA-A
	G3/4	185801	FRC-3/4-D-MAXI-KA	185802	FRC-3/4-D-MAXI-KA-A
<b>Directly actuated pressure regulator with integrated return flow function</b>					
Maxi	G1/2	192468	FRC-1/2-D-DI-MAXI-KA	192478	FRC-1/2-D-DI-MAXI-KA-A
	G3/4	192473	FRC-3/4-D-DI-MAXI-KA	192483	FRC-3/4-D-DI-MAXI-KA-A

• Note: This product conforms to ISO 1179-1 and to ISO 228-1

# Service unit combinations FRC-KB, D series, metal design

Technical data combination FRC-KB

**Function**

With condensate drain  
manual rotary

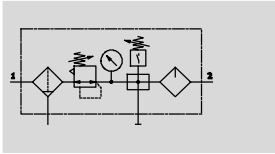

With condensate drain  
fully automatic

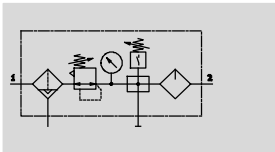

- Filter regulator LFR
- Branching module FRM with pressure switch
- Lubricator LOE
- Mounting accessories

- - Flow rate  
650 ... 8200 l/min
- - Temperature range  
-10 ... +60 °C
- - Operating pressure  
1 ... 16 bar

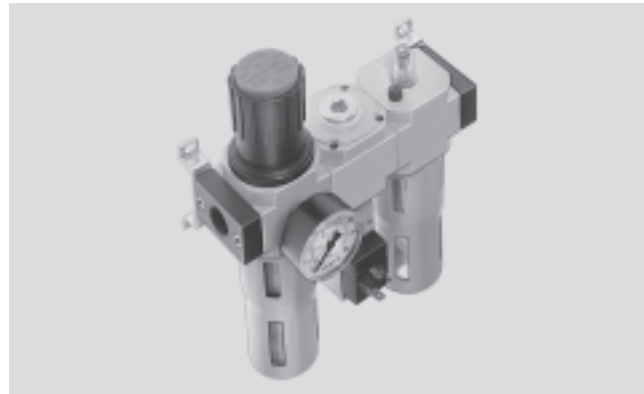

- Electrical pressure monitoring with adjustable switching pressure
- For lubricated and unlubricated compressed air
- One connection for unlubricated compressed air supply
- One connection for lubricated compressed air supply
- New filter cartridges → 34

General technical data							
Size	Mini		Midi			Maxi	
Pneumatic connection 1, 2	G <sup>1</sup> / <sub>8</sub>	G <sup>1</sup> / <sub>4</sub>	G <sup>1</sup> / <sub>4</sub>	G <sup>3</sup> / <sub>8</sub>	G <sup>1</sup> / <sub>2</sub>	G <sup>1</sup> / <sub>2</sub>	G <sup>3</sup> / <sub>4</sub>
Type of mounting	Via accessories In-line installation						
Assembly position	Vertical ±5°						
Grade of filtration [µm]	40						
Bowl guard	Metal bowl guard						
Condensate drain	Manual rotary Fully automatic						
Actuator lock	Rotary knob with detent						
Pressure regulation range [bar]	0.5 ... 12						
Max. hysteresis [bar]	0.25	0.2	0.25	0.35	0.35	0.1	0.2
Pressure indication	Via pressure gauge						
Max. condensate volume [cm <sup>3</sup> ]	22		43			80 (43) <sup>1)</sup>	

1) For the FRC...-D-DI.

- | - Note: This product conforms to ISO 1179-1 and to ISO 228-1

Standard nominal flow rate q <sub>nN</sub> <sup>1)</sup> [l/min]							
Connection	Mini		Midi			Maxi	
	G <sup>1</sup> / <sub>8</sub>	G <sup>1</sup> / <sub>4</sub>	G <sup>1</sup> / <sub>4</sub>	G <sup>3</sup> / <sub>8</sub>	G <sup>1</sup> / <sub>2</sub>	G <sup>1</sup> / <sub>2</sub>	G <sup>3</sup> / <sub>4</sub>
In main flow direction 1 → 2	650	980	1,400	2,100	2,500	7,500 (5,400) <sup>2)</sup>	8,200 (7,000) <sup>2)</sup>

1) Measured at p<sub>1</sub> = 10 bar, p<sub>2</sub> = 6 bar and Δp = 1 bar.

2) For the FRC...-D-DI.

# Service unit combinations FRC-KB, D series, metal design

Technical data combination FRC-KB

Operating and environmental conditions		
Condensate drain	Manual rotary	Fully automatic
Operating pressure [bar]	1 ... 16	2 ... 12
Operating medium	Compressed air in accordance with ISO 8573-1:2010 [-:-:-]	
Ambient temperature [°C]	-10 ... +60	
Temperature of medium [°C]	-10 ... +60	
Corrosion resistance class CRC <sup>1)</sup>	2	
Certification	Germanischer Lloyd	

1) Corrosion resistance class 2 according to Festo standard 940 070  
 Components subject to moderate corrosion stress. Externally visible parts with primarily decorative surface requirements which are in direct contact with a normal industrial environment or media such as coolants or lubricating agents.

Weight [g]			
Size	Mini	Midi	Maxi
FRC	1,200	2,600	3,500 (3,700) <sup>1)</sup>

1) For the FRC-...-D-DI.

 - Note  
 Materials → Technical data of the individual devices

## Standard flow rate qn as a function of the output pressure p2 FRC-1/2-D-DI-MAXI-KB(-A)

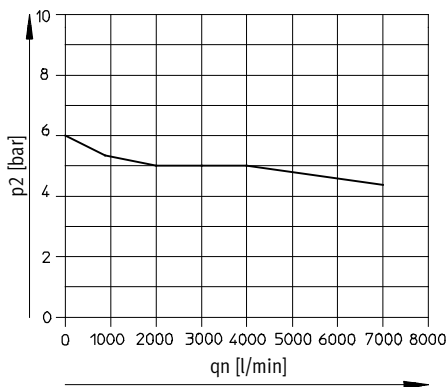

Primary pressure p1 = 10 bar

# Service unit combinations FRC-KB, D series, metal design

Technical data combination FRC-KB

FESTO

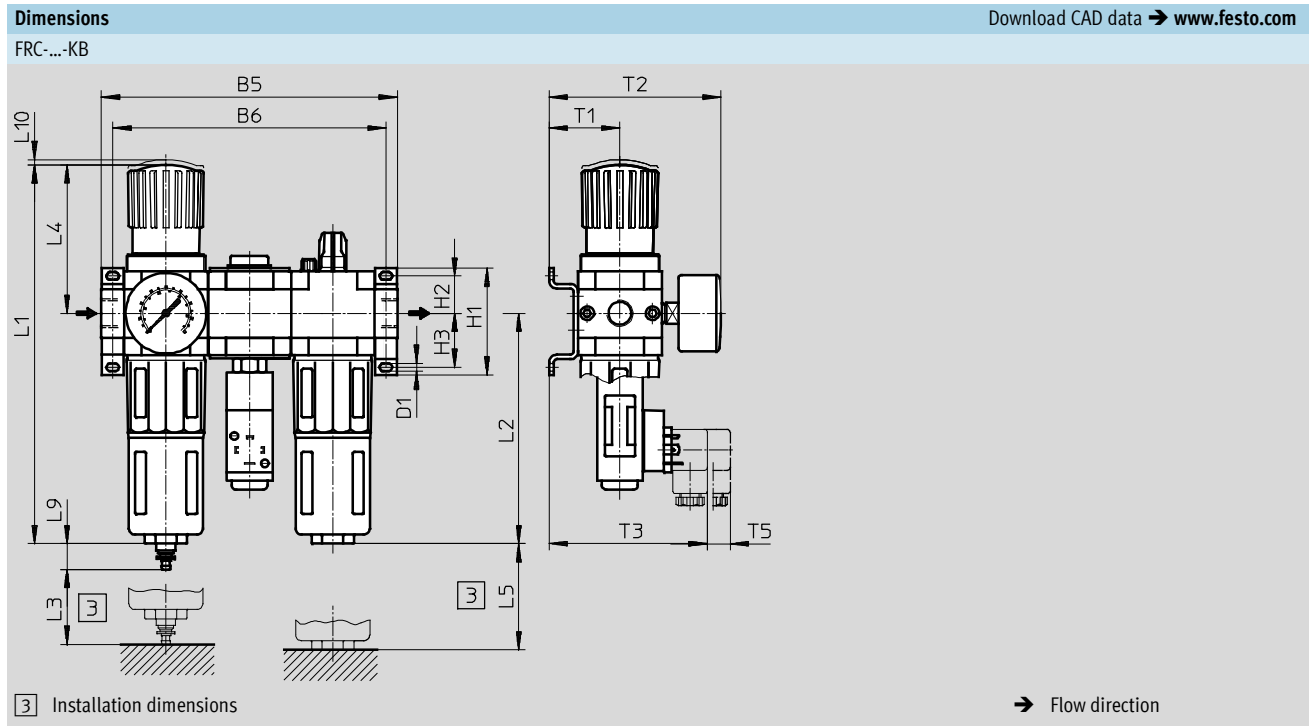

Type	B5	B6	D1	H1	H2	H3	L1	L2	L3	L4	L5	L9	L10	T1	T2	T3	T5
<b>Mini</b>																	
FRC-...-D-MINI-KB (-A)	144	132	4.3	43	17.5	17.5	193	124	60	68	100	19	3	39	95	97	15
<b>Midi</b>																	
FRC-...-D-MIDI-KB (-A)	195	180	5.3	70	24.5	35.5	250	152	80	99	120	19	3	47	114	105	15
<b>Maxi</b>																	
FRC-...-D-MAXI-KB (-A)	228	212	5.3	70	24.5	35.5	252	171	90	82	150	19	3	53	126	111	15
FRC-...-D-DI-MAXI-KB (-A)							275			105							

<b>Ordering data</b>						
Size	Connection	Condensate drain turned manually		Condensate drain fully automatic		
		Part No.	Type	Part No.	Type	
Mini	G1/8	185803	FRC-1/8-D-MINI-KB	185804	FRC-1/8-D-MINI-KB-A	
	G1/4	185805	FRC-1/4-D-MINI-KB	185806	FRC-1/4-D-MINI-KB-A	
Midi	G1/4	185807	FRC-1/4-D-MIDI-KB	185808	FRC-1/4-D-MIDI-KB-A	
	G3/8	185809	FRC-3/8-D-MIDI-KB	185810	FRC-3/8-D-MIDI-KB-A	
	G1/2	185811	FRC-1/2-D-MIDI-KB	185812	FRC-1/2-D-MIDI-KB-A	
Maxi	G1/2	186055	FRC-1/2-D-MAXI-KB	186056	FRC-1/2-D-MAXI-KB-A	
	G3/4	185813	FRC-3/4-D-MAXI-KB	185814	FRC-3/4-D-MAXI-KB-A	
<b>Directly actuated pressure regulator with integrated return flow function</b>						
Maxi	G1/2	192469	FRC-1/2-D-DI-MAXI-KB	192479	FRC-1/2-D-DI-MAXI-KB-A	
	G3/4	192474	FRC-3/4-D-DI-MAXI-KB	192484	FRC-3/4-D-DI-MAXI-KB-A	

|| Note: This product conforms to ISO 1179-1 and to ISO 228-1

# Service unit combinations FRC-KC, D series, metal design

Technical data combination FRC-KC

**Function**

With condensate drain  
manual rotary

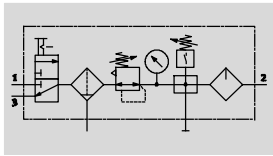

With condensate drain  
fully automatic

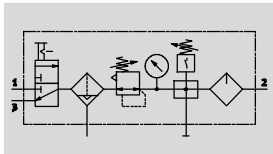

- On-off valve HE manually actuated
- Filter regulator LFR
- Branching module FRM with pressure switch
- Lubricator LOE
- Mounting accessories

- Flow rate  
640 ... 7800 l/min
- Temperature range  
-10 ... +60 °C
- Operating pressure  
1 ... 16 bar

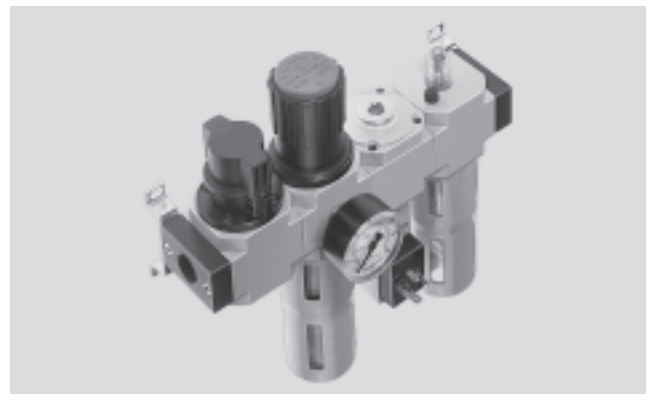

- To ensure safe venting of the system, an additional quick exhaust valve is necessary at the output of the service unit combination

- Electrical pressure monitoring with adjustable switching pressure
- The system is vented when supply air is closed

- For lubricated and unlubricated compressed air
- One connection for unlubricated compressed air supply
- One connection for lubricated compressed air supply
- New filter cartridges → 34

General technical data							
Size	Mini		Midi			Maxi	
Pneumatic connection 1, 2	G1/8	G1/4	G1/4	G3/8	G1/2	G1/2	G3/4
Type of mounting	Via accessories In-line installation						
Assembly position	Vertical ±5°						
Grade of filtration [µm]	40						
Bowl guard	Metal bowl guard						
Condensate drain	Manual rotary Fully automatic						
Actuator lock	Rotary knob with detent						
Pressure regulation range [bar]	0.5 ... 12						
Max. hysteresis [bar]	0.2	0.2	0.4	0.3	0.3	0.15	0.15
Pressure indication	Via pressure gauge						
Max. condensate volume [cm <sup>3</sup> ]	22		43			80 (43) <sup>1)</sup>	

1) For the FRC-...-D-DI.

- | Note: This product conforms to ISO 1179-1 and to ISO 228-1

Standard nominal flow rate $q_{nN}^{1)}$ [l/min]							
Connection	Mini		Midi			Maxi	
	G1/8	G1/4	G1/4	G3/8	G1/2	G1/2	G3/4
In main flow direction 1 → 2	640	870	1,320	1,870	2,400	6,600 (4,800) <sup>2)</sup>	7,800 (5,400) <sup>2)</sup>

1) Measured at p<sub>1</sub> = 10 bar, p<sub>2</sub> = 6 bar and Δp = 1 bar.

2) For the FRC-...-D-DI.

# Service unit combinations FRC-KC, D series, metal design

Technical data combination FRC-KC

Operating and environmental conditions		
Condensate drain	Manual rotary	Fully automatic
Operating pressure [bar]	1 ... 16	1.5 ... 12
Operating medium	Compressed air in accordance with ISO 8573-1:2010 [-:-:-]	
Ambient temperature [°C]	-10 ... +60	
Temperature of medium [°C]	-10 ... +60	
Corrosion resistance class CRC <sup>1)</sup>	2	
Certification	Germanischer Lloyd	

1) Corrosion resistance class 2 according to Festo standard 940 070  
 Components subject to moderate corrosion stress. Externally visible parts with primarily decorative surface requirements which are in direct contact with a normal industrial environment or media such as coolants or lubricating agents.

Weight [g]			
Size	Mini	Midi	Maxi
FRC	1,400	3,000	4,600 (4,800) <sup>1)</sup>

1) For the FRC-...-D-DI.

-  - Note

Materials → Technical data of the individual devices

## Standard flow rate qn as a function of the output pressure p2

FRC-1/2-D-DI-MAXI-KC(-A)

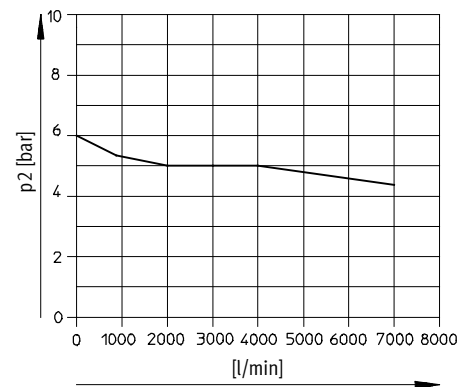

Primary pressure p1 = 10 bar



# Service unit combinations FRC-KC, D series, metal design

Technical data combination FRC-KC

**Dimensions** Download CAD data → [www.festo.com](http://www.festo.com)

FRC-...-KC

3 Installation dimensions → Flow direction

Type	B7	B8	D1	H1	H2	H3	L1	L2	L3	L4	L5	L9	L10	T1	T2	T3	T5
<b>Mini</b>																	
FRC-...-D-MINI-KC (-A)	184	172	4.3	43	17.5	17.5	193	124	60	68	100	19	3	39	95	97	15
<b>Midi</b>																	
FRC-...-D-MIDI-KC (-A)	250	235	5.3	70	24.5	35.5	250	152	80	99	120	19	3	47	114	105	15
<b>Maxi</b>																	
FRC-...-D-MAXI-KC (-A)	294	278	5.3	70	24.5	35.5	252	171	90	82	150	19	3	53	126	111	15
FRC-...-D-DI-MAXI-KC (-A)							275			105							

<b>Ordering data</b>							
Size	Connection	Condensate drain turned manually				Condensate drain fully automatic	
		Part No.	Type			Part No.	Type
Mini	G1/8	185815	FRC-1/8-D-MINI-KC			185816	FRC-1/8-D-MINI-KC-A
	G1/4	185817	FRC-1/4-D-MINI-KC			185818	FRC-1/4-D-MINI-KC-A
Midi	G1/4	185819	FRC-1/4-D-MIDI-KC			185820	FRC-1/4-D-MIDI-KC-A
	G3/8	185821	FRC-3/8-D-MIDI-KC			185822	FRC-3/8-D-MIDI-KC-A
	G1/2	185823	FRC-1/2-D-MIDI-KC			185824	FRC-1/2-D-MIDI-KC-A
Maxi	G1/2	186057	FRC-1/2-D-MAXI-KC			186058	FRC-1/2-D-MAXI-KC-A
	G3/4	185825	FRC-3/4-D-MAXI-KC			185826	FRC-3/4-D-MAXI-KC-A
<b>Directly actuated pressure regulator with integrated return flow function</b>							
Maxi	G1/2	192470	FRC-1/2-D-DI-MAXI-KC			192480	FRC-1/2-D-DI-MAXI-KC-A
	G3/4	192475	FRC-3/4-D-DI-MAXI-KC			192485	FRC-3/4-D-DI-MAXI-KC-A

• Note: This product conforms to ISO 1179-1 and to ISO 228-1

# Service unit combinations FRC-KE, D series, metal design

Technical data combination FRC-KE

Function

With condensate drain  
manual rotary

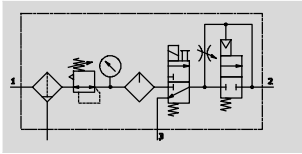

With condensate drain  
fully automatic

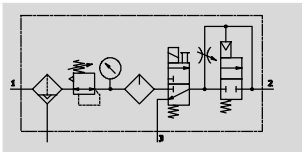

- - Flow rate  
550 ... 3,800 l/min
- - Temperature range  
-10 ... +60 °C
- - Operating pressure  
3 ... 16 bar

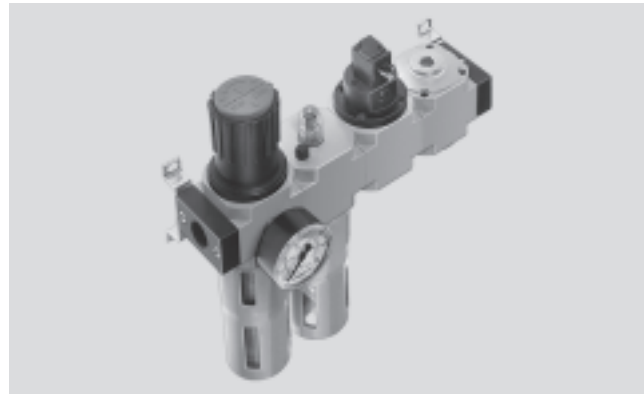

- Filter regulator LFR
- Lubricator LOE
- On-off valve HEE solenoid actuated, 24 V DC
- Soft-start valve HEL pneumatically actuated
- Mounting accessories

- Gradual pressure build-up prevents sudden, unpredictable movements
- For lubricated compressed air
- New filter cartridges → 34
- When supply pressure is closed, quick venting ensures rapid pressure reduction

General technical data							
Size	Mini		Midi			Maxi	
Pneumatic connection 1, 2	G $\frac{1}{8}$	G $\frac{1}{4}$	G $\frac{1}{4}$	G $\frac{3}{8}$	G $\frac{1}{2}$	G $\frac{1}{2}$	G $\frac{3}{4}$
Type of mounting	Via accessories In-line installation						
Assembly position	Vertical $\pm 5^\circ$						
Grade of filtration [µm]	40						
Bowl guard	Metal bowl guard						
Condensate drain	Manual rotary Fully automatic						
Actuator lock	Rotary knob with detent						
Pressure regulation range [bar]	2.5 ... 12						
Max. hysteresis [bar]	0.15	0.15	0.25	0.2	0.4	0.3	0.3
Pressure indication	Via pressure gauge						
Max. condensate volume [cm <sup>3</sup> ]	22		43			80 (43) <sup>1)</sup>	

1) For the FRC...-D-DI.

- | - Note: This product conforms to ISO 1179-1 and to ISO 228-1

Standard nominal flow rate $q_{nN}^{1)}$ [l/min]							
Connection	Mini		Midi			Maxi	
	G $\frac{1}{8}$	G $\frac{1}{4}$	G $\frac{1}{4}$	G $\frac{3}{8}$	G $\frac{1}{2}$	G $\frac{1}{2}$	G $\frac{3}{4}$
In main flow direction 1 → 2	550	650	1,100	1,420	1,590	3,500 (2,900) <sup>2)</sup>	3,800 (3,300) <sup>2)</sup>

1) Measured at p<sub>1</sub> = 10 bar, p<sub>2</sub> = 6 bar and Δp = 1 bar.

2) For the FRC...-D-DI.

# Service unit combinations FRC-KE, D series, metal design

Technical data combination FRC-KE

Operating and environmental conditions		
Condensate drain	Manual rotary	Fully automatic
Operating pressure [bar]	3 ... 16	3 ... 12
Operating medium	Compressed air in accordance with ISO 8573-1:2010 [-:-:-]	
Ambient temperature [°C]	-10 ... +60	
Temperature of medium [°C]	-10 ... +60	
Corrosion resistance class CRC <sup>1)</sup>	2	
Certification	Germanischer Lloyd	

1) Corrosion resistance class 2 according to Festo standard 940 070  
 Components subject to moderate corrosion stress. Externally visible parts with primarily decorative surface requirements which are in direct contact with a normal industrial environment or media such as coolants or lubricating agents.

Weight [g]			
Size	Mini	Midi	Maxi
FRC	1,200	2,800	4,200 (4,400) <sup>1)</sup>

1) For the FRC-...-D-DI.

 - Note  
 Materials → Technical data of the individual devices

## Standard flow rate qn as a function of the output pressure p2 FRC-1/2-D-DI-MAXI-KE(-A)

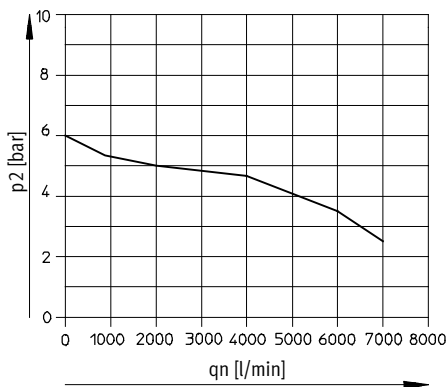

Primary pressure p1 = 10 bar

# Service unit combinations FRC-KE, D series, metal design

Technical data combination FRC-KE

Download CAD data → [www.festo.com](http://www.festo.com)

FRC-...-KE

3 Installation dimensions → Flow direction

Type	B7	B8	D1	H1	H2	H3	L1	L2	L3	L4	L5	L9	L10	T1	T2	T4	T5
<b>Mini</b>																	
FRC-...-D-MINI-KE (-A)	184	172	4.3	43	17.5	17.5	193	124	60	68	100	19	3	39	95	78	15
<b>Midi</b>																	
FRC-...-D-MIDI-KE (-A)	250	235	5.3	70	24.5	35.5	250	152	80	99	120	19	3	47	114	86	15
<b>Maxi</b>																	
FRC-...-D-MAXI-KE (-A)	294	278	5.3	70	24.5	35.5	252	171	90	82	150	19	3	53	126	92	15
FRC-...-D-DI-MAXI-KE (-A)							275			105							

<b>Ordering data</b>						
Size	Connection	Condensate drain turned manually			Condensate drain fully automatic	
		Part No.	Type		Part No.	Type
Mini	G1/8	185827	FRC-1/8-D-MINI-KE		185828	FRC-1/8-D-MINI-KE-A
	G1/4	185829	FRC-1/4-D-MINI-KE		185830	FRC-1/4-D-MINI-KE-A
Midi	G1/4	185831	FRC-1/4-D-MIDI-KE		185832	FRC-1/4-D-MIDI-KE-A
	G3/8	185833	FRC-3/8-D-MIDI-KE		185834	FRC-3/8-D-MIDI-KE-A
	G1/2	185835	FRC-1/2-D-MIDI-KE		185836	FRC-1/2-D-MIDI-KE-A
Maxi	G1/2	186059	FRC-1/2-D-MAXI-KE		186060	FRC-1/2-D-MAXI-KE-A
	G3/4	185837	FRC-3/4-D-MAXI-KE		185838	FRC-3/4-D-MAXI-KE-A
<b>Directly actuated pressure regulator with integrated return flow function</b>						
Maxi	G1/2	192471	FRC-1/2-D-DI-MAXI-KE		192481	FRC-1/2-D-DI-MAXI-KE-A
	G3/4	192476	FRC-3/4-D-DI-MAXI-KE		192486	FRC-3/4-D-DI-MAXI-KE-A

• Note: This product conforms to ISO 1179-1 and to ISO 228-1

# Service unit combinations FRC-KF, D series, metal design

Technical data combination FRC-KF

**Function**

With condensate drain  
manual rotary

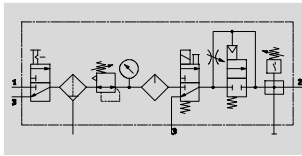

With condensate drain  
fully automatic

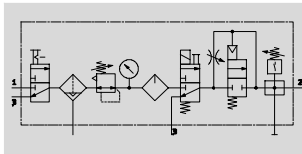

- Flow rate  
530 ... 6000 l/min
- Temperature range  
-10 ... +60 °C
- Operating pressure  
3 ... 16 bar

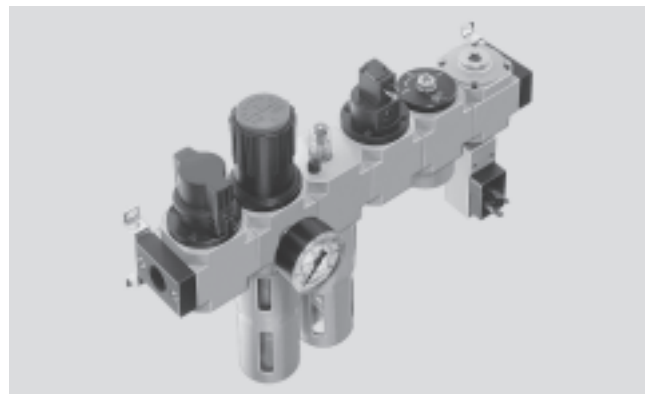

- On-off valve HE manually actuated
- Filter regulator LFR
- Lubricator LOE
- On-off valve HEE solenoid actuated, 24 V DC
- Soft-start valve HEL pneumatically actuated
- Branching module FRM with pressure switch
- Mounting accessories

- Gradual pressure build-up prevents sudden, unpredictable movements
- To ensure safe venting of the system, an additional quick exhaust valve is necessary at the output of the service unit combination
- For lubricated compressed air
- Two branch connections are available
- Supply pressure can be opened and closed
- New filter cartridges → 34

General technical data							
Size	Mini		Midi			Maxi	
Pneumatic connection 1, 2	G1/8	G1/4	G1/4	G3/8	G1/2	G1/2	G3/4
Type of mounting	Via accessories						
	In-line installation						
Assembly position	Vertical ±5°						
Grade of filtration [µm]	40						
Bowl guard	Metal bowl guard						
Condensate drain	Manual rotary						
	Fully automatic						
Actuator lock	Rotary knob with detent						
Pressure regulation range [bar]	2.5 ... 12						
Max. hysteresis [bar]	0.2	0.3	0.25	0.3	0.25	0.3	0.25
Pressure indication	Via pressure gauge						
Max. condensate volume [cm <sup>3</sup> ]	22		43			80 (43) <sup>1)</sup>	

1) For the FRC-...-D-DI.

- ¶ - Note: This product conforms to ISO 1179-1 and to ISO 228-1

Standard nominal flow rate q <sub>nN</sub> <sup>1)</sup> [l/min]							
Connection	Mini		Midi			Maxi	
	G1/8	G1/4	G1/4	G3/8	G1/2	G1/2	G3/4
In main flow direction 1 → 2	530	620	1,060	1,150	1,220	3,400 (5,000) <sup>2)</sup>	3,700 (6,000) <sup>2)</sup>

1) Measured at p<sub>1</sub> = 10 bar, p<sub>2</sub> = 6 bar and Δp = 1 bar.

2) For the FRC-...-D-DI.

# Service unit combinations FRC-KF, D series, metal design

Technical data combination FRC-KF

Operating and environmental conditions		
Condensate drain	Manual rotary	Fully automatic
Operating pressure [bar]	3 ... 16	3 ... 12
Operating medium	Compressed air in accordance with ISO 8573-1:2010 [-:-:-]	
Ambient temperature [°C]	-10 ... +60	
Temperature of medium [°C]	-10 ... +60	
Corrosion resistance class CRC <sup>1)</sup>	2	
Certification	Germanischer Lloyd	

1) Corrosion resistance class 2 according to Festo standard 940 070  
 Components subject to moderate corrosion stress. Externally visible parts with primarily decorative surface requirements which are in direct contact with a normal industrial environment or media such as coolants or lubricating agents.

Weight [g]			
Size	Mini	Midi	Maxi
FRC	1,800	4,000	6,300 (6,500) <sup>1)</sup>

1) For the FRC-...-D-DI.

 - Note  
 Materials → Technical data of the individual devices

## Standard flow rate qn as a function of the output pressure p2 FRC-1/2-D-DI-MAXI-KF(-A)

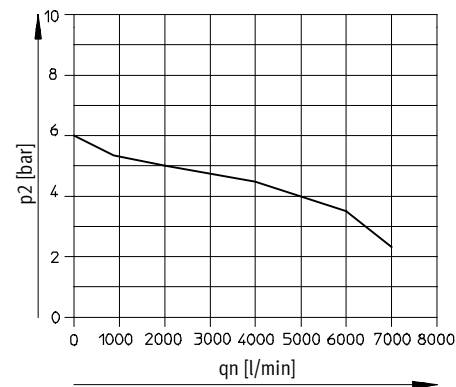

Primary pressure p1 = 10 bar

# Service unit combinations FRC-KF, D series, metal design

Technical data combination FRC-KF

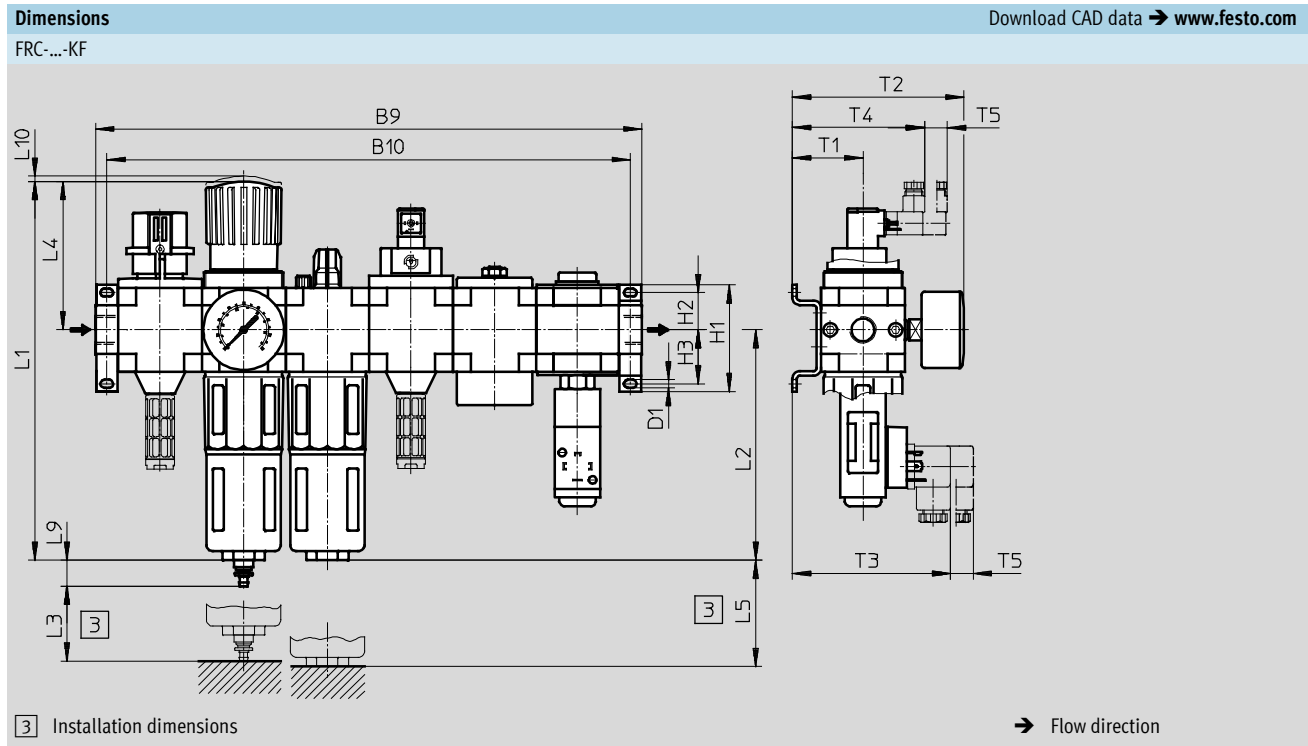



Type	B9	B10	D1	H1	H2	H3	L1	L2	L3	L4	L5	L9	L10	T1	T2	T3	T4	T5
<b>Mini</b>																		
FRC-...-D-MINI-KF (-A)	264	252	4.3	43	17.5	17.5	193	124	60	68	100	19	3	39	95	97	78	15
<b>Midi</b>																		
FRC-...-D-MIDI-KF (-A)	360	344	5.3	70	24.5	35.5	250	152	80	99	120	19	3	47	114	105	86	15
<b>Maxi</b>																		
FRC-...-D-MAXI-KF (-A)	426	410	5.3	70	24.5	35.5	252	171	90	82	150	19	3	53	126	111	92	15
FRC-...-D-DI-MAXI-KF (-A)							275			105								

<b>Ordering data</b>					
Size	Connection	Condensate drain turned manually		Condensate drain fully automatic	
		Part No.	Type	Part No.	Type
Mini	G1/8	185839	FRC-1/8-D-MINI-KF	185840	FRC-1/8-D-MINI-KF-A
	G1/4	185841	FRC-1/4-D-MINI-KF	185842	FRC-1/4-D-MINI-KF-A
Midi	G1/4	185843	FRC-1/4-D-MIDI-KF	185844	FRC-1/4-D-MIDI-KF-A
	G3/8	185845	FRC-3/8-D-MIDI-KF	185846	FRC-3/8-D-MIDI-KF-A
	G1/2	185847	FRC-1/2-D-MIDI-KF	185848	FRC-1/2-D-MIDI-KF-A
Maxi	G1/2	186061	FRC-1/2-D-MAXI-KF	186062	FRC-1/2-D-MAXI-KF-A
	G3/4	185849	FRC-3/4-D-MAXI-KF	185850	FRC-3/4-D-MAXI-KF-A
<b>Directly actuated pressure regulator with integrated return flow function</b>					
Maxi	G1/2	192472	FRC-1/2-D-DI-MAXI-KF	192482	FRC-1/2-D-DI-MAXI-KF-A
	G3/4	192477	FRC-3/4-D-DI-MAXI-KF	192487	FRC-3/4-D-DI-MAXI-KF-A

Note: This product conforms to ISO 1179-1 and to ISO 228-1

## Service unit combinations FRC-K, D series, polymer

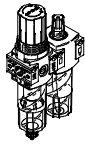
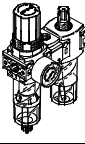
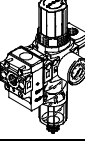
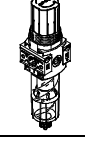
Product range overview D series service units, polymer

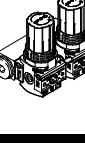
Type	Size	Pneumatic connection			Pressure regulation range [bar]	Grade of filtration [µm]		
		G1/8	G1/4	G1/2		5	40	
<b>Service units</b>								
FRC		Mini	■	■	-	■	■	■
<b>Service unit combinations</b>								
FRC-K		Mini	-	■	-	■	-	■
LFR-K		Mini	-	■	-	■	-	■
<b>Individual devices</b>								
Filter regulators LFR		Mini	■	■	-	■	■	■
Pressure regulators LR		Mini	■	■	-	■	-	-
Pressure regulator combinations LRB-K		Mini	-	-	■	■	-	-



## Service unit combinations FRC-K, D series, polymer

Product range overview D series service units, polymer

Type	Size	Condensate drain		Pressure display		Actuator lock	Regulating functions		→ Page/ Internet
		Manual rotary	Semi-automatic	With pressure gauge	Without pressure gauge		With secondary venting	With return flow function	
<b>Service units</b>									
FRC	Mini	■	■	■	-	■	■	■	frc
<b>Service unit combinations</b>									
FRC-K	Mini	■	-	■	-	■	■	■	26
LFR-K	Mini	■	-	■	-	■	■	■	lfr
<b>Individual devices</b>									
Filter regulators LFR	Mini	■	■	■	■	■	■	■	lfr
Pressure regulators LR	Mini	-	-	■	■	■	■	■	lr
Pressure regulator combinations LRB-K	Mini	-	-	-	■	■	■	■	lrb

## Service unit combinations FRC-K, D series, polymer

Peripherals overview

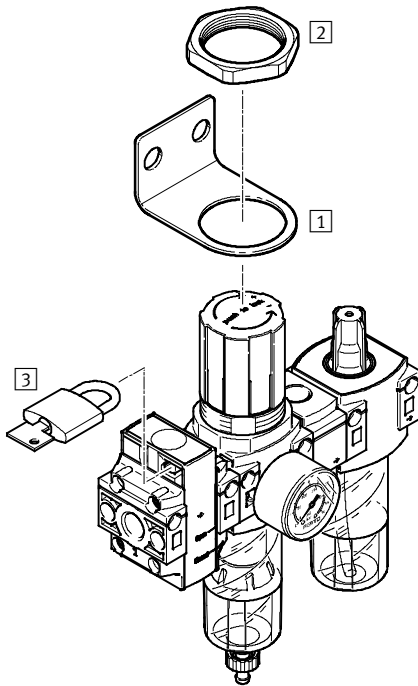

 Note

The range of accessories depends on the selected service unit combination. The example shows the service unit combination FRC-KC.

Mounting components and accessories		→ Page/Internet
1	Mounting bracket HR-D	hr-d
2	Hex nut HMR	hmr-d
3	Padlock LRVS	lrvs-d
-	Filter cartridge MS4-LFP-E	34
-	Special oil OFSW	34

## Service unit combinations FRC-K, D series, polymer

FESTO

Type codes

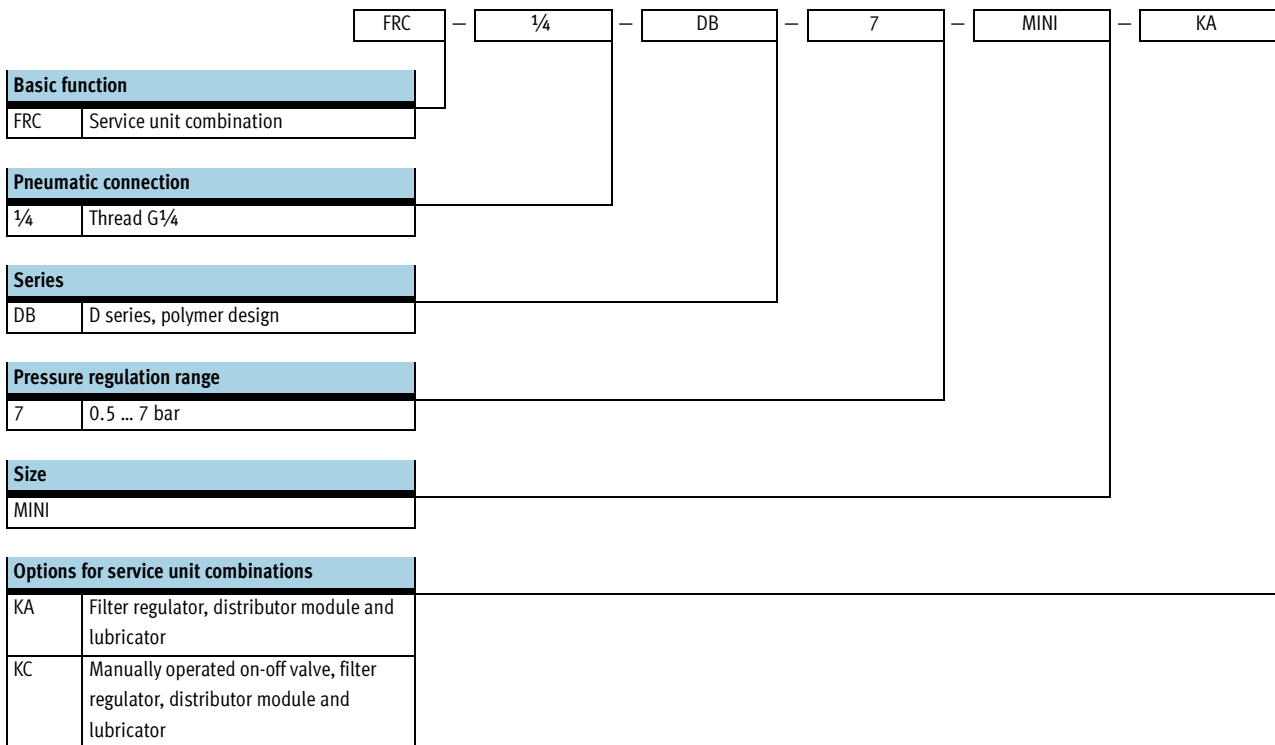



## Service unit combinations FRC-KA, D series, polymer

Technical data – FRC-KA combination

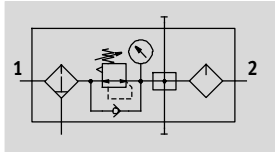
**Function**



- Filter regulator
- Distributor module
- Lubricator

-  - Standard nominal flow rate  
700 l/min
-  - Temperature range  
-5 ... +50 °C
-  - Operating pressure  
1.5 ... 10 bar



- For filtered and lubricated compressed air
- Output pressure is infinitely adjustable within the pressure regulation range

- Removal of filtered and unlubricated compressed air at the distributor module ports
- New filter cartridges → 34

The following oils are recommended for Festo components:  
Viscosity range to  
ISO 3448 class VG 32  
32 mm<sup>2</sup>/s (cSt) at 40 °C

- Approved oils:
- Festo special oil → 34
  - ARAL Vitam GF 32
  - BP Energol HLP 32
  - Esso Nuto H 32
  - Mobil DTE 24
  - Shell Tellus Oil DO 32

General technical data	
Size	Mini
Pneumatic connection 1, 2, 3	G <sup>1</sup> / <sub>4</sub>
Design	Filter regulator/distributor module/lubricator
Regulator type	Output pressure constant, without primary pressure compensation, with return flow action, with secondary venting
Type of mounting	In-line installation Via through-hole Via mounting bracket
Mounting position	Vertical ±5°
Grade of filtration [µm]	40
Condensate drain	Manual rotary
Actuation security	Rotary knob with detent
Pressure regulation range [bar]	0.5 ... 7
Max. pressure hysteresis [bar]	0.5
Pressure indication	Via pressure gauge
Pressure gauge connection	G <sup>1</sup> / <sub>8</sub>
Max. condensate volume [ml]	13

Flow rates [l/min]	
Standard nominal flow rate q <sub>nN</sub>	700
Max. standard flow rate	2,500

1) Measured at p<sub>1</sub> = 10 bar, p<sub>2</sub> = 6 bar and Δp = 1 bar.

-  - Note

The design allows for slight leakage at the outlet. It improves the control response of the controller without input pressure compensation. In rare cases, however, the leakage can sporadically be up to 500 l/min.

## Service unit combinations FRC-KA, D series, polymer

Technical data – FRC-KA combination

Operating and environmental conditions	
Operating pressure [bar]	1.5 ... 10
Operating medium	Compressed air according to ISO 8573-1:2010 [7:9:4]
Note on operating/pilot medium	Lubricated operation not possible
Ambient temperature [°C]	-5 ... +50
Temperature of medium [°C]	-5 ... +50
Storage temperature [°C]	-5 ... +50
Corrosion resistance class CRC <sup>1)</sup>	1

- 1) Corrosion resistance class 1 according to Festo standard 940 070  
 Components subject to low corrosion stress. Transport and storage protection. Parts that do not have primarily decorative surface requirements, e.g. in internal areas that are not visible or behind covers.

Weight [g]	
Service unit	285

Materials	
Housing	PA reinforced
Bowl	PC
Rotary knob	POM
Filter	PE
Seals	NBR
Note on materials	RoHS-compliant

# Service unit combinations FRC-KA, D series, polymer

Technical data – FRC-KA combination

**Dimensions**

Download CAD data → [www.festo.com](http://www.festo.com)

Mini

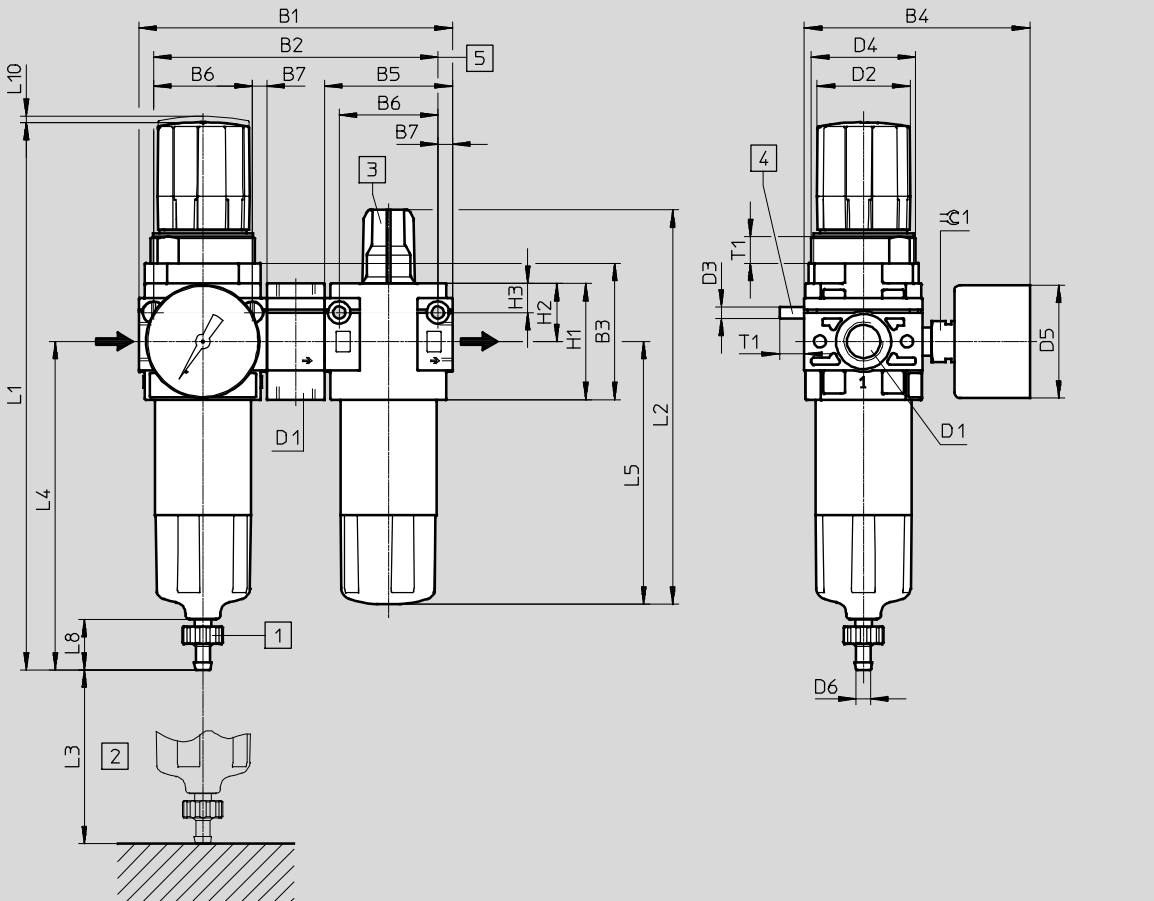

- 1 Barbed connector for plastic tubing PCN-4
- 2 Installation dimensions
- 3 Oil adjusting screw
- 4 M4 socket head screw for wall mounting (2 included in the scope of delivery)
- 5 Recommended through-holes for wall mounting via socket head screws
- Flow direction

Type	D1	B1	B2	B3	B4	B5	B6	B7	D2	D3	D4	D5	D6
FRC-1/4-DB	G1/4	108	98	47	78	44	34	5	∅	M4	M36x1.5	∅	∅

Type	H1	H2	H3	L1	L2	L3 min.	L4	L5	L8	L10	T1	≈C 1
FRC-1/4-DB	40	20	10	189	136	60	113	91	17	2	9	14



Ordering data			
Condensate drain	Size	Connection	Grade of filtration 40 µm
			Part No.    Type
With pressure gauge			
Manual rotary	Mini	G1/4	<b>8002800 FRC-1/4-DB-7-MINI-KA</b>

## Service unit combinations FRC-KC, D series, polymer

Technical data – FRC-KC combination

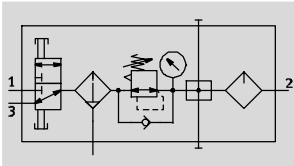
### Function



-  Standard nominal flow rate  
400 l/min
-  Temperature range  
-5 ... +50 °C
-  Operating pressure  
1.5 ... 10 bar



- Manually operated on-off valve
- Filter regulator
- Distributor module
- Lubricator

- For filtered and lubricated compressed air
- The operating pressure can be switched on or off
- Output pressure is infinitely adjustable within the pressure regulation range

- The unit is vented when switched off
- Removal of filtered and unlubricated compressed air at the distributor module ports
- New filter cartridges → 34

The following oils are recommended for Festo components:  
Viscosity range to  
ISO 3448 class VG 32  
32 mm<sup>2</sup>/s (cSt) at 40 °C

- Approved oils:
- Festo special oil → 34
  - ARAL Vitam GF 32
  - BP Energol HLP 32
  - Esso Nuto H 32
  - Mobil DTE 24
  - Shell Tellus Oil DO 32

General technical data	
Size	Mini
Pneumatic connection 1, 2, 3	G <sup>1</sup> / <sub>4</sub>
Design	On-off valve/filter regulator/distributor module/lubricator
Regulator type	Output pressure constant, without primary pressure compensation, with return flow action, with secondary venting
Type of mounting	In-line installation
	Via through-hole
	Via mounting bracket
Mounting position	Vertical ±5°
Actuation type	Manual
Grade of filtration [µm]	40
Condensate drain	Manual rotary
Actuation security	Rotary knob with detent
	Padlock (optional)
Exhaust function	No flow control
Pressure regulation range [bar]	0.5 ... 7
Max. pressure hysteresis [bar]	0.5
Pressure indication	Via pressure gauge
Pressure gauge connection	G <sup>1</sup> / <sub>8</sub>
Max. condensate volume [ml]	13

Flow rates [l/min]	
Standard nominal flow rate $q_{nN}$	400
Max. standard flow rate	2,400

1) Measured at  $p_1 = 10$  bar,  $p_2 = 6$  bar and  $\Delta p = 1$  bar.

-  - Note

The design allows for slight leakage at the outlet. It improves the control response of the controller without input pressure compensation. In rare cases, however, the leakage can sporadically be up to 500 l/min.

## Service unit combinations FRC-KC, D series, polymer

Technical data – FRC-KC combination

Operating and environmental conditions	
Operating pressure [bar]	1.5 ... 10
Operating medium	Compressed air according to ISO 8573-1:2010 [7:9:4]
Note on operating/pilot medium	Lubricated operation not possible
Ambient temperature [°C]	-5 ... +50
Temperature of medium [°C]	-5 ... +50
Storage temperature [°C]	-5 ... +50
Corrosion resistance class CRC <sup>1)</sup>	1

- 1) Corrosion resistance class 1 according to Festo standard 940 070  
 Components subject to low corrosion stress. Transport and storage protection. Parts that do not have primarily decorative surface requirements, e.g. in internal areas that are not visible or behind covers.

Weight [g]	
Service unit	360

Materials	
Housing	PA reinforced
Piston spool	POM
Bowl	PC
Rotary knob	POM
Filter	PE
Seals	NBR
On-off valve seals	FPM
Note on materials	RoHS-compliant



# Service unit combinations FRC-KC, D series, polymer

Technical data – FRC-KC combination

Dimensions Download CAD data → [www.festo.com](http://www.festo.com)

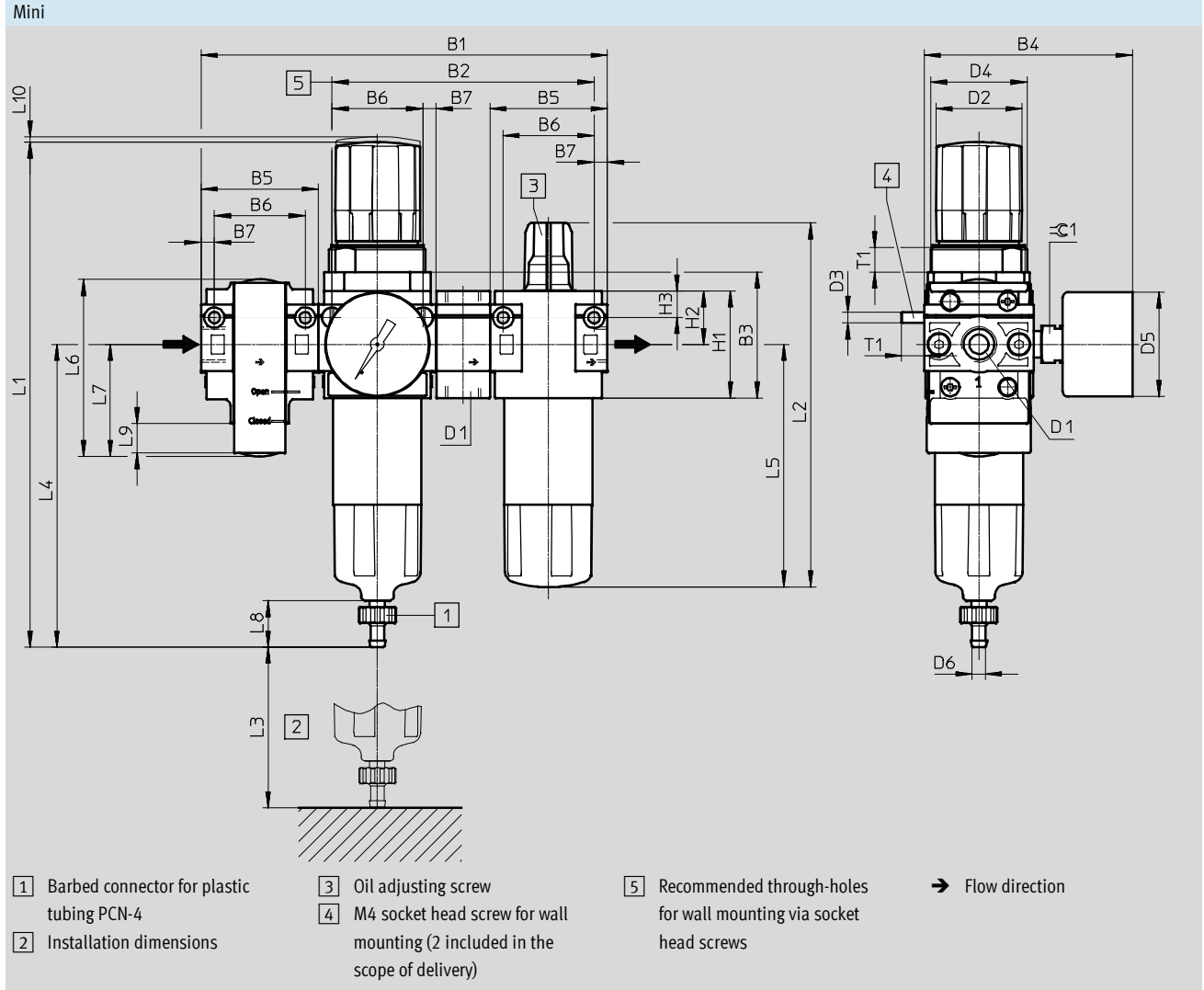

Type	D1	B1	B2	B3	B4	B5	B6	B7	D2	D3	D4	D5	D6
FRC-1/4-DB	G1/4	152	98	47	78	44	34	5	32	M4	M36x1.5	39	5

Type	H1	H2	H3	L1	L2	L3 min.	L4	L5	L6	L7	L8	L9	L10	T1	≈ 1
FRC-1/4-DB	40	20	10	189	136	60	113	91	66	42	17	11	2	9	14

Ordering data			
Condensate drain	Size	Connection	Grade of filtration 40 µm
			Part No. Type
With pressure gauge			
Manual rotary	Mini	G1/4	<b>8002801 FRC-1/4-DB-7-MINI-KC</b>

## Service unit combinations FRC-K, D series

Accessories

FESTO

Filter cartridges, D series, metal design



Ordering data			
Size	Grade of filtration [µm]	Part No.	Type
Mini	40 (colour: white)	363665	LFP-D-MINI-40M
Midi	40 (colour: white)	363667	LFP-D-MIDI-40M
Maxi	40 (colour: white)	363664	LFP-D-MAXI-40M

Filter cartridges, D series, polymer



Ordering data			
Size	Grade of filtration [µm]	Part No.	Type
Mini	40	534502	MS4-LFP-E

Special oil





Ordering data			
Scope of delivery		Part No.	Type
1 litre		152811	OFSW-32

## Service unit combinations FRC-K, D series

FESTO

Accessories

Ordering data – Angled socket PEV					Technical data → Internet: pev-1/4	
	Description	Operating voltage range	Electrical connection	Switching status display	Part No.	Type
	for PEV-1/4-...-OD	15 ... 30 V DC	4-pin	Yellow LED	164274	PEV-1/4-WD-LED-24
		≤ 230 V AC ≤ 180 V DC	4-pin	Yellow LED	164275	PEV-1/4-WD-LED-230

Ordering data – Plug socket MSSD					Technical data → Internet: mssd	
	Description	Operating voltage range	Electrical connection	Type of mounting cable connection	Part No.	Type
	for PEV-1/4-...-OD	≤ 250 V AC/DC	3-pin	Clamping screws	171157	MSSD-C-4P
	for on-off valve HEE	≤ 250 V AC/DC	3-pin	Clamping screws	151687	MSSD-EB
			4-pin	Insulation displacement technology	192745	MSSD-EB-S-M14

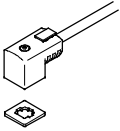
Ordering data – Plug socket with cable KMEB						Technical data → Internet: kmeb	
	Description	Operating voltage range	Electrical connection	Switching status display	Cable length [m]	Part No.	Type
	for on-off valve HEE	24 V DC	3-pin	LED	2.5	151688	KMEB-1-24-2,5-LED
					5	151689	KMEB-1-24-5-LED
					10	193457	KMEB-1-24-10-LED
		230 V AC	3-pin	–	2.5	151690	KMEB-1-230AC-2,5
					5	151691	KMEB-1-230AC-5

Ordering data – Illuminating seal MEB-LD				Technical data → Internet: meb	
	Description	Operating voltage range		Part No.	Type
	for plug socket with cable KMEB and plug socket MSSD-EB	12 ... 24 V DC		151717	MEB-LD-12-24DC
		230 V DC/AC ±10%		151718	MEB-LD-230AC