

**Electric cylinders EPCO, with spindle drive**



# Electric cylinders EPCO, with spindle drive

Key features

## At a glance

### General

The electric cylinder EPCO is a mechanical linear drive with piston rod and permanently attached motor. The driving component consists of an

electrically actuated spindle that converts the rotary motion of the motor into linear motion of the piston rod.

### Properties

- With recirculating ball spindle
- Optionally with female thread
- Optionally with holding brake
- Protection class IP40
- Compact dimensions
- Extensive mounting accessories for various installation situations

### Range of applications

- Suitable for simple applications in factory automation that in the past were mostly realised with pneumatic solutions

## Everything from a single source

Electric cylinder  
EPCO  
→ 6

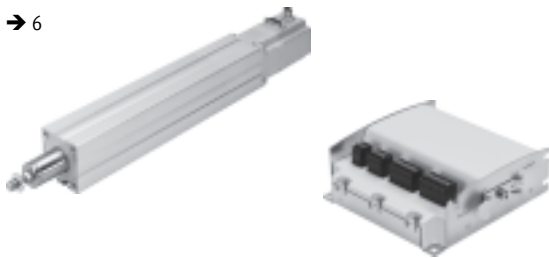

Controller  
CMMO  
→ Internet: [cmmo](http://cmmo)

- Electric cylinder EPCO
- Controller CMMO
- Motor cable NEBM
- Encoder cable NEBM

The electric cylinder EPCO and controller CMMO form one unit. Two activation modes possible:

- Closed-loop operation with encoder (servo lite operation)
- Open-loop operation without encoder, for cost-optimised applications

## Motor mounting variants

EPCO-16

Standard

Underneath (feature D)

Left (feature L)

Right (feature R)

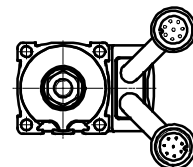
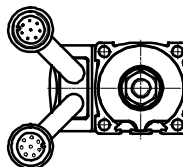
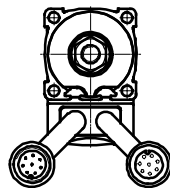
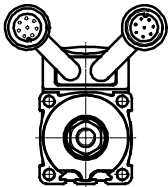

EPCO-25/-40

Standard

Underneath (feature D)

Left (feature L)

Right (feature R)

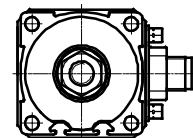
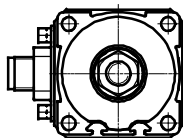
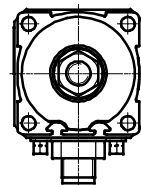
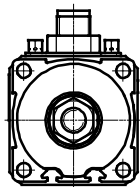

# Electric cylinders EPCO, with spindle drive

Type codes

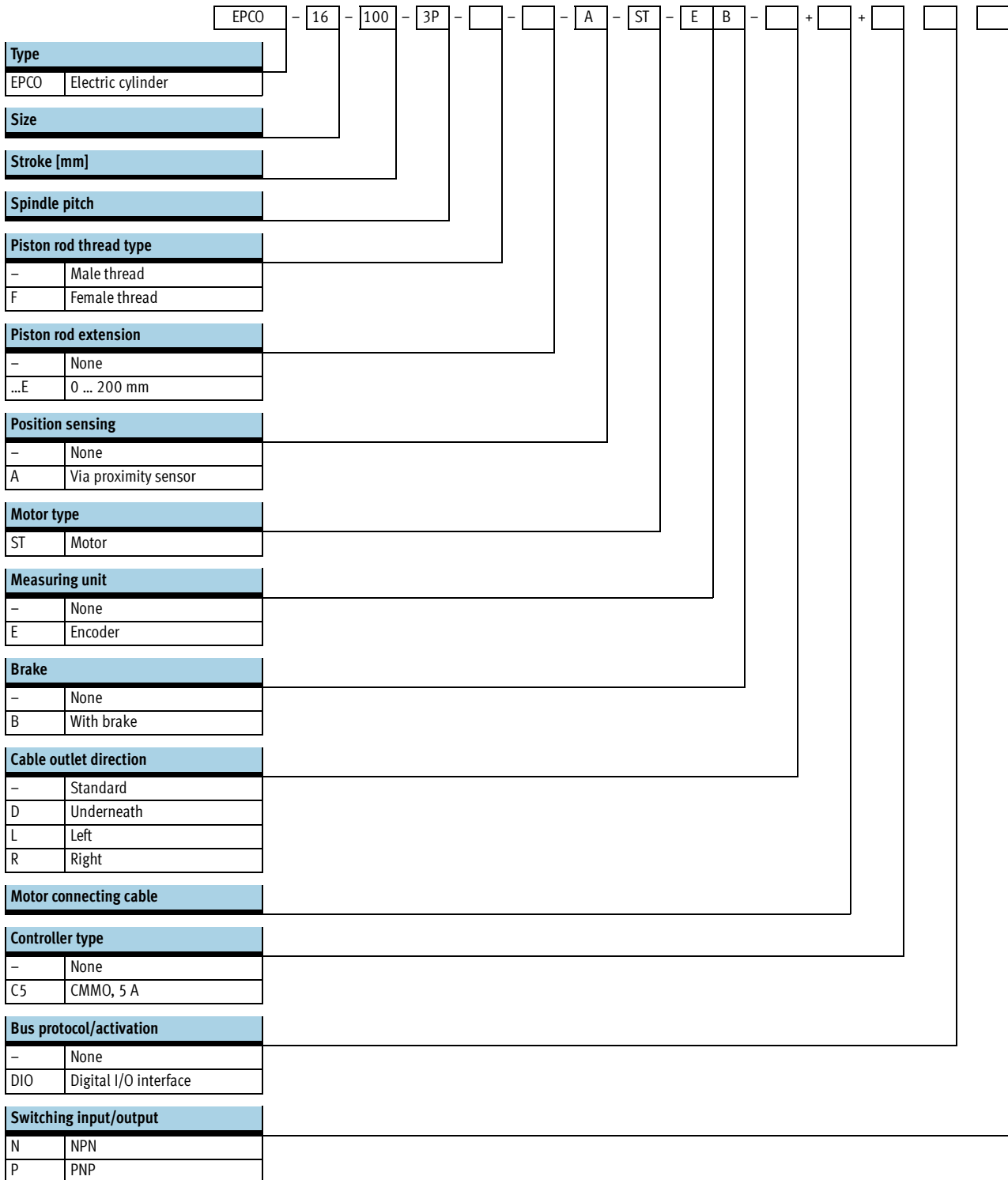

# Electric cylinders EPCO, with spindle drive

Peripherals overview

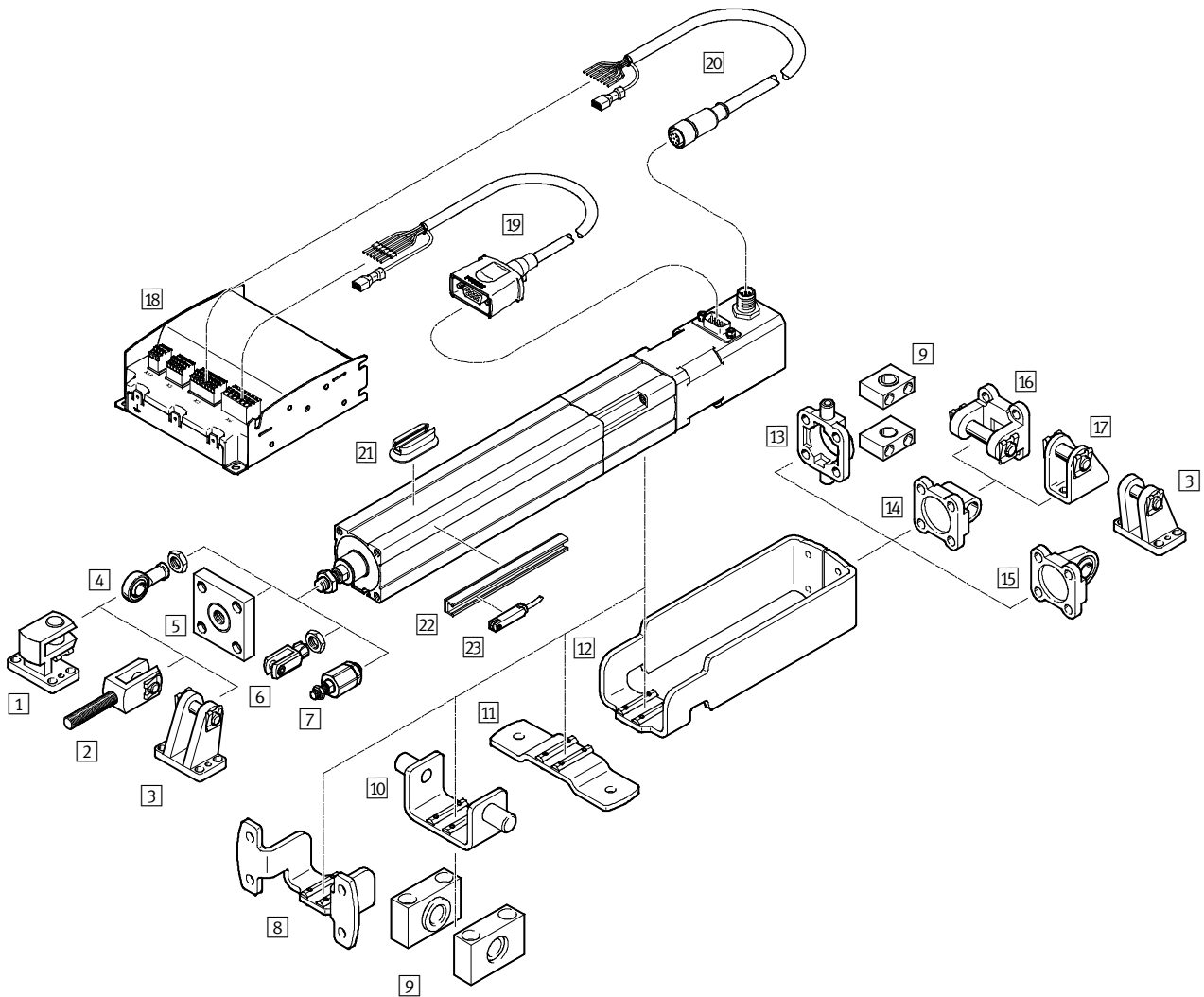

# Electric cylinders EPCO, with spindle drive

Peripherals overview

Mounting attachments and accessories						
	Brief description	For size			→ Page/Internet	
		16	25	40		
1	Right-angle clevis foot LQG	For rod eye SGS	-	-	■	28
2	Rod clevis SGA	For rod eye SGS, for swivelling cylinder mounting	-	-	■	29
3	Clevis foot LBG	For rod eye SGS, for spherical bearing	-	-	■	28
4	Rod eye SGS/CRSGS	For spherical bearing	■	■	■	29
5	Coupling piece KSG	For compensating radial deviations	-	-	■	29
6	Rod clevis SG/CRSG	Permits a swivelling movement of the cylinder in one plane	■	■	■	29
7	Self-aligning rod coupler FK	For compensating radial and angular deviations	■	■	■	29
8	Flange mounting EAHH	- For mounting the electric cylinder via the profile - Position freely selectable along the cylinder length	■	■	■	23
9	Trunnion support LNZG	For mounting the cylinder in combination with swivel mounting or trunnion flange	■	■	■	26
10	Swivel mounting EAHS	Position freely selectable along the cylinder length	■	■	■	24
11	Foot mounting EAHF	Position freely selectable along the cylinder length	■	■	■	22
12	Adapter kit EAHA	For mounting swivel flange and trunnion flange on the front side. The only motor connection that can be ordered with this adapter kit is for top or bottom mounting.	■	■	■	25
13	Trunnion flange ZNCF	For spherical bearing. It cannot be mounted when turned by 90°.	-	-	■	26
14	Swivel flange SNCL	For spherical bearing	■	■	■	27
15	Swivel flange SNCS	For spherical bearing	-	-	■	27
16	Swivel flange SNCB/SNCB-...-R3	For spherical bearing	-	-	■	28
17	Clevis foot LBN	For spherical bearing	■	■	■	28
18	Controller CMMO	For parameterising and positioning the electric cylinder	■	■	■	cmmo
19	Motor cable NEBM	For connecting the motor and controller	■	■	■	31
20	Encoder cable NEBM	For connecting the encoder and controller	■	■	■	31
21	Mounting kit CRSMB	For proximity sensor SME/SMT-8	■	■	■	30
22	Sensor rail SAMH	- For proximity sensor SME/SMT-8 - Size 25 only with proximity sensor SMT-8	■	■	■	30
23	Proximity sensor SME/SMT-8	For homing or position sensing	■	■	■	29

 Note

For applications involving high loads, the cylinder must not be mounted exclusively via the mounting thread on the front.



The mass of the motor can be amplified by the lever effect, which can result in the mounting thread being torn out.

# Electric cylinders EPCO, with spindle drive

Technical data

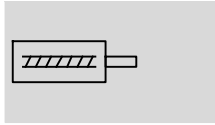
Function



-  - Size  
16 ... 40
-  - Stroke length  
1 ... 400 mm



General technical data			
Size	16	25	40
Design	Electric cylinder with recirculating ball spindle and motor		
Piston rod thread			
Male thread	M6	M8	M10x1.25
Female thread	M4	M6	M8
Working stroke [mm]	50 ... 200	50 ... 300	50 ... 400
Stroke reserve [mm]	0		
Max. torsion angle of the piston rod [°]	≤ ±2	≤ ±1.5	≤ ±1
Impact energy at the end positions [J]	0.1x 10 <sup>-3</sup>	0.2x 10 <sup>-3</sup>	0.4x 10 <sup>-3</sup>
Position sensing	Via proximity sensor		
Type of mounting	Via female thread Via accessories		
Mounting position	Any		

Mechanical data						
Size	16		25		40	
Spindle design	3P	8P	3P	10P	5P	12.7P
Spindle pitch <sup>1)</sup> [mm/rev.]	3	8	3	10	5	12.7
Spindle diameter [mm]	8	8	10	10	12	12.7
Max. effective load						
Horizontal <sup>2)</sup> [kg]	24	8	60	20	120	40
Vertical [kg]	12	4	30	10	60	20
Max. feed force F <sub>x</sub> [N]	125	50	350	105	650	250
Max. speed [mm/s]	125	300	150	500	180	460
Max. acceleration [m/s <sup>2</sup> ]	10					
Reversing backlash <sup>3)</sup> [mm]	≤ 0.1					
Repetition accuracy [mm]	±0.02					

1) Nominal value varies due to component tolerances

2) Note max. lateral force

3) In new condition

# Electric cylinders EPCO, with spindle drive

Technical data

Electrical data				
Size	16		25	40
<b>Motor</b>				
Nominal voltage	[V DC]	24		
Nominal current	[A]	1.4	3	4.2
<b>Holding brake</b>				
Nominal voltage	[V DC]	24 ±10%		
Rated output	[W]	8		
<b>Encoder</b>				
Pulses/revolution		500		
Zero pulse		Yes		
Line driver		RS422 protocol		
Operating voltage of encoder	[V]	5		

Operating and environmental conditions		
Ambient temperature <sup>1)</sup>	[°C]	0 ... +50
Storage temperature	[°C]	-20 ... +60
Relative air humidity	[%]	45 ... 80 (non-condensing)
Protection class to IEC 60529		IP40
Corrosion resistance class CRC <sup>2)</sup>		1
Duty cycle	[%]	100
CE mark (see declaration of conformity)		To EU EMC Directive <sup>3)</sup>
Certification		C-Tick

- 1) Note operating range of proximity sensors
- 2) Corrosion resistance class 1 according to Festo standard 940 070  
Components subject to low corrosion stress. Transport and storage protection. Parts that do not have primarily decorative surface requirements, e.g. in internal areas that are not visible or behind covers.
- 3) For information about the applicability of the component see the manufacturer's EC declaration of conformity at: [www.festo.com](http://www.festo.com) → Support → User documentation.  
If the component is subject to restrictions on usage in residential, office or commercial environments or small businesses, further measures to reduce the emitted interference may be necessary.

Weight [kg]				
Size	16		25	40
<b>Basic weight with 0 mm stroke</b>				
EPCO-...-ST	0.62	1.04	2.49	
EPCO-...-ST-E	0.62	1.13	2.59	
EPCO-...-ST-B	0.68	1.22	2.71	
EPCO-...-ST-EB	0.68	1.28	2.77	
Additional weight per 100 mm stroke	0.17	0.34	0.55	
Moving load with 0 mm stroke	0.07	0.15	0.42	
Moving load per 10 mm stroke	0.0020	0.0026	0.0049	

Mass moment of inertia							
Size	16		25		40		
Spindle design	3P	8P	3P	10P	5P	12.7P	
<b>J<sub>0</sub> with 0 mm stroke</b>							
EPCO-...-ST	[kg mm <sup>2</sup> ]	2.28	2.29	9.33	9.40	33.25	33.75
EPCO-...-ST-B	[kg mm <sup>2</sup> ]	2.97	2.98	10.63	10.70	34.55	35.05
j <sub>S</sub> per meter stroke	[kg mm <sup>2</sup> /m]	2.53	2.65	4.87	5.78	11.66	16.70
j <sub>L</sub> per kg effective load	[kg mm <sup>2</sup> /kg]	0.23	1.62	0.23	2.54	0.64	4.09

The mass moment of inertia  $J_A$  of the electric cylinder is calculated as follows:

$$J_A = J_0 + j_S \times \text{working stroke [m]} + j_L \times m_{\text{moving effective load [kg]}}$$

# Electric cylinders EPCO, with spindle drive

Technical data

## Materials

Sectional view

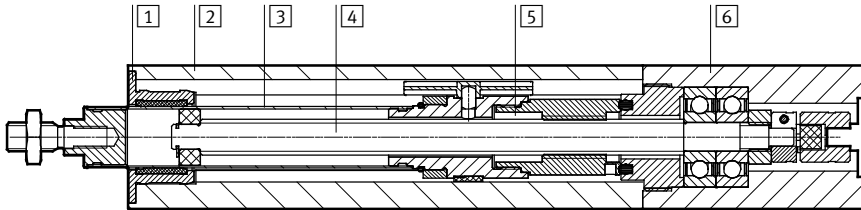

### Electric cylinder

1	Bearing cap	Wrought aluminium alloy
2	Cylinder barrel	Wrought aluminium alloy
3	Piston rod	High-alloy stainless steel
4	Spindle	Steel
5	Spindle nut	Steel
6	Drive cover	Wrought aluminium alloy
Note on materials		Contains PWIS (paint-wetting impairment substances)
		RoHS-compliant

### Piston rod deflection $f$ as a function of projection $l$ and lateral force $F$

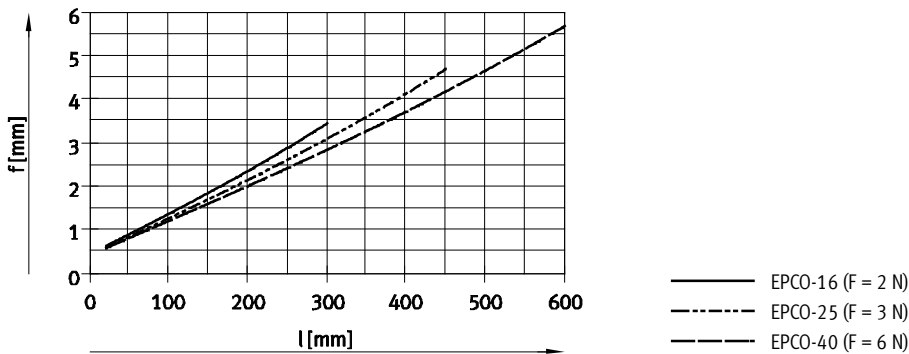
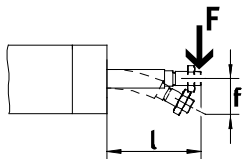



# Electric cylinders EPCO, with spindle drive

Technical data

## Maximum permissible loads on the piston rod

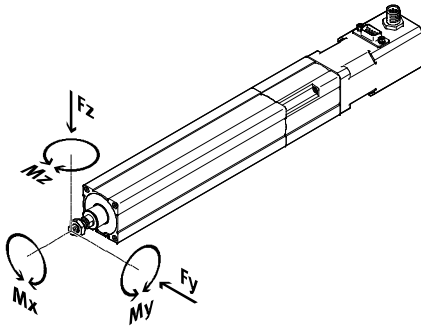

If there are two or more forces and torques simultaneously acting on the piston rod, the following equations must be satisfied:

$$\frac{|F_y|}{F_{y_{max}}} + \frac{|F_z|}{F_{z_{max}}} + \frac{|M_y|}{M_{y_{max}}} + \frac{|M_z|}{M_{z_{max}}} \leq 1$$

$$|F_x| \leq F_{x_{max}}$$

$$|M_x| \leq M_{x_{max}}$$

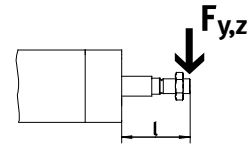

## Maximum permissible lateral forces $F_{y_{max}}$ and $F_{z_{max}}$ on the piston rod as a function of projection l

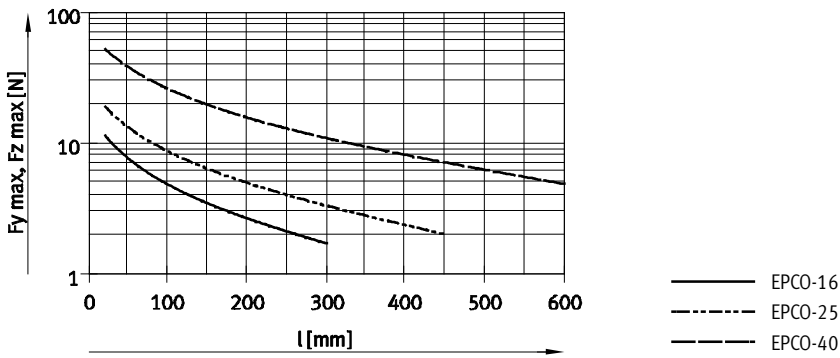

Size	16		25		40	
Spindle design	3P	8P	3P	10P	5P	12.7P
$F_{x_{max}}$ (static) [N]	125	50	350	105	650	250
$M_{x_{max}}$ [Nm]	0		0		0	
$M_{y_{max}}, M_{z_{max}}$ [Nm]	0.6		1.0		3.3	

-  Note  
 PositioningDrives  
 sizing software  
 → [www.festo.com](http://www.festo.com)

# Electric cylinders EPCO, with spindle drive

Technical data

## Effective load $m$ as a function of speed $v$ and acceleration $a$

Horizontal mounting position

EPCO-16-3P

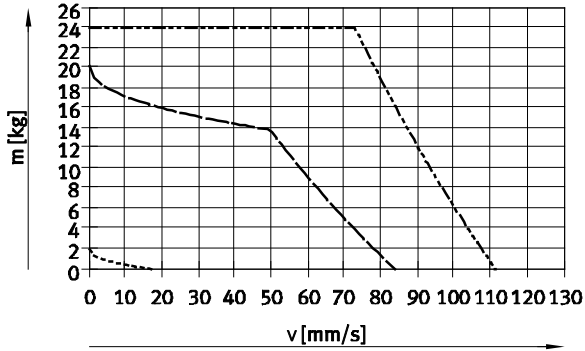

EPCO-16-8P

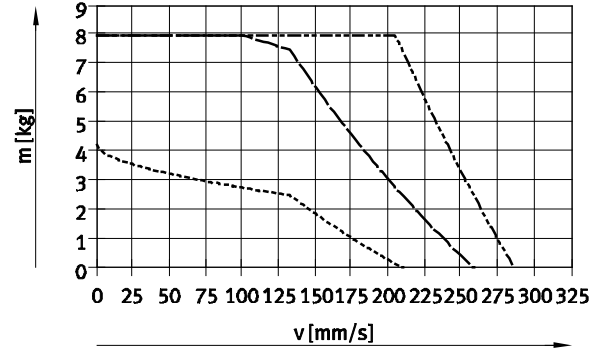

EPCO-25-3P

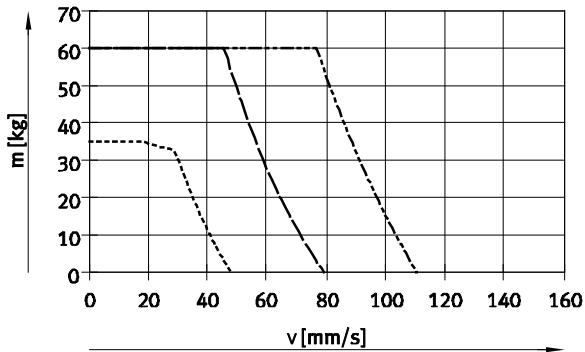

EPCO-25-10P

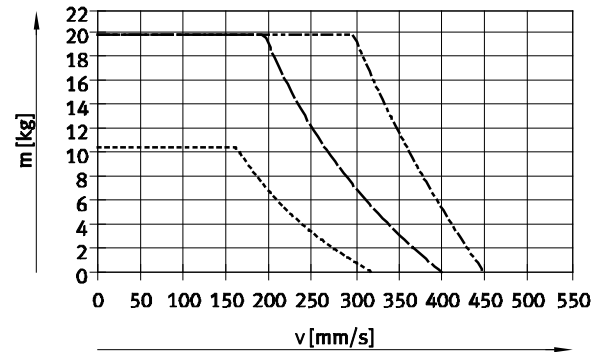

EPCO-40-5P

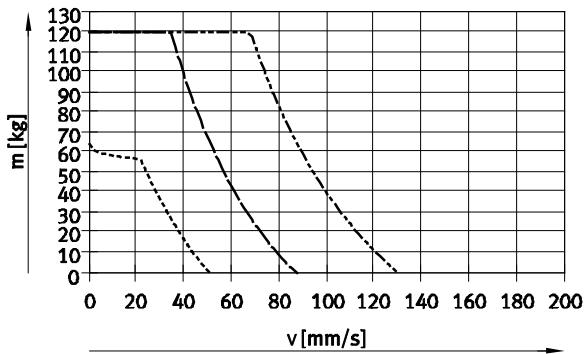

EPCO-40-12,7P

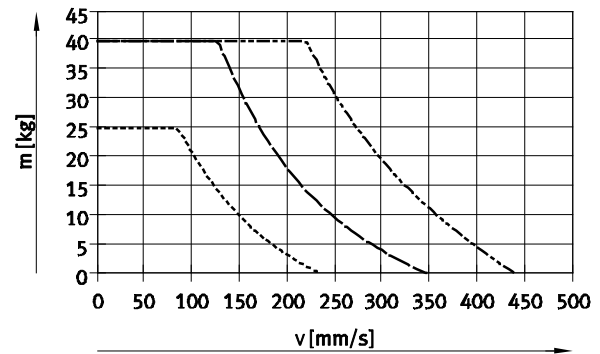

- $a = 2.5 \text{ m/s}^2$
- $a = 5 \text{ m/s}^2$
- .....  $a = 10 \text{ m/s}^2$

# Electric cylinders EPCO, with spindle drive

Technical data

## Effective load $m$ as a function of speed $v$ and acceleration $a$

Vertical mounting position

EPCO-16-3P

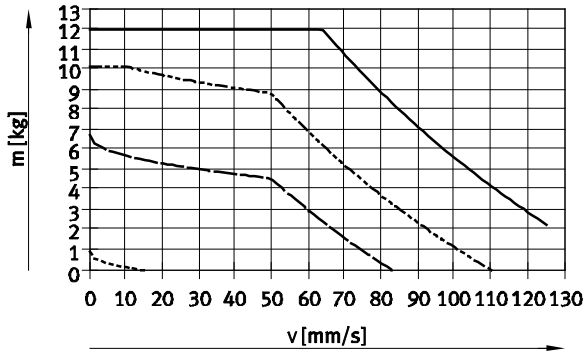

EPCO-16-8P

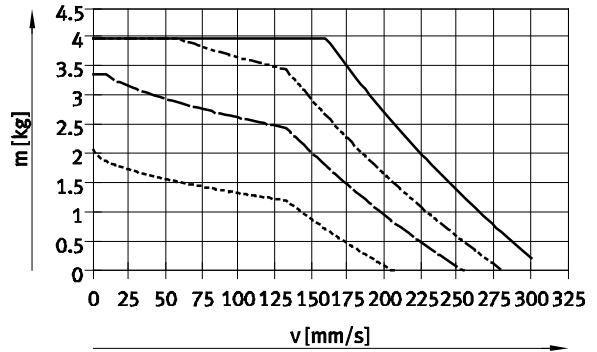

EPCO-25-3P

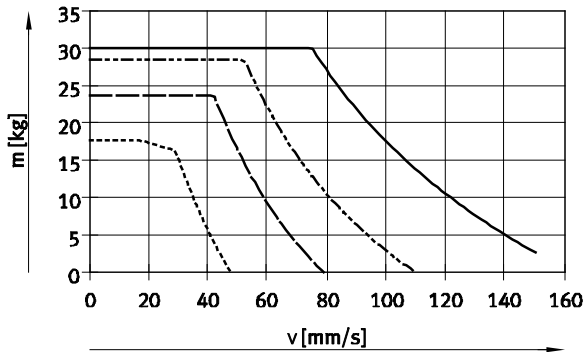

EPCO-25-10P

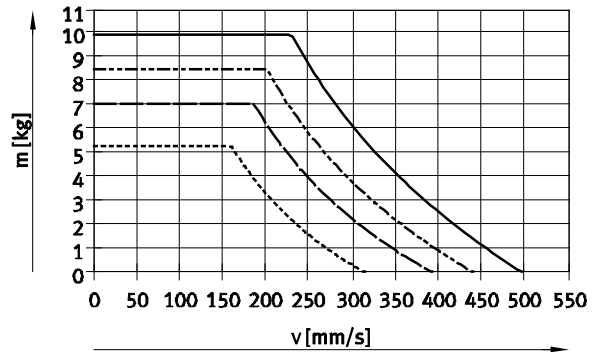

EPCO-40-5P

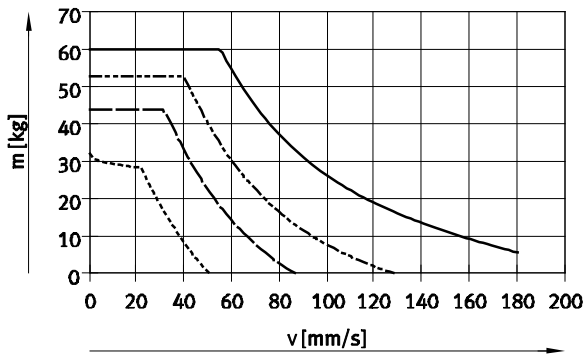

EPCO-40-12,7P

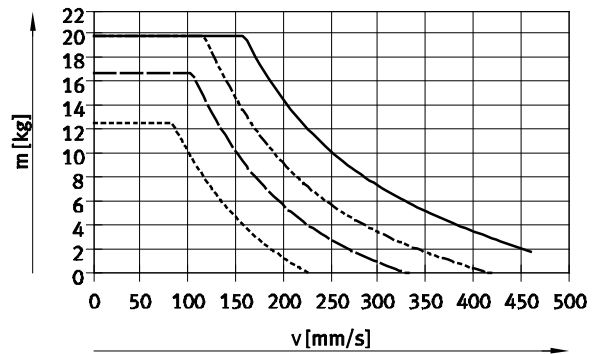

- $a = 0 \text{ m/s}^2$
- - -  $a = 2.5 \text{ m/s}^2$
- · -  $a = 5 \text{ m/s}^2$
- · ·  $a = 10 \text{ m/s}^2$

# Electric cylinders EPCO, with spindle drive

Technical data

## Positioning time $t$ as a function of effective load $m$ and travel distance $l$

Horizontal mounting position

EPCO-16-3P

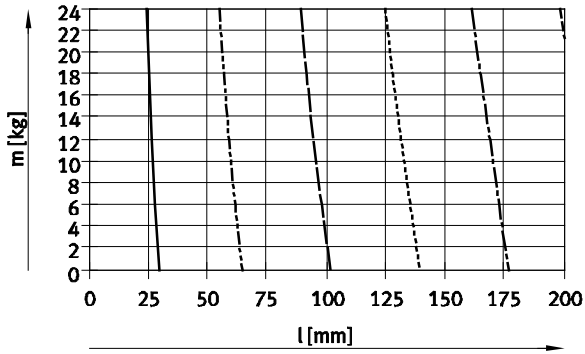

- $t = 0.3 \text{ s}$       - - - - -  $t = 1.2 \text{ s}$
- - - - -  $t = 0.6 \text{ s}$       - · - · -  $t = 1.5 \text{ s}$
- · - · -  $t = 0.9 \text{ s}$       - - - - -  $t = 1.8 \text{ s}$

EPCO-16-8P

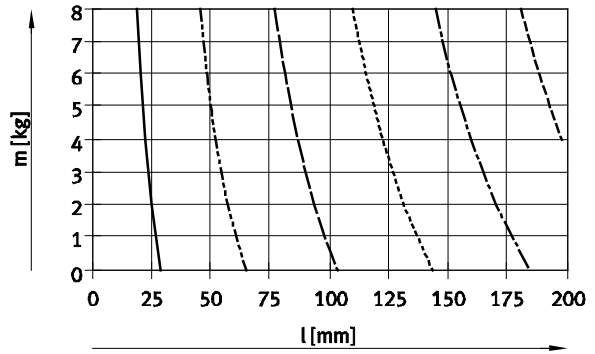

- $t = 0.15 \text{ s}$       - - - - -  $t = 0.6 \text{ s}$
- - - - -  $t = 0.3 \text{ s}$       - · - · -  $t = 0.75 \text{ s}$
- · - · -  $t = 0.45 \text{ s}$       - - - - -  $t = 0.9 \text{ s}$

EPCO-25-3P

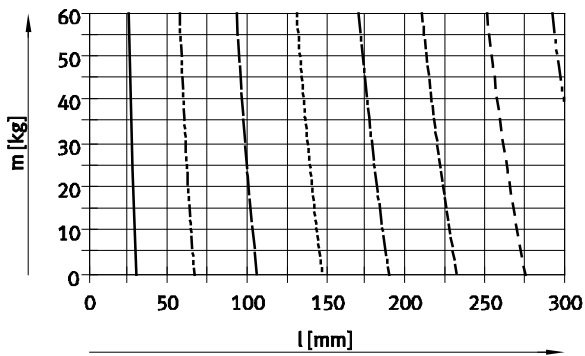

- $t = 0.3 \text{ s}$       - - - - -  $t = 1.5 \text{ s}$
- - - - -  $t = 0.6 \text{ s}$       - · - · -  $t = 1.8 \text{ s}$
- · - · -  $t = 0.9 \text{ s}$       - - - - -  $t = 2.1 \text{ s}$
- - - - -  $t = 1.2 \text{ s}$       - - - - -  $t = 2.4 \text{ s}$

EPCO-25-10P

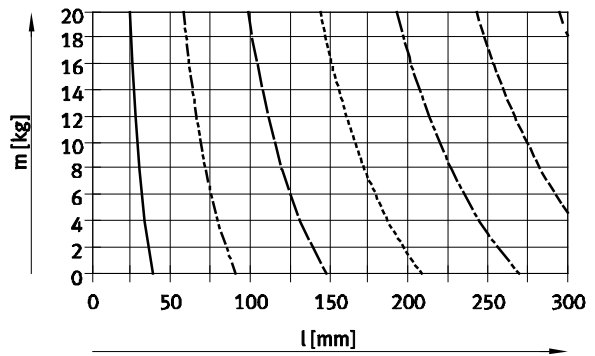

- $t = 0.15 \text{ s}$       - - - - -  $t = 0.75 \text{ s}$
- - - - -  $t = 0.30 \text{ s}$       - · - · -  $t = 0.90 \text{ s}$
- · - · -  $t = 0.45 \text{ s}$       - - - - -  $t = 1.05 \text{ s}$
- - - - -  $t = 0.60 \text{ s}$

EPCO-40-5P

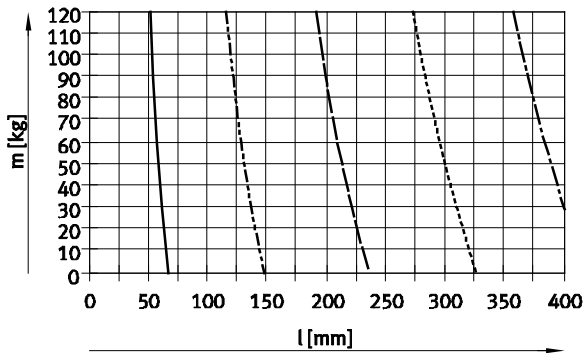

- $t = 0.5 \text{ s}$       - - - - -  $t = 2.0 \text{ s}$
- - - - -  $t = 1.0 \text{ s}$       - · - · -  $t = 2.5 \text{ s}$
- · - · -  $t = 1.5 \text{ s}$

EPCO-40-12,7P

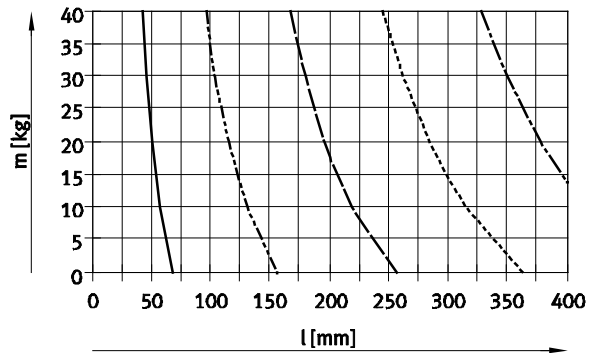

- $t = 0.25 \text{ s}$       - - - - -  $t = 1.00 \text{ s}$
- - - - -  $t = 0.50 \text{ s}$       - · - · -  $t = 1.25 \text{ s}$
- · - · -  $t = 0.75 \text{ s}$

# Electric cylinders EPCO, with spindle drive

Technical data

## Positioning time $t$ as a function of effective load $m$ and travel distance $l$

Vertical mounting position

EPCO-16-3P

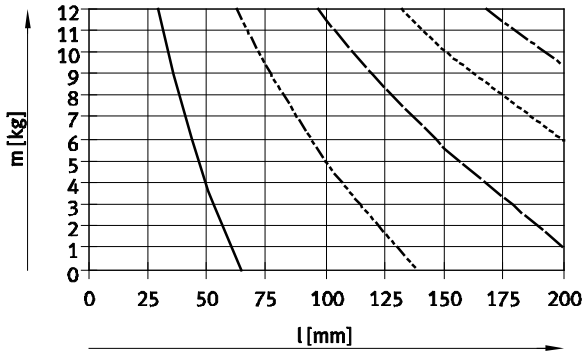

———  $t = 0.6 \text{ s}$       - - - - -  $t = 2.4 \text{ s}$   
 - - - - -  $t = 1.2 \text{ s}$       - - - - -  $t = 3.0 \text{ s}$   
 - - - - -  $t = 1.8 \text{ s}$

EPCO-16-8P

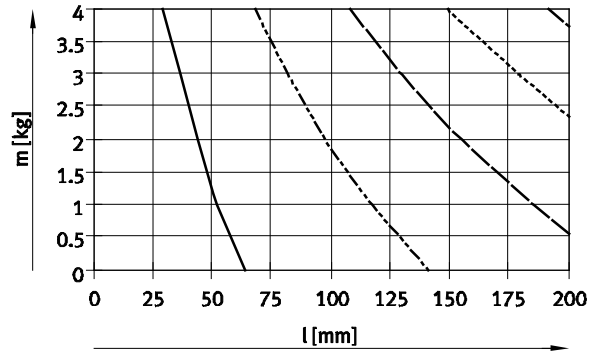

———  $t = 0.3 \text{ s}$       - - - - -  $t = 1.2 \text{ s}$   
 - - - - -  $t = 0.6 \text{ s}$       - - - - -  $t = 1.5 \text{ s}$   
 - - - - -  $t = 0.9 \text{ s}$

EPCO-25-3P

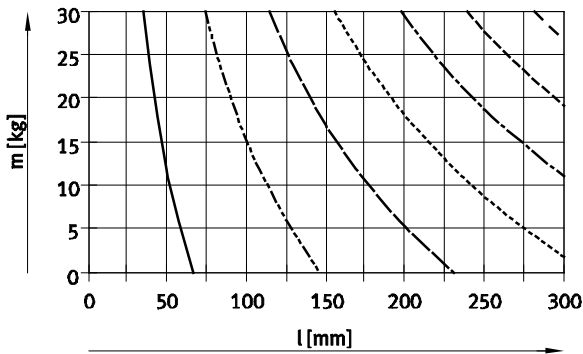

———  $t = 0.6 \text{ s}$       - - - - -  $t = 3.0 \text{ s}$   
 - - - - -  $t = 1.2 \text{ s}$       - - - - -  $t = 3.6 \text{ s}$   
 - - - - -  $t = 1.8 \text{ s}$       - - - - -  $t = 4.2 \text{ s}$   
 - - - - -  $t = 2.4 \text{ s}$

EPCO-25-10P

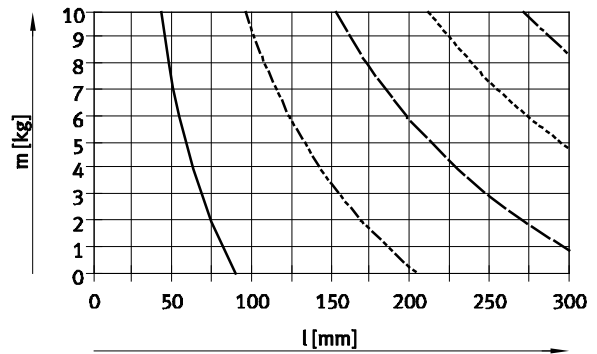

———  $t = 0.3 \text{ s}$       - - - - -  $t = 1.2 \text{ s}$   
 - - - - -  $t = 0.6 \text{ s}$       - - - - -  $t = 1.5 \text{ s}$   
 - - - - -  $t = 0.9 \text{ s}$

EPCO-40-5P

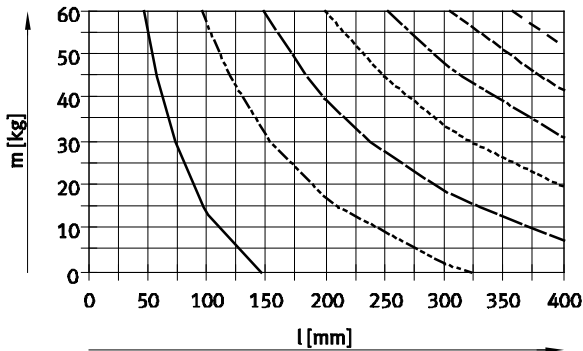

———  $t = 1 \text{ s}$       - - - - -  $t = 5 \text{ s}$   
 - - - - -  $t = 2 \text{ s}$       - - - - -  $t = 6 \text{ s}$   
 - - - - -  $t = 3 \text{ s}$       - - - - -  $t = 7 \text{ s}$   
 - - - - -  $t = 4 \text{ s}$

EPCO-40-12,7P

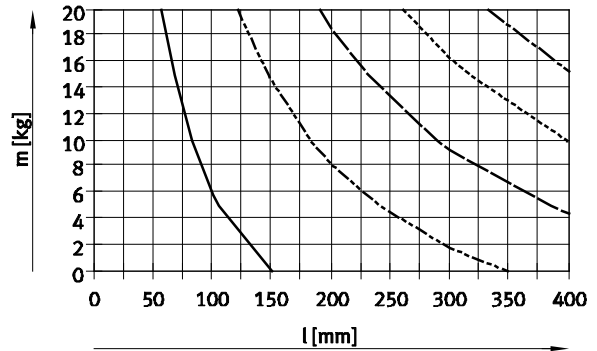

———  $t = 0.5 \text{ s}$       - - - - -  $t = 2.0 \text{ s}$   
 - - - - -  $t = 1.0 \text{ s}$       - - - - -  $t = 2.5 \text{ s}$   
 - - - - -  $t = 1.5 \text{ s}$

# Electric cylinders EPCO, with spindle drive

Technical data

## Feed force F as a function of speed v and acceleration a

EPCO-16-3P

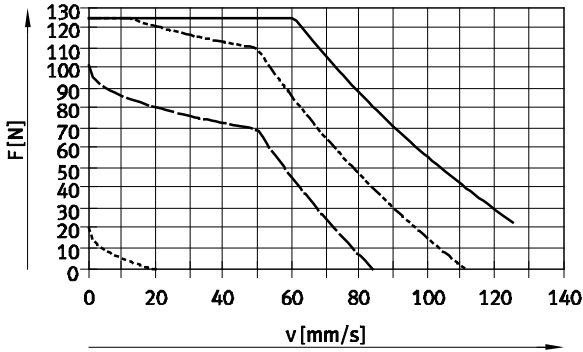

EPCO-16-8P

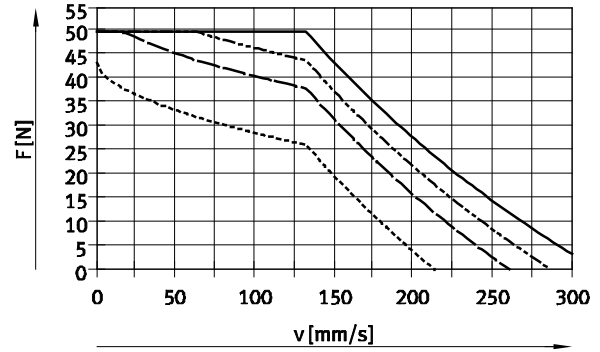

EPCO-25-3P

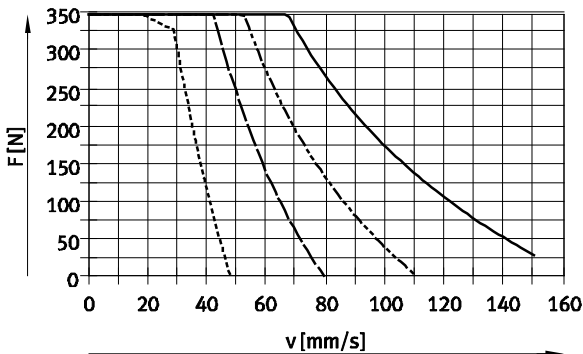

EPCO-25-10P

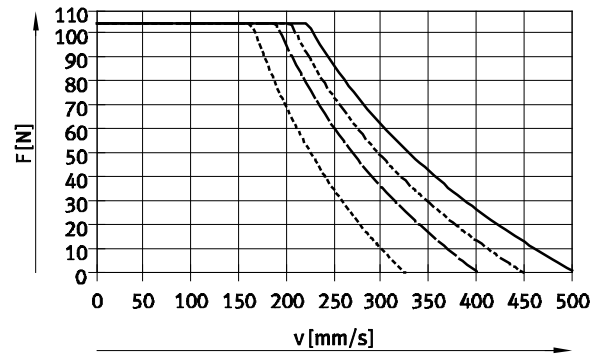

EPCO-40-5P

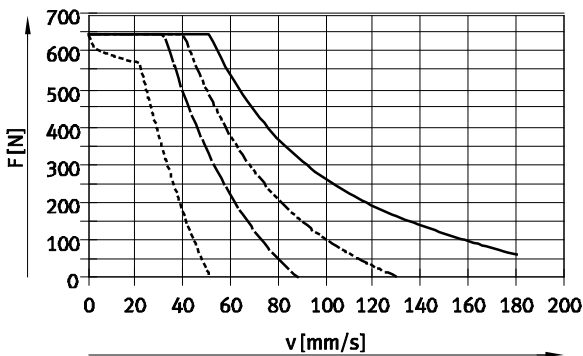

EPCO-40-12,7P

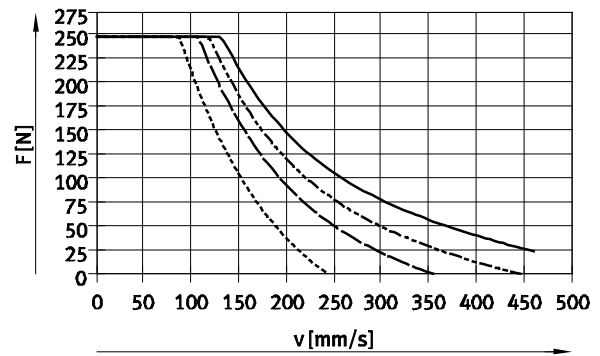

- a = 0 m/s<sup>2</sup>
- - - a = 2.5 m/s<sup>2</sup>
- · - a = 5 m/s<sup>2</sup>
- · · a = 10 m/s<sup>2</sup>

# Electric cylinders EPCO, with spindle drive

Technical data

## Calculating the mean feed force $F_{xm}$ with the electric cylinder EPCO

The peak feed force value must not exceed the maximum feed force within a movement cycle. The peak value is generally achieved in vertical

operation during the acceleration phase of the upwards stroke. If the maximum feed force is exceeded, this can increase wear and thus shorten

the service life of the ball screw spindle. The maximum speed must likewise not be exceeded.

$$F_x \leq F_{x\max}$$

and

$$v_x \leq v_{x\max}$$

### Mean feed force (to DIN 69 051-4)

During operation, the continuous feed force may be briefly exceeded up to the maximum feed force. The continu-

ous feed force must, however, be adhered to when averaged over a movement cycle.

$$F_{xm} \leq F_{\text{continuous}}$$

$$F_{xm} = \sqrt[3]{\sum F_x^3 \times \frac{v_x}{v_{xm}} \times \frac{q}{100}} =$$

$$F_{xm} = \sqrt[3]{F_{x1}^3 \times \frac{v_{x1}}{v_{xm}} \times \frac{q_1}{100} + F_{x2}^3 \times \frac{v_{x2}}{v_{xm}} \times \frac{q_2}{100} + F_{x3}^3 \times \frac{v_{x3}}{v_{xm}} \times \frac{q_3}{100} + \dots}$$

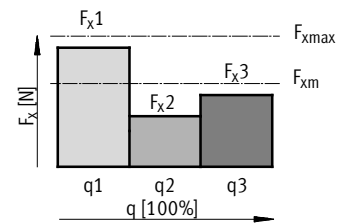

### Mean feed speed (to DIN 69 051-4)

$$v_{xm} = \sum v_x \times \frac{q}{100} = v_{x1} \times \frac{q_1}{100} + v_{x2} \times \frac{q_2}{100} + v_{x3} \times \frac{q_3}{100} + \dots$$

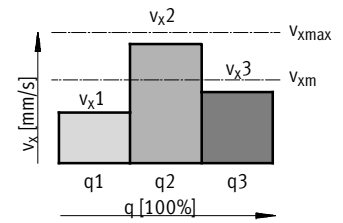

$F_x$	Feed force	$v_x$	Feed speed
$F_{xm}$	Mean feed force	$v_{xm}$	Mean feed speed
$F_{x\max}$	Max. feed force	$v_{x\max}$	Max. feed speed
$F_{x\text{continuous}}$	Continuous feed force		
$q$	Time		

# Electric cylinders EPCO, with spindle drive

Technical data

## Mean feed force F as a function of running performance L (to DIN 69 051-4)

EPCO-16

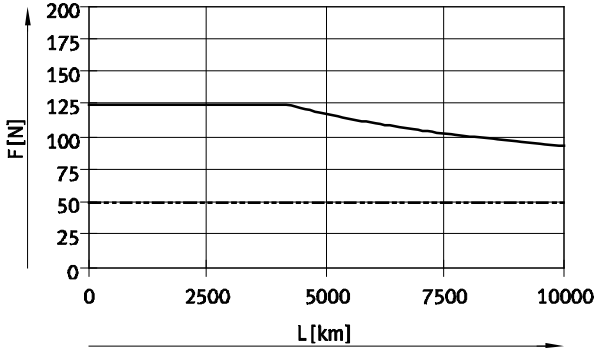

— EPCO-16-3P  
- - - EPCO-16-8P

EPCO-25

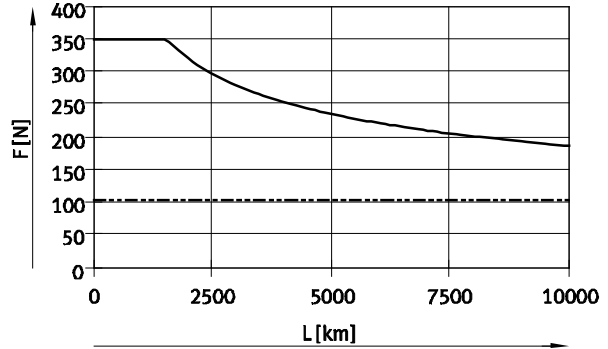

— EPCO-25-3P  
- - - EPCO-25-10P

EPCO-40

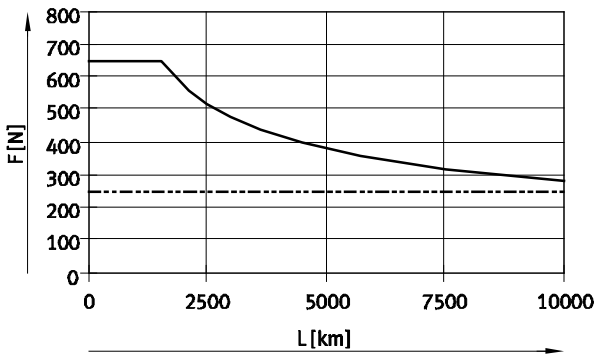

— EPCO-40-5P  
- - - EPCO-40-12,7P

 Note

- The specifications for running performance are based on experimentally determined and theoretically calculated data. The running performance attainable in practice can deviate considerably from the specified curves under different parameters.

## Pin allocation

Motor

EPCO-16

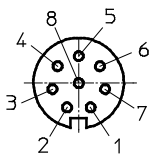

EPCO-25/-40

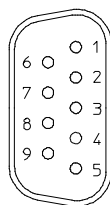

Encoder

EPCO-16/-25/-40

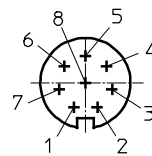

Pin	Function
1	String A
2	String A/
3	String B
4	String B/
5	n.c.
6	n.c.
7	Brake +24 V DC <sup>1)</sup>
8	Brake GND <sup>1)</sup>
-	-

Pin	Function
1	String A
2	String A/
3	String B
4	String B/
5	n.c.
6	n.c.
7	Brake +24 V DC <sup>1)</sup>
8	Brake GND <sup>1)</sup>
9	n.c.

Pin	Function
1	Signal trace A
2	Signal trace A/
3	Signal trace B
4	Signal trace B/
5	GND encoder
6	Signal trace N
7	Signal trace N/
8	VCC auxiliary supply +5 V
GND	Shield on plug housing

1) Only on motors with brake.



# Electric cylinders EPCO, with spindle drive

Technical data

FESTO

## Dimensions

Download CAD data → [www.festo.com](http://www.festo.com)

### Size 16

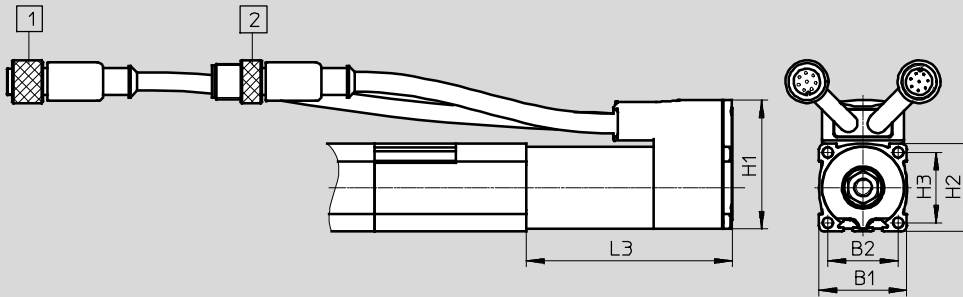

1 Motor connection:  
Round plug M12, 8-pin, socket  
cable length: 350 mm

2 Encoder connection:  
Round plug M12, 8-pin, pins  
cable length: 250 mm

### Size 25, 40

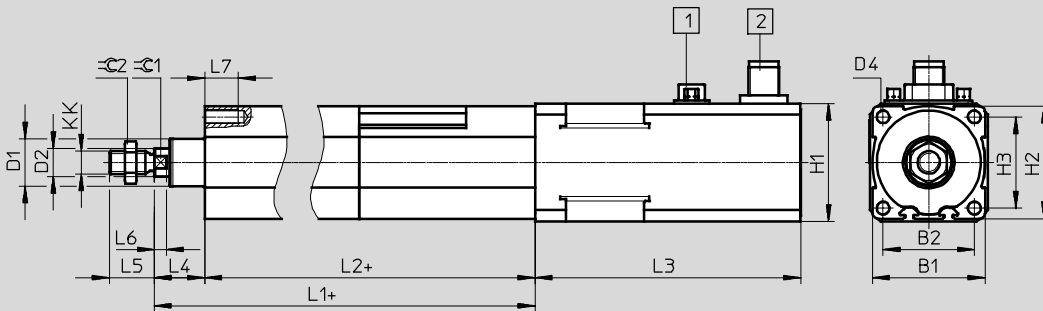

1 Motor connection:  
SUB-D plug, 9-pin, pins

2 Encoder connection:  
Round plug M12, 8-pin, pins

+ = plus stroke length

Size	B1	B2	D1 ∅ ±0.05	D4	H1	H2	H3	KK	L1	L2 ±1
16	30	24	13.27	M4	44	30	24	M6	143	127
25	40	32.5	17.27	M5	42 <sup>+0.3</sup>	40	32.5	M8	174.6	156.6
40	55	42	26.52	M6	56.4	55	42	M10x1.25	214.2	192.7

Size [mm]	L3				L4	L5 -0.5	L6 -0.15	L7	MM -0.1	⌀C1	⌀C2
	-E	-B	-EB								
16	70±1	70±1	96±1.5	96±1.5	16	12	3.7	10	8	7	10
25	66±1	94.4±1.2	114.4±1.3	127.4±1.3	18	16	4.2	12	10	9	13
40	73.5±0.8	102.5±1.1	123.5±1.1	138±1.1	21.5	19	4.7	14	12	10	17

# Electric cylinders EPCO, with spindle drive

Technical data

**Variants**

E – Extended piston rod

F – Female piston rod thread

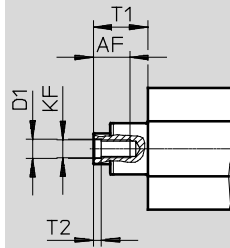
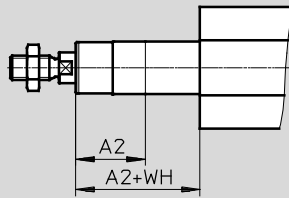

Size [mm]	A2 max.	AF	KF	T1	T2	D1	WH
16	100	10	M4	16	1.5	4.3	16
25	150	12	M6	18	2.6	6.4	18
40	200	14	M8	21.5	3.3	8.4	21.5

# Electric cylinders EPCO, with spindle drive

Technical data

**FESTO**

Ordering data – EPCO-16 (stock items)					
Stroke [mm]	Part No.	Type	Stroke [mm]	Part No.	Type
Spindle pitch 3 mm, with encoder			Spindle pitch 8 mm, with encoder		
50	1476415	EPCO-16-50-3P-ST-E	50	1476522	EPCO-16-50-8P-ST-E
100	1476417	EPCO-16-100-3P-ST-E	100	1476524	EPCO-16-100-8P-ST-E
150	1476419	EPCO-16-150-3P-ST-E	150	1476526	EPCO-16-150-8P-ST-E
200	1476421	EPCO-16-200-3P-ST-E	200	1476528	EPCO-16-200-8P-ST-E

Ordering data – EPCO-25 (stock items)					
Stroke [mm]	Part No.	Type	Stroke [mm]	Part No.	Type
Spindle pitch 3 mm, with encoder			Spindle pitch 10 mm, with encoder		
50	1470698	EPCO-25-50-3P-ST-E	50	1470769	EPCO-25-50-10P-ST-E
100	1470700	EPCO-25-100-3P-ST-E	100	1470771	EPCO-25-100-10P-ST-E
150	1470702	EPCO-25-150-3P-ST-E	150	1470773	EPCO-25-150-10P-ST-E
200	1470704	EPCO-25-200-3P-ST-E	200	1470775	EPCO-25-200-10P-ST-E
300	1470706	EPCO-25-300-3P-ST-E	300	1470777	EPCO-25-300-10P-ST-E

Ordering data – EPCO-40 (stock items)					
Stroke [mm]	Part No.	Type	Stroke [mm]	Part No.	Type
Spindle pitch 5 mm, with encoder			Spindle pitch 12.7 mm, with encoder		
50	1472501	EPCO-40-50-5P-ST-E	50	1472617	EPCO-40-50-12.7P-ST-E
100	1472503	EPCO-40-100-5P-ST-E	100	1472619	EPCO-40-100-12.7P-ST-E
150	1472505	EPCO-40-150-5P-ST-E	150	1472621	EPCO-40-150-12.7P-ST-E
200	1472507	EPCO-40-200-5P-ST-E	200	1472623	EPCO-40-200-12.7P-ST-E
300	1472509	EPCO-40-300-5P-ST-E	300	1472625	EPCO-40-300-12.7P-ST-E

 - Note  
 Variants ordered via modular product system → 20

 - Note  
 Position sensing is only possible in combination with feature "A" (position sensing) → 20 (modular product system)

# Electric cylinders EPCO, with spindle drive

Ordering data – Modular products

Ordering table							
Size	16	25	40	Condi- tions	Code	Enter code	
<b>M</b> Module No.	<b>1476585</b>	<b>1470874</b>	<b>1472887</b>				
Function	Electric cylinder				<b>EPCO</b>	EPCO	
Size	16	25	40		-...		
Stroke [mm]	50				-...		
	75						
	100						
	125						
	150						
	175						
	200						
	-		250				
	-		300				
	-			350			
-			400				
Spindle pitch [mm]	3	3			-...P		
	-			5			
	8						
	-		10				
	-			12.7			
<b>O</b> Piston rod thread type	Male thread						
	Female thread				<b>-F</b>		
Piston rod extension [mm]	None						
	1 ... 100	1 ... 150	1 ... 200		<b>-...E</b>		
Position sensing	None						
	Via proximity sensor			<b>1</b>	<b>-A</b>		
<b>M</b> Motor type	Stepper motor				<b>-ST</b>	ST	

**1** A Must be selected if encoder E is not selected.

Transfer order code

# Electric cylinders EPCO, with spindle drive

Ordering data – Modular products

Ordering table						
Size	16	25	40	Condi- tions	Code	Enter code
0 Measuring unit	None					
	Encoder				-E	
Brake	None					
	Brake				B	
Cable outlet direction	Standard					
	Underneath				-D	
	Left				-L	
	Right				-R	
Connecting cable to motor controller, suitable for use with energy chains	1.5 m, straight plug			2	+1.5E	
	1.5 m, angled plug			2	+1.5EA	
	2.5 m, straight plug			2	+2.5E	
	2.5 m, angled plug			2	+2.5EA	
	5 m, straight plug			2	+5E	
	5 m, angled plug			2	+5EA	
	7 m, straight plug			2	+7E	
	7 m, angled plug			2	+7EA	
	10 m, straight plug			2	+10E	
	10 m, angled plug			2	+10EA	
Controller type	None					
	CMMO, 5 A			2	+C5	
Bus protocol/activation	None					
	Digital I/O interface			3	DIO	
Switching input/output	NPN			3	N	
	PNP			3	P	

2 1.5E, 1.5EA, 2.5E, 2.5EA, 5E, 5EA, 7E, 7EA, 10E, 10EA, C5 Only with encoder E.

3 DIO, N, P Only in conjunction with CMMO, 5 A (controller type).

Transfer order code

-  -  +  +

# Electric cylinders EPCO, with spindle drive

Accessories

## Foot mounting EAHF

Material:

Galvanised steel

RoHS-compliant

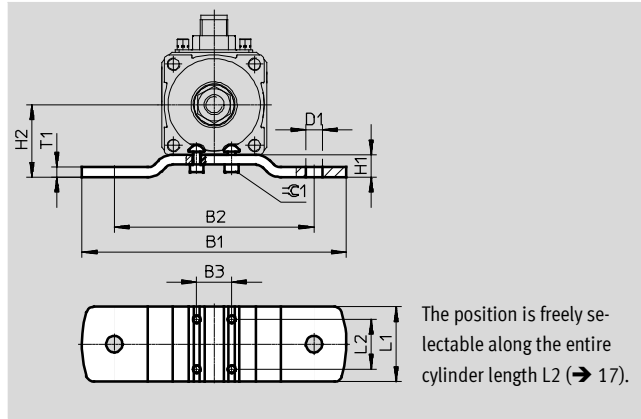

Dimensions and ordering data							
For size	B1	B2	B3	D1 Ø	H1	H2	L1
[mm]							
16	86	60	10	5.5	7	22	30
25	106	80	14	6.6	9	29	30
40	130	100	18	9	10.5	38	40

For size	L2	T1	≈G1	CRC <sup>1)</sup>	Weight	Part No.	Type
[mm]					[g]		
16	20	3	2.5	1	60	<b>1434903</b>	<b>EAHF-P1-16</b>
25	20	4	2.5	1	100	<b>1434904</b>	<b>EAHF-P1-25</b>
40	20	4	4	1	160	<b>1434905</b>	<b>EAHF-P1-40</b>

1) Corrosion resistance class 1 according to Festo standard 940 070. Components subject to low corrosion stress. Transport and storage protection. Parts that do not have primarily decorative surface requirements, e.g. in internal areas that are not visible or behind covers.

# Electric cylinders EPCO, with spindle drive

Accessories

**FESTO**

## Flange mounting EAHH

Material:

Galvanised steel

RoHS-compliant

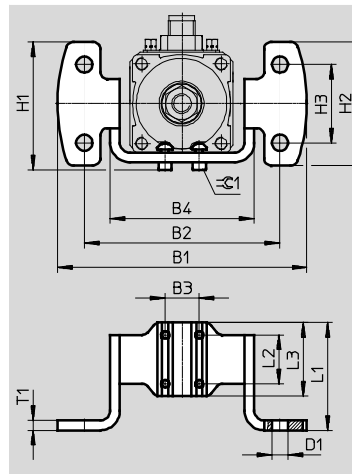

The position is freely selectable along the entire cylinder length L2 (→ 17).

Dimensions and ordering data									
For size	B1	B2	B3	B4	D1 ∅	H1	H2	H3	L1
[mm]									
16	77.2	60	10	45	5.5	38.3	34.6	20	43
25	102	80	14	59	6.6	52.3	50.6	32	44
40	119	100	18	76	9	64.5	56	36	54

For size	L2	L3	T1	$\varnothing 1$	CRC <sup>1)</sup>	Weight	Part No.	Type
[mm]						[g]		
16	20	30	3	2.5	1	80	<b>1434906</b>	<b>EAHH-P1-16</b>
25	20	30	4	2.5	1	150	<b>1434907</b>	<b>EAHH-P1-25</b>
40	20	40	4	4	1	240	<b>1434908</b>	<b>EAHH-P1-40</b>

1) Corrosion resistance class 1 according to Festo standard 940 070.  
Components subject to low corrosion stress. Transport and storage protection. Parts that do not have primarily decorative surface requirements, e.g. in internal areas that are not visible or behind covers.

# Electric cylinders EPCO, with spindle drive

Accessories

## Swivel mounting EAHS

Material:

Galvanised steel

RoHS-compliant

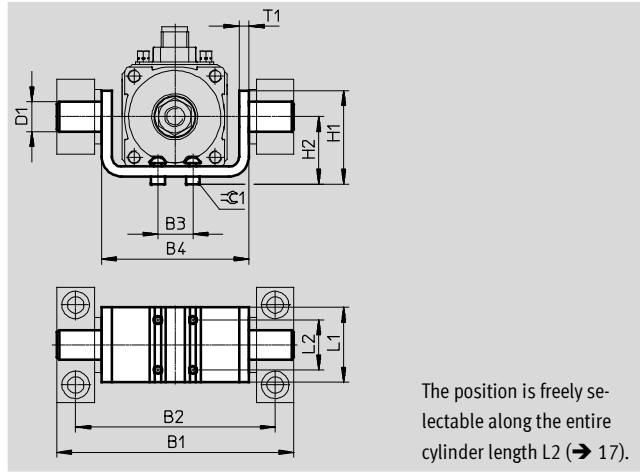

The position is freely selectable along the entire cylinder length L2 (→ 17).

Dimensions and ordering data							
For size	B1	B2	B3	B4	D1	H1	H2
[mm]					∅ e9		
16	71	60	10	45	8	33	21
25	95	80	14	59	12	37.5	27
40	118	100	18	76	16	55	36.5

For size	L1	L2	T1	≈C1	CRC <sup>1)</sup>	Weight	Part No.	Type
[mm]						[g]		
16	30	20	3	2.5	1	80	<b>1434909</b>	<b>EAHS-P1-16</b>
25	30	20	4	2.5	1	140	<b>1434910</b>	<b>EAHS-P1-25</b>
40	40	20	4	4	1	260	<b>1434911</b>	<b>EAHS-P1-40</b>

1) Corrosion resistance class 1 according to Festo standard 940 070. Components subject to low corrosion stress. Transport and storage protection. Parts that do not have primarily decorative surface requirements, e.g. in internal areas that are not visible or behind covers.



# Electric cylinders EPCO, with spindle drive

Accessories

**FESTO**

## Adapter kit EAHA

Material:

Galvanised steel

RoHS-compliant

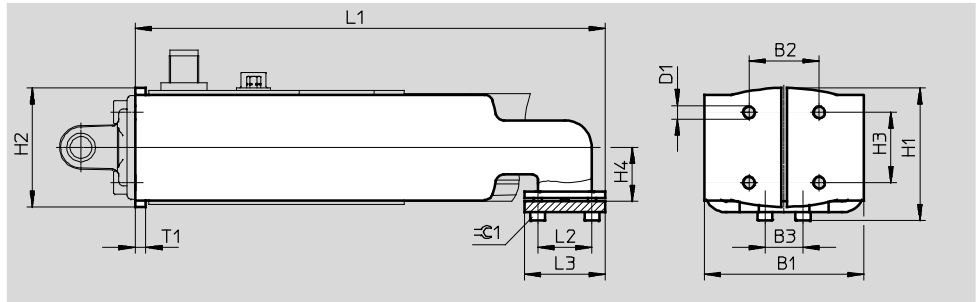

Dimensions and ordering data								
For size	B1	B2	B3	D1	H1	H2	H3	H4
[mm]								
16	45	18	10	M4	35.9	29.8	18	15
25	59	26	14	M5	49	44	26	20
40	76	38	18	M6	66.9	60.8	38	27.5

For size	L1	L2	L3	T1	≈C1	CRC <sup>1)</sup>	Weight	Part No.	Type
[mm]							[g]		
16	139	20	30	3	2.5	1	210	<b>1434900</b>	<b>EAHA-P1-16</b>
25	174	20	30	4	2.5	1	480	<b>1434901</b>	<b>EAHA-P1-25</b>
40	193.4	20	40	4	4	1	770	<b>1434902</b>	<b>EAHA-P1-40</b>

1) Corrosion resistance class 1 according to Festo standard 940 070.  
 Components subject to low corrosion stress. Transport and storage protection. Parts that do not have primarily decorative surface requirements, e.g. in internal areas that are not visible or behind covers.

# Electric cylinders EPCO, with spindle drive

Accessories



## Trunnion flange ZNCF

Material:  
ZNCF: Stainless steel casting

Free of copper and PTFE  
RoHS-compliant

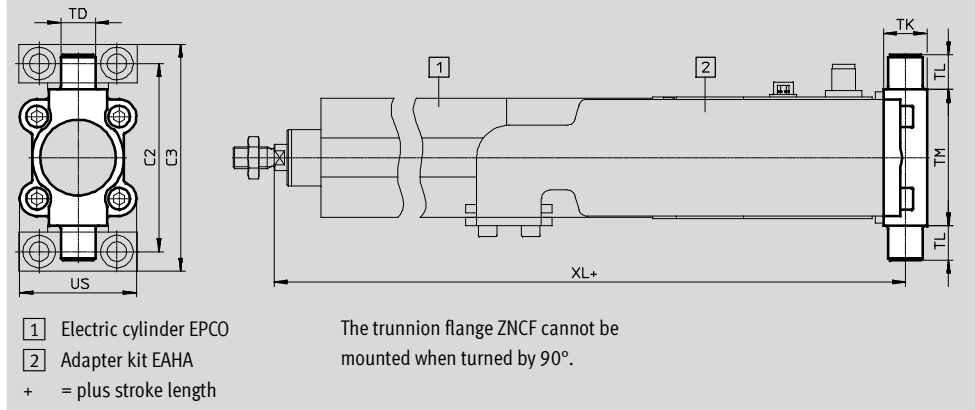

Dimensions and ordering data														
For size	C2	C3	TD	TK	TL	TM	US	XL			CRC <sup>1)</sup>	Weight	Part No.	Type
[mm]			∅ e9					-E	-B	-EB		[g]		
40	87	105	16	20	16	63	54	306.7	335.7	356.7	371.2	2	285	174412 ZNCF-40

1) Corrosion resistance class 2 according to Festo standard 940 070  
Components subject to moderate corrosion stress. Externally visible parts with primarily decorative surface requirements which are in direct contact with a normal industrial environment or media such as coolants or lubricating agents.

## Trunnion support LNZG

Material:  
Trunnion support: Anodised aluminium  
Plain bearing: Plastic  
Free of copper and PTFE  
RoHS-compliant

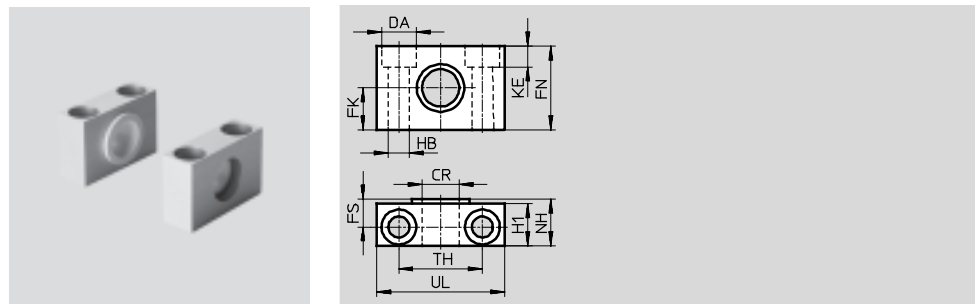

Dimensions and ordering data															
For size	CR	DA	FK	FN	FS	H1	HB	KE	NH	TH	UL	CRC <sup>1)</sup>	Weight	Part No.	Type
[mm]	∅ D11	∅ H13	∅ ±0.1				∅ H13			±0.2			[g]		
16	8	8	10	20	7.5	11	4.5	4.6	13	20	30	2	26	1434912 LNZG-16	
25	12	11	15	30	10.5	15	6.6	6.8	18	32	46	2	83	32959 LNZG-32	
40	16	15	18	36	12	18	9	9	21	36	55	2	129	32960 LNZG-40/50	

1) Corrosion resistance class 2 according to Festo standard 940 070  
Components subject to moderate corrosion stress. Externally visible parts with primarily decorative surface requirements which are in direct contact with a normal industrial environment or media such as coolants or lubricating agents.

# Electric cylinders EPCO, with spindle drive

Accessories

**FESTO**

## Swivel flange SNCS

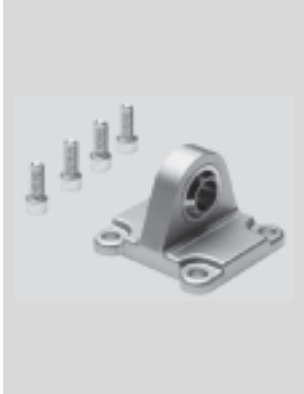

Material:  
Die-cast aluminium

Free of copper and PTFE  
RoHS-compliant

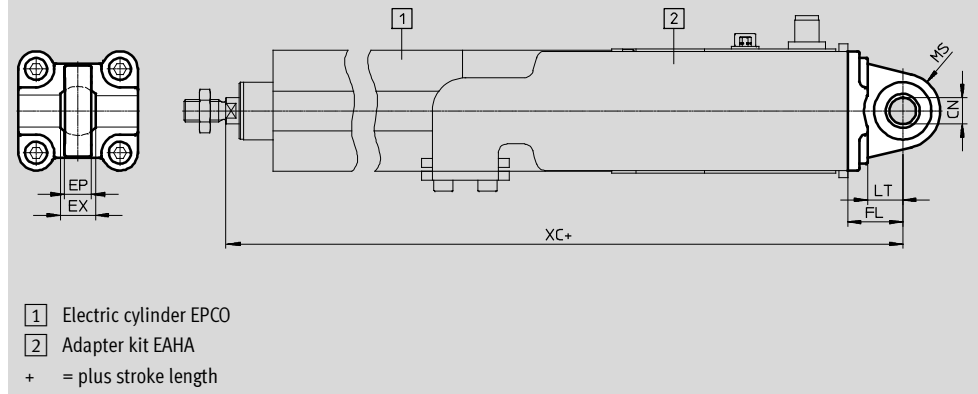

Dimensions and ordering data														
For size	CN	EP	EX	FL	LT	MS	XC				CRC <sup>1)</sup>	Weight	Part No.	Type
[mm]	∅	+0.2		±0.2			-E	-B	-EB		[g]			
40	12	12	16	25	16	17	321.7	350.7	371.7	386.2	2	125	<b>174398</b>	<b>SNCS-40</b>

1) Corrosion resistance class 2 according to Festo standard 940 070  
Components subject to moderate corrosion stress. Externally visible parts with primarily decorative surface requirements which are in direct contact with a normal industrial environment or media such as coolants or lubricating agents.

## Swivel flange SNCL



Material:  
Wrought aluminium alloy

Free of copper and PTFE  
RoHS-compliant

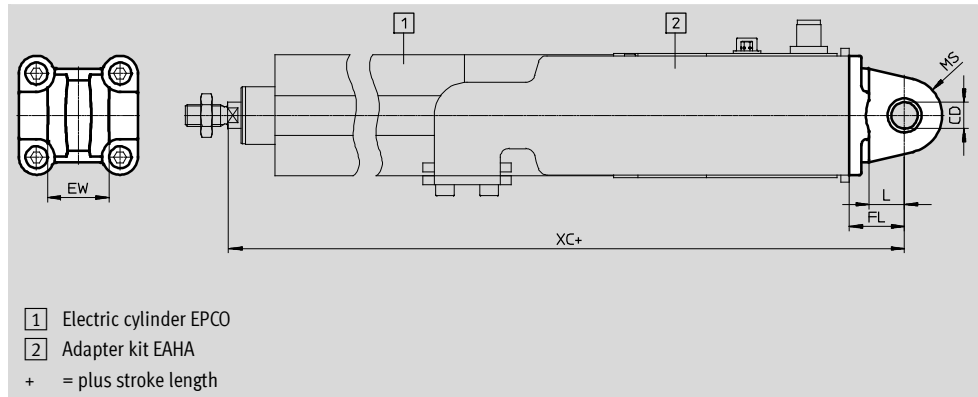

Dimensions and ordering data													
For size	CD	EW	FL	L	MR	XC				CRC <sup>1)</sup>	Weight	Part No.	Type
[mm]	∅	h12	±0.2		-0.5	-E	-B	-EB			[g]		
16	6	12	16	10	6	237	237	263	263	2	25	<b>537791</b>	<b>SNCL-16</b>
25	8	16	20	14	8	269.6	298	318	331	2	45	<b>537793</b>	<b>SNCL-25</b>
40	12	28	25	16	12	321.7	350.7	371.7	386.2	2	100	<b>174405</b>	<b>SNCL-40</b>

1) Corrosion resistance class 2 according to Festo standard 940 070  
Components subject to moderate corrosion stress. Externally visible parts with primarily decorative surface requirements which are in direct contact with a normal industrial environment or media such as coolants or lubricating agents.

# Electric cylinders EPCO, with spindle drive

Accessories

## Swivel flange SNCB

Material:  
Die-cast aluminium

Free of copper and PTFE  
RoHS-compliant

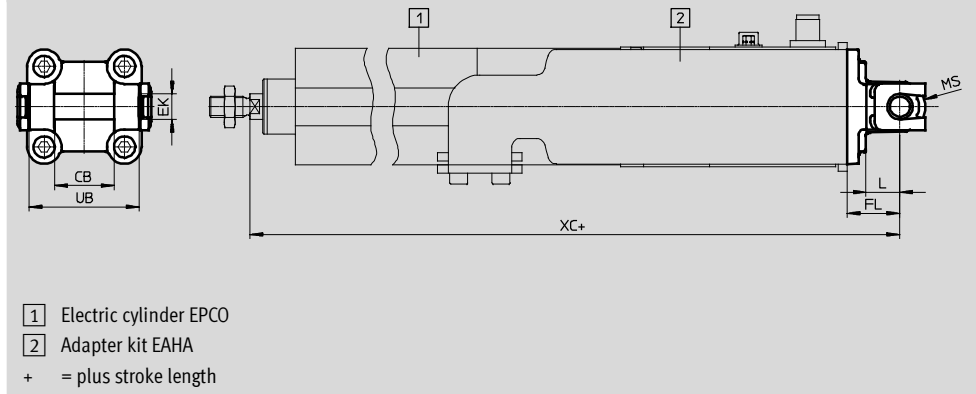

### Dimensions and ordering data

For size	CB	EK	FL	L	MR	UB	XC				CRC <sup>1)</sup>	Weight	Part No.	Type
[mm]	H14	∅ e8	±0.2			h14		-E	-B	-EB		[g]		
40	28	12	25	16	12	52	321.7	350.7	371.7	386.2	2	155	<b>174391</b>	<b>SNCB-40</b>

1) Corrosion resistance class 2 according to Festo standard 940 070

Components subject to moderate corrosion stress. Externally visible parts with primarily decorative surface requirements which are in direct contact with a normal industrial environment or media such as coolants or lubricating agents.

### Ordering data – Mounting attachments



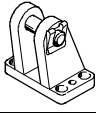
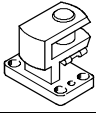
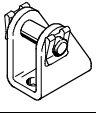

Technical data → Internet: clevis foot

Designation	For size	Part No.	Type	Designation	For size	Part No.	Type
<b>Clevis foot LBG</b>				<b>Right-angle clevis foot LQG</b>			
	40	<b>31762</b>	<b>LBG-40</b>		40	<b>31769</b>	<b>LQG-40</b>
<b>Clevis foot LBN</b>							
	16	<b>6058</b>	<b>LBN-12/16</b>				
	25	<b>6059</b>	<b>LBN-20/25</b>				
	40	<b>195861</b>	<b>LBN-40</b>				



# Electric cylinders EPCO, with spindle drive

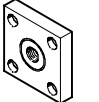

Accessories

**FESTO**

Ordering data – Piston rod attachments				Technical data → Internet: piston rod attachment			
Designation	For size	Part No.	Type	Designation	For size	Part No.	Type
<b>Rod eye SGS</b>				<b>Rod clevis SG</b>			
	16	9254	SGS-M6		16	3110	SG-M6
	25	9255	SGS-M8		25	3111	SG-M8
	40	9261	SGS-M10x1,25		40	6144	SG-M10x1,25
<b>Self-aligning rod coupler FK</b>							
	16	2061	FK-M6				
	25	2062	FK-M8				
	40	6140	FK-M10x1,25				
<b>Coupling piece KSG</b>				<b>Rod clevis SGA</b>			
	40	32963	KSG-M10x1,25		40	32954	SGA-M10x1,25

 **Note**  
 Position sensing is only possible in combination with feature "A" (position sensing) → 20 (modular product system)

Ordering data – Proximity sensors for T-slot, magneto-resistive					Technical data → Internet: smt	
	Type of mounting	Switch output	Electrical connection	Cable length [m]	Part No.	Type
<b>N/O contact</b>						
	Insertable in the slot from above, flush with cylinder profile, short design	PNP	Cable, 3-wire	2.5	574335	SMT-8M-A-PS-24V-E-2,5-OE
			Plug M8x1, 3-pin	0.3	574334	SMT-8M-A-PS-24V-E-0,3-M8D
			Plug M12x1, 3-pin	0.3	574337	SMT-8M-A-PS-24V-E-0,3-M12
		NPN	Cable, 3-wire	2.5	574338	SMT-8M-A-NS-24V-E-2,5-OE
Plug M8x1, 3-pin	0.3		574339	SMT-8M-A-NS-24V-E-0,3-M8D		
<b>N/C contact</b>						
	Insertable in the slot from above, flush with cylinder profile, short design	PNP	Cable, 3-wire	7.5	574340	SMT-8M-A-PO-24V-E-7,5-OE

Ordering data – Proximity sensor for T-slot, magnetic reed					Technical data → Internet: sme	
	Type of mounting	Switching output	Electrical connection	Cable length [m]	Part No.	Type
<b>N/O contact</b>						
	Insertable in the slot from above, flush with the cylinder profile	Contacting	Cable, 3-wire	2.5	543862	SME-8M-DS-24V-K-2,5-OE
				5.0	543863	SME-8M-DS-24V-K-5,0-OE
			Cable, 2-wire	2.5	543872	SME-8M-ZS-24V-K-2,5-OE
			Plug M8x1, 3-pin	0.3	543861	SME-8M-DS-24V-K-0,3-M8D
	Insertable in the slot lengthwise, flush with the cylinder profile	Contacting	Cable, 3-wire	2.5	150855	SME-8-K-LED-24
			Plug M8x1, 3-pin	0.3	150857	SME-8-S-LED-24
<b>N/C contact</b>						
	Insertable in the slot lengthwise, flush with the cylinder profile	Contacting	Cable, 3-wire	7.5	160251	SME-8-O-K-LED-24

# Electric cylinders EPCO, with spindle drive

Accessories

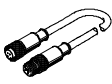
Ordering data – Connecting cable				Technical data → Internet: km8	
	Mounting	Connection	Cable length [m]	Part No.	Type
<b>Straight socket</b>					
	Union nut M8, both ends	3-pin	0.5	<b>175488</b>	<b>KM8-M8-GSGD-0,5</b>
			1	<b>175489</b>	<b>KM8-M8-GSGD-1</b>
			2.5	<b>165610</b>	<b>KM8-M8-GSGD-2,5</b>
			5	<b>165611</b>	<b>KM8-M8-GSGD-5</b>

## Sensor mounting



The sensor mountings can only be attached within the highlighted area due to the asymmetry of the internal magnets.

The proximity sensors may not switch reliably if they are mounted outside of this area.

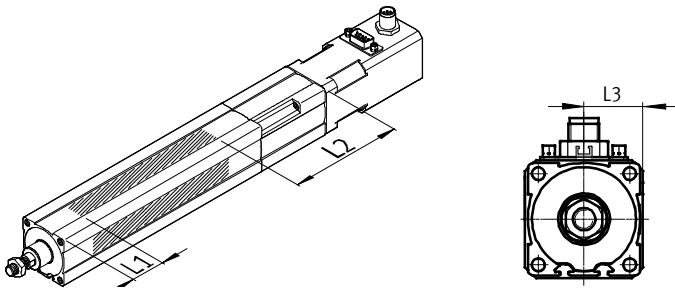
The overall length of the sensor rail SAMH corresponds to the length of the sensing range plus approx. 10 mm adjustment range on either side for the proximity sensors.



Size	L1	L2	L3
16	29	95	15
25	33	121	20
40	40	150	27.5

Ordering data – Sensor mounting for T-slot				
	Brief description	Length [mm]	Part No.	Type
<b>Sensor rail<sup>1)</sup></b>				
	For size 16, 25, 40	50	<b>160093</b>	<b>SAMH-N8-SR-50</b>
		100	<b>160018</b>	<b>SAMH-N8-SR-100</b>
<b>Mounting kit</b>				
	For size 16, 25, 40	35	<b>525565</b>	<b>CRSMB-8-32/100</b>

 Note

1) Size 25 can only be used with proximity sensor SMT-8 (magneto-resistive).

# Electric cylinders EPCO, with spindle drive

Accessories

**FESTO**

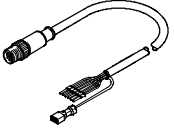
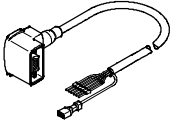
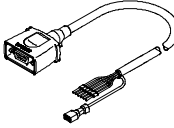
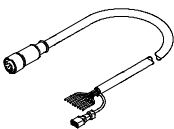
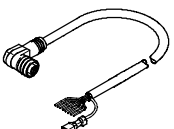
Ordering data – Cables <sup>1)</sup>					
	For type	Description	Cable length [m]	Part No.	Type
<b>Motor cable</b>					
	EPCO-16	<b>Straight plug</b>			
		– Min. bending radius: 62 mm	1.5	<b>1449600</b>	<b>NEBM-M12G8-E-1.5-Q5-LE6</b>
		– Suitable for use with energy chains	2.5	<b>1449601</b>	<b>NEBM-M12G8-E-2.5-Q5-LE6</b>
		– Ambient temp.: –40 ... +80 °C	5	<b>1449602</b>	<b>NEBM-M12G8-E-5-Q5-LE6</b>
			7	<b>1449603</b>	<b>NEBM-M12G8-E-7-Q5-LE6</b>
	10	<b>1449604</b>	<b>NEBM-M12G8-E-10-Q5-LE6</b>		
	EPCO-25/-40	<b>Angled plug</b>			
		– Min. bending radius: 62 mm	1.5	<b>1450736</b>	<b>NEBM-S1W9-E-1.5-Q5-LE6</b>
		– Suitable for use with energy chains	2.5	<b>1450737</b>	<b>NEBM-S1W9-E-2.5-Q5-LE6</b>
		– Ambient temp.: –40 ... +80 °C	5	<b>1450738</b>	<b>NEBM-S1W9-E-5-Q5-LE6</b>
			7	<b>1450739</b>	<b>NEBM-S1W9-E-7-Q5-LE6</b>
	10	<b>1450740</b>	<b>NEBM-S1W9-E-10-Q5-LE6</b>		
		<b>Straight plug</b>			
		– Min. bending radius: 62 mm	1.5	<b>1450368</b>	<b>NEBM-S1G9-E-1.5-Q5-LE6</b>
		– Suitable for use with energy chains	2.5	<b>1450369</b>	<b>NEBM-S1G9-E-2.5-Q5-LE6</b>
		– Ambient temp.: –40 ... +80 °C	5	<b>1450370</b>	<b>NEBM-S1G9-E-5-Q5-LE6</b>
			7	<b>1450371</b>	<b>NEBM-S1G9-E-7-Q5-LE6</b>
	10	<b>1450372</b>	<b>NEBM-S1G9-E-10-Q5-LE6</b>		
<b>Encoder cable</b>					
	EPCO-16/-25/-40	<b>Straight plug</b>			
		– Min. bending radius: 68 mm	1.5	<b>1451586</b>	<b>NEBM-M12G8-E-1.5-LE8</b>
		– Suitable for use with energy chains	2.5	<b>1451587</b>	<b>NEBM-M12G8-E-2.5-LE8</b>
		– Ambient temp.: –40 ... +80 °C	5	<b>1451588</b>	<b>NEBM-M12G8-E-5-LE8</b>
			7	<b>1451589</b>	<b>NEBM-M12G8-E-7-LE8</b>
	10	<b>1451590</b>	<b>NEBM-M12G8-E-10-LE8</b>		
	EPCO-25/-40	<b>Angled plug</b>			
		– Min. bending radius: 68 mm	1.5	<b>1451674</b>	<b>NEBM-M12W8-E-1.5-LE8</b>
		– Suitable for use with energy chains	2.5	<b>1451675</b>	<b>NEBM-M12W8-E-2.5-LE8</b>
		– Ambient temp.: –40 ... +80 °C	5	<b>1451676</b>	<b>NEBM-M12W8-E-5-LE8</b>
			7	<b>1451677</b>	<b>NEBM-M12W8-E-7-LE8</b>
	10	<b>1451678</b>	<b>NEBM-M12W8-E-10-LE8</b>		

1) Other cable lengths on request.