

Rotary lifting modules EHMB, electric



# Rotary lifting modules EHMB, electric

Key features

## At a glance

The rotary lifting module EHMB combines rotary and linear movement in one compact unit. The rotary movement is transmitted to a hollow shaft via a toothed belt driven by an electric motor while the linear movement is generated either by means of

a pneumatic cylinder DNC or an electric cylinder DNCE. Both movements act on the output flange, which is compatible with the semi-rotary drive DRQD, so that numerous grippers can be used.

Cables and tubing can be easily

routed to the front end of the rotary lifting module through the large hollow shaft.

The movement range can also be sensed via proximity sensors at the rotary unit and the cylinder.

Advantages:

- Large hollow shaft
- Stable bearing arrangement
- Various motors and cylinders enable easy adaptation of the performance to the application

## The technology in detail

- 1 Stop nut
- 2 Grooved-shaft guide
- 3 Through-hole for mounting
- 4 Mounting thread/holes
- 5 Output flange with centring and threaded holes for effective load. The interface corresponds to that of the pneumatic semi-rotary drive DRQD
- 6 Drive shaft for rotary movement
- 7 Cylinder retainer
- 8 Rod eye and connection bolt for linear movement

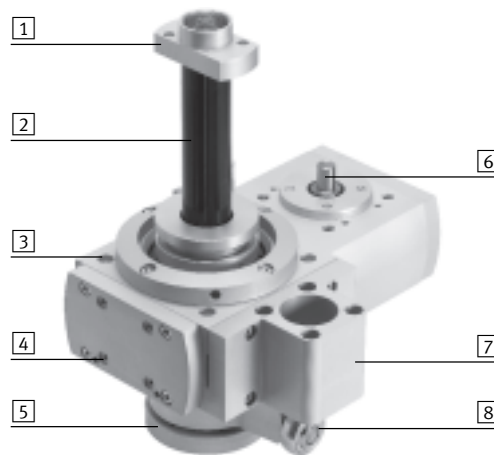

## Flexible connection

Orientation:

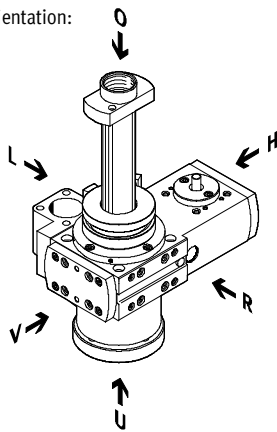

- O= top  
 U= underneath  
 R= right  
 V= front  
 L= left  
 H= rear

- The rotary lifting module EHMB can be mounted on four sides:
  - On the right or left of the housing (L, R)
  - On the front cover (V)
  - Underneath the housing (U)
- The cylinder retainer can be mounted on three sides:
  - On the right or left of the housing (L, R)
  - On the front, after removing the front cover (V)
- The side where the cylinder retainer is mounted cannot be used for mounting the rotary lifting module.
- A pneumatic standard cylinder DNC or an electric cylinder DNCE can be attached to the cylinder retainer (these cylinders must be ordered separately).

-  - Note

Eccentric loads can destroy the bearing.  
 The front side (V) is only permissible for mounting with a symmetrical applied load.

# Rotary lifting modules EHMB, electric

Key features

## Complete system consisting of rotary lifting module, motor and axial kit

Rotary lifting module

→ 6

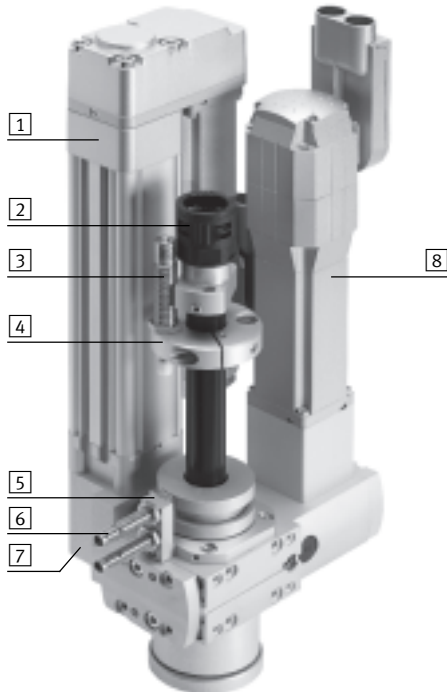

- 1) Electric cylinder DNCE or standard cylinder DNC<sup>1)</sup>
- 2) Protective conduit fitting<sup>1)</sup>
- 3) Shock absorber<sup>1)</sup>
- 4) Shock absorber retainer<sup>1)</sup>
- 5) Sensor retainer
- 6) Proximity sensor SIEN<sup>1)</sup>
- 7) Cylinder retainer
- 8) Motor for rotary movement<sup>1)</sup>

1) These parts must be ordered separately as accessories.

## Motors

→ 16

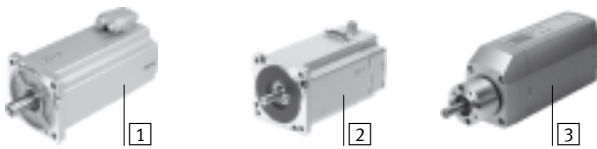

- 1) Servo motor EMME-AS, EMMS-AS
- 2) Stepper motor EMMS-ST
- 3) Motor unit MTR-DCI

- - Note

A range of specially matched complete solutions is available for the rotary lifting module EHMB and motors.

## Motor controllers

Technical data → Internet: motor controller

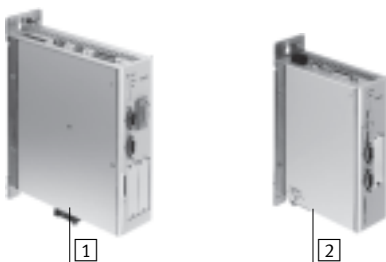

- 1) Servo motor controller CMMP-AS, CMMS-AS
- 2) Stepper motor controller CMMS-ST

## Motor mounting kit

→ 16

Axial kit

Parallel kit



A range of complete kits is available for both parallel and axial motor mounting.

# Rotary lifting modules EHMB, electric

Peripherals overview

FESTO

## Overview of peripherals

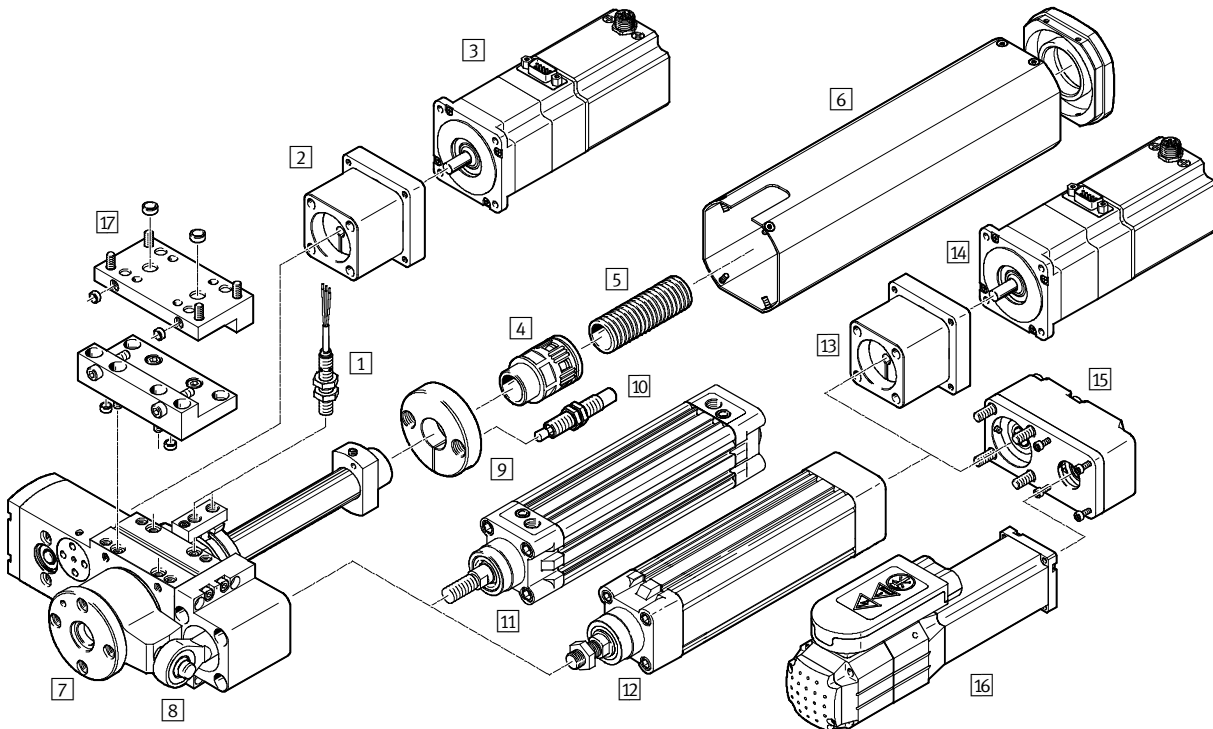

Accessory		
Type	Brief description	→ Page/Internet
1 Proximity sensor SIEN	<ul style="list-style-type: none"> <li>For use as a proximity signal or safety monitor</li> <li>The retainer for the proximity sensor SIEN is included in the scope of delivery of the rotary lifting module</li> <li>Two cams → 24, for sensing positions, are included in the scope of delivery</li> </ul>	24
2 Axial kit EAMM-A	<ul style="list-style-type: none"> <li>For the rotary movement of the rotary lifting module</li> <li>For axial motor mounting</li> <li>(consisting of: coupling, coupling housing and motor flange)</li> </ul>	20
3 Motor EMMS, MTR-DCI	<ul style="list-style-type: none"> <li>For the rotary movement of the rotary lifting module</li> <li>Motors specially matched to the axis, with or without brake</li> <li>The motor can be mounted turned by 90° depending on the requirement. This means the connection side can be freely selected</li> </ul>	20
4 Protective conduit fitting EASA	For mounting the protective conduit	24
5 Protective conduit MKR	For protecting electrical cables and compressed air tubing	24
6 Cover EASC	For protection against accidental contact with the grooved-shaft guide and trip cams	23
7 Rotary lifting module EHMB	Combination of linear and rotary drive	6
8 Rod eye SGS	<ul style="list-style-type: none"> <li>Connecting piece between rotary lifting module and standard/electric cylinder</li> <li>Included in the scope of delivery of the rotary lifting module</li> </ul>	23
9 Shock absorber retainer EAYH	Retainer for the shock absorber DYSW	23

# Rotary lifting modules EHMB, electric

Peripherals overview and type codes

Accessory			
Type		Brief description	→ Page/Internet
10	Shock absorber DYSW	Hydraulic shock absorber with path-controlled flow control function	23
11	Standard cylinder DNC	Pneumatic drive for the linear movement of the rotary lifting module	16
12	Electric cylinder DNCE	Electric drive for the linear movement of the rotary lifting module	16
13	Axial kit EAMM-A	<ul style="list-style-type: none"> <li>For the linear movement of the rotary lifting module</li> <li>For axial motor mounting</li> <li>Alternative parallel kit 15</li> <li>(consisting of: coupling, coupling housing and motor flange)</li> </ul>	17
14	Motor EMMS, MTR-DCI	<ul style="list-style-type: none"> <li>For the linear movement of the rotary lifting module</li> <li>Motors specially matched to the axis, with or without brake</li> <li>The motor can be mounted turned by 90° depending on the requirement. This means the connection side can be freely selected</li> </ul>	17
15	Parallel kit EAMM-U	<ul style="list-style-type: none"> <li>For the linear movement of the rotary lifting module</li> <li>For parallel motor mounting</li> <li>Alternative axial kit 13</li> <li>(consisting of: housing, clamping component, clamping sleeve, toothed belt pulley, toothed belt)</li> </ul>	18
16	Motor EMMS, MTR-DCI	<ul style="list-style-type: none"> <li>For the linear movement of the rotary lifting module</li> <li>Motors specially matched to the axis, with or without brake</li> <li>The motor can be mounted turned by 90° depending on the requirement. This means the connection side can be freely selected</li> </ul>	18
17	Adapter plate kit EHAM	<ul style="list-style-type: none"> <li>For attachment to the axes EGC and DGC</li> <li>Screws and centring sleeves are included in the scope of delivery of the adapter plate kit</li> </ul>	23

 Note

When installing electric cables or compressed air tubing through the hollow shaft of the grooved-shaft guide, the rotation angle of the EHMB must be limited to a value that is dependent on the cables or compressed air tubing. Endless rotation damages cables and tubing.

Type codes	
	EHMB – 25 – 100
<b>Type</b>	
EHMB	Rotary lifting module
<b>Size</b>	
<b>Stroke</b>	

# Rotary lifting modules EHMB, electric

Technical data

FESTO

Size  
20, 25, 32

Note  
All values are based on a room temperature of 23 °C.

www.festo.com



General technical data				
Size		20	25	32
Design		Electromechanical rotary lifting module with toothed belt		
Drive shaft $\varnothing$	[mm]	6	8	12
Rotation angle		Endless (→ 5)		
Stroke, linear	[mm]	100, 200		
Repetition accuracy, rotary <sup>1)</sup>				
With servo motor EMMS-AS	[°]	±0.03		
With stepper motor EMMS-ST <sup>2)</sup>	[°]	±0.08		
With motor unit MTR-DCI	[°]	±0.05		
Repetition accuracy, linear <sup>1)</sup>	[mm]	±0.02		
Max. speed, linear				
With standard cylinder DNC	[m/s]	→ 10		
With electric cylinder DNCE	[m/s]	0.5		0.64
Positioning times, rotary		→ 11		
Transmission ratio		4.5:1	4:1	3:1
Position sensing		Via proximity sensor		
Mounting position		Any		

- 1) As per FN 942 027, with electric cylinder DNCE  
2) Dependent on the encoder solution

Mechanical data				
Size		20	25	32
Max. driving torque	[Nm]	0.7	2.2	6.7
Max. output torque <sup>1)</sup>	[Nm]	3.15	8.8	20
No-load driving torque <sup>2)</sup>	[Nm]	< 0.07	< 0.18	< 0.5
Max. input speed	[rpm]	1,350	1,200	900
Max. output speed	[rpm]	300	300	300
Max. effective load, horizontal	[kg]	3	5	8
Max. effective load, vertical	[kg]	3	5	15 <sup>3)</sup>
Max. mass moment of inertia <sup>4)</sup>				
With servo motor EMMS-AS	[kgcm <sup>2</sup> ]	50	200	1 000
With stepper motor EMMS-ST	[kgcm <sup>2</sup> ]	30	100	500
With motor unit MTR-DCI-...-G7	[kgcm <sup>2</sup> ]	50	300	1,000
With motor unit MTR-DCI-...-G14	[kgcm <sup>2</sup> ]	200	1,200	3,700
Toothed belt pitch		2	3	5

- 1) Output torque less friction is dependent on speed  
2) At maximum speed  
3) With symmetrical and non-eccentric arrangement  
4) Dependent on the size of the motor. Suitable motors → 20

# Rotary lifting modules EHMB, electric

Technical data

Operating and environmental conditions			
Size	20	25	32
Ambient temperature [°C]	-10 ... +60		
Noise level $L_{pEq}$ with cover [dB (A)]	57	56	53
Noise level $L_{pEq}$ without cover [dB (A)]	54	51	51

Weight [g]						
Size	20		25		32	
Stroke [mm]	100	200	100	200	100	200
Product weight						
Total	1,716	1,851	3,347	3,620	6,112	6,388
Moving mass for linear movement						
Guide rod	501	681	1,251	1,651	1,332	1,732
Stop nut	25	25	53	53	53	53
Shock absorber retainer	64	64	99	99	99	99
Shock absorber	42	42	66	66	66	66
Rod eye	73	73	73	73	108	108
Moving mass of standard cylinder DNC	252	342	252	342	467	627

## Materials

Sectional view

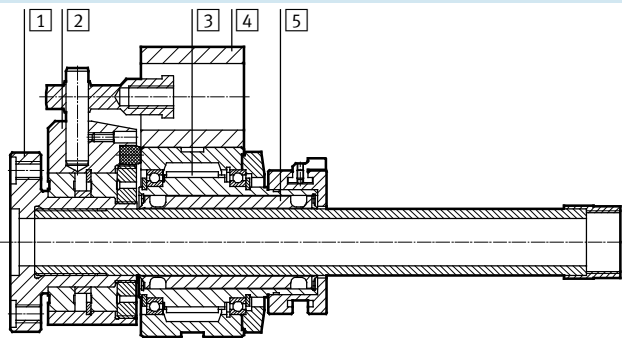

Rotary lifting module		
1	Flange	Anodised aluminium
2	Holder	Wrought aluminium alloy, anodised
3	Toothed belt	Polychloroprene with glass fibres
4	Retainer	Anodised aluminium
5	Output shaft	Steel
-	Drive shaft	High-alloy stainless steel
	Note on materials	Contains PWIS (paint wetting impairment substances)

# Rotary lifting modules EHMB, electric

Technical data

## Maximum radial and axial force $F_y/F_z$ at the output shaft as a function of distance $x/z$

If the rotary module is subjected to two or more forces at once, the following equation must be satisfied in addition to the maximum loads indicated below.

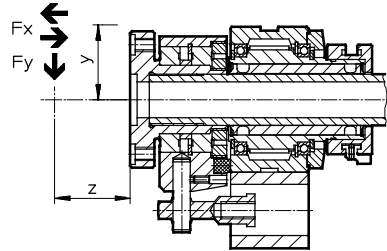

$$\frac{|F_x|}{F_{x_{max}}} + \frac{|F_y|}{F_{y_{max}}} + \frac{|F_z|}{F_{z_{max}}} \leq 1$$

### Max. radial force $F_y$ , dynamic

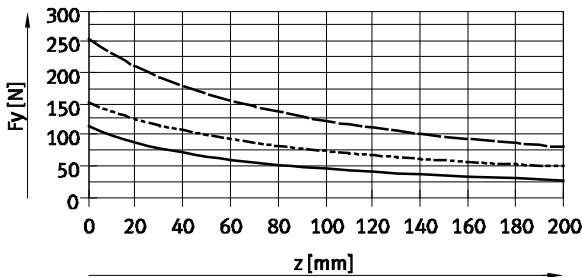

### Max. axial force $F_x$ , dynamic, pushing and pulling

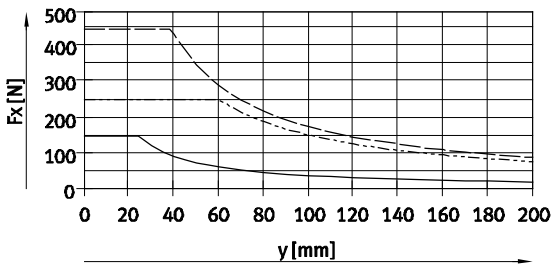

- EHMB-20
- - - EHMB-25
- · - EHMB-32



# Rotary lifting modules EHMB, electric

Technical data

## Deflection $f$ as a function of lateral stroke $F$ and stroke $l$

The following graphs show the deflection  $f$  of the rotary lifting module under radial forces and with two strokes.

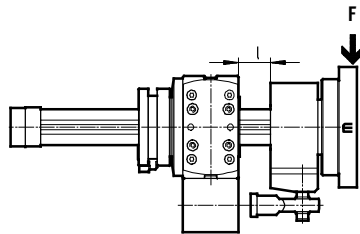

EHMB-20

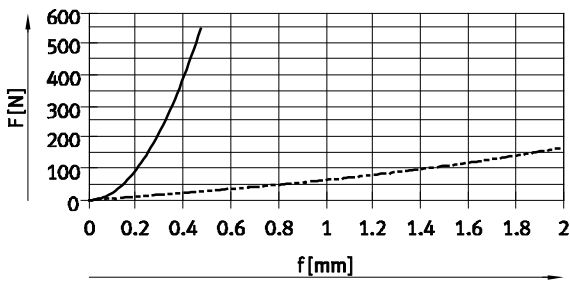

EHMB-25

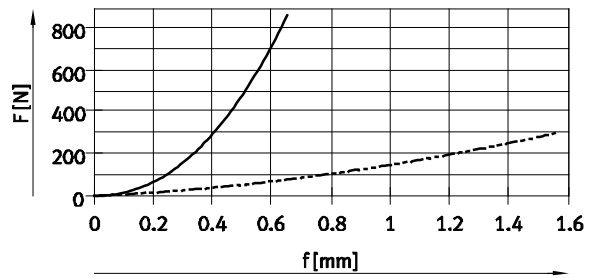

EHMB-32

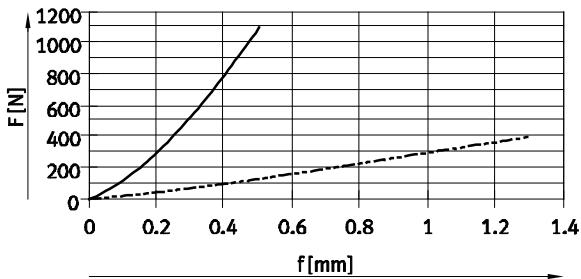

—  $l = 10$  mm  
 - - -  $l = 200$  mm

# Rotary lifting modules EHMB, electric

Technical data

Max. speed  $v$  as a function of effective load  $m$ , in combination with the pneumatic standard cylinder DNC

Mounting position:

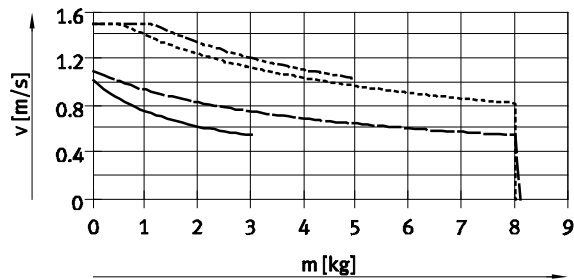
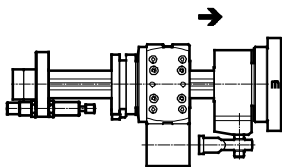
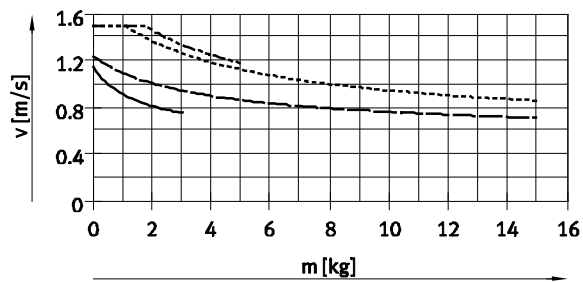
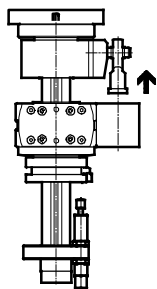
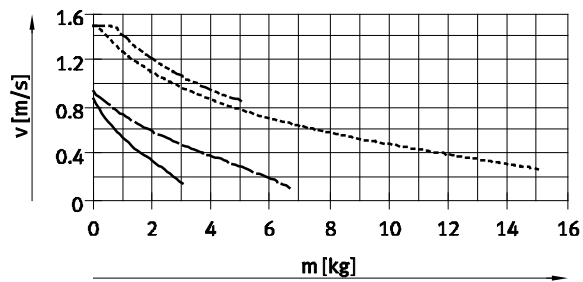
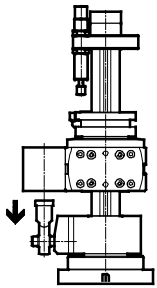

- EHMB-20
- - - EHMB-25
- · - EHMB-32, with one shock absorber DYSW
- · · EHMB-32, with two shock absorbers DYSW

# Rotary lifting modules EHMB, electric

Technical data

## Positioning time $t$ as a function of rotation angle $\alpha$ in combination with motor EMMS-.../motor unit MTR-DCI-...

Size 20

With servo motor EMMS-AS

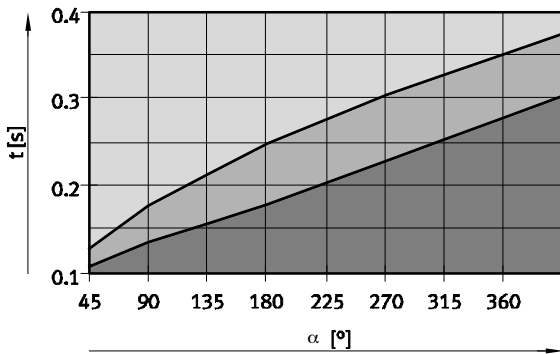

- Permissible range
- The viability is dependent on the motor size and inertia of the load
- Non-viable range

## With stepper motor EMMS-ST

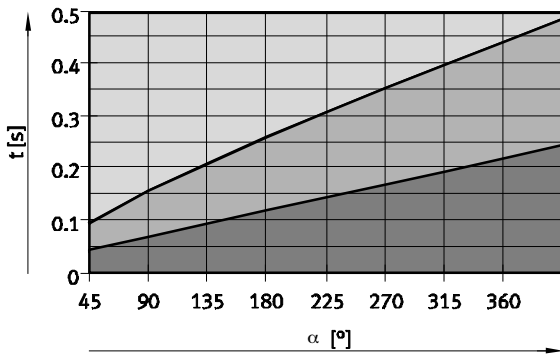

- Permissible range
- The viability is dependent on the motor size and inertia of the load
- Non-viable range

## With motor unit MTR-DCI

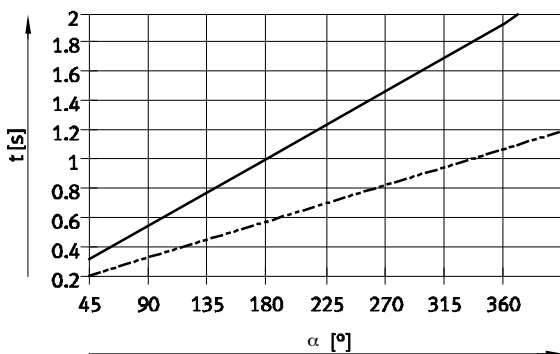

- Limit range for MTR-DCI-32-G14 at 0 ... 200 kgcm<sup>2</sup>
- Limit range for MTR-DCI-32-G7 at 0 ... 50 kgcm<sup>2</sup>

# Rotary lifting modules EHMB, electric

Technical data

## Positioning time $t$ as a function of rotation angle $\alpha$ in combination with motor EMMS-.../motor unit MTR-DCI-...

Size 25

With servo motor EMMS-AS

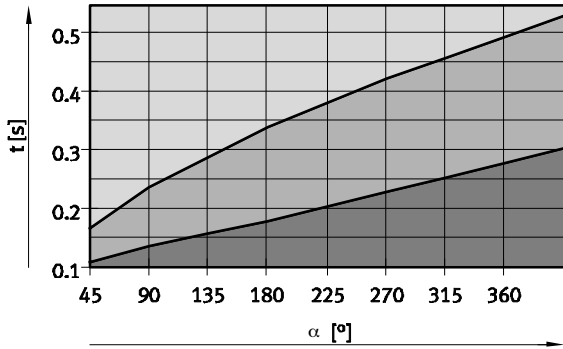

- Permissible range
- The viability is dependent on the motor size and inertia of the load
- Non-viable range

With stepper motor EMMS-ST

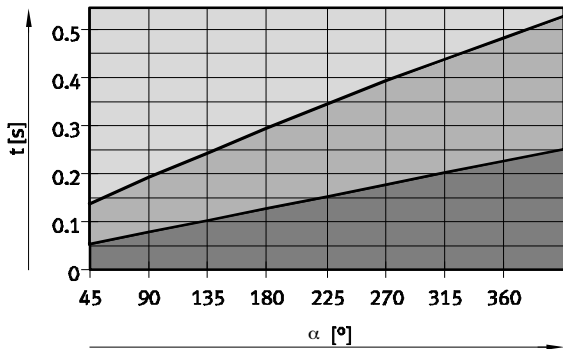

- Permissible range
- The viability is dependent on the motor size and inertia of the load
- Non-viable range

With motor unit MTR-DCI

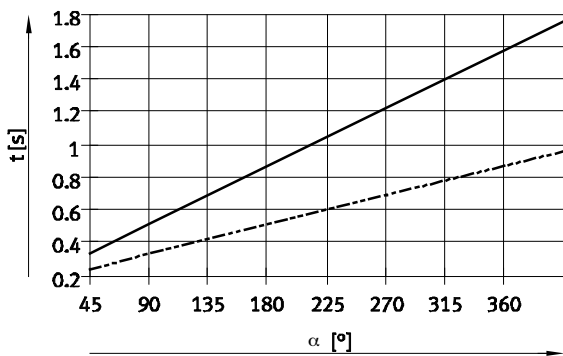

- Limit range for MTR-DCI-42-G14 at 0 ... 1,200 kgcm<sup>2</sup>
- - - Limit range for MTR-DCI-42-G7 at 0 ... 300 kgcm<sup>2</sup>

# Rotary lifting modules EHMB, electric

Technical data

## Positioning time $t$ as a function of rotation angle $\alpha$ in combination with motor EMMS-.../motor unit MTR-DCI-...

Size 32

With servo motor EMMS-AS

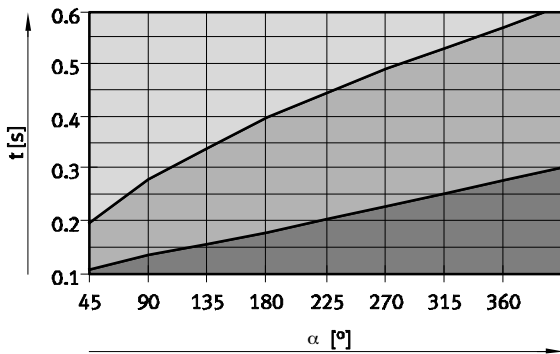

- Permissible range
- The viability is dependent on the motor size and inertia of the load
- Non-viable range

With stepper motor EMMS-ST

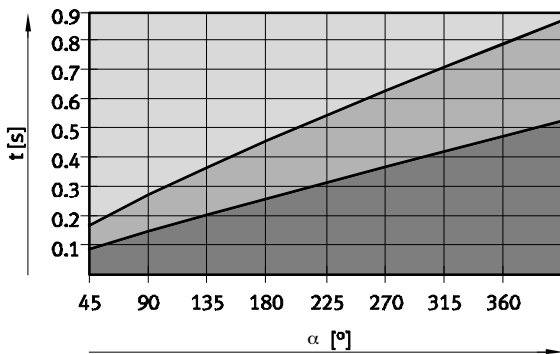

- Permissible range
- The viability is dependent on the motor size and inertia of the load
- Non-viable range

With motor unit MTR-DCI

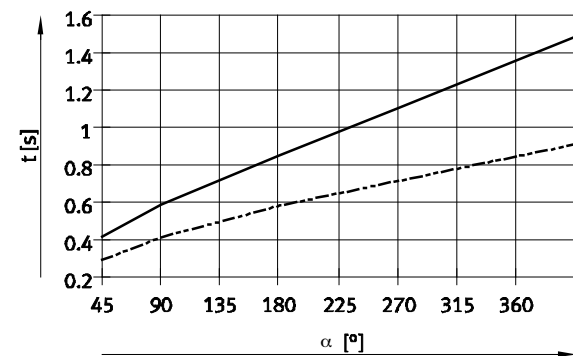

- Limit range for MTR-DCI-52-G14 at 0 ... 3,700 kgcm<sup>2</sup>
- Limit range for MTR-DCI-52-G7 at 0 ... 1,000 kgcm<sup>2</sup>

# Rotary lifting modules EHMB, electric

Technical data

FESTO

Dimensions

Download CAD data → [www.festo.com](http://www.festo.com)

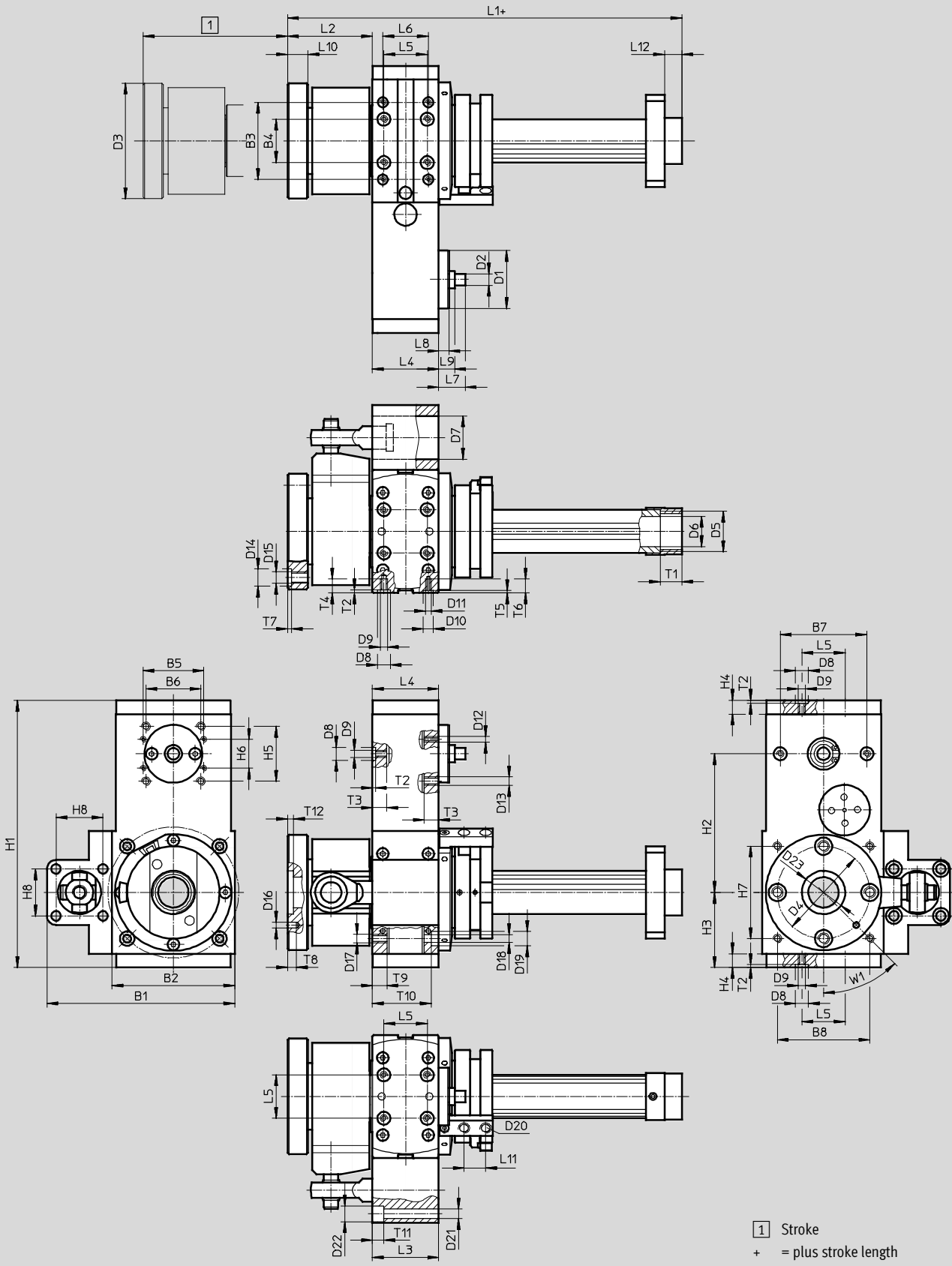

# Rotary lifting modules EHMB, electric

Technical data

Size	B1 ±0.5	B2 ±0.2	B3 <sup>1)</sup>	B4 <sup>1)</sup>	B5 ±0.15	B6 ±0.15	B7 <sup>1)</sup>	B8 ±0.15	D1 ∅ g7	D2 ∅ h6	D3 ∅	D4 ∅ ±0.05
20	110	65	54	34	32	32.5	30	52	32	6	58	45
25	130	85	53.5	30	42	38	60	64	40	8	80	64
32	169.5	115	70	40	62	56.5	80	88	60	12	80	64

Size	D5	D6 ∅	D7 ∅ H8	D8 ∅ H7	D9	D10 ∅ H7	D11	D12	D13	D14 ∅ H7	D15	D16 ∅ H7
20	Pg16	14	30	9	M5	7	M4	M3	M6	9	M6	4
25	Pg21	21	30	9	M5	7	M4	M4	M6	12	M8	4
32	Pg21	21	35	9	M5	-	M5	M5	M8	12	M8	4

Size	D17	D18 ∅	D19 ∅	D20	D21 ∅	D22 ∅	D23 ∅	H1 ±0.5	H2 ±0.05	H3	H4	H5 ±0.15
20	M5	-	-	M8x1	6.6	11	19 <sup>H8</sup>	149	72	45	9.5	32.5
25	M6	5.5	10	M8x1	6.6	11	30 <sup>H7</sup>	185	96	52	9.5	38
32	M6	6.2	10	M8x1	6.6	11	30 <sup>H7</sup>	229.5	108	70.5	13	56.5

Size	H6 ±0.15	H7 ±0.15	H8	L1	L2 min.	L3 ±0.1	L4 ±0.1	L5 <sup>1)</sup>	L6 <sup>1)</sup>	L7	L8	L9	L10	L11 ±0.1
20	19	44	32.5	147.5	40.5	52	40	30	30	15.8	5	7.8	9	15
25	20	64	32.5	173	58.6	46	46	30	31.5	18.35	7	-	14	15
32	31	88	38	183	61.4	60	60	40	47	23.3	6	-	14	15

Size	L12	T1	T2 +0.1	T3	T4	T5 +0.2	T6	T7 +0.1	T8	T9	T10 ±0.2	T11	T12 ±0.5	W1
20	12	14	2.1	10	9	1.6	9.5	2.1	6	8.5	-	11	3	45°
25	12	15	2.1	10	9.6	1.6	9.5	2.7	6	10	40.8	8	4	45°
32	12	15	2.1	10	9	-	9.5	2.7	6	10	54.3	15	4	45°

1) Tolerance for centring hole ±0.02 mm  
Tolerance for thread ±0.1 mm

# Rotary lifting modules EHMB, electric

Technical data

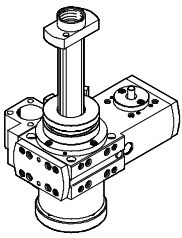
Ordering data				
	Size	Stroke [mm]	Part No.	Type
	20	100	1107096	EHMB-20-100
		200	1107097	EHMB-20-200
	25	100	1095933	EHMB-25-100
		200	1095934	EHMB-25-200
	32	100	1098558	EHMB-32-100
		200	1098559	EHMB-32-200

## Cylinder connection for linear movement

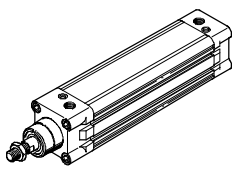
Ordering data				
In combination with pneumatic standard cylinder DNC			Technical data → Internet: dnc	
	For rotary lifting module	Standard cylinder DNC		
		Part No.	Type	
	EHMB-20-100	163309	DNC-32-100-PPV-A	
	EHMB-20-200	163312	DNC-32-200-PPV-A	
	EHMB-25-100	163309	DNC-32-100-PPV-A	
	EHMB-25-200	163312	DNC-32-200-PPV-A	
	EHMB-32-100	163341	DNC-40-100-PPV-A	
	EHMB-32-200	163344	DNC-40-200-PPV-A	

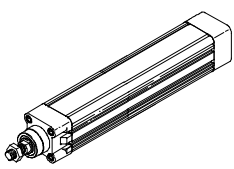
In combination with electric cylinder DNCE				
			Technical data → Internet: dnce	
	For rotary lifting module	Electric cylinder DNCE		
		Part No.	Type	
	EHMB-20-100	543115	DNCE-32-100-BS- <sup>1</sup> 3 <sup>1</sup> P-Q <sup>1</sup>	
	EHMB-20-200	543116	DNCE-32-200-BS- <sup>1</sup> 3 <sup>1</sup> P-Q <sup>1</sup>	
	EHMB-25-100	543115	DNCE-32-100-BS- <sup>1</sup> 3 <sup>1</sup> P-Q <sup>1</sup>	
	EHMB-25-200	543116	DNCE-32-200-BS- <sup>1</sup> 3 <sup>1</sup> P-Q <sup>1</sup>	
	EHMB-32-100	543127	DNCE-40-100-BS- <sup>1</sup> 5 <sup>1</sup> P-Q <sup>2</sup>	
	EHMB-32-200	543128	DNCE-40-200-BS- <sup>1</sup> 5 <sup>1</sup> P-Q <sup>2</sup>	

- 1) Linear ball screw drive with spindle pitch 3 mm, with reduced dynamic response
- 2) Linear ball screw drive with spindle pitch 5 mm, with reduced dynamic response

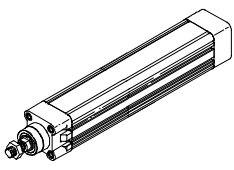
In combination with electric cylinder DNCE				
			Technical data → Internet: dnce	
	For rotary lifting module	Electric cylinder DNCE		
		Part No.	Type	
	EHMB-20-100	543119	DNCE-32-100-BS- <sup>1</sup> 10 <sup>1</sup> P-Q <sup>3</sup>	
	EHMB-20-200	543120	DNCE-32-200-BS- <sup>1</sup> 10 <sup>1</sup> P-Q <sup>3</sup>	
	EHMB-25-100	543119	DNCE-32-100-BS- <sup>1</sup> 10 <sup>1</sup> P-Q <sup>3</sup>	
	EHMB-25-200	543120	DNCE-32-200-BS- <sup>1</sup> 10 <sup>1</sup> P-Q <sup>3</sup>	
	EHMB-32-100	543131	DNCE-40-100-BS- <sup>1</sup> 12,7 <sup>1</sup> P-Q <sup>4</sup>	
	EHMB-32-200	543132	DNCE-40-200-BS- <sup>1</sup> 12,7 <sup>1</sup> P-Q <sup>4</sup>	

- 3) Linear ball screw drive with spindle pitch 10 mm
- 4) Linear ball screw drive with spindle pitch 12.7 mm





# Rotary lifting modules EHMB, electric

Accessories

FESTO

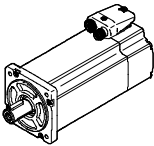
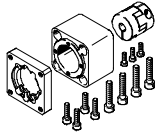
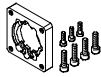
## Motor connection for linear movement

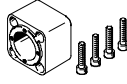
Permissible axis/motor combinations with axial kit				Technical data → Internet: eamm-a
Motor/motor unit	Axial kit	Axial kit consisting of:		
		Motor flange	Coupling	Coupling housing
				
Type	Part No. Type	Part No. Type	Part No. Type	Part No. Type
<b>DNCE-32</b>				
With servo motor				
EMME-AS-40-...	1976465 EAMM-A-D32-40P	1976704 EAMF-A-28B-40P	1232854 EAMC-16-20-6-8	552155 EAMK-A-D32-28B
EMME-AS-60-...	1956054 EAMM-A-D32-60P	1956846 EAMF-A-44C-60P	1233256 EAMC-30-32-6-14	551006 EAMK-A-D32-44A/C
EMMS-AS-40-...	543147 EAMM-A-D32-40A	552163 EAMF-A-28B-40A	543420 EAMC-16-20-6-6	552155 EAMK-A-D32-28B
EMMS-AS-55-...	550979 EAMM-A-D32-55A	529942 EAMF-A-44A/B-55A	551003 EAMC-30-32-6-9	551006 EAMK-A-D32-44A/C
With stepper motor				
EMMS-ST-42-...	543148 EAMM-A-D32-42A	552164 EAMF-A-28B-42A	543419 EAMC-16-20-5-6	552155 EAMK-A-D32-28B
EMMS-ST-57-...	550980 EAMM-A-D32-57A	530081 EAMF-A-44A/B-57A	551002 EAMC-30-32-6-6.35	551006 EAMK-A-D32-44A/C
With motor unit				
MTR-DCI-32S-... <sup>1)</sup>	543149 EAMM-A-D32-32B	–	543420 EAMC-16-20-6-6	552156 EAMK-A-D32-32B
<b>DNCE-40</b>				
With servo motor				
EMMS-AS-55-...	543153 EAMM-A-D40-55A	529942 EAMF-A-44A/B-55A	543423 EAMC-30-32-8-9	552157 EAMK-A-D40-44A/C
EMME-AS-60-...	1977000 EAMM-A-D40-60P	1956846 EAMF-A-44C-60P	562682 EAMC-30-32-8-14	552157 EAMK-A-D40-44A/C
EMMS-AS-70-...	550981 EAMM-A-D40-70A	529943 EAMF-A-44A/B-70A	551004 EAMC-30-32-8-11	552157 EAMK-A-D40-44A/C
With stepper motor				
EMMS-ST-57-...	543154 EAMM-A-D40-57A	530081 EAMF-A-44A/B-57A	543421 EAMC-30-32-6.35-8	552157 EAMK-A-D40-44A/C
EMMS-ST-87-...	550982 EAMM-A-D40-87A	530082 EAMF-A-44A/B-87A	551004 EAMC-30-32-8-11	552157 EAMK-A-D40-44A/C
With motor unit				
MTR-DCI-42S-...-G7 <sup>1)</sup>	543155 EAMM-A-D40-42B	–	543422 EAMC-30-32-8-8	522158 EAMK-A-D40-42B
MTR-DCI-42S-...-G14 <sup>1)</sup>	543156 EAMM-A-D40-42C	–	543422 EAMC-30-32-8-8	522159 EAMK-A-D40-42C

1) Only in combination with DNCE-...-LS

 Note

Depending on the combination of motor/motor unit and rotary lifting module, it may not be possible to reach the maximum feed force of the cylinder.

The following tool is available for sizing:  
PositioningDrives  
sizing software  
→ [www.festo.com](http://www.festo.com)

# Rotary lifting modules EHMB, electric

Accessories

FESTO

## Motor connection for linear movement

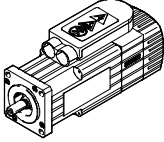
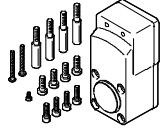
Permissible axis/motor combinations with parallel kit		Technical data → Internet: eamm-u
Motor/motor unit	Parallel kit	
		
Type	Part No.	Type
<b>DNCE-32</b>		
With servo motor		
<b>EMMS-AS-40-...</b>	<b>543150</b>	<b>EAMM-U-D32-40A</b>
With motor unit		
<b>MTR-DCI-32S-...</b>	<b>543152</b>	<b>EAMM-U-D32-32B</b>
<b>DNCE-40</b>		
With servo motor		
<b>EMMS-AS-55-...</b>	<b>543157</b>	<b>EAMM-U-D40-55A</b>
With motor unit		
<b>MTR-DCI-42S-...-G7</b>	<b>543159</b>	<b>EAMM-U-D40-42B</b>
<b>MTR-DCI-42S-...-G14</b>	<b>543160</b>	<b>EAMM-U-D40-42C</b>

 Note

Depending on the combination of motor/motor unit and rotary lifting module, it may not be possible to reach the maximum feed force of the cylinder.

The respective no-load driving torque of the kit must be taken into consideration when using parallel kits.

The following tool is available for sizing:  
PositioningDrives  
sizing software  
→ [www.festo.com](http://www.festo.com)

# Rotary lifting modules EHMB, electric

Accessories

## Motor connection for linear movement

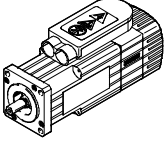
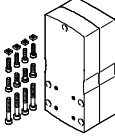
Permissible axis/motor combinations with parallel kit		Technical data → Internet: eamm-u
Motor/motor unit	Parallel kit	
		<ul style="list-style-type: none"> <li>• Increased housing rigidity</li> <li>• More flexible motor mounting possible</li> <li>• Optionally with protection to IP65</li> <li>• Use in combination with third-party motors on request</li> </ul>
Type	Part No.	Type
<b>DNCE-32</b>		
With servo motor		
EMMS-AS-40-...	1201591	EAMM-U-50-D32-40A-78 <sup>1)</sup>
EMMS-AS-55-...	1210126	EAMM-U-60-D32-55A-91 <sup>2)</sup>
With stepper motor		
EMMS-ST-42-...	1201607	EAMM-U-50-D32-42A-78 <sup>1)</sup>
EMMS-ST-57-...	1210419	EAMM-U-60-D32-57A-91 <sup>2)</sup>
With motor unit		
MTR-DCI-32S-...	1570862	EAMM-U-50-D32-32B-78 <sup>1)</sup>
<b>DNCE-40</b>		
With servo motor		
EMMS-AS-55-...	1210438	EAMM-U-60-D40-55A-91
EMMS-AS-70-...	1212826	EAMM-U-86-D40-70A-102 <sup>3)</sup>
With stepper motor		
EMMS-ST-57-...	1210442	EAMM-U-60-D40-57A-91
EMMS-ST-87-...	1215802	EAMM-U-86-D40-87A-102 <sup>3)</sup>
With motor unit		
MTR-DCI-42S-...	1570950	EAMM-U-60-D40-42B/C-91

1) The parallel kit EAMM-U-50-.. cannot be operated in combination with the cover EASC-H1 in all attachment positions.

2) The parallel kit EAMM-U-60-.. cannot be operated in combination with the cover EASC-H1.

3) The parallel kit EAMM-U-86-.. cannot be operated in combination with the cover EASC-H1 in all attachment positions.

### Note

The motor and/or axis shaft can optionally be supported with a counter bearing EAMG.



More information → eamm-u

# Rotary lifting modules EHMB, electric

Accessories

FESTO

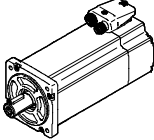
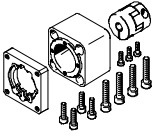
## Motor connection for rotary movement

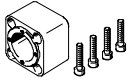
Permissible axis/motor combinations with axial kit – Without gear unit					Technical data → Internet: eamm-a
Motor/motor unit	Axial kit	Axial kit consisting of:			
		Motor flange	Coupling	Coupling housing	
					
Type	Part No. Type	Part No. Type	Part No. Type	Part No. Type	
<b>EHMB-20</b>					
With servo motor					
EMME-AS-40-...	2207441 EAMM-A-D32-35A-40P	–	533708 EAMC-30-32-6-8	2207509 EAMK-A-D32-35-40P	
EMMS-AS-40-...	560281 EAMM-A-D32-35A-40A	–	558312 EAMC-30-32-6-6	560280 EAMK-A-D32-35-40A	
With stepper motor					
EMMS-ST-42-...	543148 EAMM-A-D32-42A	552164 EAMF-A-28B-42A	543419 EAMC-16-20-5-6	552155 EAMK-A-D32-28B	
EMMS-ST-57-S-...	550980 EAMM-A-D32-57A	530081 EAMF-A-44A/B-57A	551002 EAMC-30-32-6-6.35	551006 EAMK-A-D32-44A/C	
With motor unit					
MTR-DCI-32S-...	543149 EAMM-A-D32-32B	–	543420 EAMC-16-20-6-6	552156 EAMK-A-D32-32B	
<b>EHMB-25</b>					
With servo motor					
EMMS-AS-55-...	543153 EAMM-A-D40-55A	529942 EAMF-A-44A/B-55A	543423 EAMC-30-32-8-9	552157 EAMK-A-D40-44A/C	
EMME-AS-60-...	1977000 EAMM-A-D40-60P	1956846 EAMF-A-44C-60P	562682 EAMC-30-32-8-14	552157 EAMK-A-D40-44A/C	
EMMS-AS-70-S-...	550981 EAMM-A-D40-70A	529943 EAMF-A-44A/B-70A	551004 EAMC-30-32-8-11	552157 EAMK-A-D40-44A/C	
With stepper motor					
EMMS-ST-57-...	543154 EAMM-A-D40-57A	530081 EAMF-A-44A/B-57A	543421 EAMC-30-32-6.35-8	552157 EAMK-A-D40-44A/C	
With motor unit					
MTR-DCI-42S-...-G7	543155 EAMM-A-D40-42B	–	543422 EAMC-30-32-8-8	552158 EAMK-A-D40-42B	
MTR-DCI-42S-...-G14	543156 EAMM-A-D40-42C	–	543422 EAMC-30-32-8-8	552159 EAMK-A-D40-42C	

-  - Note

Note the maximum permissible drive torque of the EHMB. The motor current may need to be limited.



The following tool is available for sizing:  
PositioningDrives  
sizing software  
→ [www.festo.com](http://www.festo.com)

# Rotary lifting modules EHMB, electric

Accessories

FESTO

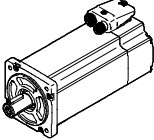
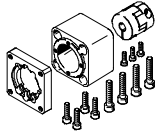
## Motor connection for rotary movement

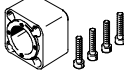
Permissible axis/motor combinations with axial kit – Without gear unit				Technical data → Internet: eamm-a
Motor/motor unit	Axial kit	Axial kit consisting of:		
		Motor flange	Coupling	Coupling housing
				
Type	Part No. Type	Part No. Type	Part No. Type	Part No. Type
<b>EHMB-32</b>				
With servo motor				
EMMS-AS-70-M-...	543161 EAMM-A-D60-70A	529945 EAMF-A-64A/B-70A	543424 EAMC-42-50-11-12	552160 EAMK-A-D60-64B
EMME-AS-80-...	1977073 EAMM-A-D60-80P	1977113 EAMF-A-64A/C-80P	551005 EAMC-42-50-12-19	551007 EAMK-A-D60-64C
EMME-AS-100-...	550983 EAMM-A-D60-100A	529947 EAMF-A-64A/C/D-100A	551005 EAMC-42-50-12-19	551007 EAMK-A-D60-64C
EMMS-AS-100-S-...	550983 EAMM-A-D60-100A	529947 EAMF-A-64A/C/D-100A	551005 EAMC-42-50-12-19	551007 EAMK-A-D60-64C
With stepper motor				
EMMS-ST-87-...	543162 EAMM-A-D60-87A	533140 EAMF-A-64A/B-87A	543424 EAMC-42-50-11-12	552160 EAMK-A-D60-64B
With motor unit				
MTR-DCI-52S-...-G7	543163 EAMM-A-D60-52B	–	533709 EAMC-42-50-12-12	552161 EAMK-A-D60-52B
MTR-DCI-52S-...-G14	543164 EAMM-A-D60-52C	–	533709 EAMC-42-50-12-12	552162 EAMK-A-D60-52C

 Note

Note the maximum permissible drive torque of the EHMB. The motor current may need to be limited.



The following tool is available for sizing:  
PositioningDrives  
sizing software  
→ [www.festo.com](http://www.festo.com)

# Rotary lifting modules EHMB, electric

Accessories

FESTO

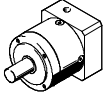
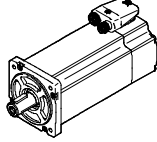
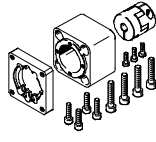
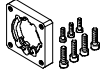
## Motor connection for rotary movement

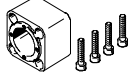
Permissible axis/motor combinations with axial kit – With gear unit						Technical data → Internet: eamm-a
Gear unit	Motor	Axial kit	Axial kit consisting of:			
			Motor flange	Coupling	Coupling housing	
						
Type	Type	Part No. Type	Part No. Type	Part No. Type	Part No. Type	
<b>EHMB-25</b>						
With servo motor						
EMGA-40-P-G...-EAS-40	EMME-AS-40-...	560282 EAMM-A-D40-40G	550986 EAMF-A-44A/B-40G	558029 EAMC-30-32-8-10	552157 EAMK-A-D40-44A/C	
EMGA-40-P-G3-SAS-40	EMMS-AS-40-...	560282 EAMM-A-D40-40G	550986 EAMF-A-44A/B-40G	558029 EAMC-30-32-8-10	552157 EAMK-A-D40-44A/C	
EMGA-40-P-G...-SST-42	EMMS-ST-42-...	560282 EAMM-A-D40-40G	550986 EAMF-A-44A/B-40G	558029 EAMC-30-32-8-10	552157 EAMK-A-D40-44A/C	
<b>EHMB-32</b>						
With servo motor						
EMGA-60-P-G...-SAS-55	EMMS-AS-55-...	560283 EAMM-A-D60-60G	550987 EAMF-A-64A/B-60G/H	543424 EAMC-42-50-11-12	552160 EAMK-A-D60-64B	
EMGA-60-P-G3-SAS-70	EMMS-AS-70-...	560283 EAMM-A-D60-60G	550987 EAMF-A-64A/B-60G/H	543424 EAMC-42-50-11-12	552160 EAMK-A-D60-64B	
With stepper motor						
EMGA-60-P-G...-SST-57	EMMS-ST-57-...	560283 EAMM-A-D60-60G	550987 EAMF-A-64A/B-60G	543424 EAMC-42-50-11-12	552160 EAMK-A-D60-64B	

 - Note

Note the maximum permissible drive torque of the EHMB. The motor current may need to be limited.

The following tool is available for sizing:  
PositioningDrives  
sizing software  
→ [www.festo.com](http://www.festo.com)

# Rotary lifting modules EHMB, electric

Accessories

## Rod eye SGS

Scope of delivery:

1 rod eye, 1 hex nut to DIN 439

Material:

Galvanised steel

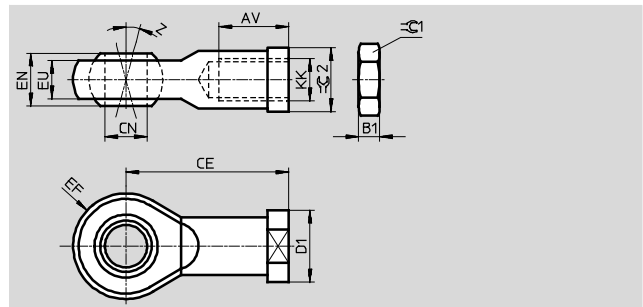

Dimensions and ordering data								
For size	AV	B1	CE	CN	D1	EF	EN	EU
20, 25	20 -2	5	43	10	19	14	14	10.5
32	22 -2	6	50	12	22	16	16	12

For size	EU	KK	Z	∅C1	∅C2	Part No.	Type
20, 25	10.5	M10x1.25	13	17	17	9261	SGS-M10x1,25
32	12	M12x1.25	13	19	19	9262	SGS-M12x1,25



Ordering data						
	For size	Brief description	Weight [g]	Part No.	Type	PU <sup>1)</sup>
<b>Cover EASC</b>						
	20	For protecting the grooved-shaft guide	303	1099901	EASC-H1-20-100	1
			388	1099902	EASC-H1-20-200	
	25		385	1096387	EASC-H1-25-100	
			482	1096388	EASC-H1-25-200	
	32		383	1107235	EASC-H1-32-100	
		481	1107236	EASC-H1-32-200		
<b>Shock absorber retainer EAYH</b>						
	20	For attaching the shock absorbers	68	1153896	EAYH-H1-20	1
	25, 32		106	1153905	EAYH-H1-25	
<b>Shock absorber DYSW</b>						
	20	Progressive shock absorbers	42	548073	DYSW-8-14-Y1F	1
	25, 32		67	548074	DYSW-10-17-Y1F	
<b>Adapter plate kit EHAM</b>						
	20	For attaching the EHMB to the axes EGC and DGC	288	1132369	EHAM-H1-20-L2-80	1
	25		292	1132402	EHAM-H1-25-L2-80	
	32		668	1132529	EHAM-H1-32-L2-120	

1) Packaging unit

# Rotary lifting modules EHMB, electric

Accessories

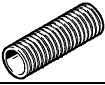
FESTO

Ordering data						
	For size	Brief description	Weight [g]	Part No.	Type	PU <sup>1)</sup>
<b>Protective conduit fitting EASA</b>						
	20	For attaching the protective conduit	8	1157774	EASA-H1-20-PG16	1
	25, 32		12	1096549	EASA-H1-25-PG21	
<b>Protective conduit MKR</b>						
	20	For protecting lines and tubing	-	177566	MKR-16,5-PG-16	-
	25, 32		-	177567	MKR-23-PG-21	
<b>Cam EAPS</b>						
	20	For sensing positions (2 cams included in the scope of delivery)	11	1234887	EAPS-H1-20-CK	2
	25, 32		11	1234888	EAPS-H1-25-CK	
<b>Centring sleeve ZBH</b>						
	- <sup>2)</sup>	For centring loads and attachments	1	186717	ZBH-7	10
			1	150927	ZBH-9	
			1	189653	ZBH-12	

1) Packaging unit

2) → Dimensional drawing 14

Ordering data – Proximity sensors, inductive			Technical data → Internet: sien	
	Contact	Connection	Part No.	Type
	N/O contact	Cable, 2.5 m	150386	SIEN-M8B-PS-K-L
		Plug	150387	SIEN-M8B-PS-S-L
	N/C contact	Cable, 2.5 m	150390	SIEN-M8B-PO-K-L
		Plug	150391	SIEN-M8B-PO-S-L

-  - Note

The bracket for the proximity sensor SIEN is included in the scope of delivery of the rotary lifting module.

Ordering data – Connecting cables			Technical data → Internet: nebu		
	Electrical connection, left	Electrical connection, right	Cable length [m]	Part No.	Type
	Straight socket, M8x1, 3-pin	Cable, open end,	2.5	541333	NEBU-M8G3-K-2.5-LE3
		3-wire	5	541334	NEBU-M8G3-K-5-LE3