

Toothed belt axes EGC-HD-TB, with heavy-duty guide



Electromechanical drives

Selection aid

Overview of toothed belt and spindle axes

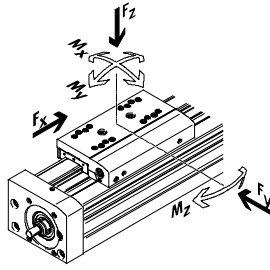
Toothed belt axes	Spindle axes	Coordinate system
<ul style="list-style-type: none"> • Speeds of up to 10 m/s • Acceleration of up to 50 m/s² • Repetition accuracy of up to +0.08 mm • Strokes of up to 8,500 mm (longer strokes on request) • Flexible motor mounting 	<ul style="list-style-type: none"> • Speeds of up to 2 m/s • Acceleration of up to 20 m/s² • Repetition accuracy of up to +0.003 mm • Strokes of up to 3,000 mm 	

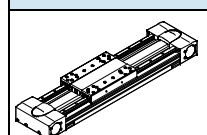
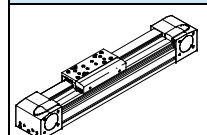
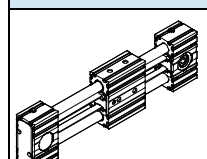
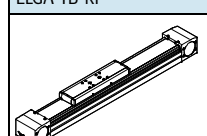
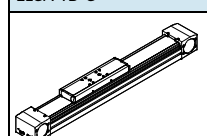
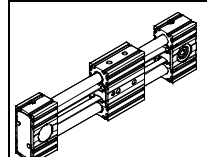
Toothed belt axes						
Type	F _x [N]	v [m/s]	M _x [Nm]	M _y [Nm]	M _z [Nm]	Properties
Heavy-duty recirculating ball bearing guide						
EGC-HD-TB						
	450 1,000 1,800	3 5 5	140 300 900	275 500 1,450	275 500 1,450	<ul style="list-style-type: none"> • Flat drive unit with rigid, closed profile • Precision, resilient DUO guide rail • Ideal as a basic axis for linear gantries and cantilever axes
Recirculating ball bearing guide						
EGC-TB-KF						
	50 100 350 800 2,500	3 5 5 5 5	3.5 16 36 144 529	10 132 228 680 1,820	10 132 228 680 1,820	<ul style="list-style-type: none"> • Rigid, closed profile • Precision, resilient guide rail • Small drive pinions reduce necessary driving torque • Space-saving position sensing
ELGR-TB						
	50 100 350	3 3 3	2.5 5 15	20 40 124	20 40 124	<ul style="list-style-type: none"> • Cost-optimised rod guide • Ready-to-install unit • Resilient ball bearings for dynamic operation
Roller bearing guide						
ELGA-TB-RF						
	350 800 1 300	10 10 10	11 30 100	40 180 640	40 180 640	<ul style="list-style-type: none"> • Sturdy roller bearing guide • Guide and toothed belt protected by cover strip • Speeds of up to 10 m/s • Lower weight than axes with guide rails
Plain-bearing guide						
ELGA-TB-G						
	350 800 1,300	5 5 5	5 10 120	30 60 120	10 20 40	<ul style="list-style-type: none"> • Guide and toothed belt protected by cover strip • For simple handling tasks • As an actuator for external guides • Insensitive to harsh environmental conditions
ELGR-TB-GF						
	50 100 350	1 1 1	1 2.5 1	10 20 40	10 20 40	<ul style="list-style-type: none"> • Cost-optimised rod guide • Ready-to-install unit • Heavy-duty plain bearings for use in harsh environmental conditions

Electromechanical drives

Selection aid

Overview of toothed belt and spindle axes

Toothed belt axes

- Speeds of up to 10 m/s
- Acceleration of up to 50 m/s²
- Repetition accuracy of up to +0.08 mm
- Strokes of up to 8,500 mm (longer strokes on request)
- Flexible motor mounting

Spindle axes

- Speeds of up to 2 m/s
- Acceleration of up to 20 m/s²
- Repetition accuracy of up to +0.003 mm
- Strokes of up to 3,000 mm

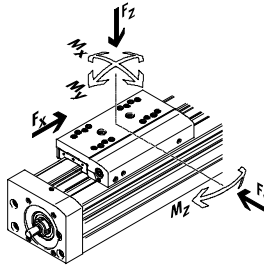

Spindle axes

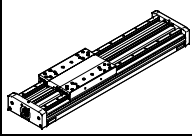
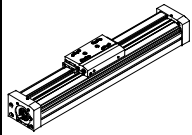
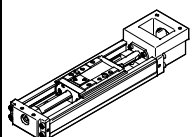
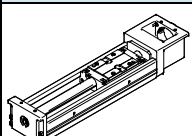
Type	F_x [N]	v [m/s]	M_x [Nm]	M_y [Nm]	M_z [Nm]	Properties
Heavy-duty recirculating ball bearing guide						
EGC-HD-BS						
	300 600 1,300	0.5 1.0 1.5	140 300 900	275 500 1,450	275 500 1,450	<ul style="list-style-type: none"> • Flat drive unit with rigid, closed profile • Precision, resilient DUO guide rail • Ideal as a basic axis for linear gantries and cantilever axes
Recirculating ball bearing guide						
EGC-BS-KF						
	300 600 1,300 3,000	0.5 1.0 1.5 2.0	16 36 144 529	132 228 680 1,820	132 228 680 1,820	<ul style="list-style-type: none"> • Rigid, closed profile • Precision, resilient guide rail • For extremely high requirements for speed, acceleration and torque resistance • Space-saving position sensing
EGSK						
	57 133 184 239 392	0.33 1.10 0.83 1.10 1.48	13 28.7 60 79.5 231	3.7 9.2 20.4 26 77.3	3.7 9.2 20.4 26 77.3	<ul style="list-style-type: none"> • Spindle axes with maximum precision, compactness and rigidity • Recirculating ball bearing guide and ball screw without caged ball bearings • Standard designs in stock
EGSP						
	112 212 466 460	0.6 0.6 2.0 2.0	36.3 81.5 90.3 258	12.5 31.6 32.1 94	12.5 31.6 32.1 94	<ul style="list-style-type: none"> • Spindle axes with maximum precision, compactness and rigidity • Recirculating ball bearing guide with caged ball bearings • Ball screw sizes 33, 46 with caged ball bearings

Toothed belt axes EGC-HD-TB, with heavy-duty guide

Key features

At a glance

- New heavy-duty guide for:
 - Maximum loads and torques
 - High feed forces and speeds
 - Long service life
- Precision, resilient DUO guide rail
- Ideal as a basic axis for linear gantries and cantilever axes
- In addition to its technical data, the toothed belt axis also offers an excellent price/performance ratio
- Space-saving position sensing with proximity sensor in the profile slot
- Wide range of options for mounting on drives

Flexible motor mounting

The motor position can be freely selected on four sides and can be changed at any time.

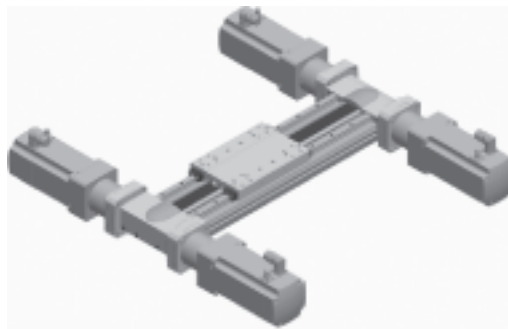

Flat unit with rigid, closed profile

EGC-HD-125

EGC-HD-160

EGC-HD-220

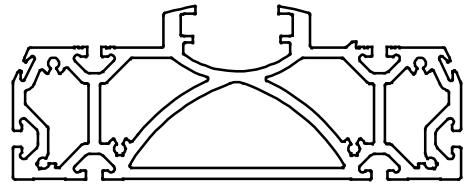
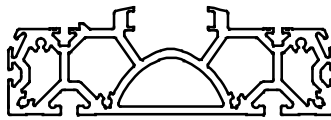
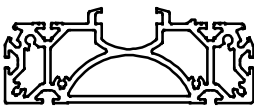

Characteristic values of the axes

The specifications shown in the table are maximum values.

The precise values for each of the variants can be found in the relevant technical data section.

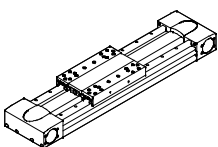
Version	Size	Working stroke [mm]	Speed [m/s]	Repetition accuracy [mm]	Feed force [N]	Guide characteristics				
						Forces and torques				
						F _y [N]	F _z [N]	M _x [Nm]	M _y [Nm]	M _z [Nm]
Recirculating ball bearing guide										
	125	50 ... 3 000	3	+0.08	450	3,650	3,650	140	275	275
	160	50 ... 5,000	5	+0.08	1,000	5,600	5,600	300	500	500
	220	50 ... 4,750	5	+0.1	1,800	13,000	13,000	900	1,450	1,450

 Note

PositioningDrives
sizing software
www.festo.com

Toothed belt axes EGC-HD-TB, with heavy-duty guide

Key features

Slide variants

Standard slide



Standard slide, protected



With additional slide



Complete system comprising toothed belt axis, motor, motor controller and motor mounting kit

Toothed belt axis with recirculating ball bearing guide



Motor mounting kit

Axial kit



Kit comprising:

- Motor flange
- Coupling housing
- Coupling
- Screws

Motor

Servo motor EMMS-AS



Gear unit

Gear unit EMGA



Motor controller

Servo motor controller
CMMP-AS, CMMS-AS



 Note

A range of specially adapted complete solutions is available for the toothed belt axis EGC and the motors.

Toothed belt axes EGC-HD-TB, with heavy-duty guide

Type codes

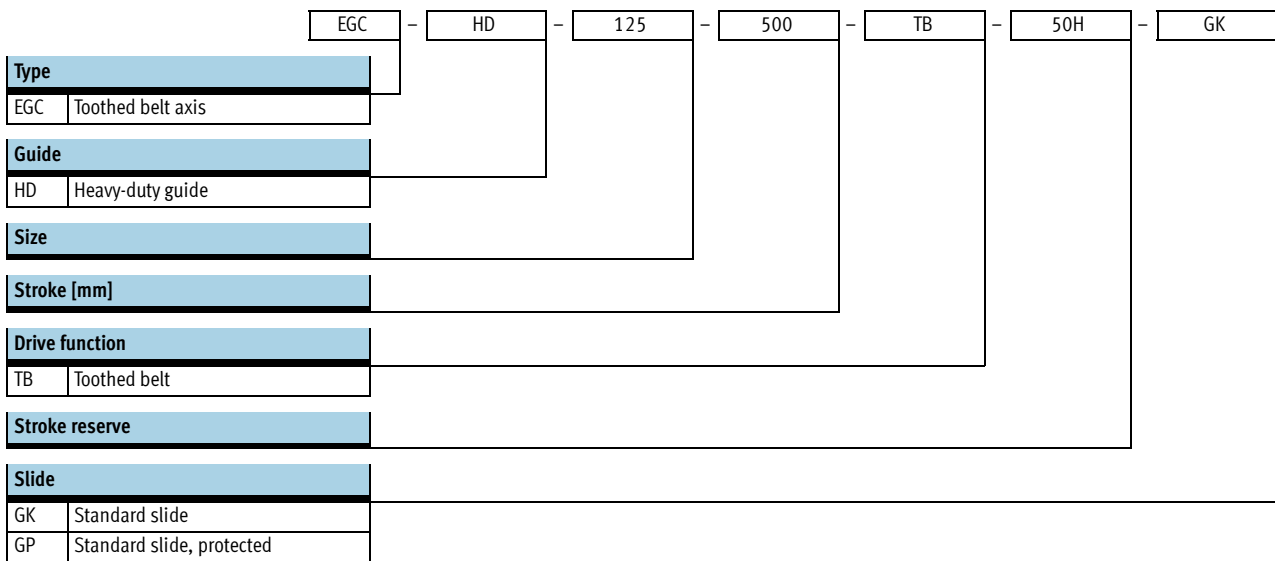

Toothed belt axes EGC-HD-TB, with heavy-duty guide

Type codes

→		-		ZUB -	2MX2Z	-	DN
Additional slide							
KL	Standard, left						
Additional slide							
KR	Standard, right						
Accessories enclosed separately							
...M	Profile mounting						
...B	Mounting slot cover						
...S	Sensor slot cover						
...Y	Slot nut for mounting slot						
...X	Proximity sensor (SIES), inductive, slot type 8, PNP, N/O contact, 7.5 m cable						
...Z	Proximity sensor (SIES), inductive, slot type 8, PNP, N/C contact, 7.5 m cable						
...A	Emergency buffer with retainer						
...C	Shock absorber with retainer						
...O	Proximity sensor (SIEN), inductive, M8, PNP, N/O contact, 2.5 m cable						
...P	Proximity sensor (SIEN), inductive, M8, PNP, N/C contact, 2.5 m cable						
...W	Proximity sensor (SIEN), inductive, M8, PNP, N/O contact, plug M8						
...R	Proximity sensor (SIEN), inductive, M8, PNP, N/C contact, plug M8						
...V	Connecting cable						
...CL	Cable clip						
Operating instructions							
DN	None						

Toothed belt axes EGC-HD-TB, with heavy-duty guide

Peripherals overview

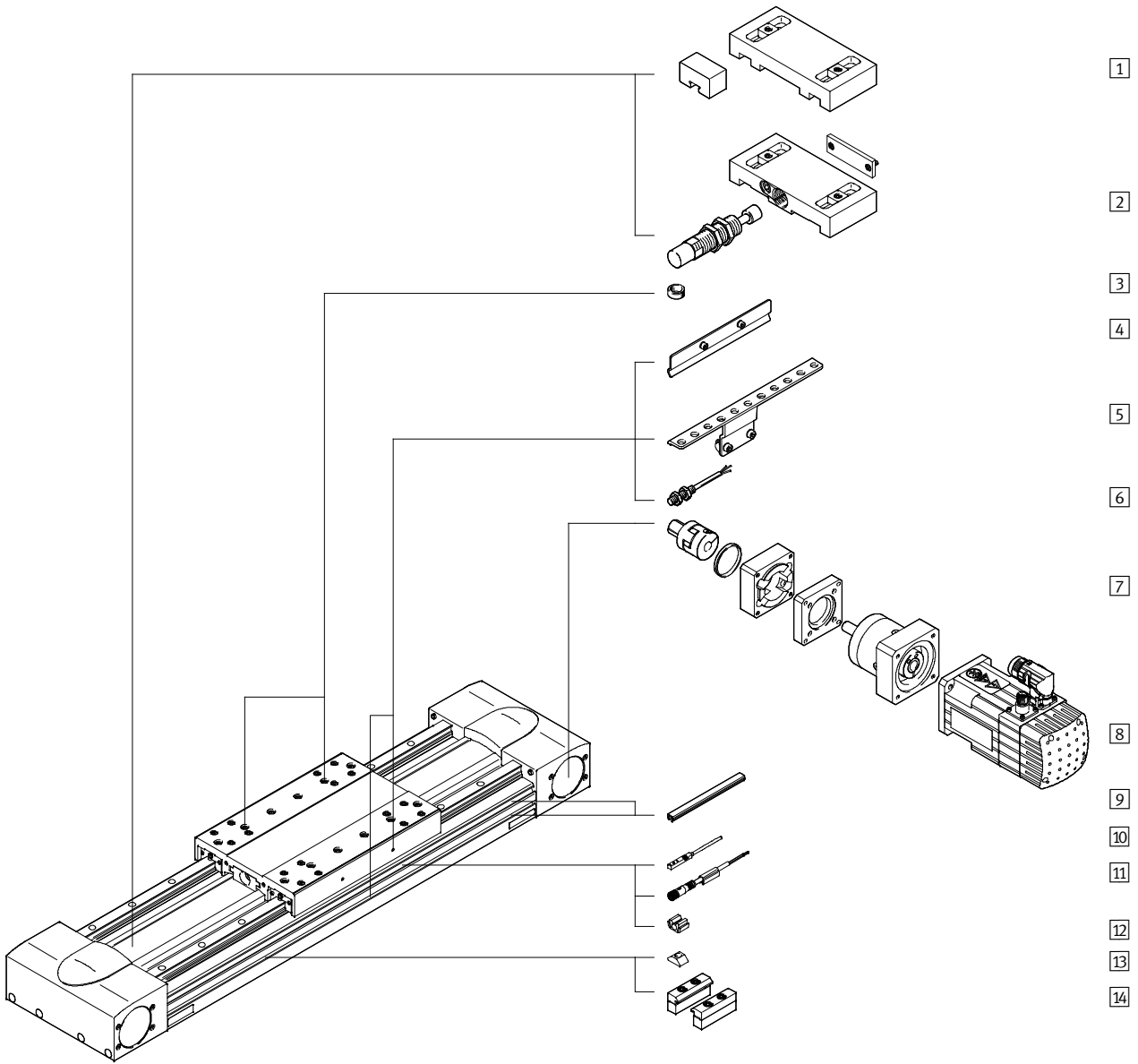

Toothed belt axes EGC-HD-TB, with heavy-duty guide

Peripherals overview



Variants and accessories		
Type	Brief description	→ Page/Internet
1 Emergency buffer with retainer A	For avoiding damage at the end stop in the event of malfunction	26
2 Shock absorber with retainer C	For avoiding damage at the end stop in the event of malfunction	26
3 Centring pin/sleeve ZBS, ZBH	<ul style="list-style-type: none"> For centring loads and attachments on the slide 2 centring pins/sleeves included in the scope of delivery of the axis 	28
4 Switch lug X, Z, O, P, W, R	For sensing the slide position	26
5 Sensor bracket O, P, W, R	Adapter for mounting the inductive proximity sensors (round design) on the axis	26
6 Proximity sensor, M8 O, P, W, R	<ul style="list-style-type: none"> Inductive proximity sensor, round design The order code O, P, W, R includes 1 switch lug and max. 2 sensor brackets 	29
7 Axial kit EAMM	For axial motor mounting (consisting of: coupling, coupling housing and motor flange)	24
8 Motor EMMS	Motors specially matched to the axis, with gear unit, with or without brake	24
9 Slot cover B, S	<ul style="list-style-type: none"> For protecting against the ingress of dirt 	28
10 Proximity sensor, T-slot X, Z	<ul style="list-style-type: none"> Inductive proximity sensor, for T-slot The order code X, Z includes 1 switch lug 	29
11 Connecting cable V	For proximity sensor (order code W and R)	29
12 Clip CL	For mounting the proximity sensor cable in the slot	28
13 Slot nut Y	For mounting attachments	28
14 Profile mounting M	For mounting the axis on the profile	25

Toothed belt axes EGC-HD-TB, with heavy-duty guide

Technical data

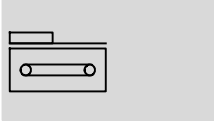
Function



-  - Size
125 ... 220
-  - Stroke length
50 ... 5,000 mm

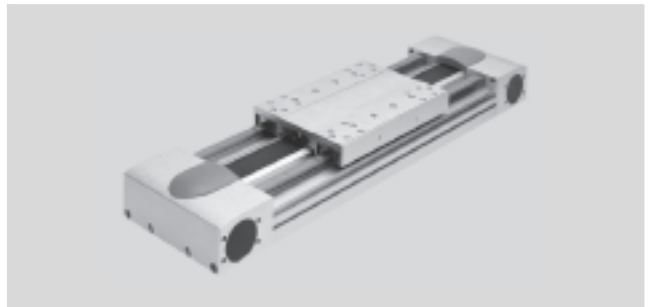

General technical data				
Size		125	160	220
Design		Electromechanical axis with toothed belt		
Guide		Recirculating ball bearing guide		
Mounting position		Any		
Working stroke	[mm]	50 ... 3,000	50 ... 5,000	50 ... 4,750
Max. feed force F_x	[N]	450	1,000	1,800
Max. no-load torque ¹⁾	[Nm]	0.5	2.1	4.1
Max. no-load resistance to shifting ¹⁾	[N]	30.79	105.5	123.8
Max. driving torque	[Nm]	7.2	20	59.58
Max. speed				
EGC-...-GK	[m/s]	3	5	
EGC-...-GP	[m/s]	-	3	
Max. acceleration	[m/s ²]	40	50	
Repetition accuracy	[mm]	+0.08		+0.1

1) At 0.2 m/s

Operating and environmental conditions		
Ambient temperature	[°C]	-10 ... +60
Protection class		IP40
Duty cycle	[%]	100

Weight [g]				
Size		125	160	220
Basic weight with 0 mm stroke ¹⁾		4,720	9,050	25,510
Additional weight per 10 mm stroke		73	107	210
Slide				
EGC-...-GK		1,218	2,571	6,317
EGC-...-GP		-	2,643	6,417
Additional slide				
EGC-...-GK		1,026	2,022	5,498
EGC-...-GP		-	2,134	5,598

1) Incl. slide

Toothed belt axes EGC-HD-TB, with heavy-duty guide

Technical data

Toothed belt				
Size		125	160	220
Pitch	[mm]	3	5	8
Width	[mm]	30.3	40.0	50.5
Expansion ¹⁾	[%]	0.31	0.23	0.29
Effective diameter	[mm]	32.47	39.79	66.21
Feed constant	[mm/rev.]	102	125	208

1) At max. feed force

Mass moment of inertia				
Size		125	160	220
J_0	[kg cm ²]	4,639	14.49	108.99
J_S per metre stroke	[kg cm ² /m]	0.38	1.267	6.269
J_L per kg effective load	[kg cm ² /kg]	2.635	3.96	10.96
J_W Additional slide	[kg cm ²]	3.3	11.734	80.66

The mass moment of inertia J_A of the entire axis is calculated as follows:

$$J_A = J_0 + J_W + J_S \times \text{working stroke [m]} + J_L \times m_{\text{effective load [kg]}}$$

Materials

Sectional view

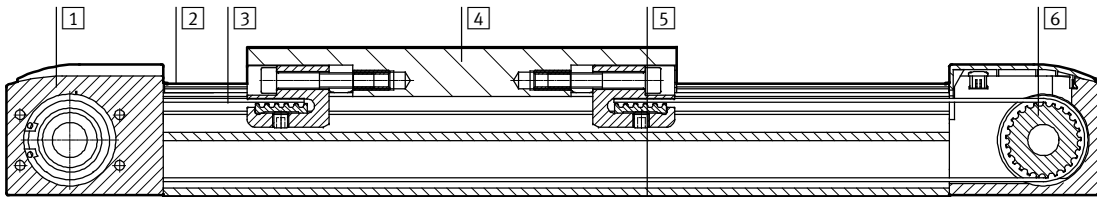

Axis		
1	Drive cover	Anodised wrought aluminium alloy
2	Guide rail	Coated and corrosion-resistant steel
3	Toothed belt	Polychloroprene with glass cord and nylon coating
4	Slide	Anodised wrought aluminium alloy
5	Profile	Anodised wrought aluminium alloy
6	Toothed belt disc	High-alloy stainless steel
Note on materials		Conforms to RoHS
		Contains PWIS (paint-wetting impairment substances)

Toothed belt axes EGC-HD-TB, with heavy-duty guide

Technical data

Characteristic load values

The indicated forces and torques refer to the slide surface. The point of application of force is the point where the centre of the guide and the longitudinal centre of the slide intersect.

These values must not be exceeded during dynamic operation. Special attention must be paid to the cushioning phase.

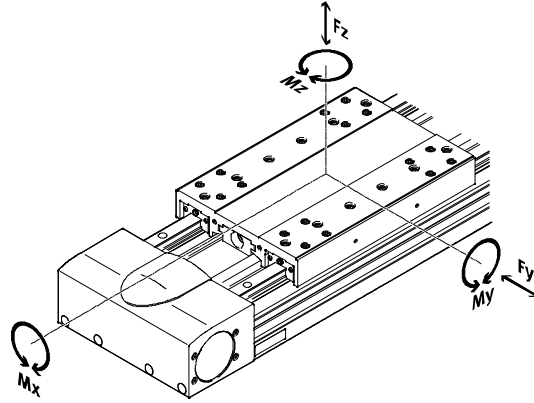

If the axis is subjected to more than two of the indicated forces and torques at the same time, the following equation must be satisfied in addition to the indicated maximum loads:

Calculating the load comparison factor:

$$f_v = \frac{|F_{y,dyn}|}{F_{y,max}} + \frac{|F_{z,dyn}|}{F_{z,max}} + \frac{|M_{x,dyn}|}{M_{x,max}} + \frac{|M_{y,dyn}|}{M_{y,max}} + \frac{|M_{z,dyn}|}{M_{z,max}} \leq 1$$

Permissible forces and torques				
Size		125	160	220
F _{y,max.}	[N]	3,650	5,600	13,000
F _{z,max.}	[N]	3,650	5,600	13,000
M _{x,max.}	[Nm]	140	300	900
M _{y,max.}	[Nm]	275	500	1,450
M _{z,max.}	[Nm]	275	500	1,450

Toothed belt axes EGC-HD-TB, with heavy-duty guide

Technical data

Calculating the service life

The service life of the guide depends on the load. To provide a rough indication of the service life of the guide, the

graph below plots the load comparison factor f_c against the service life.

These values are only theoretical. You must consult with your local contact person at Festo for load comparison factors f_c greater than 1.5.

Load comparison factor f_c as a function of service life

Example:

A user wants to move a load of X kg. Calculation with the formula $\rightarrow 12$ produces a value of 1.5 for the load comparison factor f_c . According to the graph, the guide has a service life of

approx. 1,500 km. Reducing the acceleration reduces the M_z and M_y values. A load comparison factor f_c of 1 now gives a service life of 5,000 km.

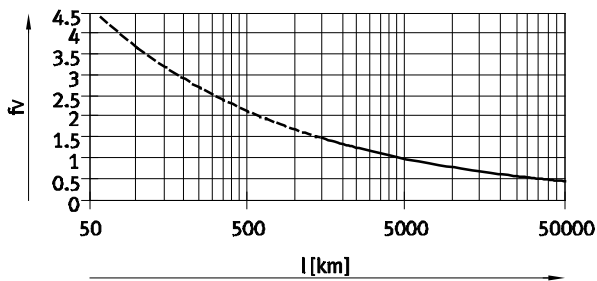

 Note

PositioningDrives
sizing software
www.festo.com

The sizing software can be used to calculate a guide workload for a service life of 5,000 km.

$f_c > 1.5$ are only theoretical comparison values for the recirculating ball bearing guide.

Toothed belt axes EGC-HD-TB, with heavy-duty guide

Technical data

Maximum acceleration a as a function of applied load m

EGC-HD-125

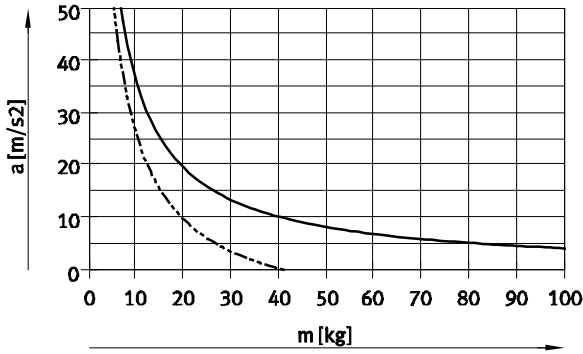

EGC-HD-160

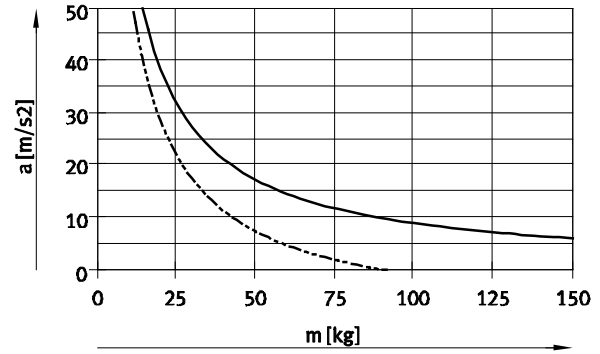

EGC-HD-220

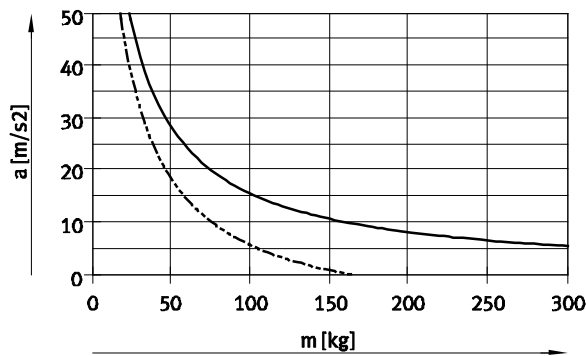

— Horizontal mounting position
 - - - Vertical mounting position

Speed v as a function of rotational speed n

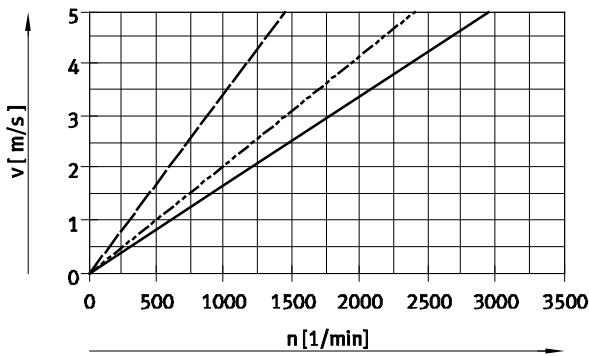

— EGC-HD-125
 - - - EGC-HD-160
 - · - EGC-HD-220

Toothed belt axes EGC-HD-TB, with heavy-duty guide

Technical data

Theoretical feed force F as a function of input torque M

EGC-HD-125

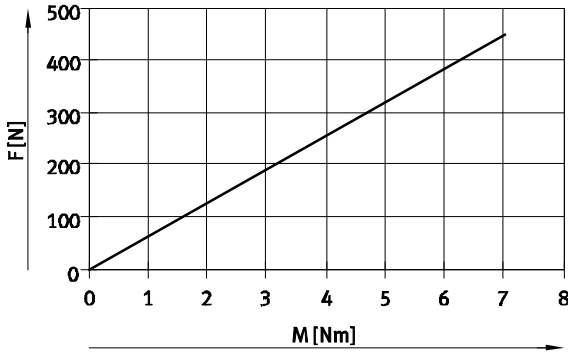

EGC-HD-160

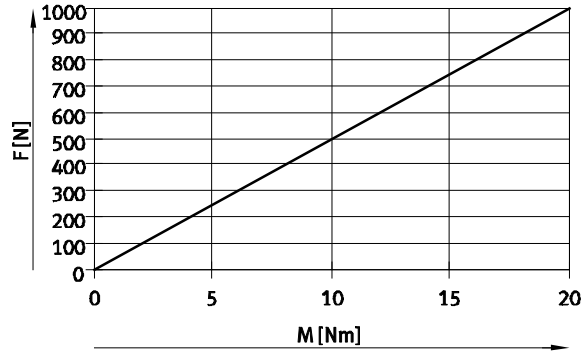

EGC-HD-220

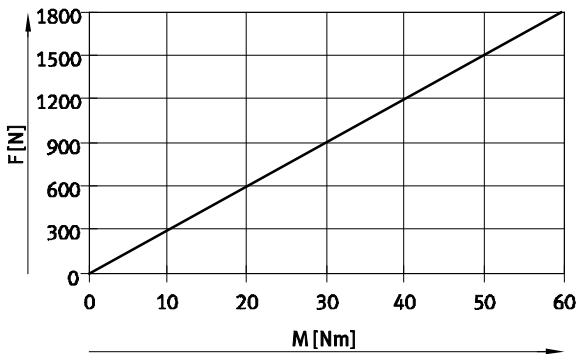

Stroke reserve

Stroke length

The selected stroke corresponds in principle to the required working stroke. The variants GK do not have a long-term lubrication unit on the guide. These variants therefore additionally have a safety distance between the drive cap and slide that is not designated as part of the working stroke.

Stroke reserve

A safety distance (similar to GK) between the drive cap and slide can be defined for the variants GP using the modular product system via the stroke reserve feature. With the variants GK, the stroke reserve and safety distance are added for each end position.

- The stroke reserve length can be freely selected
- The sum of the stroke length and 2x stroke reserve must not exceed the maximum working stroke

Example:

Type:
EGC-HD-125-500-TB-20H-...
Working stroke = 500 mm
2x stroke reserve = 40 mm

Total stroke = 540 mm
(540 mm = 500 mm + 2x 20 mm)

Size	125	160	220
L9 = safety distance with GK [mm] (per end position)	12.5	15.5	20

Toothed belt axes EGC-HD-TB, with heavy-duty guide

Technical data

Working stroke reduction

With standard slide GK/GP with additional slide KL/KR

- With a toothed belt axis with additional slide, the working stroke is reduced by the length of the additional slide L17 and the distance between both slides L18
- If the variant GP is ordered, the additional slide is also protected

L16 = Length of slide
 L17 = Length of additional slide
 L18 = Distance between both slides

Example:
 Type: EGC-HD-220-1000-TB-...-GP-KR
 L18 = 100 mm

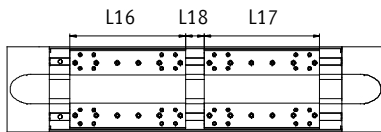

Working stroke = 1,000 mm – 328 mm – 100 mm = 572 mm

Dimensions – Additional slide

Size	125	160	220
Variant	GK	GK	GP
Length L17 [mm]	202	220	250

Working stroke reduction per side

With integrated emergency buffer NPE/shock absorber YSRW with shock absorber retainer EAYH-L2

- With a toothed belt axis, the working stroke is reduced by the total dimension of the emergency buffer/shock absorber and shock absorber retainer.

Size	125	160	220
With emergency buffer [mm]	65	93	98
With shock absorber [mm]	66	94	99

Second moment of area

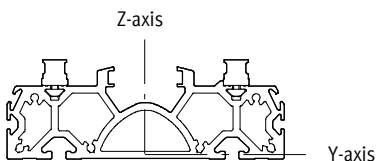

Size	125	160	220
ly [mm ⁴]	6.89x10 ⁵	12.9x10 ⁵	55.8x10 ⁵
lz [mm ⁴]	40.9x10 ⁵	98.9x10 ⁵	351x10 ⁵

Toothed belt axes EGC-HD-TB, with heavy-duty guide

Technical data

Maximum permissible support spacing L (without profile mounting) as a function of force F

In order to limit deflection in the case of large strokes, the axis may need to be supported.

The following graphs help to determine the maximum permissible support spacing L as a function of force F acting on the axis. The deflection is $f = 0.5 \text{ mm}$.

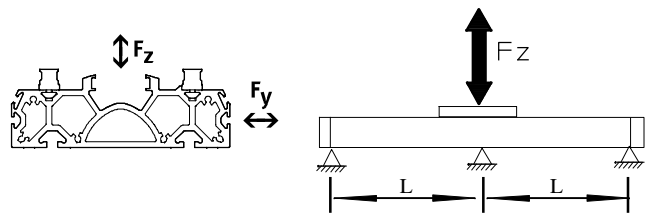

Force Fy

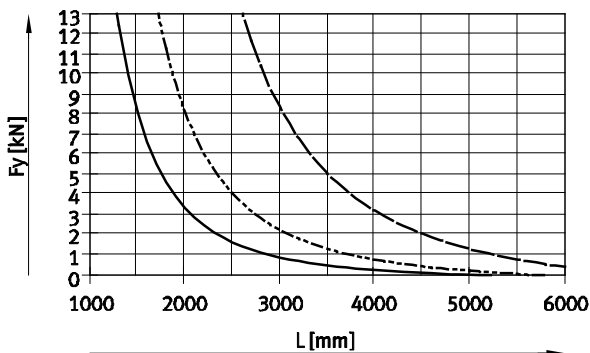

Force Fz

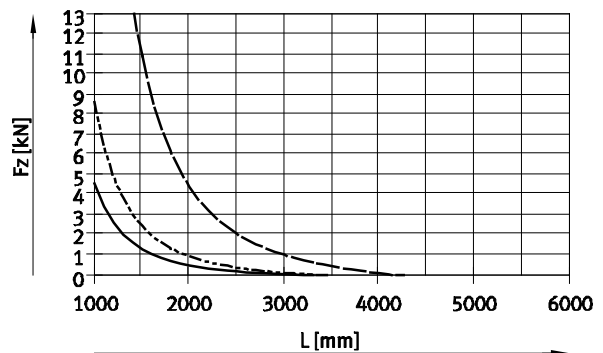

- EGC-HD-125-TB
- - - EGC-HD-160-TB
- · - EGC-HD-220-TB

Recommended deflection limits

Adherence to the following deflection limits is recommended so as not to impair the functional performance of

the axes. Greater deformation can result in increased friction, greater wear and reduced service life.

Size	Dyn. deflection (moving load)	Stat. deflection (stationary load)
125 ... 220	0.05% of the axis length, max. 0.5 mm	0.1% of the axis length

Toothed belt axes EGC-HD-TB, with heavy-duty guide

Technical data

Dimensions

Download CAD data → www.festo.com

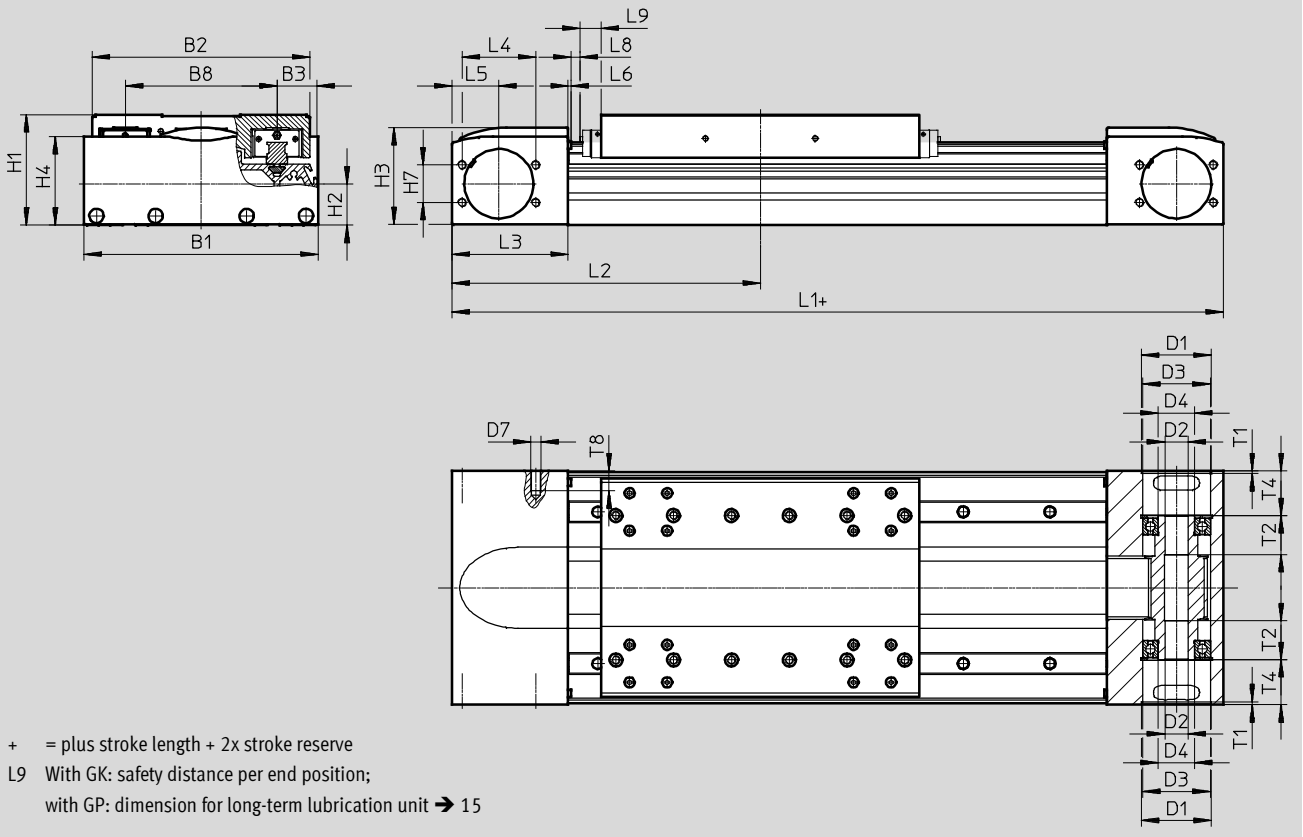

Size	B1	B2	B3	B8	D1 Ø H7	D2 Ø H7	D3 Ø	D4 Ø	D7
125	124	120	21	80	43	16	42	25	M6
160	162	156	27.5	105	48	16	47	25	M6
220	224	216	40	140	80	23	75	45	M8

Size	H1	H2	H3	H4	H7	L1	L2 min.	L3	L4
125	64	26.1	55.8	50.8	24	346	173	57.5	46
160	76.5	28.7	67.5	61.5	26	417	208.5	80.5	51
220	111.5	45.2	98	91.1	59	576	288	115	76

Size	L5	L6	L8	L9	T1	T2	T4	T8
125	27.5	1.8	2	-	2.1	27	23.65	13
160	32.5	2	0.55	14.9	3.1	27	31.1	14
220	50	2	2	18	3.1	29.5	47.5	16

Toothed belt axes EGC-HD-TB, with heavy-duty guide

Technical data

Dimensions Download CAD data → www.festo.com

Profile

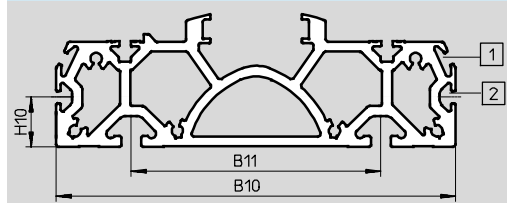

1 Sensor slot for proximity sensor
2 Mounting slot for slot nut

Size	B10	B11	H10
125	122	80	20
160	160	100	20
220	220	140	20

GK – Standard slide

Size 125

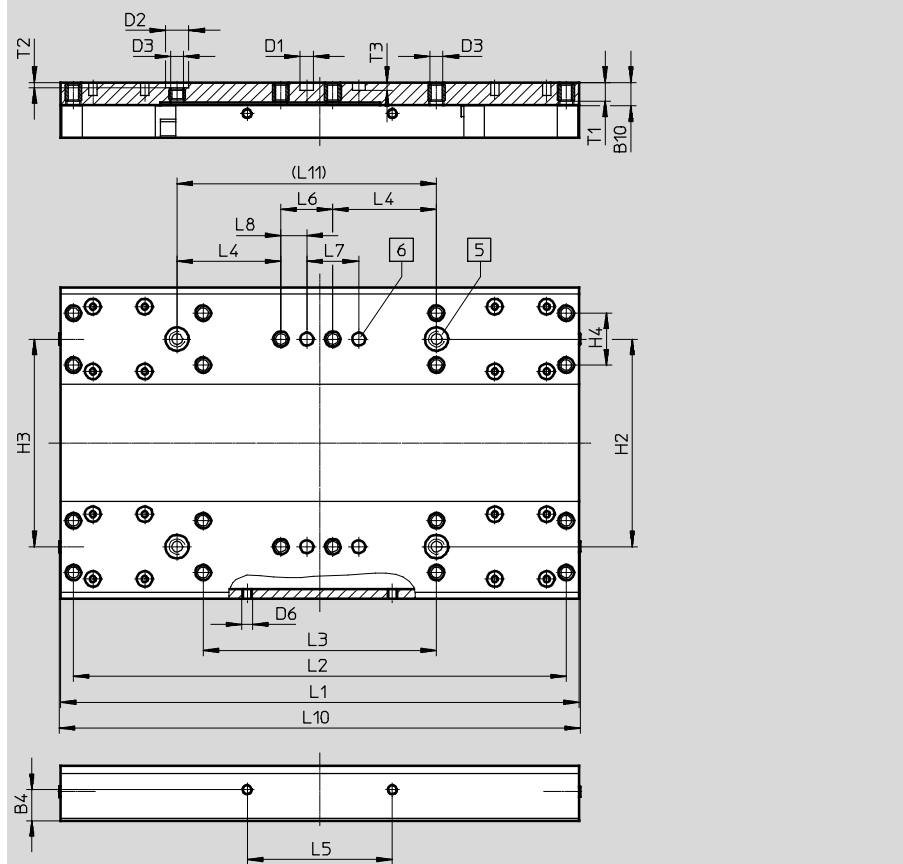

5 Hole for centring sleeve ZBH
6 Hole for centring pin ZBS

Size	B4	B10	D1	D2	D3	D6	H2	H3	H4	L1	L2	L3
	±0.1		∅ H7	∅ H7			±0.03	±0.05	±0.1	±0.1	±0.2	±0.1
125	12	9	5	9	M5	M4	80	80	20	200	190	90

Size	L4	L5	L6	L7	L8	L10	L11	T1	T2	T3
	±0.1	±0.2	±0.1	±0.03	±0.1		±0.03		+0.1	+0.1
125	40	56	20	20	10	202	100	7.8	2.1	3.1

Toothed belt axes EGC-HD-TB, with heavy-duty guide

Technical data

Dimensions

Download CAD data → www.festo.com

GK – Standard slide/GP – Standard slide, protected

Size 160

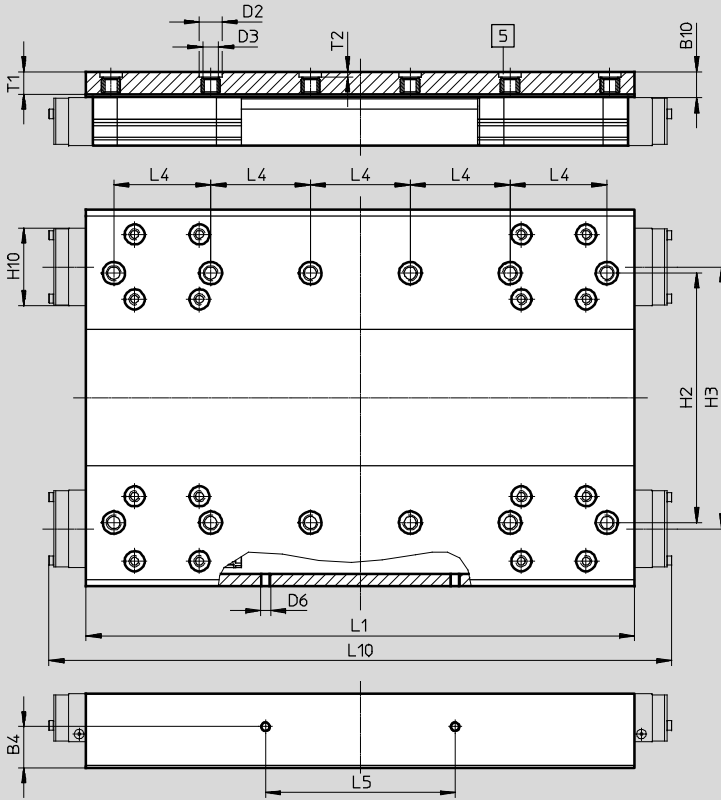

5 Hole for centring sleeve ZBH

Size	B4	B10 ^{*)}	D2 ∅ H7	D3	D6	H2 ±0.03	H3 ±0.05
160	16.5	10.5	9	M6	M4	100	105

Size	H10 ^{*)}	L1 ±0.1	L4 ±0.03	L5 ±0.1	L10 ^{*)}	T1	T2 +0.1
160	31	220	40	76	250	9	2.1

^{*)} Protected version

Toothed belt axes EGC-HD-TB, with heavy-duty guide

Technical data

Dimensions

Download CAD data → www.festo.com

GK – Standard slide/GP – Standard slide, protected

Size 220

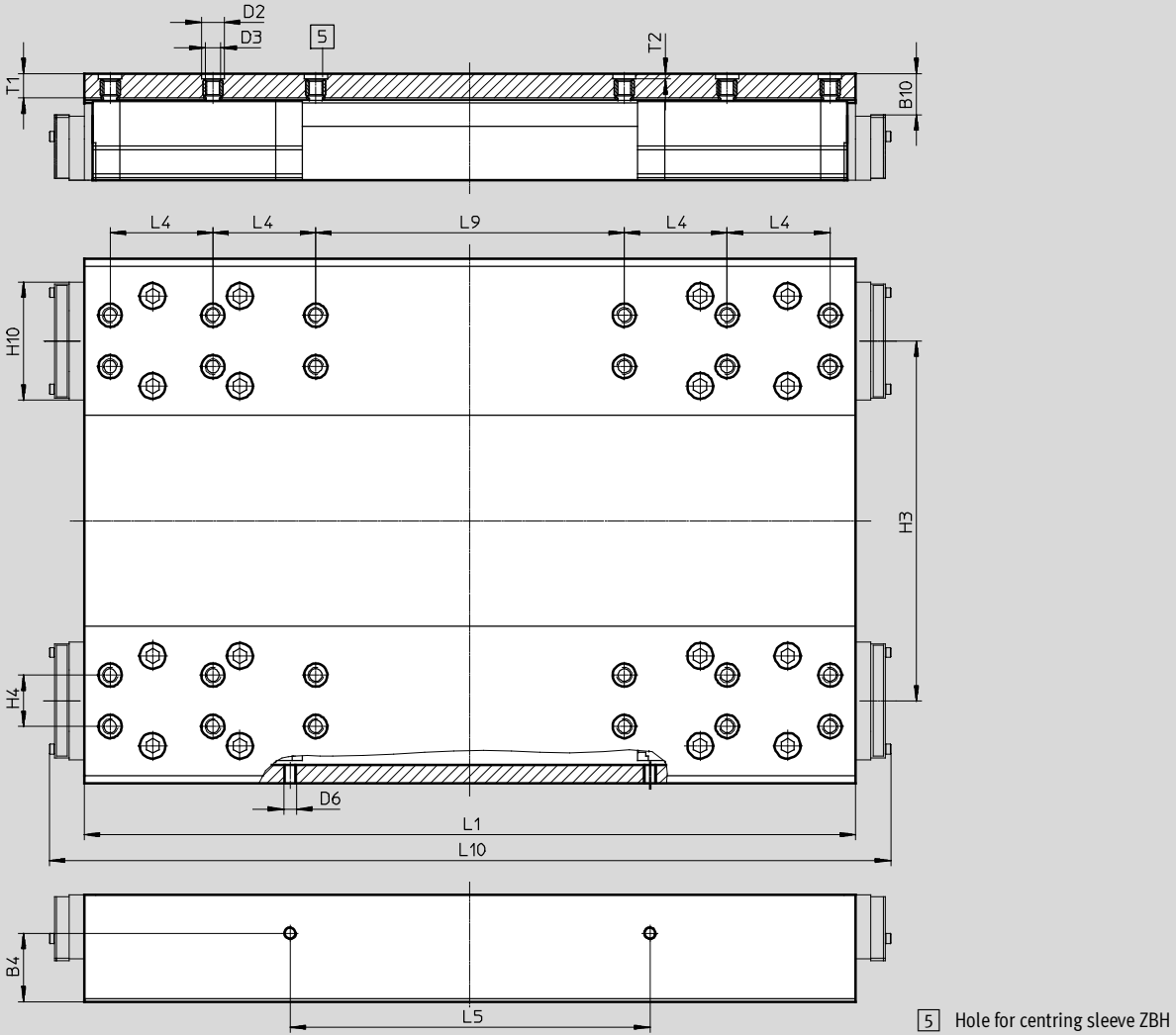

Size	B4	B10 ^{*)}	D2 ∅ H7	D3	D6	H3	H4	H10 ^{*)}
220	±0.1	16	9	M6	M5	±0.05	±0.03	45.95

Size	L1	L4	L5	L9	L10 ^{*)}	T1	T2
220	±0.1	±0.03	±0.1	±0.03	328	9.5	+0.1

^{*)} Protected version

Toothed belt axes EGC-HD-TB, with heavy-duty guide

Ordering data – Modular products

Order code

Mandatory data

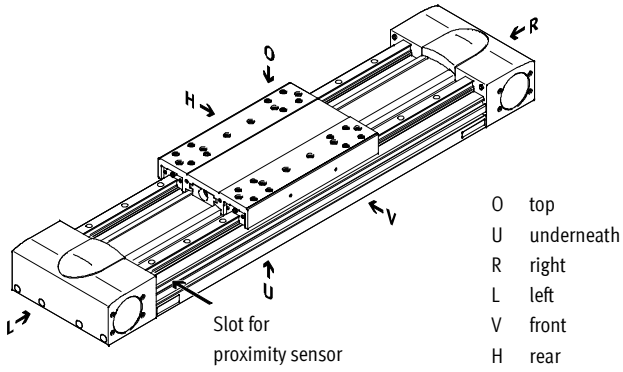

- O top
- U underneath
- R right
- L left
- V front
- H rear

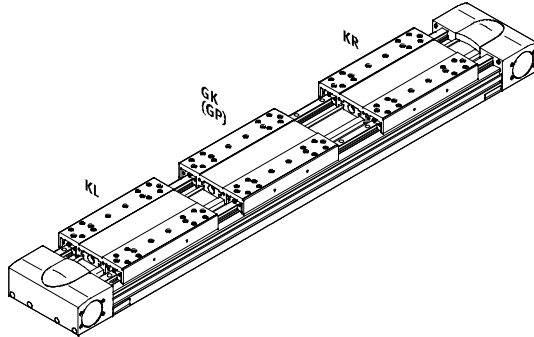

Accessories

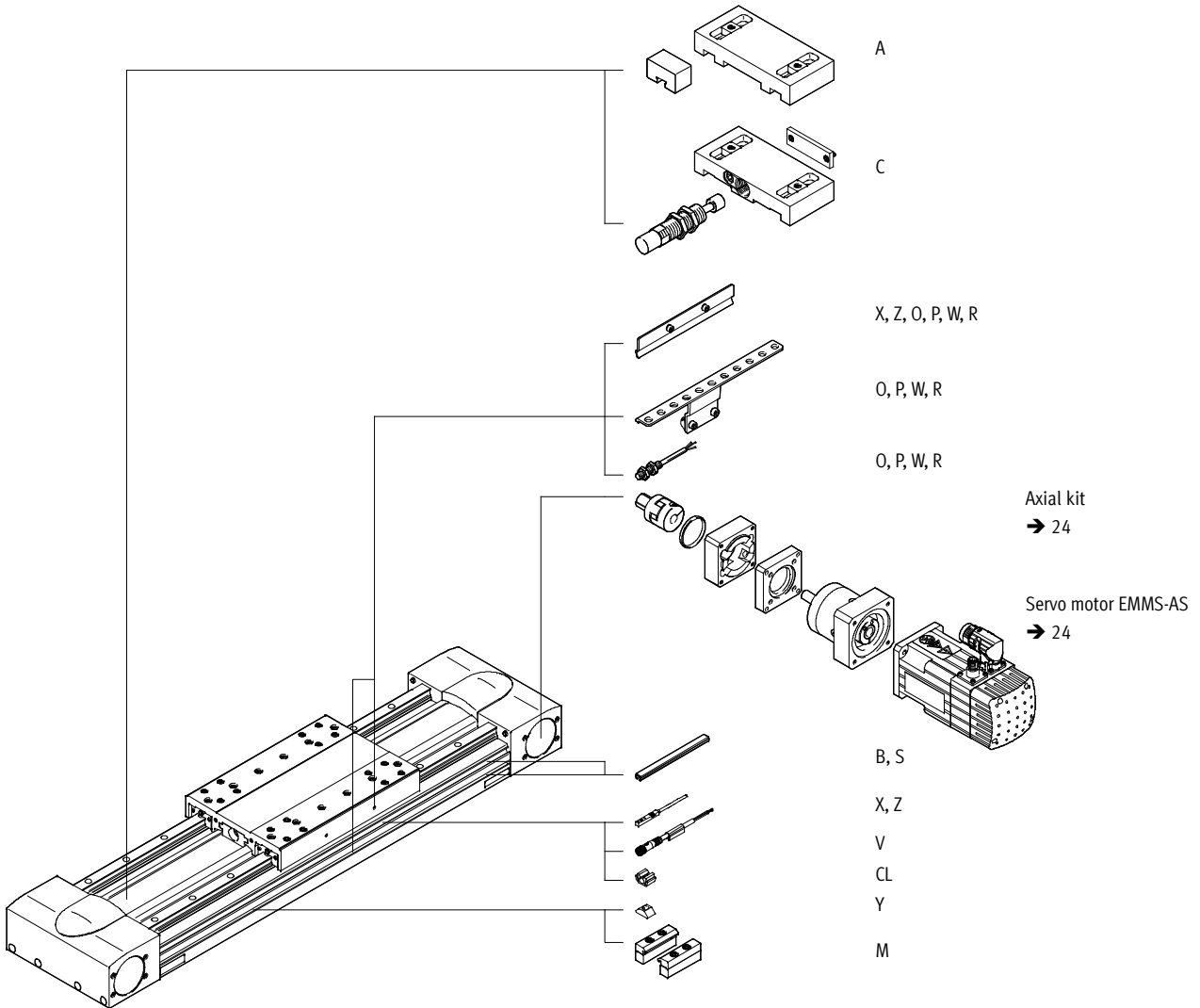

Toothed belt axes EGC-HD-TB, with heavy-duty guide

Ordering data – Modular products

Ordering table		125	160	220	Condi- tions	Code	Enter code
M	Module No.	556823	556824	556825			
	Design	Linear axis				EGC	EGC
	Guide	Heavy-duty guide				-HD	-HD
	Size	125	160	220		-...	-...
	Stroke [mm]	50 ... 3,000	50 ... 5,000	50 ... 4,750	1	-...	-...
	Function	Toothed belt				-TB	-TB
	Stroke reserve [mm]	0 ... 999 (0 = no stroke reserve)			1	-... H	
	Slide	Standard slide				-GK	
		-	Standard slide, protected			-GP	
O	Additional slide	Left	Additional slide, standard, on left		2	-KL	
		Right	Additional slide, standard, on right		2	-KR	
	Accessories	Accessories enclosed separately				ZUB-	ZUB-
	Profile mounting	1 ... 50				...M	
	Cover	Mounting slot	1 ... 50 (1 = 2x 500 mm pieces)		4	...B	
		Sensor slot	1 ... 50			...S	
	Slot nut for mounting slot	1 ... 99			4	...Y	
	Proximity sensor (SIES), inductive, slot type 8, PNP, incl. switch lug	N/O contact, 7.5 m cable	1 ... 6			...X	
		N/C contact, 7.5 m cable	1 ... 6			...Z	
	Emergency buffer with retainer	1 ... 2			3	...A	
	Shock absorber with retainer	1 ... 2			3	...C	
	Proximity sensor (SIEN), inductive, M8, PNP, incl. switch lug with sensor bracket	N/O contact, 2.5 m cable	1 ... 99			...O	
		N/C contact, 2.5 m cable	1 ... 99			...P	
	Connecting cable, M8, 3-wire, 2.5 m	N/O contact, plug M8	1 ... 99			...W	
		N/C contact, plug M8	1 ... 99			...R	
	Cable clip	10, 20, 30, 40, 50, 60, 70, 80, 90				...CL	
	Operating instructions	Express waiver - no user documentation to be included (already available) (operating instructions in PDF format are available free of charge on the Internet at http://www.festo.com)				-DN	

- 1** -... The sum of the stroke length in mm and 2x the stroke reserve in mm must not exceed the maximum stroke length in mm.
- 2** **KL, KR** If the protected slide variant (GP) is selected, then the additional slide (KL, KR) is also protected.
- 3** ... **A**, ... **C** Cannot be combined with slide GP.
- 4** **B, Y** Scope of delivery with size 160 for both slot sizes (→ 30).

Order code



	EGC	-	HD	-		-		-	TB	-		-		-		-	
--	------------	---	-----------	---	--	---	--	---	-----------	---	--	---	--	---	--	---	--

Toothed belt axes EGC-HD-TB, with heavy-duty guide

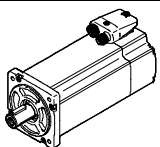
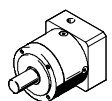
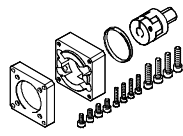
Accessories

Permissible axis/motor combinations with axial kit – With gear unit		Technical data → Internet: eamm-a	
Motor	Gear unit	Axial kit	
			
Type	Type	Part No.	Type
EGC-HD-125			
With servo motor			
EMMS-AS-55-...	EMGA-60-P-G...-SAS-55	1190076	EAMM-A-M43-60G
EMMS-AS-70-...	EMGA-60-P-G...-SAS-70	1190076	EAMM-A-M43-60G
With stepper motor			
EMMS-ST-57-...	EMGA-60-P-G...-SST-57	1190076	EAMM-A-M43-60G
EGC-HD-160			
With servo motor			
EMMS-AS-70-...	EMGA-80-P-G...-SAS-70	1190421	EAMM-A-M48-80G
EMME-AS-80-...	EMGA-80-P-G...-EAS-80	1190421	EAMM-A-M48-80G
EMME-AS-100-...	EMGA-80-P-G...-SAS-100	1190421	EAMM-A-M48-80G
EMMS-AS-100-...	EMGA-80-P-G...-SAS-100	1190421	EAMM-A-M48-80G
With stepper motor			
EMMS-ST-87-...	EMGA-80-P-G...-SST-87	1190421	EAMM-A-M48-80G
EGC-HD-220			
With servo motor			
EMMS-AS-100-...	EMGA-120-P-G...-SAS-100	1190774	EAMM-A-M80-120G
EMMS-AS-140-...	EMGA-120-P-G...-SAS-140	1190774	EAMM-A-M80-120G

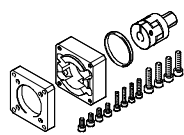
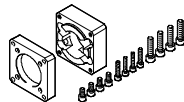
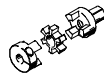
 **Note**
 For the optimum selection of axis/
 motor combinations → www.festo.com
 PositioningDrives
 sizing software

Component parts of the axial kit			
Axial kit	Comprising:		
	Motor flange	Coupling	Centring ring
			
Part No. Type	Part No. Type	Part No. Type	Part No. Type
EGC-HD-125			
1190076 EAMM-A-M43-60G	1597579 EAMF-A-43D-60G	558001 EAMD-32-32-11-16X20	575962 EAML-43-4-43
EGC-HD-160			
1190421 EAMM-A-M48-80G	1190375 EAMF-A-48C-80G	1781043 EAMD-42-40-20-16X25-U	558031 EAML-48-4-48
EGC-HD-220			
1190774 EAMM-A-M80-120G	1190702 EAMF-A-80A-120G	1781045 EAMD-56-46-25-23X27-U	1209006 EAML-80-6-80

Toothed belt axes EGC-HD-TB, with heavy-duty guide

Accessories

Profile mounting MUE
(order code M)

Material:
Anodised aluminium
Conforms to RoHS

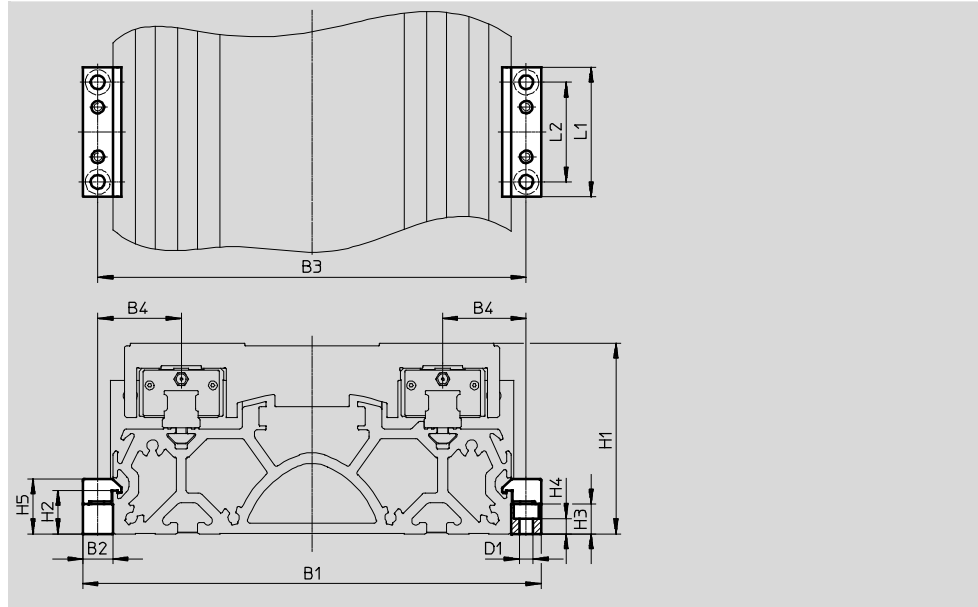

Dimensions and ordering data								
For size	B1	B2	B3	B4	D1 Ø	H1	H2	H3
125	146	12	134	27	5.5	64	17.5	12
160	184	12	172	33.5	5.5	76.5	17.5	12
220	258	19	239	49.5	9	111.5	16	14

For size	H4	H5	L1	L2	Weight [g]	Part No.	Type
125	6.2	22	52	40	80	558043	MUE-70/80
160	6.2	22	52	40	80	558043	MUE-70/80
220	5.5	29.5	90	40	290	558044	MUE-120/185

Toothed belt axes EGC-HD-TB, with heavy-duty guide

Accessories

Shock absorber retainer, retainer
EAYH

Emergency buffer NPE → 28
Shock absorber YSRW → 28
(order code A or C)

Material:
Anodised aluminium
Conforms to RoHS

Cannot be used in combination with
the variants GP.

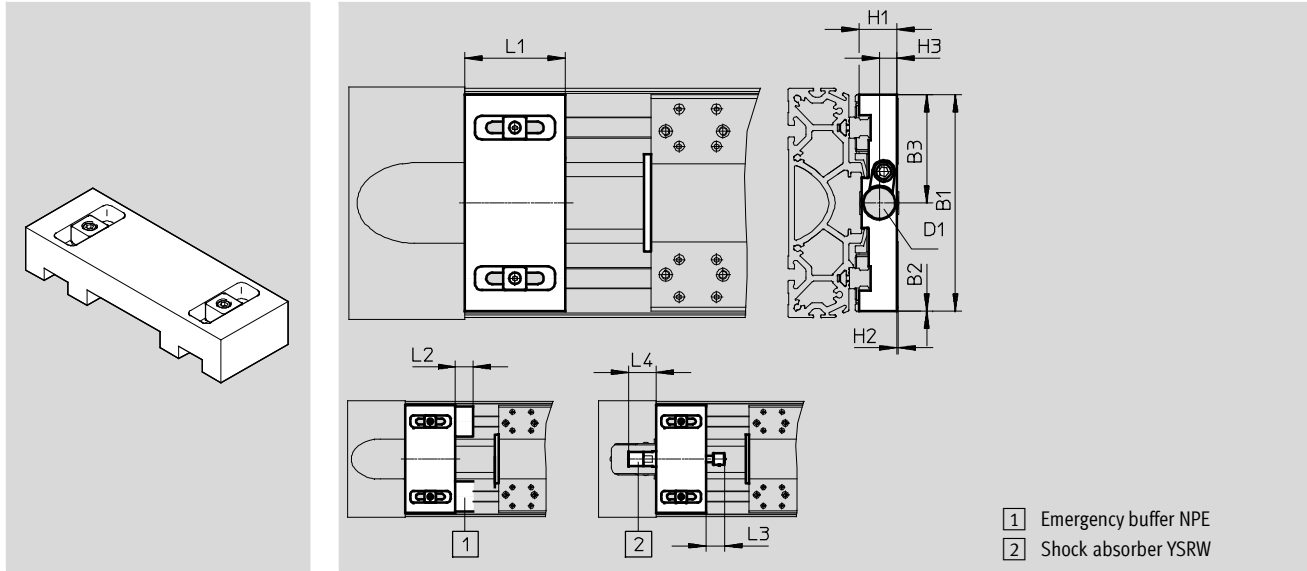

Dimensions and ordering data														
For size	B1	B2	B3	D1	H1	H2	H3	L1	L2	L3	L4 min.	Weight [g]	Part No.	Type
Shock absorber retainer														
125	120	0	60	M16x1	19.8	0.4	9.7	50	-	20	31	286	1653251	EAYH-L2-125
160	150.7	2.65	75.3	M22x1.5	26.2	0.8	12.2	70	-	26	38.5	622	1653250	EAYH-L2-160
220	204	6	102	M26x1.5	38.7	0.1	15	70	-	34	63.5	1,218	1653253	EAYH-L2-220
Retainer for emergency buffer														
125	120	0.2	-	-	19.8	0.9	-	45	17	-	-	260	1662803	EAYH-L2-125-N
160	150.7	-	-	-	26.2	0.4	-	60	25	-	-	617	1669259	EAYH-L2-160-N
220	204	0.5	-	-	38.7	0.9	-	75	30	-	-	1,195	1669260	EAYH-L2-220-N

Switch lug SF-EGC-HD-1

for sensing via proximity sensor
SIES-8M
(order code X or Z)

Material:
Galvanised steel
Conforms to RoHS

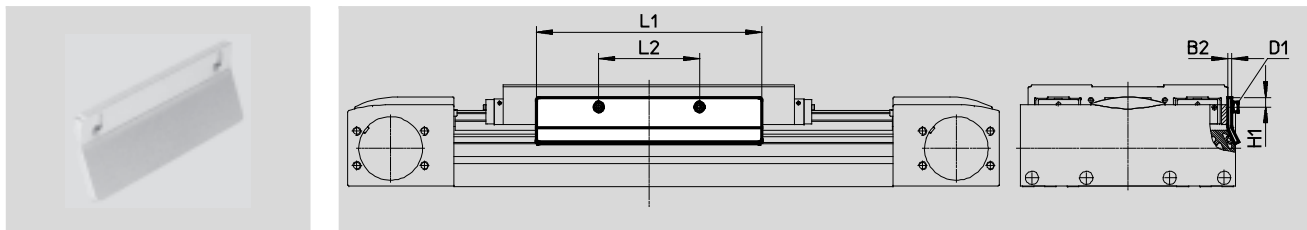

Dimensions and ordering data								
For size	B2	D1	H1	L1	L2	Weight [g]	Part No.	Type
125	2	M4x8	7.8	150	56	70	570027	SF-EGC-HD-1-125
160	3	M4x8	7.3	170	76	160	1645872	SF-EGC-HD-1-160
220	3	M5x10	11.5	250	140	310	1645866	SF-EGC-HD-1-220

Toothed belt axes EGC-HD-TB, with heavy-duty guide

Accessories

Switch lug SF-EGC-HD-2

For sensing via proximity sensor
SIEN-M8B (order code O, P, W or R) or
SIES-8M (order code X or Z)

Material:
Galvanised steel
Conforms to RoHS



Sensor bracket HWS-EGC

For proximity sensor SIEN-M8B
(order code O, P, W or R)

Material:
Galvanised steel
Conforms to RoHS

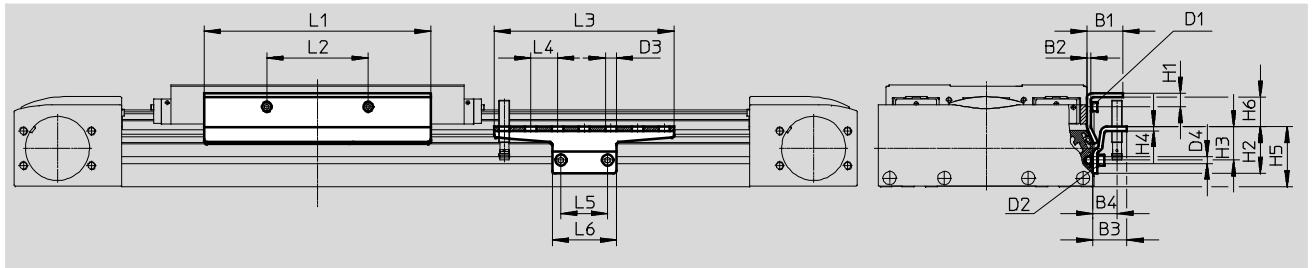

Dimensions and ordering data										
For size	B1	B2	B3	B4	D1	D2	D3 Ø	D4 Ø	H1	H2
125	24	2	25.5	18	M4x8	M5x8	8.4	5.2	9	35
160	27	3	25.5	18	M4x8	M5x8	8.4	5.2	10.3	35
220	31	3	25.5	18	M5x10	M5x14	8.4	5.2	11.5	65





For size	H3	H4	H5	H6	L1	L2	L3	L4	L5	L6
125	25	3	45	14	150	56	135	20	35	48
160	25	3	45	22.2	170	76	135	20	35	48
220	55	3	75	18.4	250	140	215	20	35	48

For size	Weight [g]	Part No.	Type
Switch lug			
125	122	570030	SF-EGC-HD-2-125
160	261	1645865	SF-EGC-HD-2-160
220	430	1645868	SF-EGC-HD-2-220

For size	Weight [g]	Part No.	Type
Sensor bracket			
125	110	558057	HWS-EGC-M5
160	110	558057	HWS-EGC-M5
220	217	570365	HWS-EGC-M8-B

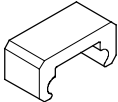
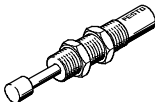
Toothed belt axes EGC-HD-TB, with heavy-duty guide

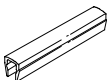
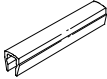
Accessories



Ordering data						
	For size	Remark	Order code	Part No.	Type	PU ¹⁾
Emergency buffer NPE						
	125	Use in combination with retainer EAYH	A	1662475	NPE-125	1
	160			1672593	NPE-160	
	220			1672598	NPE-220	
Shock absorber YSRW Technical data → Internet: ysrw						
	125	Use in combination with shock absorber retainer EAYH	C	191196	YSRW-12-20	1
	160			191197	YSRW-16-26	
	220			191198	YSRW-20-34	
Slot nut NST						
	125, 160 ³⁾	For mounting slot	Y	150914	NST-5-M5	1
	160 ⁴⁾ , 220			150915	NST-8-M6	
Centring pin/sleeve ZBS/ZBH²⁾						
	125	For slide	-	150928	ZBS-5	10
	125 ... 220			150927	ZBH-9	
Slot cover ABP						
	125, 160 ³⁾	For mounting slot every 0.5 m	B	151681	ABP-5	2
	160 ⁴⁾ , 220			151682	ABP-8	
Slot cover ABP-S						
	125 ... 220	For sensor slot every 0.5 m	S	563360	ABP-5-S1	2
Clip SMBK						
	125 ... 220	For sensor slot, for attaching the proximity sensor cables	CL	534254	SMBK-8	10

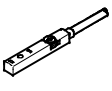
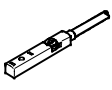

- 1) Packaging unit
- 2) 2 centring pins/sleeves included in the scope of delivery of the axis
- 3) For mounting slot at side
- 4) For mounting slot underneath

Toothed belt axes EGC-HD-TB, with heavy-duty guide

Accessories

Ordering data – Proximity sensors for T-slot, inductive							Technical data → Internet: sies	
	Type of mounting	Electrical connection	Switching output	Cable length [m]	Order code	Part No.	Type	
N/O contact								
	Insertable in the slot from above, flush with the cylinder profile	Cable, 3-wire	PNP	7.5	X	551386	SIES-8M-PS-24V-K-7,5-OE	
		Plug M8x1, 3-pin		0.3	–	551387	SIES-8M-PS-24V-K-0,3-M8D	
		Cable, 3-wire	NPN	7.5	–	551396	SIES-8M-NS-24V-K-7,5-OE	
		Plug M8x1, 3-pin		0.3	–	551397	SIES-8M-NS-24V-K-0,3-M8D	
N/C contact								
	Insertable in the slot from above, flush with the cylinder profile	Cable, 3-wire	PNP	7.5	Z	551391	SIES-8M-PO-24V-K-7,5-OE	
		Plug M8x1, 3-pin		0.3	–	551392	SIES-8M-PO-24V-K-0,3-M8D	
		Cable, 3-wire	NPN	7.5	–	551401	SIES-8M-NO-24V-K-7,5-OE	
		Plug M8x1, 3-pin		0.3	–	551402	SIES-8M-NO-24V-K-0,3-M8D	

Ordering data – Proximity sensors M8 (round design), inductive							Technical data → Internet: sien	
	Electrical connection	LED	Switching output	Cable length [m]	Order code	Part No.	Type	
N/O contact								
	Cable, 3-wire	■	PNP	2.5	O	150386	SIEN-M8B-PS-K-L	
	Plug M8x1, 3-pin	■	PNP	–	W	150387	SIEN-M8B-PS-S-L	
N/C contact								
	Cable, 3-wire	■	PNP	2.5	P	150390	SIEN-M8B-PO-K-L	
	Plug M8x1, 3-pin	■	PNP	–	R	150391	SIEN-M8B-PO-S-L	

Ordering data – Connecting cables					Technical data → Internet: nebu	
	Electrical connection, left	Electrical connection, right	Cable length [m]	Part No.	Type	
	Straight socket, M8x1, 3-pin	Cable, open end, 3-wire	2.5	159420	SIM-M8-3GD-2,5-PU	
			2.5	541333	NEBU-M8G3-K-2.5-LE3	
			5	541334	NEBU-M8G3-K-5-LE3	
	Angled socket, M8x1, 3-pin	Cable, open end, 3-wire	2.5	541338	NEBU-M8W3-K-2.5-LE3	
			5	541341	NEBU-M8W3-K-5-LE3	