

Spindle axes EGC-HD-BS, with heavy-duty guide

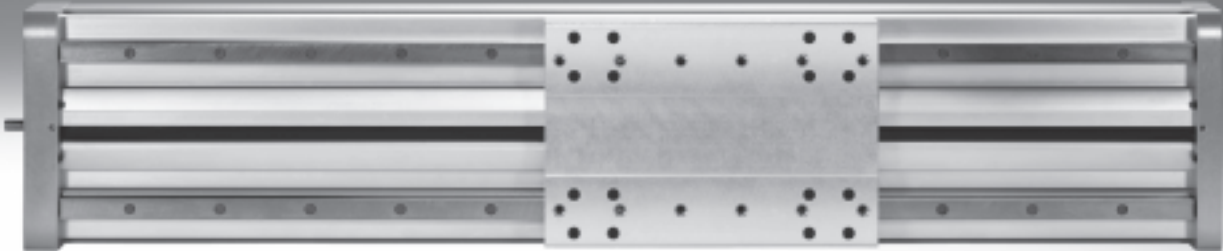

Electromechanical drives

Selection aid



Overview of toothed belt and spindle axes

Toothed belt axes

- Speeds of up to 10 m/s
- Acceleration of up to 50 m/s²
- Repetition accuracy of up to ±0.08 mm
- Strokes of up to 8,500 mm (longer strokes on request)
- Flexible motor mounting

Spindle axes

- Speeds of up to 2 m/s
- Acceleration of up to 20 m/s²
- Repetition accuracy of up to ±0.003 mm
- Strokes of up to 3,000 mm

Coordinate system

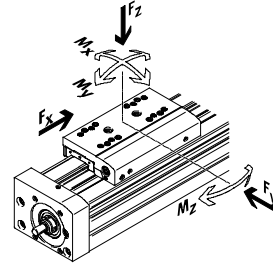

Toothed belt axes

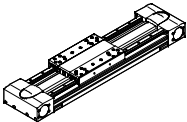
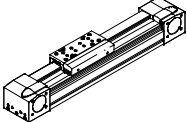
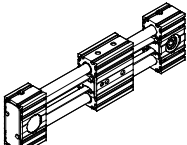
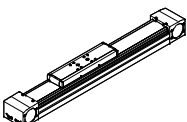
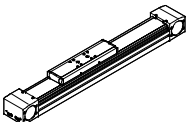
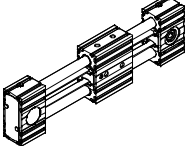
Type	F _x [N]	v [m/s]	M _x [Nm]	M _y [Nm]	M _z [Nm]	Properties
Heavy-duty recirculating ball bearing guide						
EGC-HD-TB						
	450	3	140	275	275	<ul style="list-style-type: none"> • Flat drive unit with rigid, closed profile • Precision, resilient DUO guide rail • Ideal as a basic axis for linear gantries and cantilever axes
	1,000	5	300	500	500	
	1,800	5	900	1,450	1,450	
Recirculating ball bearing guide						
EGC-TB-KF						
	50	3	3.5	10	10	<ul style="list-style-type: none"> • Rigid, closed profile • Precision, resilient guide rail • Small drive pinions reduce necessary driving torque • Space-saving position sensing
	100	5	16	132	132	
	350	5	36	228	228	
	800	5	144	680	680	
	2,500	5	529	1,820	1,820	
ELGR-TB						
	50	3	2.5	20	20	<ul style="list-style-type: none"> • Cost-optimised rod guide • Ready-to-install unit • Resilient ball bearings for dynamic operation
	100	3	5	40	40	
	350	3	15	124	124	
Roller bearing guide						
ELGA-TB-RF						
	350	10	11	40	40	<ul style="list-style-type: none"> • Sturdy roller bearing guide • Guide and toothed belt protected by cover strip • Speeds of up to 10 m/s • Lower weight than axes with guide rails
	800	10	30	180	180	
	1 300	10	100	640	640	
Plain-bearing guide						
ELGA-TB-G						
	350	5	5	30	10	<ul style="list-style-type: none"> • Guide and toothed belt protected by cover strip • For simple handling tasks • As an actuator for external guides • Insensitive to harsh environmental conditions
	800	5	10	60	20	
	1,300	5	120	120	40	
ELGR-TB-GF						
	50	1	1	10	10	<ul style="list-style-type: none"> • Cost-optimised rod guide • Ready-to-install unit • Heavy-duty plain bearings for use in harsh environmental conditions
	100	1	2.5	20	20	
	350	1	1	40	40	

Electromechanical drives

Selection aid

Overview of toothed belt and spindle axes

Toothed belt axes

- Speeds of up to 10 m/s
- Acceleration of up to 50 m/s²
- Repetition accuracy of up to ±0.08 mm
- Strokes of up to 8,500 mm (longer strokes on request)
- Flexible motor mounting

Spindle axes

- Speeds of up to 2 m/s
- Acceleration of up to 20 m/s²
- Repetition accuracy of up to ±0.003 mm
- Strokes of up to 3,000 mm

Coordinate system

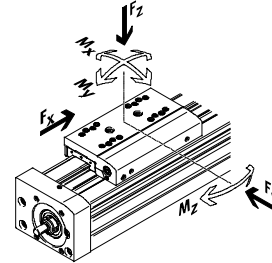

Spindle axes

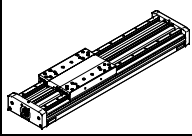
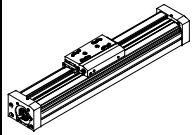
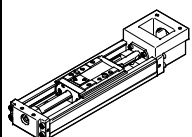
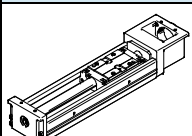
Type	F_x [N]	v [m/s]	M_x [Nm]	M_y [Nm]	M_z [Nm]	Properties
Heavy-duty recirculating ball bearing guide						
EGC-HD-BS						
	300 600 1,300	0.5 1.0 1.5	140 300 900	275 500 1,450	275 500 1,450	<ul style="list-style-type: none"> • Flat drive unit with rigid, closed profile • Precision, resilient DUO guide rail • Ideal as a basic axis for linear gantries and cantilever axes
Recirculating ball bearing guide						
EGC-BS-KF						
	300 600 1,300 3,000	0.5 1.0 1.5 2.0	16 36 144 529	132 228 680 1,820	132 228 680 1,820	<ul style="list-style-type: none"> • Rigid, closed profile • Precision, resilient guide rail • For extremely high requirements for speed, acceleration and torque resistance • Space-saving position sensing
EGSK						
	57 133 184 239 392	0.33 1.10 0.83 1.10 1.48	13 28.7 60 79.5 231	3.7 9.2 20.4 26 77.3	3.7 9.2 20.4 26 77.3	<ul style="list-style-type: none"> • Spindle axes with maximum precision, compactness and rigidity • Recirculating ball bearing guide and ball screw without caged ball bearings • Standard designs in stock
EGSP						
	112 212 466 460	0.6 0.6 2.0 2.0	36.3 81.5 90.3 258	12.5 31.6 32.1 94	12.5 31.6 32.1 94	<ul style="list-style-type: none"> • Spindle axes with maximum precision, compactness and rigidity • Recirculating ball bearing guide with caged ball bearings • Ball screw sizes 33, 46 with caged ball bearings

Spindle axes EGC-HD-BS, with heavy-duty guide

Key features

At a glance

- New heavy-duty guide for:
 - Maximum loads and torques
 - High feed forces and speeds
 - Long service life
- Precision, resilient DUO guide rail
- Ideal as a basic axis for linear gantries and cantilever axes
- The spindle axis with integrated ball screw combines high precision and flexible spindle pitches
- In addition to its technical data, the spindle axis also offers an excellent price/performance ratio
- Space-saving position sensing with proximity sensor in the profile slot
- Wide range of options for mounting on drives
- Spindle support enables maximum travel speed with all stroke lengths

Flat unit with rigid, closed profile

EGC-HD-125

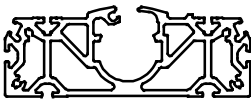

EGC-HD-160

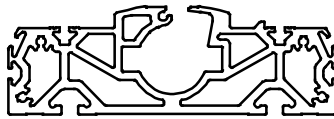

EGC-HD-220

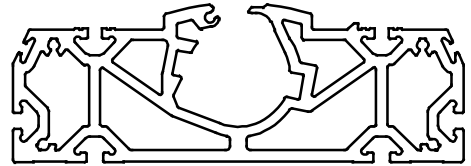

Characteristic values of the axes

The specifications shown in the table are maximum values.

The precise values for each of the variants can be found in the relevant technical data section.

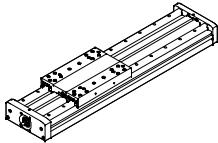
Version	Size	Working stroke [mm]	Speed [m/s]	Repetition accuracy [mm]	Feed force [N]	Guide characteristics				
						Forces and torques				
						Fy [N]	Fz [N]	Mx [Nm]	My [Nm]	Mz [Nm]
Recirculating ball bearing guide										
	125	50 ... 900	0.5	±0.02	300	3,650	3,650	140	275	275
	160	50 ... 1,900	1	±0.02	600	5,600	5,600	300	500	500
	220	50 ... 2,400	1.5	±0.02	1,300	13,000	13,000	900	1,450	1,450

 **Note**

PositioningDrives
sizing software
www.festo.com

Spindle axes EGC-HD-BS, with heavy-duty guide

Key features

Slide variants

Standard slide



Standard slide, protected



With additional slide



Complete system comprising spindle axis, motor, motor controller and motor mounting kit

Spindle axis with recirculating ball bearing guide



Axial kit



Parallel kit



Motor

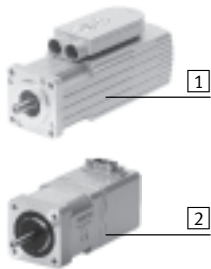

- 1 Servo motor EMMS-AS
- 2 Stepper motor EMMS-ST

Motor controller

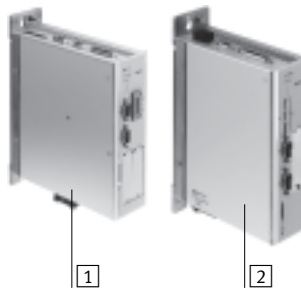

- 1 Servo motor controller CMMP-AS, CMMS-AS
- 2 Stepper motor controller CMMS-ST

Note

A range of specially adapted complete solutions is available for the spindle axis EGC and the motors.

Spindle axes EGC-HD-BS, with heavy-duty guide

Type codes

	EGC	-	HD	-	160	-	500	-	BS	-	10	-		-	20	-	GK
Type																	
EGC	Spindle axis																
Guide																	
HD	Heavy-duty guide																
Size																	
Stroke [mm]																	
Drive function																	
BS	Spindle																
Spindle pitch																	
Spindle support																	
-	None																
S	With spindle support																
Stroke reserve																	
Slide																	
GK	Standard slide																
GP	Standard slide, protected																

Spindle axes EGC-HD-BS, with heavy-duty guide

Type codes

→			ZUB	2MX2Z	DN
Additional slide					
KL	Standard, left				
Additional slide					
KR	Standard, right				
Accessories enclosed separately					
...M	Profile mounting				
...B	Mounting slot cover				
...S	Sensor slot cover				
...Y	Slot nut for mounting slot				
...X	Proximity sensor (SIES), inductive, slot type 8, PNP, N/O contact, 7.5 m cable				
...Z	Proximity sensor (SIES), inductive, slot type 8, PNP, N/C contact, 7.5 m cable				
...A	Emergency buffer with retainer				
...O	Proximity sensor (SIEN), inductive, M8, PNP, N/O contact, 2.5 m cable				
...P	Proximity sensor (SIEN), inductive, M8, PNP, N/C contact, 2.5 m cable				
...W	Proximity sensor (SIEN), inductive, M8, PNP, N/O contact, plug M8				
...R	Proximity sensor (SIEN), inductive, M8, PNP, N/C contact, plug M8				
...V	Connecting cable				
...CL	Cable clip				
Operating instructions					
DN	None				

Spindle axes EGC-HD-BS, with heavy-duty guide

Peripherals overview

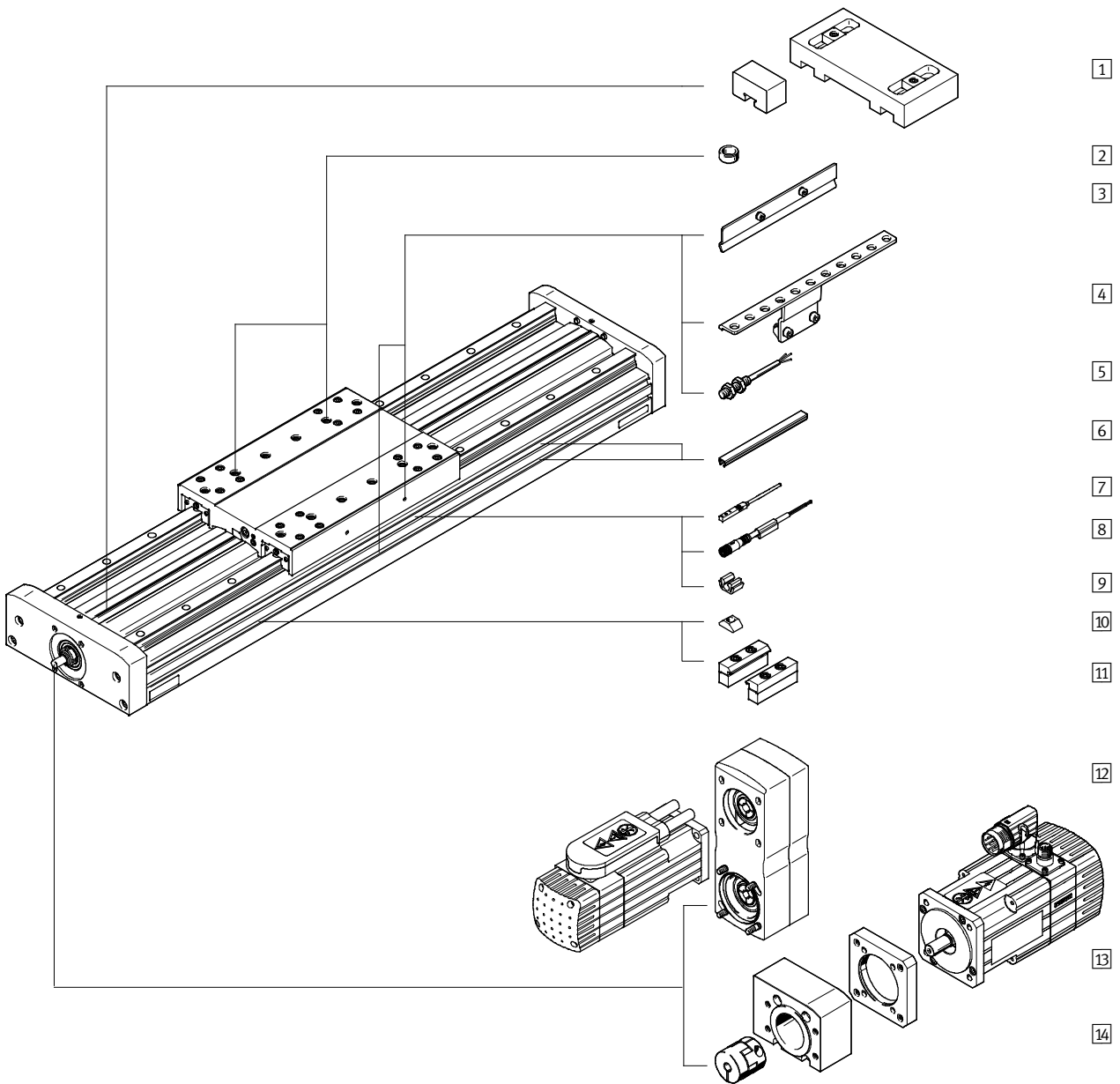

Spindle axes EGC-HD-BS, with heavy-duty guide

Peripherals overview



Variants and accessories		
Type	Brief description	→ Page/Internet
1 Emergency buffer with retainer A	For avoiding damage at the end stop in the event of malfunction	28
2 Centring pin/sleeve ZBS, ZBH	<ul style="list-style-type: none"> For centring loads and attachments on the slide 2 centring pins/sleeves included in the scope of delivery of the axis 	30
3 Switch lug X, Z, O, P, W, R	For sensing the slide position	28
4 Sensor bracket O, P, W, R	Adapter for mounting the inductive proximity sensors (round design) on the axis	29
5 Proximity sensor, M8 O, P, W, R	<ul style="list-style-type: none"> Inductive proximity sensor, round design The order code O, P, W, R includes 1 switch lug and max. 2 sensor brackets 	31
6 Slot cover B, S	<ul style="list-style-type: none"> For protecting against the ingress of dirt 	30
7 Proximity sensor, T-slot X, Z	<ul style="list-style-type: none"> Inductive proximity sensor, for T-slot The order code X, Z includes 1 switch lug 	30
8 Connecting cable V	For proximity sensor (order code W and R)	31
9 Clip CL	For mounting the proximity sensor cable in the slot	30
10 Slot nut Y	For mounting attachments	30
11 Profile mounting M	For mounting the axis on the profile	27
12 Parallel kit EAMM-U	For parallel motor mounting, pointing upwards or downwards only (consisting of: housing, clamping component, toothed belt pulley, toothed belt)	26
13 Motor EMMS	Motors specially matched to the axis, with or without gear unit, with or without brake	24
14 Axial kit EAMM	For axial motor mounting (consisting of: coupling, coupling housing and motor flange)	24

Spindle axes EGC-HD-BS, with heavy-duty guide

Technical data

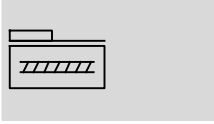
Function



-  - Size
125 ... 220
-  - Stroke length
50 ... 2,400 mm



General technical data						
Size		125	160	220		
Spindle pitch	[mm/ rev.]	10	10	20	10	25
Design		Electromechanical axis with recirculating ball spindle				
Guide		Recirculating ball bearing guide				
Mounting position		Any				
Working stroke	[mm]	50 ... 900	50 ... 1,900		50 ... 2,400	
Max. feed force F_x	[N]	300	600		1,300	
No-load torque at min. travel speed t						
EGC-...-	[Nm]	0.3	0.5	0.5	1.5	1.5
EGC-...-S	[Nm]	0.3	0.5	0.5	1.5	1.5
	[m/s]	0.05	0.1	0.1	0.2	0.2
No-load torque at max. travel speed t						
EGC-...-	[Nm]	0.45	0.75	0.75	2.25	2.25
EGC-...-S	[Nm]	0.45	0.75	0.75	2.25	2.25
	[m/s]	0.5	0.5	1.0	0.6	1.5
Max. radial force ¹⁾	[N]	220	250	250	500	500
Max. speed ²⁾	[1/min]	3,000	3,000	3,000	3,600	3,600
Max. acceleration	[m/s ²]	15				
Repetition accuracy	[mm]	±0.02				

- 1) At the drive shaft
- 2) Rotational speed and speed are stroke-dependent

Operating and environmental conditions	
Ambient temperature	[°C] -10 ... +60
Protection class	IP40
Duty cycle	[%] 100

Weight [g]			
Size	125	160	220
Basic weight with 0 mm stroke ¹⁾	4,123	7,210	19,137
Additional weight per 10 mm stroke	90	138	250
Slide			
EGC-...-GK	1,049	2,080	5,826
EGC-...-GP	-	2,346	6,325
Additional slide			
EGC-...-GK	978	1,963	5,505
EGC-...-GP	-	2,035	5,584

- 1) Incl. slide

Spindle axes EGC-HD-BS, with heavy-duty guide

Technical data

Spindle						
Size		125	160		220	
Diameter	[mm]	12	15		25	
Pitch	[mm/rev.]	10	10	20	10	25

Mass moment of inertia						
Size		125	160		220	
Spindle pitch	[mm/rev.]	10	10	20	10	25
J_0	[kg mm ²]	6.06	13.94	29.74	106.78	184.26
J_S per metre stroke	[kg mm ² /m]	14.20	34.59	34.59	275.64	275.64
J_L per kg effective load	[kg mm ² /kg]	2.53	2.53	10.13	2.53	15.83
J_W Additional slide	[kg mm ²]	2.25	4.69	18.77	13.20	82.48

The mass moment of inertia J_A of the entire axis is calculated as follows: $J_A = J_0 + J_W + J_S \times \text{working stroke [m]} + J_L \times m_{\text{effective load [kg]}}$

Materials

Sectional view

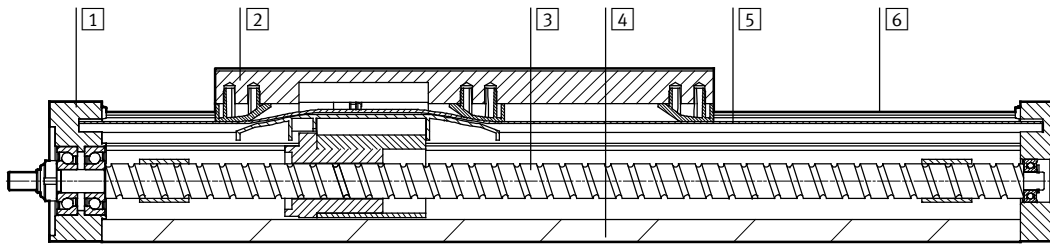

Axis		
1	Drive cover	Anodised wrought aluminium alloy
2	Slide	Anodised wrought aluminium alloy
3	Spindle	Steel
4	Profile	Anodised wrought aluminium alloy
5	Cover strip	Polyurethane
6	Guide rail	Coated and corrosion-resistant steel
Note on materials		Conforms to RoHS
		Contains PWIS (paint-wetting impairment substances)

Spindle axes EGC-HD-BS, with heavy-duty guide

Technical data

Characteristic load values

The indicated forces and torques refer to the slide surface. The point of application of force is the point where the centre of the guide and the longitudinal centre of the slide intersect. These values must not be exceeded during dynamic operation. Special attention must be paid to the cushioning phase.

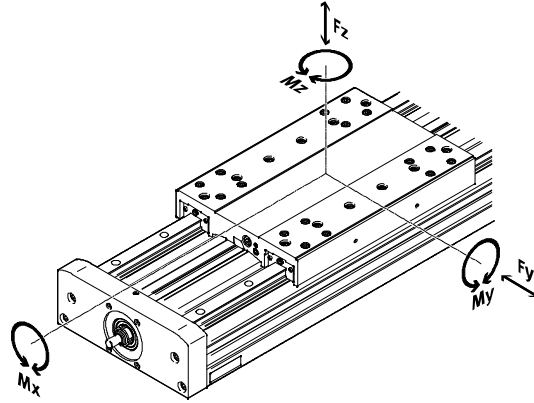

If the axis is subjected to more than two of the indicated forces and torques at the same time, the following equation must be satisfied in addition to the indicated maximum loads:

Calculating the load comparison factor:

$$f_v = \frac{|F_{y,dyn}|}{F_{y,max}} + \frac{|F_{z,dyn}|}{F_{z,max}} + \frac{|M_{x,dyn}|}{M_{x,max}} + \frac{|M_{y,dyn}|}{M_{y,max}} + \frac{|M_{z,dyn}|}{M_{z,max}} \leq 1$$

Permissible forces and torques				
Size		125	160	220
F _{y,max.}	[N]	3,650	5,600	13,000
F _{z,max.}	[N]	3,650	5,600	13,000
M _{x,max.}	[Nm]	140	300	900
M _{y,max.}	[Nm]	275	500	1,450
M _{z,max.}	[Nm]	275	500	1,450

Basic load ratings						
Size		125	160	220		
Spindle pitch		10	10	20	10	25
Ball screw						
Dynamic C _{dyn,ball screw}	[N]	4,000	6,820	7,480	16,000	13,700

Spindle axes EGC-HD-BS, with heavy-duty guide

Technical data

FESTO

Calculating the service life

The service life of the guide depends on the load. To provide a rough indication of the service life of the guide, the

graph below plots the load comparison factor f_c against the service life.

These values are only theoretical. You must consult your local contact person at Festo for load comparison factors f_c greater than 1.5.

Load comparison factor f_c as a function of service life

Example:

A user wants to move a load of X kg. Calculation with the formula $\rightarrow 12$ produces a value of 1.5 for the load comparison factor f_c . According to the graph, the guide has a service life of

approx. 1,500 km. Reducing the acceleration reduces the M_z and M_y values. A load comparison factor f_c of 1 now gives a service life of 5,000 km.

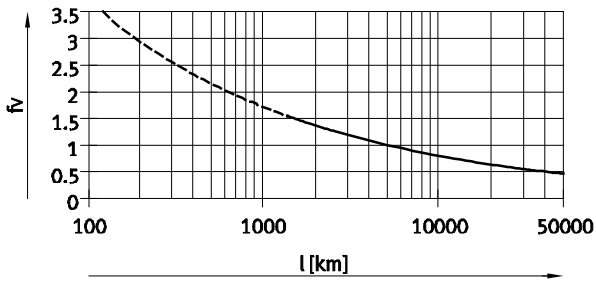

 Note

PositioningDrives
sizing software
www.festo.com

The sizing software can be used to calculate a guide workload for a service life of 5,000 km.

$f_c > 1.5$ are only theoretical comparison values for the recirculating ball bearing guide.

Spindle axes EGC-HD-BS, with heavy-duty guide

Technical data

Speed v as a function of working stroke l

EGC-HD-125

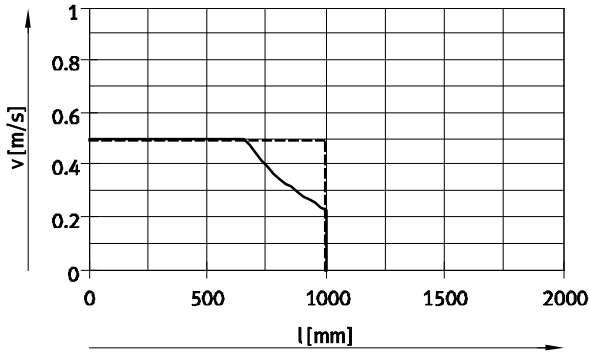

— EGC-HD-125-BS-10P without spindle support
 - - - EGC-HD-125-BS-10P with spindle support

EGC-HD-160

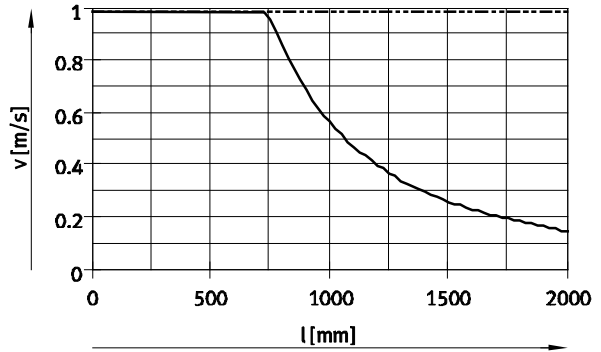

— EGC-HD-160-BS-20P without spindle support
 - - - EGC-HD-160-BS-20P with spindle support

EGC-HD-220

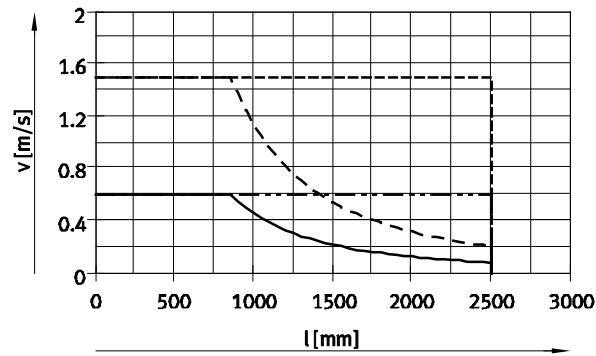

— EGC-HD-220-BS-10P without spindle support
 - - - EGC-HD-220-BS-10P with spindle support
 — EGC-HD-220-BS-25P without spindle support
 - - - EGC-HD-220-BS-25P with spindle support

Speed v as a function of rotational speed n

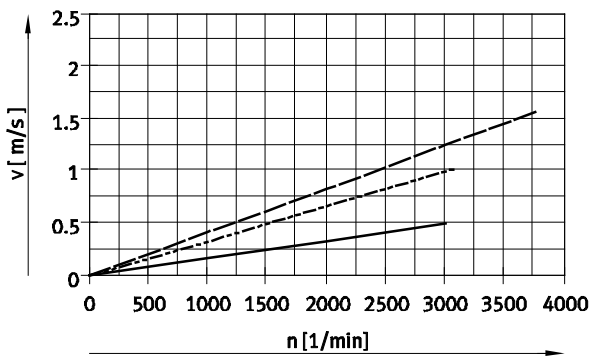

 Note
 Rotational speed is stroke-dependent.
 Note maximum rotational speed.

— EGC-HD-125/160/220-BS-10P
 - - - EGC-HD-160-BS-20P
 - · - EGC-HD-220-BS-25P

Maximum acceleration a as a function of applied load m

EGC-HD-125

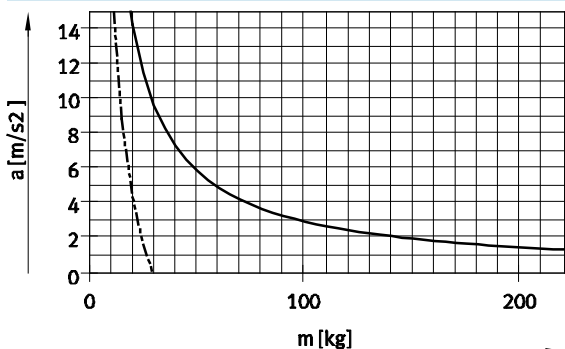

EGC-HD-160

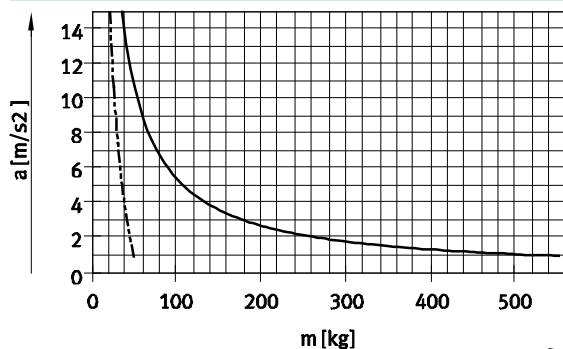

Spindle axes EGC-HD-BS, with heavy-duty guide

Technical data

FESTO

Maximum acceleration a as a function of applied load m

EGC-HD-220

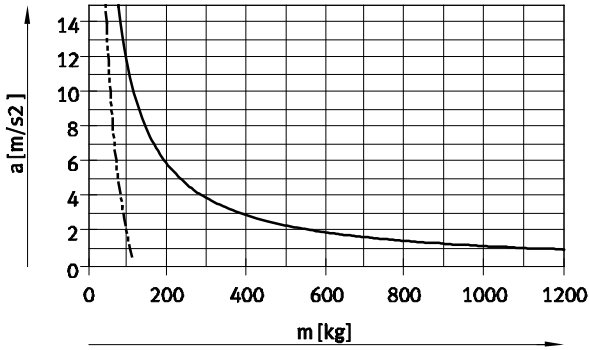

— Horizontal mounting position
 - - - Vertical mounting position

Theoretical feed force F as a function of input torque M

EGC-HD-125

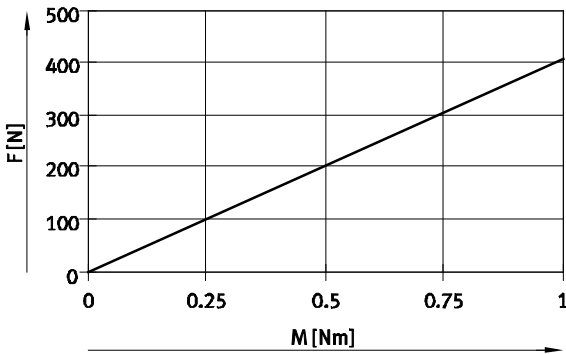

— EGC-HD-125-BS-10P

EGC-HD-160

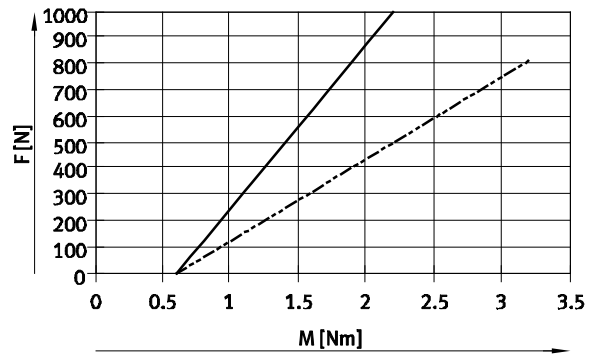

— EGC-HD-160-BS-10P
 - - - EGC-HD-160-BS-20P

EGC-HD-220

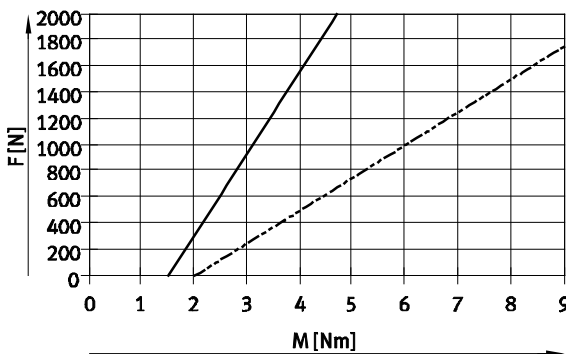

— EGC-HD-220-BS-10P
 - - - EGC-HD-220-BS-25P

Spindle axes EGC-HD-BS, with heavy-duty guide

Technical data

Stroke reserve

Stroke length	Stroke reserve
---------------	----------------

The selected stroke corresponds in principle to the required working stroke. The variant GK does not have a long-term lubrication unit on the guide. These variants therefore additionally have a safety distance between the drive cap and slide that is not designated as part of the working stroke.

A safety distance (similar to GK) between the drive cap and slide can be defined for the variants GP using the modular product system via the stroke reserve feature. With the variants GK, the stroke reserve and safety distance are added for each end position.

- The stroke reserve length can be freely selected
- The sum of the stroke length and 2x stroke reserve must not exceed the maximum working stroke

Example:

Type: EGC-HD-125-500-BS-20H-...
 Working stroke = 500 mm
 2x stroke reserve = 40 mm
 Total stroke = 540 mm
 (540 mm = 500 mm + 2x 20 mm)

Size	125	160	220
L = safety distance with GK [mm] (per end position)	12.5	15.5	20

Working stroke reduction

With standard slide GK/GP with additional slide KL/KR

- With a spindle axis with additional slide, the working stroke is reduced by the length of the additional slide L17 and the distance between both slides L18
- If the variant GP is ordered, the additional slide is also protected

L16 = Length of slide
 L17 = Length of additional slide
 L18 = Distance between both slides

Example:

Type: EGC-HD-220-1000-BS-...-GP-KR
 L18 = 100 mm

Working stroke = 1,000 mm – 328 mm – 100 mm = 572 mm

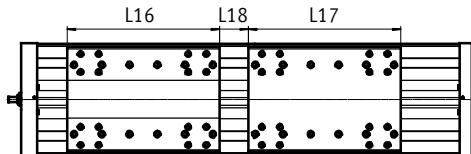

Dimensions – Additional slide

Size	125	160	220
Variant	GK	GK	GP
Length L17 [mm]	202	220	250

Working stroke reduction per side

With integrated emergency buffer NPE with retainer EAYH-L2

- With a spindle axis, the working stroke is reduced by the total dimension of the emergency buffer and retainer.

Size	125	160	220
With emergency buffer [mm]	65	93	98

Spindle axes EGC-HD-BS, with heavy-duty guide

Technical data

Second moment of area

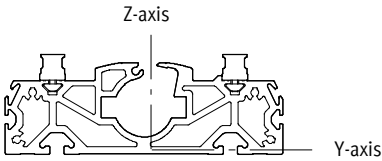

Size		125	160	220
I_y	[mm ⁴]	7.15×10^5	13.5×10^5	55.7×10^5
I_z	[mm ⁴]	41.1×10^5	101×10^5	352×10^5

Maximum permissible support spacing L (without profile mounting) as a function of force F

In order to limit deflection in the case of large strokes, the axis may need to be supported.

The following graphs help to determine the maximum permissible support spacing L as a function of force F acting on the axis. The deflection is $f = 0.5$ mm.

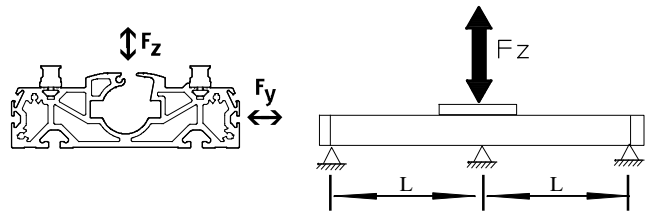

Force Fy

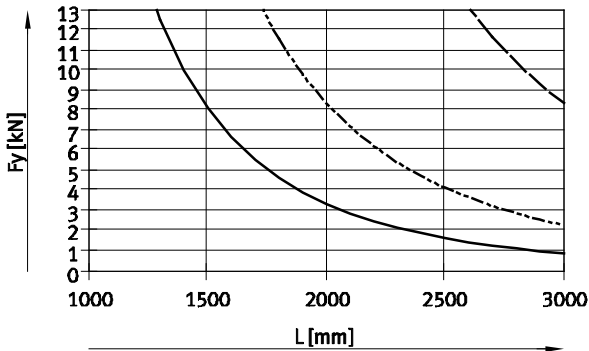

Force Fz

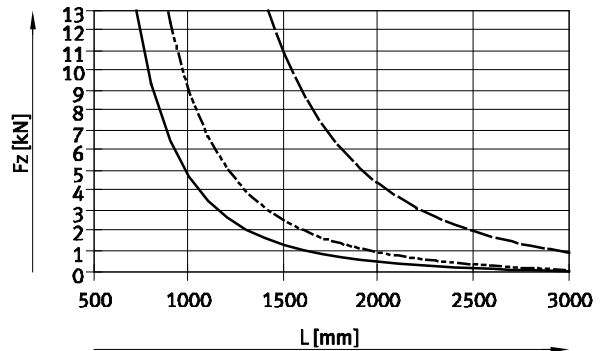

- EGC-HD-125-BS
- - - EGC-HD-160-BS
- EGC-HD-220-BS

Recommended deflection limits

Adherence to the following deflection limits is recommended so as not to impair the functional performance of

the axes. Greater deformation can result in increased friction, greater wear and reduced service life.

Size	Dyn. deflection (moving load)	Stat. deflection (stationary load)
125 ... 220	0.05% of the axis length, max. 0.5 mm	0.1% of the axis length

Spindle axes EGC-HD-BS, with heavy-duty guide

Technical data

Dimensions

Download CAD data → www.festo.com

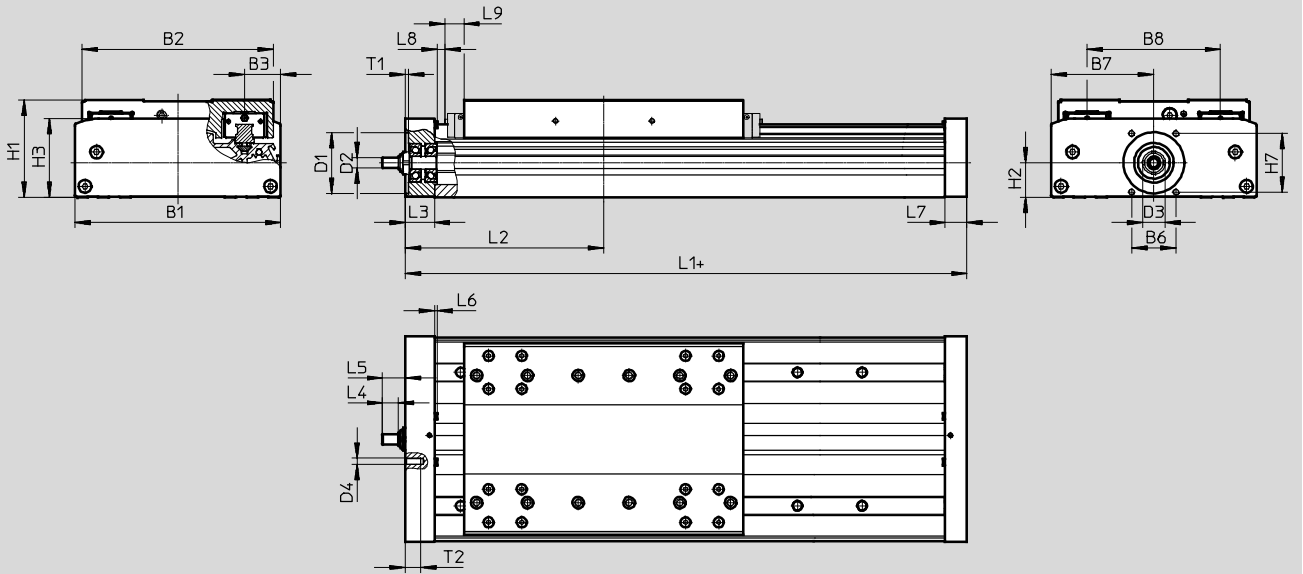

+ = plus stroke length + 2x stroke reserve
 L9 With GK: safety distance per end position;
 with GP: dimension for long-term lubrication unit → 16

Size	B1	B2	B3	B6	B7	B8	D1 ∅ H7	D2 ∅ h6
125	124	120	21	29	62	80	38	6
160	162	150.7	27.5	35	81	105	48	8
220	224	204.2	40	64	112	140	62	12

Size	D3	D4	H1	H2	H3	H7	L3	L4
125	15	M5	64	22.5	50.5	36	21	8
160	18	M5	76.5	27	62	46	23	12.5
220	28	M6	111.5	42.5	89.5	54	33	17.5

Size	L5	L6	L7	L8	L9	T1	T2
125	14	1.8	16	2	–	2.5	12
160	18	2	17	0.55	14.9	2.5	12
220	25.5	2	30	2	18	3	15

Size	Stroke	L1	L2 min.
125	≤900	268	136.5
160	<1,377	296	151.3
	≥1,377	336	171
220	<1,604	409	206
	≥1,604	469	236

Spindle axes EGC-HD-BS, with heavy-duty guide

Technical data

Dimensions

Download CAD data → www.festo.com

Profile

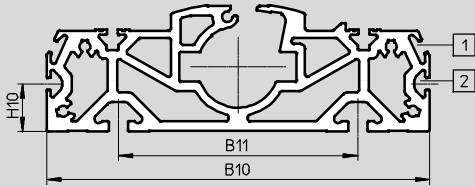

- 1 Sensor slot for proximity sensor
- 2 Mounting slot for slot nut

Size	B10	B11	H10
125	122	80	20
160	160	100	20
220	220	140	20

GK – Standard slide

Size 125

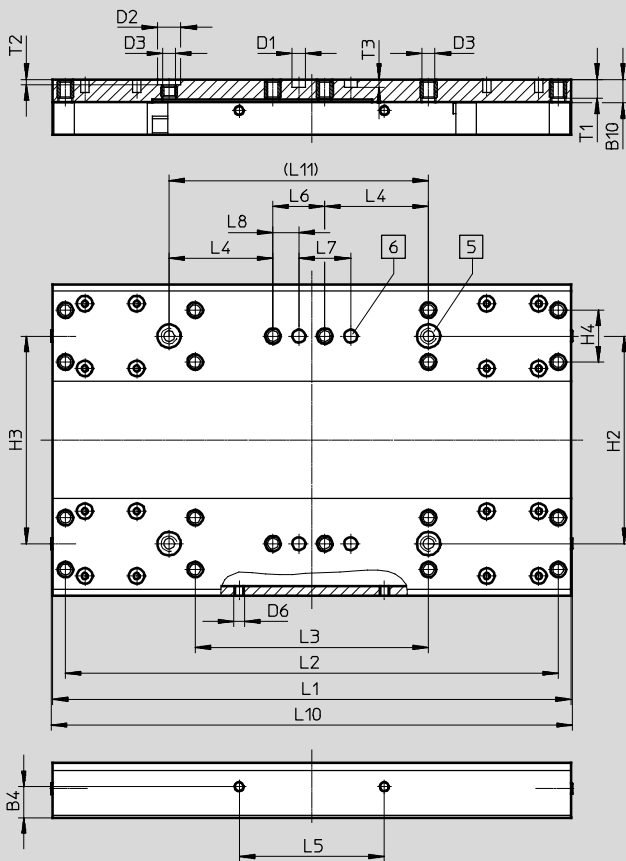

- 5 Hole for centring sleeve ZBH
- 6 Hole for centring pin ZBS

Size	B4	B10	D1	D2	D3	D6	H2	H3	H4	L1	L2	L3
	±0.1		∅ H7	∅ H7			±0.03	±0.05	±0.1	±0.1	±0.2	±0.1
125	12	9	5	9	M5	M4	80	80	20	200	190	90

Size	L4	L5	L6	L7	L8	L10	L11	T1	T2	T3
	±0.1	±0.2	±0.1	±0.03	±0.1		±0.03		+0.1	+0.1
125	40	56	20	20	10	202	100	7.8	2.1	3.1

Spindle axes EGC-HD-BS, with heavy-duty guide

Technical data

Dimensions

Download CAD data → www.festo.com

GK – Standard slide/GP – Standard slide, protected

Size 160

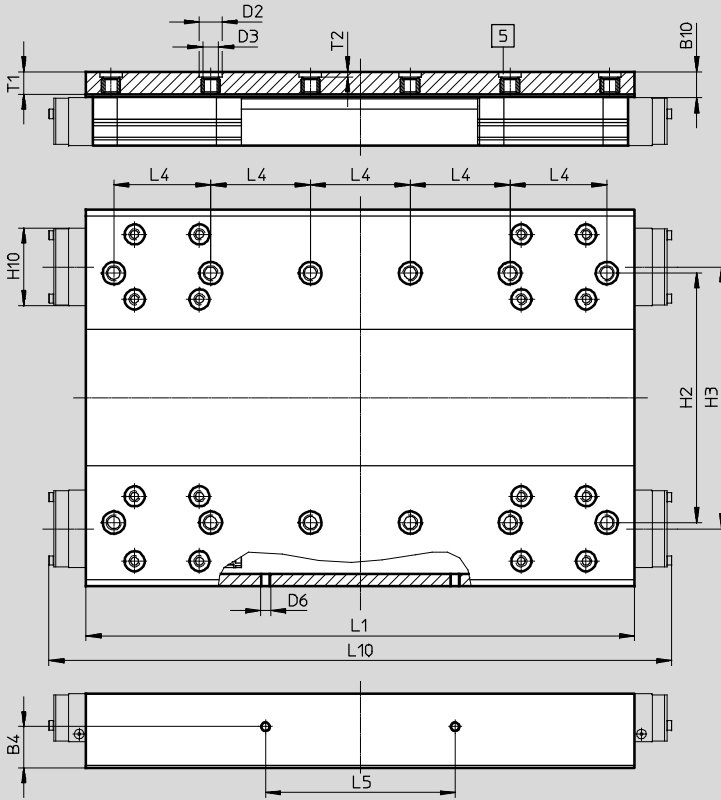

5 Hole for centring sleeve ZBH

Size	B4	B10 ^{*)}	D2 ∅ H7	D3	D6	H2 ±0.03	H3 ±0.05
160	16.5	10.5	9	M6	M4	100	105

Size	H10 ^{*)}	L1 ±0.1	L4 ±0.03	L5 ±0.1	L10 ^{*)}	T1	T2 +0.1
160	31	220	40	76	250	9	2.1

^{*)} Protected version

Spindle axes EGC-HD-BS, with heavy-duty guide

Technical data

Dimensions

Download CAD data → www.festo.com

GK – Standard slide/GP – Standard slide, protected

Size 220

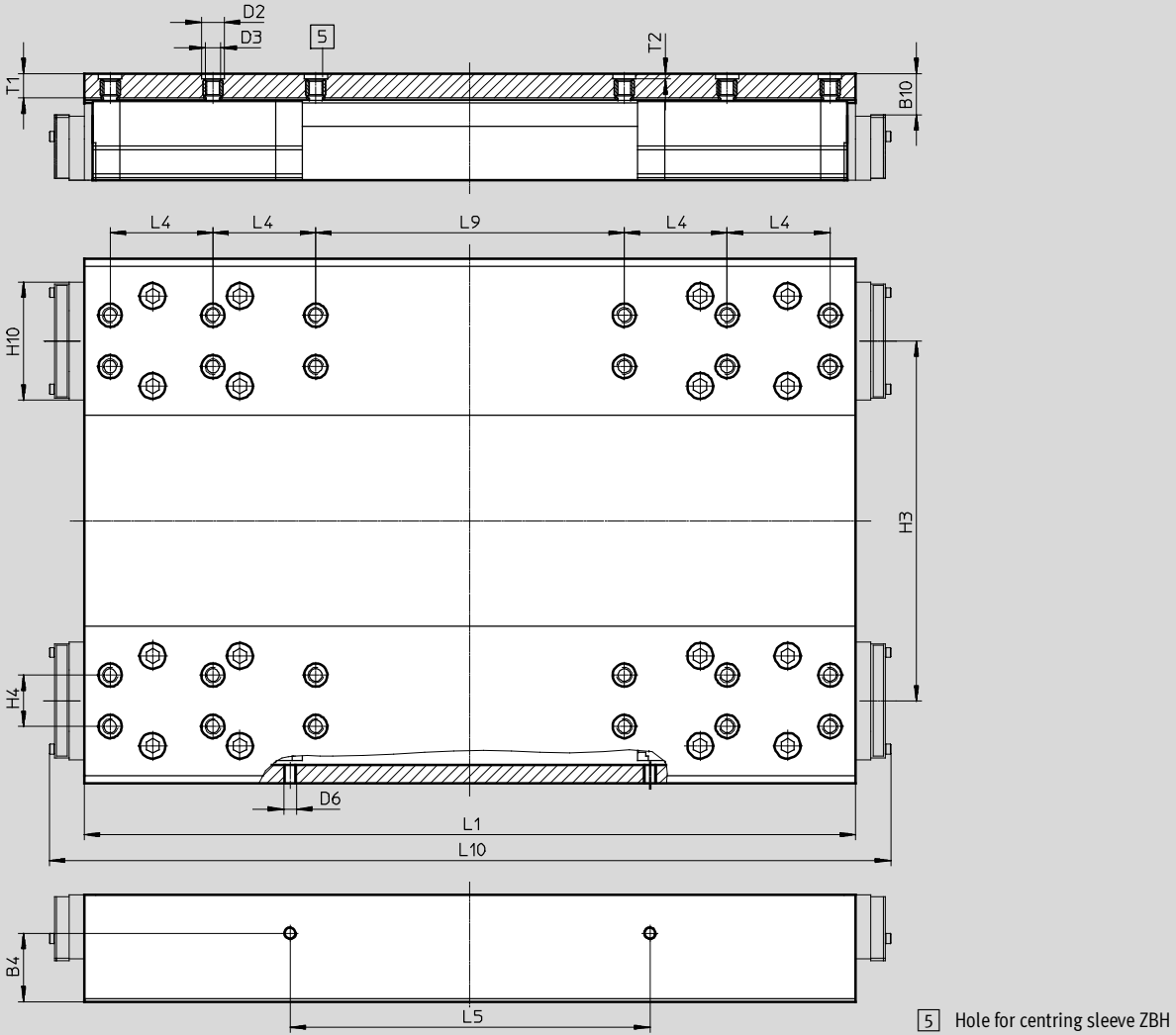

Size	B4	B10 ^{*)}	D2 ∅ H7	D3	D6	H3	H4	H10 ^{*)}
220	±0.1	16	9	M6	M5	±0.05	±0.03	45.95

Size	L1	L4	L5	L9	L10 ^{*)}	T1	T2
220	±0.1	±0.03	±0.1	±0.03	328	9.5	+0.1

^{*)} Protected version

Spindle axes EGC-HD-BS, with heavy-duty guide

Ordering data – Modular products

Order code

Mandatory data

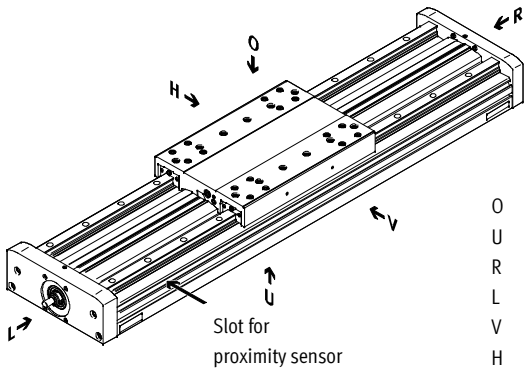

- O top
- U underneath
- R right
- L left
- V front
- H rear

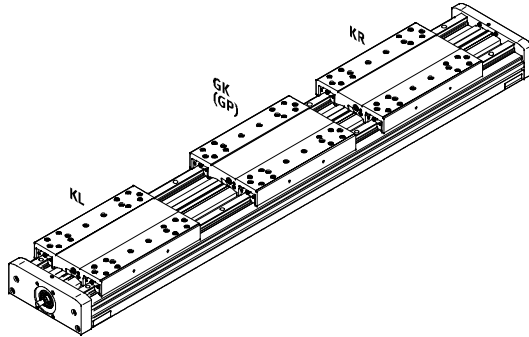

Accessories

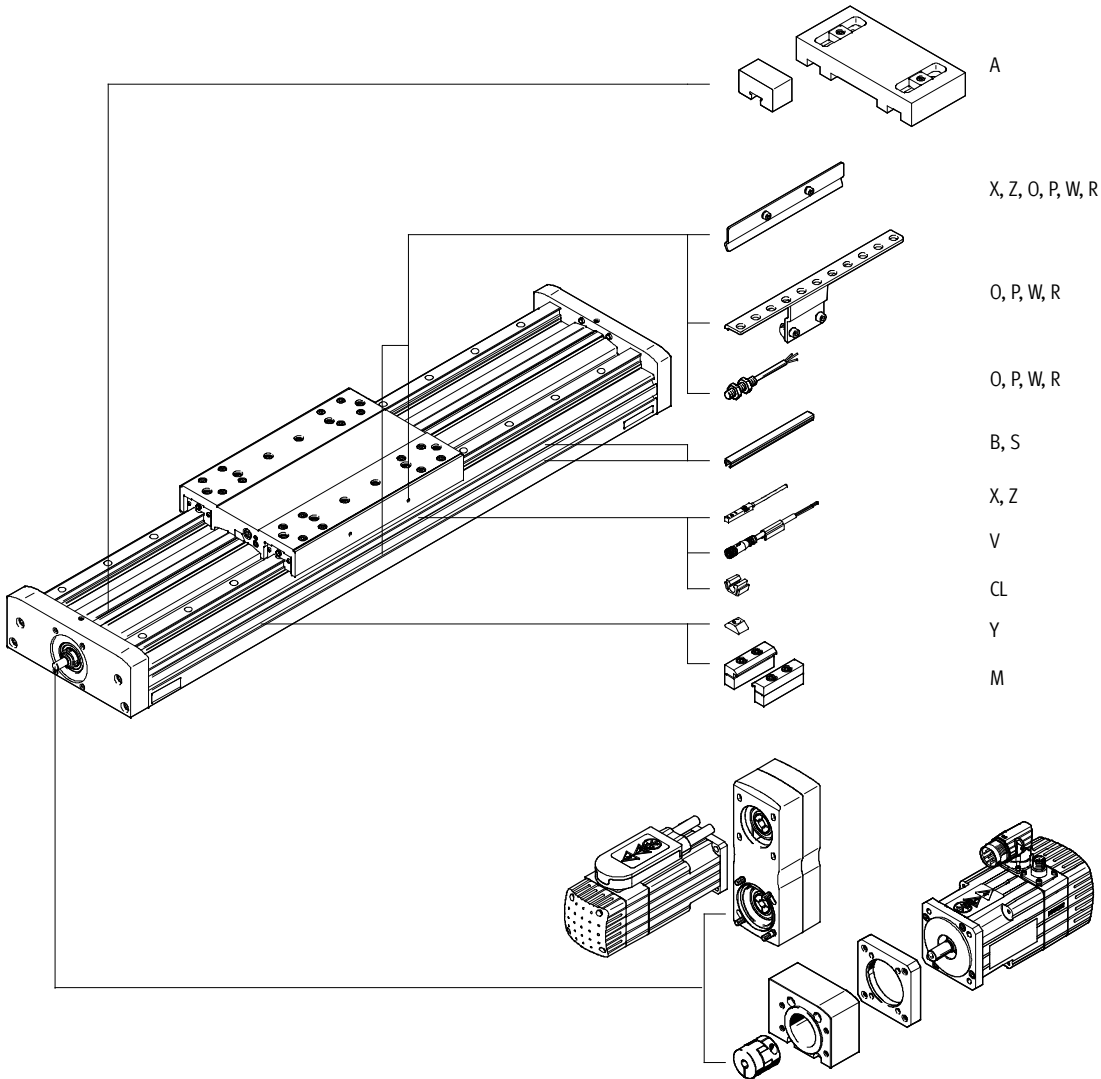

Parallel kit
→ 26

Servo motor EMMS-AS
Stepper motor EMMS-ST
→ 24

Axial kit
→ 24

Spindle axes EGC-HD-BS, with heavy-duty guide

Ordering data – Modular products

Ordering table						
Size	125	160	220	Condi- tions	Code	Enter code
[M] Module No.	556819	556820	556821			
Design	Linear axis				EGC	EGC
Guide	Heavy-duty guide				-HD	-HD
Size	125	160	220		-...	-...
Stroke (without stroke reserve)	[mm] 100, 200, 300, 400, 500, 600, 700, 900	100; 200; 400; 500; 700; 900; 1,300; 1,400; 1,700; 1,900	100; 200; 400; 500; 700; 900; 1,300; 1,400; 1,900; 2,400	[1]	-...	-...
Stroke	50 ... 900	50 ... 1,900	50 ... 2,400			
Function	Ball screw spindle				-BS	-BS
Spindle pitch	10	10	10		-10P	
	-	20	-		-20P	
	-	-	25		-25P	
Spindle support	None					
	With spindle support			[4]	-S	
	> 605 mm	> 680 mm	> 783 mm			
Stroke reserve	[mm] 0 ... 999 (0 = no stroke reserve)			[1]	-...H	
Slide	Standard slide				-GK	
	-	Standard slide, protected			-GP	
[O] Additional slide	Left	Additional slide, standard, on left		[2]	-KL	
	Right	Additional slide, standard, on right		[2]	-KR	
Accessories	Accessories enclosed separately				ZUB-	ZUB-
Profile mounting	1 ... 50				...M	
Cover	Mounting slot	1 ... 50 (1 = 2x 500 mm pieces)		[5]	...B	
	Sensor slot	1 ... 50			...S	
Slot nut for mounting slot	1 ... 99			[5]	...Y	
Proximity sensor (SIES), inductive, slot type 8, PNP, incl. switch lug	N/O contact, 7.5 m cable	1 ... 6			...X	
	N/C contact, 7.5 m cable	1 ... 6			...Z	
Emergency buffer with retainer	1 ... 2			[3]	...A	
Proximity sensor (SIEN), inductive, M8, PNP, incl.	N/O contact, 2.5 m cable	1 ... 99			...O	
	N/C contact, 2.5 m cable	1 ... 99			...P	
switch lug with sensor bracket	N/O contact, plug M8	1 ... 99			...W	
	N/C contact, plug M8	1 ... 99			...R	
Connecting cable, M8, 3-wire, 2.5 m	1 ... 99				...V	
Cable clip	10, 20, 30, 40, 50, 60, 70, 80, 90				...CL	
Operating instructions	Express waiver - no user documentation to be included (already available) (operating instructions in PDF format are available free of charge on the Internet at http://www.festo.com)				-DN	

- [1]** -... The sum of the stroke length in mm and 2x the stroke reserve in mm must not exceed the maximum stroke length in mm.
- [2]** **KL, KR** If the protected slide variant (GP) is selected, then the additional slide (KL, KR) is also protected.
- [3]** ... **A** Cannot be combined with slide GP.
- [4]** **S** Only available above the specified strokes.
- [5]** **B, Y** Scope of delivery with size 160 for both slot sizes (→ 30).

Order code

EGC - **HD** - - - **BS** - - - - - - -

Spindle axes EGC-HD-BS, with heavy-duty guide

Accessories

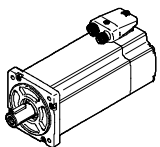
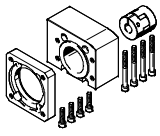
Permissible axis/motor combinations with axial kit		Technical data → Internet: eamm-a	
Motor	Axial kit		
			
Type	Part No.	Type	
EGC-HD-125			
With servo motor			
EMME-AS-40-...	2219044	EAMM-A-S38-40P	
EMMS-AS-40-...	558162	EAMM-A-S38-40A	
EMMS-AS-55-...	558163	EAMM-A-S38-55A	
EMME-AS-60-...	2219110	EAMM-A-S38-60P	
With stepper motor			
EMMS-ST-42-...	560685	EAMM-A-S38-42A	
EMMS-ST-57-...	560686	EAMM-A-S38-57A	
EGC-HD-160			
With servo motor			
EMMS-AS-55-...	558164	EAMM-A-S48-55A	
EMME-AS-60-...	2220560	EAMM-A-S48-60P	
EMMS-AS-70-...	558165	EAMM-A-S48-70A	
With stepper motor			
EMMS-ST-57-...	560687	EAMM-A-S48-57A	
EMMS-ST-87-...	560688	EAMM-A-S48-87A	
EGC-HD-220			
With servo motor			
EMMS-AS-70-...	558166	EAMM-A-S62-70A	
EMME-AS-80-...	2222582	EAMM-A-S62-80P	
EMME-AS-100-...	558167	EAMM-A-S62-100A	
EMMS-AS-100-...	558167	EAMM-A-S62-100A	
EMMS-AS-140-...	558168	EAMM-A-S62-140A	
With stepper motor			
EMMS-ST-87-...	560689	EAMM-A-S62-87A	

 **Note**





For the optimum selection of axis/
motor combinations → www.festo.com

PositioningDrives
sizing software
www.festo.com

Spindle axes EGC-HD-BS, with heavy-duty guide

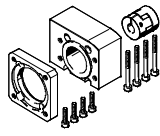
Accessories

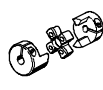
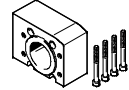
FESTO

Component parts of the axial kit				
Axial kit	Comprising:			
	Motor flange	Coupling	Coupling housing	Screw set
				
Part No. Type	Part No. Type	Part No. Type	Part No. Type	Part No. Type
EGC-HD-125				
2219044 EAMM-A-S38-40P	2219077 EAMF-A-38B-40P	533708 EAMC-30-32-6-8	558171 EAMK-A-S38-38A/B	–
558162 EAMM-A-S38-40A	558175 EAMF-A-38B-40A	558312 EAMC-30-32-6-6	558171 EAMK-A-S38-38A/B	–
560685 EAMM-A-S38-42A	560691 EAMF-A-38B-42A	561333 EAMC-30-32-5-6	558171 EAMK-A-S38-38A/B	–
558163 EAMM-A-S38-55A	558176 EAMF-A-38A-55A	551003 EAMC-30-32-6-9	558171 EAMK-A-S38-38A/B	567488 EAHM-L2-M5-50
560686 EAMM-A-S38-57A	560692 EAMF-A-38A-57A	551002 EAMC-30-32-6-6.35	558171 EAMK-A-S38-38A/B	567488 EAHM-L2-M5-50
2219110 EAMM-A-S38-60P	1987412 EAMF-A-38A-60P	1233256 EAMC-30-32-6-14	558171 EAMK-A-S38-38A/B	567489 EAHM-L2-M5-55
EGC-HD-160				
558164 EAMM-A-S48-55A	558177 EAMF-A-48B-55A	543423 EAMC-30-32-8-9	558172 EAMK-A-S48-48A/B	–
560687 EAMM-A-S48-57A	560694 EAMF-A-48B-57A	543421 EAMC-30-32-6.35-8	558172 EAMK-A-S48-48A/B	–
2220560 EAMM-A-48-60P	2220620 EAMF-A-48A-60P	562682 EAMC-30-32-8-14	558172 EAMK-A-S48-48A/B	567489 EAHM-L2-M5-55
558165 EAMM-A-S48-70A	558025 EAMF-A-48A-70A	551004 EAMC-30-32-8-11	558172 EAMK-A-S48-48A/B	567488 EAHM-L2-M5-50
560688 EAMM-A-S48-87A	560695 EAMF-A-48A-87A	551004 EAMC-30-32-8-11	558172 EAMK-A-S48-48A/B	567489 EAHM-L2-M5-55
EGC-HD-220				
558166 EAMM-A-S62-70A	558179 EAMF-A-62B-70A	558313 EAMC-42-66-11-12	558173 EAMK-A-S62-62A/B	–
2222582 EAMM-A-S62-80P	2222624 EAMF-A-62B-80P	551005 EAMC-42-50-12-19	558173 EAMK-A-S62-62A/B	–
560689 EAMM-A-S62-87A	560696 EAMF-A-62B-87A	558313 EAMC-42-66-11-12	558173 EAMK-A-S62-62A/B	–
558167 EAMM-A-S62-100A	558026 EAMF-A-62A-100A	551005 EAMC-42-50-12-19	558173 EAMK-A-S62-62A/B	567494 EAHM-L2-M6-80
558168 EAMM-A-S62-140A	558022 EAMF-A-62A-140A	558314 EAMC-42-50-12-24	558173 EAMK-A-S62-62A/B	567495 EAHM-L2-M6-90

Spindle axes EGC-HD-BS, with heavy-duty guide

Accessories

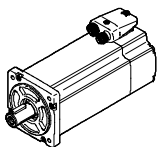
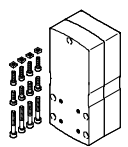
Permissible axis/motor combinations with parallel kit			Technical data → Internet: eamm-u
Motor	Parallel kit		
			
Type	Part No.	Type	
EGC-HD-125			
With servo motor			
EMME-AS-40-...	2155239	EAMM-U-50-S38-40P-78	
EMMS-AS-40-...	1217708	EAMM-U-50-S38-40A-78	
EMMS-AS-55-...	1218538	EAMM-U-60-S38-55A-91	
With stepper motor			
EMMS-ST-42-...	1217945	EAMM-U-50-S38-42A-78	
EMMS-ST-57-...	1218568	EAMM-U-60-S38-57A-91	
With gear unit ²⁾			
EMGA-40-P-...	2283732	EAMM-U-60-S38-40G-91	
EMGC-40-P-...	2283732	EAMM-U-60-S38-40G-91	
EGC-HD-160			
With servo motor			
EMMS-AS-55-...	1219370	EAMM-U-60-S48-55A-91¹⁾	
EMMS-AS-70-...	1217689	EAMM-U-86-S48-70A-102¹⁾	
With stepper motor			
EMMS-ST-57-...	1219379	EAMM-U-60-S48-57A-91¹⁾	
EMMS-ST-87-...	1217604	EAMM-U-86-S48-87A-177¹⁾	
With gear unit ²⁾			
EMGA-40-P-...	2283760	EAMM-U-60-S48-40G-91¹⁾	
EMGC-40-P-...	2283760	EAMM-U-60-S48-40G-91¹⁾	
EMGA-60-P-...-SAS/SST	1587251	EAMM-U-86-S48-60G-102¹⁾	
EMGA-60-P-...-EAS	1587338	EAMM-U-86-S48-60H-102¹⁾	
EMGC-60-P-...			
EGC-HD-220			
With servo motor			
EMMS-AS-70-...	1217543	EAMM-U-86-S62-70A-177¹⁾	
EMME-AS-80-...	2157004	EAMM-U-86-S62-80P-177¹⁾	
EMME-AS-100-...	1217381	EAMM-U-110-S62-100A-207¹⁾	
EMMS-AS-100-...	1217381	EAMM-U-110-S62-100A-207¹⁾	
EMMS-AS-140-...	1219440	EAMM-U-145-S62-140A-288¹⁾	
With stepper motor			
EMMS-ST-87-...	1217373	EAMM-U-86-S62-87A-177¹⁾	
With gear unit ²⁾			
EMGA-60-P-...-SAS/SST	1587411	EAMM-U-86-S62-60G-177¹⁾	
EMGA-60-P-...-EAS	1587453	EAMM-U-86-S62-60H-177¹⁾	
EMGC-60-P-...			

2) The output torque at the gear unit output must be less than the transferable torque of the kit.

 Note

1) These parallel kits include a counter bearing EAMG to support the axis shaft.
More information → eamm-u

 Note

The clamping component EADT is required to adjust the toothed belt pretension with EAMM-U-110 and EAMM-U-145.

The motor and/or axis shaft can optionally be supported with a counter bearing EAMG.
More information → eamm-u

Spindle axes EGC-HD-BS, with heavy-duty guide

Accessories

FESTO

Profile mounting MUE
(order code M)

Material:
Anodised aluminium
Conforms to RoHS

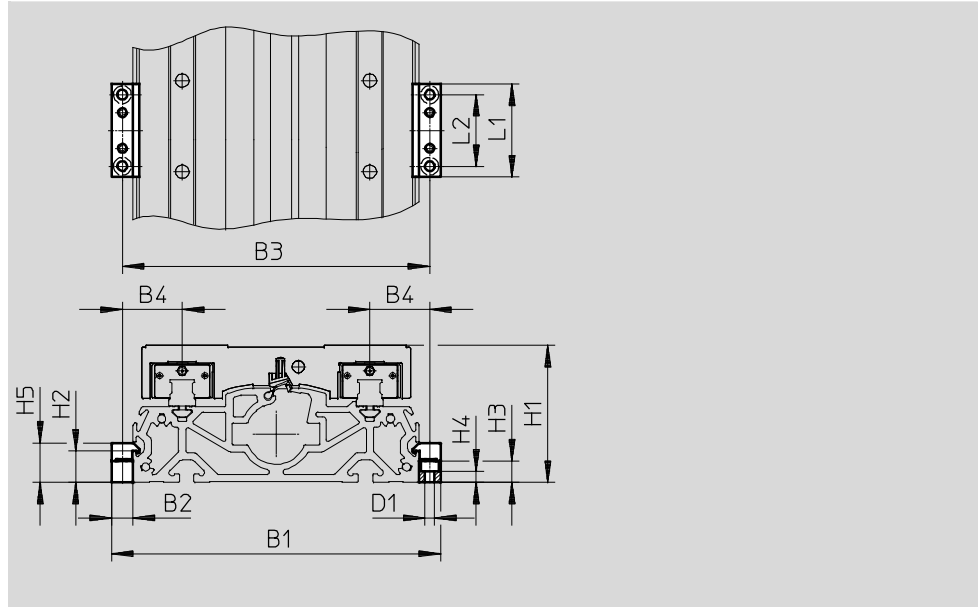

Dimensions and ordering data								
For size	B1	B2	B3	B4	D1 Ø	H1	H2	H3
125	146	12	134	27	5.5	64	17.5	12
160	184	12	172	33.5	5.5	76.5	17.5	12
220	258	19	239	49.5	9	111.5	16	14

For size	H4	H5	L1	L2	Weight [g]	Part No.	Type
125	6.2	22	52	40	80	558043	MUE-70/80
160	6.2	22	52	40	80	558043	MUE-70/80
220	5.5	29.5	90	40	290	558044	MUE-120/185

Spindle axes EGC-HD-BS, with heavy-duty guide

Accessories

Retainer EAYH

Emergency buffer NPE → 30
(order code A)

Material:

Anodised aluminium
Conforms to RoHS

Cannot be used in combination with
the variants GP.

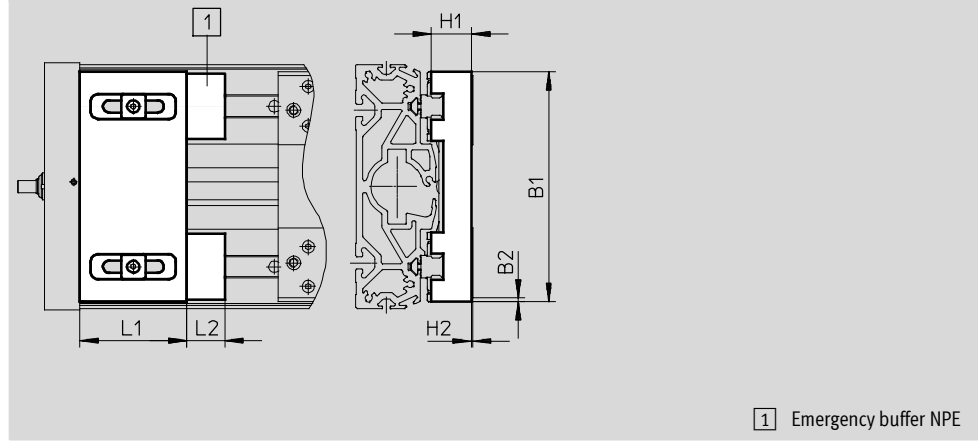
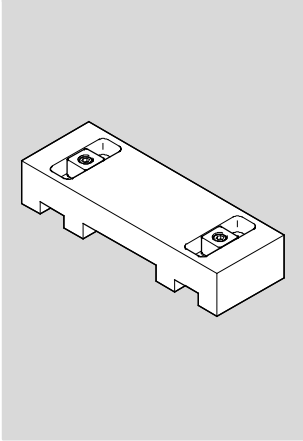

1 Emergency buffer NPE

Dimensions and ordering data									
For size	B1	B2	H1	H2	L1	L2	Weight [g]	Part No.	Type
125	120	0	17.8	0.4	50	17	260	1662803	EAYH-L2-125-N
160	150.7	2.65	26.2	0.8	70	25	617	1669259	EAYH-L2-160-N
220	204	6	38.7	0.1	70	30	1,195	1669260	EAYH-L2-220-N

Switch lug SF-EGC-HD-1

for sensing via proximity sensor
SIES-8M
(order code X or Z)

Material:

Galvanised steel
Conforms to RoHS

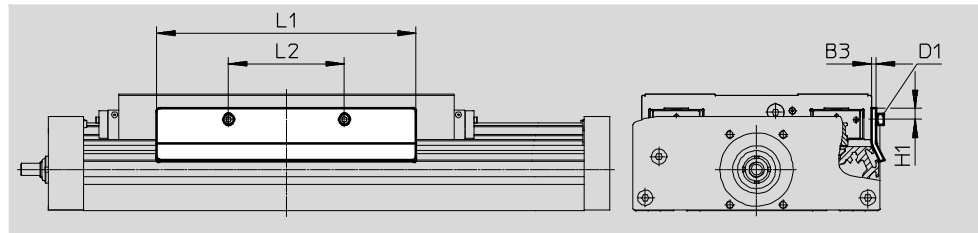

Dimensions and ordering data									
For size	B3	D1	H1	L1	L2	Weight [g]	Part No.	Type	
125	2	M4x8	7.8	150	56	70	570027	SF-EGC-HD-1-125	
160	3	M4x8	7.3	170	76	160	1645872	SF-EGC-HD-1-160	
220	3	M5x10	11.5	250	140	310	1645866	SF-EGC-HD-1-220	

Spindle axes EGC-HD-BS, with heavy-duty guide

Accessories

Switch lug SF-EGC-HD-2

For sensing via proximity sensor
SIEN-M8B (order code O, P, W or R) or
SIES-8M (order code X or Z)

Material:
Galvanised steel
Conforms to RoHS



Sensor bracket HWS-EGC

For proximity sensor SIEN-M8B
(order code O, P, W or R)

Material:
Galvanised steel
Conforms to RoHS

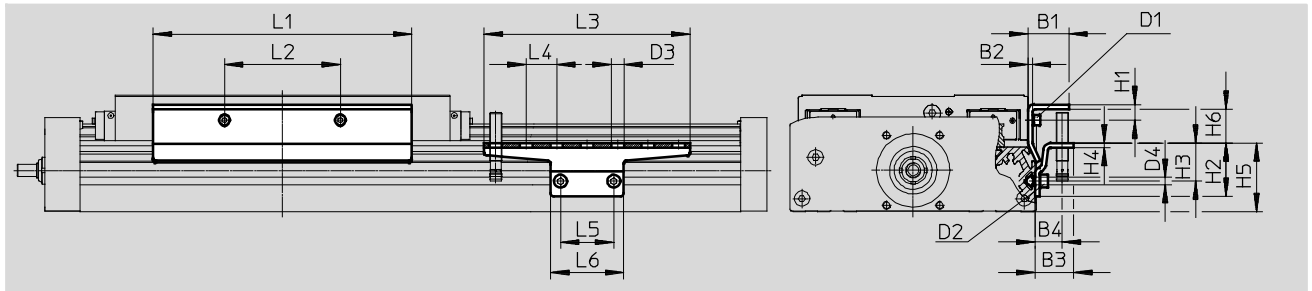

Dimensions and ordering data											
For size	B1	B2	B3	B4	D1	D2	D3	D4	H1	H2	
125	24	2	25.5	18	M4x8	M5x8	8.4	5.2	9	35	
160	27	3	25.5	18	M4x8	M5x8	8.4	5.2	10.3	35	
220	31	3	25.5	18	M5x10	M5x14	8.4	5.2	11.5	65	





For size	H3	H4	H5	H6	L1	L2	L3	L4	L5	L6
125	25	3	45	14	150	56	135	20	35	48
160	25	3	45	22.2	170	76	135	20	35	48
220	55	3	75	18.4	250	140	215	20	35	48

For size	Weight [g]	Part No.	Type
Switch lug			
125	122	570030	SF-EGC-HD-2-125
160	261	1645865	SF-EGC-HD-2-160
220	430	1645868	SF-EGC-HD-2-220

For size	Weight [g]	Part No.	Type
Sensor bracket			
125	110	558057	HWS-EGC-M5
160	110	558057	HWS-EGC-M5
220	217	570365	HWS-EGC-M8-B

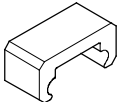
Spindle axes EGC-HD-BS, with heavy-duty guide

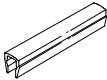
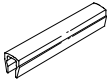
Accessories





Ordering data						
	For size	Remark	Order code	Part No.	Type	PU ¹⁾
Emergency buffer NPE						
	125	Use in combination with retainer EAYH	A	1662475	NPE-125	1
	160			1672593	NPE-160	
	220			1672598	NPE-220	
Slot nut NST						
	125, 160 ³⁾	For mounting slot	Y	150914	NST-5-M5	1
	160 ⁴⁾ , 220			150915	NST-8-M6	
Centring pin/sleeve ZBS/ZBH²⁾						
	125	For slide	-	150928	ZBS-5	10
	125 ... 220			150927	ZBH-9	
Slot cover ABP						
	125, 160 ³⁾	For mounting slot every 0.5 m	B	151681	ABP-5	2
	160 ⁴⁾ , 220			151682	ABP-8	
Slot cover ABP-S						
	125 ... 220	For sensor slot every 0.5 m	S	563360	ABP-5-S1	2
Clip SMBK						
	125 ... 220	For sensor slot, for attaching the proximity sensor cables	CL	534254	SMBK-8	10

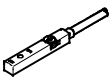
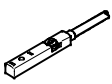

- 1) Packaging unit
- 2) 2 centring pins/sleeves included in the scope of delivery of the axis
- 3) For mounting slot at side
- 4) For mounting slot underneath

Spindle axes EGC-HD-BS, with heavy-duty guide

Accessories

Ordering data – Proximity sensors for T-slot, inductive							Technical data → Internet: sies	
	Type of mounting	Electrical connection	Switching output	Cable length [m]	Order code	Part No.	Type	
N/O contact								
	Insertable in the slot from above, flush with the cylinder profile	Cable, 3-wire	PNP	7.5	X	551386	SIES-8M-PS-24V-K-7,5-OE	
		Plug M8x1, 3-pin		0.3	–	551387	SIES-8M-PS-24V-K-0,3-M8D	
		Cable, 3-wire	NPN	7.5	–	551396	SIES-8M-NS-24V-K-7,5-OE	
		Plug M8x1, 3-pin		0.3	–	551397	SIES-8M-NS-24V-K-0,3-M8D	
N/C contact								
	Insertable in the slot from above, flush with the cylinder profile	Cable, 3-wire	PNP	7.5	Z	551391	SIES-8M-PO-24V-K-7,5-OE	
		Plug M8x1, 3-pin		0.3	–	551392	SIES-8M-PO-24V-K-0,3-M8D	
		Cable, 3-wire	NPN	7.5	–	551401	SIES-8M-NO-24V-K-7,5-OE	
		Plug M8x1, 3-pin		0.3	–	551402	SIES-8M-NO-24V-K-0,3-M8D	

Ordering data – Proximity sensors M8 (round design), inductive							Technical data → Internet: sien	
	Electrical connection	LED	Switching output	Cable length [m]	Order code	Part No.	Type	
N/O contact								
	Cable, 3-wire	■	PNP	2.5	O	150386	SIEN-M8B-PS-K-L	
	Plug M8x1, 3-pin	■	PNP	–	W	150387	SIEN-M8B-PS-S-L	
N/C contact								
	Cable, 3-wire	■	PNP	2.5	P	150390	SIEN-M8B-PO-K-L	
	Plug M8x1, 3-pin	■	PNP	–	R	150391	SIEN-M8B-PO-S-L	

Ordering data – Connecting cables					Technical data → Internet: nebu	
	Electrical connection, left	Electrical connection, right	Cable length [m]	Part No.	Type	
	Straight socket, M8x1, 3-pin	Cable, open end, 3-wire	2.5	159420	SIM-M8-3GD-2,5-PU	
			2.5	541333	NEBU-M8G3-K-2.5-LE3	
			5	541334	NEBU-M8G3-K-5-LE3	
	Angled socket, M8x1, 3-pin	Cable, open end, 3-wire	2.5	541338	NEBU-M8W3-K-2.5-LE3	
			5	541341	NEBU-M8W3-K-5-LE3	