

Spindle axes EGC-BS-KF, with recirculating ball bearing guide



Electromechanical drives

Selection aid



Overview of toothed belt and spindle axes

Toothed belt axes

- Speeds of up to 10 m/s
- Acceleration of up to 50 m/s²
- Repetition accuracy of up to ±0.08 mm
- Strokes of up to 8,500 mm (longer strokes on request)
- Flexible motor mounting

Spindle axes

- Speeds of up to 2 m/s
- Acceleration of up to 20 m/s²
- Repetition accuracy of up to ±0.003 mm
- Strokes of up to 3,000 mm

Coordinate system

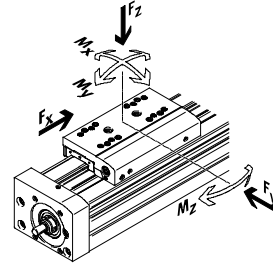

Toothed belt axes

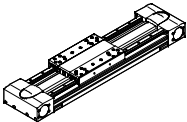
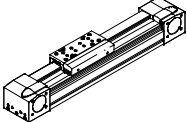
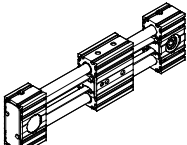
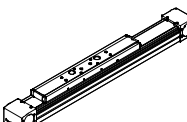
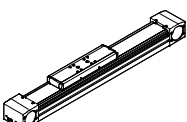
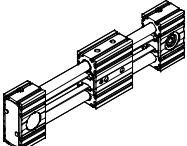
Type	F_x [N]	v [m/s]	M_x [Nm]	M_y [Nm]	M_z [Nm]	Properties
Heavy-duty recirculating ball bearing guide						
EGC-HD-TB						
	450 1,000 1,800	3 5 5	140 300 900	275 500 1,450	275 500 1,450	<ul style="list-style-type: none"> • Flat drive unit with rigid, closed profile • Precision, resilient DUO guide rail • Ideal as a basic axis for linear gantries and cantilever axes
Recirculating ball bearing guide						
EGC-TB-KF						
	50 100 350 800 2,500	3 5 5 5 5	3.5 16 36 144 529	10 132 228 680 1,820	10 132 228 680 1,820	<ul style="list-style-type: none"> • Rigid, closed profile • Precision, resilient guide rail • Small drive pinions reduce necessary driving torque • Space-saving position sensing
ELGR-TB						
	50 100 350	3 3 3	2.5 5 15	20 40 124	20 40 124	<ul style="list-style-type: none"> • Cost-optimised rod guide • Ready-to-install unit • Resilient ball bearings for dynamic operation
Roller bearing guide						
ELGA-TB-RF						
	350 800 1,300	10 10 10	11 30 100	40 180 640	40 180 640	<ul style="list-style-type: none"> • Heavy-duty roller bearing guide • Guide and toothed belt protected by cover strip • Speeds of up to 10 m/s • Lower weight than axes with guide rails
Plain-bearing guide						
ELGA-TB-G						
	350 800 1,300	5 5 5	5 10 120	30 60 120	10 20 40	<ul style="list-style-type: none"> • Guide and toothed belt protected by cover strip • For simple handling tasks • As an actuator for external guides • Insensitive to harsh environmental conditions
ELGR-TB-GF						
	50 100 350	1 1 1	1 2.5 1	10 20 40	10 20 40	<ul style="list-style-type: none"> • Cost-optimised rod guide • Ready-to-install unit • Heavy-duty plain bearings for use in harsh environmental conditions

Electromechanical drives

Selection aid

Overview of toothed belt and spindle axes

Toothed belt axes

- Speeds of up to 10 m/s
- Acceleration of up to 50 m/s²
- Repetition accuracy of up to ±0.08 mm
- Strokes of up to 8,500 mm (longer strokes on request)
- Flexible motor mounting

Spindle axes

- Speeds of up to 2 m/s
- Acceleration of up to 20 m/s²
- Repetition accuracy of up to ±0.003 mm
- Strokes of up to 3,000 mm

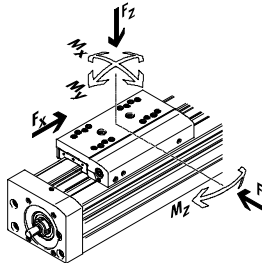

Spindle axes

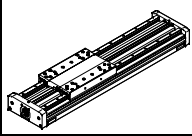
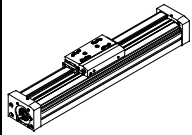
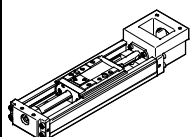
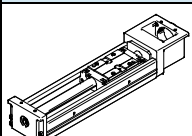
Type	F_x [N]	v [m/s]	M_x [Nm]	M_y [Nm]	M_z [Nm]	Properties
Heavy-duty recirculating ball bearing guide						
EGC-HD-BS						
	300 600 1,300	0.5 1.0 1.5	140 300 900	275 500 1,450	275 500 1,450	<ul style="list-style-type: none"> • Flat drive unit with rigid, closed profile • Precision, resilient DUO guide rail • Ideal as a basic axis for linear gantries and cantilever axes
Recirculating ball bearing guide						
EGC-BS-KF						
	300 600 1,300 3,000	0.5 1.0 1.5 2.0	16 36 144 529	132 228 680 1,820	132 228 680 1,820	<ul style="list-style-type: none"> • Rigid, closed profile • Precision, resilient guide rail • For extremely high requirements for speed, acceleration and torque resistance • Space-saving position sensing
EGSK						
	57 133 184 239 392	0.33 1.10 0.83 1.10 1.48	13 28.7 60 79.5 231	3.7 9.2 20.4 26 77.3	3.7 9.2 20.4 26 77.3	<ul style="list-style-type: none"> • Spindle axes with maximum precision, compactness and rigidity • Recirculating ball bearing guide and ball screw without caged ball bearings • Standard designs in stock
EGSP						
	112 212 466 460	0.6 0.6 2.0 2.0	36.3 81.5 90.3 258	12.5 31.6 32.1 94	12.5 31.6 32.1 94	<ul style="list-style-type: none"> • Spindle axes with maximum precision, compactness and rigidity • Recirculating ball bearing guide with caged ball bearings • Ball screw sizes 33, 46 with caged ball bearings

Spindle axes EGC-BS-KF, with recirculating ball bearing guide

Key features



At a glance			
Powerful	Economical	Versatile	
<ul style="list-style-type: none"> • Generously sized profiles with an optimised cross section afford maximum rigidity and load capacity • Speed, acceleration and torque resistance set a new standard 	<ul style="list-style-type: none"> • In addition to its technical data, the spindle axis also offers an excellent price/performance ratio • Due to the EGC's high performance it is often possible to use a smaller size 	<ul style="list-style-type: none"> • Different spindle pitches, numerous sizes and variants such as protected guides open up a broad range of applications • Space-saving position sensing with proximity sensors in the profile slot is possible 	<ul style="list-style-type: none"> • Wide range of options for mounting on drives • Comprehensive range of mounting accessories for multi-axis combinations • Spindle support enables maximum travel speed with all stroke lengths

Comprehensive range for the most varied load conditions

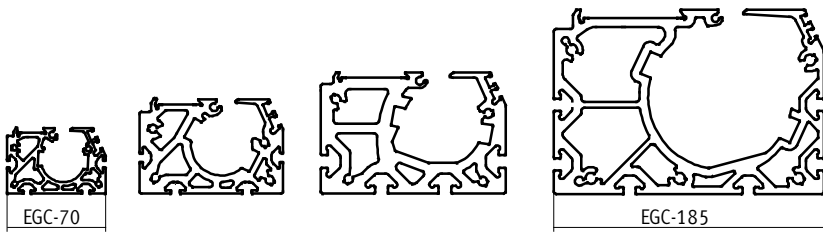

Characteristic values of the axes

The specifications shown in the table are maximum values. The precise values for each of the variants can be found in the relevant technical data in the catalogue.

Version	Size	Working stroke [mm]	Speed [m/s]	Repetition accuracy [mm]	Feed force [N]	Guide characteristics				
						Forces and torques				
						F _y [N]	F _z [N]	M _x [Nm]	M _y [Nm]	M _z [Nm]
Recirculating ball bearing guide										
	70	50 ... 1,000	0.5	±0.02	300	1,850	1,850	16	132	132
	80	50 ... 2,000	1.0	±0.02	600	3,050	3,050	36	228	228
	120	50 ... 2,500	1.5	±0.02	1,300	6,890	6,890	144	680	680
	185	50 ... 3,000	2.0	±0.02	3,000	15,200	15,200	529	1,820	1,820

- - Note
PositioningDrives
sizing software
www.festo.com

Spindle axes EGC-BS-KF, with recirculating ball bearing guide

Key features

Slide variants

Standard slide



Extended slide



Additional slide



Guide options

Protected version

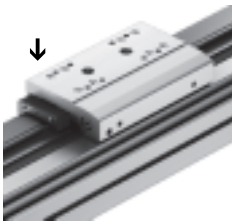

- The protected guide cleans the guide rail and protects the recirculating ball bearing guide with the aid of an additional wiper

With central lubrication

→ 28



- The lubrication adapter enables the guide to be permanently lubricated using semi or fully automatic relubrication devices
- The adapters are suitable for oils and greases
- Both lubrication adapters must be connected

Displacement encoder

→ 12



- The position of the slide can be sensed directly when using the incremental displacement encoder. This means that all elasticities of the drive train can be detected and can be corrected by the motor controller

Clamping unit

→ 12

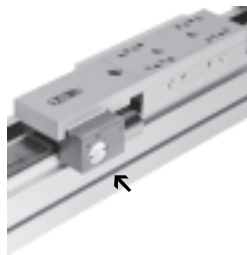

- 1 or 2-channel design, for holding loads
- Reliable holding is guaranteed since the forces act directly on the slide
- A limited number of emergency braking operations are permissible with the sizes 120 and 185

Complete system comprising spindle axis, motor, motor controller and motor mounting kit

Spindle axis with recirculating ball bearing guide



Axial kit



Parallel kit



Motor

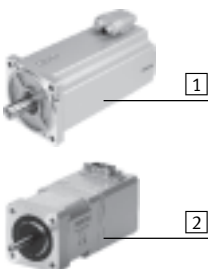

- 1 Servo motor EMME-AS, EMMS-AS
- 2 Stepper motor EMMS-ST

 Note

A range of specially adapted complete solutions is available for the spindle axis EGC and the motors.

Motor controller

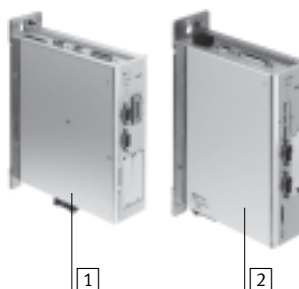

- 1 Servo motor controller CMMP-AS, CMMS-AS
- 2 Stepper motor controller CMMS-ST

Spindle axes EGC-BS-KF, with recirculating ball bearing guide

Peripherals overview

FESTO

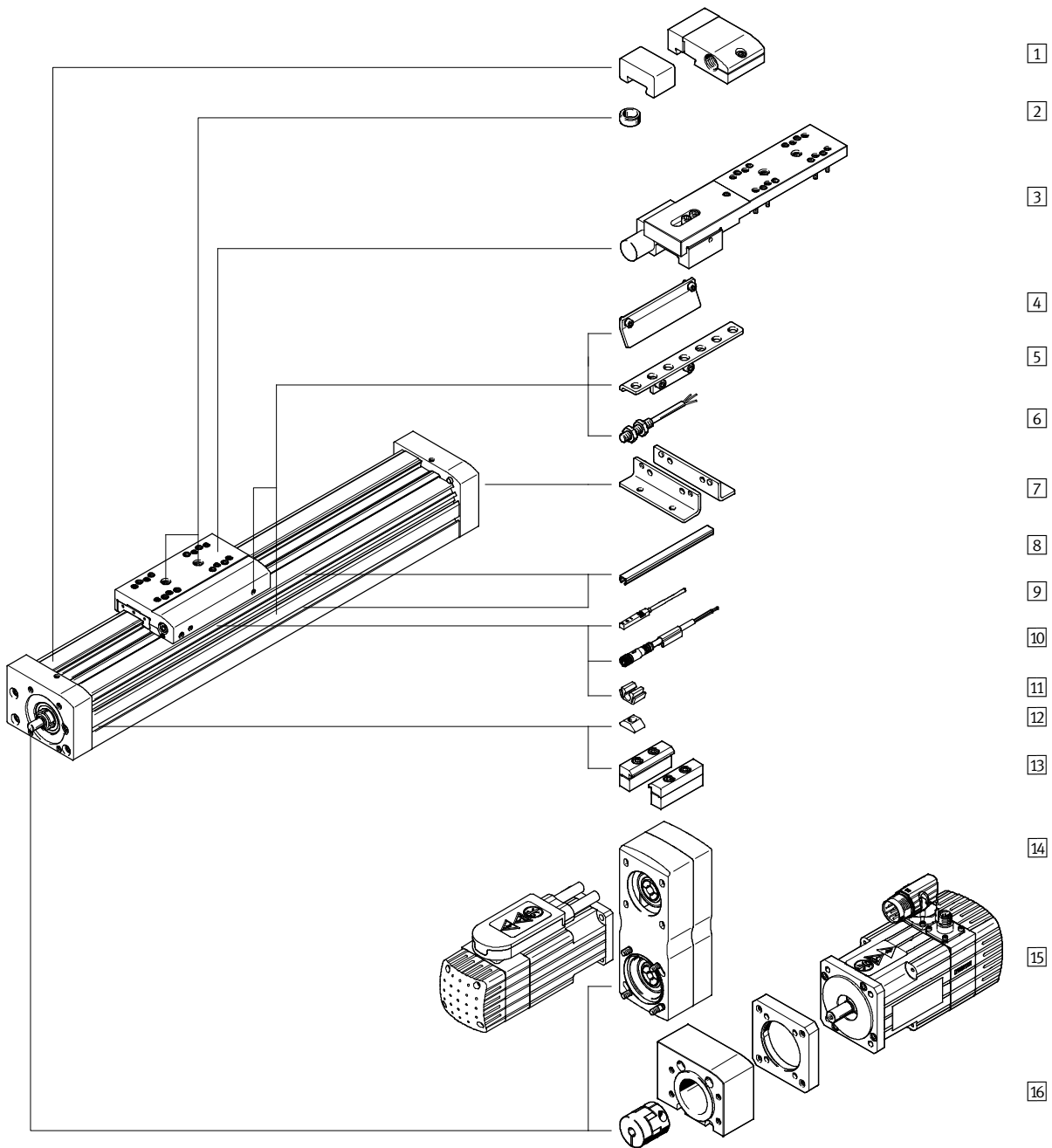

Spindle axes EGC-BS-KF, with recirculating ball bearing guide

Peripherals overview

Variants and accessories		
Type	Brief description	→ Page/Internet
1 Emergency buffer with retainer A	For avoiding damage at the end stop in the event of malfunction	47
2 Centring pin/sleeve ZBS, ZBH	<ul style="list-style-type: none"> For centring loads and attachments on the slide 2 centring pins/sleeves included in the scope of delivery of the axis 	49
3 Clamping unit 1H...-PN, 2H-PN	For holding loads	12
4 Switch lug X, Z, O, P, W, R	For sensing the slide position	47
5 Sensor bracket O, P, W, R	Adapter for mounting the inductive proximity sensors (round design) on the axis	48
6 Proximity sensor, M8 O, P, W, R	<ul style="list-style-type: none"> Inductive proximity sensor, round design The order code O, P, W, R includes 1 switch lug and max. 2 sensor brackets in the scope of delivery 	50
7 Foot mounting F	For mounting the axis on the end cap (only possible on one side)	46
8 Slot cover B, S	<ul style="list-style-type: none"> For protecting against ingress of dirt 	49
9 Proximity sensor, T-slot X, Z	<ul style="list-style-type: none"> Inductive proximity sensor, for T-slot The order code X, Z includes 1 switch lug in the scope of delivery 	49
10 Connecting cable V	For proximity sensor (order code W and R)	50
11 Clip CL	For mounting the proximity sensor cable in the slot	49
12 Slot nut Y	For mounting attachments	49
13 Profile mounting M	For mounting the axis on the profile	46
14 Parallel kit EAMM-U	For parallel motor mounting (consisting of: housing, clamping sleeve, toothed belt pulley, toothed belt)	44
15 Motor EMMS	Motors specially matched to the axis, with or without brake	42
16 Axial kit EAMM-A	For axial motor mounting (consisting of: coupling, coupling housing and motor flange)	42
- Passive guide axis EGC-FA	Axis without drive	egc-fa

Spindle axes EGC-BS-KF, with recirculating ball bearing guide

Type codes

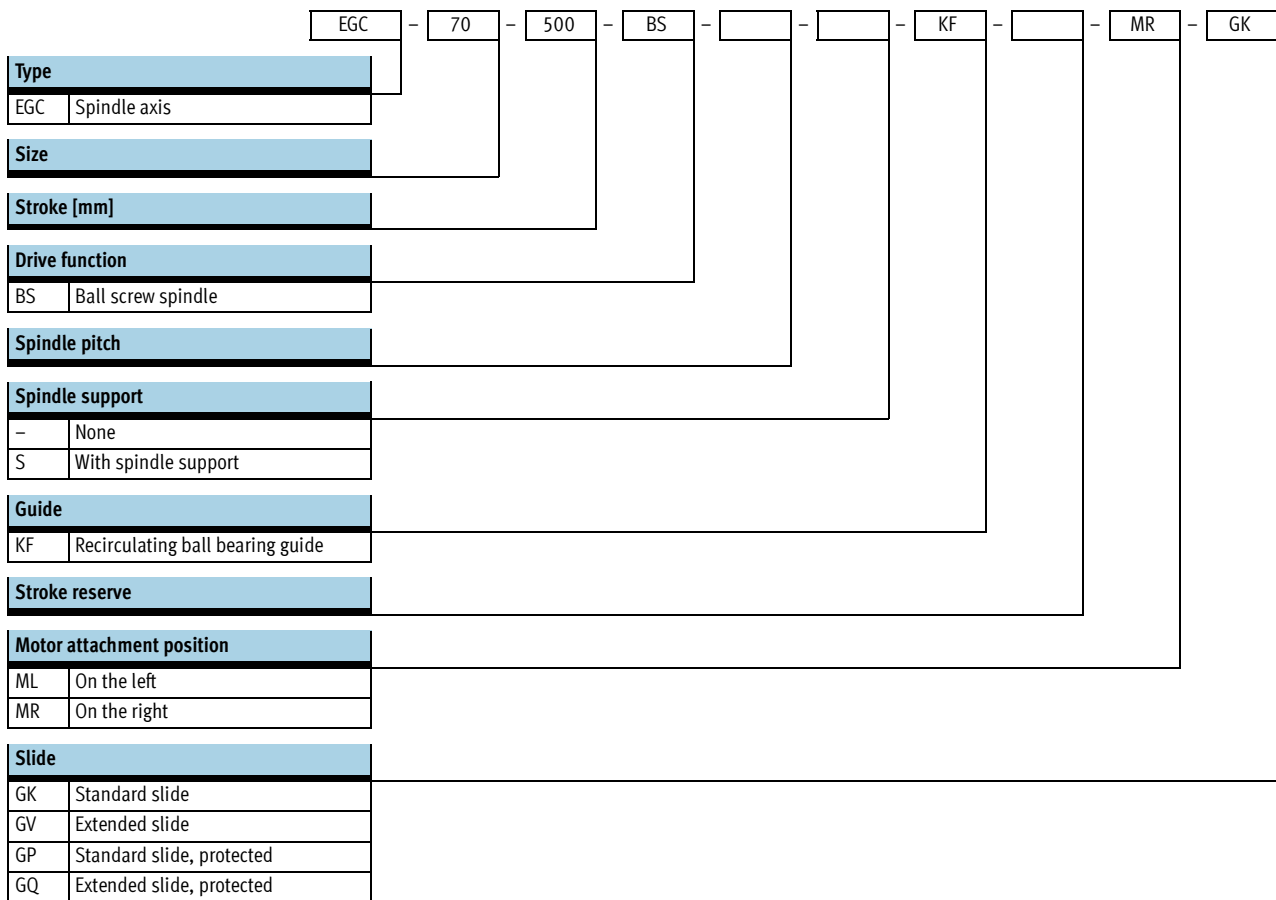

Spindle axes EGC-BS-KF, with recirculating ball bearing guide

FESTO

Type codes

→							ZUB	F2MX2Z	DN
Additional slide									
KL	Standard, left								
Additional slide									
KR	Standard, right								
Lubrication function									
-	Standard								
C	Lubrication adapter								
Displacement encoder, incremental									
M1	Resolution: 2.5 µm								
M2	Resolution: 10 µm								
Clamping unit									
1HL	1-channel, left								
1HR	1-channel, right								
2H	2-channel								
Actuation type									
PN	Pneumatically actuated								
Accessories enclosed separately									
F	Foot mounting								
...M	Profile mounting								
...B	Mounting slot cover								
...S	Sensor slot cover								
...Y	Slot nut for mounting slot								
...X	Proximity sensor (SIES), inductive, slot type 8, PNP, N/O contact, 7.5 m cable								
...Z	Proximity sensor (SIES), inductive, slot type 8, PNP, N/C contact, 7.5 m cable								
...A	Emergency buffer with retainer								
...O	Proximity sensor (SIEN), inductive, M8, PNP, N/O contact, 2.5 m cable								
...P	Proximity sensor (SIEN), inductive, M8, PNP, N/C contact, 2.5 m cable								
...W	Proximity sensor (SIEN), inductive, M8, PNP, N/O contact, plug M8								
...R	Proximity sensor (SIEN), inductive, M8, PNP, N/C contact, plug M8								
...V	Connecting cable								
...CL	Cable clip								
Operating instructions									
DN	None								



Spindle axes EGC-BS-KF, with recirculating ball bearing guide

FESTO

Technical data

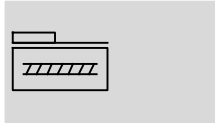
Function



-  Size
70 ... 185
-  Stroke length
50 ... 3,000 mm



General technical data							
Size		70	80		120		185
Spindle pitch		10	10	20	10	25	40
Design	Electromechanical axis with recirculating ball bearing spindle						
Guide	Recirculating ball bearing guide						
Mounting position	Any						
Working stroke							
EGC-...-GK/-GP	[mm]	50 ... 1,000	50 ... 2,000		50 ... 2,500		50 ... 3,000
EGC-...-GV/-GQ	[mm]	50 ... 900	50 ... 1,900		50 ... 2,400		50 ... 2,900
Max. feed force F_x	[N]	300	600		1,300		3,000
No-load torque	[Nm]	0.3	0.5	0.5	1.5	1.5	3.0
at min. travel speed	[m/s]	0.05	0.1	0.1	0.2	0.2	0.2
No-load torque	[Nm]	0.45	0.75	0.75	2.25	2.25	6.5
at max. travel speed	[m/s]	0.5	0.5	1	0.6	1.5	2
Max. radial force ¹⁾	[N]	220	250		500		4,000
Max. rotational speed ²⁾	[rpm]	3,000	3,000		3,600		3,000
Max. acceleration	[m/s ²]	15					
Repetition accuracy	[mm]	±0.02					

1) At the drive shaft

2) Rotational speed and speed are stroke-dependent

Operating and environmental conditions	
Ambient temperature	[°C] -10 ... +60
Protection class	IP40
Duty cycle	[%] 100

Weight [g]				
Size	70	80	120	185
Basic weight with 0 mm stroke ¹⁾				
EGC-...-GK/-GP	1,500	2,700	12,500	30,000
EGC-...-GV/-GQ	2,000	3,500	14,400	34,500
Additional weight per 10 mm stroke	50	80	190	390
Moving load				
EGC-...-GK/-GP	400	740	2,400	8,600
EGC-...-GV/-GQ	600	950	2,900	9,850
Additional slide				
EGC-...-KL/-KR	300	550	2,000	6,000
Clamping unit				
EGC-...-1H...-PN	-	700	2,300	4,900
EGC-...-2H-PN	-	1,300	4,000	8,300

1) Incl. slide

Spindle axes EGC-BS-KF, with recirculating ball bearing guide

Technical data

Spindle								
Size		70		80		120		185
Diameter	[mm]	12		15		25		40
Pitch	[mm/rev.]	10	10	20	10	25	40	

Mass moment of inertia								
Size		70		80		120		185
Spindle pitch		10	10	20	10	25	40	
J_0								
EGC-...-GK	[kg mm ²]	1.99	5.2	5.2	64.46	64.46	594	
EGC-...-GV	[kg mm ²]	3.41	8.67	8.68	92	92	774.71	
J_H per metre stroke	[kg mm ² /m]	14.2	34.6	34.6	275.6	275.6	1,803.1	
J_L per kg effective load	[kg mm ² /kg]	2.53	2.53	10.13	2.53	15.83	40.53	
J_W Slide								
EGC-...-GK	[kg mm ²]	1.04	1.86	7.46	6.09	38.06	348.87	
EGC-...-GV	[kg mm ²]	1.48	2.34	9.35	7.34	45.85	399.08	
J_F Clamping unit								
EGC-...-1H...-PN	[kg mm ²]	–	1.78	7.1	5.8	36.4	198.5	
EGC-...-2H-PN	[kg mm ²]	–	3.3	13.2	10	63.3	336.4	

The mass moment of inertia J_A of the entire axis is calculated as follows:

$$J_A = J_0 + \sum J_W + J_H \times \text{working stroke [m]} + J_L \times m_{\text{effective load [kg]}} + J_F$$

$\sum J_W$ = Total mass moment of inertia of all slides (including the first slide)

Materials

Sectional view

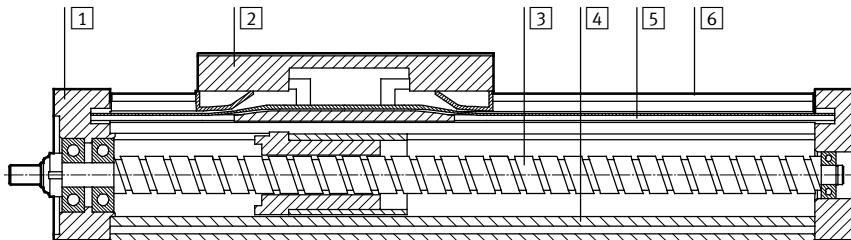

Axis		
1	End cap	Anodised wrought aluminium alloy
2	Slide	Anodised wrought aluminium alloy
3	Spindle	Steel
4	Profile	Anodised aluminium
5	Cover band	Polyurethane
6	Guide rail	High-alloy steel
Note on materials		RoHS-compliant

Spindle axes EGC-BS-KF, with recirculating ball bearing guide

FESTO

Technical data

Technical data – Displacement encoder			Dimensions → 33
Type	EGC-...-M1	EGC-...-M2	
Resolution	[μm]	2.5	10
Max. travel speed			
With motor controller CMM...	[m/s]	4	4
With safety system CMGA...	[m/s]	1	4
Electrical connection	8-pin plug, round design, M12		
Cable length	[mm]	160	

Operating and environmental conditions – Displacement encoder	
Ambient temperature	[°C] -10 ... +70
Protection class	IP64
CE marking (see declaration of conformity)	To EU EMC Directive ¹⁾

- 1) For information about the applicability of the component see the manufacturer's EC declaration of conformity at: www.festo.com → Support → User documentation.
If the component is subject to restrictions on usage in residential, office or commercial environments or small businesses, further measures to reduce the emitted interference may be necessary.

Instructions for use

The spindle axis with displacement encoder is not designed for the following sample applications:

- Magnetic field

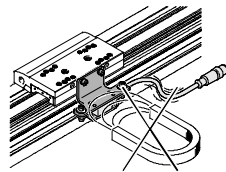

- Welding application

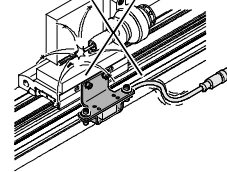

Technical data – Clamping unit				Dimensions → 34
Size		80	120	185
Pneumatic connection		M5	M5	M5
Clamping type	Clamping via spring force, released via compressed air			
Static holding force				
EGC-...-1H...-PN	[N]	320	1,200	1,500
EGC-...-2H-PN	[N]	640	2,400	3,000
Max. number of emergency braking operations ¹⁾ at reference energy	[Nm]	-	750 35	750 70
Number of clamping operations under nominal load	[million switching cycles]	0.45	0.05	> 1.4

- 1) Emergency braking refers to braking the effective load if the drive axis loses power.

Operating and environmental conditions – Clamping unit	
Operating medium	Compressed air according to ISO 8573-1:2010 [7:4:4]
Operating pressure	
Clamping unit opened	[bar] 4.5 ... 8
Clamping unit closed	[bar] Pressureless
Ambient temperature	[°C] -10 ... +60

Note

The axis can only be relubricated with the lubrication adapter when used in combination with the clamping unit (EGC-...-C).

Spindle axes EGC-BS-KF, with recirculating ball bearing guide

Technical data

Characteristic load values

The indicated forces and torques refer to the slide surface. The point of application of force is the point where the centre of the guide and the longitudinal centre of the slide intersect. These values must not be exceeded during dynamic operation. Special attention must be paid to the cushioning phase.

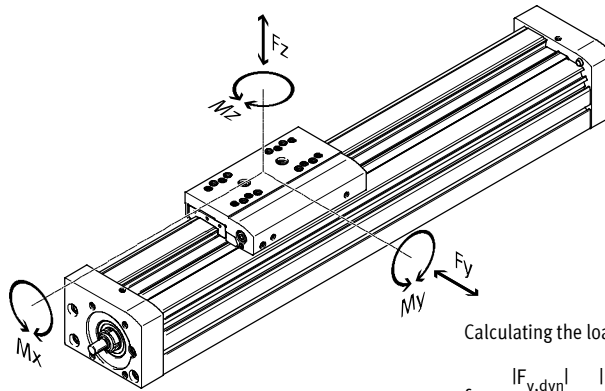

If the axis is subjected to more than two of the indicated forces and torques simultaneously, the following equation must be satisfied in addition to the indicated maximum loads:

Calculating the load comparison factor:

$$f_v = \frac{|F_{y,dyn}|}{F_{y,max}} + \frac{|F_{z,dyn}|}{F_{z,max}} + \frac{|M_{x,dyn}|}{M_{x,max}} + \frac{|M_{y,dyn}|}{M_{y,max}} + \frac{|M_{z,dyn}|}{M_{z,max}}$$

Permissible forces and torques						
Size		70	80	120	185	
F _{y,max.}	[N]	1,850	3,050	6,890	15,200	
F _{z,max.}	[N]	1,850	3,050	6,890	15,200	
M _{x,max.}	[Nm]	16	36	144	529	
M _{y,max./M_{z,max.}}						
EGC-...GK/-GP	[Nm]	51	97	380	1,157	
M _{y,max./M_{z,max.}}						
EGC-...GV/-GQ	[Nm]	132	228	680	1,820	

Basic load ratings							
Size		70	80	120	185		
Spindle pitch		10	10	20	10	25	40
Ball screw							
Dynamic c _{dyn,BS}	[N]	4,000	6,820	7,480	16,000	13,700	36,200

Calculating service life

The service life of the guide depends on the load. To provide a rough indication of the service life of the guide, the

graph below plots the load comparison factor f_v against the service life.

These values are only theoretical. You must consult your local Festo contact for load comparison factors f_v greater than 1.5.

Load comparison factor f_v as a function of service life

Example:

A user wants to move an X kg load. Using the formula → 13 gives a value of 1.5 for the load comparison factor f_v . According to the graph, the guide would have a service life of

approx. 1,500 km. Reducing the acceleration reduces the Mz and My values. A load comparison factor f_v of 1 now gives a service life of 5,000 km.

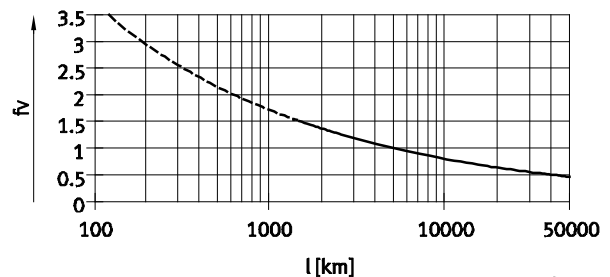

Note

PositioningDrives
sizing software
www.festo.com

The guide workload for a service life of 5,000 km can be calculated with the help of the sizing software.

$f_v > 1.5$ are only theoretical comparison values for the recirculating ball bearing guide.

Spindle axes EGC-BS-KF, with recirculating ball bearing guide

Technical data

FESTO

Speed v as a function of working stroke l

EGC-70

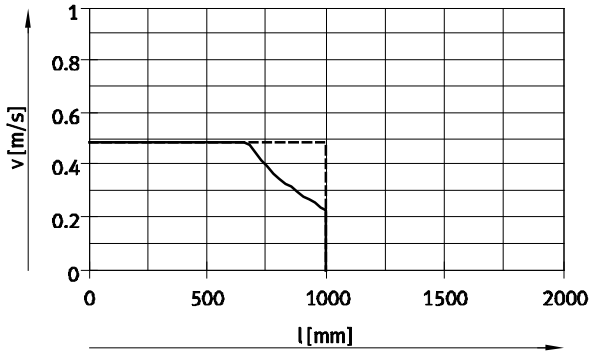

— EGC-70-10P without spindle support
 - - - EGC-70-10P with spindle support

EGC-80

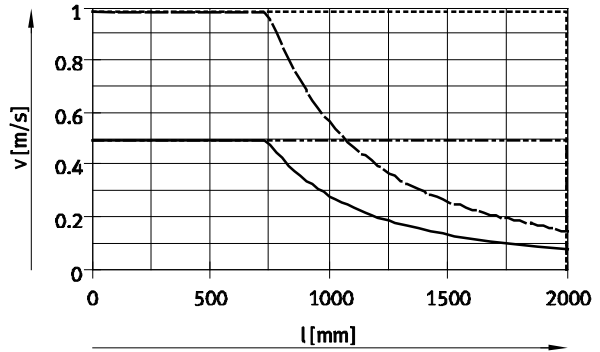

— EGC-80-10P without spindle support
 - - - EGC-80-10P with spindle support
 — EGC-80-20P without spindle support
 - - - EGC-80-20P with spindle support

EGC-120

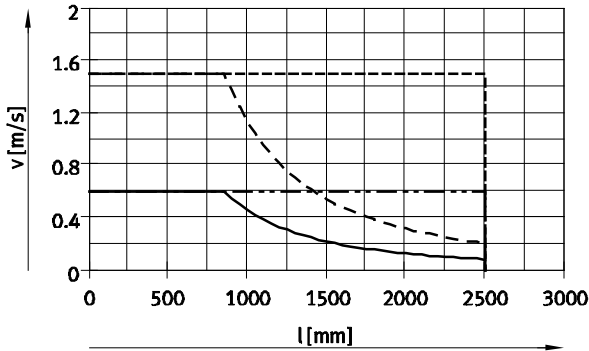

— EGC-120-10P without spindle support
 - - - EGC-120-10P with spindle support
 — EGC-120-25P without spindle support
 - - - EGC-120-25P with spindle support

EGC-185

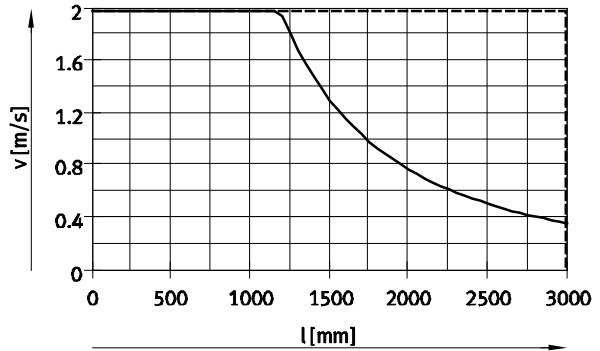

— EGC-185-40P without spindle support
 - - - EGC-185-40P with spindle support

Speed v as a function of rotational speed n

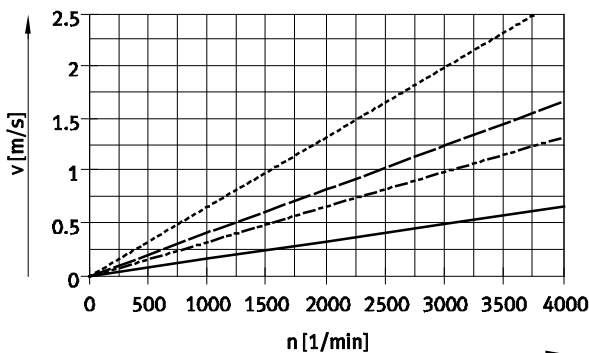

Note
 Rotational speed is stroke-dependent.
 Note maximum rotational speed.

— EGC-70/-80-10P/-120-10P
 - - - EGC-80-20P
 — EGC-120-25P
 ····· EGC-185

Spindle axes EGC-BS-KF, with recirculating ball bearing guide

Technical data

Maximum acceleration a as a function of applied load m

EGC-70

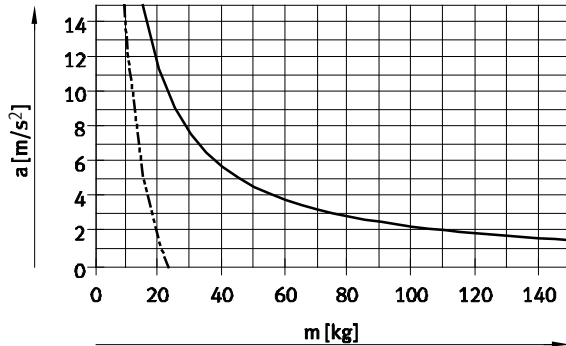

EGC-80

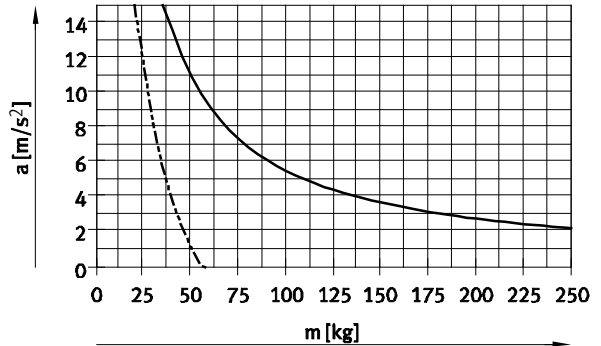

EGC-120

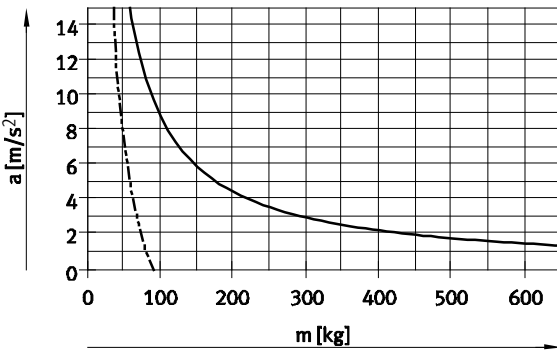

EGC-185

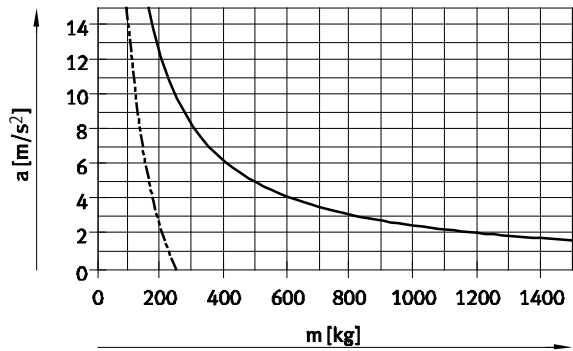

— Horizontal mounting position - - - - - Vertical mounting position

Theoretical feed force F as a function of input torque M

EGC-70/-80

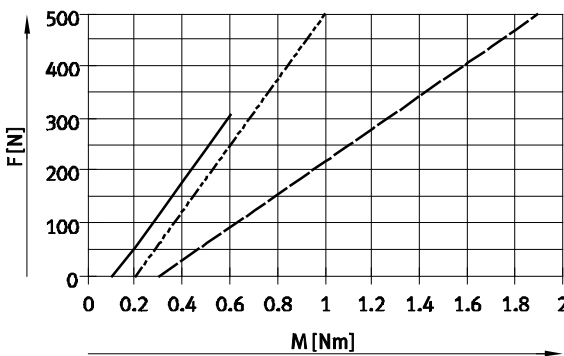

EGC-120/-185

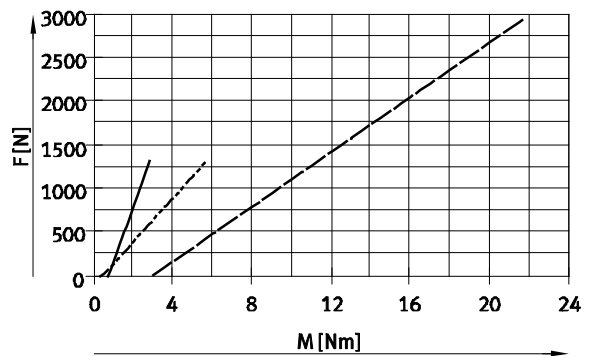

— EGC-70-10P - - - - - EGC-80-20P
 ····· EGC-80-10P

— EGC-120-BS-10P - - - - - EGC-185-BS-40P
 ····· EGC-120-BS-25P

Spindle axes EGC-BS-KF, with recirculating ball bearing guide

Technical data

Stroke reserve

Stroke length	Stroke reserve		
The selected stroke corresponds in principle to the required working stroke. The variants GK/GV do not have a wiper seal on the guide. These variants therefore additionally have a safety distance between the drive cap and slide that is not designated as part of the working stroke.	A safety distance (similar to GK/GV) between the drive cap and slide can be defined for the variants GP/GQ and GK-C/GV-C using the modular product system via the "stroke reserve" feature. With the variants GK/GV, the stroke reserve and safety distance are added for each end position.	<ul style="list-style-type: none"> The stroke reserve length can be freely selected The sum of the stroke length and 2x stroke reserve must not exceed the maximum working stroke 	Example: EGC-70-500-BS-10P-KF-20H-... Working stroke = 500 mm 2x stroke reserve = 40 mm Total stroke = 540 mm (540 mm = 500 mm + 2x 20 mm)

Size	70	80	120	185		
Spindle pitch	10	10	20	10	25	40
L9 = safety distance with GK/GV (per end position) [mm]	10.5	13	13	18	18	21

Working stroke reduction

With standard slide GK/GP / extended slide GV/GQ with additional slide KL/KR

- The working stroke is reduced by the length of the additional slide and the distance between both slides
- If the variant GP/GQ is ordered, the additional slide is also protected
- If the variant GV/GQ is ordered, the additional slide is not extended
- If the variant GK-C/GV-C is ordered, the additional slide is also supplied with lubrication adapters

L16 = Slide length	L18 = Distance between both slides	Example:	
L17 = Additional slide length	1 Additional slide	Type EGC-70-500-BS-...-GK-KR	Working stroke with additional slide = 380 mm
		Working stroke without additional slide = 500 mm	(500 mm - 20 mm - 100 mm)
		L18 = 20 mm	
		L16, L17 = 100 mm	

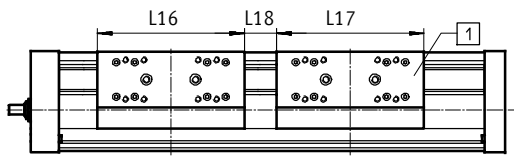

Dimensions – Additional slide

Size	70		80		120		185	
	GK/GV	GP/GQ	GK/GV	GP/GQ or GK-C/GV-C	GK/GV	GP/GQ or GK-C/GV-C	GK/GV	GK-C/GV-C
Length L17 [mm]	100	121	120	146	200	236	280	322
Min. distance between the slides L18 [mm]	-	21	-	26	-	36	-	42

Working stroke reduction per side

With integrated emergency buffer NPE and shock absorber retainer KYE

- The working stroke is reduced by the total dimension of the emergency buffer and shock absorber retainer.
- The rubber buffer in the cap must be removed.
- Shock absorbers must not be used in combination with lubrication adapters.

Size	70	80	120	185
With emergency buffer [mm]	43	68	98	133

Spindle axes EGC-BS-KF, with recirculating ball bearing guide

Technical data

Working stroke reduction

With integrated clamping unit

- The working stroke is reduced by the length of the clamping unit.
- With 1-channel clamping units, the stroke is reduced on one side with respect to the mounting surface.
- With 2-channel clamping units, the stroke is reduced symmetrically with respect to the mounting surface of the load.
- Shock absorbers must not be used in combination with the clamping unit.

Size	80	120	185
EGC-...-1H...-PN [mm]	87	124	131
EGC-...-2H-PN [mm]	174	248	262

2nd moment of area

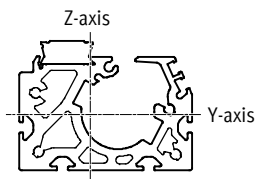

Size	70	80	120	185
I_y [mm ⁴]	4.19×10^5	9.81×10^5	5.01×10^6	2.61×10^7
I_z [mm ⁴]	5.78×10^5	1.32×10^6	5.82×10^6	2.6×10^7

Maximum permissible support span L (without profile mounting) as a function of force F

In order to limit deflection in the case of large strokes, the axis may need to be supported.

The following graphs can be used to determine the maximum permissible support span l as a function of force F acting on the axis. The deflection is $f = 0.5$ mm.

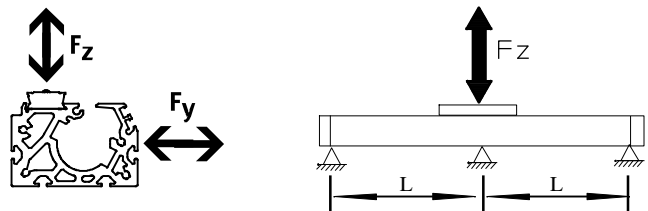

Force F_y

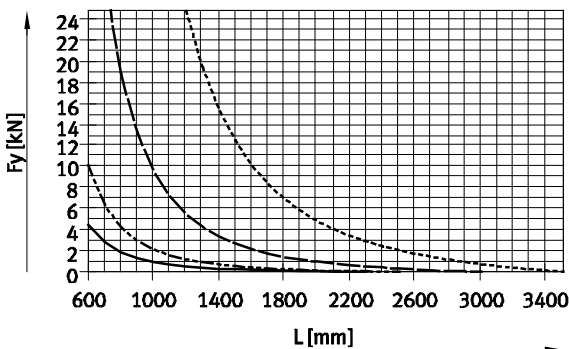

Force F_z

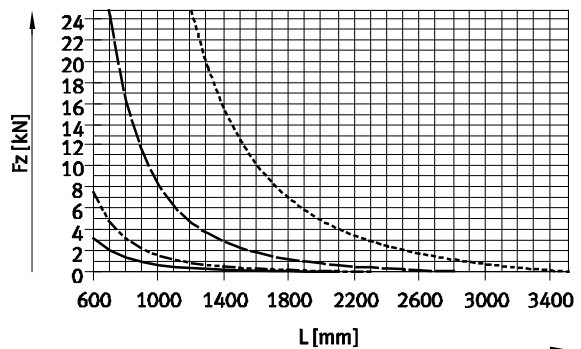

- EGC-70
- EGC-120
- EGC-80
- EGC-185

Recommended deflection limits

Adherence to the following deflection limits is recommended so as not to impair the functional performance of

the axes. Greater deformation can result in increased friction, greater wear and reduced service life.

Size	Dyn. deflection (load moving)	Stat. deflection (load stationary)
70 ... 185	0.05% of the axis length, max. 0.5 mm	0.1% of the axis length

Spindle axes EGC-BS-KF, with recirculating ball bearing guide

Technical data

Dimensions Download CAD data → www.festo.com

+ = plus stroke length + 2x stroke reserve
 L9 With GK/GV: safety distance per end position
 With GP/GQ: dimension for wiper seal → 16
 With GK-C/GV-C: dimension for adapter → 28
 Working stroke reduction in combination with additional slide → 16

Size	Variant	Stroke	B1	B2	B3	B4	B5	B6	B7	B9	D1 ∅ H7	D2 ∅ h7	D3
70	GK/GP	50 ... 1,000	69	58.6	16.5	30	45	29	39	1	38	6	≈13
	GV/GQ	50 ... 900											
80	GK/GP	< 1,477	82	72.6	22	40	60	35	46.75	1	48	8	∅18
		≥ 1,477											
	GV/GQ	< 1,377											
		≥ 1,377											
120	GK/GP	< 1,704	120	107	33	80	40	64	78	1	62	12	∅28
		≥ 1,704											
	GV/GQ	< 1,604											
		≥ 1,604											
185	GK/GP	< 2,361	186	169	53	120	80	80	114	1	95	25	∅44
		≥ 2,361											
	GV/GQ	< 2,261											
		≥ 2,261											

Spindle axes EGC-BS-KF, with recirculating ball bearing guide

Technical data

Size	Variant	Stroke	D4	D5 ∅ H7	D6	D8 ∅ H7	H1	H2	H3	H5	H6	H7	L1	L2
70	GK/GP	50 ... 1,000	M5	-	M5	5	64	22.5	50.5	13	13	36	168	86.5
	GV/GQ	50 ... 900											268	136.5
80	GK/GP	< 1,477	M5	9	M5	5	76.5	27	62	17.5	15	46	196	101
		≥ 1,477											236	121
	GV/GQ	< 1,377											296	151
		≥ 1,377											336	171
120	GK/GP	< 1,704	M6	-	M8	9	111.5	42.5	89.5	22	22	54	309	156
		≥ 1,704											369	186
	GV/GQ	< 1,604											409	206
		≥ 1,604											469	236
185	GK/GP	< 2,361	M8	-	M10	9	172.5	65.2	141.5	25	25	80	412	209
		≥ 2,361											512	259
	GV/GQ	< 2,261											512	259
		≥ 2,261											612	309

Size	Variant	Stroke	L3	L4	L5	L6	L7	L8	L9	T1	T2	T6	T7	T9
70	GK/GP	50 ... 1,000	21	8	14	1.8	16	3	10.5	2.5	12	-	10	3.1
	GV/GQ	50 ... 900												
80	GK/GP	< 1,477	23	12.5	18	2	17	3	13	2.5	12	2.1	10	3.1
		≥ 1,477												
	GV/GQ	< 1,377												
		≥ 1,377												
120	GK/GP	< 1,704	33	17.5	25.5	2	30	3	18	3	15	-	16	2.1
		≥ 1,704												
	GV/GQ	< 1,604												
		≥ 1,604												
185	GK/GP	< 2,361	43	23	30.5	2	37	3	21	3	20	-	20	2.1
		≥ 2,361												
	GV/GQ	< 2,261												
		≥ 2,261												

 Note
 To avoid distortion in the slide, the bearing surfaces of the attachments must maintain a minimum flatness of 0.01 mm.

Spindle axes EGC-BS-KF, with recirculating ball bearing guide

Technical data

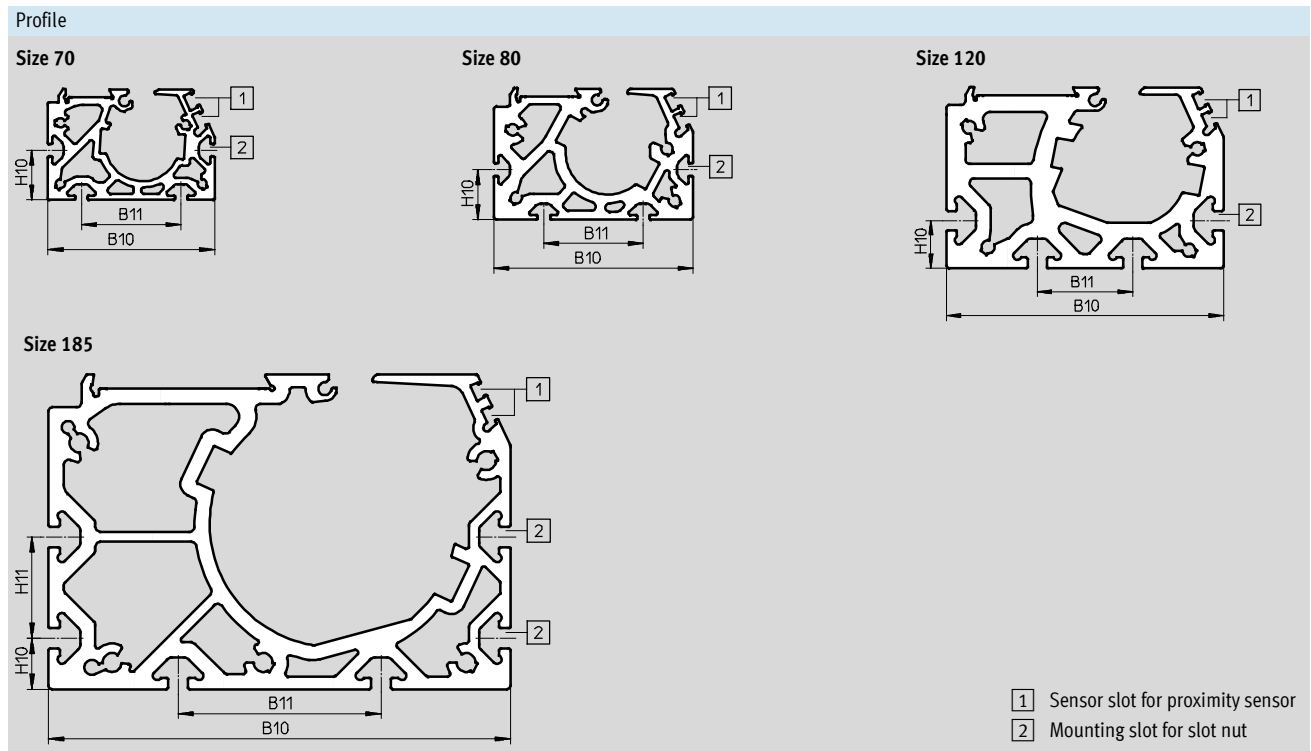

Size	B10	B11	H10	H11
70	67	40	20	-
80	80	40	20	-
120	116	40	20	-
185	182	80	20	40

Spindle axes EGC-BS-KF, with recirculating ball bearing guide

Technical data

Dimensions Download CAD data → www.festo.com

GK – Standard slide/GP – Standard slide, protected

Size 70

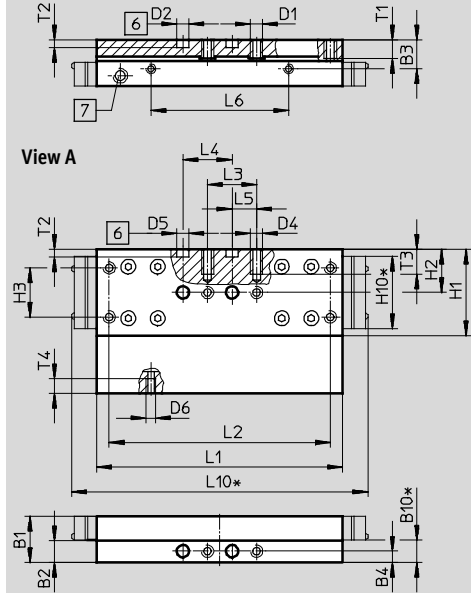

Size 80

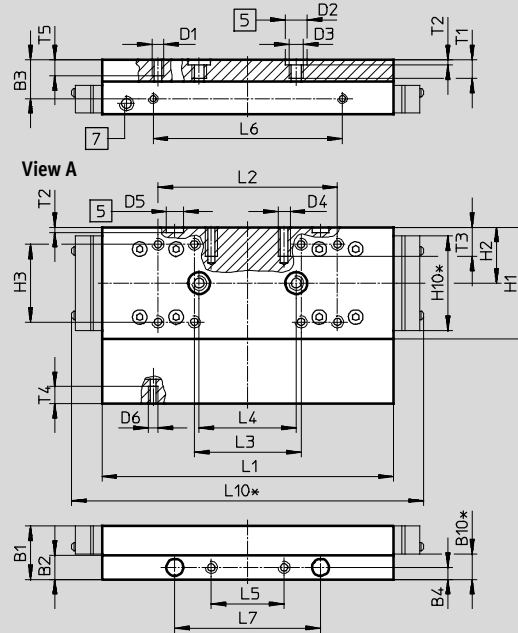

- 5 Hole for centring sleeve
- 6 Hole for centring pin
- 7 Lubricating hole for spindle
M6 threaded connection, 8 mm deep
- * Protected version

Size	B1	B2	B3	B4	B10*	D1	D2 ∅ H7	D3	D4	D5 ∅ H7	D6	H1	H2	H3
70	18.7	8.7	11.7	4.5	9	M5	5	–	M5	5	M4	35	17.5	20 ±0.1
80	22	10	16	5	10.4	M5	9	M6	M5	7	M4	46	23	32 ±0.2

Size	H10*	L1	L2	L3	L4	L5	L6	L7	L10*	T1	T2	T3	T4	T5
		±0.1			±0.03		±0.1	±0.05			+0.1			
70	29.4	100	90 ±0.1	20 ±0.1	20	10 ±0.1	56	–	121	7.5	3.1	10	6	–
80	39	120	74 ±0.2	44 ±0.2	40	30 ±0.1	78	60	145	8.6	2.1	12	7	7.5

* Protected version

Spindle axes EGC-BS-KF, with recirculating ball bearing guide

Technical data

Dimensions Download CAD data → www.festo.com

GK – Standard slide/GP – Standard slide, protected

Size 120

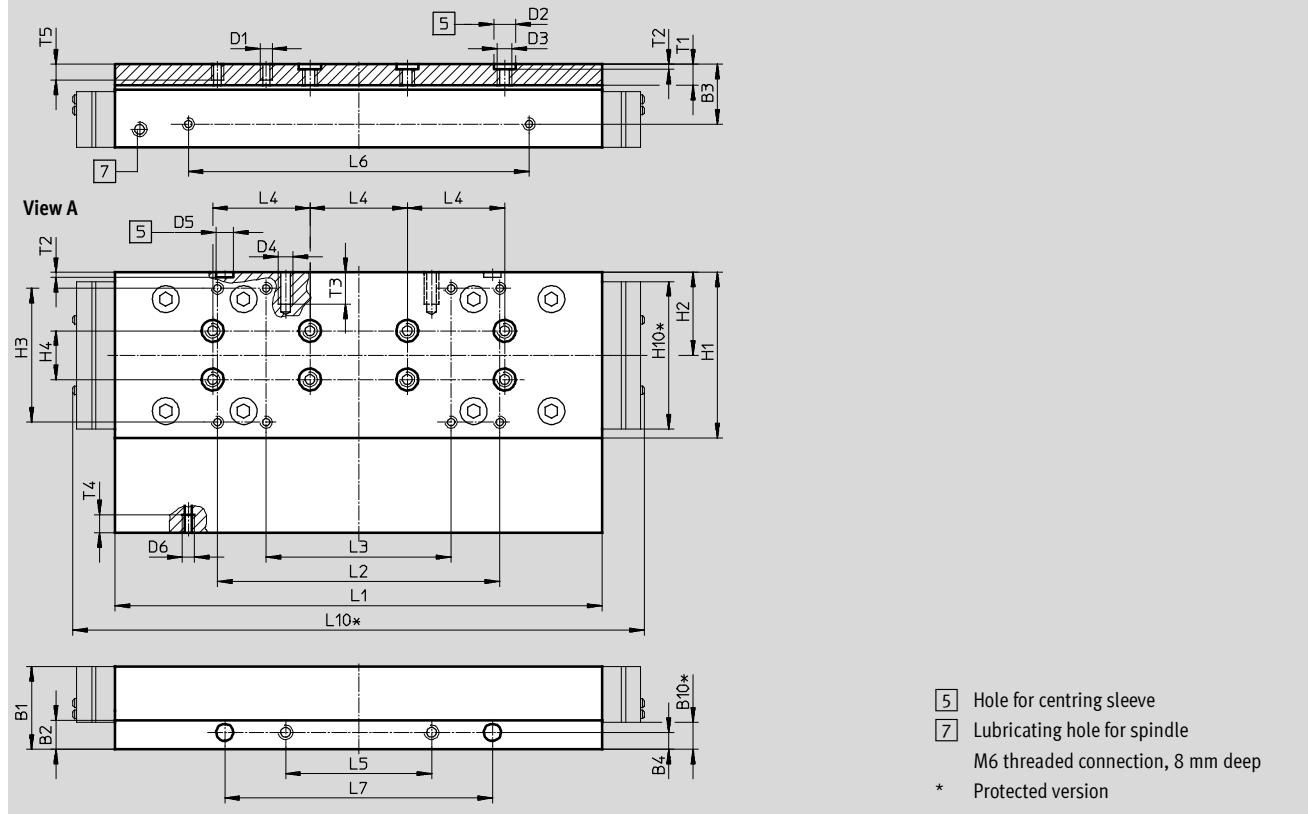

Size	B1	B2	B3	B4	B10*	D1	D2 ∅ H7	D3	D4	D5 ∅ H7	D6	H1	H2	H3	H4 ±0.03
120	34	12	24.5	7	11.2	M5	9	M6	M6	7	M5	68	34	55 ±0.2	20

Size	H10*	L1	L2	L3	L4	L5	L6	L7	L10*	T1	T2	T3	T4	T5
120	60.6	±0.1	±0.2	±0.2	±0.03	±0.1	±0.1	±0.05	235	8.6	±0.1	13	7.5	7.5

* Protected version

Spindle axes EGC-BS-KF, with recirculating ball bearing guide

Technical data

Dimensions Download CAD data → www.festo.com
 GK – Standard slide

Size 185

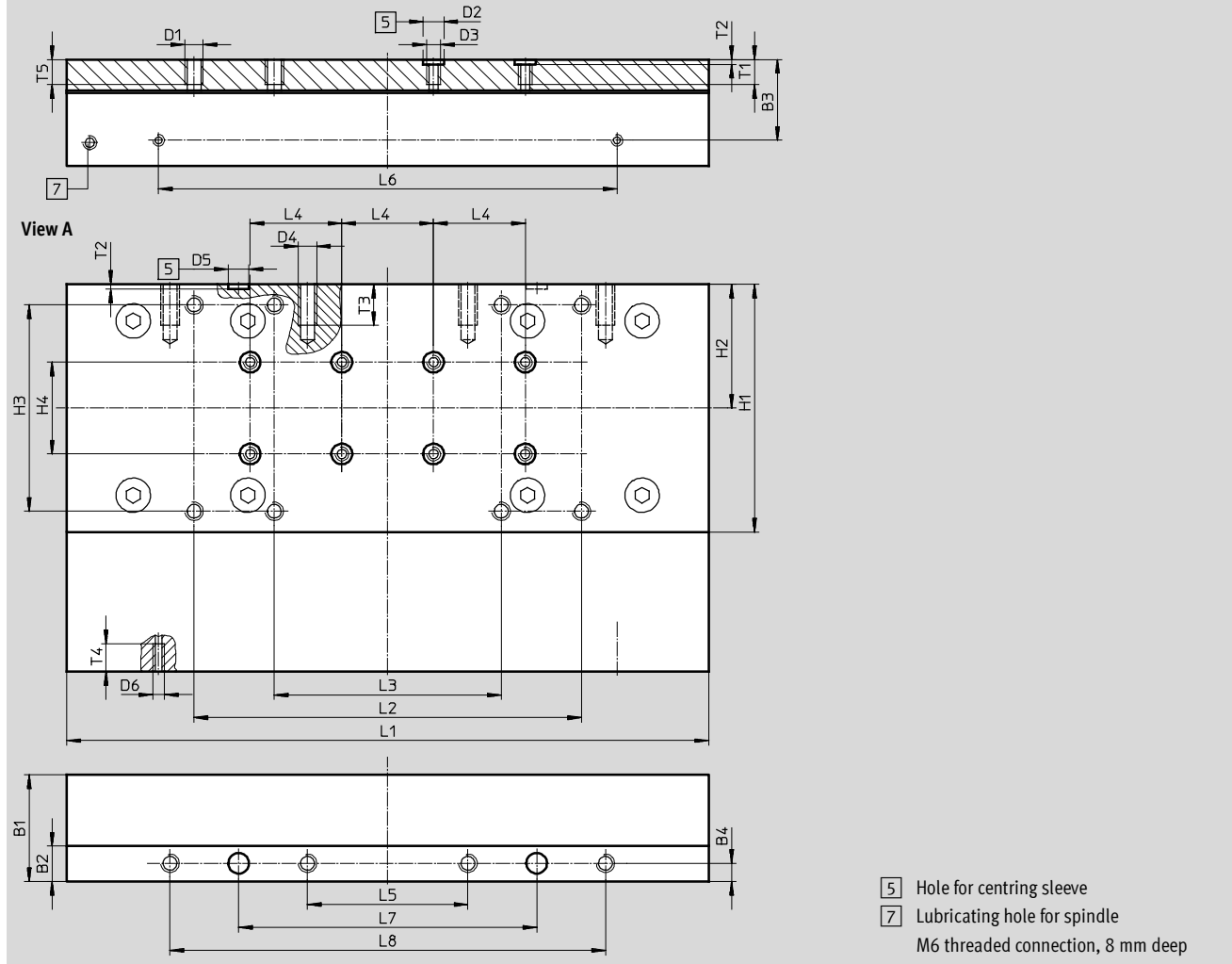

Size	B1	B2	B3	B4	D1	D2 ∅ H7	D3	D4	D5 ∅ H7	D6	H1	H2	H3 ±0.2	H4 ±0.03
185	46.5	15.5	35.2	8	M8	9	M6	M8	9	M5	108	54	90	40

Size	L1	L2	L3	L4	L5	L6	L7	L8	T1	T2 +0.1	T3	T4	T5
185	±0.1	±0.2	±0.2	±0.03	±0.2	±0.1	±0.05	±0.2	11	2.1	18	12.3	12

Spindle axes EGC-BS-KF, with recirculating ball bearing guide

Technical data

Dimensions Download CAD data → www.festo.com

GV – Extended slide/GQ – Extended slide, protected

Size 70

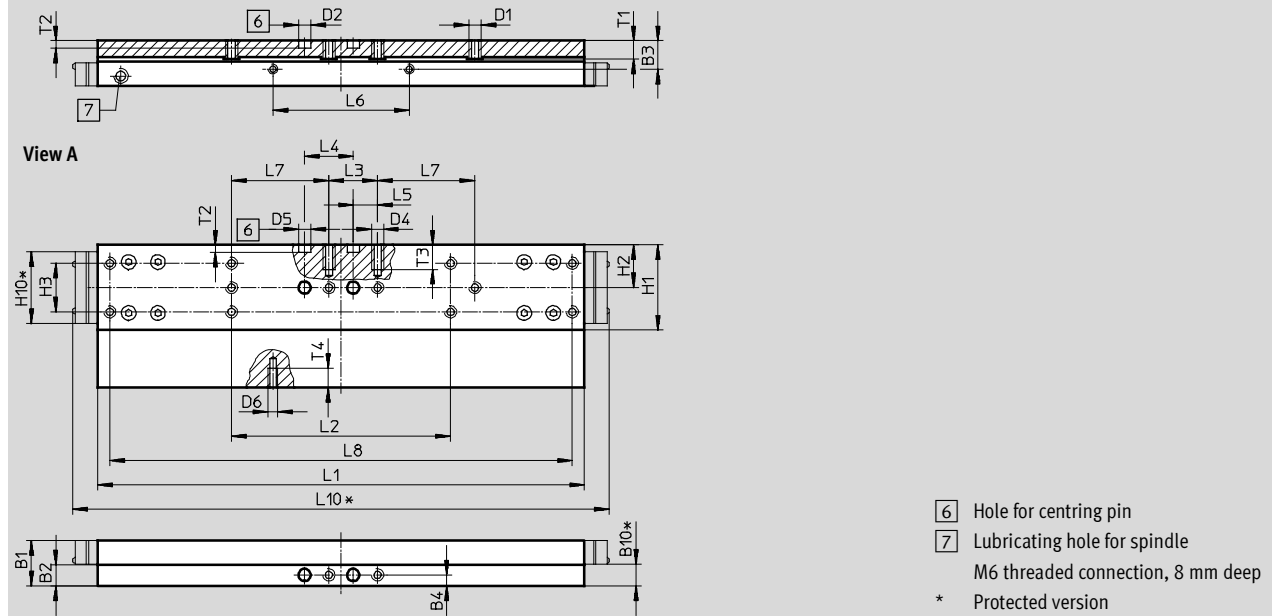

Size	B1	B2	B3	B4	B10*	D1	D2 ∅ H7	D4	D5 ∅ H7
70	18.7	8.7	11.7	4.5	9	M5	5	M5	5

Size	D6	H1	H2	H3	H10*	L1	L2	L3	L4
				±0.1		±0.1	±0.1	±0.1	±0.03
70	M4	35	17.5	20	29.4	200	90	20	20

Size	L5	L6	L7	L8	L10*	T1	T2	T3	T4
	±0.1	±0.1	±0.1	±0.2			+0.1		
70	10	56	40	190	221	7.5	3.1	10	6

* Protected version

Spindle axes EGC-BS-KF, with recirculating ball bearing guide

Technical data

Dimensions Download CAD data → www.festo.com

GV – Extended slide/GQ – Extended slide, protected

Size 80

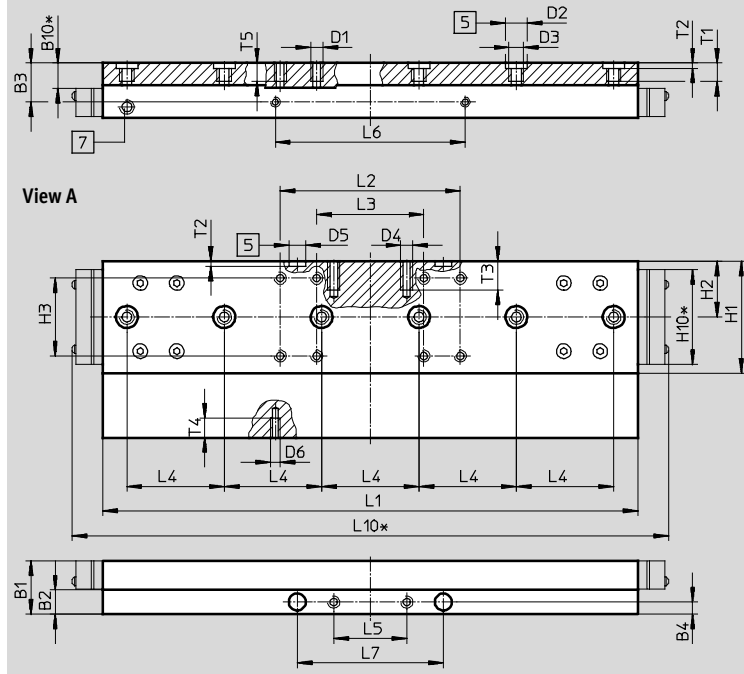

- 5 Hole for centring sleeve
- 7 Lubricating hole for spindle
M6 threaded connection, 8 mm deep
- * Protected version

Size	B1	B2	B3	B4	B10*	D1	D2 Ø H7	D3	D4	D5 Ø H7
80	22	10	16	5	10.4	M5	9	M6	M5	7

Size	D6	H1	H2	H3	H10*	L1	L2	L3	L4
80	M4	46	23	±0.2	39	±0.1	±0.2	±0.2	±0.03

Size	L5	L6	L7	L10*	T1	T2	T3	T4	T5
80	±0.1	±0.1	±0.05	245	8.6	+0.1	12	7	7.5

* Protected version

Spindle axes EGC-BS-KF, with recirculating ball bearing guide

Technical data

Dimensions Download CAD data → www.festo.com

GV – Extended slide/GQ – Extended slide, protected

Size 120

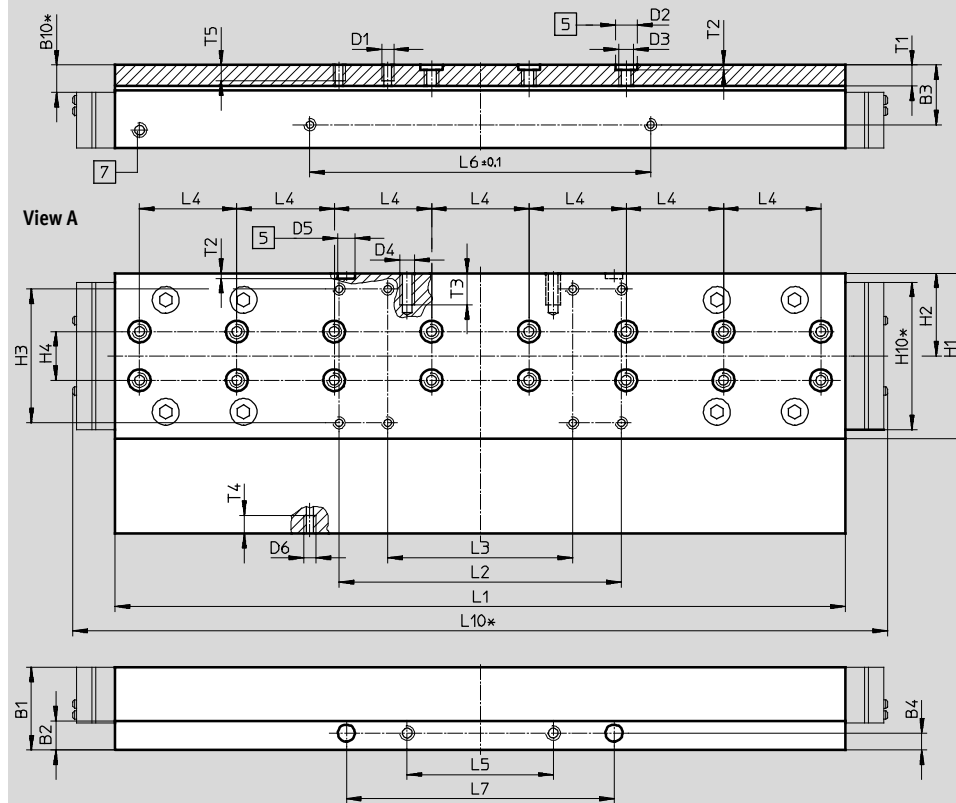

- 5 Hole for centring sleeve
- 7 Lubricating hole for spindle
M6 threaded connection, 8 mm deep
- * Protected version

Size	B1	B2	B3	B4	B10*	D1	D2 ∅ H7	D3	D4	D5 ∅ H7
120	34	12	24.5	7	11.2	M5	9	M6	M6	7

Size	D6	H1	H2	H3	H4	H10*	L1	L2	L3	L4	
120	M5	68	34	55 ±0.2	20	60.6	±0.1	303.3	116 ±0.2	76 ±0.2	±0.03

Size	L5	L6	L7	L8	L10*	T1	T2	T3	T4	T5
120	±0.1	±0.1	110 ±0.05	–	335	8.6	±0.1	13	7.5	7.5

* Protected version

Spindle axes EGC-BS-KF, with recirculating ball bearing guide

Technical data

Dimensions Download CAD data → www.festo.com

GV – Extended slide

Size 185

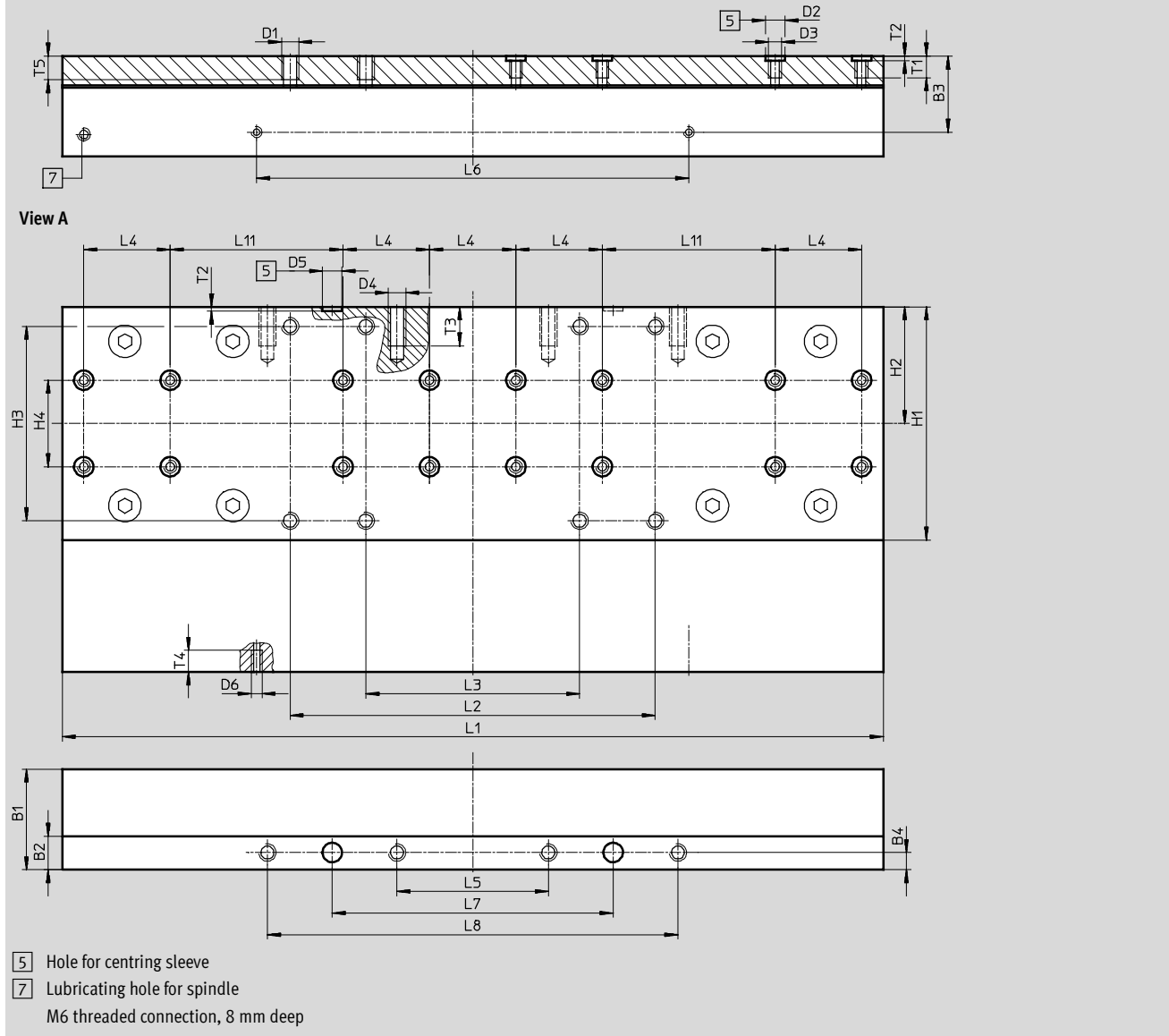

Size	B1	B2	B3	B4	D1	D2 ∅ H7	D3	D4	D5 ∅ H7
185	46.5	15.5	35.2	8	M8	9	M6	M8	9

Size	D6	H1	H2	H3	H4	L1	L2	L3	L4
185	M5	108	54	±0.2	±0.03	±0.1	±0.2	±0.2	±0.03

Size	L5	L6	L7	L8	L11	T1	T2	T3	T4	T5
185	±0.2	±0.1	±0.05	±0.2	±0.03	11	+0.1	18	10	12

Spindle axes EGC-BS-KF, with recirculating ball bearing guide

Technical data

Dimensions Download CAD data → www.festo.com

GK-C – Standard slide with lubrication adapter

Size 80

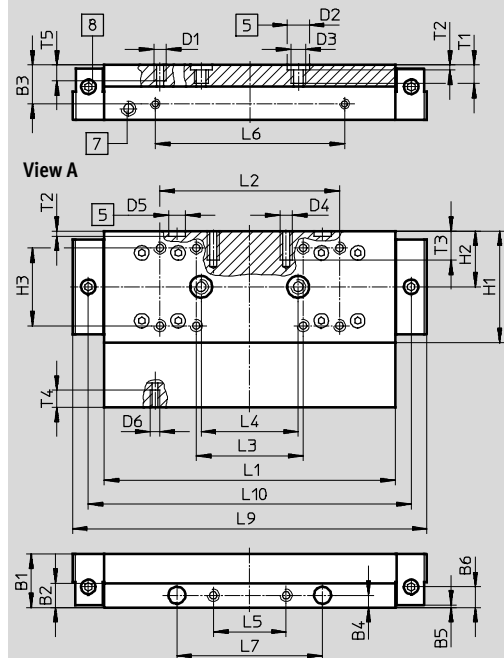

Size 120

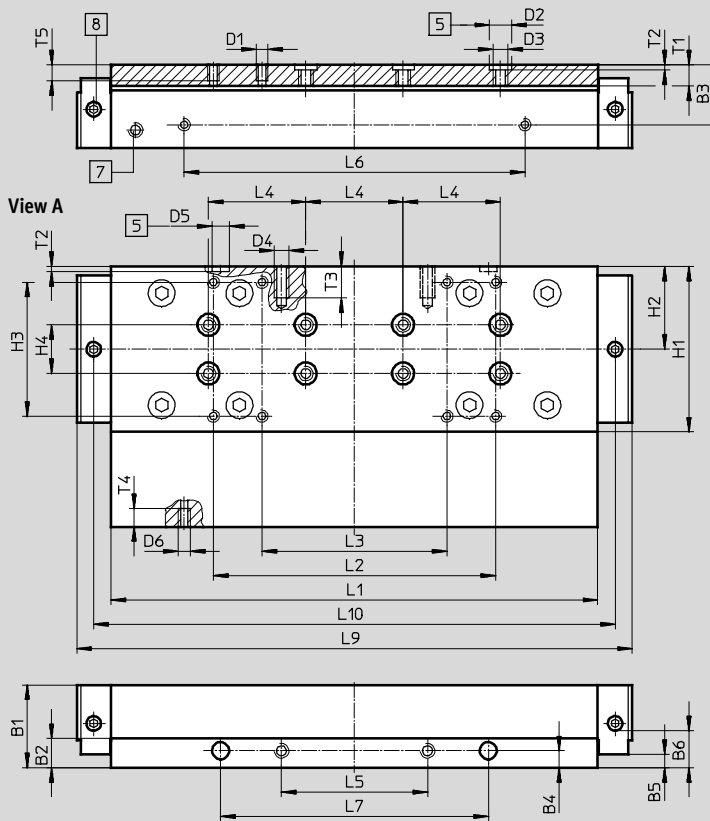

- 5 Hole for centring sleeve
- 7 Lubricating hole for spindle
M6 threaded connection, 8 mm deep
- 8 Lubricating hole for lubrication adapter
M6 threaded connection, 6 mm deep

Size	B1	B2	B3	B4	B5	B6	D1	D2	D3	D4
					±0.1			∅ H7		
80	22	10	16	5	1	8.5	M5	9	M6	M5
120	34	12	24.5	7	5.5	18.2	M5	9	M6	M6

Size	D5	D6	H1	H2	H3	H4	L1	L2	L3	L4
	∅ H7				±0.2	±0.03	±0.1	±0.2	±0.2	±0.03
80	7	M4	46	23	32	–	120	74	44	40
120	7	M5	68	34	55	20	203.3	116	76	40

Size	L5	L6	L7	L9	L10	T1	T2	T3	T4	T5
	±0.1	±0.1	±0.05				+0.1			
80	30	78	60	146	133	8.6	2.1	12	7	7.5
120	60	140	110	226.9	214.3	8.6	2.1	13	7.5	7.5

Spindle axes EGC-BS-KF, with recirculating ball bearing guide

Technical data

Dimensions Download CAD data → www.festo.com

GK-C – Standard slide with lubrication adapter

Size 185

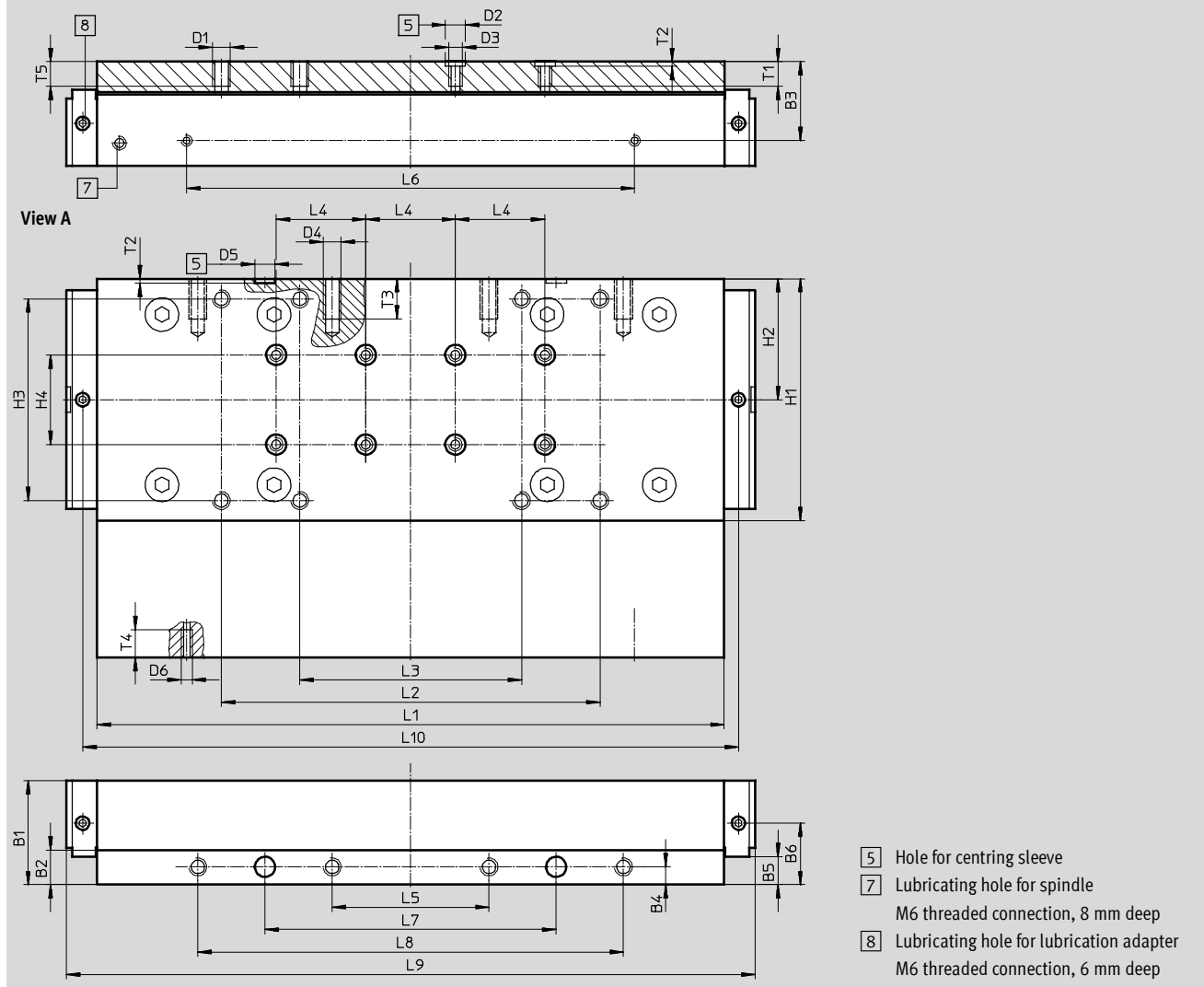

Size	B1	B2	B3	B4	B5	B6	D1	D2	D3	D4
185	46.5	15.5	35.2	8	±0.1	27.5	M8	∅ 9 H7	M6	M8

Size	D5	D6	H1	H2	H3	H4	L1	L2	L3	L4
185	∅ 9 H7	M5	108	54	±0.2	±0.03	±0.1	±0.2	±0.2	±0.03
185	9	M5	108	54	90	40	282.8	169	99	40

Size	L5	L6	L7	L8	L9	L10	T1	T2	T3	T4	T5
185	±0.2	±0.1	±0.05	±0.2				+0.1			
185	70	200	130	190	307.4	292.8	11	2.1	18	12.3	12

Spindle axes EGC-BS-KF, with recirculating ball bearing guide

Technical data

Dimensions Download CAD data → www.festo.com

GV-C – Extended slide with lubrication adapter

Size 80

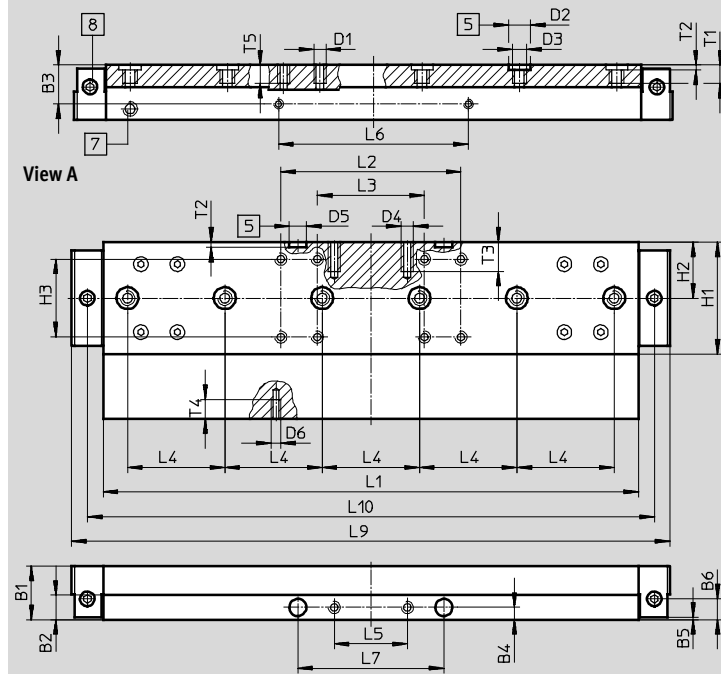

- 5 Hole for centring sleeve
- 7 Lubricating hole for spindle
M6 threaded connection, 8 mm deep
- 8 Lubricating hole for lubrication adapter
M6 threaded connection, 6 mm deep

Size	B1	B2	B3	B4	B5	B6	D1	D2	D3	D4
80	22	10	16	5	±0.1	8.5	M5	∅ H7 9	M6	M5

Size	D5	D6	H1	H2	H3	L1	L2	L3	L4	L5
80	∅ H7 7	M4	46	23	±0.2	±0.1	±0.2	±0.2	±0.03	±0.1

Size	L6	L7	L9	L10	T1	T2	T3	T4	T5
80	±0.1	±0.05	246	233	8.6	+0.1	12	7	7.5

Spindle axes EGC-BS-KF, with recirculating ball bearing guide

Technical data

Dimensions

Download CAD data → www.festo.com

GV-C – Extended slide with lubrication adapter

Size 120

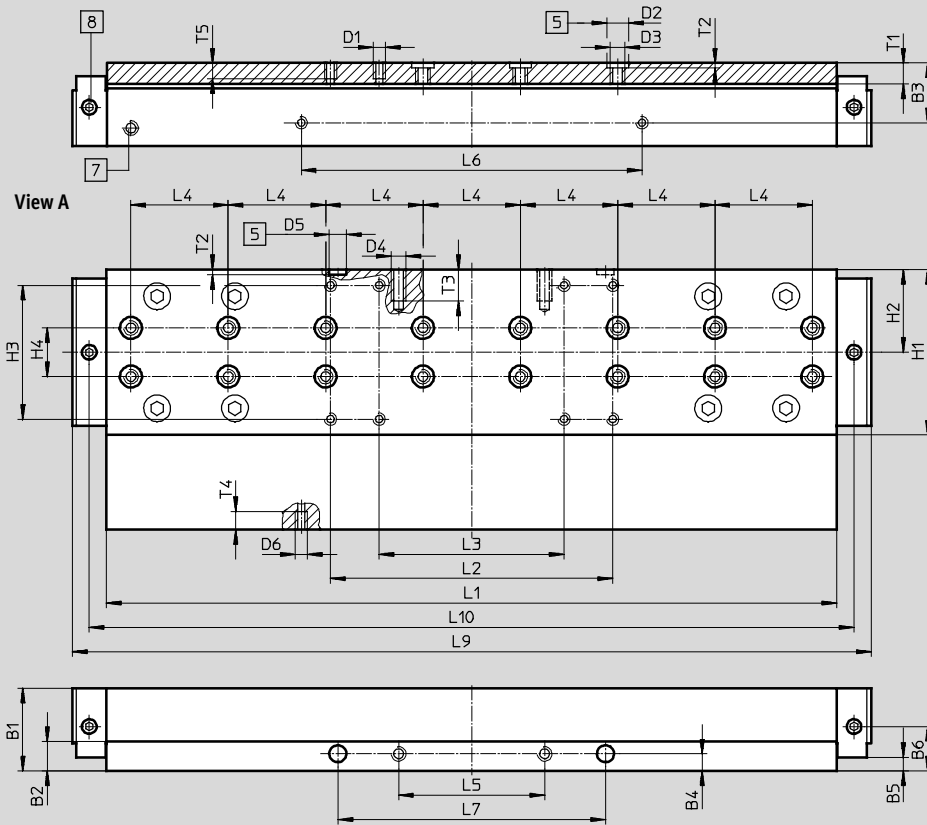

- 5 Hole for centring sleeve
- 7 Lubricating hole for spindle
M6 threaded connection, 8 mm deep
- 8 Lubricating hole for lubrication adapter
M6 threaded connection, 6 mm deep

Size	B1	B2	B3	B4	B5	B6	D1	D2 ∅ H7	D3	D4
120	34	12	24.5	7	±0.1 5.5	18.2	M5	9	M6	M6

Size	D5 ∅ H7	D6	H1	H2	H3	H4	L1	L2	L3	L4
120	±0.2 7	±0.2 M5	±0.2 68	±0.03 34	±0.1 55	±0.1 20	±0.1 303.3	±0.2 116	±0.2 76	±0.03 40

Size	L5	L6	L7	L9	L10	T1	T2	T3	T4	T5
120	±0.1 60	±0.1 140	±0.05 110	326.9	314.3	8.6	+0.1 2.1	13	7.5	7.5

Spindle axes EGC-BS-KF, with recirculating ball bearing guide

Technical data

FESTO

Dimensions

Download CAD data → www.festo.com

GV-C – Extended slide with lubrication adapter

Size 185

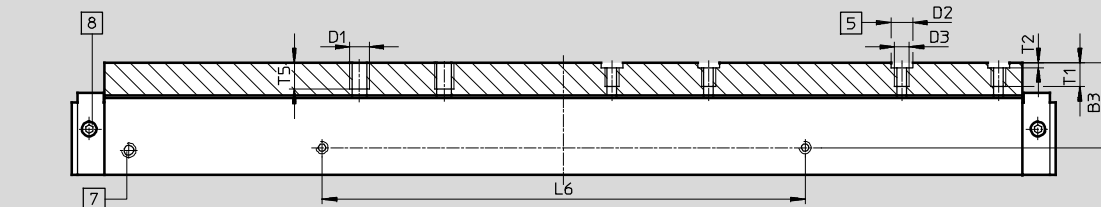

View A

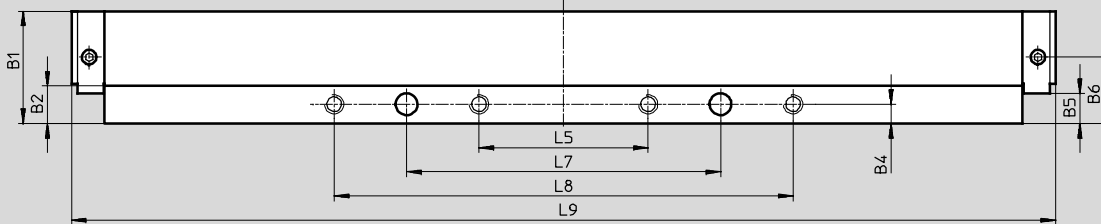
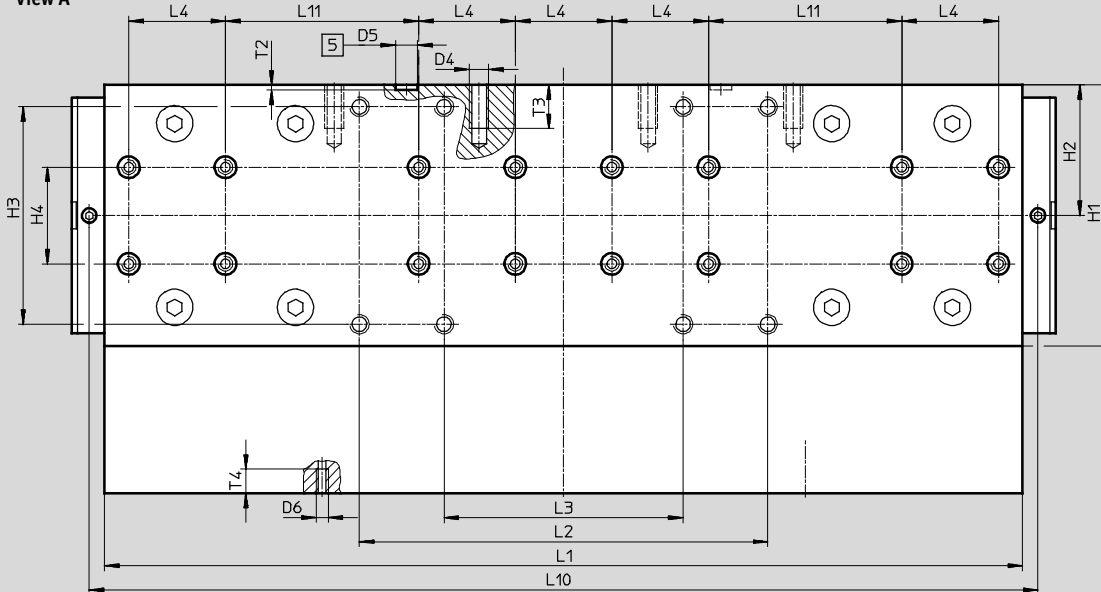

- [5] Hole for centring sleeve
- [7] Lubricating hole for spindle
M6 threaded connection, 8 mm deep
- [8] Lubricating hole for lubrication adapter
M6 threaded connection, 6 mm deep

Size	B1	B2	B3	B4	B5	B6	D1	D2 ∅ H7	D3	D4
185	46.5	15.5	35.2	8	±0.1 12.5	27.5	M8	9	M6	M8

Size	D5 ∅ H7	D6	H1	H2	H3	H4	L1	L2	L3	L4	L5
185	9	M5	108	54	±0.2 90	±0.03 40	±0.1 382.8	±0.2 169	±0.2 99	±0.03 40	±0.2 70

Size	L6	L7	L8	L9	L10	L11	T1	T2	T3	T4	T5
185	±0.1 200	±0.05 130	±0.2 190	407.4	392.8	±0.03 80	11	+0.1 2.1	18	10	12

Spindle axes EGC-BS-KF, with recirculating ball bearing guide

Technical data

Dimensions Download CAD data → www.festo.com

M1/M2 – With incremental displacement encoder

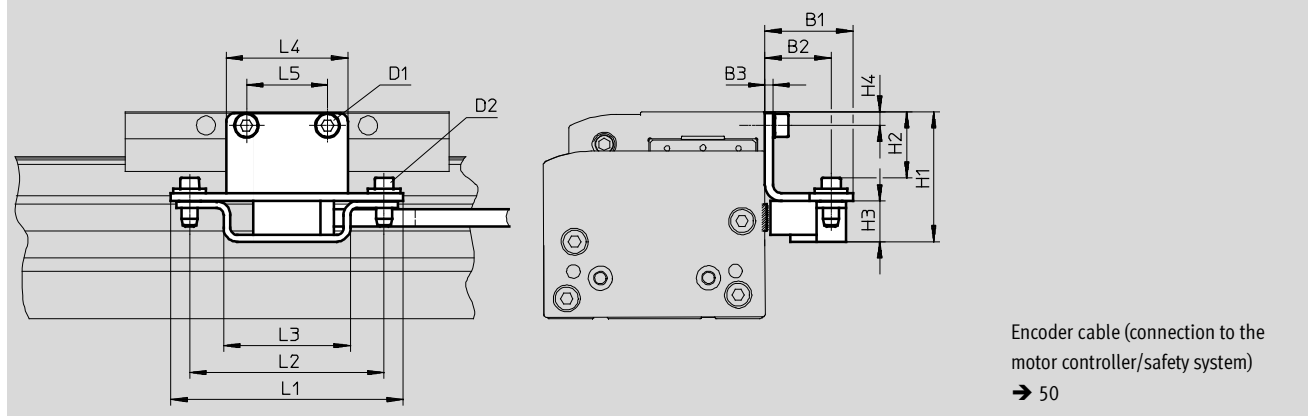

Type	B1	B2	B3	H1	H2	H3	H4
EGC-70-...-M1	32.5	24.5	3	39	18.4	15	4.5
EGC-70-...-M2				39	18.4		4.5
EGC-80-...-M1				48	24.4		5
EGC-80-...-M2				48	24.4		5
EGC-120-...-M1				60	36.4		7
EGC-120-...-M2				60	36.4		7
EGC-185-...-M1				78.5	54.9		8
EGC-185-...-M2				78.5	54.9		8

Type	D1	D2	L1	L2	L3	L4	L5
EGC-70-...-M1	M5x8	M4x14	86	72	47	35	20
EGC-70-...-M2	M5x8					35	20
EGC-80-...-M1	M5x8					45	30
EGC-80-...-M2	M5x8					45	30
EGC-120-...-M1	M6x10					86	60
EGC-120-...-M2	M6x10					86	60
EGC-185-...-M1	M8x12					86	70
EGC-185-...-M2	M8x12					86	70

Spindle axes EGC-BS-KF, with recirculating ball bearing guide

Technical data

Dimensions

Download CAD data → www.festo.com

1HL/1HR/2H – With clamping unit

Size 80

1-channel, left

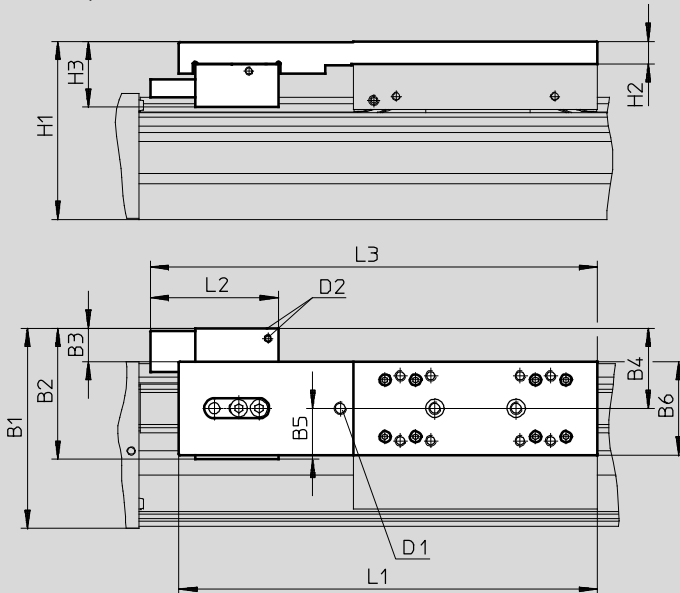

1-channel, right

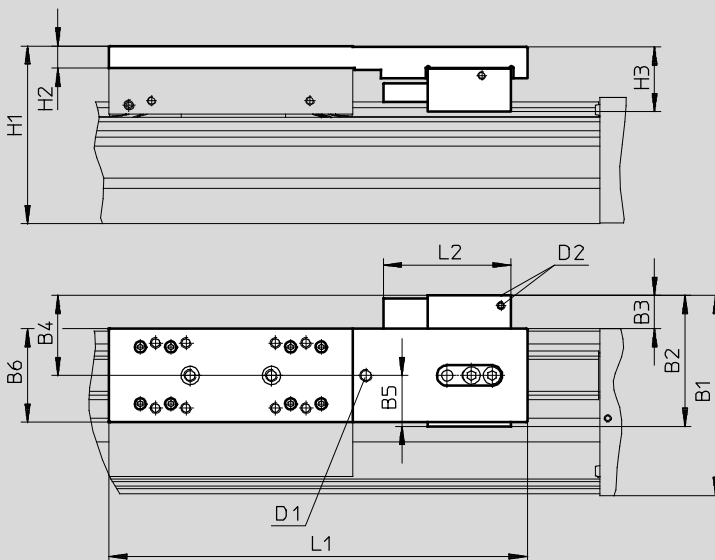

D2 Compressed air supply

Working stroke reduction in
combination with additional slide
→ 16

Spindle axes EGC-BS-KF, with recirculating ball bearing guide

Technical data

FESTO

Dimensions

Download CAD data → www.festo.com

1HL/1HR/2H – With clamping unit

Size 80

2-channel

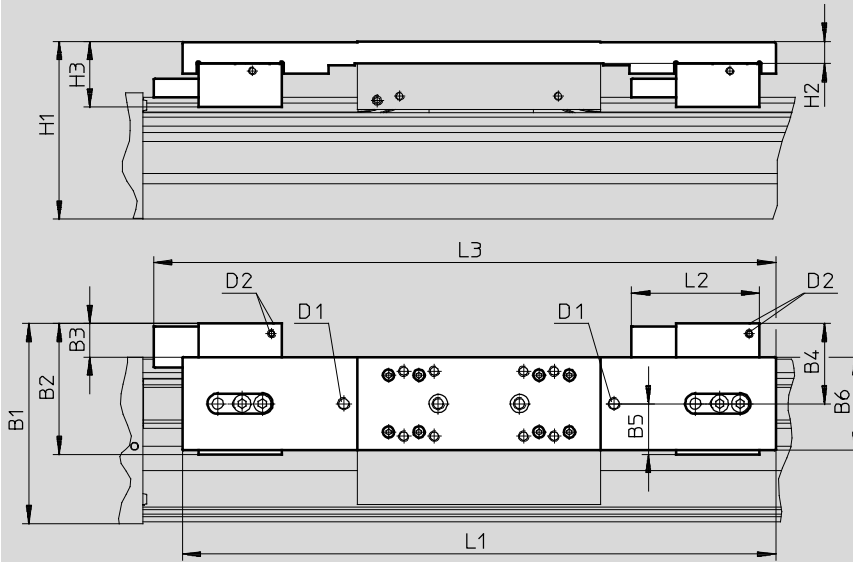

D2 Compressed air supply

Working stroke reduction in combination with additional slide
→ 16

Type	B1	B2	B3	B4	B5	B6	H1	H2	H3	D1	D2	L1	L2	L3											
EGC-80-...-1HL-PN	98.4	64.4	17.4	39.4	25	46	87.5	11	32.4	M6	M5	206	63	220											
EGC-80-...-1HR-PN														-											
EGC-80-...-C-1HL-PN														220											
EGC-80-...-C-1HR-PN														-											
EGC-80-...-2H-PN												292													306
EGC-80-...-C-2H-PN																									

Spindle axes EGC-BS-KF, with recirculating ball bearing guide

Technical data

FESTO

Dimensions

Download CAD data → www.festo.com

1HL/1HR/2H – With clamping unit

Size 120/185

1-channel, left

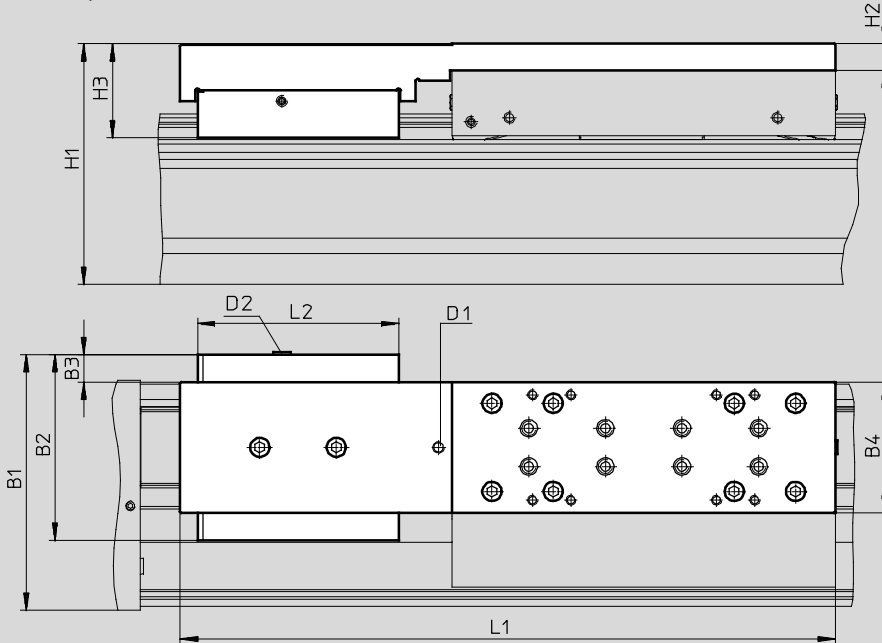

1-channel, right

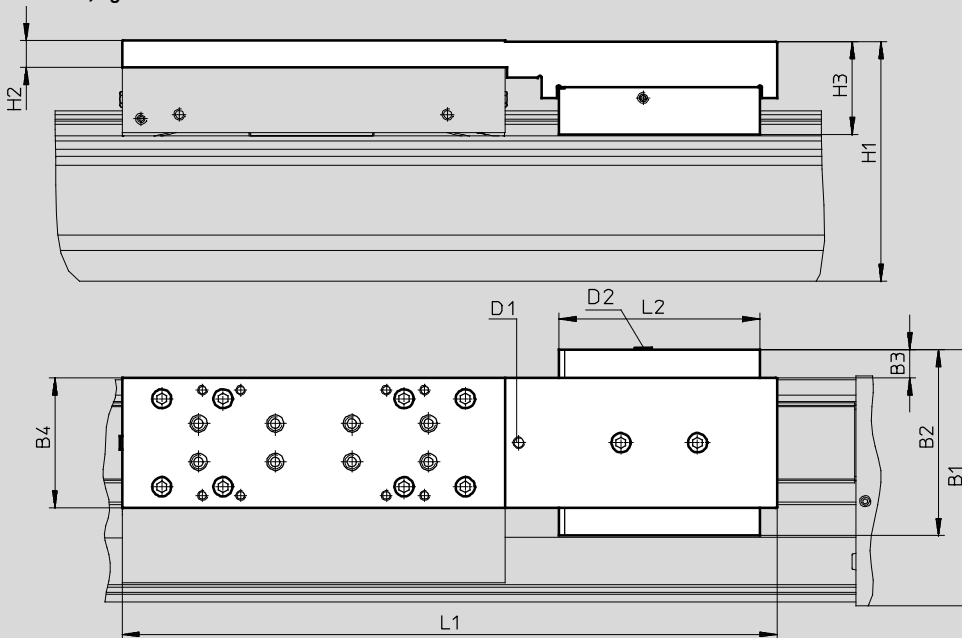

D2 Compressed air supply

Working stroke reduction in
combination with additional slide
→ 16

Spindle axes EGC-BS-KF, with recirculating ball bearing guide

FESTO

Technical data

Dimensions

Download CAD data → www.festo.com

1HL/1HR/2H – With clamping unit

Size 120/185

2-channel

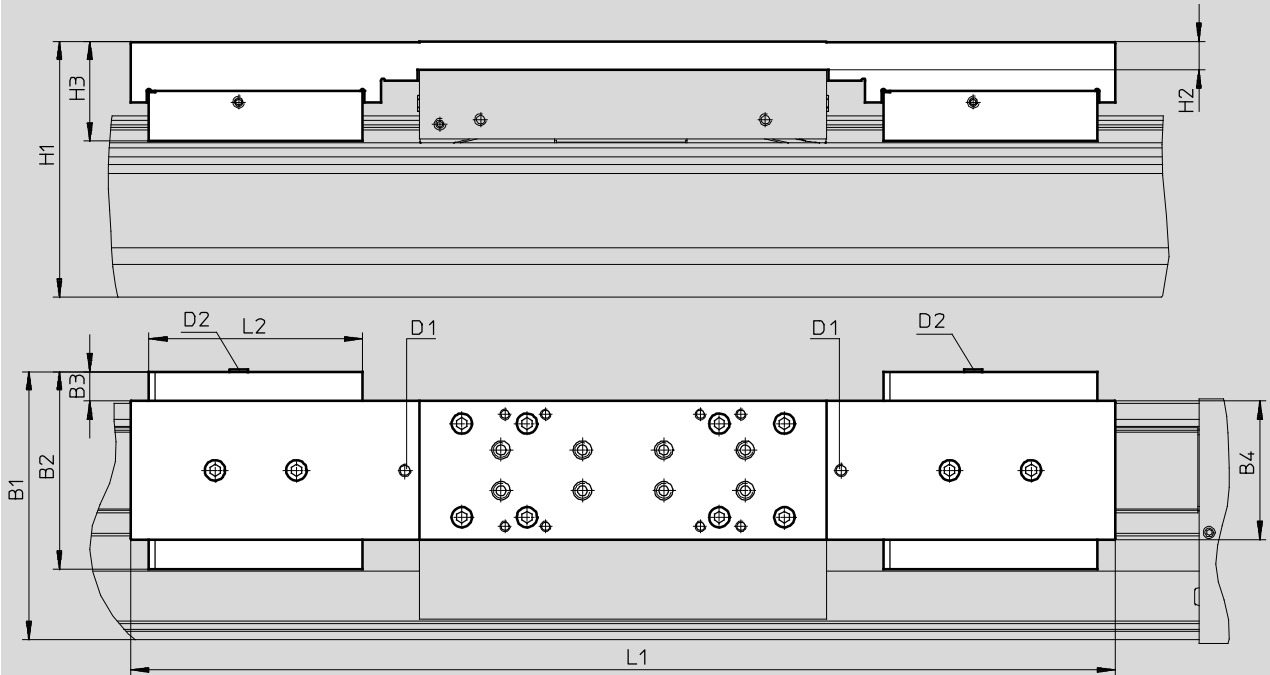

D2 Compressed air supply

Working stroke reduction in combination with additional slide
→ 16

Type	B1	B2	B3	B4	H1	H2	H3	D1	D2	L1	L2
Size 120											
EGC-120-...-1HL-PN	133.5	97	15.5	68	125.5	14	48.9	M6	M5	342	105
EGC-120-...-1HR-PN											
EGC-120-...-C-1HL-PN											
EGC-120-...-C-1HR-PN											
EGC-120-...-2H-PN											
EGC-120-...-C-2H-PN										484	
Size 185											
EGC-185-...-1HL-PN	196.5	131	12.5	108	189.5	17	64.1	M6	M5	432	109
EGC-185-...-1HR-PN											
EGC-185-...-C-1HL-PN											
EGC-185-...-C-1HR-PN											
EGC-185-...-2H-PN											
EGC-185-...-C-2H-PN										584	

Spindle axes EGC-BS-KF, with recirculating ball bearing guide

Ordering data – Modular products

Order code

Mandatory data

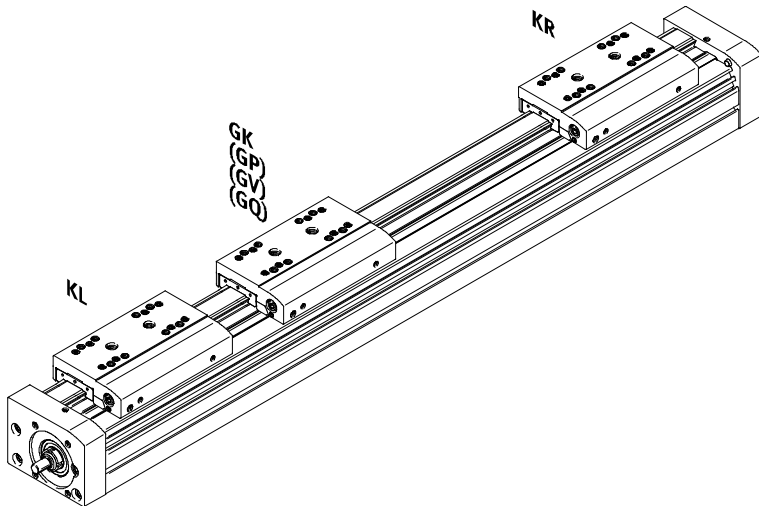
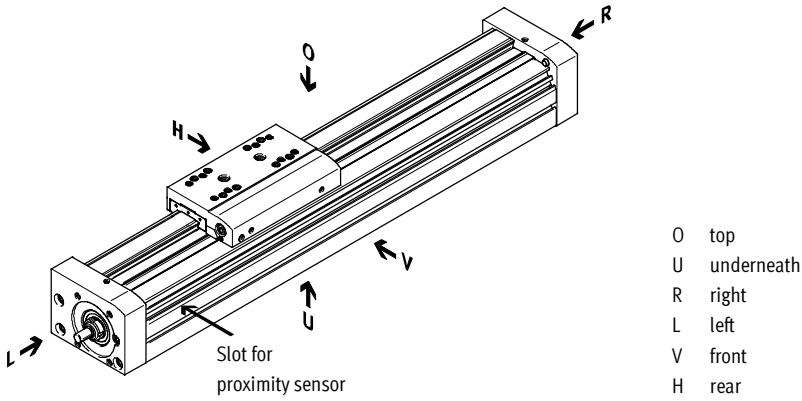

-  - Note
Spindle support enables maximum travel speed with all stroke lengths.

Spindle axes EGC-BS-KF, with recirculating ball bearing guide

Ordering data – Modular products

Order code

Accessories

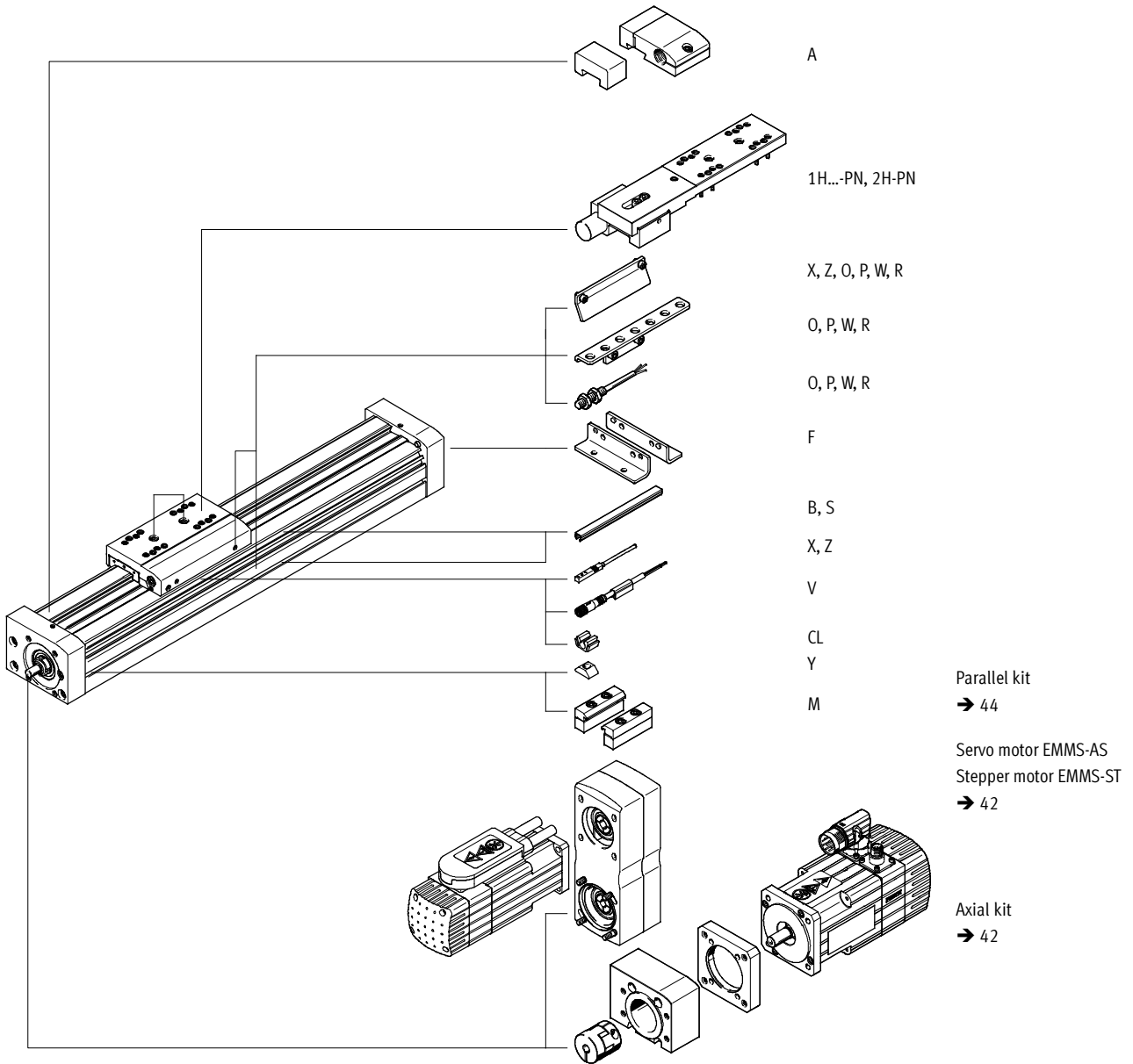

Spindle axes EGC-BS-KF, with recirculating ball bearing guide

Ordering data – Modular products

Ordering table							
Size	70	80	120	185	Condi- tions	Code	Enter code
M Module No.	556807	556808	556809	556811			
Design	Linear axis					EGC	EGC
Size	70	80	120	185		-...	
Stroke for GK, GP (without stroke reserve) [mm]	100; 200; 300; 400; 500; 600; 700; 800; 1,000	100; 200; 300; 500; 600; 800; 1,000; 1,400; 1,500; 1,800; 2,000	200; 300; 500; 600; 800; 1,000; 1,400; 1,500; 2,000; 2,500	300; 500; 600; 1,000; 1,500; 2,000; 2,500; 3,000		-...	-...
Stroke for GV, GQ (without stroke reserve) [mm]	100; 200; 300; 400; 500; 600; 700; 900	100; 200; 400; 500; 700; 900; 1,300; 1,400; 1,700; 1,900	100; 200; 400; 500; 700; 900; 1,300; 1,400; 1,900; 2,400	200; 400; 500; 900; 1,400; 1,900; 2,400; 2,900		-...	
Function	Ball screw spindle					-BS	-BS
Spindle pitch	10	10	10	-		-10P	
	-	20	-	-		-20P	
	-	-	25	-		-25P	
	-	-	-	40		-40P	
Spindle support	None						
	With spindle support				¹	-S	
	> 705 mm ¹⁾ > 605 mm ²⁾	> 780 mm ¹⁾ > 680 mm ²⁾	> 883 mm ¹⁾ > 783 mm ²⁾	> 1,224 mm ¹⁾ > 1,124 mm ²⁾			
Guide	Recirculating ball bearing guide					-KF	-KF
Stroke reserve [mm]	0 ... 999 (0 = no stroke reserve)				²	-...H	
Motor attachment position	Motor on the left					-ML	
	Motor on the right					-MR	
Slide	Standard slide					-GK	
	Extended slide, protected				-	-GQ	
	Standard slide, protected				-	-GP	
	Extended slide					-GV	

¹ **S** Only available above the specified strokes

1) in combination with slide GK, GP

2) in combination with slide GQ, GV

² **...H** The sum of the stroke length and 2x stroke reserve must not exceed the maximum stroke length

Order code

EGC - - - **BS** - - - **KF** - - -

Spindle axes EGC-BS-KF, with recirculating ball bearing guide

Ordering data – Modular products

Ordering table								
Size		70	80	120	185	Condi- tions	Code	Enter code
0	Additional slide	Left	Additional slide, standard, on left			3	-KL	
		Right	Additional slide, standard, on right				-KR	
	Lubrication function	Standard						
		-	Lubrication adapter				-C	
	Displacement encoder, incremental	Resolution: 2.5 µm					-M1	
		Resolution: 10 µm					-M2	
	Clamping unit	-	1-channel, left		4		-1HL	
		-	1-channel, right			-1HR		
		-	2-channel			-2H		
	Actuation type	-	Pneumatic				-PN	
↓	Accessories	Accessories enclosed separately					ZUB-	ZUB-
0	Foot mounting	1					F	
	Profile mounting	1 ... 50					...M	
	Cover	Mounting slot		1 ... 50 (1 = 2 units, 500 mm)			...B	
		Sensor slot		1 ... 50 (1 = 2 units, 500 mm)			...S	
	Slot nut for mounting slot	1 ... 99					...Y	
	Proximity sensor (SIES), inductive, slot type 8, PNP, incl. switch lug	N/O contact, 7.5 m cable		1 ... 6			...X	
		N/C contact, 7.5 m cable		1 ... 6			...Z	
	Emergency buffer with retainer	1 ... 2				5	...A	
	Proximity sensor (SIEN), inductive, M8, PNP, incl. switch lug with sensor bracket	N/O contact, 2.5 m cable		1 ... 99			...O	
		N/C contact, 2.5 m cable		1 ... 99			...P	
		N/O contact, plug M8		1 ... 99			...W	
		N/C contact, plug M8		1 ... 99			...R	
	Connecting cable 2.5 m, M8, 3-wire	1 ... 99					...V	
	Cable clip	10, 20, 30, 40, 50, 60, 70, 80, 90					...CL	
	Operating instructions	Express waiver - no operating instructions to be included (already available) (operating instructions in pdf format are available free of charge on the Internet at www.festo.com)					-DN	

- 3 KL, KR If the protected slide variant (GQ, GP) is selected, then the additional slide (KL, KR) is also protected
If the extended slide variant (GQ, GV) is selected, then the additional slide (KL, KR) is not extended
If the slide with lubrication adapter (GK-C, GV-C) is selected, then the additional slide (KL, KR) is also supplied with lubrication adapter
Working stroke reduction in combination with additional slide (KL, KR) → 16
- 4 1HL, 1HR, 2H Not with slide GQ, GV as well as additional slide KL, KR
Only with PN
Working stroke reduction in combination with clamping unit (1HL, 1HR, 2H) → 17
- 5 ... A Emergency buffer with retainer A cannot be combined with slide GP, GQ, GK-C, GV-C and clamping unit 1H...-PN, 2H-PN

 Note

The code X, Z includes a switch lug in the scope of delivery.

The code O, P, W, R includes one switch lug and max. two sensor brackets in the scope of delivery.

Transfer order code

- - - - - - **ZUB** - -

Spindle axes EGC-BS-KF, with recirculating ball bearing guide

Accessories

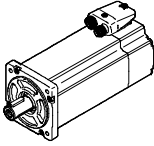
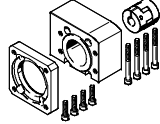
Permissible axis/motor combinations with axial kit		Technical data → Internet: eamm-a	
Motor	Axial kit		
			
Type	Part No.	Type	
EGC-70			
With servo motor			
EMME-AS-40-...	2219044	EAMM-A-S38-40P	
EMMS-AS-40-...	558162	EAMM-A-S38-40A	
EMMS-AS-55-...	558163	EAMM-A-S38-55A	
EMME-AS-60-...	2219110	EAMM-A-S38-60P	
With stepper motor			
EMMS-ST-42-...	560685	EAMM-A-S38-42A	
EMMS-ST-57-...	560686	EAMM-A-S38-57A	
EGC-80			
With servo motor			
EMMS-AS-55-...	558164	EAMM-A-S48-55A	
EMME-AS-60-...	2220560	EAMM-A-S48-60P	
EMMS-AS-70-...	558165	EAMM-A-S48-70A	
With stepper motor			
EMMS-ST-57-...	560687	EAMM-A-S48-57A	
EMMS-ST-87-...	560688	EAMM-A-S48-87A	
EGC-120			
With servo motor			
EMMS-AS-70-...	558166	EAMM-A-S62-70A	
EMME-AS-80-...	2222582	EAMM-A-S62-80P	
EMME-AS-100-...	558167	EAMM-A-S62-100A	
EMMS-AS-100-...	558167	EAMM-A-S62-100A	
EMMS-AS-140-...	558168	EAMM-A-S62-140A	
With stepper motor			
EMMS-ST-87-...	560689	EAMM-A-S62-87A	
EGC-185			
With servo motor			
EMME-AS-100-...	558169	EAMM-A-S95-100A	
EMMS-AS-100-...	558169	EAMM-A-S95-100A	
EMMS-AS-140-...	558170	EAMM-A-S95-140A	





-  - Note

For the optimum selection of axis/
motor combinations →

PositioningDrives
sizing software
www.festo.com

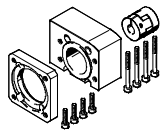
Spindle axes EGC-BS-KF, with recirculating ball bearing guide

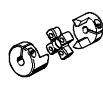
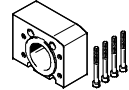
Accessories

Component parts of the axial kit				
Axial kit	Consisting of:			
	Motor flange	Coupling	Coupling housing	Screw set
				
Part No. Type	Part No. Type	Part No. Type	Part No. Type	Part No. Type
EGC-70				
2219044 EAMM-A-S38-40P	2219077 EAMF-A-38B-40P	533708 EAMC-30-32-6-8	558171 EAMK-A-S38-38A/B	–
2219110 EAMM-A-S38-60P	1987412 EAMF-A-38A-60P	1233256 EAMC-30-32-6-14	558171 EAMK-A-S38-38A/B	567489 EAHM-L2-M5-55
558162 EAMM-A-S38-40A	558175 EAMF-A-38B-40A	558312 EAMC-30-32-6-6	558171 EAMK-A-S38-38A/B	–
560685 EAMM-A-S38-42A	560691 EAMF-A-38B-42A	561333 EAMC-30-32-5-6	558171 EAMK-A-S38-38A/B	–
558163 EAMM-A-S38-55A	558176 EAMF-A-38A-55A	551003 EAMC-30-32-6-9	558171 EAMK-A-S38-38A/B	567488 EAHM-L2-M5-50
560686 EAMM-A-S38-57A	560692 EAMF-A-38A-57A	551002 EAMC-30-32-6-6.35	558171 EAMK-A-S38-38A/B	567488 EAHM-L2-M5-50
EGC-80				
2220560 EAMM-A-S48-60P	2220620 EAMF-A-48A-60P	562682 EAMC-30-32-8-14	558172 EAMK-A-S48-48A/B	567489 EAHM-L2-M5-55
558164 EAMM-A-S48-55A	558177 EAMF-A-48B-55A	543423 EAMC-30-32-8-9	558172 EAMK-A-S48-48A/B	–
560687 EAMM-A-S48-57A	560694 EAMF-A-48B-57A	543421 EAMC-30-32-6.35-8	558172 EAMK-A-S48-48A/B	–
558165 EAMM-A-S48-70A	558025 EAMF-A-48A-70A	551004 EAMC-30-32-8-11	558172 EAMK-A-S48-48A/B	567488 EAHM-L2-M5-50
560688 EAMM-A-S48-87A	560695 EAMF-A-48A-87A	551004 EAMC-30-32-8-11	558172 EAMK-A-S48-48A/B	567489 EAHM-L2-M5-55
EGC-120				
2222582 EAMM-A-S62-80P	2222624 EAMF-A-62B-80P	551005 EAMC-42-50-12-19	558173 EAMK-A-S62-62A/B	–
558166 EAMM-A-S62-70A	558179 EAMF-A-62B-70A	558313 EAMC-42-66-11-12	558173 EAMK-A-S62-62A/B	–
560689 EAMM-A-S62-87A	560696 EAMF-A-62B-87A	558313 EAMC-42-66-11-12	558173 EAMK-A-S62-62A/B	–
558167 EAMM-A-S62-100A	558026 EAMF-A-62A-100A	551005 EAMC-42-50-12-19	558173 EAMK-A-S62-62A/B	567494 EAHM-L2-M6-80
558168 EAMM-A-S62-140A	558022 EAMF-A-62A-140A	558314 EAMC-42-50-12-24	558173 EAMK-A-S62-62A/B	567495 EAHM-L2-M6-90
EGC-185				
558169 EAMM-A-S95-100A	558182 EAMF-A-95B-100A	558315 EAMC-56-58-19-25	558174 EAMK-A-S95-95A/B	–
558170 EAMM-A-S95-140A	558023 EAMF-A-95A-140A	558316 EAMC-56-58-24-25	558174 EAMK-A-S95-95A/B	567498 EAHM-L2-M8-100

Spindle axes EGC-BS-KF, with recirculating ball bearing guide

Accessories

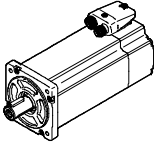
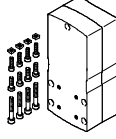
Permissible axis/motor combinations with parallel kit		Technical data → Internet: eamm-u
Motor	Parallel kit	
		
Type	Part No.	Type
EGC-70-...-BS		
With servo motor		
EMME-AS-40-...	2155239	EAMM-U-50-S38-40P-78
EMMS-AS-40-...	1217708	EAMM-U-50-S38-40A-78
EMMS-AS-55-...	1218538	EAMM-U-60-S38-55A-91
With stepper motor		
EMMS-ST-42-...	1217945	EAMM-U-50-S38-42A-78
EMMS-ST-57-...	1218568	EAMM-U-60-S38-57A-91
With gear unit ²⁾		
EMGA-40-P-...	2283732	EAMM-U-60-S38-40G-91
EMGC-40-P-...	2283732	EAMM-U-60-S38-40G-91
EGC-80-...-BS		
With servo motor		
EMMS-AS-55-...	1219370	EAMM-U-60-S48-55A-91 ¹⁾
EMMS-AS-70-...	1217689	EAMM-U-86-S48-70A-102 ¹⁾
With stepper motor		
EMMS-ST-57-...	1219379	EAMM-U-60-S48-57A-91 ¹⁾
EMMS-ST-87-...	1217604	EAMM-U-86-S48-87A-177 ¹⁾
With gear unit ²⁾		
EMGA-40-P-...	2283760	EAMM-U-60-S48-40G-91 ¹⁾
EMGC-40-P-...	2283760	EAMM-U-60-S48-40G-91 ¹⁾
EMGA-60-P-...-SAS/SST	1587251	EAMM-U-86-S48-60G-102 ¹⁾
EMGA-60-P-...-EAS, EMGC-60-P-...	1587338	EAMM-U-86-S48-60H-102 ¹⁾

2) The output torque at the gear unit output must be less than the transferable torque of the kit.

 Note

1) These parallel kits include a counter bearing EAMG to support the axis shaft.
More information → eamm-u

Spindle axes EGC-BS-KF, with recirculating ball bearing guide

Accessories

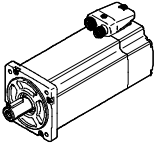
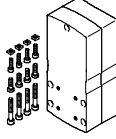
Permissible axis/motor combinations with parallel kit		Technical data → Internet: eamm-u
Motor	Parallel kit	
		
Type	Part No.	Type
EGC-120-...-BS		
With servo motor		
EMMS-AS-70-...	1217543	EAMM-U-86-S62-70A-177 ¹⁾
EMME-AS-80-...	2157004	EAMM-U-86-S62-80P-177 ¹⁾
EMME-AS-100-...	1217381	EAMM-U-110-S62-100A-207 ¹⁾
EMMS-AS-100-...	1217381	EAMM-U-110-S62-100A-207 ¹⁾
EMMS-AS-140-...	1219440	EAMM-U-145-S62-140A-288 ¹⁾
With stepper motor		
EMMS-ST-87-...	1217373	EAMM-U-86-S62-87A-177 ¹⁾
With gear unit ²⁾		
EMGA-60-P-...-SAS/SST	1587411	EAMM-U-86-S62-60G-177 ¹⁾
EMGA-60-P-...-EAS, EMGC-60-P-...	1587453	EAMM-U-86-S62-60H-177 ¹⁾
EGC-185-...-BS		
With servo motor		
EMME-AS-100-...	1220656	EAMM-U-110-S95-100A-207 ¹⁾
EMMS-AS-100-...	1220656	EAMM-U-110-S95-100A-207 ¹⁾
EMMS-AS-140-...	1220582	EAMM-U-145-S95-140A-288 ¹⁾
With gear unit ²⁾		
EMGA-80-P-...	1589544	EAMM-U-110-S95-80G-207 ¹⁾

2) The output torque at the gear unit output must be less than the transferable torque of the kit.

 - Note

1) These parallel kits include a counter bearing EAMG to support the axis shaft.
More information → eamm-u

 - Note

The clamping component EADT is required to adjust the toothed belt pretension with EAMM-U-110 and EAMM-U-145.

The motor and/or axis shaft can optionally be supported with a counter bearing EAMG.
More information → eamm-u

Spindle axes EGC-BS-KF, with recirculating ball bearing guide

Accessories



Foot mounting HPE
(order code F)

Material:
Galvanised steel
RoHS-compliant

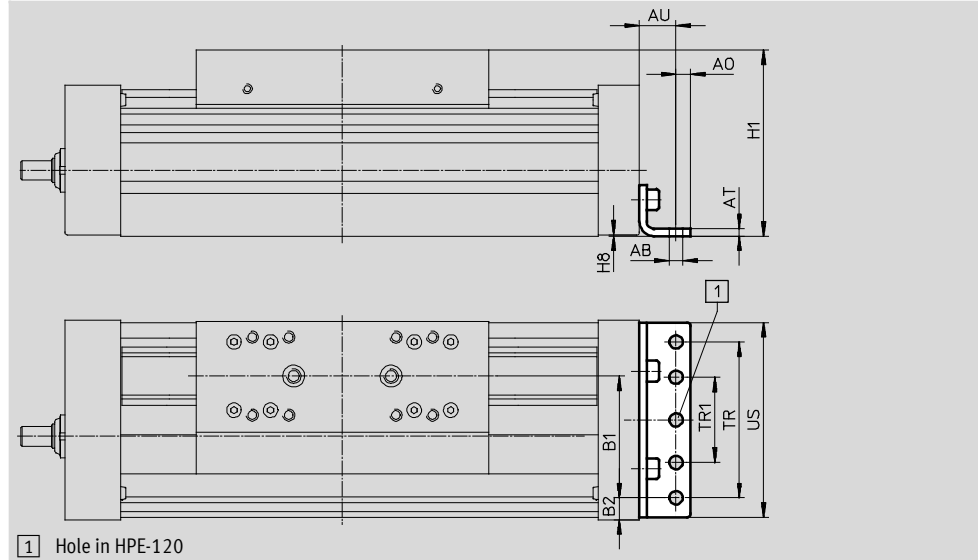

Dimensions and ordering data														
For size	AB ∅	A0	AT	AU	B1	B2	H1	H8	TR	TR1	US	Weight [g]	Part No.	Type
70	5.5	6	3	13	37	14.5	64	0.5	40	-	67	115	558321	HPE-70
80	5.5	6	3	15	38	21	76.5	0.5	40	-	80	150	558322	HPE-80
120	9	8	6	22	65	20	111.5	0.6	80	-	116	578	558323	HPE-120
185	9	12	8	25	118	13	172.5	0.5	160	80	182	1,438	558325	HPE-185

Profile mounting MUE
(order code M)

Material:
Anodised aluminium
RoHS-compliant

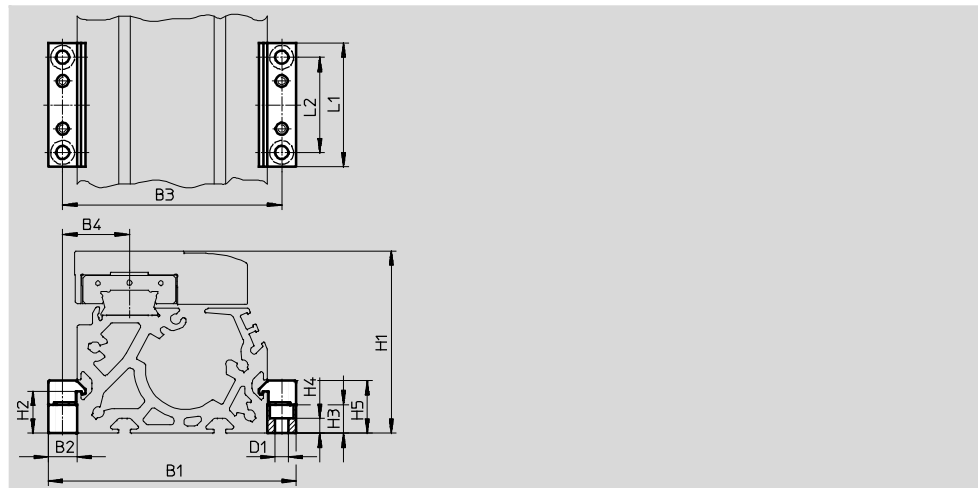

Dimensions and ordering data															
For size	B1	B2	B3	B4	D1 ∅	H1	H2	H3	H4	H5	L1	L2	Weight [g]	Part No.	Type
70	91	12	79	22.5	5.5	64	17.5	12	6.2	22	52	40	80	558043	MUE-70/80
80	104	12	92	28	5.5	76.5	17.5	12	6.2	22	52	40	80	558043	MUE-70/80
120	154	19	135	42.5	9	111.5	16	14	5.5	29.5	90	40	290	558044	MUE-120/185
185	220	19	201	62.5	9	172.5	16	14	5.5	29.5	90	40	290	558044	MUE-120/185

Spindle axes EGC-BS-KF, with recirculating ball bearing guide

Accessories

Shock absorber retainer KYE
Emergency buffer NPE → 49
(order code A)

Material:
Anodised aluminium
RoHS-compliant

Cannot be used in combination with
the variants GP and GQ or GK-C, GV-
C and 1H...-PN, 2H-PN.

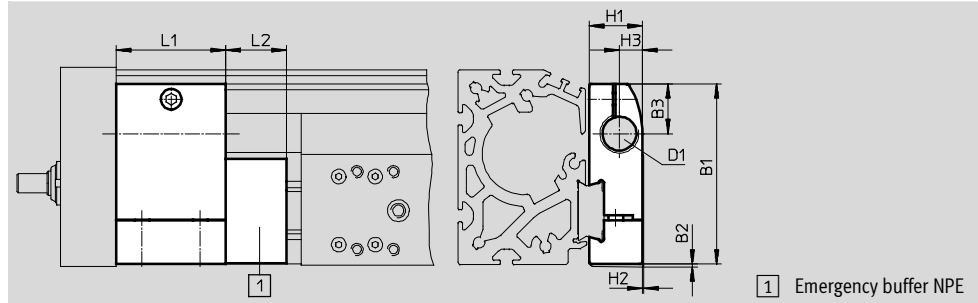

Dimensions and ordering data												
For size	B1	B2	B3	D1	H1	H2	H3	L1	L2	Weight [g]	Part No.	Type
70	57.5	1	16.5	M12X1	18.2	0.5	7.5	30	15	75	557584	KYE-70
80	74.2	1	20.5	M16X1	22	0.5	9.5	45	25	170	557585	KYE-80
120	108.5	1	26	M22X1.5	31	1	14	60	40	680	557586	KYE-120
185	168	1	37	M26X1.5	42	4	18	75	60	1,075	557587	KYE-185

Switch lug SF-EGC-1
for sensing via proximity sensor
SIES-8M
(order code X or Z)

Material:
Galvanised steel
RoHS-compliant

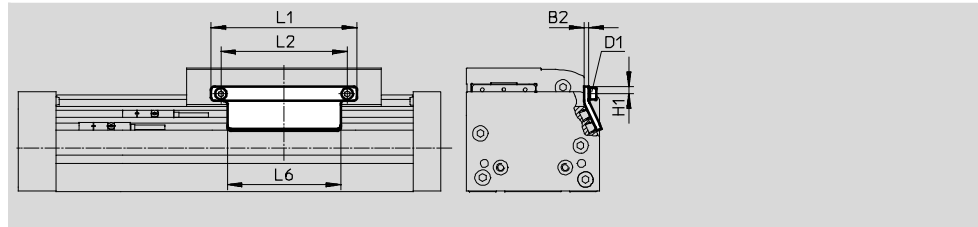

Dimensions and ordering data									
For size	B2	D1	H1	L1	L2	L6	Weight [g]	Part No.	Type
70	3	M4	4.65	70	56	50	50	558047	SF-EGC-1-70
80	3	M4	4.65	90	78	70	60	558048	SF-EGC-1-80
120	3	M5	8	170	140	170	150	558049	SF-EGC-1-120
185	3	M5	10	230	200	230	245	558051	SF-EGC-1-185

Spindle axes EGC-BS-KF, with recirculating ball bearing guide

Accessories

Switch lug SF-EGC-2

for sensing via proximity sensor
SIEN-M8B (order code O, P, W or R) or
SIES-8M (order code X or Z)

Material:
Galvanised steel
RoHS-compliant

Sensor bracket HWS-EGC
for proximity sensor SIEN-M8B
(order code O, P, W or R)

Material:
Galvanised steel
RoHS-compliant

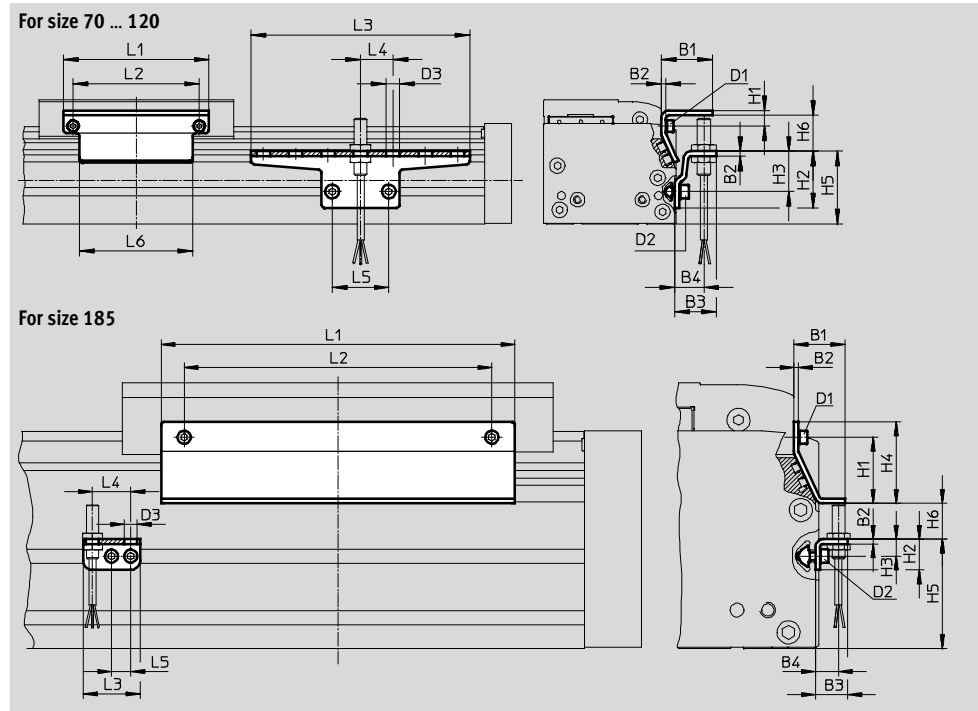
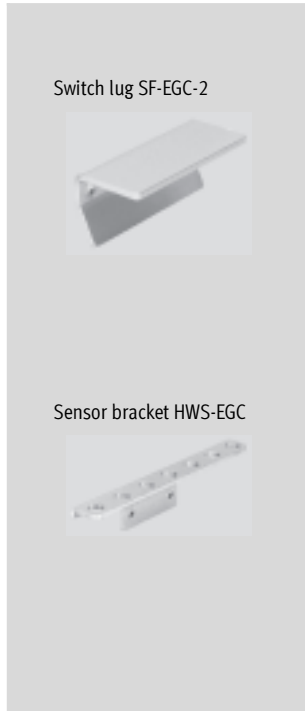

Dimensions and ordering data									
For size	B1	B2	B3	B4	D1	D2	D3	H1	H2
70	31.5	3	25.5	18	M4	M5	8.4	9.5	35
80	31.5	3	25.5	18	M4	M5	8.4	9.5	35
120	32	3	25.5	18	M5	M5	8.4	13.2	65
185	33	3	25.5	15	M5	M5	8.4	43	20





For size	H3	H4	H5	H6 max.	L1	L2	L3	L4	L5	L6
70	25	-	45	13.5	70	56	135	20	35	50
80	25	-	45	23.5	90	78	135	20	35	70
120	55	-	75	24	170	140	215	20	35	170
185	11	53	71	25.5	230	200	37	25	12.5	230

For size	Weight [g]	Part No.	Type
Switch lug			
70	100	558052	SF-EGC-2-70
80	130	558053	SF-EGC-2-80
120	280	558054	SF-EGC-2-120
185	390	558056	SF-EGC-2-185

For size	Weight [g]	Part No.	Type
Sensor bracket			
70	110	558057	HWS-EGC-M5
80	110	558057	HWS-EGC-M5
120	200	570365	HWS-EGC-M8-B
185	60	560517	HWS-EGC-M8-KURZ

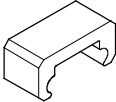
Spindle axes EGC-BS-KF, with recirculating ball bearing guide

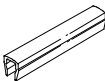
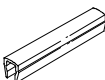
Accessories

Ordering data						
	For size	Remarks	Order code	Part No.	Type	PU ¹⁾
Emergency buffer NPE						
	70	Use in combination with shock absorber retainer KYE	A	562581	NPE-70	1
	80			562582	NPE-80	
	120			562583	NPE-120	
	185			562584	NPE-185	
Slot nut NST						
	70, 80	For mounting slot	Y	150914	NST-5-M5	1
	120, 185			150915	NST-8-M6	
Centring pin/sleeve ZBS/ZBH²⁾						
	70	For slide	-	150928	ZBS-5	10
	80, 120, 185			150927	ZBH-9	
Slot cover ABP						
	70, 80	For mounting slot every 0.5 m	B	151681	ABP-5	2
	120, 185			151682	ABP-8	
Slot cover ABP-S						
	70 ... 185	For sensor slot every 0.5 m	S	563360	ABP-5-S1	2
Clip SMBK						
	70 ... 185	For sensor slot, for attaching the proximity sensor cables	CL	534254	SMBK-8	10

1) Packaging unit



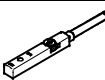
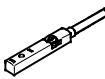

2) 2 centring pins/sleeves included in the scope of delivery of the axis



Ordering data – Proximity sensors for T-slot, inductive						Technical data → Internet: sies	
	Type of mounting	Electrical connection	Switching output	Cable length [m]	Order code	Part No.	Type
N/O contact							
	Insertable in the slot from above, flush with the cylinder profile	Cable, 3-wire	PNP	7.5	X	551386	SIES-8M-PS-24V-K-7,5-OE
		Plug M8x1, 3-pin		0.3	-	551387	SIES-8M-PS-24V-K-0,3-M8D
		Cable, 3-wire	NPN	7.5	-	551396	SIES-8M-NS-24V-K-7,5-OE
		Plug M8x1, 3-pin		0.3	-	551397	SIES-8M-NS-24V-K-0,3-M8D
N/C contact							
	Insertable in the slot from above, flush with the cylinder profile	Cable, 3-wire	PNP	7.5	Z	551391	SIES-8M-PO-24V-K-7,5-OE
		Plug M8x1, 3-pin		0.3	-	551392	SIES-8M-PO-24V-K-0,3-M8D
		Cable, 3-wire	NPN	7.5	-	551401	SIES-8M-NO-24V-K-7,5-OE
		Plug M8x1, 3-pin		0.3	-	551402	SIES-8M-NO-24V-K-0,3-M8D

Spindle axes EGC-BS-KF, with recirculating ball bearing guide

FESTO

Accessories

Ordering data – Proximity sensors M8 (round design), inductive						Technical data → Internet: sien	
	Electrical connection	LED	Switching output	Cable length [m]	Order code	Part No.	Type
N/O contact							
	Cable, 3-wire	■	PNP	2.5	O	150386	SIEN-M8B-PS-K-L
	Plug M8x1, 3-pin	■	PNP	–	W	150387	SIEN-M8B-PS-S-L
N/C contact							
	Cable, 3-wire	■	PNP	2.5	P	150390	SIEN-M8B-PO-K-L
	Plug M8x1, 3-pin	■	PNP	–	R	150391	SIEN-M8B-PO-S-L

Ordering data – Connecting cables				Technical data → Internet: nebu	
	Electrical connection, left	Electrical connection, right	Cable length [m]	Part No.	Type
	Straight socket, M8x1, 3-pin	Cable, open end, 3-wire	2.5	159420	SIM-M8-3GD-2,5-PU
			2.5	541333	NEBU-M8G3-K-2.5-LE3
			5	541334	NEBU-M8G3-K-5-LE3
	Angled socket, M8x1, 3-pin	Cable, open end, 3-wire	2.5	541338	NEBU-M8W3-K-2.5-LE3
			5	541341	NEBU-M8W3-K-5-LE3

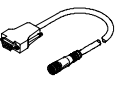
Ordering data – Encoder cables for displacement encoder, EGC-...-M1/-M2				Technical data → Internet: nebm	
	Electrical connection, left	Electrical connection, right	Cable length [m]	Part No.	Type
	Displacement encoder EGC-...-M1/-M2	Motor controller CMM...	5	1599105	NEBM-M12G8-E-5-S1G9-V3
			10	1599106	NEBM-M12G8-E-10-S1G9-V3
			15	1599107	NEBM-M12G8-E-15-S1G9-V3
			χ ¹⁾	1599108	NEBM-M12G8-E-...-S1G9-V3
	Displacement encoder EGC-...-M1/-M2	Safety system CMGA...	5	1617289	NEBM-M12G8-E-5-S1G9-V4
			10	1617288	NEBM-M12G8-E-10-S1G9-V4
			15	1617287	NEBM-M12G8-E-15-S1G9-V4
			χ ¹⁾	1617291	NEBM-M12G8-E-...-S1G9-V4

1) Max. cable length 25 m.