

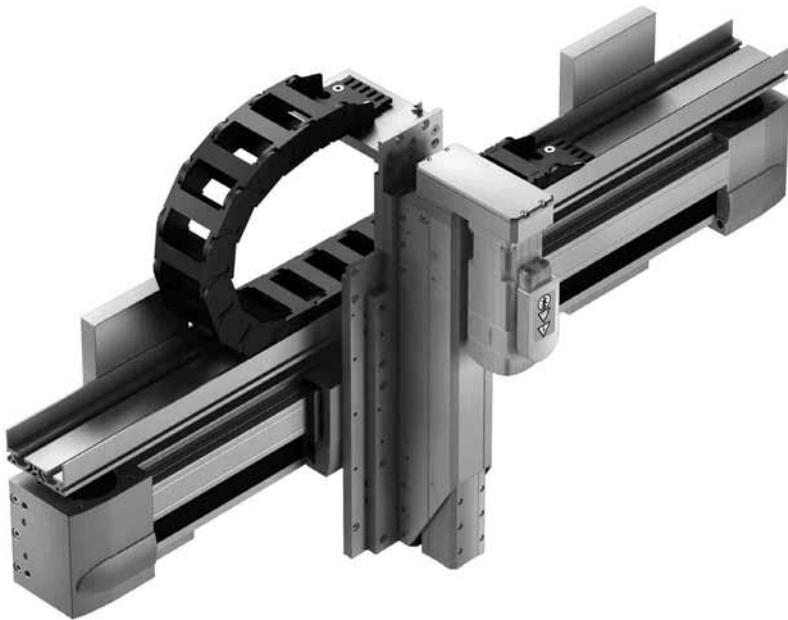

Linear gantries



Movements in 2D: a linear gantry consists of a gantry axis and a yoke drive.

- High mechanical rigidity and sturdy design
- Pneumatic and electrical components – freely combinable
- As electrical solution – variable positioning/any desired intermediate positions

Range of application:

- Ideal for long gantry strokes
- Often used for feeding applications
- Workpiece masses up to 5 kg (effective load up to 10 kg)
- Long gantry strokes up to 3 m and heavy loads up to 10 kg
- High requirements on system resistance to torsion

Example: construction materials industry

Handling, palletising and packing of ceramic tiles







Requirements

- High dynamic response
- Gentle acceleration and braking
- Jerk-free movement
- Good positioning flexibility

Solution

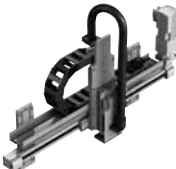
- Linear gantry with toothed belt axes and cantilever axis
- Complete solution, including vacuum gripper



Type	Important characteristics	Axis design	Effective load	Max. effective strokes	Components
 <ul style="list-style-type: none"> Linear gantry as mono axis Free movement of the Z-axis in the vertical plane (2D) 	<ul style="list-style-type: none"> High process reliability thanks to installation integration Pneumatic and electric drives (with freely programmable positions) Repetition-accurate, centralised direct axis connections Mini slide on the Z-axis for maximum precision 	Y: Gantry axes Z: Slide Cantilever axis	Mono: 0 to 6 kg	Y: Up to 5000 mm Z: Up to 300 mm	Y: DGC/EGC Z: DGSL EGSA
 <ul style="list-style-type: none"> See above 	<ul style="list-style-type: none"> See above, points 1–3 Pneumatic cantilever axis on the Z-axis with high repetition accuracy, high dynamic response and intermediate positions 	Y: Gantry axes Z: Handling axis	Mono: 0 to 5 kg	Y: Up to 5000 mm Z: Up to 200 mm	Y: DGC/EGC Z: HMPL
 <ul style="list-style-type: none"> See above 	<ul style="list-style-type: none"> See above, points 1–3 Pneumatic handling axis on the Z-axis with high rigidity and intermediate positions 	Y: Gantry axes Z: Handling axis	Mono: 0 to 10 kg*	Y: Up to 5000 mm Z: Up to 400 mm	Y: DGC/EGC Z: HMP
 <ul style="list-style-type: none"> Linear gantry as mono or duo axis Free movement of the Z-axis in the vertical plane (2D) 	<ul style="list-style-type: none"> See above, points 1–3 Electric cantilever axis on the Z-axis for large strokes, high dynamic response and low moving dead weight 	Y: Gantry axes Z: Cantilever axis	Mono: 0 to 15 kg Duo: 0 ... 25 kg	Y: Up to 5000 mm Z: Up to 900 mm	Y: DGC/EGC Z: DGEA

Higher effective loads of up to 50 kg on request

* With the pneumatic drive DGC, can be used as duo axis

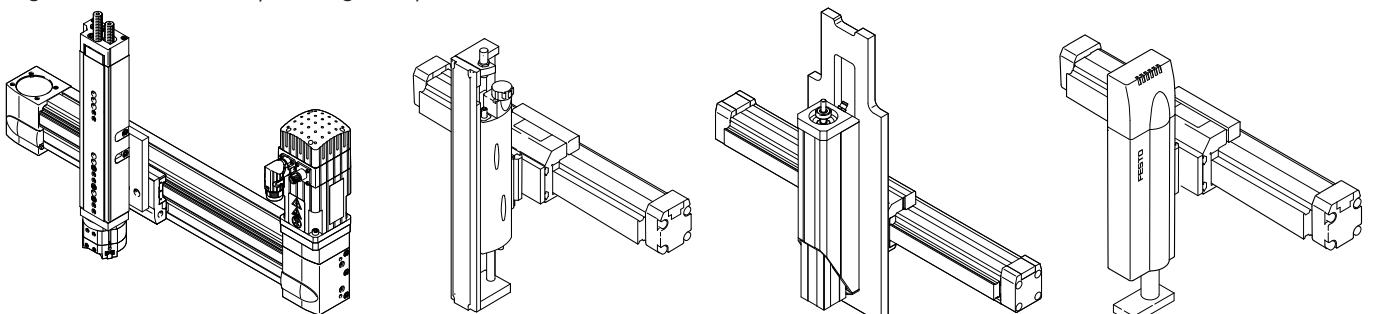

Standard linear gantry LP 10

Effective load up to 10 kg

Motor controller package on electric axes
 Servo motor: EMMS-AS
 Controller: CMMS/P-AS (CMMD)

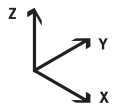

Technical data

		Stroke/mm	Intermed. position	Repetition accuracy/mm	
Z-axis	↕			End position	Intermediate position
ZR	DGEA-25	0 ... 800	Any	± 0.05	± 0.05
SP	EGC-80-BS-KF	0 ... 1000	Any	± 0.02	± 0.02
SP	DNCE-32 with FENG	0 ... 400	Any	± 0.02	± 0.02
P	DGSL-25	0 ... 200	–	± 0.01	–
P	DFM-32	0 ... 400	–	Max. 0.05	–
P	DNC-32 with FENG	0 ... 500	–	± 0.2	–
PS	DNCL-32 with FENG	0 ... 500	2/any **	≤± 0.5	≤± 0.5/± 2**
Y-axis	↔				
ZR	EGC-120-TB-KF ***	0 ... 8500	Any	± 0.08	± 0.08
SP	EGC-120-BS-KF ***	0 ... 2500	Any	± 0.02	± 0.02
ZR	EGC-HD-160 ****	0 ... 5000	Any	± 0.08	± 0.08
SP	EGC-HD-160 ****	0 ... 2500	Any	± 0.02	± 0.02
P	DGC-32 + FA	0 ... 8500	1*	± 0.02	± 0.02/± 0.1
PS	DGCL-32 + FA	0 ... 2000	2/any**	Max. ± 0.4	Max. ± 0.4/± 2

* More than 1 on request

** 2 with SPC11/CMPX, any with SPC200/CMAX; ≤± 0.5 mm with SPC11/CMPX/± 2 mm with SPC200/CMAX

*** Max. Z-stroke 400 mm

**** Max. Z-stroke 800 mm

Grey shading: drive components in the illustration

EGC-HD: available end of 2011

Reference for cycle times

Z-axis

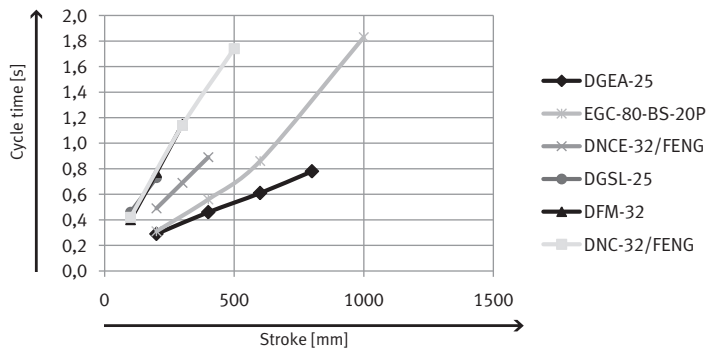

Y-axis

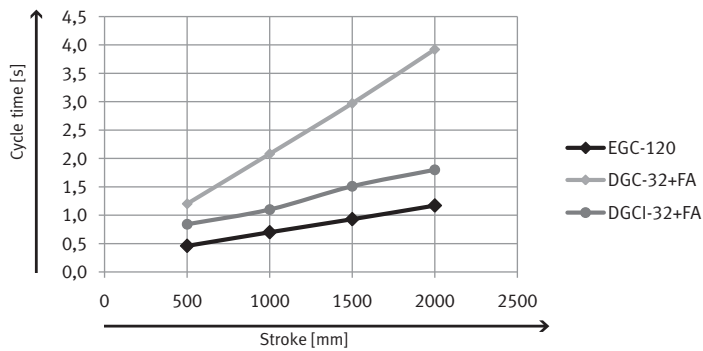

Note

Selection matrix

Types of handling units

→ Pages 6 to 9

Handling components

→ Page 95

Gripping/rotating

Adaptation options

→ Page 71

Control cabinets

→ Page 92

Frames

→ Page 78

CAD drawings/

CAD hotline

2D and 3D drawings

→

Tel. +49 (0)711 347-4667

Individual project engineering and cycle time calculation

→

Tel. +49 (0)711 347-4381

Fax enquiry

Form

→ Page 101

Note

An operating pressure of 6 bar is assumed for all the pneumatic drives shown here.

Overview of Festo control products

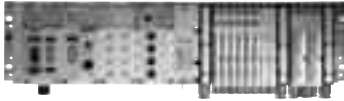
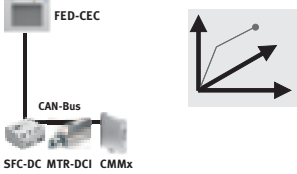
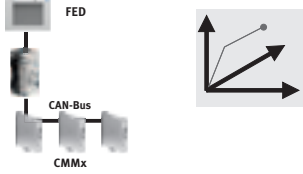
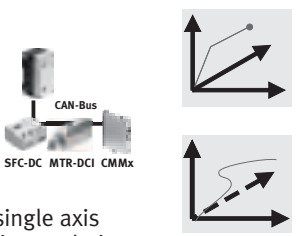
	 FED-CEC Integrated controller FED-CEC	 CPX terminal CoDeSys controller CPX-CEC-C1 Motion controller CPX-CEC-M1	
	 Single axis (point-to-point asynchronous)	 C1: single axis M1: interpolation	 C1: single axis M1: interpolation
Maximum number of possible axes	Recommended: 8 axes Note: one axis is treated as a CANopen node. 128 nodes are possible (as defined by CANopen specifications).	Recommended: 8 axes Note: one axis is treated as a CANopen node. 128 nodes are possible (as defined by CANopen specifications).	Recommended: 8 axes Note: one axis is treated as a CANopen node. 128 nodes are possible (as defined by CANopen specifications).
Motion	<ul style="list-style-type: none"> • Point-to-point asynchronous • Every axis moves with its own pre-defined parameter • The axes do not reach their end positions at the same time and the path is not defined 		
			<ul style="list-style-type: none"> • 2.5D interpolation • PLC Open
Special features	Integrated controller in a display screen	Function integration on the CPX valve platform	
			<ul style="list-style-type: none"> • CNC editor • DXF import • Cam disk editor
Application examples	<ul style="list-style-type: none"> • Handling systems • Pick & place, palletising 	Path control, bonding, cutting, handling, flying saw, cam disk	
Programming environment	CoDeSys	CoDeSys	CoDeSys + Softmotion

Modular control

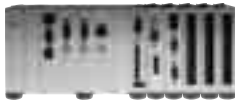

Modular control		CMXR robotic controller	
Modular controller CECX-C1	Motion controller CECX-M1	CMXR-C1 (Basic)	CMXR-C2 (Advanced)
<p>Single axis (point-to-point asynchronous)</p>	<p>Interpolation (2.5D)</p>	<p>Robotics (3D)</p>	<p>Robotics (3D)</p>
<p>Recommended: 8 axes Note: one axis is treated as a CANopen node. 128 nodes are possible (as defined by CANopen specifications).</p>		<p>Max. 6 interpolated axes, of which max. 3 basic axes and 1 orientation axis and max. 3 dependent auxiliary axes that are interpolated together with the kinematics system.</p>	
			<p>Additional single axes (not interpolated together with others) can be controlled via the integrated CoDeSys PLC. Recommended: 16 axes.</p>
		<p>3D contour interpolation with an orientation axis for kinematics systems with up to 4 degrees of freedom. E.g. 3D gantry with an axis of rotation on the front end.</p>	
	<ul style="list-style-type: none"> • 2.5D interpolation • PLC Open 		<p>CoDeSys control: point-to-point asynchronous</p>
<ul style="list-style-type: none"> • Powerful PLC • Encoder interface • Interrupt function • Fast clock pulse inputs • Profibus master • Two Canbus masters • RS 232/ RS 485-A/422-A 		<ul style="list-style-type: none"> • Economical design and configuration with the Festo Configuration Tool (FCT) • Simple programming of motions with Festo Teach Language (FTL), no specialist expertise required • Optional teach pendant with 2-channel permission button • Reduced speed in manual override mode • Automatic repositioning when continuing interrupted motions • Simple teaching of positions • Definition of tools, allowing easy use of multiple grippers • Real orientation axes on the front end • Integrated kinematics models e.g. for Cartesian systems, tripod, H- and T-gantries 	
	<ul style="list-style-type: none"> • CNC editor • DXF import • Cam disk editor 		<ul style="list-style-type: none"> • Increased flexibility with the integrated CoDeSys PLC, e.g. for the integration of vision systems • Tracking function for applications involving selecting items from a conveyor belt • Speed-independent path switching points with time compensation, e.g. for bonding applications • Complete automation of a cell is possible
<ul style="list-style-type: none"> • Handling systems • Pick & place, palletising 	<p>Path control, bonding, cutting, handling, flying saw, cam disk</p>	<p>Handling, palletising, bonding, metered dispensing, painting, cutting</p>	<p>Tracking applications such as processing of moving parts on a conveyor belt or synchronised kinematics movement with up to 6D</p>
CoDeSys	CoDeSys + Softmotion	Festo Teach Language (FTL)	FTL + CoDeSys