

Mini slides DGSL



Mini slides DGSL

Key features

FESTO

General information

- Double-acting drives
- Wide range of options for mounting
- System product for handling and assembly technology
- Highly elastic thanks to wide range of assembly and connection options on:
 - Drive body, slide, yoke plate

The technology in detail

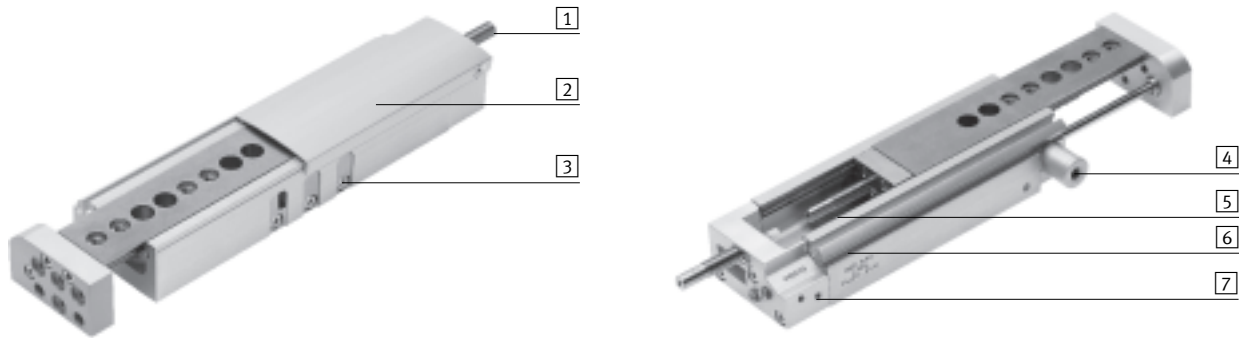

1 Cushioning



- Choice of five cushioning types:
 - Elastic cushioning without metal end position (P)
 - Elastic cushioning without metal end position, short design (E)
 - Elastic cushioning with metal end position (P1)
 - Shock absorbers (Y3)
 - Shock absorbers with reducing sleeve (Y11)
- Alternative:
 - Without cushioning (N)

2 Cover



- The cover stops foreign parts or dirt getting into the guide
- The cover comes in different lengths and can be trimmed as required by the customer

3 Coarse stroke adjustment



- The end stop for the advanced end position can be adjusted mechanically, for example to shorten the stroke

4 Clamping unit



- Mechanical clamping, for fixing the slide in any position; frictional locking (C)

4 End-position locking



- Mechanical locking when the end position is reached, for fixing the slide in the unpressurised, retracted state; positive locking (E3)

5 Innovative guide unit

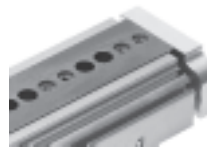

- Wide roller track, which provides extremely high rigidity
- High load capacity
- High precision
- Housing and steel slide form a guide: there are no accumulative tolerances

6 Position sensing



- Proximity sensors can be integrated, so there are no projecting parts
- Two slots for mounting
- Clearly visible from the side and from above

7 Supply ports

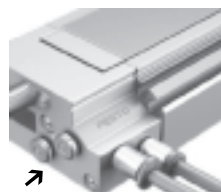

- Choice of two sides:
 - On front face
 - At the side

Mini slides DGSL

System example

System product for handling and assembly technology

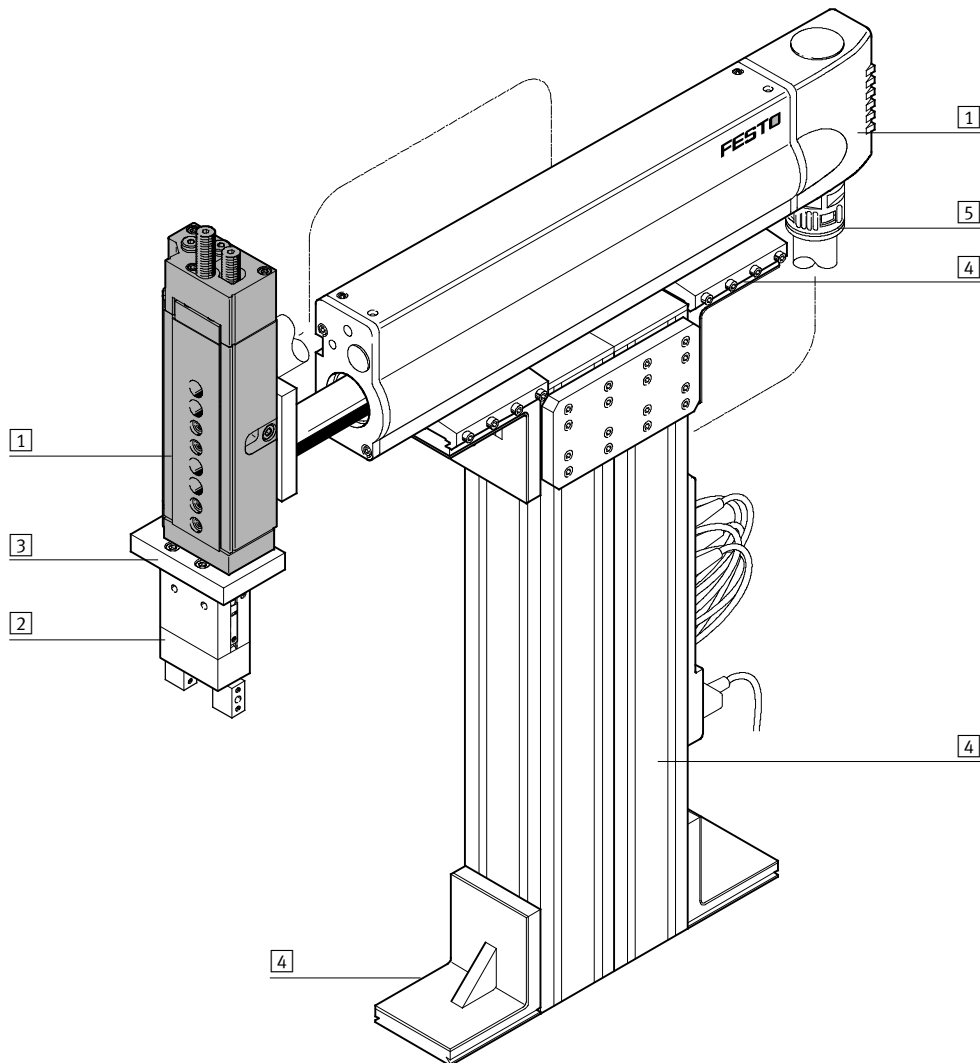



System components and accessories		
	Brief description	→ Page/Internet
1	Drives	Wide range of combinations possible within handling and assembly technology drive
2	Grippers	Wide range of variations possible within handling and assembly technology gripper
3	Adapters	For drive/drive and drive/gripper connections adapter kit
4	Basic components	Profiles and profile connections as well as profile/drive connections basic component
5	Installation components	For a clear, safe layout of electrical cables and tubing installation component
-	Axes	Wide range of combinations possible within handling and assembly technology axis
-	Motors	Servo and stepper motors, with or without gearing motor

Mini slides DGSL

Peripherals overview

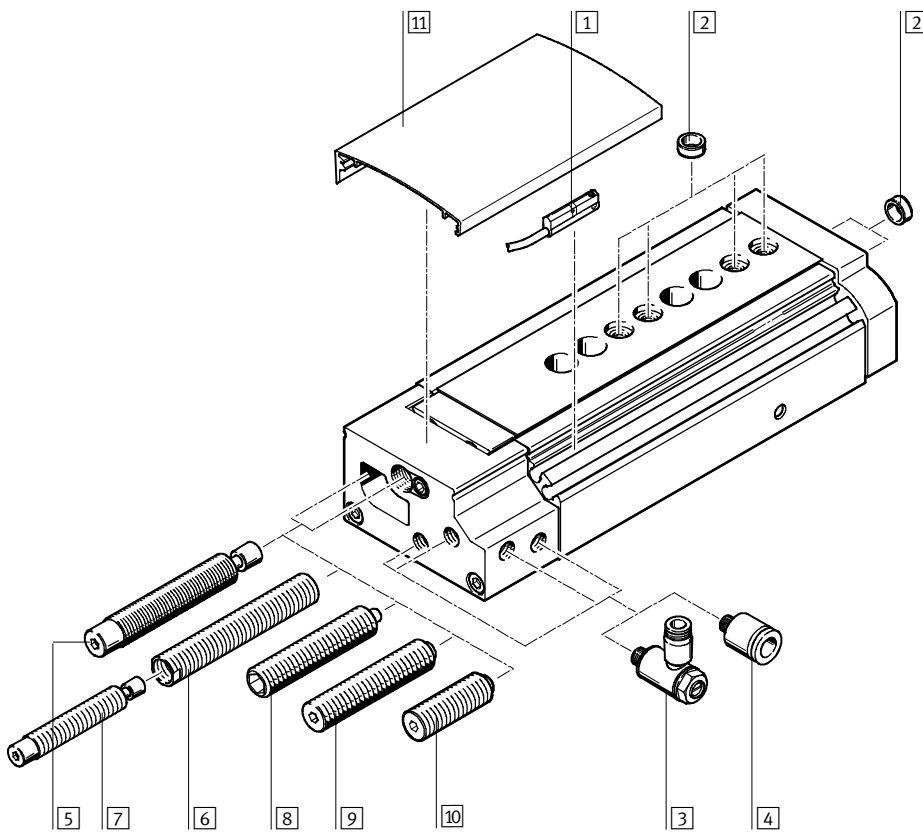
FESTO



 Note
Operation without cushioning components is not permitted.

Accessories			
	Brief description	→ Page/Internet	
1	Proximity sensor SME/SMT-10	For position sensing. Can be integrated in the sensor slot, so there are no projecting parts	47
2	Centring sleeve ZBH	For centring loads and attachments (centring sleeves are included in the scope of delivery of the mini slide)	46
3	One-way flow control valve GRLA	For regulating speed	47
4	Push-in fitting QSM	For connecting compressed air tubing with standard O.D.	47
5	Cushioning with shock absorber Y3	For large loads and high speed. Ensures precise, metal-to-metal contact after the cushioning	46
6	Reducing sleeve DAYH	For installing a smaller shock absorber. For applications where the cushioning energy lies between the cushioning Y3 and P1	46
7	Shock absorber DYSW	→ 12 (shock absorber selection)	46
8	Cushioning with stop P1	Precision metal stop for small loads at low speed	46
9	Cushioning P	<ul style="list-style-type: none"> • Flexible stop for medium loads at medium speed • (standard design) 	46
10	Cushioning E	<ul style="list-style-type: none"> • Flexible stop for medium loads at medium speed • (short design) 	46
11	Cover DADS	<ul style="list-style-type: none"> • For protection, to stop foreign parts or dirt getting into the guide • The cover can be trimmed as required by the customer 	45

Mini slides DGSL

Type codes

		DGSL	-	10	-	100	-		-	E3	-	Y3	-	A
Type														
Double-acting														
DGSL	Mini slide													
Size														
Stroke [mm]														
Clamping unit														
C	Attached													
End-position locking														
E3	With piston rod in retracted position													
Cushioning														
P	Elastic cushioning without metal end position, both ends													
P1	Elastic cushioning with metal end position, both ends													
Y3	Progressive shock absorber, both ends													
E	Elastic cushioning without metal end position, both ends, short design													
Y11	Progressive shock absorber with reducing sleeve, both ends													
N	Without cushioning													
Position sensing														
A	Via proximity sensor													

Mini slides DGSL

Technical data

FESTO

Function

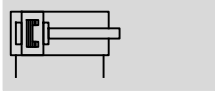

○ - Size
4 ... 25

┆ - Stroke length
10 ... 200 mm

Wearing parts kits

→ 45

Technical data:

- DGSL-C (with clamping unit)
 - DGSL-E3 (with end-position locking)
- 40



General technical data		4	6	8	10	12	16	20	25
Size		4	6	8	10	12	16	20	25
Pneumatic connection		M3			M5		G1/8		
Design		Scotch yoke system							
Guide		Ball bearing cage guide							
Type of mounting		Via through-hole Via female thread							
Cushioning	P	Elastic cushioning without metal end position, both ends							
	E	Elastic cushioning without metal end position, both ends, short design							
	P1	Elastic cushioning with metal end position, both ends, adjustable							
	Y3	-			Progressive shock absorber, both ends				
	Y11	-			Progressive shock absorber with reducing sleeve, both ends				
	N	-			Without cushioning				
Position sensing		Via proximity sensor							
Mounting position		Any							
Max. advancing speed	[m/s]	0.5			0.8				
Max. retracting speed	[m/s]	0.5			0.8				
Repetition accuracy	P1/Y3	[mm]	±0.01						
	P	[mm]	0.3						

Operating and environmental conditions		4	6	8	10	12	16	20	25
Size		4	6	8	10	12	16	20	25
Operating medium		Compressed air in accordance with ISO 8573-1:2010 [7:4:4]							
Note on operating/pilot medium		Operation with lubricated medium possible (in which case lubricated operation will always be required)							
Min. operating pressure	[bar]	2.5	1.5			1			
Max. operating pressure	[bar]	8							
Ambient temperature ¹⁾	[°C]	0 ... +60							

1) Note operating range of proximity sensors.

Piston Ø, forces and impact energy		4	6	8	10	12	16	20	25	
Size		4	6	8	10	12	16	20	25	
Piston Ø	[mm]	6	8	10	12	16	20	25	32	
Theoretical force at 6 bar, advancing	[N]	17	30	47	68	121	188	295	483	
Theoretical force at 6 bar, retracting	[N]	13	23	40	51	104	158	247	415	
Impact energy in the end positions	P, E	[Nm]	0.015	0.05	0.08	0.12	0.25	0.35	0.45	0.55
	P1	[Nm]	0.005	0.02	0.03	0.04	0.06	0.12	0.2	0.25
	Y3	[Nm]	-	-	0.8	1.3	2.5	4	8	12
	1)	[Nm]	-	-	-	0.8	1.3	2.5	4	8

1) With reducing sleeve and next smallest shock absorber.

Mini slides DGSL

Technical data

FESTO

Weight [g]									
Size	Stroke	4	6	8	10	12	16	20	25
Product weight without cushioning component									
	10	82	158	235	396	604	896	1,535	2,520
	20	93	179	263	434	660	954	1,649	2,670
	30	104	197	289	470	711	1,008	1,746	2,824
	40	–	215	313	507	762	1,072	1,857	2,983
	50	–	232	370	548	813	1,143	1,991	3,137
	80	–	–	454	727	1,112	1,365	2,295	4,019
	100	–	–	–	813	1,229	1,712	2,921	4,519
	150	–	–	–	–	1,499	2,034	3,620	5,344
	200	–	–	–	–	–	–	4,248	6,139
Moving load without cushioning component									
	10	31	68	101	163	256	403	660	998
	20	34	76	111	180	279	432	710	1,052
	30	38	83	121	194	299	459	750	1,115
	40	–	90	130	208	320	486	801	1,181
	50	–	99	152	226	340	519	858	1,244
	80	–	–	185	299	456	618	998	1,567
	100	–	–	–	334	507	776	1,254	1,761
	150	–	–	–	–	614	910	1,566	2,102
	200	–	–	–	–	–	–	1,807	2,432
Cushioning component									
	P	2	3.6	6	14	23	45.6	82.4	106
	E	1	2	3	9	12	15	31	40
	P1	1.6	3	5	12	19.7	39.6	77.3	104
	Y3	–	–	6	11	21	42	67	91
	1)	–	–	–	18	33	52	91	131

1) With reducing sleeve and next smallest shock absorber.

Materials

Sectional view

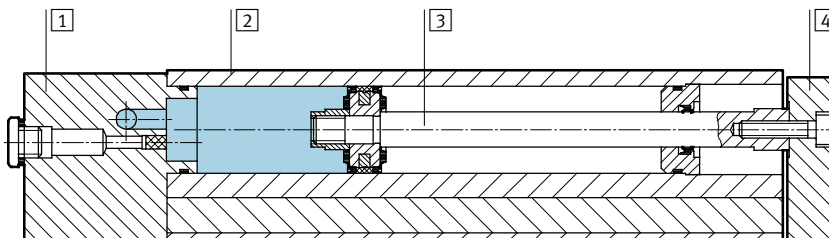

Mini slide		
1	End cap	Anodised aluminium
2	Housing	Anodised aluminium
3	Piston rod	High-alloy steel
4	Yoke plate	Anodised aluminium
–	Guide	Tempered steel
–	Seals	Thermoplastic rubber, hydrogenated nitrile rubber, nitrile rubber
	Note on materials	Free of copper and PTFE

Mini slides DGSL

Technical data

Possible combinations without adapter plate

Pick and place

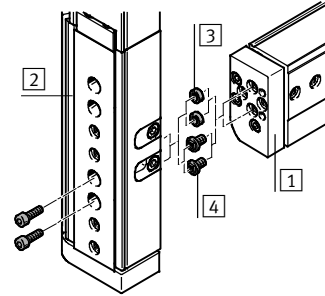
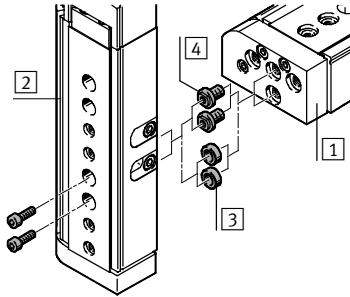

- 3 Centring sleeve ZBH
- 4 Connector sleeve ZBV

Piggy-back assembly

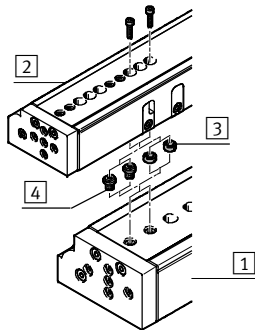

- 3 Centring sleeve ZBH
- 4 Connector sleeve ZBV

Mounting example with connector sleeve ZBV

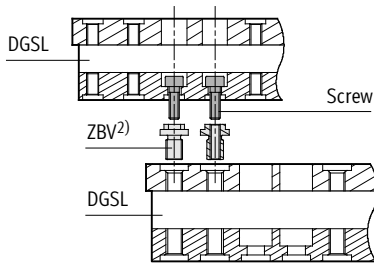

		1 Basic drive								
		Size	4	6	8	10	12	16	20	25
2 Assembly drive	4	2x M3x7 2x ZBH-5 ¹⁾	2x M3x10 2x ZBH-5 ¹⁾	ZBV-M4-7 ²⁾	ZBV-M4-7 ²⁾	-	-	-	-	-
	6	-	2x M3x10 2x ZBH-5 ¹⁾	ZBV-M4-7 ²⁾	ZBV-M4-7 ²⁾	-	-	-	-	-
	8	-	-	2x M4x12 2x ZBH-7 ¹⁾	2x M4x12 2x ZBH-7 ¹⁾	ZBV-M5-7 ²⁾	ZBV-M5-7 ²⁾	-	-	-
	10	-	-	-	2x M4x14 2x ZBH-7 ¹⁾	ZBV-M5-7 ²⁾	ZBV-M5-7 ²⁾	-	-	-
	12	-	-	-	-	2x M5x14 2x ZBH-7 ¹⁾	2x M5x16 2x ZBH-7 ¹⁾	ZBV-M6-9 ²⁾	ZBV-M6-9 ²⁾	-
	16	-	-	-	-	-	2x M5x18 2x ZBH-7 ¹⁾	ZBV-M6-9 ²⁾	ZBV-M6-9 ²⁾	-
	20	-	-	-	-	-	-	2x M6x20 2x ZBH-9 ¹⁾	2x M6x20 2x ZBH-9 ¹⁾	-
	25	-	-	-	-	-	-	-	2x M6x30 2x ZBH-9 ¹⁾	-

1) Centring sleeves ZBH are included in the scope of delivery of the mini slide DGSL

2) Connector sleeves ZBV → 46

Mini slides DGSL

Technical data

Parallelism [mm]

The term parallelism refers to the accuracy of alignment between the mounting surface and the slide surface.

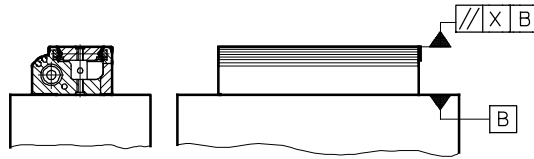

Size	Stroke [mm]	4	6	8	10	12	16	20	25
Parallelism X	10	0.02	0.02	0.02	0.02	0.02	0.02	0.02	0.02
	20	0.02	0.02	0.02	0.02	0.025	0.025	0.025	0.025
	30	0.025	0.025	0.025	0.025	0.025	0.025	0.03	0.03
	40	-	0.025	0.025	0.025	0.03	0.03	0.035	0.035
	50	-	0.03	0.03	0.03	0.035	0.035	0.04	0.04
	80	-	-	0.035	0.035	0.04	0.04	0.045	0.045
	100	-	-	-	0.045	0.05	0.05	0.055	0.055
	150	-	-	-	-	0.075	0.075	0.08	0.08
200	-	-	-	-	-	-	0.08	0.08	

Linearity [mm]

The term linearity refers to the accuracy of alignment between the mounting surface and the slide surface as a function of the stroke.

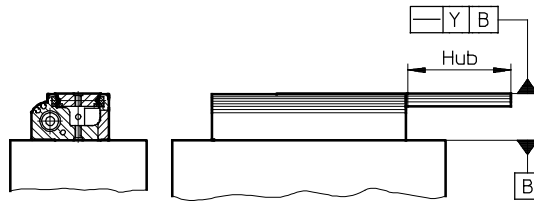

Linear travel accuracy as a function of stroke length l

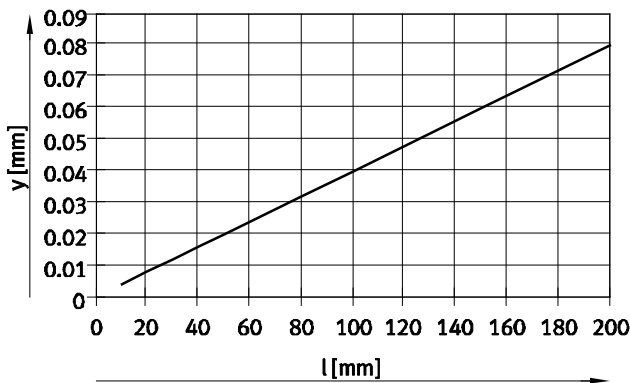

Mini slides DGSL

Technical data

Adjustable end-position range

Coarse adjustment of the advanced end position

The mini slide DGSL allows the advanced fixed stop to be adjusted by removing the cover.

This permits stroke reduction down to the next but one smaller standard stroke through a combination of coarse and precision adjustments.

Advantages:

- Can be flexibly adapted to the application
- Integrated, which means reduced conversion effort and costs
- Large setting range



Note

Removal of the fixed stops can result in the destruction of the mini slide DGSL.

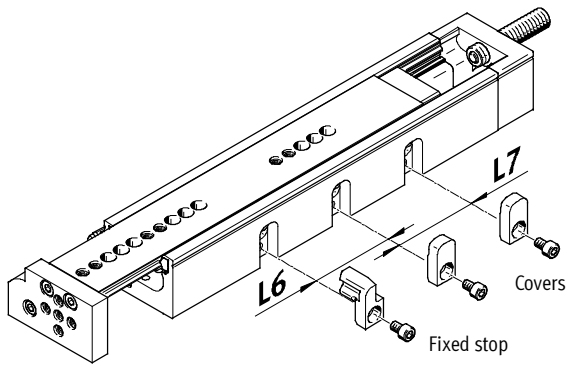

Size Stroke [mm]	4		6		8		10		12		16		20		25	
	L6	L7	L6	L7	L6	L7	L6	L7	L6	L7	L6	L7	L6	L7	L6	L7
10	-	-	-	-	-	-	-	-	-	-	-	-	-	-	-	-
20	10	-	14	-	10	-	-	-	-	-	-	-	-	-	-	-
30	10	-	14	-	16	-	-	-	-	-	-	-	-	-	-	-
40	-	-	14	-	16	-	-	-	-	-	-	-	-	-	-	-
50	-	-	14	14	16	-	-	-	-	-	-	-	-	-	-	-
80	-	-	-	-	16	16	24	-	29	-	35	-	-	-	55	-
100	-	-	-	-	-	-	24	24	29	-	35	-	44	-	55	-
150	-	-	-	-	-	-	-	-	29	29	35	-	44	-	55	-
200	-	-	-	-	-	-	-	-	-	-	-	-	44	44	55	-

Example:

DGSL-12-150-...

Max. stroke = 150 mm

By adjusting the fixed stop

by the dimension **L6**:

Stroke = $150 - 29 = 121$ mm

By adjusting the fixed stop

by the dimension **L6 and L7**:

Stroke = $150 - 29 - 29 = 92$ mm

The stroke can additionally be

reduced by means of precision

adjustment:

Stroke = $150 - 29 - 29 - 29$

= 63 mm

Precision adjustment

of the advanced and retracted end position → 11

Mini slides DGSL

Technical data

Adjustable end-position range

Precision adjustment of the advanced and retracted end position

Precision adjustment of the required stroke reduction is possible using the cushioning components (on the slide and in the end cap).

Advantages:

- Precision adjustment is accurately fixed by the clamping component
- No readjustment required, position is fully retained under load
- Quick and easy adjustment, only one tool required

Step 1:

Loosen the clamping component.

Step 2:

Position the slide by hand in the desired end position.

Step 3:

Turn the stop element using an Allen key until the end position is reached.

Step 4:

Tighten the clamping component.

Step 1

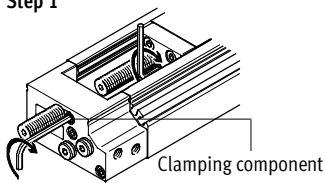

Step 2 ... 4

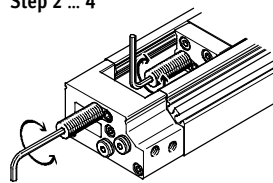

Adjustable end-position range [mm] per end position/stroke reduction									
Size		4	6	8	10	12	16	20	25
Advanced end position									
With cushioning	P	-14.5	-16.5	-19.5	-27.5	-29	-37.5	-50.5	-55
	E	-4.5	-5	-4.5	-13	-9	-3.5	-6.5	-11.5
	P1	-14.5	-16.5	-19.5	-27.5	-29	-37.5	-50.5	-55
	Y3	-	-	-15	-24	-29	-36.5	-44	-56
	1)	-	-	-	-24	-29	-36.5	-44	-56
Retracted end position									
With cushioning	P	-13.5	-15	-18.5	-20	-25.5	-39.5	-49.5	-49
	E	-3.5	-3.5	-3.5	-5.5	-5.5	-5.5	-5.5	-5.5
	P1	-13.5	-15	-18.5	-20	-25.5	-39.5	-49.5	-49
	Y3	-	-	-14	-15	-25.5	-38.5	-42	-51.5
	1)	-	-	-	-15	-25.5	-38.5	-42	-51.5

1) With reducing sleeve and next smallest shock absorber.

Note

The distance L of the cushioning component (→ operating instructions) must not be fallen below (factory setting).

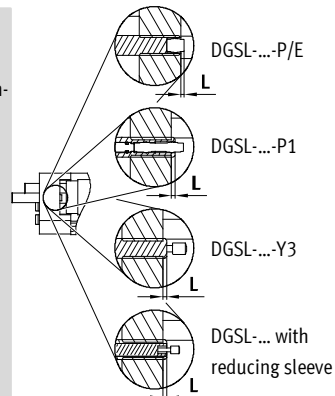

Note

The setting range of the advanced and retracted end position is restricted when using the cushioning type "E".

Mini slides DGSL

Technical data

Shock absorber selection

Effective load m as a function of impact velocity v

With the mini slide DGSL the shock absorber can be replaced and thus the cushioning behaviour can be influenced (depending on the effective load).

This is done by removing the existing shock absorbers on the DGSL and replacing them with a smaller shock absorber as appropriate to the application (→ description below).

Graphs

for selecting a suitable shock absorber as a function of the mounting position of the mini slide → from 13.

Ordering data

Shock absorbers DYSW, DYEF and reducing sleeve DAYH → 46.

With smaller loads:

The next smallest shock absorber DYSW can be installed with the help of the reducing sleeve DAYH.

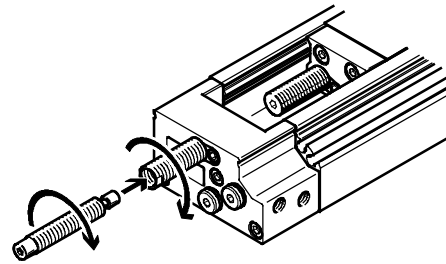
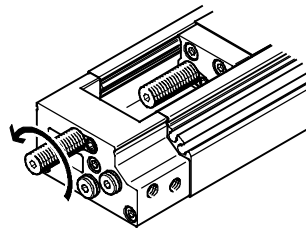

With very small loads:

The shock absorber DYEF can be installed.

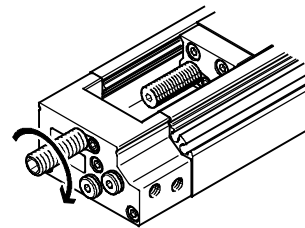
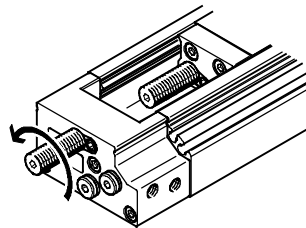

Selection example:

Existing drive:
Mini slide: DGSL-10-...-Y3-A

Given:
Effective load: 500 g
Impact velocity: 0.4 m/s
Mounting position: Horizontal

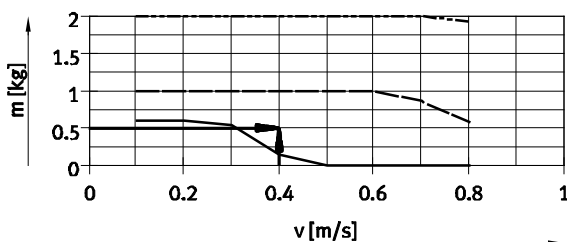

- DYSW-5-8 (cushioning Y3)
- DYSW-4-6 with DAYH-4 (cushioning Y11)
- DYEF-M8-Y1F

Result:

The first cushioning curve, which is located above the point of intersection, is the most suitable for this case. Due to the low effective load of less than one kilogram, the cushioning characteristics are greatly improved by

replacing the shock absorber DYSW-5-8 integrated in the mini slide with the reducing sleeve DAYH-4 and the next smallest shock absorber DYSW-4-6.

Fundamentally, the following applies: shock absorbers must be loaded. Since the shock absorber DYSW-4-6 is more fully utilised in this case, both the service life of the shock absorber

and the cushioning characteristics are improved.

Mini slides DGSL

Technical data

Shock absorber selection

Effective load m as a function of impact velocity v – horizontal mounting position

DGSL-4

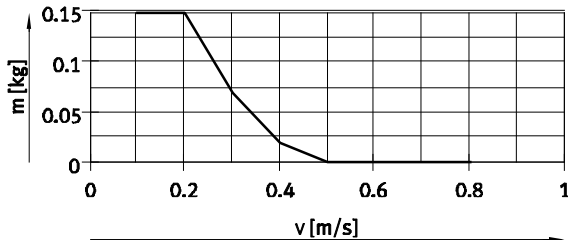

— DYE-F-M4-Y1F (cushioning P1)

DGSL-6

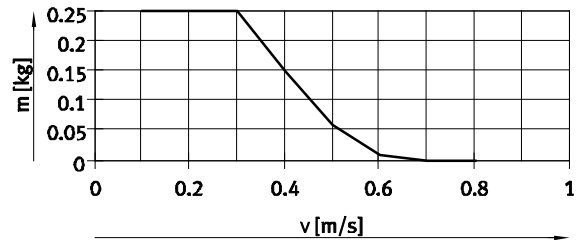

— DYE-F-M5-Y1F (cushioning P1)

DGSL-8

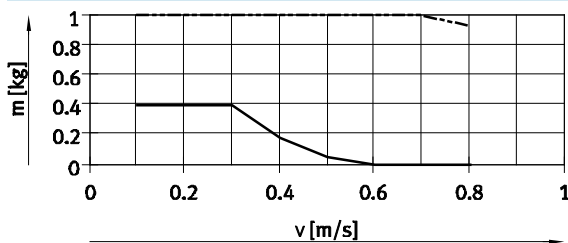

--- DYSW-4-6 (cushioning Y3)
— DYE-F-M6-Y1F

DGSL-10

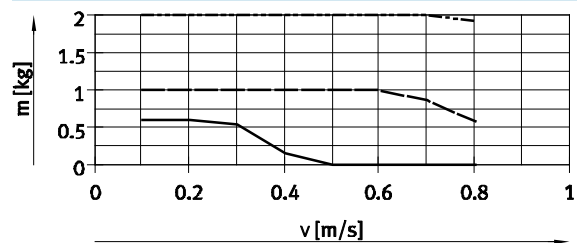

--- DYSW-5-8 (cushioning Y3)
--- DYSW-4-6 with DAYH-4 (cushioning Y11)
— DYE-F-M8-Y1F

DGSL-12

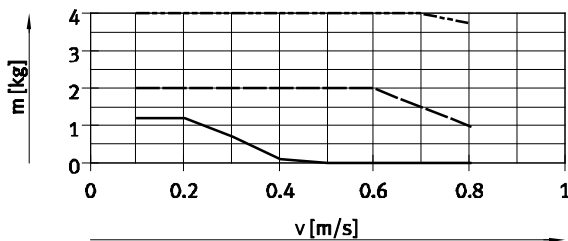

--- DYSW-7-10 (cushioning Y3)
--- DYSW-5-8 with DAYH-5 (cushioning Y11)
— DYE-F-M10-Y1F

DGSL-16

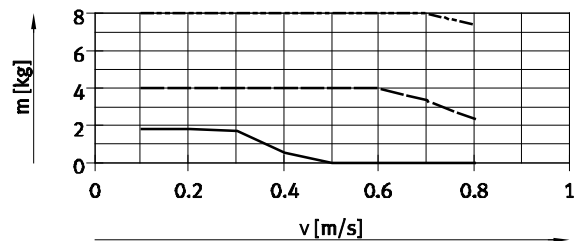

--- DYSW-8-14 (cushioning Y3)
--- DYSW-7-10 with DAYH-7 (cushioning Y11)
— DYE-F-M12-Y1F

DGSL-20

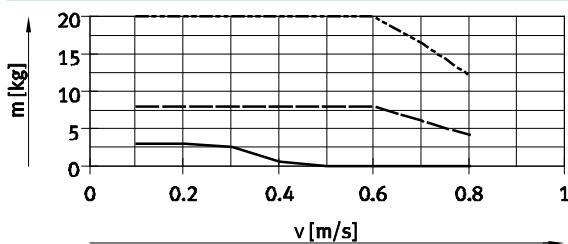

--- DYSW-10-17 (cushioning Y3)
--- DYSW-8-14 with DAYH-8 (cushioning Y11)
— DYE-F-M14-Y1F

DGSL-25

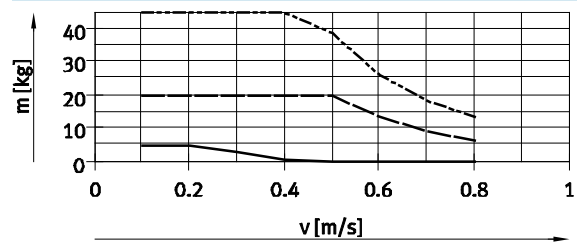

--- DYSW-12-20 (cushioning Y3)
--- DYSW-10-17 with DAYH-10 (cushioning Y11)
— DYE-F-M16-Y1F

Mini slides DGSL

Technical data

FESTO

Shock absorber selection

Effective load m as a function of impact velocity v – vertical mounting position, effective load moving upwards

DGSL-4

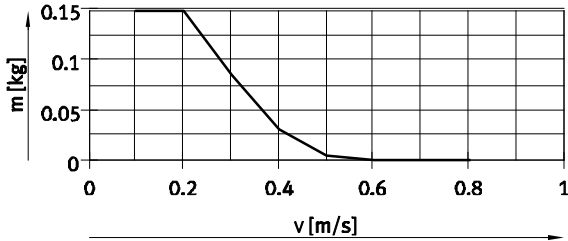

— DYE-F-M4-Y1F (cushioning P1)

DGSL-6

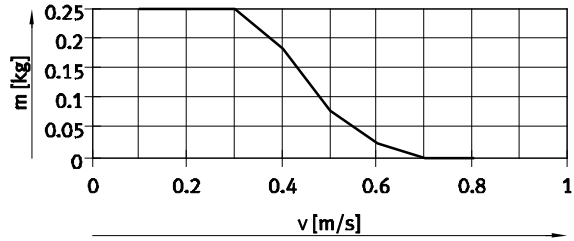

— DYE-F-M5-Y1F (cushioning P1)

DGSL-8

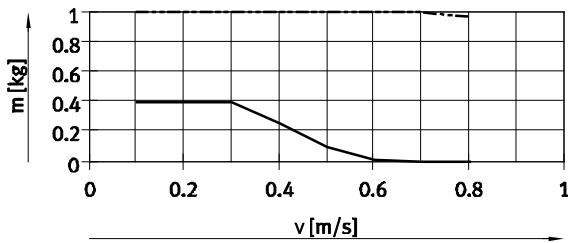

----- DYSW-4-6 (cushioning Y3)
 — DYE-F-M6-Y1F

DGSL-10

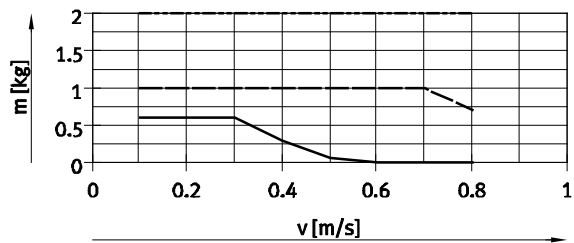

----- DYSW-5-8 (cushioning Y3)
 ----- DYSW-4-6 with DAYH-4 (cushioning Y11)
 — DYE-F-M8-Y1F

DGSL-12

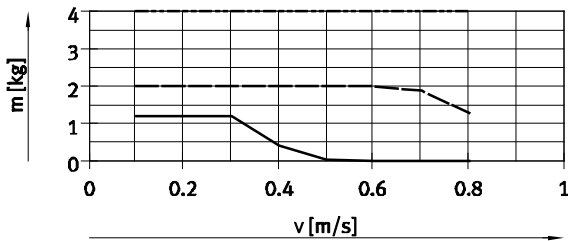

----- DYSW-7-10 (cushioning Y3)
 ----- DYSW-5-8 with DAYH-5 (cushioning Y11)
 — DYE-F-M10-Y1F

DGSL-16

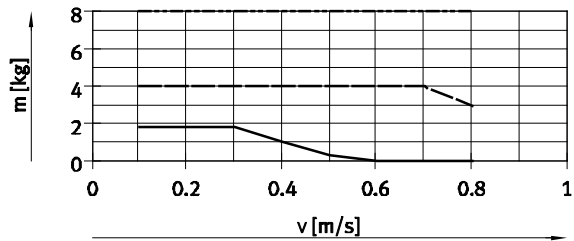

----- DYSW-8-14 (cushioning Y3)
 ----- DYSW-7-10 with DAYH-7 (cushioning Y11)
 — DYE-F-M12-Y1F

DGSL-20

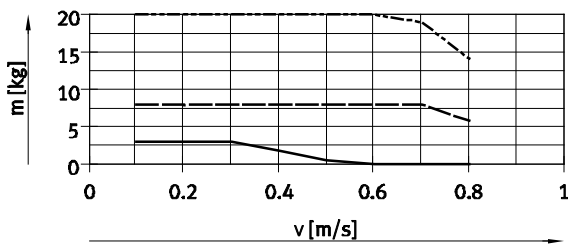

----- DYSW-10-17 (cushioning Y3)
 ----- DYSW-8-14 with DAYH-8 (cushioning Y11)
 — DYE-F-M14-Y1F

DGSL-25

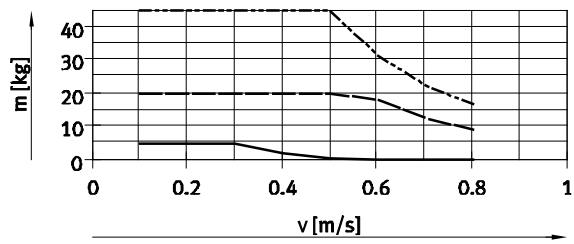

----- DYSW-12-20 (cushioning Y3)
 ----- DYSW-10-17 with DAYH-10 (cushioning Y11)
 — DYE-F-M16-Y1F

Mini slides DGSL

Technical data

Shock absorber selection

Effective load m as a function of impact velocity v – vertical mounting position, effective load moving downwards

DGSL-4

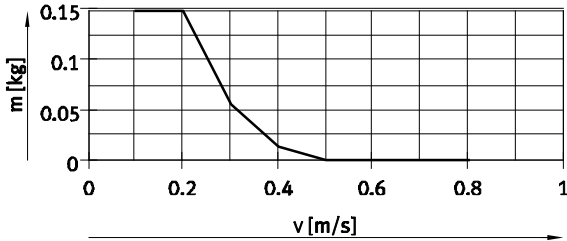

— DYE-F-M4-Y1F (cushioning P1)

DGSL-6

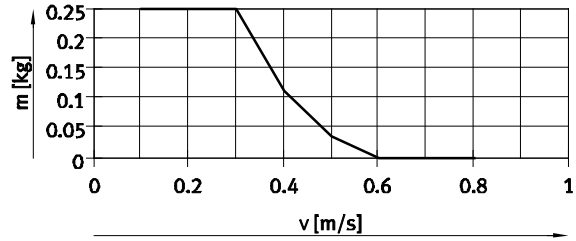

— DYE-F-M5-Y1F (cushioning P1)

DGSL-8

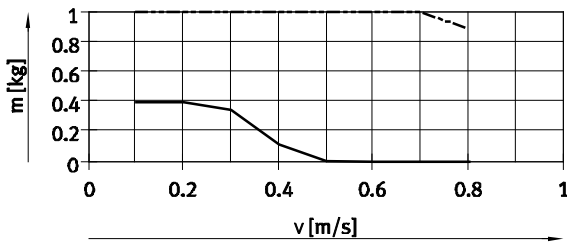

--- DYSW-4-6 (cushioning Y3)
— DYE-F-M6-Y1F

DGSL-10

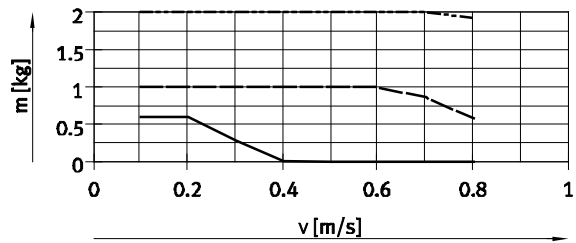

--- DYSW-5-8 (cushioning Y3)
--- DYSW-4-6 with DAYH-4 (cushioning Y11)
— DYE-F-M8-Y1F

DGSL-12

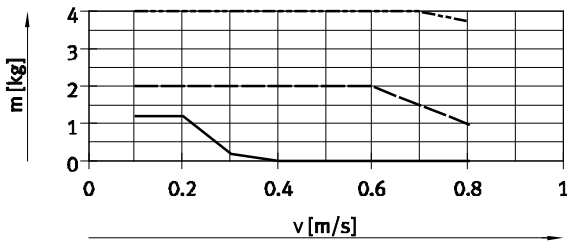

--- DYSW-7-10 (cushioning Y3)
--- DYSW-5-8 with DAYH-5 (cushioning Y11)
— DYE-F-M10-Y1F

DGSL-16

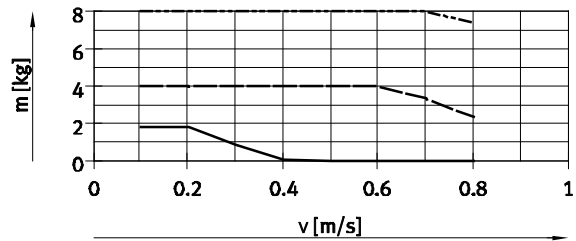

--- DYSW-8-14 (cushioning Y3)
--- DYSW-7-10 with DAYH-7 (cushioning Y11)
— DYE-F-M12-Y1F

DGSL-20

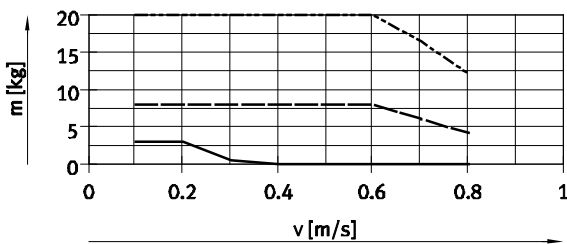

--- DYSW-10-17 (cushioning Y3)
--- DYSW-8-14 with DAYH-8 (cushioning Y11)
— DYE-F-M14-Y1F

DGSL-25

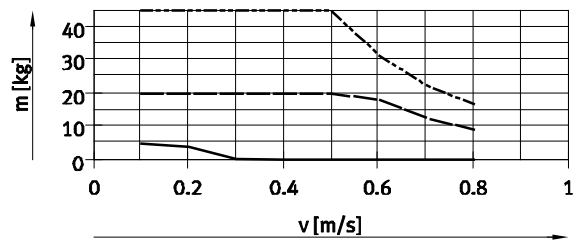

--- DYSW-12-20 (cushioning Y3)
--- DYSW-10-17 with DAYH-10 (cushioning Y11)
— DYE-F-M16-Y1F

Mini slides DGSL

Technical data

Shock absorber selection

Travel time t as a function of effective load m and cushioning P/E – horizontal mounting position

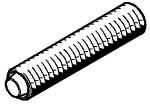

The values in the graphs are determined by calculation.
The travel time as a function of effective load must not be reduced below

the values shown, because the kinetic impact or residual energy in the end positions can result in damage to the drive.

Vertical mounting position
→ 19

Advancing

Stroke 10 mm, size 4 ... 10

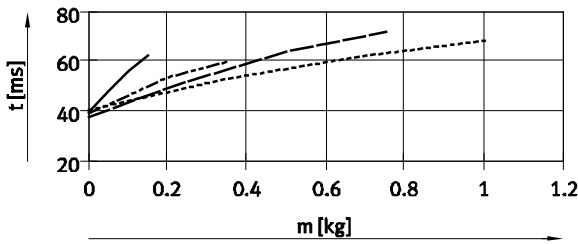

Retracting

Stroke 10 mm, size 4 ... 10

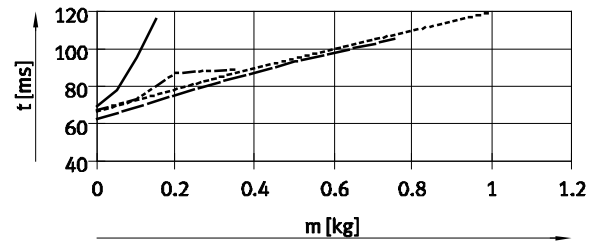

Stroke 10 mm, size 12 ... 16

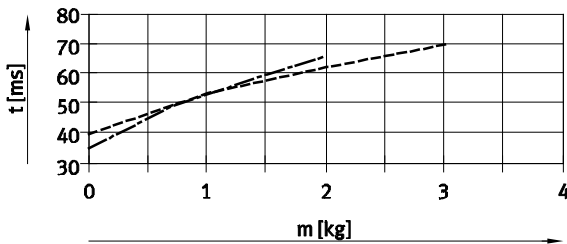

Stroke 10 mm, size 12 ... 16

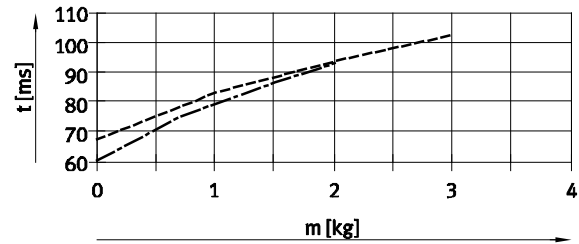

Stroke 10 mm, size 20 ... 25

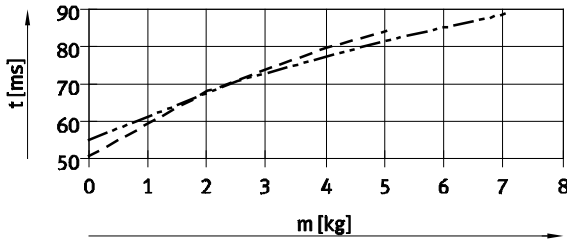

Stroke 10 mm, size 20 ... 25

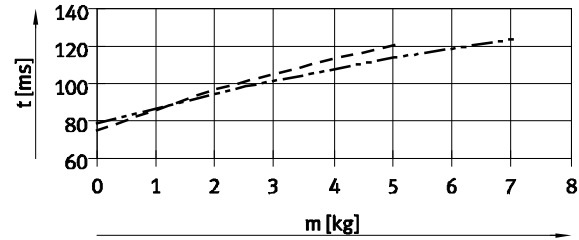

Stroke 30 mm, size 4 ... 10

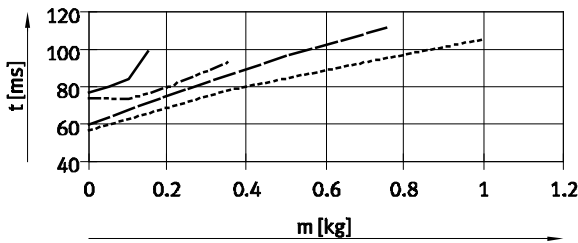

Stroke 30 mm, size 4 ... 10

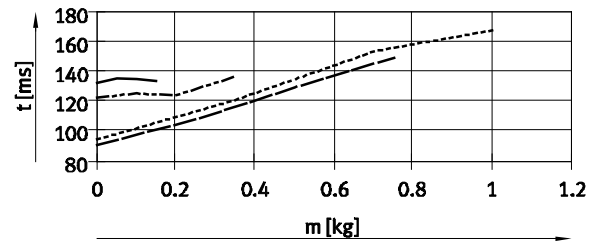

- | | | | |
|---------|---------|---------|---------|
| — | DGSL-4 | - - - - | DGSL-12 |
| - - - - | DGSL-6 | - - - - | DGSL-16 |
| — | DGSL-8 | - - - - | DGSL-20 |
| - - - - | DGSL-10 | - - - - | DGSL-25 |

Mini slides DGSL

Technical data

Shock absorber selection

Travel time t as a function of effective load m and cushioning P/E – horizontal mounting position

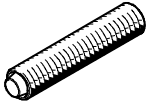

The values in the graphs are determined by calculation. The travel time as a function of effective load must not be reduced below

the values shown, because the kinetic impact or residual energy in the end positions can result in damage to the drive.

Vertical mounting position
→ 19

Advancing

Stroke 30 mm, size 12 ... 25

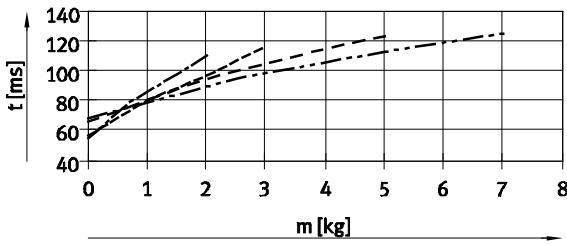

Retracting

Stroke 30 mm, size 12 ... 16

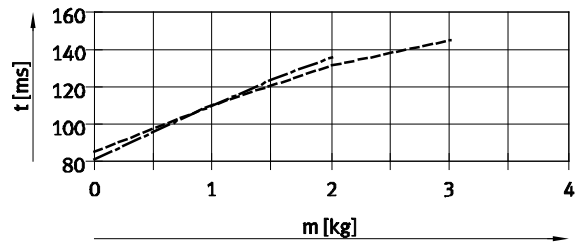

Stroke 30 mm, size 20 ... 25

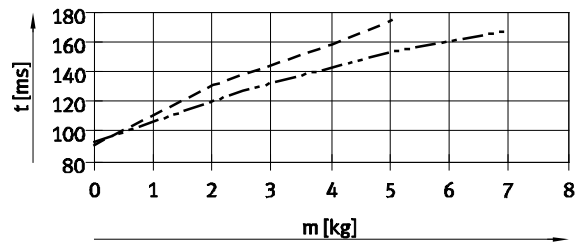

Stroke 50 mm, size 6 ... 12

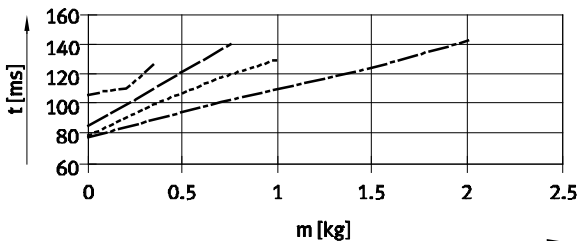

Stroke 50 mm, size 6 ... 12

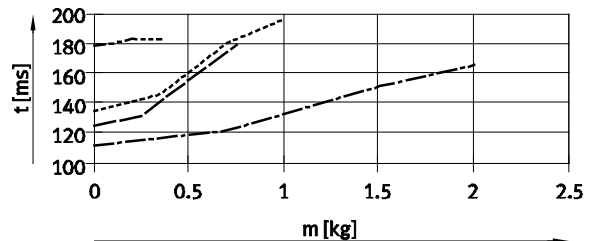

Stroke 50 mm, size 16 ... 25

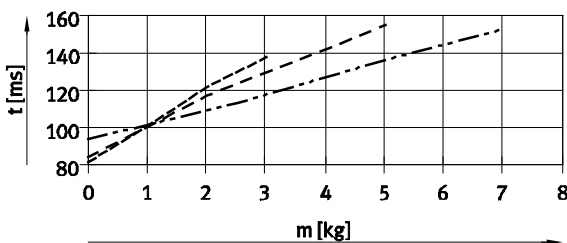

Stroke 50 mm, size 16

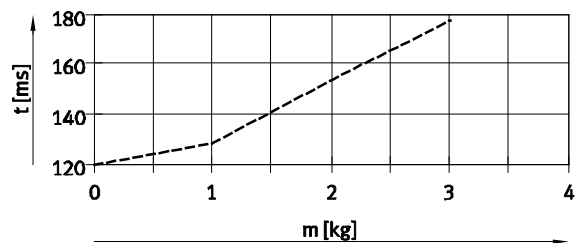

- DGSL-6
- DGSL-8
- DGSL-10
- DGSL-12
- DGSL-16
- DGSL-20
- DGSL-25

Stroke 50 mm, size 20 ... 25

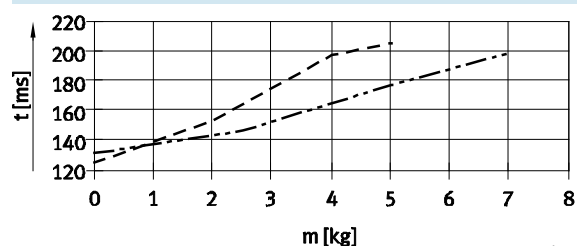

Mini slides DGSL

Technical data

Shock absorber selection

Travel time t as a function of effective load m and cushioning P/E – horizontal mounting position



The values in the graphs are determined by calculation.
The travel time as a function of effective load must not be reduced below

the values shown, because the kinetic impact or residual energy in the end positions can result in damage to the drive.

Vertical mounting position
→ 19

Advancing

Stroke 100 mm, size 10 ... 16

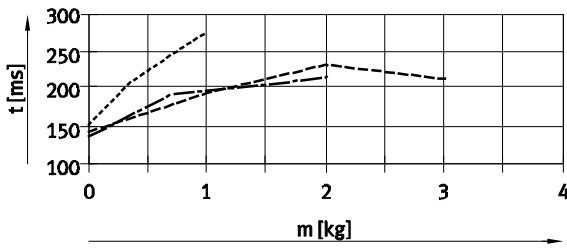

Retracting

Stroke 100 mm, size 10 ... 16

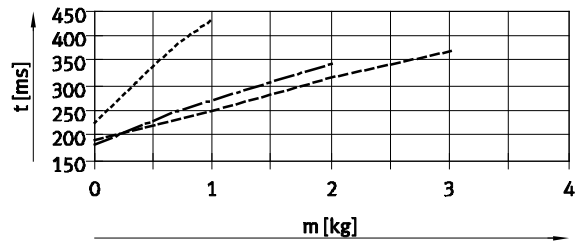

Stroke 100 mm, size 20 ... 25

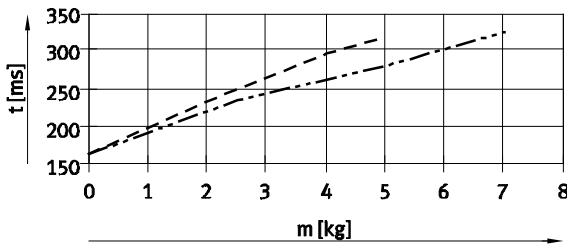

Stroke 100 mm, size 20 ... 25

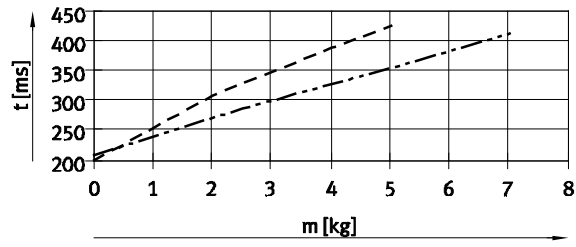

Stroke 150 mm, size 12 ... 16

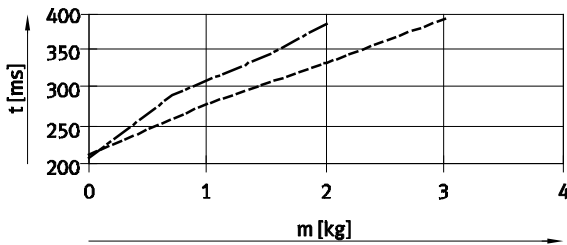

Stroke 150 mm, size 12 ... 16

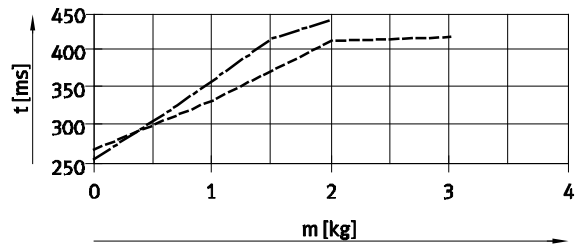

Stroke 150 mm, size 20 ... 25

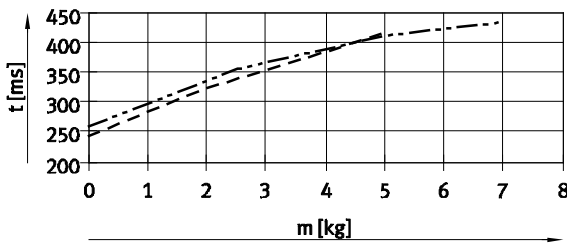

Stroke 150 mm, size 20 ... 25

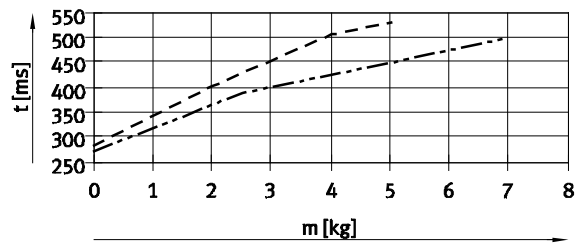

- DGSL-10
- DGSL-12
- DGSL-16
- DGSL-20
- DGSL-25

Mini slides DGSL

Technical data

Shock absorber selection

Travel time t as a function of effective load m and cushioning P/E – horizontal mounting position

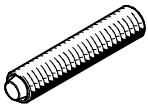

The values in the graphs are determined by calculation. The travel time as a function of effective load must not be reduced below

the values shown, because the kinetic impact or residual energy in the end positions can result in damage to the drive.

Vertical mounting position
→ 19

Advancing

Stroke 200 mm, size 20 ... 25

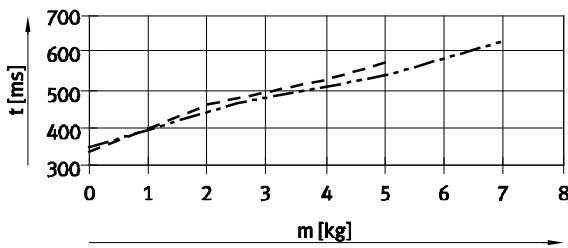

Retracting

Stroke 200 mm, size 20 ... 25

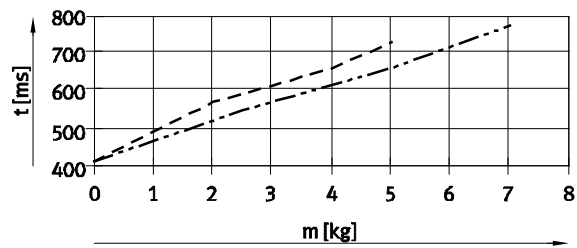

- - - - DGSL-20
- · - · - DGSL-25

Vertical mounting position

The travel times for a vertical mounting position are calculated by multiplying the data for a horizontal mounting position by a correction factor k_a (advancing) and k_r (retracting), see adjacent table.

Given:
 Stroke = 200 mm
 Size = 20
 Effective load = 3 kg
 Ascertained travel time t_h (horizontal), see graph:
 – Advancing = 500 ms
 – Retracting = 600 ms
 Calculated travel time t_v (vertical):
 – Advancing: $t_v = t_h \times k_a$
 $t_v = 500 \text{ ms} \times 0.9 = 450 \text{ ms}$
 – Retracting: $t_v = t_h \times k_r$
 $t_v = 600 \text{ ms} \times 1.1 = 660 \text{ ms}$

Stroke [mm]	Size	Advancing (k_a) ¹⁾	Retracting (k_r)
10	4, 6, 8, 10	0.95	1.1
	12, 16, 20, 25	0.95	1.2
30	4, 6, 8, 10	0.95	1.1
	12, 16, 20, 25	0.95	1.2
50	6, 8, 10, 12	0.9	1.1
	16, 20, 25	1.1	1.2
100	10, 12, 16, 20, 25	1	1.1
150	12, 16, 20, 25	1	1.1
200	20, 25	0.9	1.1

1) Downward.

Mini slides DGSL

Technical data

Shock absorber selection

Travel time t as a function of effective load m and cushioning P1 – horizontal mounting position



The values in the graphs are determined by calculation.
The travel time as a function of effective load must not be reduced below

the values shown, because the kinetic impact or residual energy in the end positions can result in damage to the drive.

Vertical mounting position
→ 23

Advancing

Stroke 10 mm, size 4 ... 10

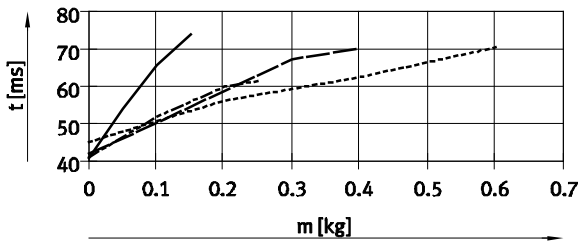

Retracting

Stroke 10 mm, size 4 ... 10

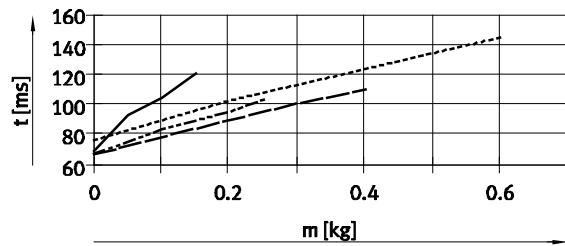

Stroke 10 mm, size 12 ... 16

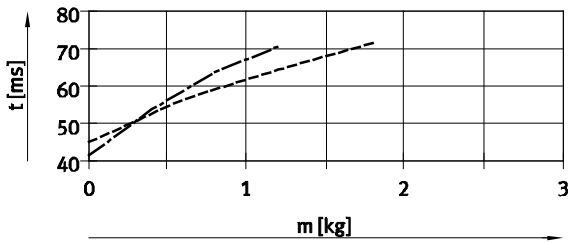

Stroke 10 mm, size 12 ... 16

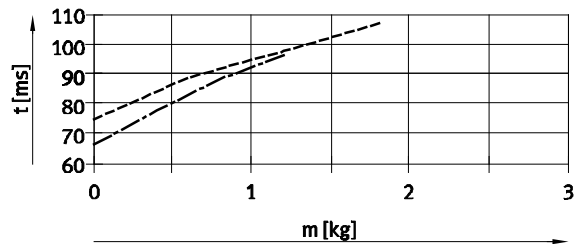

Stroke 10 mm, size 20 ... 25

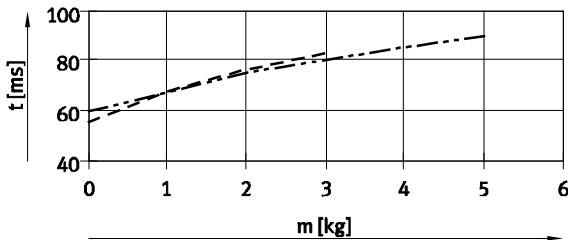

Stroke 10 mm, size 20 ... 25

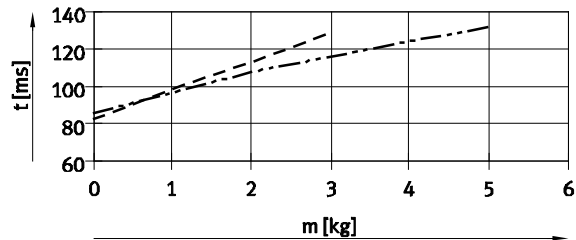

Stroke 30 mm, size 4 ... 10

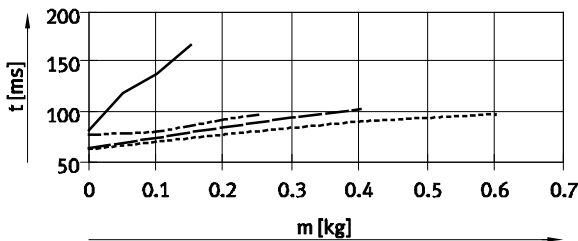

Stroke 30 mm, size 4 ... 10

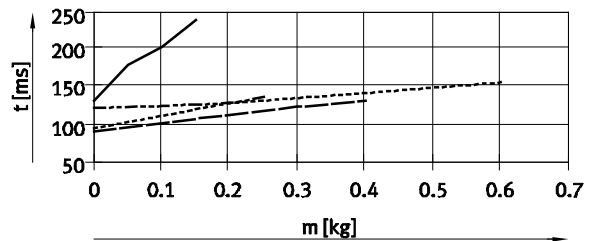

—————	DGSL-4	-----	DGSL-12
-----	DGSL-6	-----	DGSL-16
-----	DGSL-8	-----	DGSL-20
-----	DGSL-10	-----	DGSL-25

Mini slides DGSL

Technical data

Shock absorber selection

Travel time t as a function of effective load m and cushioning P1 – horizontal mounting position

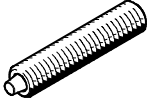

The values in the graphs are determined by calculation. The travel time as a function of effective load must not be reduced below

the values shown, because the kinetic impact or residual energy in the end positions can result in damage to the drive.

Vertical mounting position
→ 23

Advancing

Stroke 30 mm, size 12 ... 16

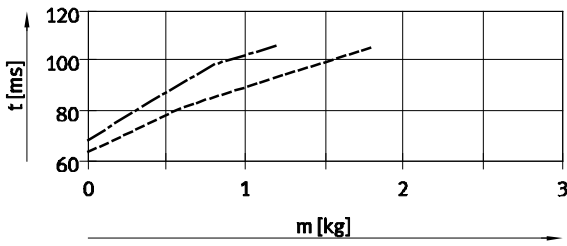

Retracting

Stroke 30 mm, size 12 ... 16

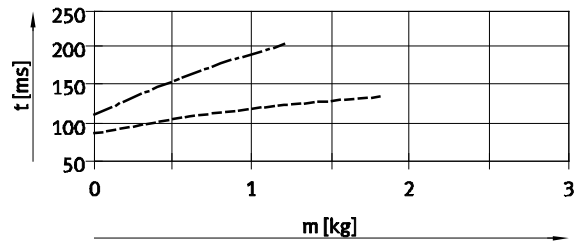

Stroke 30 mm, size 20 ... 25

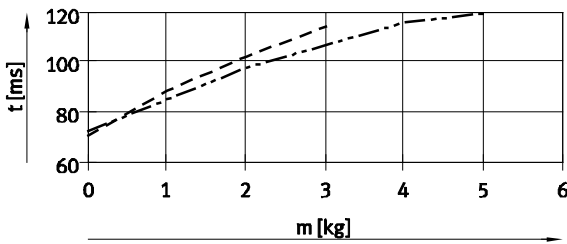

Stroke 30 mm, size 20 ... 25

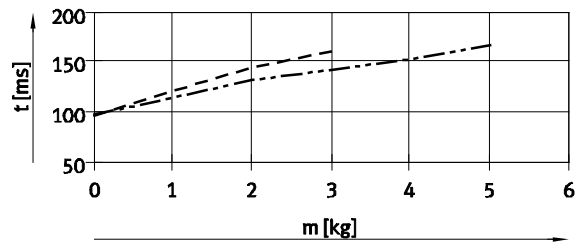

Stroke 50 mm, size 6 ... 12

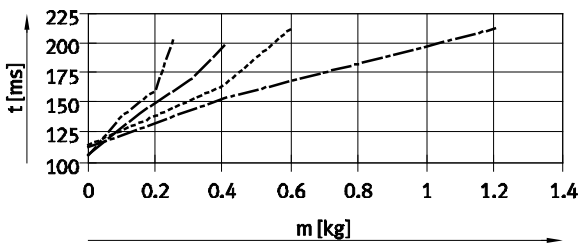

Stroke 50 mm, size 6 ... 12

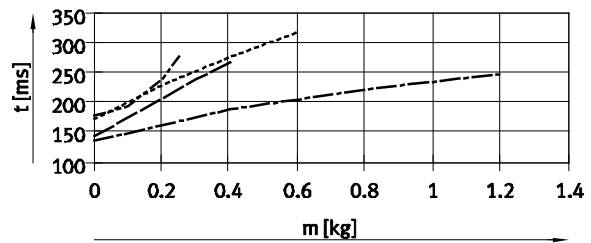

Stroke 50 mm, size 16 ... 25

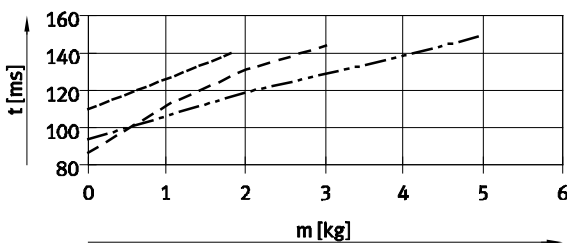

Stroke 50 mm, size 16 ... 25

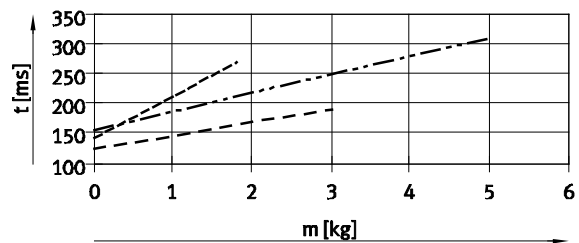

- DGSL-6
- DGSL-8
- DGSL-10
- DGSL-12
- DGSL-16
- DGSL-20
- DGSL-25

Mini slides DGSL

Technical data

Shock absorber selection

Travel time t as a function of effective load m and cushioning P1 – horizontal mounting position



The values in the graphs are determined by calculation.
The travel time as a function of effective load must not be reduced below

the values shown, because the kinetic impact or residual energy in the end positions can result in damage to the drive.

Vertical mounting position
→ 23

Advancing

Stroke 100 mm, size 10 ... 16

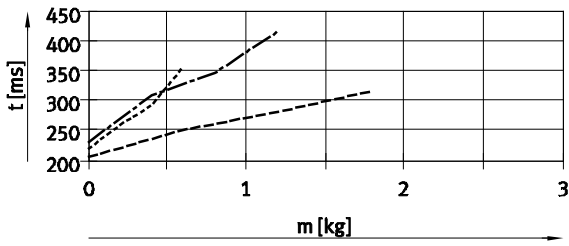

Retracting

Stroke 100 mm, size 10 ... 25

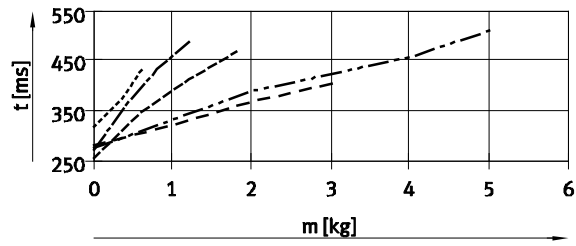

Stroke 100 mm, size 20 ... 25

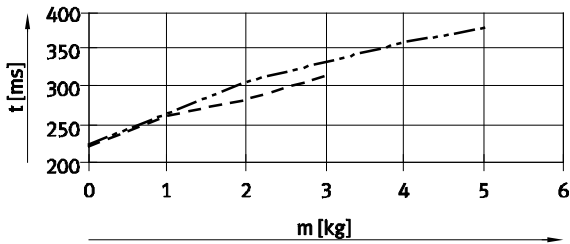

Stroke 150 mm, size 12 ... 25

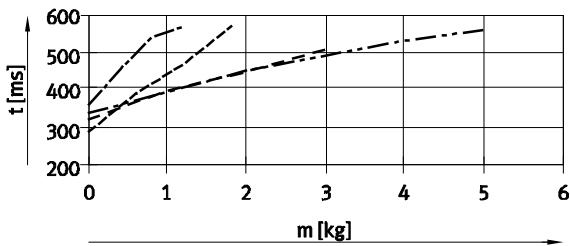

Stroke 150 mm, size 12 ... 25

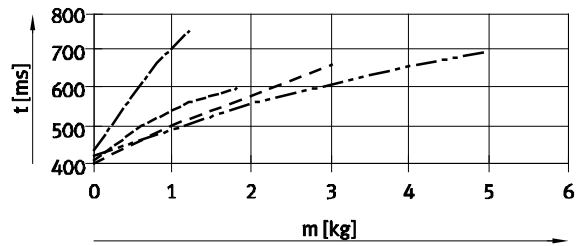

- DGSL-10
- · - · - DGSL-12
- DGSL-16
- DGSL-20
- DGSL-25

Mini slides DGSL

Technical data

Shock absorber selection

Travel time t as a function of effective load m and cushioning P1 – horizontal mounting position

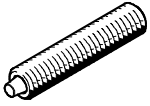

The values in the graphs are determined by calculation. The travel time as a function of effective load must not be reduced below

the values shown, because the kinetic impact or residual energy in the end positions can result in damage to the drive.

Vertical mounting position
→ 23

Advancing

Stroke 200 mm, size 20

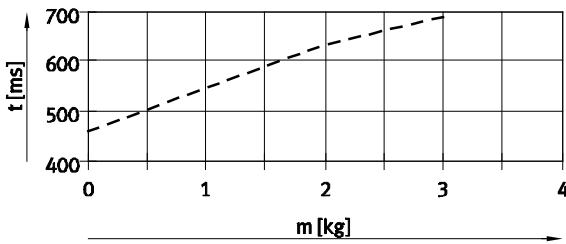

Retracting

Stroke 200 mm, size 20

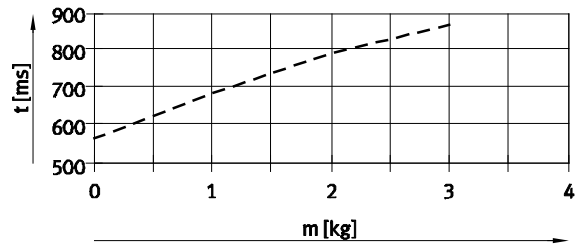

Stroke 200 mm, size 25

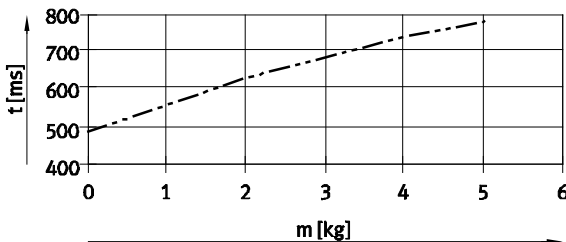

Stroke 200 mm, size 25

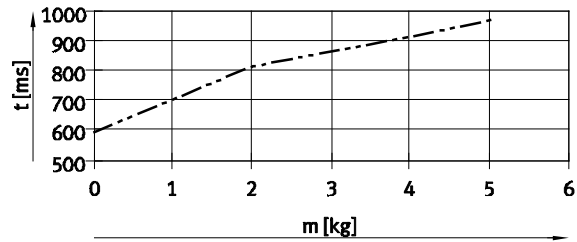

----- DGSL-20
- - - - - DGSL-25

Vertical mounting position

The travel times for a vertical mounting position are calculated by multiplying the data for a horizontal mounting position by a correction factor k_a (advancing) and k_r (retracting), see adjacent table.

Given:
Stroke = 200 mm
Size = 20
Effective load = 2 kg
Ascertained travel time t_h (horizontal), see graph:
– Advancing = 640 ms
– Retracting = 780 ms
Calculated travel time t_v (vertical):
– Advancing: $t_v = t_h \times k_a$
 $t_v = 640 \text{ ms} \times 0.9 = 576 \text{ ms}$
– Retracting: $t_v = t_h \times k_r$
 $t_v = 780 \text{ ms} \times 1.1 = 858 \text{ ms}$

Stroke [mm]	Size	Advancing (k_a) ¹⁾	Retracting (k_r)
10	4, 6, 8, 10	1	1.1
	12, 16, 20, 25	1.1	1.2
30	4, 6, 8, 10	1	1.1
	12, 16, 20, 25	1.1	1.2
50	6, 8, 10, 12	1	1.1
	16, 20, 25	0.9	1.1
100	10, 12, 16, 20, 25	0.95	1.1
150	12, 16, 20, 25	0.95	1.1
200	20, 25	0.9	1.1

1) Downward.

Mini slides DGSL

Technical data

FESTO

Shock absorber selection

Travel time t as a function of effective load m and cushioning Y3 – horizontal mounting position

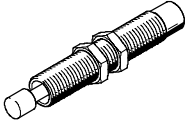

The values in the graphs are determined by calculation. The travel time as a function of effective load must not be reduced below

the values shown, because the kinetic impact or residual energy in the end positions can result in damage to the drive.

Vertical mounting position
→ 25

Advancing

Stroke 30 mm, size 8 ... 12

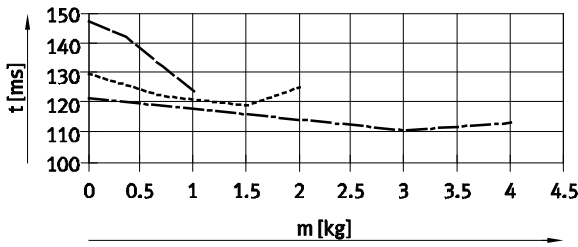

Retracting

Stroke 30 mm, size 8 ... 12

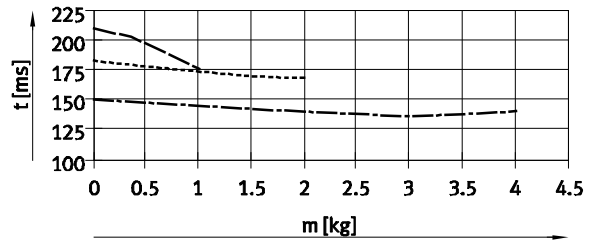

Stroke 30 mm, size 16 ... 25

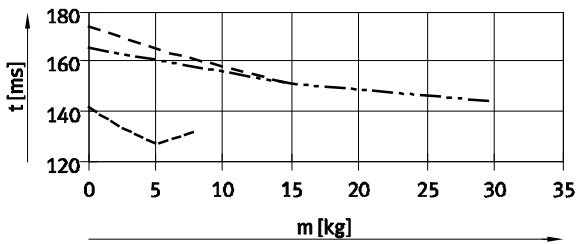

Stroke 30 mm, size 16 ... 25

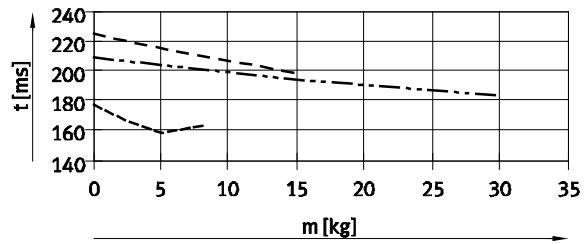

Stroke 50 mm, size 8 ... 12

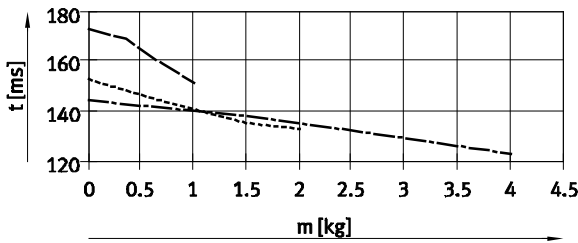

Stroke 50 mm, size 8 ... 12

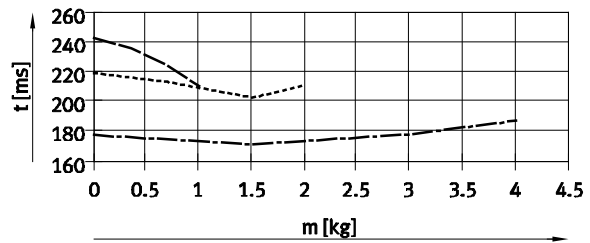

Stroke 50 mm, size 16 ... 25

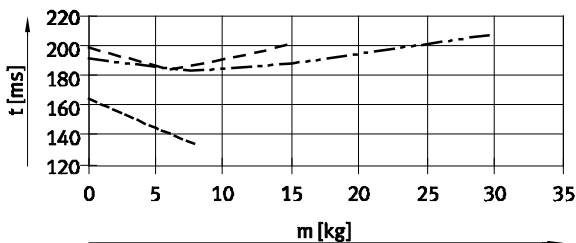

Stroke 50 mm, size 16 ... 25

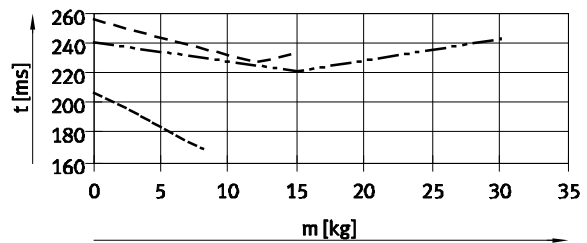

- DGSL-8 - - - - - DGSL-16
- - - - - DGSL-10 - - - - - DGSL-20
- - - - - DGSL-12 - - - - - DGSL-25

Mini slides DGSL

Technical data

Shock absorber selection

Travel time t as a function of effective load m and cushioning Y3 – horizontal mounting position

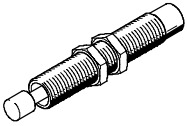

The values in the graphs are determined by calculation. The travel time as a function of effective load must not be reduced below

the values shown, because the kinetic impact or residual energy in the end positions can result in damage to the drive.

Vertical mounting position
→ 25

Advancing

Stroke 100 mm, size 10 ... 25

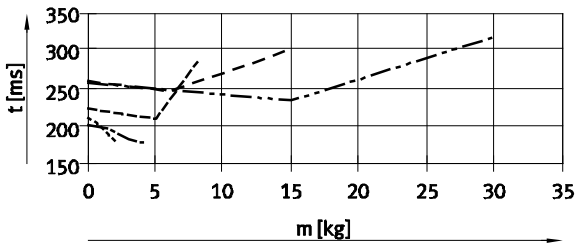

Retracting

Stroke 100 mm, size 10 ... 25

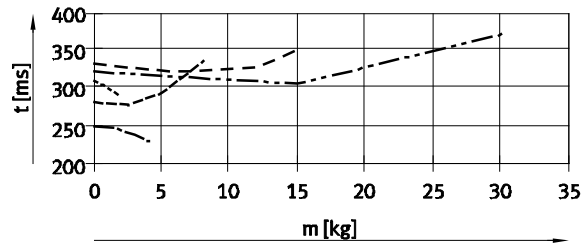

Stroke 150 mm, size 12 ... 25

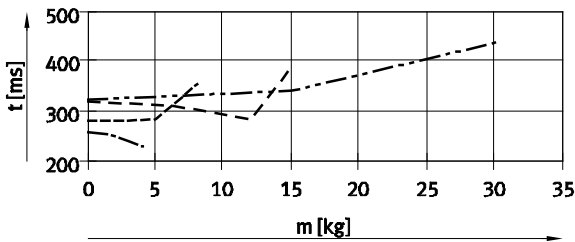

Stroke 150 mm, size 12 ... 25

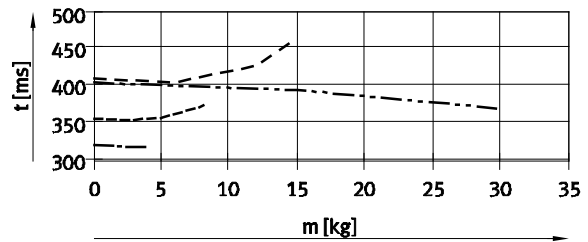

Stroke 200 mm, size 20 ... 25

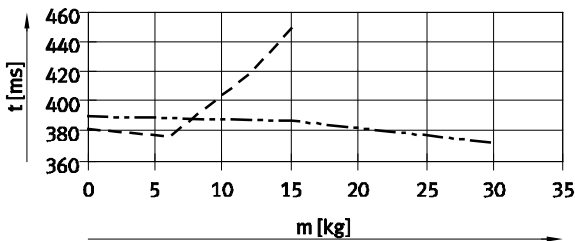

Stroke 200 mm, size 20 ... 25

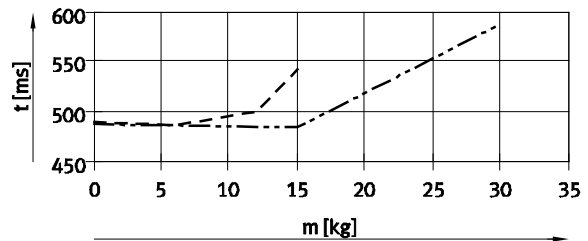

- DGSL-10
- DGSL-12
- DGSL-16
- DGSL-20
- DGSL-25

Vertical mounting position

The travel times for a vertical mounting position are calculated by multiplying the data for a horizontal mounting position by a correction factor k_a (advancing) and k_r (retracting), see adjacent table.

Given:
Stroke = 200 mm
Size = 20
Effective load = 10 kg
Ascertained travel time t_h (horizontal), see graph:
– Advancing = 405 ms
– Retracting = 490 ms
Calculated travel time t_v (vertical):
– Advancing: $t_v = t_h \times k_a$
 $t_v = 405 \text{ ms} \times 0.9 = 365 \text{ ms}$
– Retracting: $t_v = t_h \times k_r$
 $t_v = 490 \text{ ms} \times 1.5 = 735 \text{ ms}$

Stroke [mm]	Size	Advancing (k_a) ¹⁾	Retracting (k_r)
30	8, 10, 12	0.95	1.2
	16, 20, 25	0.9	1.5
50	8, 10, 12	0.9	1.5
	16, 20, 25	0.9	1.5
100	10, 12, 16, 20, 25	0.8	1.5
150	12, 16, 20, 25	0.9	1.5
200	20, 25	0.9	1.5

1) Downward.

Mini slides DGSL

Technical data

Dynamic characteristic load values

Torques are indicated with reference to the centre of the guide.
These values must not be exceeded during dynamic operation. Special attention must be paid to the cushioning phase.

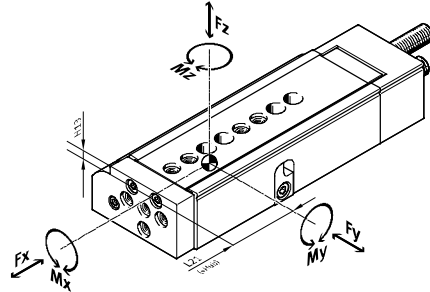

If the drive is simultaneously subjected to several of the indicated forces and torques, the following equation must be satisfied in addition to the indicated maximum loads:

$$\frac{|F_y|}{F_{y\max}} + \frac{|F_z|}{F_{z\max}} + \frac{|M_x|}{M_{x\max}} + \frac{|M_y|}{M_{y\max}} + \frac{|M_z|}{M_{z\max}} \leq 1$$

Position of the guide centre

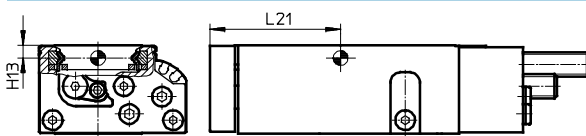

Calculation example

Given:

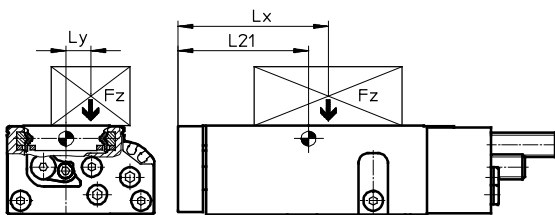

To be calculated:

Mini slide	= DGSL-10	F_y, F_z, M_x, M_y, M_z
Stroke length	= 80 mm	and
Lever arm L_x	= 50 mm	verification of operation
Lever arm L_y	= 30 mm	with combined load
Load F_z	= 0.8 kg	
Acceleration a	= 0 m/s ²	

Solution:

$L_{21} = 83$ mm from table

$F_y = 0$ N

$F_z = m \times g$
 $= 0.8 \text{ kg} \times 9.81 \text{ m/s}^2 = 7.848$ N

$M_x = m \times g \times L_y$
 $= 0.8 \text{ kg} \times 9.81 \text{ m/s}^2 \times 30 \text{ mm} = 0.236$ Nm

$M_y = m \times g \times [(L_{21} + \text{stroke}) - L_x]$
 $= 0.8 \text{ kg} \times 9.81 \text{ m/s}^2 \times [(83 \text{ mm} + 80 \text{ mm}) - 50 \text{ mm}] = 0.886$ Nm

$M_z = 0$ Nm

Combined load:

$$\frac{|F_y|}{F_{y\max}} + \frac{|F_z|}{F_{z\max}} + \frac{|M_x|}{M_{x\max}} + \frac{|M_y|}{M_{y\max}} + \frac{|M_z|}{M_{z\max}}$$

$$= 0 + \frac{7.848\text{N}}{1200\text{N}} + \frac{0.236\text{Nm}}{18\text{Nm}} + \frac{0.886\text{Nm}}{12\text{Nm}} + 0 = 0.094 \leq 1$$

Permissible forces and torques						Geometric characteristics	
Size	Stroke [mm]	$F_{y\max}$ [N]	$F_{z\max}$ [N]	$M_{x\max}$ [Nm]	$M_{y\max}, M_{z\max}$ [Nm]	H13 [mm]	L21 [mm]
4							
	10	343	343	2	2	2.7	31
	20	368	368	2	2		36
	30	387	387	2	2		42
6							
	10	540	540	6	4.5	3.4	37
	20	590	590	7	5		42
	30	631	631	8	5.5		47
	40	677	677	8	5.5		52
	50	719	719	8	5.5		57

Mini slides DGSL

Technical data



Permissible forces and torques						Geometric characteristics	
Size	Stroke [mm]	F _y max [N]	F _z max [N]	M _x max [Nm]	M _y max, M _z max [Nm]	H13 [mm]	L21 [mm]
8							
	10	657	657	7	5.5	3.25	41
	20	745	745	8	5.5		46
	30	850	850	9	5.5		51
	40	934	934	10	5.5		56
	50	962	962	10	8		67
	80	971	971	10	8		82
10							
	10	927	927	15	6	4.2	43
	20	1,003	1,003	15	7		46
	30	1,078	1,078	15	8		51
	40	1,152	1,152	15	9		56
	50	1,175	1,175	18	9		61
	80	1,200	1,200	18	12		83
	100	1,250	1,250	18	12		96
12							
	10	942	942	15	8	5.2	44
	20	1,006	1,006	15	9		49
	30	1,075	1,075	15	10		54
	40	1,142	1,142	18	11		59
	50	1,200	1,200	18	12		64
	80	1,280	1,280	20	15		88
	100	1,340	1,340	20	15		98
	150	1,400	1,400	20	15		124
16							
	10	1,769	1,769	35	20	6.4	54
	20	2,021	2,021	35	22		59
	30	2,274	2,274	35	22		64
	40	2,527	2,527	40	25		69
	50	2,780	2,780	40	25		74
	80	2,800	2,800	50	27		89
	100	2,850	2,850	50	43		113
	150	2,900	2,900	50	43		138
20							
	10	2,911	2,911	60	30	7.55	56
	20	3,143	3,143	60	30		61
	30	3,354	3,354	60	30		66
	40	3,612	3,612	60	40		71
	50	3,816	3,816	70	50		76
	80	4,032	4,032	80	50		91
	100	4,200	4,200	85	80		121
	150	4,400	4,400	90	80		152
	200	4,600	4,600	90	80		177
25							
	10	3,270	3,270	100	60	8.55	64
	20	3,744	3,744	100	60		69
	30	4,205	4,205	100	60		74
	40	4,643	4,643	110	60		79
	50	4,650	4,650	120	60		84
	80	4,700	4,700	130	80		112
	100	4,750	4,750	130	80		129
	150	4,800	4,800	130	80		154
	200	4,800	4,800	130	80		179

Mini slides DGSL

Technical data



Dimensions

Download CAD data → www.festo.com

Size 4 ... 10

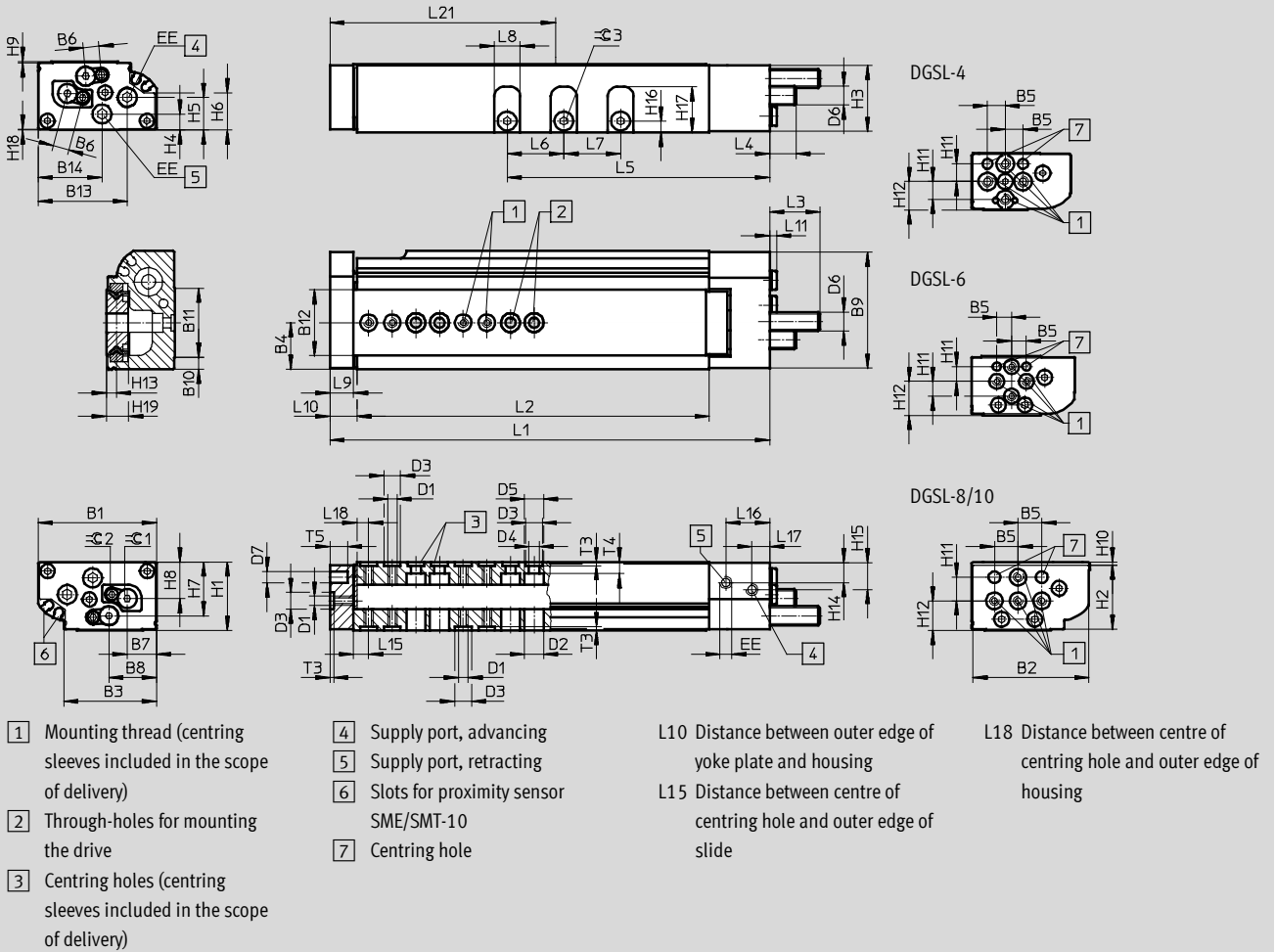

General dimensions

Size	B1	B2	B3	B4	B5	B6	B7	B8	B9	B10	B11	B12	B13	B14	D1
4	28	27.4	18.1	9.4	5	3.55	6.3	11.95	27.5	2	17.2	12.4	23.15	16.15	M3
6	35	34.5	26	13.5	5	5	8.2	13.5	34.5	3.5	19.9	20	28.1	18.9	M3
8	42	41.3	31.2	16.6	10	6	10.3	16.25	41.5	4.5	24	24.1	33	24.4	M4
10	50	49	39.2	19.65	10	6.8	12.35	20.1	49	5	29.2	28	37.7	27	M4

Size	D2 ∅	D3 ∅	D4 ∅	D5 ∅	D6	D7 ∅	EE	H1 ±0.08	H2	H3	H4	H5	H6	H7	H8
4	6.2	5 ^{H7}	3.3	6	M4x0.5	3 ^{H7}	M3	16	15.4	15.1	3.85	6.3	8.6	8.4	8.1
6	6.2	5 ^{H7}	3.3	6	M5x0.5	3 ^{H7}	M3	20	19	19.25	4.7	7.8	10.2	16	10.55
8	8	7 ^{H7}	4.3	8	M6x0.5	5 ^{H7}	M3	24	22.7	23	6.5	10.6	14	18.9	13.3
10	8	7 ^{H7}	4.3	8	M8x1	5 ^{H7}	M5	29	27.1	28	6.8	13.8	15.8	22.8	15.5

Size	H9	H10	H11	H12	H13	H14	H15	H16	H17	H18	H19	T3 +0.1	T4	T5	⊖ 2 ¹⁾	⊖ 3
4	0.65	0.3	5	8	2.7	5.35	5.85	3	10.6	0.25	5.3	1.3	2.3	4	1.3	2
6	0.5	0.5	5	11.5	3.4	6.5	7.2	3.7	13.1	0.27	6.5	1.3	3.3	6	1.5	2.5
8	0.6	0.9	10	8.7	3.25	7.8	10.5	4.1	16.8	0.35	6.6	1.6	3.8	7.5	2	2.5
10	0.6	1.4	10	12.5	4.2	8.75	11.75	4.8	19.25	0.4	9	1.6	5	7.5	2.5	3

1) With size 4, the scope of delivery of the drive includes an Allen key

Mini slides DGSL

Technical data

FESTO

Stroke-dependent dimensions															
Size	Stroke	L1	L2	L5	L6	L7	L8	L9	L10	L11	L15 ±0.05	L16	L17	L18 ±0.05	L21
4	10	72.1	48	36.35	–	–	6.5	5.5	6.6	2.5	4	13.25	4.25	3	31
	20	81.2	57.1	37.95	10										36
	30	91.2	67.1	47.95	11										42
6	10	81.1	54	33.1	–	–	8	8	9.6	2.5	5.1	13.25	4.25	3.5	37
	20	91.1	64	43.1	14										42
	30	101.1	74	53.1	14										47
	40	111.1	84	63.1	14										52
	50	121.1	94	73.1	14										57
8	10	90.2	59.6	34.6	–	–	8	10	11.6	2.5	7	14.65	4.35	5.5	41
	20	100.2	69.6	44.6	10										46
	30	110.2	79.6	54.6	16										51
	40	120.2	89.6	64.6	16										56
	50	142.2	111.6	74.6	16										67
	80	172.2	141.6	104.6	16										82
10	10	103.1	66	41.3	–	–	11	10	11.6	2.5	6.4	18.5	7	5	43
	20	112.8	75.7	51	24										46
	30	122.8	85.7	61	24										51
	40	132.8	95.7	71	24										56
	50	142.8	105.7	81	24										61
	80	186.2	149.1	111	24										83
	100	206.2	169.1	131	24										24

Cushioning-dependent dimensions					
Size	Cushioning	L3 max.	L4 max.	≈ 1	
				For adjusting the cushioning stroke	For adjusting the end position
4	P	15.2	7.8	–	1.3
	E	5.7	0	–	1.3
	P1	14	6	1.3	2.5
6	P	17.6	8.1	–	1.5
	E	6.6	0	–	1.5
	P1	15.5	5.8	1.5	3
8	P	21.1	10.7	–	2
	E	6.6	0	–	2
	P1	19	9.1	2	4
	Y3	24.3	23.9	–	2
10	P	22.8	12.5	–	2.5
	E	8.8	0	–	2.5
	P1	20.5	10.2	2.5	5
	Y3	25.5	14.9	–	2.5
	Y11	30.4	19.9	–	2

Mini slides DGSL

Technical data

FESTO

Hole pattern for mounting threads and centring holes

DGSL-4-10

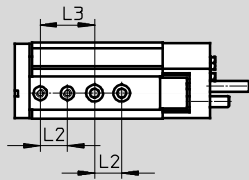

DGSL-4-20

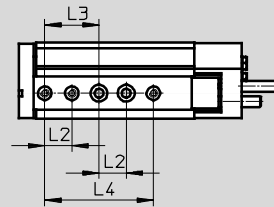

DGSL-4-30

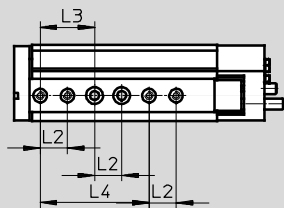

DGSL-6-10

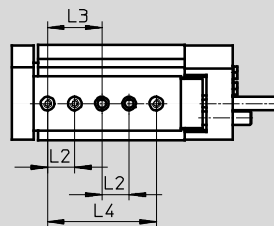

DGSL-6-20

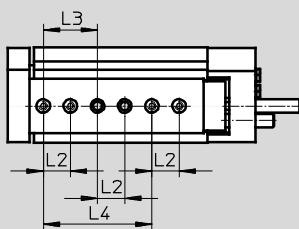

DGSL-6-30

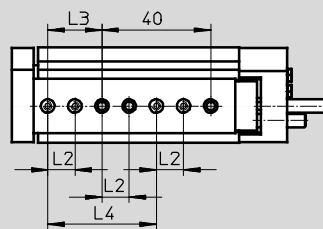

DGSL-6-40/50

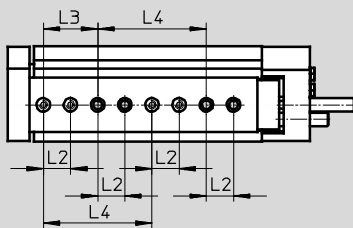

DGSL-8-10

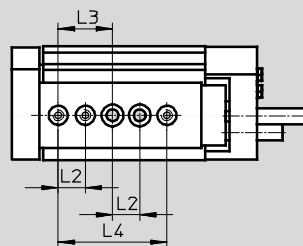

DGSL-8-20

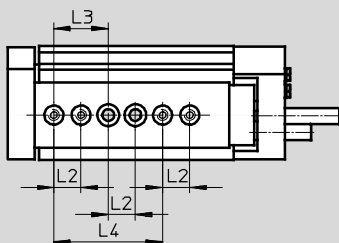

DGSL-8-30

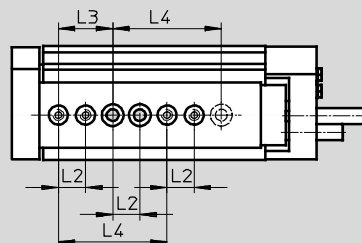

Mini slides DGSL

Technical data

Hole pattern for mounting threads and centring holes

DGSL-8-40

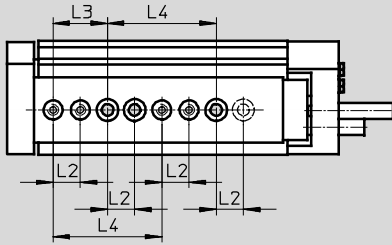

DGSL-8-50/80

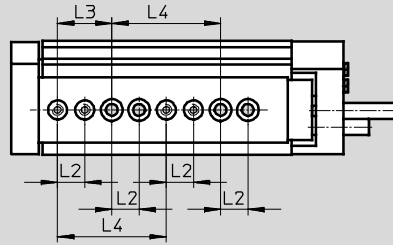

DGSL-10-10

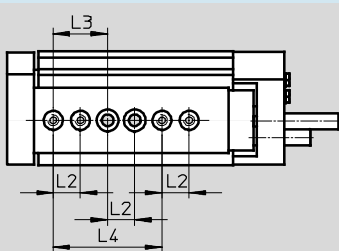

DGSL-10-20

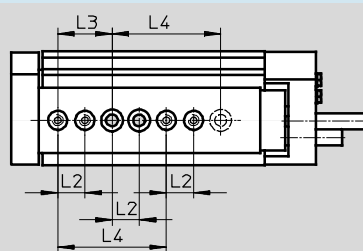

DGSL-10-30

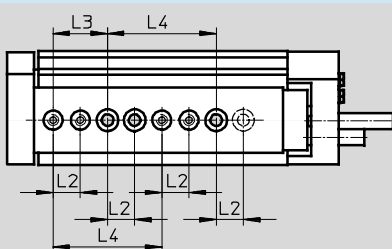

DGSL-10-40 ... 100

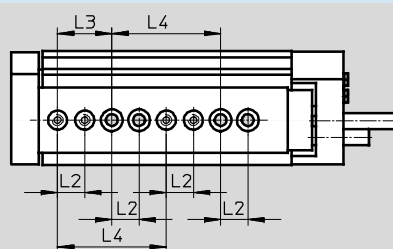

Distances from yoke plate to mounting threads and centring holes

DGSL-4 ... 10

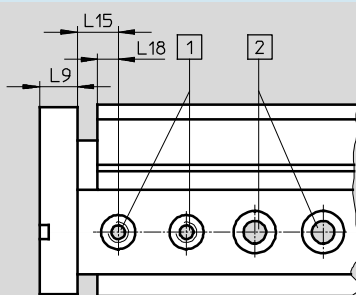

- 1 Centring holes with thread
- 2 Through-holes for mounting the drive

Size	L2 ¹⁾	L3 ¹⁾	L4 ¹⁾	L9	L15 ±0.05	L18
4	10	20	40	5.5	4	3
6	10	20	40	8	5.1	3.5
8	10	20	40	10	7	5.5
10	10	20	40	10	6.4	5

1) Tolerance for centring hole ±0,02
Tolerance for through-hole ±0,1

Mini slides DGSL

Technical data

FESTO

Dimensions

Download CAD data → www.festo.com

Size 12/16

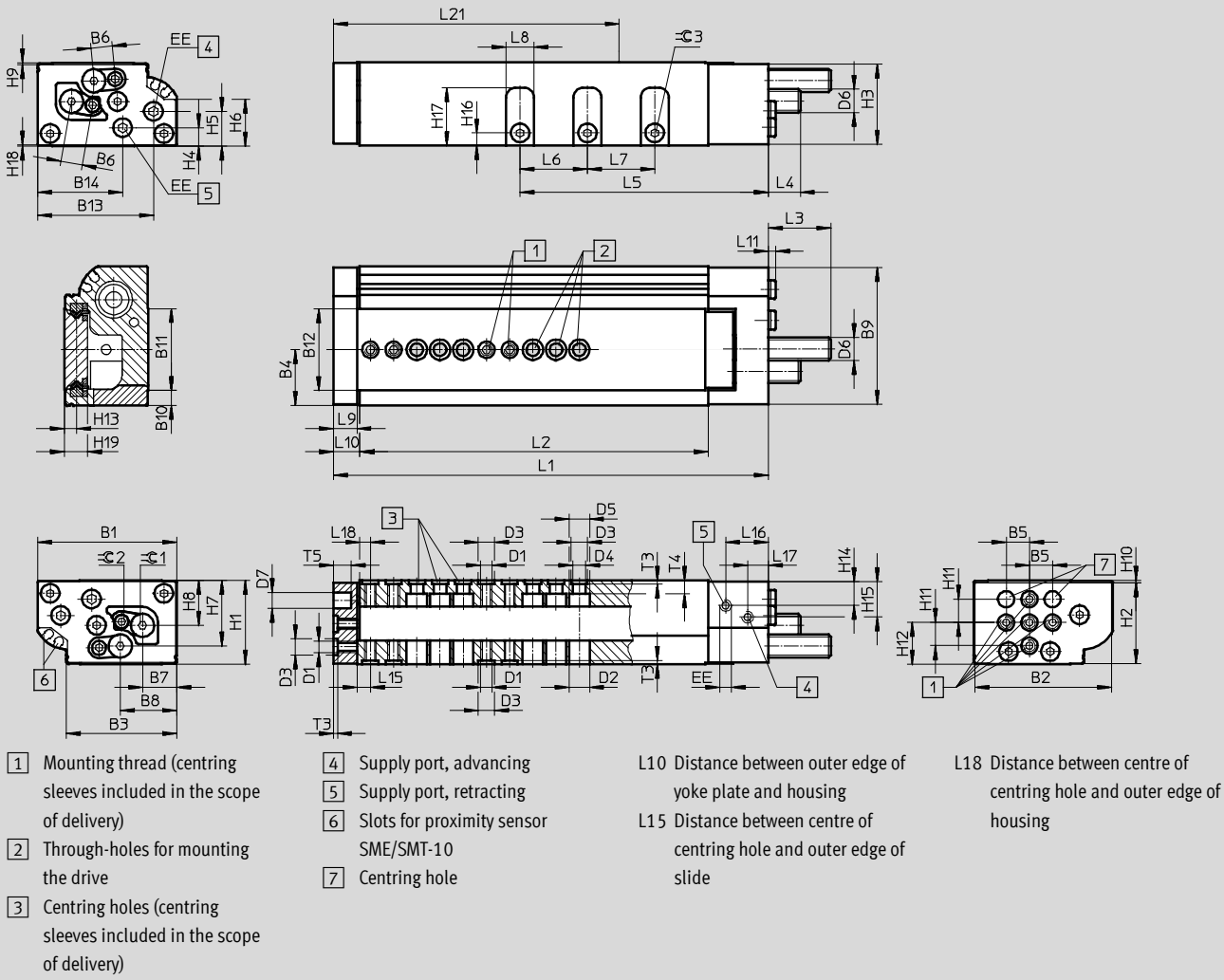

General dimensions

Size	B1	B2	B3	B4	B5	B6	B7	B8	B9	B10	B11	B12	B13	B14	D1
12	60	59	47.6	24	10	9.2	14.7	24.3	59	6.4	35.35	35.2	50	36.7	M5
16	66	65	53.5	26.7	10	11.1	16.7	27.5	65	7.75	37.9	38	50.4	36.7	M5

Size	D2	D3	D4	D5	D6	D7	EE	H1	H2	H3	H4	H5	H6	H7	H8
	∅	∅	∅	∅		∅		±0.08							
12	8.8	7 ^{H7}	5.5	8.8	M10x1	8 ^{H7}	M5	36	34.8	34.7	8	15.1	20.35	28.2	19.3
16	8.8	7 ^{H7}	5.5	9.2	M12x1	8 ^{H7}	M5	40	38	39	8.5	16.7	20.6	31.7	20.8

Size	H9	H10	H11	H12	H13	H14	H15	H16	H17	H18	H19	T3	T4	T5	∅ 2	∅ 3
												+0.1				
12	0.8	0.95	10	17.9	5.2	10.75	15.75	5.5	24.9	0.5	10	1.6	5.6	7.5	3	3
16	0.5	1.5	10	20	6.4	10.5	16.7	7	26.6	0.5	12.4	1.6	6.1	9	4	4

Mini slides DGSL

Technical data

FESTO

Stroke-dependent dimensions															
Size	Stroke	L1	L2	L5	L6	L7	L8	L9	L10	L11	L15 ±0.05	L16	L17	L18 ±0.05	L21
12	10	106.2	68.6	42.4	-	-	12	10	11.6	2.5	5.8	18.5	7.5	4.5	44
	20	116.2	78.6	52.4											49
	30	126.2	88.6	62.4											54
	40	136.2	98.6	72.4											59
	50	146.2	108.6	82.4											64
	80	197.6	160	112.4	29	29	88								
	100	217.6	180	132.4			98								
	150	267.6	230	182.4			124								
16	10	124.1	82.5	45	-	-	14	12	13.6	2.5	6.8	21	7	5.5	54
	20	134.6	93	54.6											59
	30	144.6	103	64.6											64
	40	154.6	113	74.6											69
	50	164.6	123	84.6											74
	80	194.6	153	114.6	35	35	89								
	100	243.6	202	134.6			113								
	150	293.6	252	184.6			138								

Cushioning-dependent dimensions					
Size	Cushioning	L3 max.	L4 max.	≈ 1	
				For adjusting the cushioning stroke	For adjusting the end position
12	P	28.1	14.9	-	3
	E	8.8	0	-	3
	P1	26	12.8	3	6
	Y3	36.9	23.7	-	3
	Y11	42.2	18.7	-	2.5
16	P	42.3	26.1	-	4
	E	8.8	0	-	4
	P1	40	23.8	4	8
	Y3	51.9	35.7	-	4
	Y11	55.4	38.9	-	3

Mini slides DGSL

Technical data

FESTO

Hole pattern for mounting threads and centring holes

DGSL-12-10

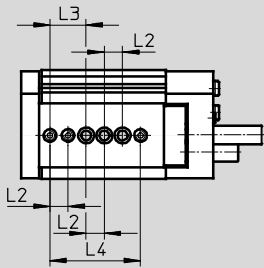

DGSL-12-20

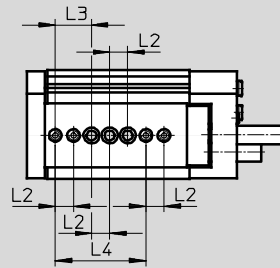

DGSL-12-30

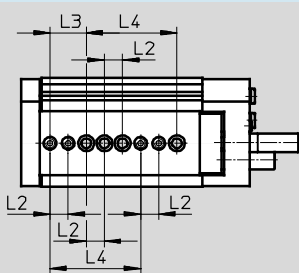

DGSL-12-40

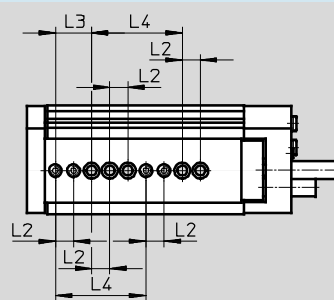

DGSL-12-50 ... 100

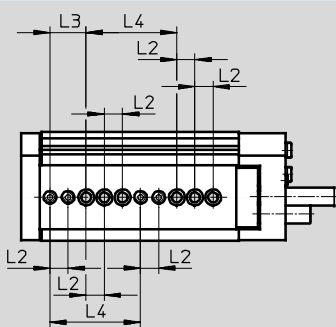

DGSL-12-150

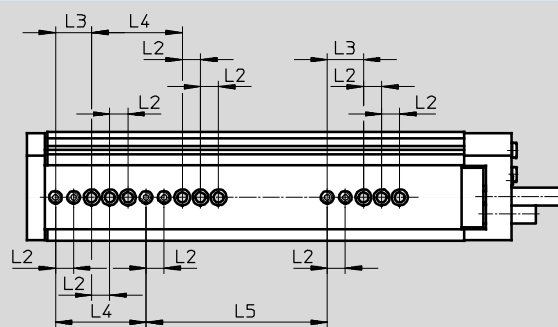

DGSL-16-10

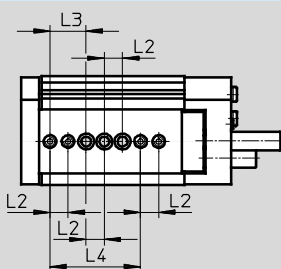

DGSL-16-20

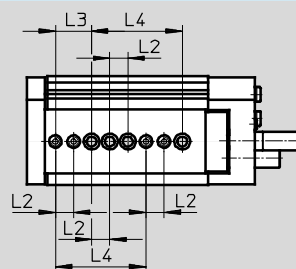

Mini slides DGSL

Technical data

Hole pattern for mounting threads and centring holes

DGSL-16-30

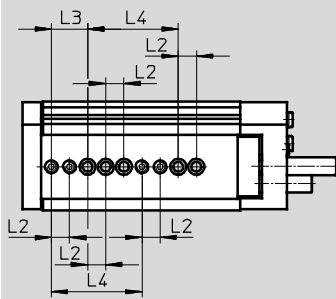

DGSL-16-40 ... 100

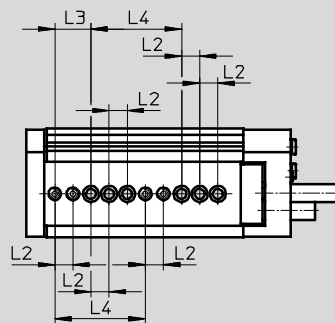

DGSL-16-150

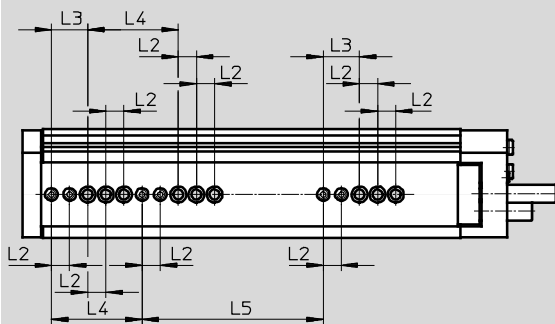

Distances from yoke plate to mounting threads and centring holes

DGSL-12/16

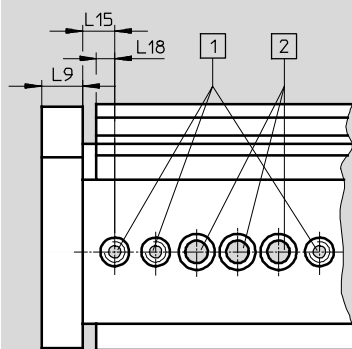

- 1 Centring holes with thread
- 2 Through-holes for mounting the drive

Size	L2 ¹⁾	L3 ¹⁾	L4 ¹⁾	L5 ±0.03	L9	L15 ±0.05	L18
12	10	20	50	100	10	5.8	4.5
16	10	20	50	100	12	6.8	5.5

1) Tolerance for centring hole ±0,02
Tolerance for through-hole ±0,1

Mini slides DGSL

Technical data

FESTO

Dimensions

Download CAD data → www.festo.com

Size 20/25

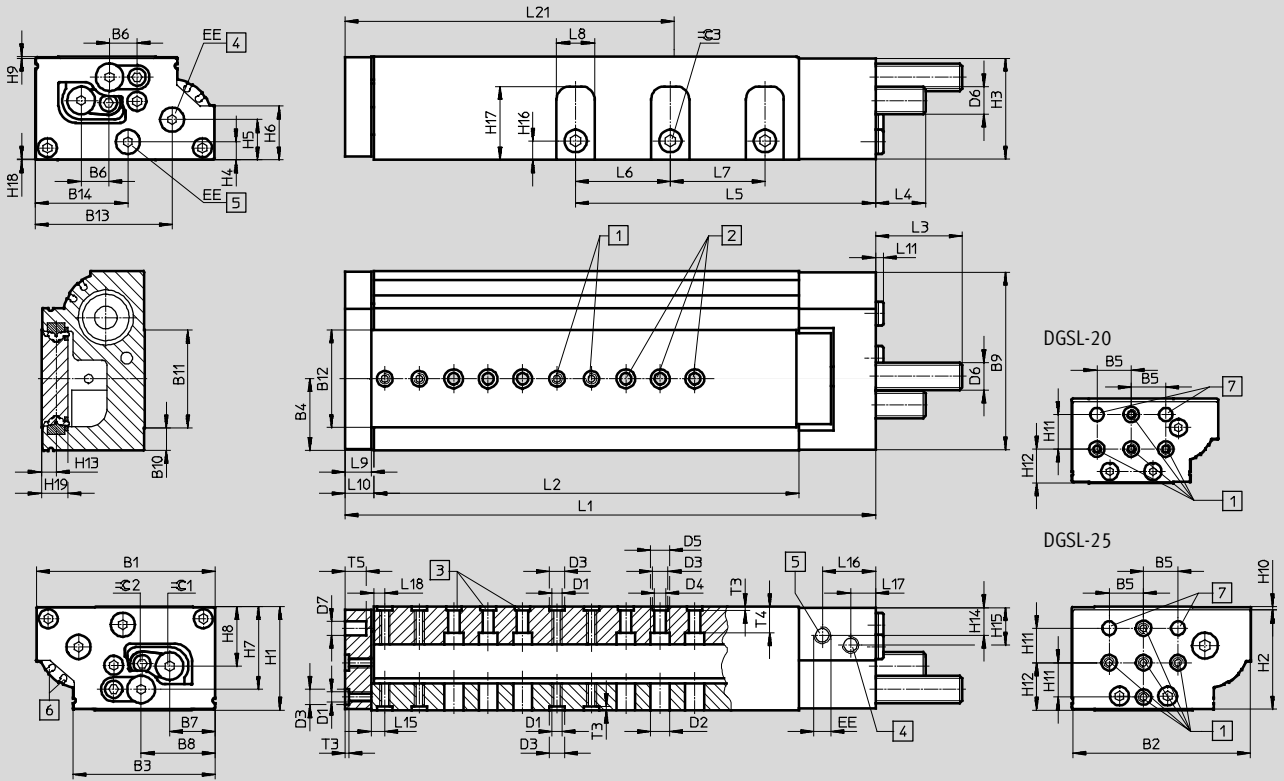

- 1 Mounting thread (centring sleeves included in the scope of delivery)
- 2 Through-holes for mounting the drive
- 3 Centring holes (centring sleeves included in the scope of delivery)
- 4 Supply port, advancing
- 5 Supply port, retracting
- 6 Slots for proximity sensor SME/SMT-10
- 7 Centring hole
- L10 Distance between outer edge of yoke plate and housing
- L15 Distance between centre of centring hole and outer edge of slide
- L18 Distance between centre of centring hole and outer edge of housing

General dimensions

Size	B1	B2	B3	B4	B5	B6	B7	B8	B9	B10	B11	B12	B13	B14	D1
20	85	84	68.85	34.5	20	14	21.4	36.35	83.4	10	48.9	49.2	64.1	48.6	M6
25	104	103	82.6	41.6	20	16.2	26.4	43.1	103	13.25	56.5	56.7	79.4	53.7	M6

Size	D2	D3	D4	D5	D6	D7	EE	H1	H2	H3	H4	H5	H6	H7	H8
	∅	∅	∅	∅		∅		±0.08							
20	11	9 ^{H7}	6.6	11	M14x1	8 ^{H7}	G ¹ / ₈	49	46.5	47.7	10.3	20.6	23.2	38.2	26.1
25	11	9 ^{H7}	6.6	11	M16x1	8 ^{H7}	G ¹ / ₈	60	57.5	58.5	10.5	23.4	31.2	48	34.5

Size	H9	H10	H11	H12	H13	H14	H15	H16	H17	H18	H19	T3	T4	T5	∠ 2	∠ 3
												+0.1				
20	0.5	2	20	19.6	7.55	14.7	14.7	10	33.3	0.8	14.5	2.1	8.8	10	4	5
25	1	2	20	27.5	8.55	16.6	22.2	11	42.7	0.5	15.5	2.1	15.1	12	5	6

Mini slides DGSL

Technical data



Stroke-dependent dimensions															
Size	Stroke	L1	L2	L5	L6	L7	L8	L9	L10	L11	L15 ±0.05	L16	L17	L18 ±0.05	L21
20	10	141.2	84.6	59.1	-	-	17	14	15.6	4.6	7.8	29.3	10.5	6.5	56
	20	151.2	94.6	69.1											61
	30	161.2	104.6	79.1											66
	40	171.2	114.6	89.1											71
	50	183.2	126.6	99.1											76
	80	211.2	154.6	129.1											91
	100	270.2	213.6	149.1	44	44	121								
	150	333.2	276.6	199.1			152								
	200	383.2	326.6	252.1			177								
25	10	157.1	96	63.7	-	-	22	15	16.6	4.6	8	30.9	12.2	6.5	64
	20	167.1	106	72.2											69
	30	177.1	116	82.2											74
	40	187.1	126	92.2											79
	50	197.1	136	102.2											84
	80	253.1	192	132.2											55
	100	286.1	225	152.2	129										
	150	338.1	277	202.2	154										
	200	388.1	327	254.2	179										

Cushioning-dependent dimensions					
Size	Cushioning	L3 max.	L4 max.	≈ 1	
				For adjusting the cushioning stroke	For adjusting the end position
20	P	52.4	31.2	-	4
	E	8.8	0	-	4
	P1	50.1	28.9	4	8
	Y3	55.5	34.3	-	4
	Y11	67.4	45.9	-	4
25	P	51.9	30.5	-	5
	E	8.8	0	-	5
	P1	49.6	28.2	5	10
	Y3	65.2	43.8	-	5
	Y11	78.4	56.9	-	4

Mini slides DGSL

Technical data

Hole pattern for mounting threads and centring holes

DGSL-20-10/20

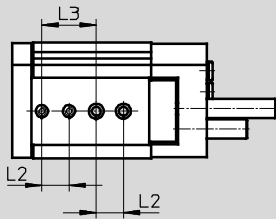

DGSL-20-30/40

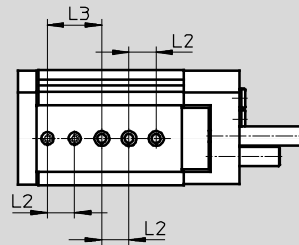

DGSL-20-50

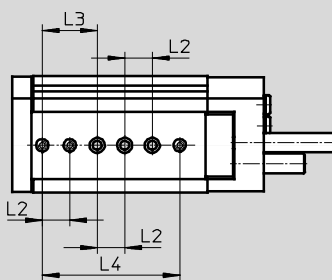

DGSL-20-80

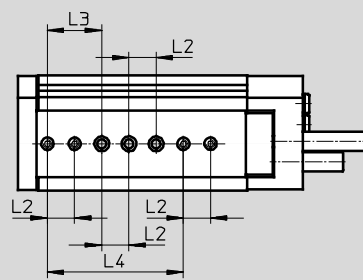

DGSL-20-100 ... 200

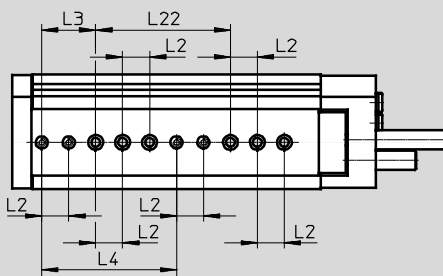

DGSL-25-10

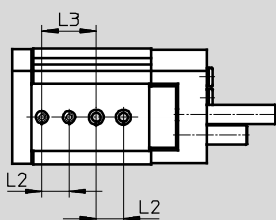

DGSL-25-20

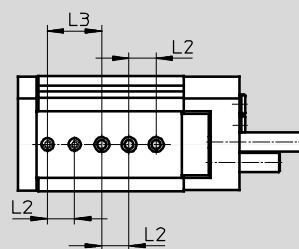

Mini slides DGSL

Technical data

Hole pattern for mounting threads and centring holes

DGSL-25-30/40

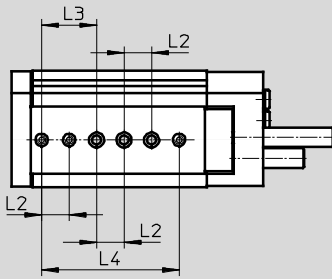

DGSL-25-50

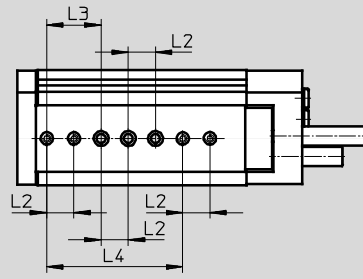

DGSL-25-80

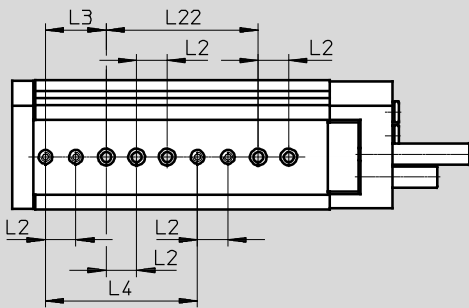

DGSL-25-100 ... 200

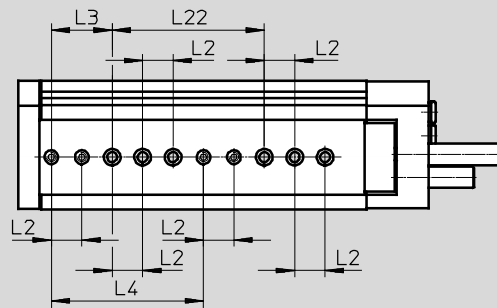

Distances from yoke plate to mounting threads and centring holes

DGSL-20/25

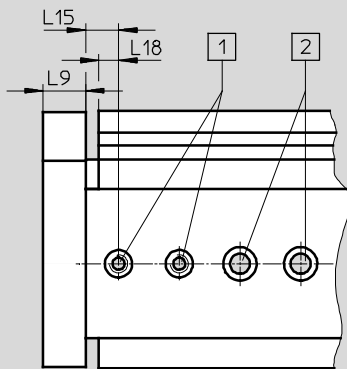

- 1 Centring holes with thread
- 2 Through-holes for mounting the drive

Size	L2 ¹⁾	L3 ¹⁾	L4	L9	L15 ±0.05	L18	L22
20	20	40	100 ¹⁾	14	7.8	6.5	100±0.03
25	20	40	100±0.03	15	8	6.5	100 ¹⁾

1) Tolerance for centring hole ±0,02
Tolerance for through-hole ±0,1

Mini slides DGSL-C/-E3

Technical data

FESTO

Function

C – Clamping unit

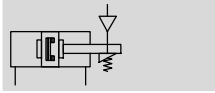

E3 – End-position locking

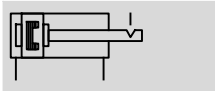

Size
6 ... 25

Wearing parts kits
→ 45



Note

Additional measures are required for use in safety-related applications; in Europe, for example, the standards listed under the EC Machinery Directive must be observed.

Without additional measures in accordance with statutory minimum requirements, the product is not suitable for use in safety-related sections of control systems.

General technical data – Clamping unit								
Size		6	8	10	12	16	20	25
Function		<ul style="list-style-type: none"> – Mechanical clamping – For fixing the slide in any position – Frictional locking 						
Clamping type with effective direction		At both ends						
		Clamping via spring force, released via air pressure						
Pneumatic connection		M5						
Mounting position		Any						
Static holding force	[N]	80	80	180	180	350	350	600
Product weight	[g]	10	10	15	15	50	50	50

Operating and environmental conditions – Clamping unit	
Operating medium	Compressed air in accordance with ISO 8573-1:2010 [7:4:4]
Note on operating/pilot medium	Operation with lubricated medium possible (in which case lubricated operation will always be required)
Min. release pressure	[bar] 3
Max. operating pressure	[bar] ≤ 10

General technical data – End-position locking								
Size		6	8	10	12	16	20	25
Function		<ul style="list-style-type: none"> – Mechanical locking when the end position is reached – For fixing the slide in the unpressurised, retracted state – Positive locking 						
Clamping type with effective direction		At both ends						
		Clamping via spring force, air pressure to unlock						
Pneumatic connection		M5						
Mounting position		Any						
Static holding force	[N]	60	60	160	160	250	380	640
Product weight	[g]	13	13	26	26	64	64	65

Operating and environmental conditions – End-position locking	
Operating medium	Compressed air in accordance with ISO 8573-1:2010 [7:4:4]
Note on operating/pilot medium	Operation with lubricated medium possible (in which case lubricated operation will always be required)
Operating pressure	[bar] 3 ... 8

Mini slides DGSL-C/-E3

Technical data

Adjustable end-position range

When using end-position locking (E3), the adjustable range of the retracted end position is reduced by the following values.

1 Adjustable end-position range

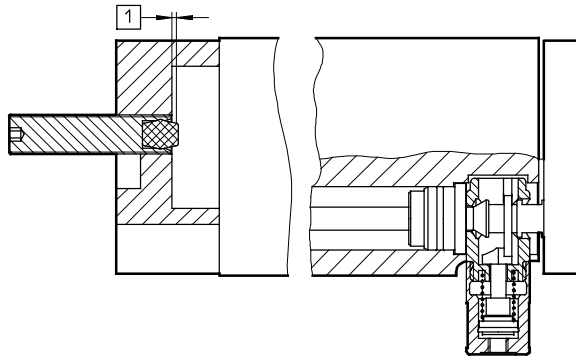

Size	1
6, 8	max. 1.5 mm
10, 12	max. 2.3 mm
16, 20, 25	max. 2.7 mm

Dimensions

Download CAD data → www.festo.com

C – Clamping unit/E3 – End-position locking

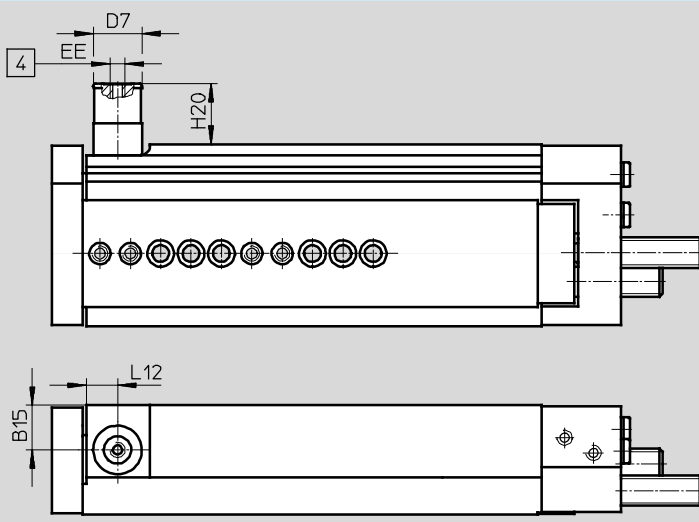

4 Supply port

Size	B15	D7 ∅	EE	H20		L12
				C	E3	
6	7.2	12	M5	10.7	21.2	7.3
8	9.9	12		10.5	21	7.3
10	11.2	16		11.8	21.2	10.5
12	14.8	16		10.5	19.9	10.3
16	14	20		27.5	30.5	13
20	17	20		21.3	24.3	14
25	22.55	20		17.75	20.65	14

Mini slides DGSL

Technical data

Ordering data				Ordering data									
Size	Stroke [mm]	Part No.	Type	Size	Stroke [mm]	Part No.	Type						
With cushioning P				With cushioning E									
4	10	543910	DGSL-4-10-PA	4	10	570158	DGSL-4-10-EA						
	20	543911	DGSL-4-20-PA		4	20	570159	DGSL-4-20-EA					
	30	543912	DGSL-4-30-PA			4	30	570160	DGSL-4-30-EA				
6	10	543916	DGSL-6-10-PA	6			10	570161	DGSL-6-10-EA				
	20	543917	DGSL-6-20-PA		6		20	570162	DGSL-6-20-EA				
	30	543918	DGSL-6-30-PA			6	30	570163	DGSL-6-30-EA				
	40	543919	DGSL-6-40-PA				6	40	570164	DGSL-6-40-EA			
	50	543920	DGSL-6-50-PA					6	50	570165	DGSL-6-50-EA		
8	10	543926	DGSL-8-10-PA	8					10	570166	DGSL-8-10-EA		
	20	543927	DGSL-8-20-PA		8				20	570167	DGSL-8-20-EA		
	30	543928	DGSL-8-30-PA			8			30	570168	DGSL-8-30-EA		
	40	543929	DGSL-8-40-PA				8		40	570169	DGSL-8-40-EA		
	50	543930	DGSL-8-50-PA					8	50	570170	DGSL-8-50-EA		
	80	543931	DGSL-8-80-PA						8	80	570171	DGSL-8-80-EA	
10	10	543942	DGSL-10-10-PA	10						10	570172	DGSL-10-10-EA	
	20	543943	DGSL-10-20-PA		10					20	570173	DGSL-10-20-EA	
	30	543944	DGSL-10-30-PA			10				30	570174	DGSL-10-30-EA	
	40	543945	DGSL-10-40-PA				10			40	570175	DGSL-10-40-EA	
	50	543946	DGSL-10-50-PA					10		50	570176	DGSL-10-50-EA	
	80	543947	DGSL-10-80-PA						10	80	570177	DGSL-10-80-EA	
	100	543948	DGSL-10-100-PA							10	100	570178	DGSL-10-100-EA
12	10	543961	DGSL-12-10-PA	12							10	570179	DGSL-12-10-EA
	20	543962	DGSL-12-20-PA		12						20	570180	DGSL-12-20-EA
	30	543963	DGSL-12-30-PA			12					30	570181	DGSL-12-30-EA
	40	543964	DGSL-12-40-PA				12				40	570182	DGSL-12-40-EA
	50	543965	DGSL-12-50-PA					12			50	570183	DGSL-12-50-EA
	80	543966	DGSL-12-80-PA						12		80	570184	DGSL-12-80-EA
	100	543967	DGSL-12-100-PA							12	100	570185	DGSL-12-100-EA
150	543968	DGSL-12-150-PA	12	150							570186	DGSL-12-150-EA	
16	10	543983		DGSL-16-10-PA	16						10	570187	DGSL-16-10-EA
	20	543984		DGSL-16-20-PA		16					20	570188	DGSL-16-20-EA
	30	543985		DGSL-16-30-PA			16				30	570189	DGSL-16-30-EA
	40	543986		DGSL-16-40-PA				16			40	570190	DGSL-16-40-EA
	50	543987		DGSL-16-50-PA					16		50	570191	DGSL-16-50-EA
	80	543988		DGSL-16-80-PA						16	80	570192	DGSL-16-80-EA
	100	543989	DGSL-16-100-PA	16							100	570193	DGSL-16-100-EA
150	543990	DGSL-16-150-PA	16		150						570194	DGSL-16-150-EA	
20	10	544005			DGSL-20-10-PA	20					10	570195	DGSL-20-10-EA
	20	544006			DGSL-20-20-PA		20				20	570196	DGSL-20-20-EA
	30	544007			DGSL-20-30-PA			20			30	570197	DGSL-20-30-EA
	40	544008			DGSL-20-40-PA				20		40	570198	DGSL-20-40-EA
	50	544009			DGSL-20-50-PA					20	50	570199	DGSL-20-50-EA
	80	544010		DGSL-20-80-PA	20						80	570200	DGSL-20-80-EA
	100	544011	DGSL-20-100-PA	20							100	570201	DGSL-20-100-EA
	150	544012	DGSL-20-150-PA								20	150	570202
200	544013	DGSL-20-200-PA	20			200						570203	DGSL-20-200-EA
25	10	544030				DGSL-25-10-PA	25					10	570204
	20	544031				DGSL-25-20-PA		25				20	570205
	30	544032				DGSL-25-30-PA			25			30	570206
	40	544033				DGSL-25-40-PA				25		40	570207
	50	544034			DGSL-25-50-PA	25						50	570208
	80	544035		DGSL-25-80-PA	25							80	570209
	100	544036		DGSL-25-100-PA							25	100	570210
	150	544037	DGSL-25-150-PA	25								150	570211
200	544038	DGSL-25-200-PA	25				200					570212	DGSL-25-200-EA

Mini slides DGSL

Technical data

FESTO

Ordering data				Ordering data				
Size	Stroke [mm]	Part No.	Type	Size	Stroke [mm]	Part No.	Type	
With cushioning P1				With cushioning Y3				
4	10	543913	DGSL-4-10-P1A	4	10	-		
	20	543914	DGSL-4-20-P1A		6	20	-	
	30	543915	DGSL-4-30-P1A			6	30	-
6	10	543921	DGSL-6-10-P1A	10			-	
	20	543922	DGSL-6-20-P1A	20	-			
	30	543923	DGSL-6-30-P1A	30	-			
	40	543924	DGSL-6-40-P1A	40	-			
6	50	543925	DGSL-6-50-P1A	50	-			
	8	10	543932	DGSL-8-10-P1A	8	10	-	
		20	543933	DGSL-8-20-P1A		20	-	
		30	543934	DGSL-8-30-P1A		30	543938	DGSL-8-30-Y3A
		40	543935	DGSL-8-40-P1A		40	543939	DGSL-8-40-Y3A
50		543936	DGSL-8-50-P1A	50		543940	DGSL-8-50-Y3A	
8	80	543937	DGSL-8-80-P1A	80	543941	DGSL-8-80-Y3A		
	10	10	543949	DGSL-10-10-P1A	10	10	-	
		20	543950	DGSL-10-20-P1A		20	-	
30		543951	DGSL-10-30-P1A	30		543956	DGSL-10-30-Y3A	
40		543952	DGSL-10-40-P1A	40		543957	DGSL-10-40-Y3A	
50		543953	DGSL-10-50-P1A	50		543958	DGSL-10-50-Y3A	
80		543954	DGSL-10-80-P1A	80		543959	DGSL-10-80-Y3A	
100		543955	DGSL-10-100-P1A	100		543960	DGSL-10-100-Y3A	
12	10	543969	DGSL-12-10-P1A	12	10	-		
	20	543970	DGSL-12-20-P1A		20	-		
	30	543971	DGSL-12-30-P1A		30	543977	DGSL-12-30-Y3A	
	40	543972	DGSL-12-40-P1A		40	543978	DGSL-12-40-Y3A	
	50	543973	DGSL-12-50-P1A		50	543979	DGSL-12-50-Y3A	
	80	543974	DGSL-12-80-P1A		80	543980	DGSL-12-80-Y3A	
	100	543975	DGSL-12-100-P1A		100	543981	DGSL-12-100-Y3A	
12	150	543976	DGSL-12-150-P1A	150	543982	DGSL-12-150-Y3A		
	16	10	543991	DGSL-16-10-P1A	16	10	-	
		20	543992	DGSL-16-20-P1A		20	-	
		30	543993	DGSL-16-30-P1A		30	543999	DGSL-16-30-Y3A
		40	543994	DGSL-16-40-P1A		40	544000	DGSL-16-40-Y3A
50		543995	DGSL-16-50-P1A	50		544001	DGSL-16-50-Y3A	
80		543996	DGSL-16-80-P1A	80		544002	DGSL-16-80-Y3A	
100		543997	DGSL-16-100-P1A	100		544003	DGSL-16-100-Y3A	
16	150	543998	DGSL-16-150-P1A	150	544004	DGSL-16-150-Y3A		
	20	10	544014	DGSL-20-10-P1A	20	10	-	
		20	544015	DGSL-20-20-P1A		20	-	
		30	544016	DGSL-20-30-P1A		30	544023	DGSL-20-30-Y3A
		40	544017	DGSL-20-40-P1A		40	544024	DGSL-20-40-Y3A
50		544018	DGSL-20-50-P1A	50		544025	DGSL-20-50-Y3A	
80		544019	DGSL-20-80-P1A	80		544026	DGSL-20-80-Y3A	
100		544020	DGSL-20-100-P1A	100		544027	DGSL-20-100-Y3A	
150		544021	DGSL-20-150-P1A	150		544028	DGSL-20-150-Y3A	
20	200	544022	DGSL-20-200-P1A	200	544029	DGSL-20-200-Y3A		
	25	10	544039	DGSL-25-10-P1A	25	10	-	
20		544040	DGSL-25-20-P1A	20		-		
30		544041	DGSL-25-30-P1A	30		544048	DGSL-25-30-Y3A	
40		544042	DGSL-25-40-P1A	40		544049	DGSL-25-40-Y3A	
50		544043	DGSL-25-50-P1A	50		544050	DGSL-25-50-Y3A	
80		544044	DGSL-25-80-P1A	80		544051	DGSL-25-80-Y3A	
100		544045	DGSL-25-100-P1A	100		544052	DGSL-25-100-Y3A	
150		544046	DGSL-25-150-P1A	150		544053	DGSL-25-150-Y3A	
200	544047	DGSL-25-200-P1A	200	544054	DGSL-25-200-Y3A			

Ordering data for modular products → 44

Mini slides DGSL

Ordering data – Modular products

M Mandatory data				O Options		M	
Module No.	Function	Size	Stroke	Clamping unit	End-position locking	Cushioning	Position sensing
543902	DGSL	4	10 ... 200	C	E3	P	A
543903		6				P1	
543904		8				Y3	
543905		10				E	
543906		12				Y11	
543907		16				N	
543908		20					
543909		25					
Ordering example							
543904	DGSL	- 8	- 30		E3	- Y3	A

Ordering table												
Size	4	6	8	10	12	16	20	25	Condi-tions	Code	Enter code	
M Module No.	543902	543903	543904	543905	543906	543907	543908	543909				
Function	Mini slide with recirculating ball bearing guide									DGSL	DGSL	
										-	-	
Size	4	6	8	10	12	16	20	25		...		
										-	-	
Stroke [mm]	10									10		
	20									20		
	30									30		
	-	40								40		
	-	50								50		
	-	-	80							80		
	-	-	-	100						100		
	-	-	-	-	150					150		
	-	-	-	-	-	-	200			200		
O										-	-	
Clamping unit	-	Attached								C		
End-position locking	-	With piston rod in retracted position							1	E3		
M										-	-	
Cushioning	Elastic cushioning rings/pads at both ends, end positions adjustable									P		
	Elastic cushioning rings/pads at both ends, end positions adjustable, with fixed stop									P1		
	Progressive shock absorber at both ends							2	Y3			
	Elastic cushioning rings/pads at both ends, end positions adjustable, short design									E		
	Progressive shock absorber with reducing sleeve, both ends							2	Y11			
	Without cushioning							2	N			
Position sensing	Via proximity sensor									A	A	

 - Note
Operation without cushioning components is not permitted.

- 1 E3 Not with clamping unit C
- 2 Y3, Y11, N Minimum stroke 30 mm

Transfer order code

	DGSL	-		-		-		-		A
--	------	---	--	---	--	---	--	---	--	---

Mini slides DGSL

Wearing parts kits and accessories



Ordering data – Wearing parts kits					
Size	Part No.	Type	Size	Part No.	Type
4	713743	DGSL-4-...	12	713747	DGSL-12-...
6	713744	DGSL-6-...	16	713748	DGSL-16-...
8	713745	DGSL-8-...	20	713749	DGSL-20-...
10	713746	DGSL-10-...	25	713750	DGSL-25-...

Cover DADS

Materials:
Anodised aluminium
Free of copper, PTFE and silicone
RoHS-compliant

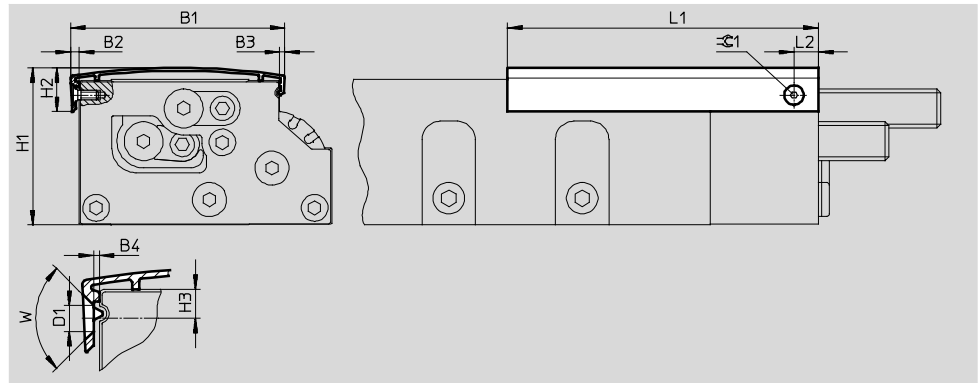

Dimensions and ordering data																
For size	Length [mm]	B1	B2	B3	B4	D1	H1	H2	H3	L1	L2	W	$\varnothing C1$	Weight [g]	Part No.	Type
4	30	22	1.9	-	0.4	2.8	17.9	7.5	2	40	4.5	90°	-	2	1086663	DADS-AB-G6-4-30
	500									27				1212468	DADS-AB-G6-4-500	
6	50	31.2	1.4	-	0	2.8	22	8.2	2.5	63	6	90°	-	4	1066625	DADS-AB-G6-6-50
	500									33				1212476	DADS-AB-G6-6-500	
8	80	36.3	1.9	-	0.3	2.8	26.5	8.2	2	93	7	90°	-	8	1087413	DADS-AB-G6-8-80
	500									42				1212478	DADS-AB-G6-8-500	
10	50	43.6	2.8	2.2	1.2	3.4	32	12	3.4	70	10	90°	2	11	1162400	DADS-AB-G6-10-50
	100									18				1090689	DADS-AB-G6-10-100	
	500									75				1212479	DADS-AB-G6-10-500	
12	50	51.7	2.7	2	0.5	3.4	38.8	12.8	4.25	72	10	90°	2	12	1162406	DADS-AB-G6-12-50
	150									28				1090732	DADS-AB-G6-12-150	
	500									82				1212480	DADS-AB-G6-12-500	
16	50	60	4.3	3.1	2.25	3.4	43.7	15.2	5	73	10	90°	2	21	1162410	DADS-AB-G6-16-50
	150									49				1066591	DADS-AB-G6-16-150	
	500									141				1212503	DADS-AB-G6-16-500	
20	50	74.8	3.6	2.8	1.2	4.4	53.2	18.9	6.5	74	10	90°	2.5	28	1162412	DADS-AB-G6-20-50
	100									46				1162415	DADS-AB-G6-20-100	
	200									83				1090823	DADS-AB-G6-20-200	
	500									184				1212521	DADS-AB-G6-20-500	
	50									34				1162417	DADS-AB-G6-25-50	
25	100	88.4	3.5	2.7	0.7	4.4	64.7	18.3	6	78	10	90°	2.5	55	1162419	DADS-AB-G6-25-100
	200									98				1090895	DADS-AB-G6-25-200	
	500									213				1212523	DADS-AB-G6-25-500	

- - Note







With the 500 mm covers, the mounting hole must be made by the customer.

The cover can be trimmed as required by the customer.

Mini slides DGSL

Accessories

FESTO



Ordering data						
	For size	Brief description	Order code	Part No.	Type	PU ¹⁾
Centring sleeve ZBH Technical data → Internet: zbh						
	4, 6	For centring loads and attachments (the scope of delivery of the mini slide includes six centring sleeves)	-	189652	ZBH-5	10
	8, 10, 12, 16			186717	ZBH-7	
	20, 25			150927	ZBH-9	
Connector sleeve ZBV Technical data → Internet: zbv						
	8, 10	<ul style="list-style-type: none"> For connecting two mini slides DGSL Sizing information refers to the y axis 	-	548802	ZBV-M4-7	3
	12, 16			548803	ZBV-M5-7	
	20, 25			548804	ZBV-M6-9	
Shock absorber DYEF-...-Y1 Technical data → Internet: dyef						
	4	Elastic cushioning, without metal stop	P	1179810	DYEF-M4-Y1	1
	6			1179818	DYEF-M5-Y1	
	8			1179831	DYEF-M6-Y1	
	10			1179834	DYEF-M8-Y1	
	12			1179837	DYEF-M10-Y1	
	16			1179840	DYEF-M12-Y1	
	20			1179863	DYEF-M14-Y1	
	25			1179879	DYEF-M16-Y1	
Shock absorber DYES-S-...-Y1 Technical data → Internet: dyef						
	4	Elastic cushioning, without metal stop, short design	E	1152500	DYES-S-M4-Y1	1
	6			1152507	DYES-S-M5-Y1	
	8			1152524	DYES-S-M6-Y1	
	10			1152536	DYES-S-M8-Y1	
	12			1152959	DYES-S-M10-Y1	
	16			1153004	DYES-S-M12-Y1	
	20			1153017	DYES-S-M14-Y1	
	25			1153023	DYES-S-M16-Y1	
Shock absorber DYEF-...-Y1F Technical data → Internet: dyef						
	4	Elastic cushioning, with metal stop	P1	548370	DYEF-M4-Y1F	1
	6			548371	DYEF-M5-Y1F	
	8			548372	DYEF-M6-Y1F	
	10			548373	DYEF-M8-Y1F	
	12			548374	DYEF-M10-Y1F	
	16			548375	DYEF-M12-Y1F	
	20			548376	DYEF-M14-Y1F	
	25			548377	DYEF-M16-Y1F	
Shock absorber DYSW Technical data → Internet: dysw						
	8	Progressive shock absorber, both ends	Y3	548070	DYSW-4-6-Y1F	1
	10			548071	DYSW-5-8-Y1F	
	12			548072	DYSW-7-10-Y1F	
	16			548073	DYSW-8-14-Y1F	
	20			548074	DYSW-10-17-Y1F	
	25			548075	DYSW-12-20-Y1F	
Reducing sleeve DAYH						
	10	For DYSW-4-6	-	1165476	DAYH-4	1
	12	For DYSW-5-8		1165480	DAYH-5	
	16	For DYSW-7-10		1165484	DAYH-7	
	20	For DYSW-8-14		1165488	DAYH-8	
	25	For DYSW-10-17		1165491	DAYH-10	

1) Packaging unit

Mini slides DGSL

Accessories

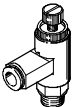
FESTO

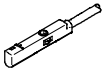

Ordering data					
	For size	Brief description	Part No.	Type	PU ¹⁾
One-way flow control valve GRLA			Technical data → Internet: grla		
	4, 6, 8	<ul style="list-style-type: none"> For regulating speed Only one GRLA-M3-QS-3 can be mounted on the front face with size 4 	175041	GRLA-M3-QS-3	1
	10, 12, 16		175038	GRLA-M3	
			193137	GRLA-M5-QS-3-D	
	20, 25		193138	GRLA-M5-QS-4-D	
			193143	GRLA-1/8-QS-4-D	
	20, 25		193144	GRLA-1/8-QS-6-D	
		162965	GRLA-1/8-QS-6-RS-B		
		162966	GRLA-1/8-QS-8-RS-B		
Push-in fitting QSM			Technical data → Internet: quick star		
	4, 6, 8	For connecting compressed air tubing with standard O.D.	153301	QSM-M3-3	10
	10, 12, 16		153304	QSM-M5-4	
	20, 25		153307	QSM-1/8-6	

1) Packaging unit

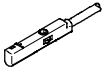
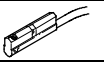
Ordering data – Proximity sensors for C-slot, magneto-resistive					Technical data → Internet: smt	
	Type of mounting	Switching output	Electrical connection, connection direction	Cable length [m]	Part No.	Type
N/O contact						
	Insertable in the slot from above	PNP	Cable, 3-wire, in-line	2.5	551373	SMT-10M-PS-24V-E-2,5-L-OE
			Plug M8x1, 3-pin, in-line	0.3	551375	SMT-10M-PS-24V-E-0,3-L-M8D
			Plug M8x1, 3-pin, angled	0.3	551376	SMT-10M-PS-24V-E-0,3-Q-M8D

Ordering data – Proximity sensors for C-slot, magnetic reed					Technical data → Internet: sme	
	Type of mounting	Switching output	Electrical connection, connection direction	Cable length [m]	Part No.	Type
N/O contact						
	Insertable in the slot from above, flush with the cylinder profile	Contacting	Plug M8x1, 3-pin, in-line	0.3	551367	SME-10M-DS-24V-E-0,3-L-M8D
			Cable, 3-wire, in-line	2.5	551365	SME-10M-DS-24V-E-2,5-L-OE
			Cable, 2-wire, in-line	2.5	551369	SME-10M-ZS-24V-E-2,5-L-OE
	Insertable in the slot lengthwise	Contacting	Plug M8x1, 3-pin, in-line	0.3	173212	SME-10-SL-LED-24
			Cable, 3-wire, in-line	2.5	173210	SME-10-KL-LED-24

- - Note
Proximity sensors SME are not permitted for size 4.

Ordering data – Connecting cables				Technical data → Internet: nebu	
	Electrical connection, left	Electrical connection, right	Cable length [m]	Part No.	Type
	Straight socket, M8x1, 3-pin	Cable, open end, 3-wire	2.5	541333	NEBU-M8G3-K-2.5-LE3
			5	541334	NEBU-M8G3-K-5-LE3
	Angled socket, M8x1, 3-pin	Cable, open end, 3-wire	2.5	541338	NEBU-M8W3-K-2.5-LE3
			5	541341	NEBU-M8W3-K-5-LE3