

**Mini slides DGSL-N, NPT**



# Mini slides DGSL-N, NPT

Key features

## General information

- Double-acting drives
- Wide range of options for mounting
- System product for handling and assembly technology
- Highly flexible thanks to wide range of assembly and connection options on:
  - Drive body, slide, yoke plate

## The technology in detail

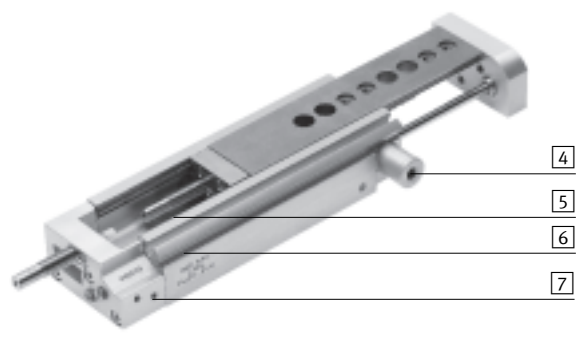
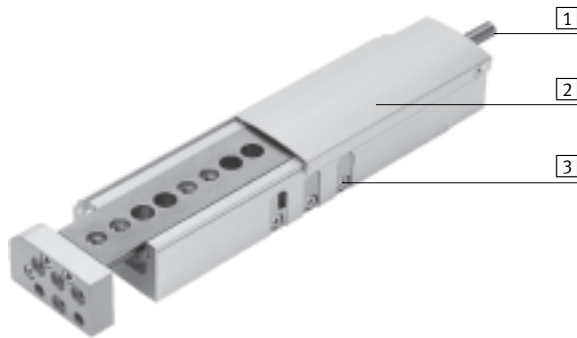

### 1 Cushioning



- Choice of five cushioning types:
  - Elastic cushioning without metal end position (P)
  - Elastic cushioning without metal end position, short design (E)
  - Elastic cushioning with metal end position (P1)
  - Hydraulic shock absorbers (Y3)
  - Shock absorbers with reducing sleeve (Y11)
- Alternative:
  - Without cushioning (N)

### 2 Cover



- The cover stops foreign parts or dirt getting into the guide
- The cover comes in different lengths and can be trimmed as required by the customer

### 3 Coarse stroke adjustment



- The end stop for the advanced end position can be adjusted mechanically, for example to shorten the stroke

### 4 Clamping unit



- Mechanical clamping, for fixing the slide in any position; frictional locking (C)

### 4 End-position locking



- Mechanical locking when the end position is reached, for fixing the slide in the unpressurised, retracted state; positive locking (E3)

### 5 Innovative guide unit

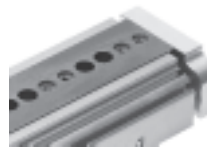

- Wide roller track, which provides extremely high rigidity
- High load capacity
- High precision
- Housing and steel slide form a guide: there are no accumulative tolerances

### 6 Position sensing



- Proximity sensors can be integrated, so there are no projecting parts
- Two slots for mounting
- Clearly visible from the side and from above

### 7 Supply ports

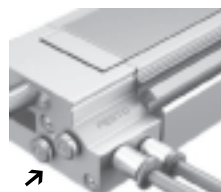

- Choice of two sides:
  - On front face
  - At the side

# Mini slides DGSL-N, NPT

System example

System product for handling and assembly technology

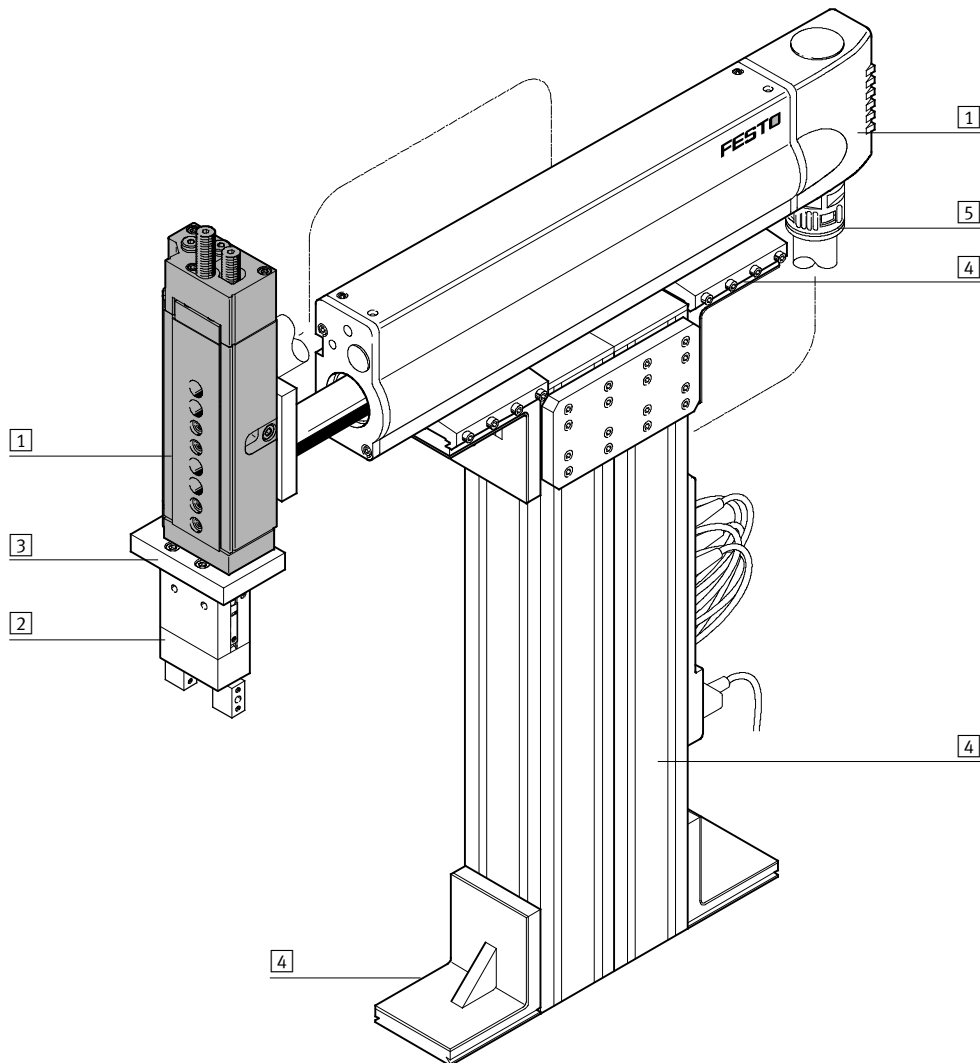

System components and accessories		
	Brief description	→ Page/Internet
1	Drives	Wide range of combinations possible within handling and assembly technology drive
2	Grippers	Wide range of variations possible within handling and assembly technology gripper
3	Adapters	For drive/drive and drive/gripper connections adapter kit
4	Basic components	Profiles and profile connections as well as profile/drive connections basic component
5	Installation components	For a clear, safe layout of electrical cables and tubing installation component
-	Axes	Wide range of combinations possible within handling and assembly technology axis
-	Motors	Servo and stepper motors, with or without gearing motor

# Mini slides DGSL-N, NPT

Peripherals overview

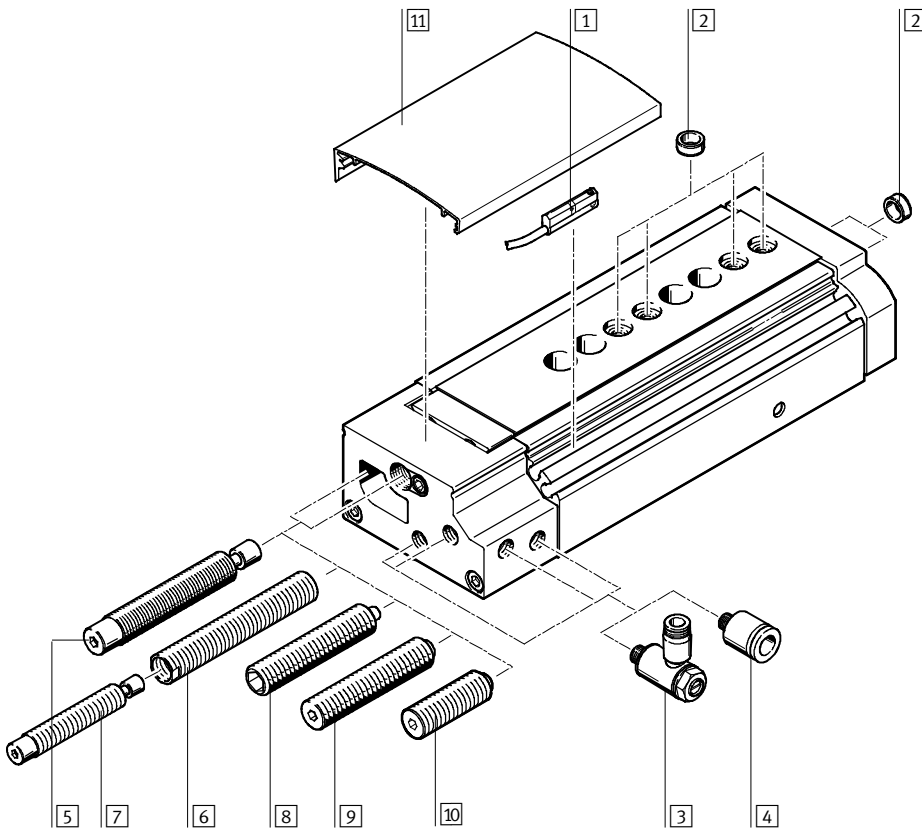

 Note  
Operation without cushioning components is not permitted.

Accessories			
	Brief description	→ Page/Internet	
1	Proximity sensor SME/SMT-10	For position sensing. Can be integrated in sensor slot, so there are no projecting parts	42
2	Centring sleeve ZBH	For centring loads and attachments (centring sleeves are included in the scope of delivery of the mini slide)	41
3	One-way flow control valve GRLA	For regulating speed	42
4	Push-in fitting QB	For connecting compressed air tubing with standard O.D.	42
5	Cushioning with shock absorber Y3	For large loads and high speed. Ensures precise, metal-to-metal contact after the cushioning	41
6	Reducing sleeve DAYH	For installing a smaller shock absorber. For applications where the cushioning energy lies between the cushioning Y3 and P1	41
7	Shock absorber DYSW	→ 12 (shock absorber selection)	41
8	Cushioning with stop P1	Precision metal stop for small loads at low speed	41
9	Cushioning P	<ul style="list-style-type: none"> <li>• Flexible stop for medium loads at medium speed</li> <li>• (standard design)</li> </ul>	41
10	Cushioning E	<ul style="list-style-type: none"> <li>• Flexible stop for medium loads at medium speed</li> <li>• (short design)</li> </ul>	41
11	Cover DADS	<ul style="list-style-type: none"> <li>• For protection, to stop foreign parts or dirt getting into the guide</li> <li>• The cover can be trimmed as required by the customer</li> </ul>	40

# Mini slides DGSL-N, NPT

Type codes

	DGSL	-	N	-	10	-	100	-		-	E3	-	Y3	-	A
<b>Type</b>															
Double-acting															
DGSL	Mini slide														
<b>System of units</b>															
N	Imperial														
<b>Size</b>															
<b>Stroke [mm]</b>															
<b>Clamping unit</b>															
C	Attached														
<b>End-position locking</b>															
E3	With piston rod in retracted position														
<b>Cushioning</b>															
P	Elastic cushioning without metal end position, both ends														
P1	Elastic cushioning with metal end position, both ends														
Y3	Progressive shock absorber, both ends														
E	Elastic cushioning without metal end position, both ends, short design														
Y11	Progressive shock absorber with reducing sleeve, both ends														
N	Without cushioning														
<b>Position sensing</b>															
A	Via proximity sensor														

# Mini slides DGSL-N, NPT

Technical data

FESTO

Function

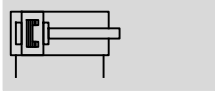

Wearing parts kits

→ 40

○ - Size  
10 ... 25

▬ - Stroke length  
10 ... 200 mm



General technical data			10	12	16	20	25
Size			10	12	16	20	25
Pneumatic connection			M5, suitable for 10-32 UNF			1/8 NPT	
Design			Scotch yoke system				
Guide			Ball bearing cage guide				
Type of mounting			Via through-hole				
			Via female thread				
Cushioning	P		Flexible cushioning without metal end position, both ends				
	E		Flexible cushioning without metal end position, both ends, short design				
	P1		Flexible cushioning with metal end position, both ends, adjustable				
	Y3		With progressive shock absorber, both ends				
	Y11		Progressive shock absorber with reducing sleeve, both ends				
	N		Without cushioning				
Position sensing			Via proximity sensor				
Mounting position			Any				
Max. advancing speed		[m/s]	0.8				
Max. retracting speed		[m/s]	0.8				
Repetition accuracy	P1/Y3	[mm]	±0.01				
	P	[mm]	0.3				

Operating and environmental conditions			10	12	16	20	25
Size			10	12	16	20	25
Operating medium			Compressed air in accordance with ISO 8573-1:2010 [7:4:4]				
Note on operating/pilot medium			Operation with lubricated medium possible (in which case lubricated operation will always be required)				
Min. operating pressure		[bar]	1.5	1			
Max. operating pressure		[bar]	8				
Ambient temperature <sup>1)</sup>		[°C]	0 ... +60				

1) Note operating range of proximity sensors.

Piston Ø, forces and impact energy			10	12	16	20	25
Size			10	12	16	20	25
Piston Ø		[mm]	12	16	20	25	32
Theoretical force at 6 bar, advancing		[N]	68	121	188	295	483
Theoretical force at 6 bar, retracting		[N]	51	104	158	247	415
Impact energy in the end positions	P, E	[Nm]	0.12	0.25	0.35	0.45	0.55
	P1	[Nm]	0.04	0.06	0.12	0.2	0.25
	Y3	[Nm]	1.3	2.5	4	8	12
	1)	[Nm]	0.8	1.3	2.5	4	8

1) With reducing sleeve and next smallest shock absorber.

# Mini slides DGSL-N, NPT

Technical data

FESTO

Weight [g]						
Size	Stroke	10	12	16	20	25
Product weight without cushioning component						
	10	396	604	896	1,535	2,520
	20	434	660	954	1,649	2,670
	30	470	711	1,008	1,746	2,824
	40	507	762	1,072	1,857	2,983
	50	548	813	1,143	1,991	3,137
	80	727	1,112	1,365	2,295	4,019
	100	813	1,229	1,712	2,921	4,519
	150	–	1,499	2,034	3,620	5,344
	200	–	–	–	4,248	6,139
Moving load without cushioning component						
	10	163	256	403	660	998
	20	180	279	432	710	1,052
	30	194	299	459	750	1,115
	40	208	320	486	801	1,181
	50	226	340	519	858	1,244
	80	299	456	618	998	1,567
	100	334	507	776	1,254	1,761
	150	–	614	910	1,566	2,102
	200	–	–	–	1,807	2,432
Cushioning component						
	P	14	23	45.6	82.4	106
	E	9	12	15	31	40
	P1	12	19.7	39.6	77.3	104
	Y3	11	21	42	67	91
	1)	18	33	52	91	131

1) With reducing sleeve and next smallest shock absorber.

## Materials

Sectional view

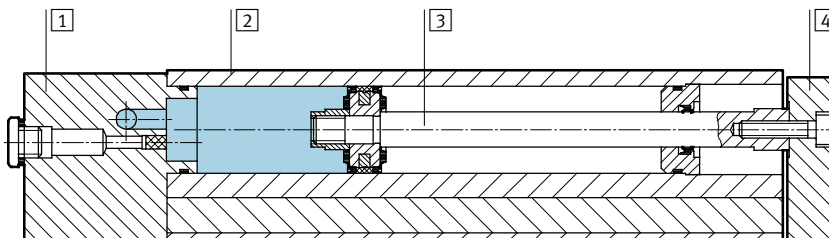

Mini slide	
1	End cap Anodised aluminium
2	Housing Anodised aluminium
3	Piston rod High-alloy steel
4	Yoke plate Anodised aluminium
–	Guide Tempered steel
–	Seals Thermoplastic rubber, hydrogenated nitrile rubber, nitrile rubber
Note on materials Free of copper and PTFE	

# Mini slides DGSL-N, NPT

Technical data

## Possible combinations without adapter plate

Pick & place

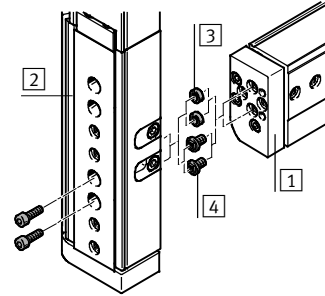
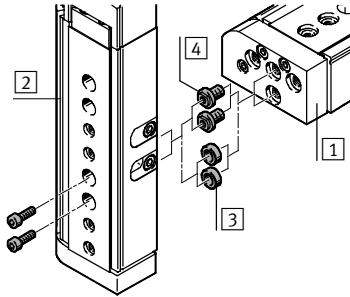

- 3 Centring sleeve ZBH
- 4 Connector sleeve ZBV

## Piggy-back assembly

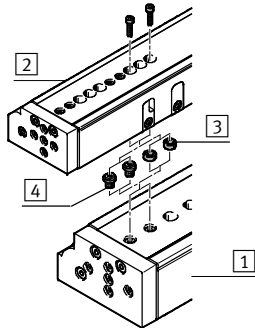

- 3 Centring sleeve ZBH
- 4 Connector sleeve ZBV

## Mounting example with connector sleeve ZBV

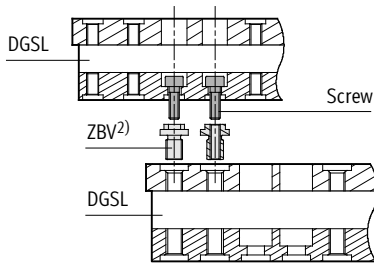

		1 Basic drive					
		Size	10	12	16	20	25
2 Assembly drive	10		2x M4x14 2x ZBH-7 <sup>1)</sup>	ZBV-M5-7 <sup>2)</sup>	ZBV-M5-7 <sup>2)</sup>	-	-
	12		-	2x M5x14 2x ZBH-7 <sup>1)</sup>	2x M5x16 2x ZBH-7 <sup>1)</sup>	ZBV-M6-9 <sup>2)</sup>	ZBV-M6-9 <sup>2)</sup>
	16		-	-	2x M5x18 2x ZBH-7 <sup>1)</sup>	ZBV-M6-9 <sup>2)</sup>	ZBV-M6-9 <sup>2)</sup>
	20		-	-	-	2x M6x20 2x ZBH-9 <sup>1)</sup>	2x M6x20 2x ZBH-9 <sup>1)</sup>
	25		-	-	-	-	2x M6x30 2x ZBH-9 <sup>1)</sup>

1) Centring sleeves ZBH are included in the scope of delivery of the mini slide DGSL

2) Connector sleeves ZBV → 41



# Mini slides DGSL-N, NPT

Technical data

## Parallelism [mm]

The term parallelism refers to the accuracy of alignment between the mounting surface and the slide surface.

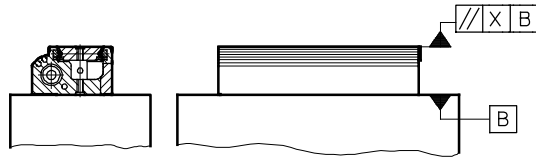

Size	Stroke [mm]	10	12	16	20	25
Parallelism X	10	0.02	0.02	0.02	0.02	0.02
	20	0.02	0.025	0.025	0.025	0.025
	30	0.025	0.025	0.025	0.03	0.03
	40	0.025	0.03	0.03	0.035	0.035
	50	0.03	0.035	0.035	0.04	0.04
	80	0.035	0.04	0.04	0.045	0.045
	100	0.045	0.05	0.05	0.055	0.055
	150	-	0.075	0.075	0.08	0.08
	200	-	-	-	0.08	0.08

## Linearity [mm]

The term linearity refers to the accuracy of alignment between the mounting surface and the slide surface as a function of the stroke.

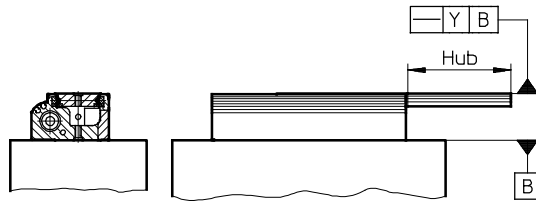

## Linear travel accuracy as a function of stroke length l

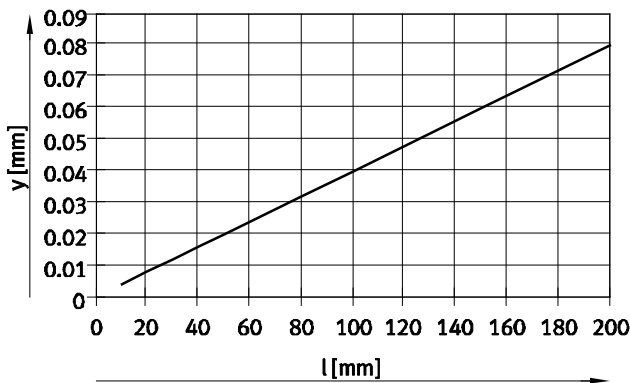

# Mini slides DGSL-N, NPT

Technical data

## Adjustable end-position range

Coarse adjustment of the advanced end position

The mini slide DGSL allows the front fixed stop to be adjusted by removing the cover.

This permits stroke reduction down to the next but one smaller standard stroke through a combination of coarse and precision adjustments.

### Advantages:

- Can be flexibly adapted to the application
- Integrated, which means fewer conversion overheads
- Large setting range



Note

Removal of the fixed stops can result in the destruction of the mini slide DGSL.

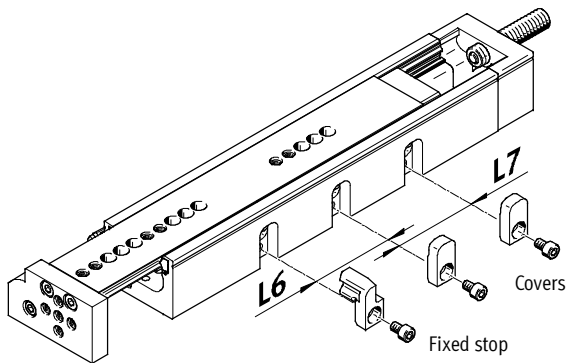

Size Stroke [mm]	10		12		16		20		25	
	L6	L7	L6	L7	L6	L7	L6	L7	L6	L7
10	-	-	-	-	-	-	-	-	-	-
20	-	-	-	-	-	-	-	-	-	-
30	-	-	-	-	-	-	-	-	-	-
40	-	-	-	-	-	-	-	-	-	-
50	-	-	-	-	-	-	-	-	-	-
80	24	-	29	-	35	-	-	-	55	-
100	24	24	29	-	35	-	44	-	55	-
150	-	-	29	29	35	-	44	-	55	-
200	-	-	-	-	-	-	44	44	55	-

### Example:

DGSL-N-12-150-...

Max. stroke = 150 mm

By adjusting the fixed stop

by the dimension L6:

Stroke =  $150 - 29 = 121$  mm

By adjusting the fixed stop

by the dimension L6 and L7:

Stroke =  $150 - 29 - 29 = 92$  mm

The stroke can additionally be reduced by means of precision adjustment:

Stroke =  $150 - 29 - 29 - 29 = 63$  mm

**Precision adjustment of the advanced and retracted end position → 11**

# Mini slides DGSL-N, NPT

Technical data



## Adjustable end-position range

Precision adjustment of the advanced and retracted end position

Precision adjustment of the required stroke reduction is possible using the cushioning components (on the slide and in the end cap).

### Advantages:

- Precision adjustment is precisely fixed by the clamping component
- No readjustment required, position is fully retained under load
- Quick and easy adjustment, only one tool required

### Step 1:

Loosen the clamping component.

### Step 2:

Position the slide by hand in the desired end position.

### Step 3:

Turn the stop element using an Allen key until the end position is reached.

### Step 4:

Tighten the clamping component.

### Step 1

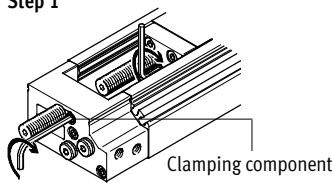

### Step 2 ... 4

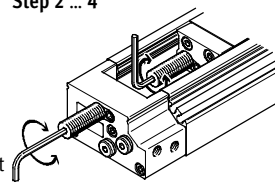

Adjustable end-position range [mm] per end position/stroke reduction						
Size		10	12	16	20	25
<b>Advanced end position</b>						
With cushioning	P	-27.5	-29	-37.5	-50.5	-55
	E	-13	-9	-3.5	-6.5	-11.5
	P1	-27.5	-29	-37.5	-50.5	-55
	Y3	-24	-29	-36.5	-44	-56
	1)	-24	-29	-36.5	-44	-56
<b>Retracted end position</b>						
With cushioning	P	-20	-25.5	-39.5	-49.5	-49
	E	-5.5	-5.5	-5.5	-5.5	-5.5
	P1	-20	-25.5	-39.5	-49.5	-49
	Y3	-15	-25.5	-38.5	-42	-51.5
	1)	-15	-25.5	-38.5	-42	-51.5

1) With reducing sleeve and next smallest shock absorber.

**Note**

The distance L of the cushioning component (→ operating instructions) must not be fallen below (factory setting).

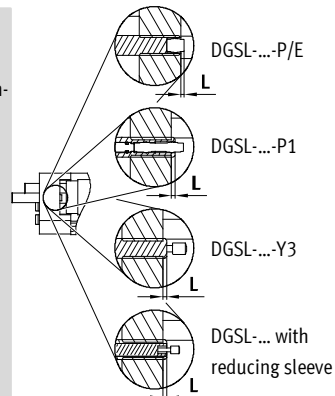

**Note**

The setting range of the advanced and retracted end position is restricted when using the cushioning type "E".

# Mini slides DGSL-N, NPT

Technical data

## Shock absorber selection

Effective load  $m$  as a function of impact velocity  $v$

The mini slide DGSL allows the shock absorber to be replaced and, in this way, the cushioning behaviour to be influenced (depending on the effective load).

This is done by removing the existing shock absorbers on the DGSL and replacing them with a smaller shock absorber as appropriate to the application (→ description below).

### Graphs

for selecting a suitable shock absorber as a function of the mounting position of the mini slide → from 13.

### Ordering data

Shock absorbers DYSW, DYEF and reducing sleeve DAYH → 41.

### With smaller loads:

The next smallest shock absorber DYSW can be installed with the help of the reducing sleeve DAYH.

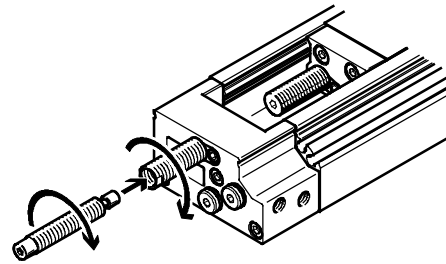
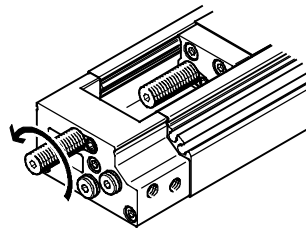

### With very small loads:

The shock absorber DYEF can be installed in this case.

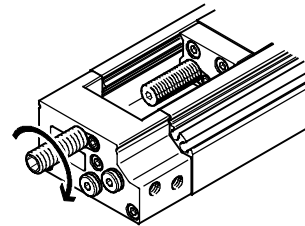
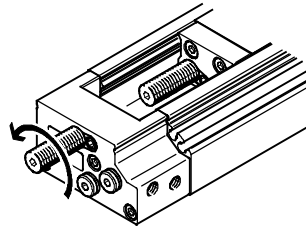

### Selection example:

Existing drive:  
Mini slide: DGSL-N-10-...-Y3-A

Given:  
Effective load: 500 g  
Impact velocity: 0.4 m/s  
Mounting position: Horizontal

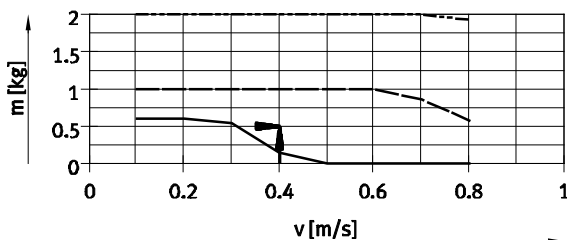

- DYSW-5-8 (cushioning Y3)
- DYSW-4-6 with DAYH-4 (cushioning Y11)
- DYEF-M8-Y1F

### Result:

The first cushioning curve, which is located above the point of intersection, is the most suitable for this case. Due to the low effective load of less than one kilogram, the cushioning characteristics are greatly improved by

replacing the shock absorber DYSW-5-8 integrated in the mini slide with the reducing sleeve DAYH-4 and the next smallest shock absorber DYSW-4-6.

Fundamentally, the following applies: shock absorbers must be loaded. Since the shock absorber DYSW-4-6 is more fully utilised in this case, both the service life of the shock absorber

and the cushioning characteristics are improved.

# Mini slides DGSL-N, NPT

Technical data

## Shock absorber selection

Effective load  $m$  as a function of impact velocity  $v$  – horizontal mounting position

### DGSL-N-10

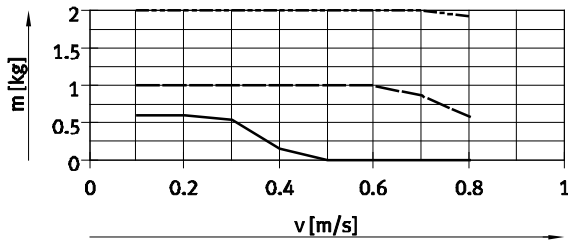

- DYSW-5-8 (cushioning Y3)
- DYSW-4-6 with DAYH-4 (cushioning Y11)
- DYEF-M8-Y1F

### DGSL-N-12

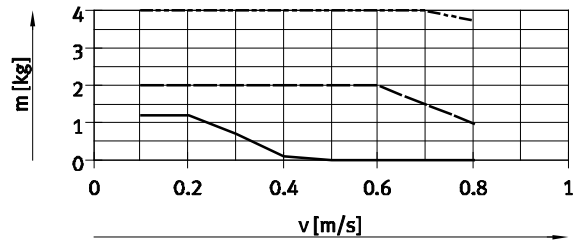

- DYSW-7-10 (cushioning Y3)
- DYSW-5-8 with DAYH-5 (cushioning Y11)
- DYEF-M10-Y1F

### DGSL-N-16

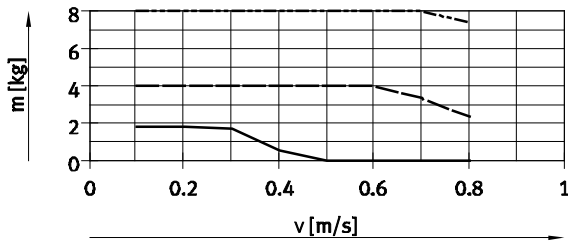

- DYSW-8-14 (cushioning Y3)
- DYSW-7-10 with DAYH-7 (cushioning Y11)
- DYEF-M12-Y1F

### DGSL-N-20

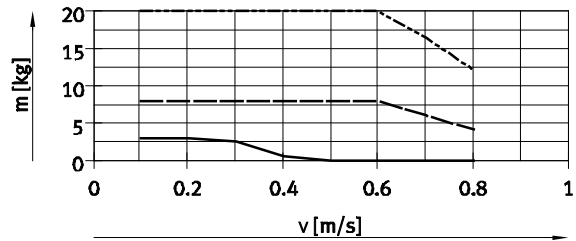

- DYSW-10-17 (cushioning Y3)
- DYSW-8-14 with DAYH-8 (cushioning Y11)
- DYEF-M14-Y1F

### DGSL-N-25

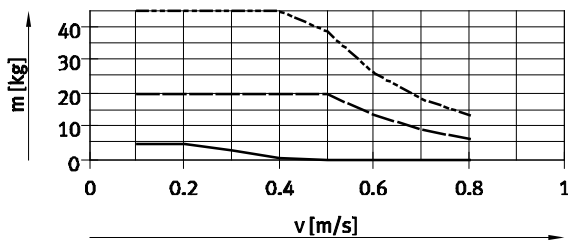

- DYSW-12-20 (cushioning Y3)
- DYSW-10-17 with DAYH-10 (cushioning Y11)
- DYEF-M16-Y1F

# Mini slides DGSL-N, NPT

Technical data

FESTO

## Shock absorber selection

Effective load  $m$  as a function of impact velocity  $v$  – vertical mounting position, effective load moving upwards

### DGSL-N-10

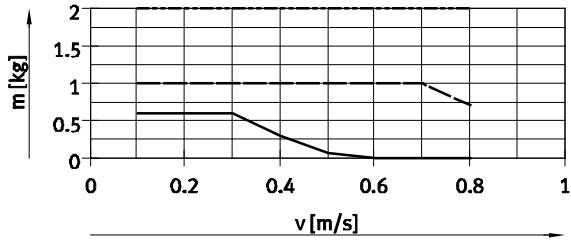

- DYSW-5-8 (cushioning Y3)
- DYSW-4-6 with DAYH-4 (cushioning Y11)
- DYEF-M8-Y1F

### DGSL-N-12

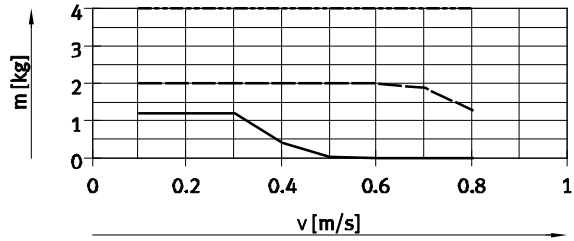

- DYSW-7-10 (cushioning Y3)
- DYSW-5-8 with DAYH-5 (cushioning Y11)
- DYEF-M10-Y1F

### DGSL-N-16

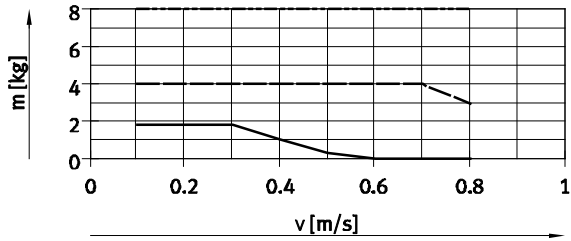

- DYSW-8-14 (cushioning Y3)
- DYSW-7-10 with DAYH-7 (cushioning Y11)
- DYEF-M12-Y1F

### DGSL-N-20

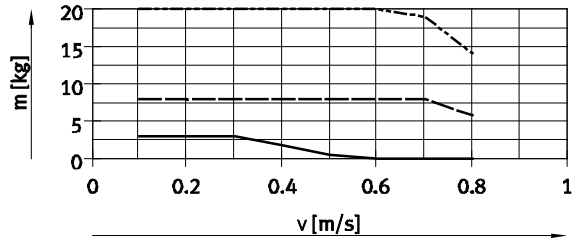

- DYSW-10-17 (cushioning Y3)
- DYSW-8-14 with DAYH-8 (cushioning Y11)
- DYEF-M14-Y1F

### DGSL-N-25

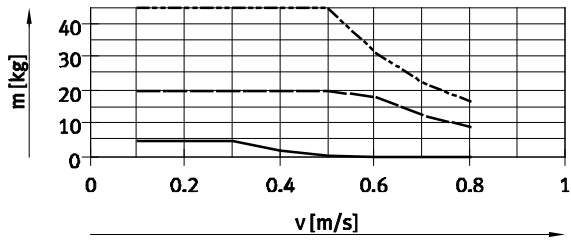

- DYSW-12-20 (cushioning Y3)
- DYSW-10-17 with DAYH-10 (cushioning Y11)
- DYEF-M16-Y1F

# Mini slides DGSL-N, NPT

Technical data

## Shock absorber selection

Effective load  $m$  as a function of impact velocity  $v$  – vertical mounting position, effective load moving downwards

### DGSL-N-10

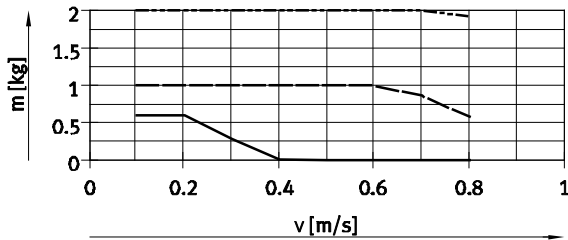

- DYSW-5-8 (cushioning Y3)
- DYSW-4-6 with DAYH-4 (cushioning Y11)
- DYEF-M8-Y1F

### DGSL-N-12

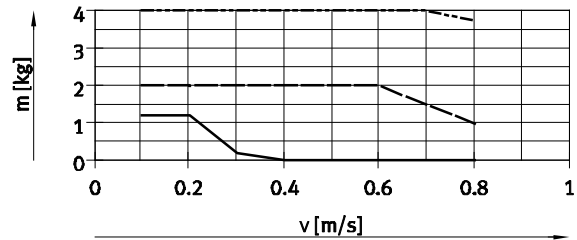

- DYSW-7-10 (cushioning Y3)
- DYSW-5-8 with DAYH-5 (cushioning Y11)
- DYEF-M10-Y1F

### DGSL-N-16

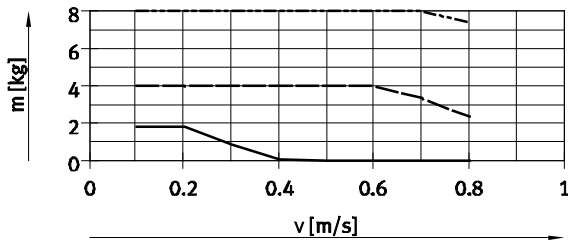

- DYSW-8-14 (cushioning Y3)
- DYSW-7-10 with DAYH-7 (cushioning Y11)
- DYEF-M12-Y1F

### DGSL-N-20

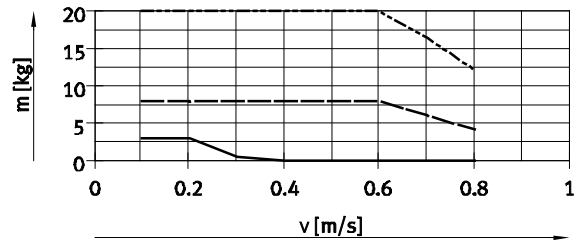

- DYSW-10-17 (cushioning Y3)
- DYSW-8-14 with DAYH-8 (cushioning Y11)
- DYEF-M14-Y1F

### DGSL-N-25

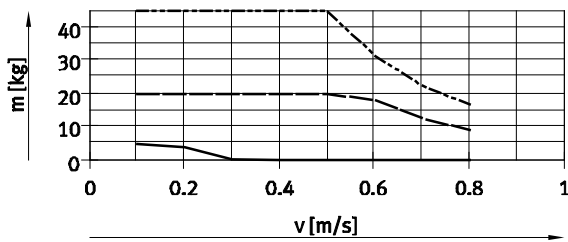

- DYSW-12-20 (cushioning Y3)
- DYSW-10-17 with DAYH-10 (cushioning Y11)
- DYEF-M16-Y1F

# Mini slides DGSL-N, NPT

Technical data

## Shock absorber selection

Travel time  $t$  as a function of effective load  $m$  and cushioning P/E – horizontal mounting position



The values in the graphs are determined by calculation.  
The travel time as a function of effective load must not be reduced below

the values shown, because the kinetic impact or residual energy in the end positions can result in damage to the drive.

Vertical mounting position  
→ 19

### Advancing

Stroke 10 mm, size 10

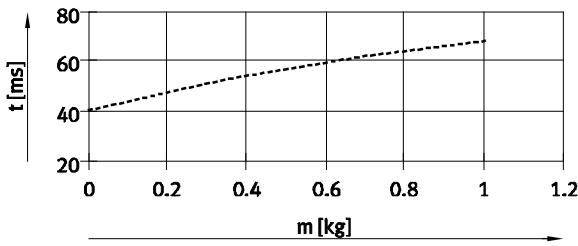

### Retracting

Stroke 10 mm, size 10

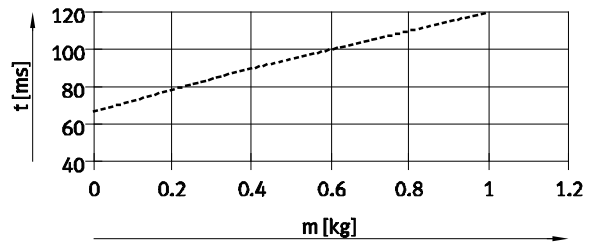

Stroke 10 mm, size 12 ... 16

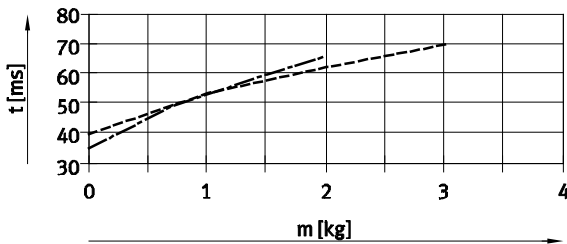

Stroke 10 mm, size 12 ... 16

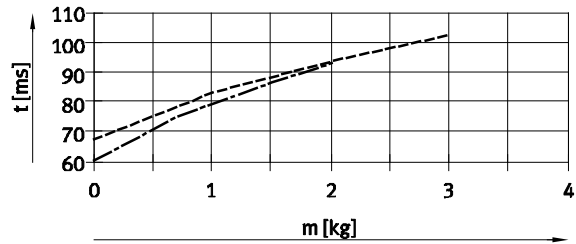

Stroke 10 mm, size 20 ... 25

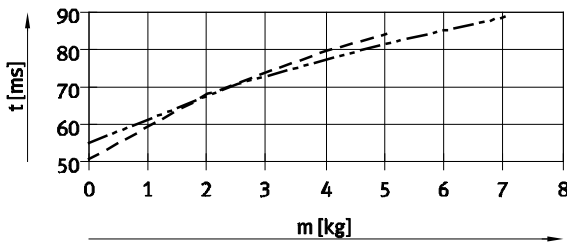

Stroke 10 mm, size 20 ... 25

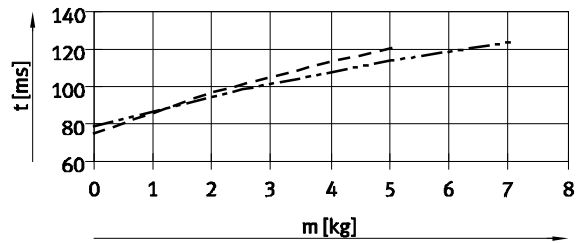

Stroke 30 mm, size 10

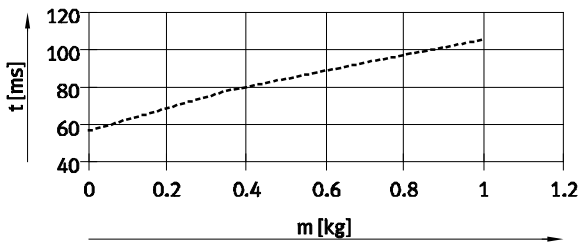

Stroke 30 mm, size 10

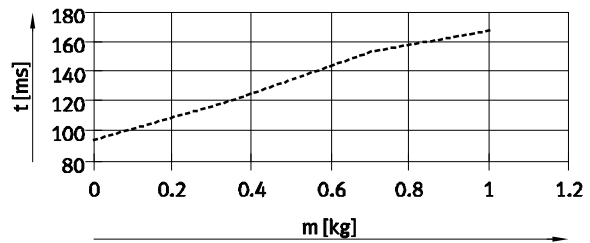

- DGSL-N-10
- DGSL-N-12
- DGSL-N-16
- DGSL-N-20
- DGSL-N-25



# Mini slides DGSL-N, NPT

Technical data

## Shock absorber selection

Travel time  $t$  as a function of effective load  $m$  and cushioning P/E – horizontal mounting position

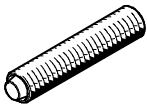

The values in the graphs are determined by calculation. The travel time as a function of effective load must not be reduced below

the values shown, because the kinetic impact or residual energy in the end positions can result in damage to the drive.

Vertical mounting position  
→ 19

### Advancing

Stroke 30 mm, size 12 ... 25

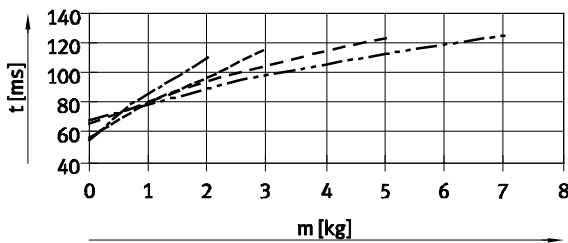

### Retracting

Stroke 30 mm, size 12 ... 16

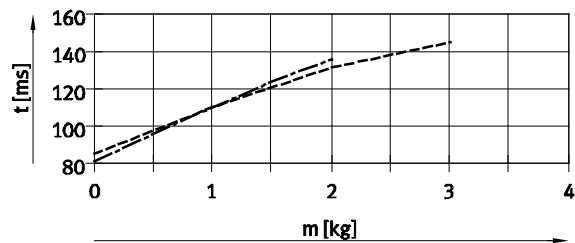

Stroke 30 mm, size 20 ... 25

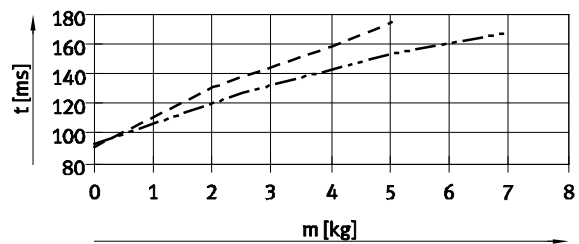

Stroke 50 mm, size 10 ... 12

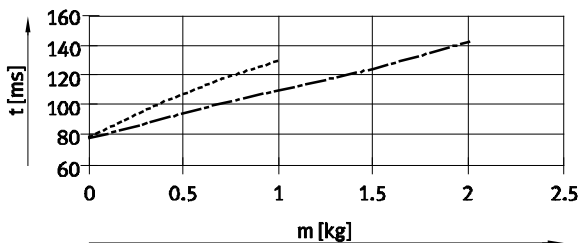

Stroke 50 mm, size 10 ... 12

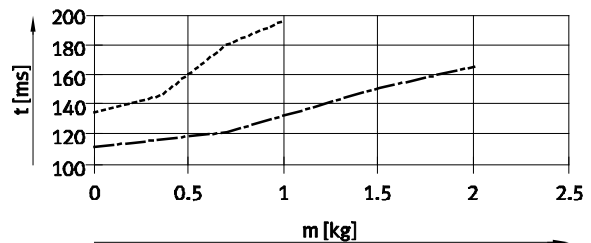

Stroke 50 mm, size 16 ... 25

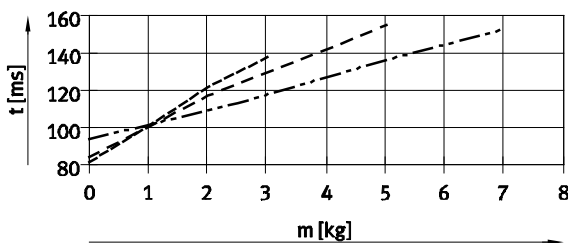

Stroke 50 mm, size 16

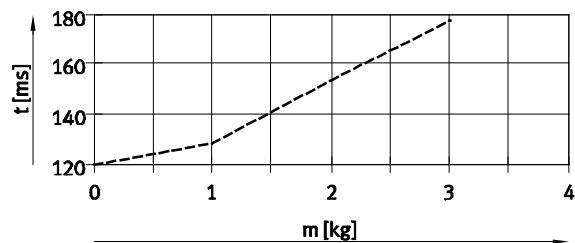

- ..... DGSL-N-10
- DGSL-N-12
- DGSL-N-16
- DGSL-N-20
- DGSL-N-25

Stroke 50 mm, size 20 ... 25

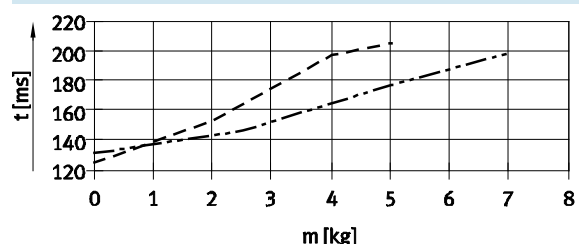

# Mini slides DGSL-N, NPT

Technical data

## Shock absorber selection

Travel time  $t$  as a function of effective load  $m$  and cushioning P/E – horizontal mounting position



The values in the graphs are determined by calculation.  
The travel time as a function of effective load must not be reduced below

the values shown, because the kinetic impact or residual energy in the end positions can result in damage to the drive.

Vertical mounting position  
→ 19

### Advancing

Stroke 100 mm, size 10 ... 16

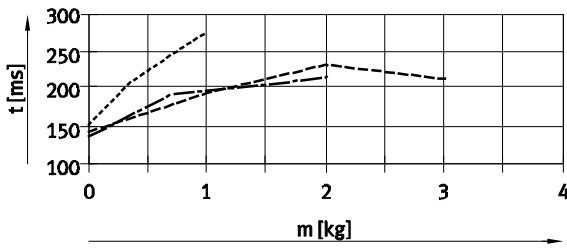

### Retracting

Stroke 100 mm, size 10 ... 16

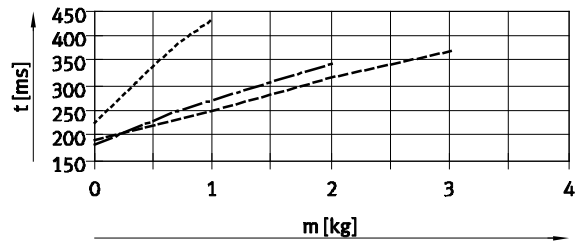

Stroke 100 mm, size 20 ... 25

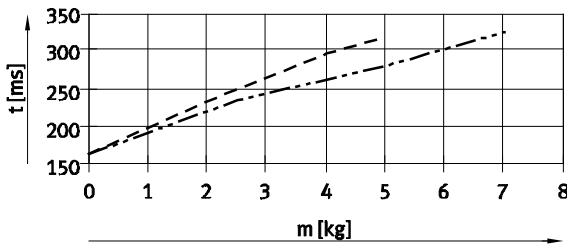

Stroke 100 mm, size 20 ... 25

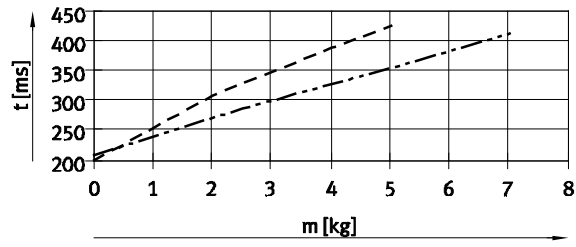

Stroke 150 mm, size 12 ... 16

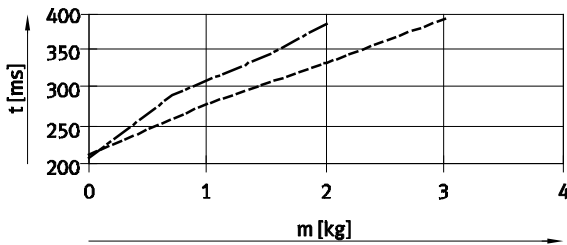

Stroke 150 mm, size 12 ... 16

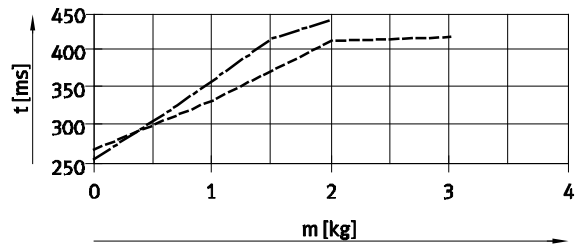

Stroke 150 mm, size 20 ... 25

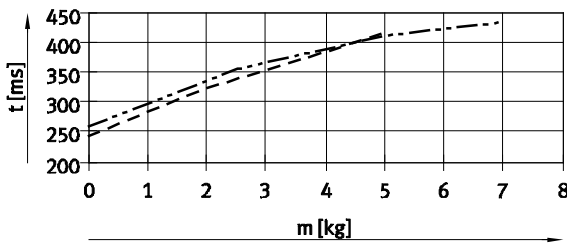

Stroke 150 mm, size 20 ... 25

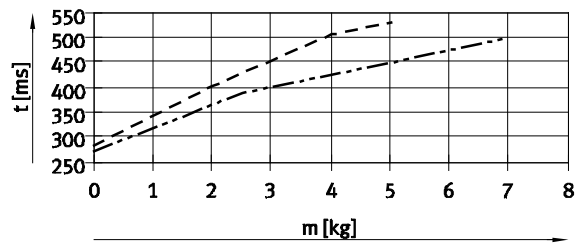

- ..... DGSL-N-10
- . - . DGSL-N-12
- DGSL-N-16
- DGSL-N-20
- DGSL-N-25

# Mini slides DGSL-N, NPT

Technical data

## Shock absorber selection

Travel time  $t$  as a function of effective load  $m$  and cushioning  $P/E$  – horizontal mounting position

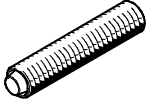

The values in the graphs are determined by calculation. The travel time as a function of effective load must not be reduced below

the values shown, because the kinetic impact or residual energy in the end positions can result in damage to the drive.

Vertical mounting position  
→ 19

### Advancing

Stroke 200 mm, size 20 ... 25

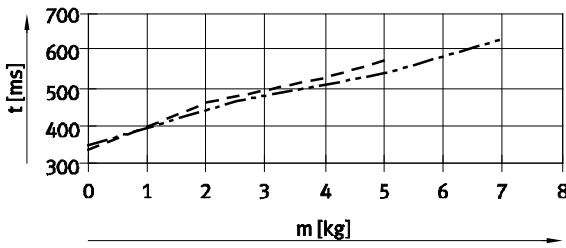

### Retracting

Stroke 200 mm, size 20 ... 25

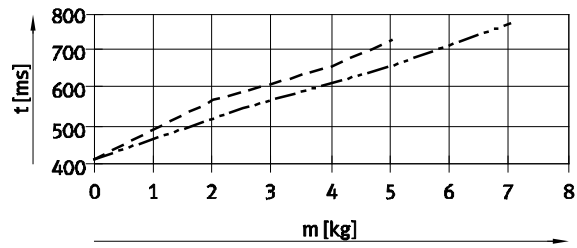

- - - - DGSL-N-20
- · - · - DGSL-N-25

## Vertical mounting position

The travel times for a vertical mounting position are calculated by multiplying the data ascertained for horizontal mounting position by a correction factor  $k_a$  (advancing) and  $k_r$  (retracting), see adjacent table.

**Given:**  
 Stroke = 200 mm  
 Size = 20  
 Effective load = 3 kg  
 Ascertained travel time  $t_h$  (horizontal), see graph:  
 – Advancing = 500 ms  
 – Retracting = 600 ms  
 Calculated travel time  $t_v$  (vertical):  
 – Advancing:  $t_v = t_h \times k_a$   
 $t_v = 500 \text{ ms} \times 0.9 = 450 \text{ ms}$   
 – Retracting:  $t_v = t_h \times k_r$   
 $t_v = 600 \text{ ms} \times 1.1 = 660 \text{ ms}$

Stroke [mm]	Size	Advancing ( $k_a$ ) <sup>1)</sup>	Retracting ( $k_r$ )
10	10	0.95	1.1
	12, 16, 20, 25	0.95	1.2
30	10	0.95	1.1
	12, 16, 20, 25	0.95	1.2
50	10, 12	0.9	1.1
	16, 20, 25	1.1	1.2
100	10, 12, 16, 20, 25	1	1.1
150	12, 16, 20, 25	1	1.1
200	20, 25	0.9	1.1

1) Downward.

# Mini slides DGSL-N, NPT

Technical data

## Shock absorber selection

Travel time  $t$  as a function of effective load  $m$  and cushioning P1 – horizontal mounting position



The values in the graphs are determined by calculation. The travel time as a function of effective load must not be reduced below

the values shown, because the kinetic impact or residual energy in the end positions can result in damage to the drive.

Vertical mounting position  
→ 23

### Advancing

Stroke 10 mm, size 10

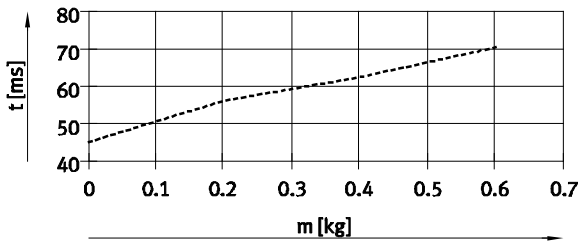

### Retracting

Stroke 10 mm, size 10

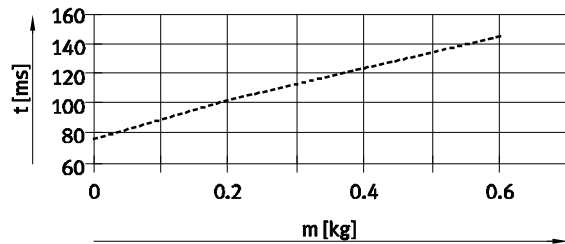

Stroke 10 mm, size 12 ... 16

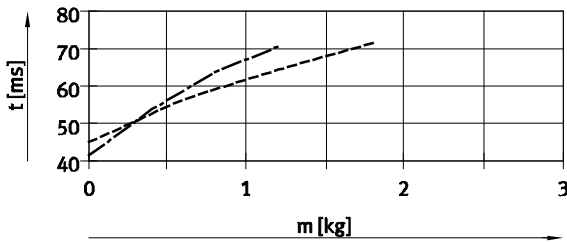

Stroke 10 mm, size 12 ... 16

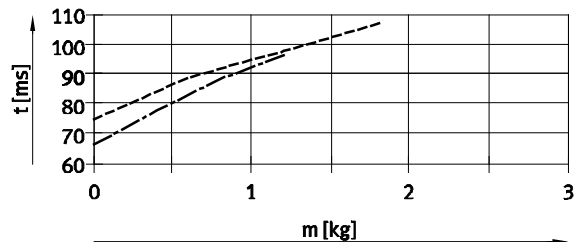

Stroke 10 mm, size 20 ... 25

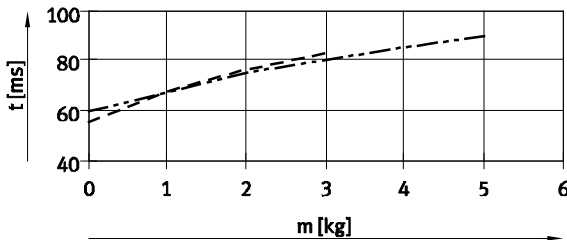

Stroke 10 mm, size 20 ... 25

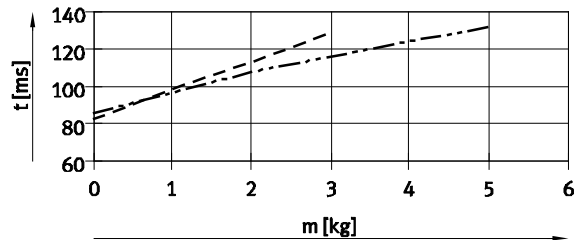

Stroke 30 mm, size 10

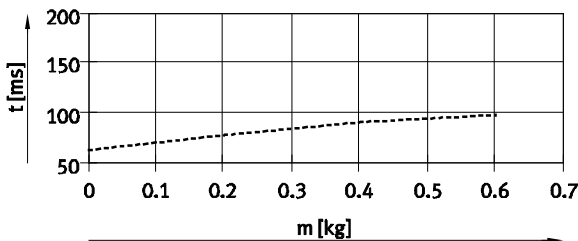

Stroke 30 mm, size 10

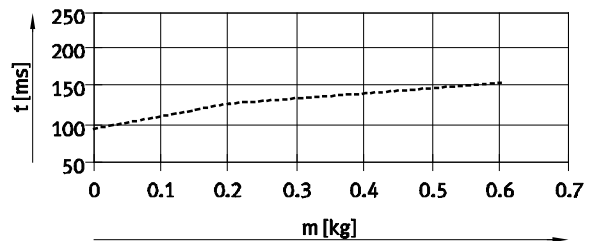

- DGSL-N-10
- DGSL-N-12
- DGSL-N-16
- DGSL-N-20
- DGSL-N-25

# Mini slides DGSL-N, NPT

Technical data

## Shock absorber selection

Travel time  $t$  as a function of effective load  $m$  and cushioning P1 – horizontal mounting position

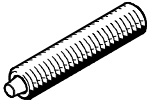

The values in the graphs are determined by calculation. The travel time as a function of effective load must not be reduced below

the values shown, because the kinetic impact or residual energy in the end positions can result in damage to the drive.

Vertical mounting position  
→ 23

### Advancing

Stroke 30 mm, size 12 ... 16

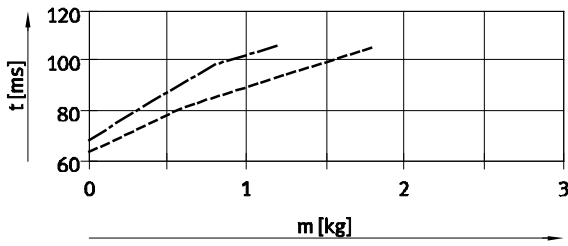

### Retracting

Stroke 30 mm, size 12 ... 16

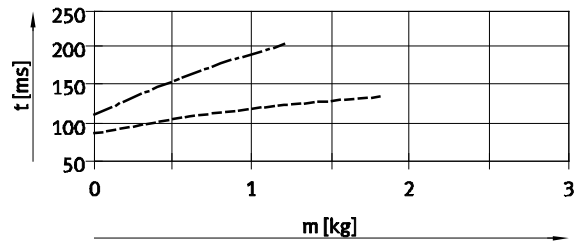

Stroke 30 mm, size 20 ... 25

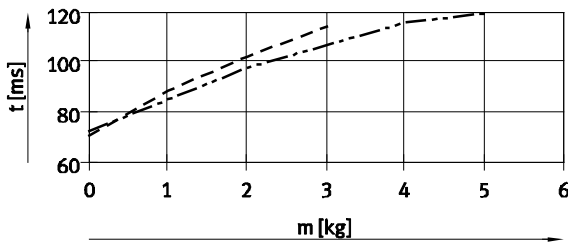

Stroke 30 mm, size 20 ... 25

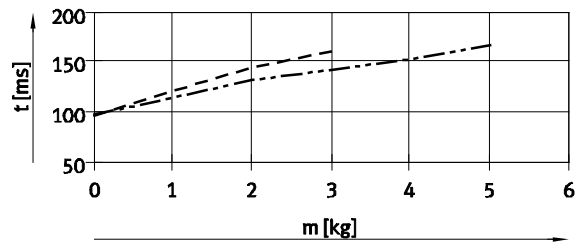

Stroke 50 mm, size 10 ... 12

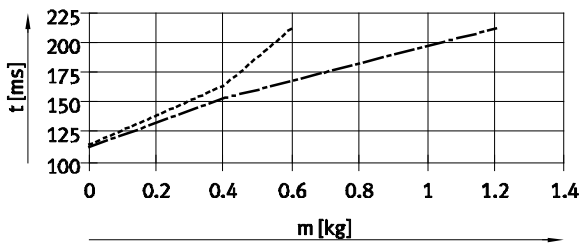

Stroke 50 mm, size 10 ... 12

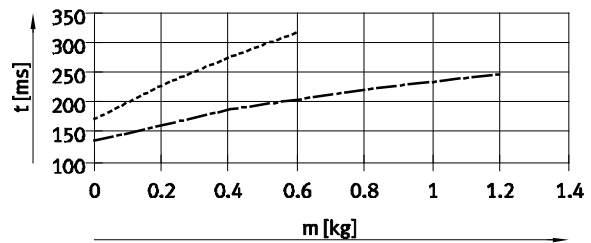

Stroke 50 mm, size 16 ... 25

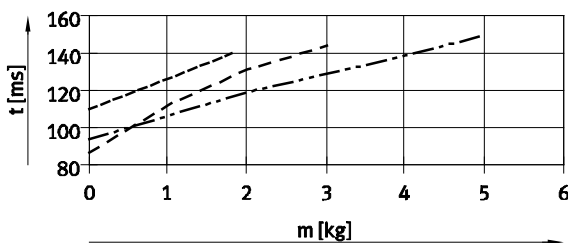

Stroke 50 mm, size 16 ... 25

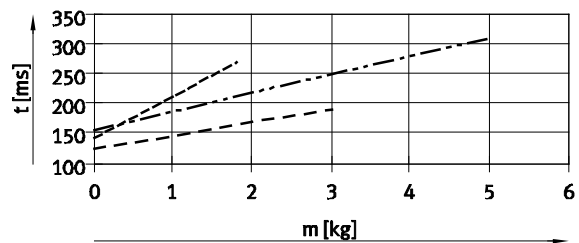

- DGSL-N-10      - - - - - DGSL-N-20
- - - - - DGSL-N-12      - - - - - DGSL-N-25
- DGSL-N-16

# Mini slides DGSL-N, NPT

Technical data

## Shock absorber selection

Travel time  $t$  as a function of effective load  $m$  and cushioning P1 – horizontal mounting position



The values in the graphs are determined by calculation.  
The travel time as a function of effective load must not be reduced below

the values shown, because the kinetic impact or residual energy in the end positions can result in damage to the drive.

Vertical mounting position  
→ 23

### Advancing

Stroke 100 mm, size 10 ... 16

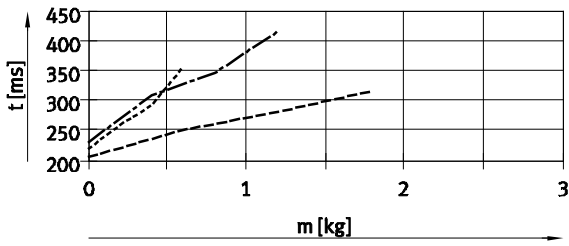

### Retracting

Stroke 100 mm, size 10 ... 25

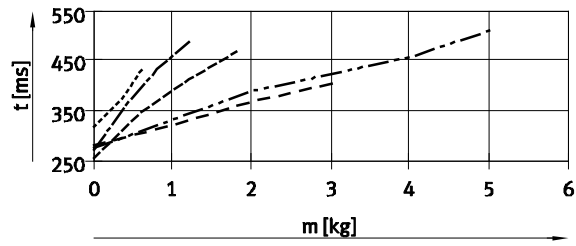

Stroke 100 mm, size 20 ... 25

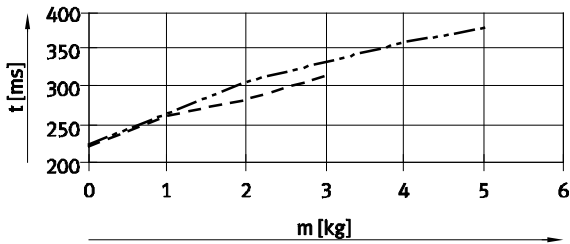

Stroke 150 mm, size 12 ... 25

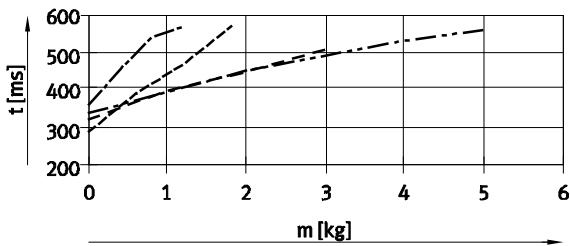

Stroke 150 mm, size 12 ... 25

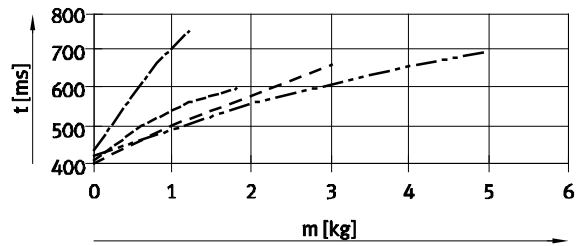

- ..... DGSL-N-10
- · - · - DGSL-N-12
- DGSL-N-16
- - - - - DGSL-N-20
- · · · - DGSL-N-25

# Mini slides DGSL-N, NPT

Technical data

## Shock absorber selection

Travel time  $t$  as a function of effective load  $m$  and cushioning P1 – horizontal mounting position

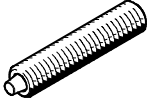

The values in the graphs are determined by calculation.  
The travel time as a function of effective load must not be reduced below

the values shown, because the kinetic impact or residual energy in the end positions can result in damage to the drive.

Vertical mounting position  
→ 23

### Advancing

Stroke 200 mm, size 20

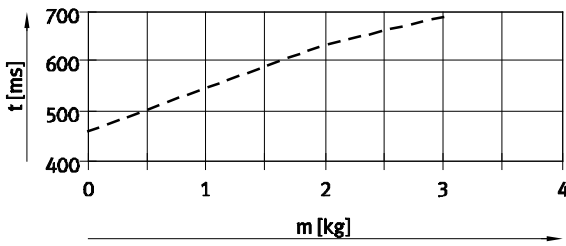

### Retracting

Stroke 200 mm, size 20

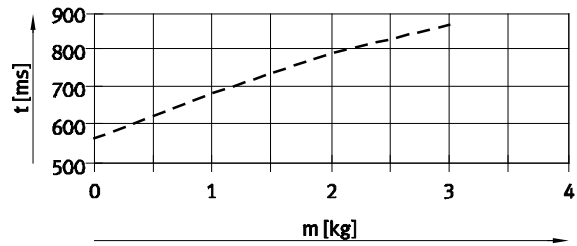

Stroke 200 mm, size 25

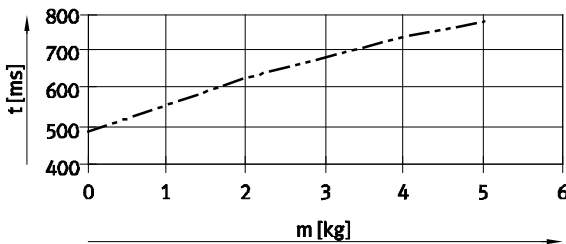

Stroke 200 mm, size 25

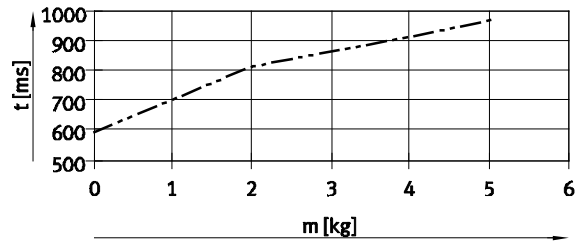

----- DGSL-N-20  
- - - - - DGSL-N-25

## Vertical mounting position

The travel times for a vertical mounting position are calculated by multiplying the data ascertained for horizontal mounting position by a correction factor  $k_a$  (advancing) and  $k_r$  (retracting), see adjacent table.

**Given:**  
Stroke = 200 mm  
Size = 20  
Effective load = 2 kg  
Ascertained travel time  $t_h$  (horizontal), see graph:  
– Advancing = 640 ms  
– Retracting = 780 ms  
Calculated travel time  $t_v$  (vertical):  
– Advancing:  $t_v = t_h \times k_a$   
 $t_v = 640 \text{ ms} \times 0.9 = 576 \text{ ms}$   
– Retracting:  $t_v = t_h \times k_r$   
 $t_v = 780 \text{ ms} \times 1.1 = 858 \text{ ms}$

Stroke [mm]	Size	Advancing ( $k_a$ ) <sup>1)</sup>	Retracting ( $k_r$ )
10	10	1	1.1
	12, 16, 20, 25	1.1	1.2
30	10	1	1.1
	12, 16, 20, 25	1.1	1.2
50	10, 12	1	1.1
	16, 20, 25	0.9	1.1
100	10, 12, 16, 20, 25	0.95	1.1
150	12, 16, 20, 25	0.95	1.1
200	20, 25	0.9	1.1

1) Downward.

# Mini slides DGSL-N, NPT

Technical data

## Shock absorber selection

Travel time  $t$  as a function of effective load  $m$  and cushioning Y3 – horizontal mounting position

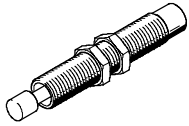

The values in the graphs are determined by calculation. The travel time as a function of effective load must not be reduced below

the values shown, because the kinetic impact or residual energy in the end positions can result in damage to the drive.

Vertical mounting position  
→ 25

### Advancing

Stroke 30 mm, size 10 ... 12

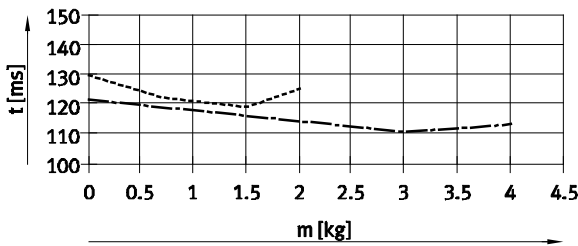

### Retracting

Stroke 30 mm, size 10 ... 12

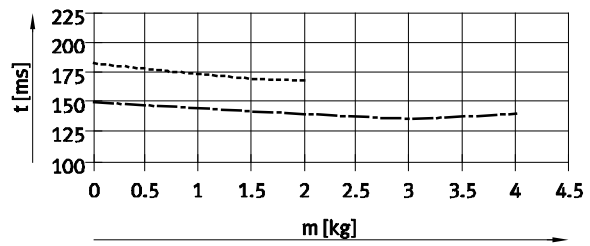

Stroke 30 mm, size 16 ... 25

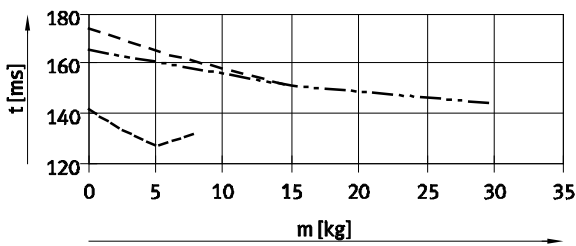

Stroke 30 mm, size 16 ... 25

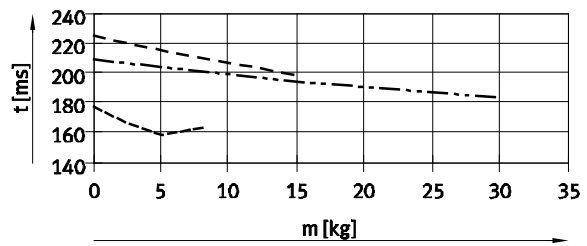

Stroke 50 mm, size 10 ... 12

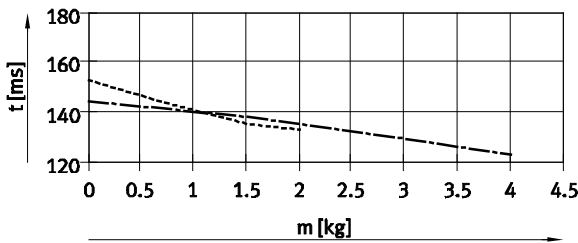

Stroke 50 mm, size 10 ... 12

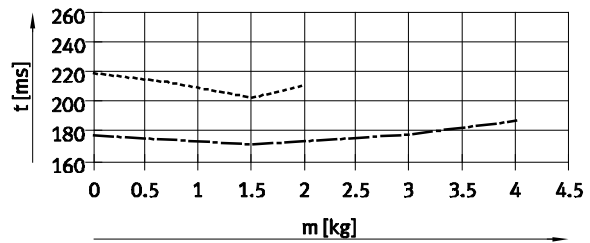

Stroke 50 mm, size 16 ... 25

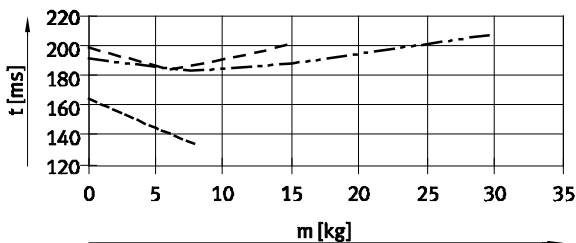

Stroke 50 mm, size 16 ... 25

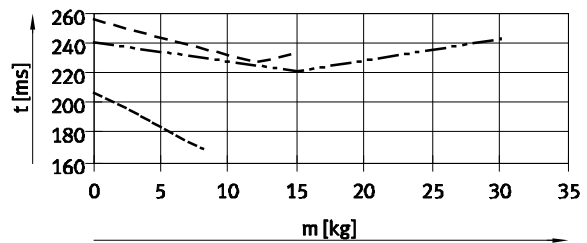

- ..... DGSL-N-10
- DGSL-N-12
- DGSL-N-16
- DGSL-N-20
- DGSL-N-25



# Mini slides DGSL-N, NPT

Technical data

## Shock absorber selection

Travel time  $t$  as a function of effective load  $m$  and cushioning Y3 – horizontal mounting position

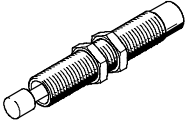

The values in the graphs are determined by calculation. The travel time as a function of effective load must not be reduced below

the values shown, because the kinetic impact or residual energy in the end positions can result in damage to the drive.

Vertical mounting position  
→ 25

### Advancing

Stroke 100 mm, size 10 ... 25

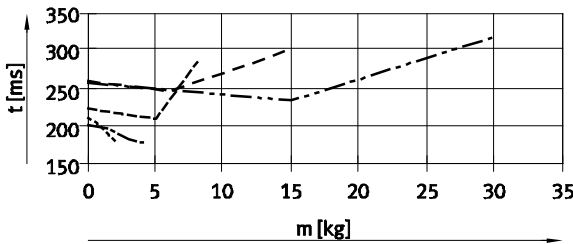

### Retracting

Stroke 100 mm, size 10 ... 25

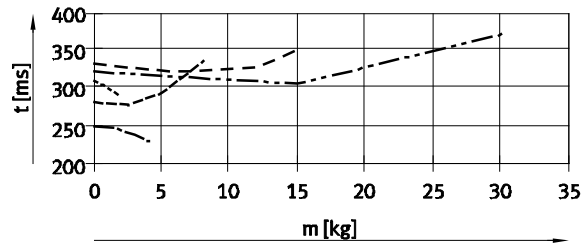

Stroke 150 mm, size 12 ... 25

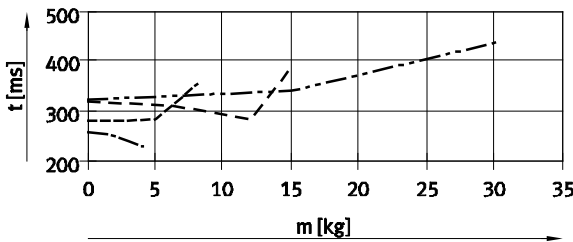

Stroke 150 mm, size 12 ... 25

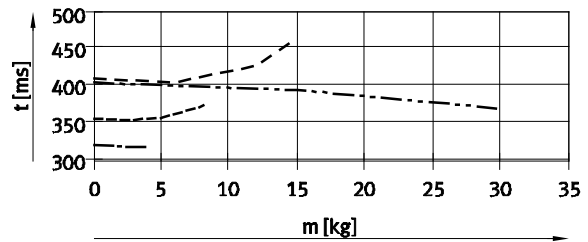

Stroke 200 mm, size 20 ... 25

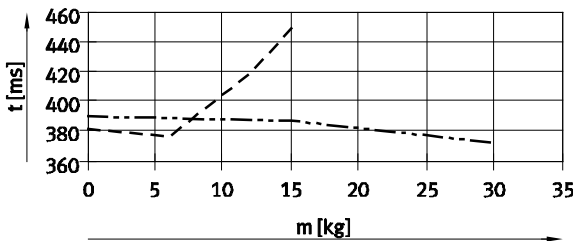

Stroke 200 mm, size 20 ... 25

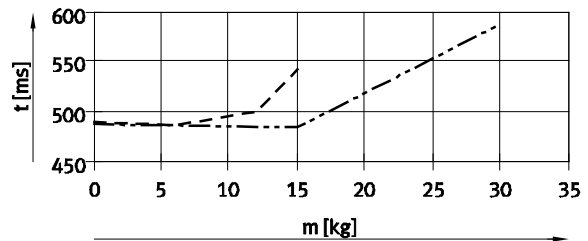

- DGSL-N-10
- DGSL-N-12
- DGSL-N-16
- DGSL-N-20
- DGSL-N-25

### Vertical mounting position

The travel times for a vertical mounting position are calculated by multiplying the data ascertained for horizontal mounting position by a correction factor  $k_a$  (advancing) and  $k_r$  (retracting), see adjacent table.

**Given:**  
 Stroke = 200 mm  
 Size = 20  
 Effective load = 10 kg  
 Ascertained travel time  $t_h$  (horizontal), see graph:  
 – Advancing = 405 ms  
 – Retracting = 490 ms  
 Calculated travel time  $t_v$  (vertical):  
 – Advancing:  $t_v = t_h \times k_a$   
 $t_v = 405 \text{ ms} \times 0.9 = 365 \text{ ms}$   
 – Retracting:  $t_v = t_h \times k_r$   
 $t_v = 490 \text{ ms} \times 1.5 = 735 \text{ ms}$

Stroke [mm]	Size	Advancing ( $k_a$ ) <sup>1)</sup>	Retracting ( $k_r$ )
30	10, 12	0.95	1.2
	16, 20, 25	0.9	1.5
50	10, 12	0.9	1.5
	16, 20, 25	0.9	1.5
100	10, 12, 16, 20, 25	0.8	1.5
150	12, 16, 20, 25	0.9	1.5
200	20, 25	0.9	1.5

1) Downward.

# Mini slides DGSL-N, NPT

Technical data

## Dynamic characteristic load values

Torques are indicated with reference to the centre of the guide.  
These values must not be exceeded during dynamic operation. Special attention must be paid to the cushioning phase.

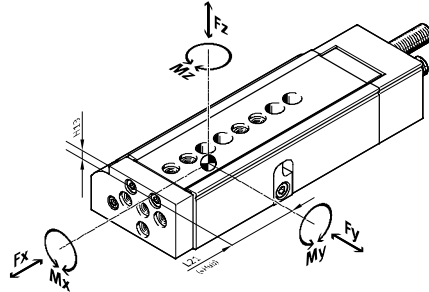

If the drive is simultaneously subjected to several of the indicated forces and torques, the following equation must be satisfied in addition to the indicated maximum loads:

$$\frac{|F_y|}{F_{y_{max}}} + \frac{|F_z|}{F_{z_{max}}} + \frac{|M_x|}{M_{x_{max}}} + \frac{|M_y|}{M_{y_{max}}} + \frac{|M_z|}{M_{z_{max}}} \leq 1$$

## Position of the guide centre

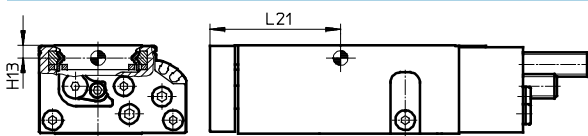

## Calculation example

Given:

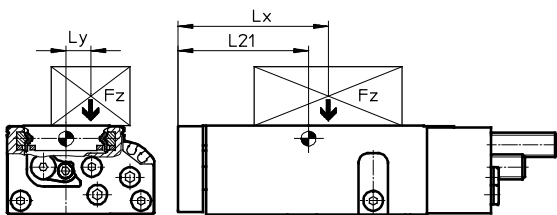

Mini slide = DGSL-N-10  
Stroke length = 80 mm  
Lever arm  $L_x$  = 50 mm  
Lever arm  $L_y$  = 30 mm  
Load  $F_z$  = 0.8 kg  
Acceleration  $a$  = 0 m/s<sup>2</sup>

To be calculated:

$F_y, F_z, M_x, M_y, M_z$   
and  
verification of operation  
with combined load

Solution:

$L_{21} = 83$  mm from table

$F_y = 0$  N

$F_z = m \times g$   
 $= 0.8 \text{ kg} \times 9.81 \text{ m/s}^2 = 7.848$  N

$M_x = m \times g \times L_y$   
 $= 0.8 \text{ kg} \times 9.81 \text{ m/s}^2 \times 30 \text{ mm} = 0.236$  Nm

$M_y = m \times g \times [(L_{21} + \text{stroke}) - L_x]$   
 $= 0.8 \text{ kg} \times 9.81 \text{ m/s}^2 \times [(83 \text{ mm} + 80 \text{ mm}) - 50 \text{ mm}] = 0.886$  Nm

$M_z = 0$  Nm

Combined load:

$$\frac{|F_y|}{F_{y_{max}}} + \frac{|F_z|}{F_{z_{max}}} + \frac{|M_x|}{M_{x_{max}}} + \frac{|M_y|}{M_{y_{max}}} + \frac{|M_z|}{M_{z_{max}}} = 0 + \frac{7.848 \text{ N}}{1200 \text{ N}} + \frac{0.236 \text{ Nm}}{18 \text{ Nm}} + \frac{0.886 \text{ Nm}}{12 \text{ Nm}} + 0 = 0.094 \leq 1$$

# Mini slides DGSL-N, NPT

Technical data

FESTO

Permissible forces and torques						Geometric characteristics	
Size	Stroke [mm]	F <sub>y</sub> max [N]	F <sub>z</sub> max [N]	M <sub>x</sub> max [Nm]	M <sub>y</sub> max, M <sub>z</sub> max [Nm]	H13 [mm]	L21 [mm]
<b>10</b>							
	10	927	927	15	6	4.2	43
	20	1,003	1,003	15	7		46
	30	1,078	1,078	15	8		51
	40	1,152	1,152	15	9		56
	50	1,175	1,175	18	9		61
	80	1,200	1,200	18	12		83
	100	1,250	1,250	18	12		96
<b>12</b>							
	10	942	942	15	8	5.2	44
	20	1,006	1,006	15	9		49
	30	1,075	1,075	15	10		54
	40	1,142	1,142	18	11		59
	50	1,200	1,200	18	12		64
	80	1,280	1,280	20	15		88
	100	1,340	1,340	20	15		98
	150	1,400	1,400	20	15		124
<b>16</b>							
	10	1,769	1,769	35	20	6.4	54
	20	2,021	2,021	35	22		59
	30	2,274	2,274	35	22		64
	40	2,527	2,527	40	25		69
	50	2,780	2,780	40	25		74
	80	2,800	2,800	50	27		89
	100	2,850	2,850	50	43		113
	150	2,900	2,900	50	43		138
<b>20</b>							
	10	2,911	2,911	60	30	7.55	56
	20	3,143	3,143	60	30		61
	30	3,354	3,354	60	30		66
	40	3,612	3,612	60	40		71
	50	3,816	3,816	70	50		76
	80	4,032	4,032	80	50		91
	100	4,200	4,200	85	80		121
	150	4,400	4,400	90	80		152
	200	4,600	4,600	90	80	177	
<b>25</b>							
	10	3,270	3,270	100	60	8.55	64
	20	3,744	3,744	100	60		69
	30	4,205	4,205	100	60		74
	40	4,643	4,643	110	60		79
	50	4,650	4,650	120	60		84
	80	4,700	4,700	130	80		112
	100	4,750	4,750	130	80		129
	150	4,800	4,800	130	80		154
	200	4,800	4,800	130	80	179	

# Mini slides DGSL-N, NPT

Technical data

FESTO

## Dimensions

Download CAD data → [www.festo.com](http://www.festo.com)

Size 10

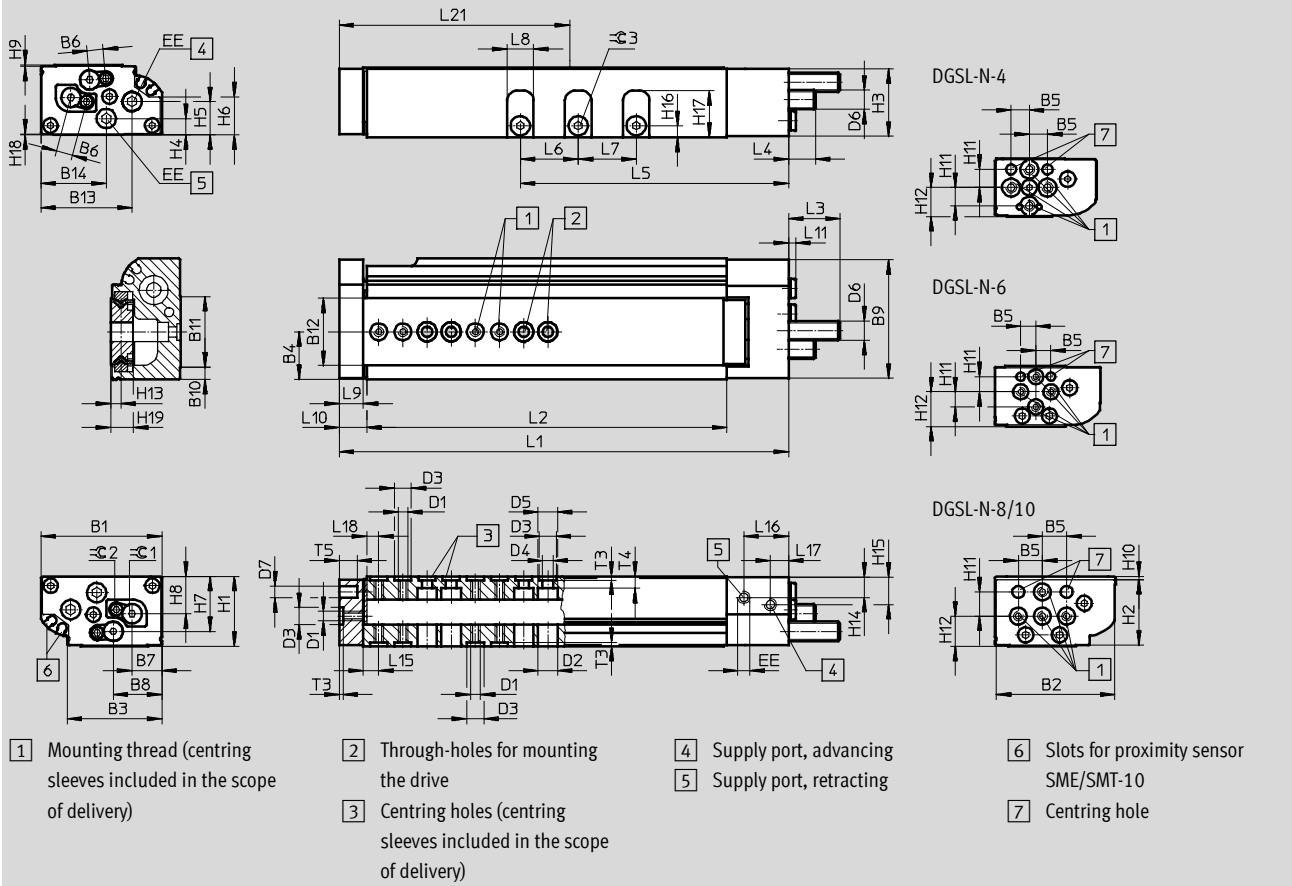

## General dimensions

Size	B1	B2	B3	B4	B5	B6	B7	B8	B9	B10	B11	B12	B13	B14	D1
10	50	49	39.2	19.65	10	6.8	12.35	20.1	49	5	29.2	28	37.7	27	M4

Size	D2	D3	D4	D5	D6	D7	EE <sup>1)</sup>	H1	H2	H3	H4	H5	H6	H7	H8	
10	8	7 <sup>H7</sup>	4.3	8	M8x1	5 <sup>H7</sup>	M5	±0.08	29	27.1	28	6.8	13.8	15.8	22.8	15.5

Size	H9	H10	H11	H12	H13	H14	H15	H16	H17	H18	H19	T3	T4	T5	⊖ 2 <sup>1)</sup>	⊖ 3
10	0.6	1.4	10	12.5	4.2	8.75	11.75	4.8	19.25	0.4	9	1.6	5	7.5	2.5	3

1) Suitable for 10-32 UNF

# Mini slides DGSL-N, NPT

Technical data



Stroke-dependent dimensions															
Size	Stroke	L1	L2	L5	L6	L7	L8	L9	L10	L11	L15 ±0.05	L16	L17	L18 ±0.05	L21
10	10	103.1	66	41.3	-	-	11	10	11.6	2.5	6.4	18.5	7	5	43
	20	112.8	75.7	51											46
	30	122.8	85.7	61											51
	40	132.8	95.7	71											56
	50	142.8	105.7	81											61
	80	186.2	149.1	111											24
	100	206.2	169.1	131	24	24	96								

Cushioning-dependent dimensions					
Size	Cushioning	L3 max.	L4 max.	±0.1	
				For adjusting the cushioning stroke	For adjusting the end position
10	P	22.8	12.5	-	2.5
	E	8.8	0	-	2.5
	P1	20.5	10.2	2.5	5
	Y3	25.5	14.9	-	2.5
	Y11	30.4	19.9	-	2

## Hole pattern for mounting threads and centring holes

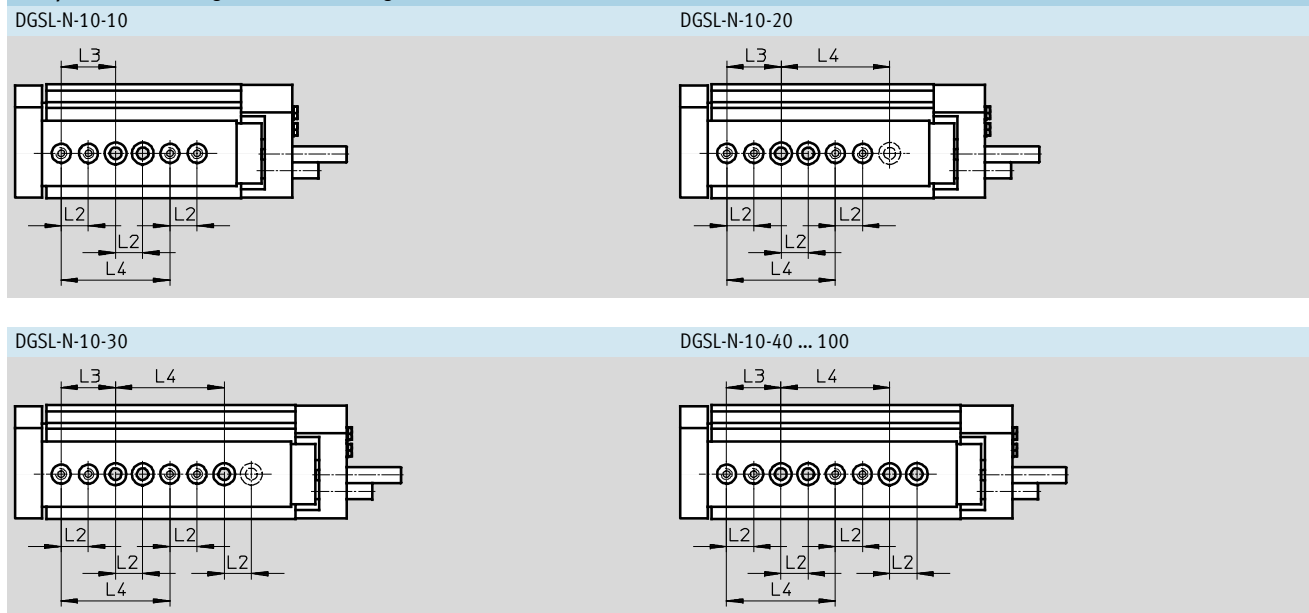

## Distances from yoke plate to mounting threads and centring holes

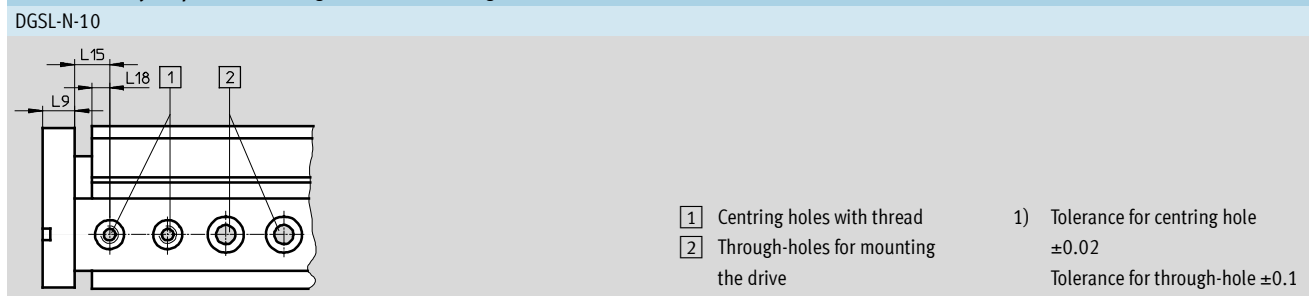

Size	L2 <sup>1)</sup>	L3 <sup>1)</sup>	L4 <sup>1)</sup>	L9	L15 ±0.05	L18
10	10	20	40	10	6.4	5

# Mini slides DGSL-N, NPT

Technical data

FESTO

## Dimensions

Download CAD data → [www.festo.com](http://www.festo.com)

Size 12/16

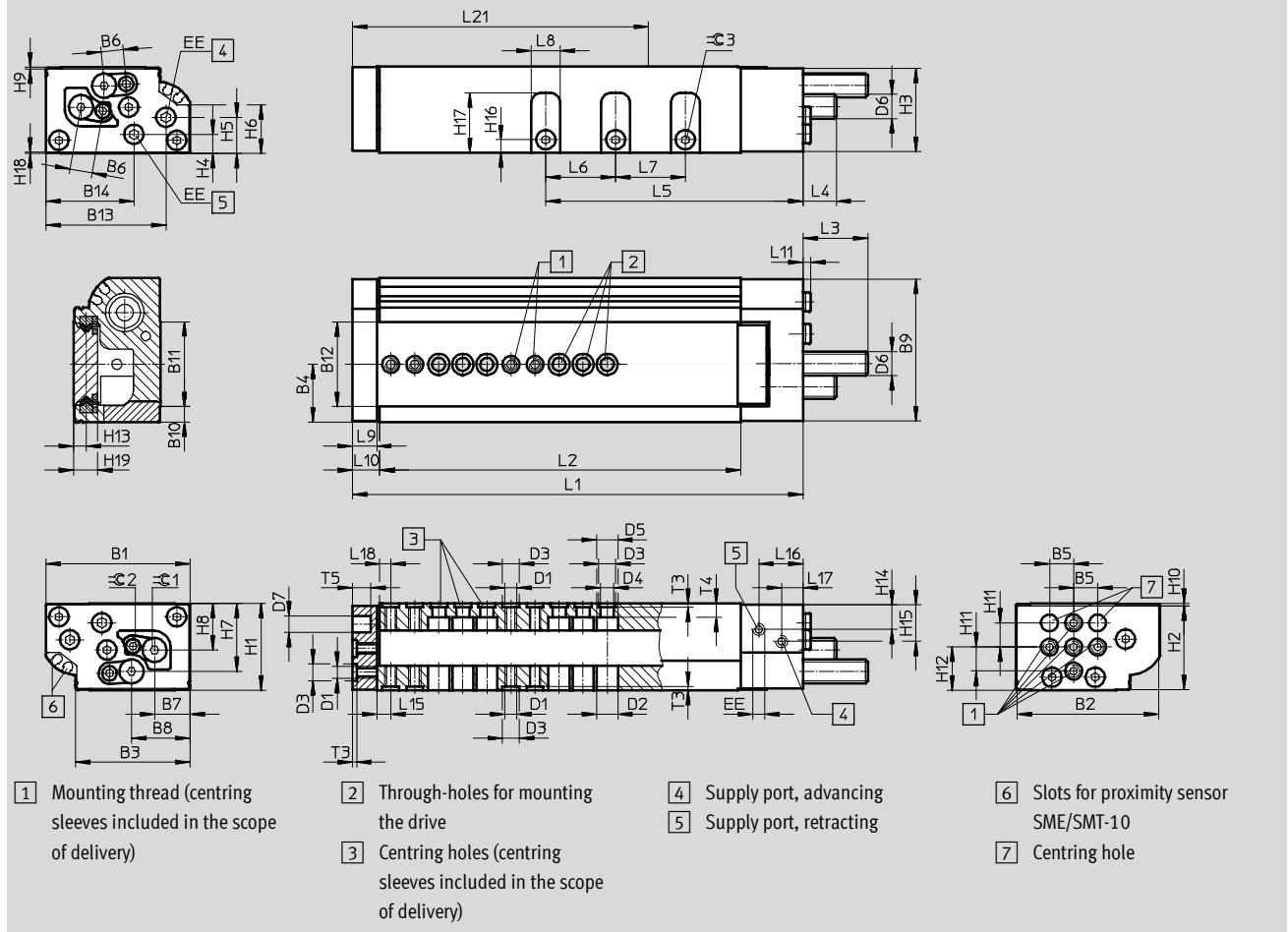

## General dimensions

Size	B1	B2	B3	B4	B5	B6	B7	B8	B9	B10	B11	B12	B13	B14	D1
12	60	59	47.6	24	10	9.2	14.7	24.3	59	6.4	35.35	35.2	50	36.7	M5
16	66	65	53.5	26.7	10	11.1	16.7	27.5	65	7.75	37.9	38	50.4	36.7	M5

Size	D2	D3	D4	D5	D6	D7	EE <sup>1)</sup>	H1	H2	H3	H4	H5	H6	H7	H8
	∅	∅	∅	∅		∅		±0.08							
12	8.8	7 <sup>H7</sup>	5.5	8.8	M10x1	8 <sup>H7</sup>	M5	36	34.8	34.7	8	15.1	20.35	28.2	19.3
16	8.8	7 <sup>H7</sup>	5.5	9.2	M12x1	8 <sup>H7</sup>	M5	40	38	39	8.5	16.7	20.6	31.7	20.8

Size	H9	H10	H11	H12	H13	H14	H15	H16	H17	H18	H19	T3	T4	T5	∅ 2	∅ 3
												+0.1				
12	0.8	0.95	10	17.9	5.2	10.75	15.75	5.5	24.9	0.5	10	1.6	5.6	7.5	3	3
16	0.5	1.5	10	20	6.4	10.5	16.7	7	26.6	0.5	12.4	1.6	6.1	9	4	4

1) Suitable for 10-32 UNF

# Mini slides DGSL-N, NPT

Technical data

FESTO

Stroke-dependent dimensions															
Size	Stroke	L1	L2	L5	L6	L7	L8	L9	L10	L11	L15 ±0.05	L16	L17	L18 ±0.05	L21
12	10	106.2	68.6	42.4	-	-	12	10	11.6	2.5	5.8	18.5	7.5	4.5	44
	20	116.2	78.6	52.4											49
	30	126.2	88.6	62.4											54
	40	136.2	98.6	72.4											59
	50	146.2	108.6	82.4											64
	80	197.6	160	112.4	29	29	88								
	100	217.6	180	132.4			98								
	150	267.6	230	182.4			124								
16	10	124.1	82.5	45	-	-	14	12	13.6	2.5	6.8	21	7	5.5	54
	20	134.6	93	54.6											59
	30	144.6	103	64.6											64
	40	154.6	113	74.6											69
	50	164.6	123	84.6											74
	80	194.6	153	114.6	35	89									
	100	243.6	202	134.6		113									
	150	293.6	252	184.6		138									

Cushioning-dependent dimensions					
Size	Cushioning	L3 max.	L4 max.	≈ 1	
				For adjusting the cushioning stroke	For adjusting the end position
12	P	28.1	14.9	-	3
	E	8.8	0	-	3
	P1	26	12.8	3	6
	Y3	36.9	23.7	-	3
	Y11	42.2	18.7	-	2.5
16	P	42.3	26.1	-	4
	E	8.8	0	-	4
	P1	40	23.8	4	8
	Y3	51.9	35.7	-	4
	Y11	55.4	38.9	-	3

# Mini slides DGSL-N, NPT

Technical data

## Hole pattern for mounting threads and centring holes

DGSL-N-12-10

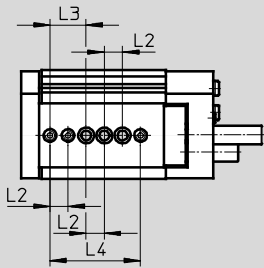

DGSL-N-12-20

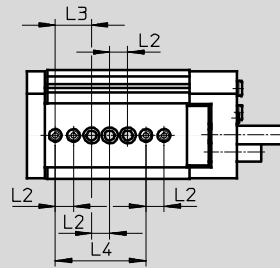

DGSL-N-12-30

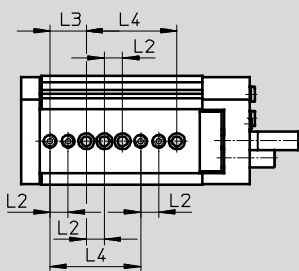

DGSL-N-12-40

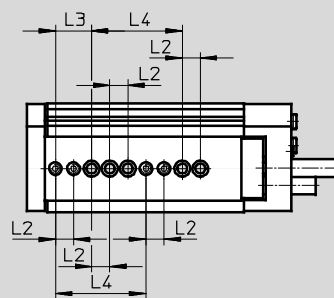

DGSL-N-12-50 ... 100

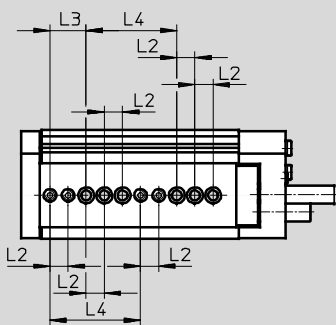

DGSL-N-12-150

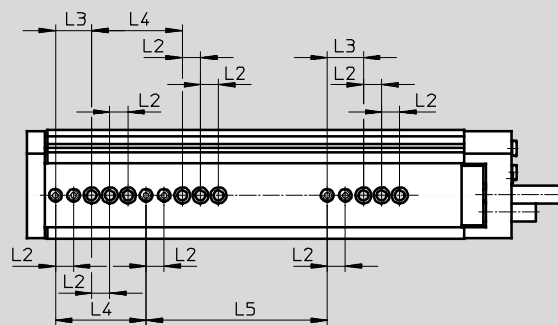

DGSL-N-16-10

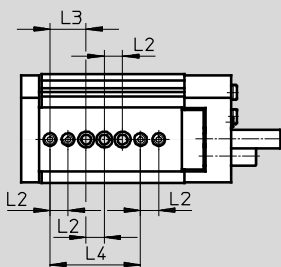

DGSL-N-16-20

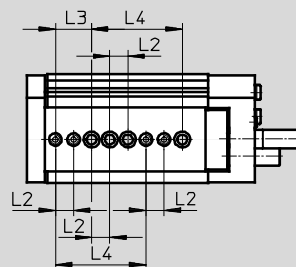



# Mini slides DGSL-N, NPT

Technical data

## Hole pattern for mounting threads and centring holes

DGSL-N-16-30

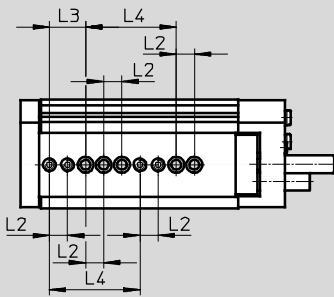

DGSL-N-16-40 ... 100

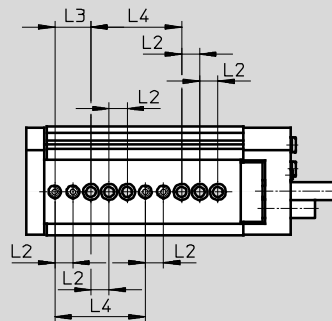

DGSL-N-16-150

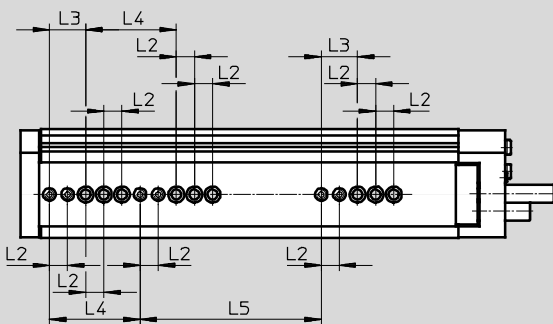

## Distances from yoke plate to mounting threads and centring holes

DGSL-N-12/16

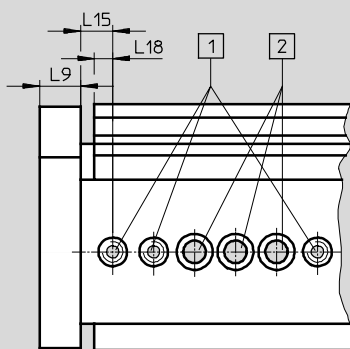

- 1 Centring holes with thread
- 2 Through-holes for mounting the drive

- 1) Tolerance for centring hole  $\pm 0.02$
- Tolerance for through-hole  $\pm 0.1$

Size	L2 <sup>1)</sup>	L3 <sup>1)</sup>	L4 <sup>1)</sup>	L5 $\pm 0.03$	L9	L15 $\pm 0.05$	L18
12	10	20	50	100	10	5.8	4.5
16	10	20	50	100	12	6.8	5.5

# Mini slides DGSL-N, NPT

Technical data

FESTO

## Dimensions

Download CAD data → [www.festo.com](http://www.festo.com)

Size 20/25

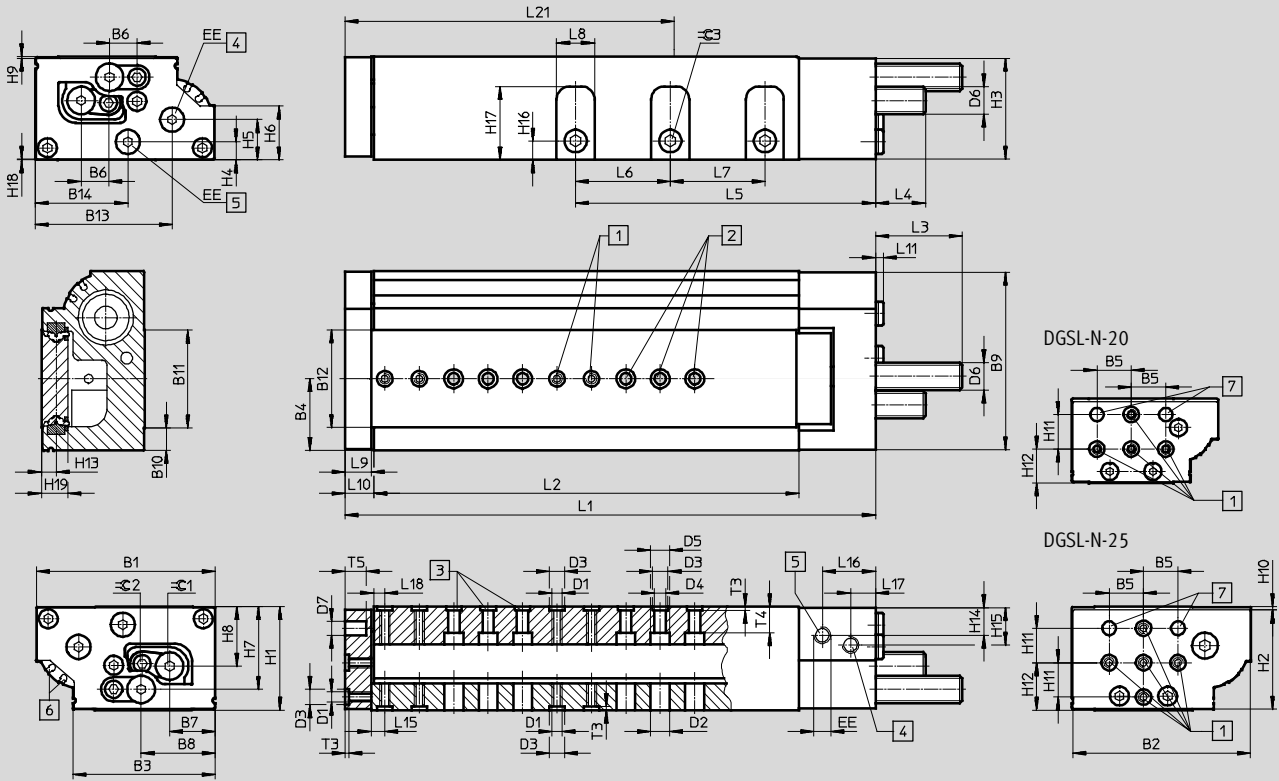

- 1 Mounting thread (centring sleeves included in the scope of delivery)
- 2 Through-holes for mounting the drive
- 3 Centring holes (centring sleeves included in the scope of delivery)
- 4 Supply port, advancing
- 5 Supply port, retracting
- 6 Slots for proximity sensor SME/SMT-10
- 7 Centring hole

## General dimensions

Size	B1	B2	B3	B4	B5	B6	B7	B8	B9	B10	B11	B12	B13	B14	D1
20	85	84	68.85	34.5	20	14	21.4	36.35	83.4	10	48.9	49.2	64.1	48.6	M6
25	104	103	82.6	41.6	20	16.2	26.4	43.1	103	13.25	56.5	56.7	79.4	53.7	M6

Size	D2	D3	D4	D5	D6	D7	EE	H1	H2	H3	H4	H5	H6	H7	H8
	∅	∅	∅	∅		∅		±0.08							
20	11	9 <sup>H7</sup>	6.6	11	M14x1	8 <sup>H7</sup>	1/8 NPT	49	46.5	47.7	10.3	20.6	23.2	38.2	26.1
25	11	9 <sup>H7</sup>	6.6	11	M16x1	8 <sup>H7</sup>	1/8 NPT	60	57.5	58.5	10.5	23.4	31.2	48	34.5

Size	H9	H10	H11	H12	H13	H14	H15	H16	H17	H18	H19	T3	T4	T5	∠ 2	∠ 3
												+0.1				
20	0.5	2	20	19.6	7.55	14.7	14.7	10	33.3	0.8	14.5	2.1	8.8	10	4	5
25	1	2	20	27.5	8.55	16.6	22.2	11	42.7	0.5	15.5	2.1	15.1	12	5	6

# Mini slides DGSL-N, NPT

Technical data



Stroke-dependent dimensions																
Size	Stroke	L1	L2	L5	L6	L7	L8	L9	L10	L11	L15 ±0.05	L16	L17	L18 ±0.05	L21	
20	10	141.2	84.6	59.1	-	-	17	14	15.6	4.6	7.8	29.3	10.5	6.5	56	
	20	151.2	94.6	69.1											61	
	30	161.2	104.6	79.1											66	
	40	171.2	114.6	89.1											71	
	50	183.2	126.6	99.1											76	
	80	211.2	154.6	129.1											91	
	100	270.2	213.6	149.1											44	121
	150	333.2	276.6	199.1	152											
	200	383.2	326.6	252.1	44	177										
25	10	157.1	96	63.7	-	-	22	15	16.6	4.6	8	30.9	12.2	6.5	64	
	20	167.1	106	72.2											69	
	30	177.1	116	82.2											74	
	40	187.1	126	92.2											79	
	50	197.1	136	102.2											84	
	80	253.1	192	132.2											55	112
	100	286.1	225	152.2												129
	150	338.1	277	202.2	154											
	200	388.1	327	254.2	179											

Cushioning-dependent dimensions					
Size	Cushioning	L3 max.	L4 max.	≈ 1	
				For adjusting the cushioning stroke	For adjusting the end position
20	P	52.4	31.2	-	4
	E	8.8	0	-	4
	P1	50.1	28.9	4	8
	Y3	55.5	34.3	-	4
	Y11	67.4	45.9	-	4
25	P	51.9	30.5	-	5
	E	8.8	0	-	5
	P1	49.6	28.2	5	10
	Y3	65.2	43.8	-	5
	Y11	78.4	56.9	-	4

# Mini slides DGSL-N, NPT

Technical data

## Hole pattern for mounting threads and centring holes

DGSL-N-20-10/20

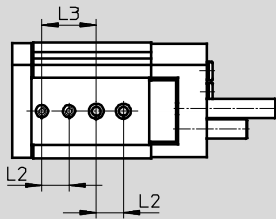

DGSL-N-20-30/40

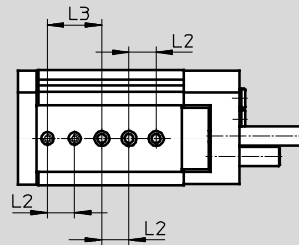

DGSL-N-20-50

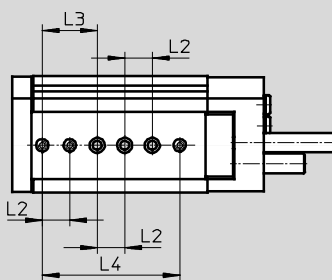

DGSL-N-20-80

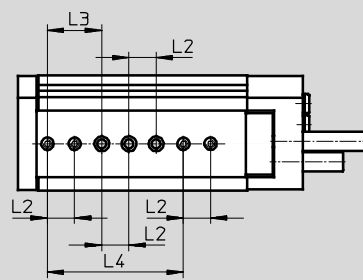

DGSL-N-20-100 ... 200

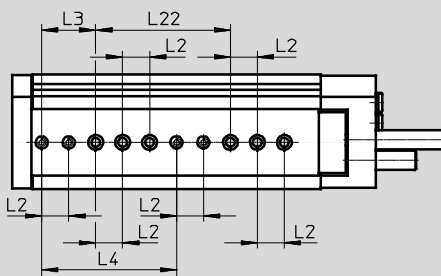

DGSL-N-25-10

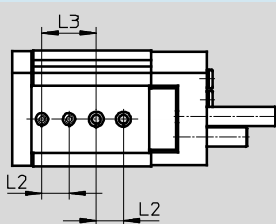

DGSL-N-25-20

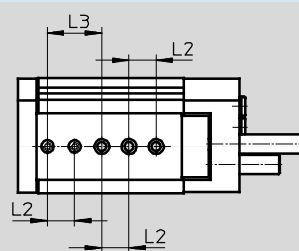

# Mini slides DGSL-N, NPT

Technical data

## Hole pattern for mounting threads and centring holes

DGSL-N-25-30/40

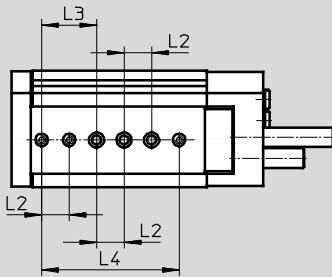

DGSL-N-25-50

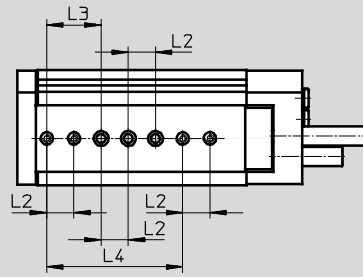

DGSL-N-25-80

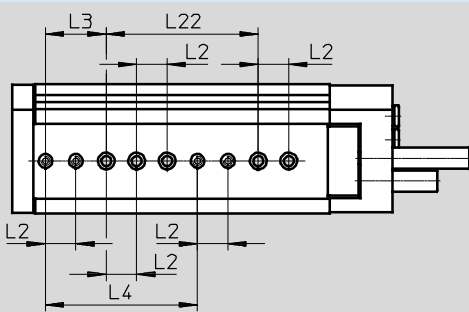

DGSL-N-25-100 ... 200

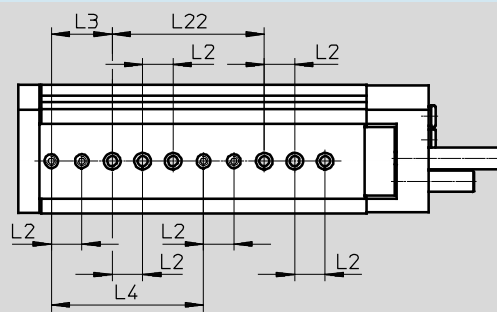

## Distances from yoke plate to mounting threads and centring holes

DGSL-N-20/25

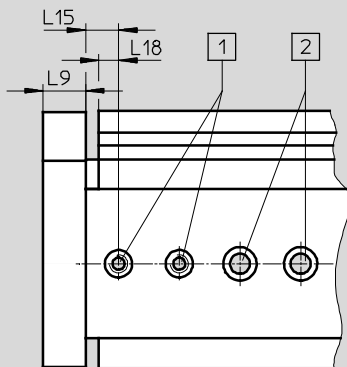

- 1 Centring holes with thread
- 2 Through-holes for mounting the drive

Size	L2 <sup>1)</sup>	L3 <sup>1)</sup>	L4	L9	L15 ±0.05	L18	L22
20	20	40	100 <sup>1)</sup>	14	7.8	6.5	100±0.03
25	20	40	100±0.03	15	8	6.5	100 <sup>1)</sup>

1) Tolerance for centring hole ±0,02  
Tolerance for through-hole ±0,1

# Mini slides DGSL-N, NPT

Technical data

Ordering data				Ordering data			
Size	Stroke [mm]	Part No.	Type	Size	Stroke [mm]	Part No.	Type
With cushioning P				With cushioning E			
10	10	566258	DGSL-N-10-10-PA	10	10	570213	DGSL-N-10-10-EA
	20	566259	DGSL-N-10-20-PA		20	570214	DGSL-N-10-20-EA
	30	566260	DGSL-N-10-30-PA		30	570215	DGSL-N-10-30-EA
	40	566261	DGSL-N-10-40-PA		40	570216	DGSL-N-10-40-EA
	50	566262	DGSL-N-10-50-PA		50	570217	DGSL-N-10-50-EA
	80	566263	DGSL-N-10-80-PA		80	570218	DGSL-N-10-80-EA
	100	566264	DGSL-N-10-100-PA		100	570219	DGSL-N-10-100-EA
12	10	566265	DGSL-N-12-10-PA	12	10	570220	DGSL-N-12-10-EA
	20	566266	DGSL-N-12-20-PA		20	570221	DGSL-N-12-20-EA
	30	566267	DGSL-N-12-30-PA		30	570222	DGSL-N-12-30-EA
	40	566268	DGSL-N-12-40-PA		40	570223	DGSL-N-12-40-EA
	50	566269	DGSL-N-12-50-PA		50	570224	DGSL-N-12-50-EA
	80	566270	DGSL-N-12-80-PA		80	570225	DGSL-N-12-80-EA
	100	566271	DGSL-N-12-100-PA		100	570226	DGSL-N-12-100-EA
16	10	566273	DGSL-N-16-10-PA	16	10	570228	DGSL-N-16-10-EA
	20	566274	DGSL-N-16-20-PA		20	570229	DGSL-N-16-20-EA
	30	566275	DGSL-N-16-30-PA		30	570230	DGSL-N-16-30-EA
	40	566276	DGSL-N-16-40-PA		40	570231	DGSL-N-16-40-EA
	50	566277	DGSL-N-16-50-PA		50	570232	DGSL-N-16-50-EA
	80	566278	DGSL-N-16-80-PA		80	570233	DGSL-N-16-80-EA
	100	566279	DGSL-N-16-100-PA		100	570234	DGSL-N-16-100-EA
20	10	566281	DGSL-N-20-10-PA	20	10	570236	DGSL-N-20-10-EA
	20	566282	DGSL-N-20-20-PA		20	570237	DGSL-N-20-20-EA
	30	566283	DGSL-N-20-30-PA		30	570238	DGSL-N-20-30-EA
	40	566284	DGSL-N-20-40-PA		40	570239	DGSL-N-20-40-EA
	50	566285	DGSL-N-20-50-PA		50	570240	DGSL-N-20-50-EA
	80	566286	DGSL-N-20-80-PA		80	570241	DGSL-N-20-80-EA
	100	566287	DGSL-N-20-100-PA		100	570242	DGSL-N-20-100-EA
25	10	566290	DGSL-N-25-10-PA	25	10	570245	DGSL-N-25-10-EA
	20	566291	DGSL-N-25-20-PA		20	570246	DGSL-N-25-20-EA
	30	566292	DGSL-N-25-30-PA		30	570247	DGSL-N-25-30-EA
	40	566293	DGSL-N-25-40-PA		40	570248	DGSL-N-25-40-EA
	50	566294	DGSL-N-25-50-PA		50	570249	DGSL-N-25-50-EA
	80	566295	DGSL-N-25-80-PA		80	570250	DGSL-N-25-80-EA
	100	566296	DGSL-N-25-100-PA		100	570251	DGSL-N-25-100-EA
	150	566297	DGSL-N-25-150-PA		150	570252	DGSL-N-25-150-EA
	200	566298	DGSL-N-25-200-PA		200	570253	DGSL-N-25-200-EA

# Mini slides DGSL-N, NPT

Technical data

Ordering data				Ordering data			
Size	Stroke [mm]	Part No.	Type	Size	Stroke [mm]	Part No.	Type
With cushioning P1				With cushioning Y3			
10	10	566299	DGSL-N-10-10-P1A	10	10	-	
	20	566300	DGSL-N-10-20-P1A		20	-	
	30	566301	DGSL-N-10-30-P1A		30	566340	DGSL-N-10-30-Y3A
	40	566302	DGSL-N-10-40-P1A		40	566341	DGSL-N-10-40-Y3A
	50	566303	DGSL-N-10-50-P1A		50	566342	DGSL-N-10-50-Y3A
	80	566304	DGSL-N-10-80-P1A		80	566343	DGSL-N-10-80-Y3A
	100	566305	DGSL-N-10-100-P1A		100	566344	DGSL-N-10-100-Y3A
12	10	566306	DGSL-N-12-10-P1A	12	10	-	
	20	566307	DGSL-N-12-20-P1A		20	-	
	30	566308	DGSL-N-12-30-P1A		30	566345	DGSL-N-12-30-Y3A
	40	566309	DGSL-N-12-40-P1A		40	566346	DGSL-N-12-40-Y3A
	50	566310	DGSL-N-12-50-P1A		50	566347	DGSL-N-12-50-Y3A
	80	566311	DGSL-N-12-80-P1A		80	566348	DGSL-N-12-80-Y3A
	100	566312	DGSL-N-12-100-P1A		100	566349	DGSL-N-12-100-Y3A
16	10	566314	DGSL-N-16-10-P1A	16	10	-	
	20	566315	DGSL-N-16-20-P1A		20	-	
	30	566316	DGSL-N-16-30-P1A		30	566351	DGSL-N-16-30-Y3A
	40	566317	DGSL-N-16-40-P1A		40	566352	DGSL-N-16-40-Y3A
	50	566318	DGSL-N-16-50-P1A		50	566353	DGSL-N-16-50-Y3A
	80	566319	DGSL-N-16-80-P1A		80	566354	DGSL-N-16-80-Y3A
	100	566320	DGSL-N-16-100-P1A		100	566355	DGSL-N-16-100-Y3A
20	10	566322	DGSL-N-20-10-P1A	20	10	-	
	20	566323	DGSL-N-20-20-P1A		20	-	
	30	566324	DGSL-N-20-30-P1A		30	566357	DGSL-N-20-30-Y3A
	40	566325	DGSL-N-20-40-P1A		40	566358	DGSL-N-20-40-Y3A
	50	566326	DGSL-N-20-50-P1A		50	566359	DGSL-N-20-50-Y3A
	80	566327	DGSL-N-20-80-P1A		80	566360	DGSL-N-20-80-Y3A
	100	566328	DGSL-N-20-100-P1A		100	566361	DGSL-N-20-100-Y3A
25	10	566331	DGSL-N-25-10-P1A	25	10	-	
	20	566332	DGSL-N-25-20-P1A		20	-	
	30	566333	DGSL-N-25-30-P1A		30	566364	DGSL-N-25-30-Y3A
	40	566334	DGSL-N-25-40-P1A		40	566365	DGSL-N-25-40-Y3A
	50	566335	DGSL-N-25-50-P1A		50	566366	DGSL-N-25-50-Y3A
	80	566336	DGSL-N-25-80-P1A		80	566367	DGSL-N-25-80-Y3A
	100	566337	DGSL-N-25-100-P1A		100	566368	DGSL-N-25-100-Y3A
150	566338	DGSL-N-25-150-P1A	150	566369	DGSL-N-25-150-Y3A		
200	566339	DGSL-N-25-200-P1A	200	566370	DGSL-N-25-200-Y3A		

# Mini slides DGSL-N, NPT

Wearing parts kits and accessories



Ordering data – Wearing parts kits		
Size	Part No.	Type
10	713746	DGSL-10-...
12	713747	DGSL-12-...
16	713748	DGSL-16-...
20	713749	DGSL-20-...
25	713750	DGSL-25-...

## Cover DADS

Materials:  
Anodised aluminium  
Free of copper, PTFE and silicone  
RoHS-compliant

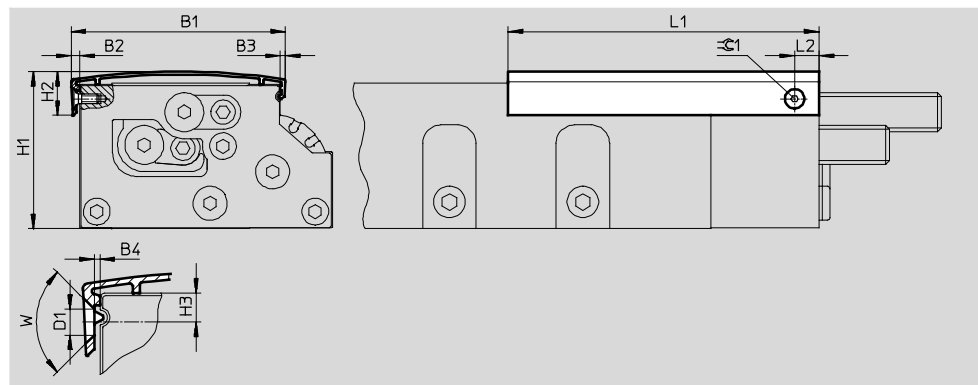

Dimensions and ordering data																
For size	Length [mm]	B1	B2	B3	B4	D1	H1	H2	H3	L1	L2	W	∅C1	Weight [g]	Part No.	Type
10	50	43.6	2.8	2.2	1.2	3.4	32	12	3.4	70	10	90°	2	11	1162400	DADS-AB-G6-10-50
	120									18				1090689	DADS-AB-G6-10-100	
	500									75				1212479	DADS-AB-G6-10-500	
12	50	51.7	2.7	2	0.5	3.4	38.8	12.8	4.25	72	10	90°	2	12	1162406	DADS-AB-G6-12-50
	170									28				1090732	DADS-AB-G6-12-150	
	500									82				1212480	DADS-AB-G6-12-500	
16	50	60	4.3	3.1	2.25	3.4	43.7	15.2	5	73	10	90°	2	21	1162410	DADS-AB-G6-16-50
	173									49				1066591	DADS-AB-G6-16-150	
	500									141				1212503	DADS-AB-G6-16-500	
20	50	74.8	3.6	2.8	1.2	4.4	53.2	18.9	6.5	74	10	90°	2.5	28	1162412	DADS-AB-G6-20-50
	124									46				1162415	DADS-AB-G6-20-100	
	224									83				1090823	DADS-AB-G6-20-200	
	500									184				1212521	DADS-AB-G6-20-500	
25	50	88.4	3.5	2.7	0.7	4.4	64.7	18.3	6	78	10	90°	2.5	34	1162417	DADS-AB-G6-25-50
	128									55				1162419	DADS-AB-G6-25-100	
	228									98				1090895	DADS-AB-G6-25-200	
	500									213				1212523	DADS-AB-G6-25-500	







- - Note  
With the 500 mm covers, the mounting hole must be made by the customer.  
The cover can be trimmed as required by the customer.



# Mini slides DGSL-N, NPT

Accessories

FESTO



Ordering data						
	For size	Brief description	Order code	Part No.	Type	PU <sup>1)</sup>
Centring sleeve ZBH <span style="float: right;">Technical data → Internet: zbh</span>						
	10, 12, 16	For centring loads and attachments (the scope of delivery of the mini slide includes six centring sleeves)	-	186717	ZBH-7	10
	20, 25			150927	ZBH-9	
Connector sleeve ZBV <span style="float: right;">Technical data → Internet: zbv</span>						
	10	<ul style="list-style-type: none"> <li>For connecting two mini slides DGSL</li> <li>Sizing information refers to the y axis</li> </ul>	-	548802	ZBV-M4-7	3
	12, 16			548803	ZBV-M5-7	
	20, 25			548804	ZBV-M6-9	
Shock absorber DYEF-...-Y1 <span style="float: right;">Technical data → Internet: dyef</span>						
	10	Flexible cushioning, without metal stop	P	1179834	DYEF-M8-Y1	1
	12			1179837	DYEF-M10-Y1	
	16			1179840	DYEF-M12-Y1	
	20			1179863	DYEF-M14-Y1	
	25			1179879	DYEF-M16-Y1	
Shock absorber DYEF-S-...-Y1 <span style="float: right;">Technical data → Internet: dyef</span>						
	10	Flexible cushioning, without metal stop, short design	E	1152536	DYEF-S-M8-Y1	1
	12			1152959	DYEF-S-M10-Y1	
	16			1153004	DYEF-S-M12-Y1	
	20			1153017	DYEF-S-M14-Y1	
	25			1153023	DYEF-S-M16-Y1	
Shock absorber DYEF-...-Y1F <span style="float: right;">Technical data → Internet: dyef</span>						
	10	Flexible cushioning, with metal stop	P1	548373	DYEF-M8-Y1F	1
	12			548374	DYEF-M10-Y1F	
	16			548375	DYEF-M12-Y1F	
	20			548376	DYEF-M14-Y1F	
	25			548377	DYEF-M16-Y1F	
Shock absorber DYSW <span style="float: right;">Technical data → Internet: dysw</span>						
	10	Progressive shock absorber, both ends	Y3	548071	DYSW-5-8-Y1F	1
	12			548072	DYSW-7-10-Y1F	
	16			548073	DYSW-8-14-Y1F	
	20			548074	DYSW-10-17-Y1F	
	25			548075	DYSW-12-20-Y1F	
Reducing sleeve DAYH						
	10	For DYSW-4-6	-	1165476	DAYH-4	1
	12	For DYSW-5-8		1165480	DAYH-5	
	16	For DYSW-7-10		1165484	DAYH-7	
	20	For DYSW-8-14		1165488	DAYH-8	
	25	For DYSW-10-17		1165491	DAYH-10	

1) Packaging unit

# Mini slides DGSL-N, NPT



Accessories



FESTO

Ordering data						
	For size	Brief description	Part No.	Type	PU <sup>1)</sup>	
One-way flow control valve GRLA <span style="float: right;">Technical data → Internet: grla</span>						
	10, 12, 16	<ul style="list-style-type: none"> <li>For regulating speed</li> <li>Only one GRLA-M3-QS-3 can be mounted on the front face with size 4</li> </ul>	564840	GRLA-10-32-UNF-QB-5/32-U	1	
	20, 25		534658	GRLA-1/8-QB-1/4-U		
Push-in fitting QB <span style="float: right;">Technical data → Internet: quick star</span>						
	10, 12, 16	For connecting compressed air tubing with standard O.D.	533267	QB-10-32-UNF-5/32-U	10	
	20, 25		533273	QB-1/8-1/4-U		

1) Packaging unit

Ordering data – Proximity sensors for C-slot, magneto-resistive							Technical data → Internet: smt
	Type of mounting	Switching output	Electrical connection, connection direction	Cable length [m]	Part No.	Type	
N/O contact							
	Insertable in the slot from above	PNP	Cable, 3-wire, in-line	2.5	551373	SMT-10M-PS-24V-E-2,5-L-OE	
			Plug M8x1, 3-pin, in-line	0.3	551375	SMT-10M-PS-24V-E-0,3-L-M8D	
			Plug M8x1, 3-pin, angled	0.3	551376	SMT-10M-PS-24V-E-0,3-Q-M8D	

Ordering data – Proximity sensors for C-slot, magnetic reed							Technical data → Internet: sme
	Type of mounting	Switching output	Electrical connection, connection direction	Cable length [m]	Part No.	Type	
N/O contact							
	Insertable in the slot from above	Contacting	Plug M8x1, 3-pin, in-line	0.3	551367	SME-10M-DS-24V-E-0,3-L-M8D	
			Cable, 3-wire, in-line	2.5	551365	SME-10M-DS-24V-E-2,5-L-OE	
			Cable, 2-wire, in-line	2.5	551369	SME-10F-ZS-24V-E-2,5L-OE	
	Insertable in the slot lengthwise	Contacting	Plug M8x1, 3-pin, in-line	0.3	173212	SME-10-SL-LED-24	
			Cable, 3-wire, in-line	2.5	173210	SME-10-KL-LED-24	

Ordering data – Connecting cables							Technical data → Internet: nebu
	Electrical connection, left	Electrical connection, right	Cable length [m]	Part No.	Type		
	Straight socket, M8x1, 3-pin	Cable, open end, 3-wire	2.5	541333	NEBU-M8G3-K-2.5-LE3		
			5	541334	NEBU-M8G3-K-5-LE3		
	Angled socket, M8x1, 3-pin	Cable, open end, 3-wire	2.5	541338	NEBU-M8W3-K-2.5-LE3		
			5	541341	NEBU-M8W3-K-5-LE3		