

Guided drives DFM-N-B, NPT

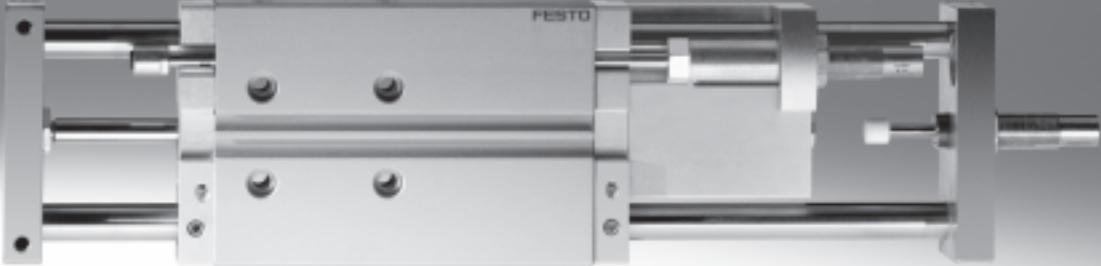

Guided drives DFM-N-B, NPT

Key features

FESTO

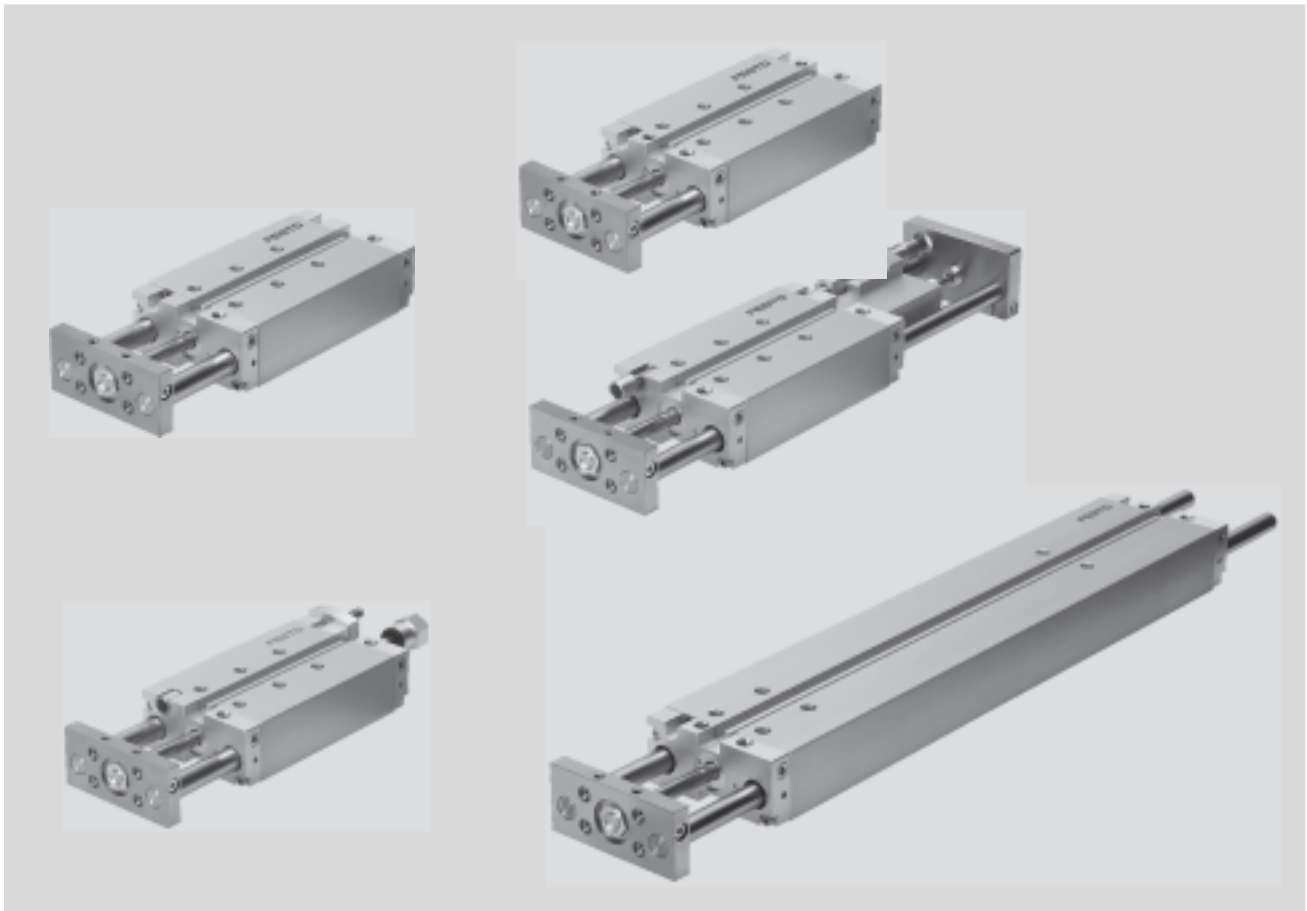

Drive and guide unit in a single housing

- Minimal space requirement
- Minimal assembly time
- Choice of supply ports
- Wide range of mounting options

Sturdy and precise

- Good protection against torsion
- Rigid construction
- Maintenance-free

High resistance to torques and lateral forces

- With plain-bearing guide: It offers high rigidity thanks to its guide rods with large diameter and four plain-bearing bushes
- With recirculating ball bearing guide: For applications involving torque loads

Wide choice of variants

- With heat-resistant seals up to 120 °C
- With adjustable end position
- With shock absorbers
- With pneumatic end-position cushioning
- Long-stroke versions

Guided drives DFM-N-B, NPT

Key features

Use in conveyor systems

Lifting

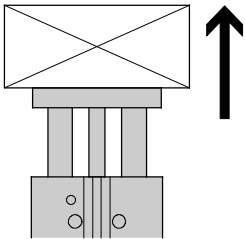

Pushing

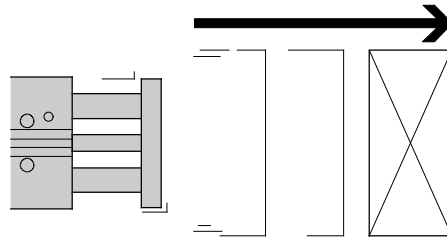

Stopping

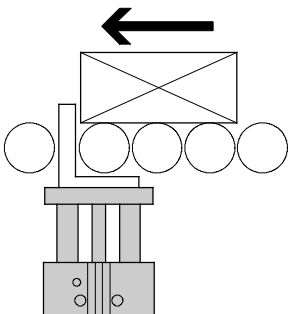

Stopping via stop bracket

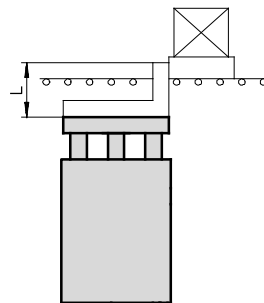

It is recommended to fit a buffer on the workpiece carrier.

Mounting options

Flat from above

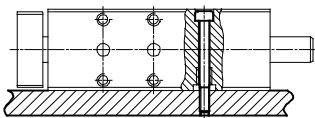

Flat from below

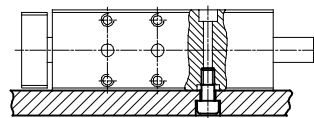

Side from below

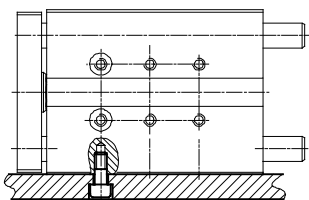

On end

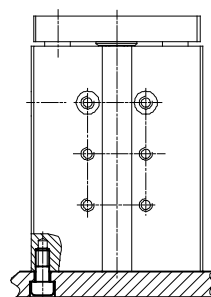

Guided drives DFM-N-B, NPT

Product range overview

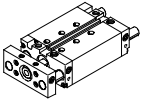
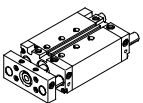
Function	Version	Type	Piston \varnothing	Stroke	Variable stroke
			[mm]	[mm]	[mm]
Double-acting	DFM-N-B with recirculating ball bearing guide				
		DFM-N-B Single-ended piston rod	12, 16	10, 20, 25, 30, 40, 50, 80, 100, 125, 160, 200	10 ... 200
			20, 25, 32	20, 25, 30, 40, 50, 80, 100, 125, 160, 200, 250, 320, 400	20 ... 400
			40, 50, 63	25, 50, 80, 100, 125, 160, 200, 250, 320, 400	25 ... 400
	DFM-N-B with plain-bearing guide				
		DFM-N-B Single-ended piston rod	12, 16	10, 20, 25, 30, 40, 50, 80, 100, 125, 160, 200	10 ... 200
			20, 25, 32	20, 25, 30, 40, 50, 80, 100, 125, 160, 200, 250, 320, 400	20 ... 400
			40, 50, 63	25, 50, 80, 100, 125, 160, 200, 250, 320, 400	25 ... 400

Guided drives DFM-N-B, NPT

Product range overview

Type	Position sensing	Cushioning			Heat-resistant seals	Precision end-position adjustment		→ Page/Internet
		Not adjustable	Adjustable for heavy loads	Self-adjusting end position adjustable for heavy loads		Advanced end position	Retracted end position	
	A	P	PPV	YSRW	S6	AJ	EJ	
DFM-N-B with recirculating ball bearing guide								
DFM-N-B Single-ended piston rod	■	■	■ ∅ 16 and above	■ ∅ 20 and above	–	■	■ ∅ 20 and above	30
DFM-N-B with plain-bearing guide								
DFM-N-B Single-ended piston rod	■	■	■	–	■	■	■	30

Guided drives DFM-N-B, NPT

Peripherals overview

FESTO

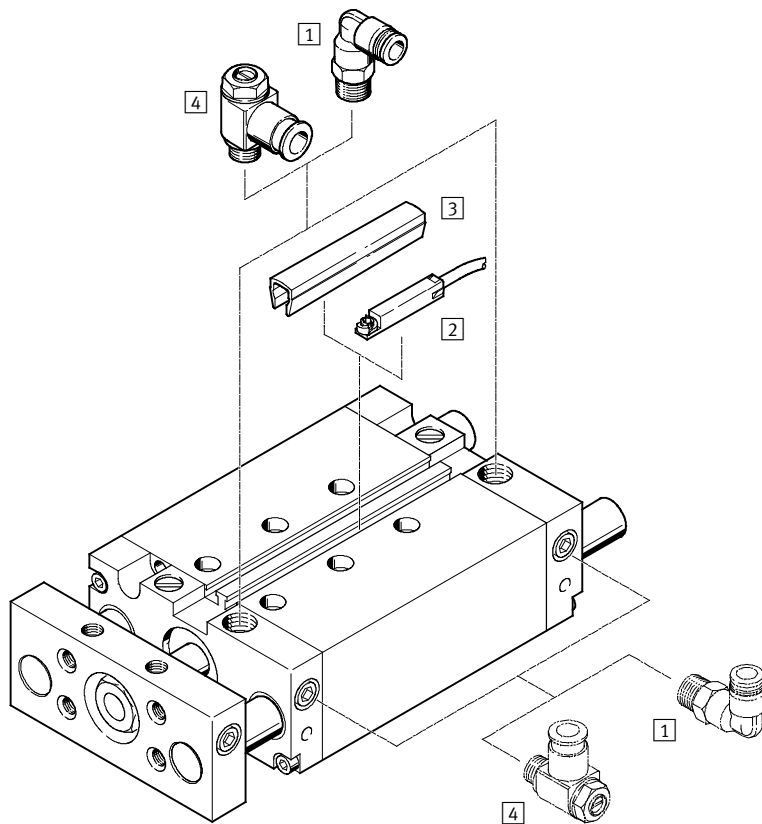

DFM-N-B-12-P

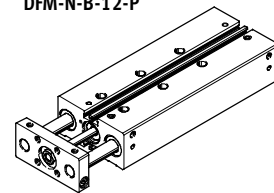

DFM-N-B-12-P-AJ

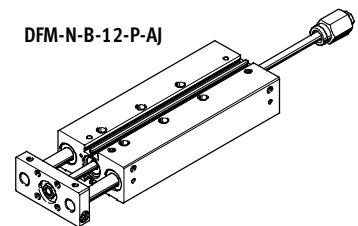

Variants

AJ

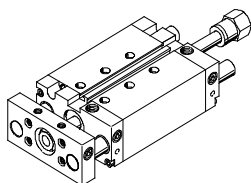

EJ

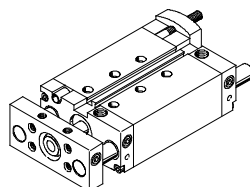

AJ + EJ

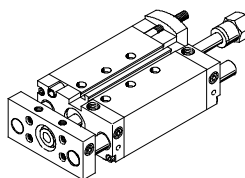

YSRW

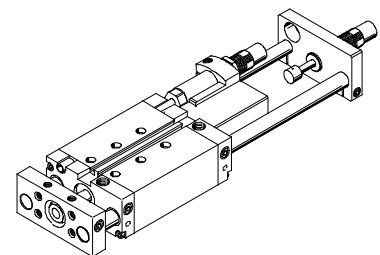

Accessories

	Brief description	→ Page/Internet
1 Push-in fitting QS	For connecting compressed air tubing with standard O.D.	quick star
2 Proximity sensor SME-/SMT-8	Can be integrated in the profile barrel	38
3 Slot cover ABP-5-S	For protecting the sensor cable and keeping dirt out of the sensor slots	38
4 One-way flow control valve GRLA	For speed regulation	39
- Centring sleeves ZBH	4 or 6 pieces included in the scope of delivery	38

- Note

Proximity sensors SM...0-8E cannot be used with the DFM-N-B.

Guided drives DFM-N-B, NPT

Type codes

DFM - N - 50 - 80 - B - P - A - GF - S6 - AJ - ZUB - 10S - G

Type

DFM	Guided drive
-----	--------------

System of units

N	Imperial
---	----------

Piston Ø [mm]

Stroke [mm]

Generation

B	Series
---	--------

Cushioning

P	Flexible cushioning rings/pads at both ends
PPV	Pneumatic cushioning, adjustable at both ends
YSRW	Self-adjusting at both ends

Position sensing

A	Via proximity sensor
---	----------------------

Guide

GF	Plain-bearing guide
KF	Recirculating ball bearing guide

Variant

S6	Heat-resistant seals up to max. 120 °C
----	--

Precision adjustment

AJ	Advanced end position
EJ	Retracted end position

Accessories

ZUB	Supplied separately
-----	---------------------

Slot cover

...S	Sensor slot
------	-------------

Proximity sensor

...G	With cable, 2.5 m
...I	Contactless with cable, 2.5 m

Guided drives DFM-N-B, NPT



Technical data

FESTO

Function

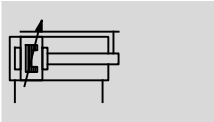
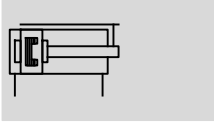
 www.festo.com



-  Diameter
12 ... 63 mm
-  Stroke length
10 ... 400 mm

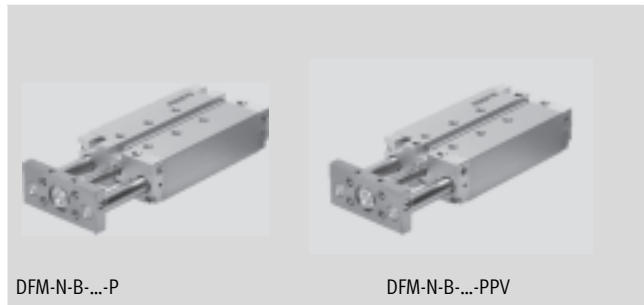

DFM-N-B-...-P

DFM-N-B-...-PPV

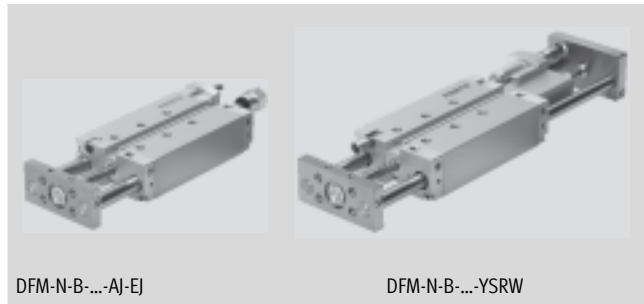

DFM-N-B-...-AJ-EJ

DFM-N-B-...-YSRW

General technical data								
Piston \varnothing	12	16	20	25	32	40	50	63
Pneumatic connection	M5 suitable for 10-32 UNF			$\frac{1}{8}$ NPT			$\frac{1}{4}$ NPT	
Operating medium	Compressed air in accordance with ISO 8573-1:2010 [7:4:4]							
Note on operating/pilot medium	Operation with lubricated medium possible (in which case lubricated operation will always be required)							
Operating pressure [bar]	2 ... 10	2 ... 10	2 ... 10	1.5 ... 10	1.5 ... 10	1.5 ... 10	1 ... 10	1 ... 10
Design	Piston							
	Piston rod							
	Guide rods with yoke							
Cushioning	Flexible cushioning rings/pads at both ends							
	-	Pneumatic cushioning, adjustable at both ends						
	-	-	Self-adjusting at both ends					
Cushioning length (PPV) [mm]	-	12	15	15	16	17	19	19
Position sensing	Via proximity sensor							
Type of mounting	Via through-holes							
	Via female thread							
Mounting position	Any							
Protection against torsion/guide	Guide rod with yoke/plain-bearing or recirculating ball bearing guide							
Variant AJ, EJ and YSRW								
Setting range [mm]	0 ... 10							
Variant YSRW with shock absorber								
Repetition accuracy [mm]	-	-	Max. 0.05					

- | - Note: This product conforms to ISO 1179-1 and to ISO 228-1

Guided drives DFM-N-B, NPT

Technical data

Ambient conditions				
	Plain-bearing guide GF	Recirculating ball bearing guide KF	YSRW with shock absorber	S6
Ambient temperature ¹⁾ [°C]	-20 ... +80	-5 ... +60	0 ... +60	0 ... +120
Corrosion resistance class CRC ²⁾	2	-	-	2
ATEX	Specified types → www.festo.com			

1) Note operating range of proximity sensors

2) Corrosion resistance class 2 to Festo standard 940 070

Components subject to moderate corrosion stress. Externally visible parts with primarily decorative surface requirements which are in direct contact with a normal industrial environment or media such as coolants or lubricating agents

Speed [m/s]								
Piston Ø	12	16	20	25	32	40	50	63
Cushioning P, precision stroke adjustment AJ and EJ								
Maximum speed advancing, retracting	0.8	0.8	0.8	0.8	0.8	0.8	0.6	0.6
Cushioning P, plain-bearing guide GF in combination with S6								
Maximum speed advancing, retracting	0.5	0.5	0.5	0.5	0.5	0.5	0.4	0.4
Cushioning PPV, YSRW, PPV S6								
Maximum speed advancing, retracting	-	1.5	1.5	1.5	1.5	1.5	1	1

Forces [N]								
Piston Ø	12	16	20	25	32	40	50	63
Cushioning P, PPV, YSRW, precision stroke adjustment E]								
Theoretical force at 6 bar, advancing	68	121	188	295	482	754	1,178	1,870
Theoretical force at 6 bar, retracting	51	90	141	247	415	686	1,057	1,750
Precision stroke adjustment AJ and AJ+E]								
Theoretical force at 6 bar, advancing	51	90	141	247	415	686	1,057	1,750
Theoretical force at 6 bar, retracting	51	90	141	247	415	686	1,057	1,750

Guided drives DFM-N-B, NPT

Technical data

Impact energy [J]								
Piston Ø	12	16	20	25	32	40	50	63
Cushioning P								
Max. impact energy in the end positions	0.09	0.15	0.2	0.35	0.40	0.7	1.0	1.3
Max. impact energy in the end positions S6	0.035	0.075	0.1	0.15	0.2	0.35	0.5	0.65
Cushioning YSRW								
Max. energy absorption per stroke	-	-	4	8	12	35	35	70
Max. energy absorption per hour	-	-	21,000	30,000	41,000	68,000	68,000	100,000

Permissible impact velocity:

$$v_{perm.} = \sqrt{\frac{2 \times E_{perm.}}{m_{dead} + m_{load}}}$$

$v_{perm.}$ Permissible impact velocity

$E_{perm.}$ Max. impact energy

$m_{intrinsic}$ Moving load (drive)

m_{Load} Moving effective load

 Note

This data represents the maximum values that can be achieved. The maximum permissible impact energy must be observed.

Maximum permissible load:

$$m_{load} = \frac{2 \times E_{perm.}}{v^2} - m_{dead}$$

DFM-N-B with plain-bearing guide GF, cushioning P, PPV								
Stroke [mm]	Piston Ø [mm]							
	12	16	20	25	32	40	50	63
Product weight [g]								
10	385	621	-	-	-	-	-	-
20	432	680	1,026	1,474	2,163	-	-	-
25	452	706	1,068	1,530	2,238	2,606	4,290	5,568
30	476	736	1,109	1,586	2,337	-	-	-
40	523	795	1,215	1,726	2,489	-	-	-
50	570	854	1,298	1,838	2,640	3,047	5,019	6,457
80	712	1,033	1,572	2,218	3,210	3,663	5,909	7,503
100	803	1,148	1,733	2,435	3,502	3,981	6,376	8,116
125	962	1,352	2,000	2,800	4,018	4,534	7,151	9,050
160	1,128	1,560	2,293	3,193	4,549	5,118	8,017	10,137
200	1,318	1,797	2,628	3,642	5,158	5,786	9,007	11,379
250	-	-	3,237	4,430	6,259	6,962	10,813	13,509
320	-	-	3,823	5,215	7,322	8,129	12,545	15,682
400	-	-	4,493	6,113	8,537	9,462	14,525	18,165
Moving load [g]								
10	201	283	-	-	-	-	-	-
20	216	302	506	715	1,147	-	-	-
25	223	312	520	734	1,176	1,305	2,217	2,640
30	230	322	534	753	1,230	-	-	-
40	245	342	586	823	1,289	-	-	-
50	260	362	615	861	1,347	1,476	2,567	2,990
80	304	423	724	1,022	1,644	1,776	3,002	3,426
100	333	463	781	1,098	1,764	1,893	3,189	3,613
125	420	579	917	1,289	2,059	2,188	3,586	4,009
160	472	649	1,016	1,422	2,264	2,393	3,913	4,336
200	530	730	1,129	1,573	2,499	2,627	4,286	4,710
250	-	-	1,489	2,017	3,164	3,293	5,351	5,774
320	-	-	1,688	2,283	3,574	3,703	6,005	6,428
400	-	-	1,914	2,587	4,042	4,171	6,752	7,176

Guided drives DFM-N-B, NPT

Technical data

DFM-N-B with plain-bearing guide GF, cushioning P, PPV, variant S6								
Stroke [mm]	Piston \varnothing [mm]							
	12	16	20	25	32	40	50	63
Product weight [g]								
0	283	488	745	1,080	1,594	1,847	3,124	3,992
10	328	548	–	–	–	–	–	–
20	376	607	907	1,298	1,889	–	–	–
25	395	633	949	1,354	1,964	2,257	3,735	4,762
30	419	663	990	1,410	2,063	–	–	–
40	466	722	1,096	1,550	2,215	–	–	–
50	514	781	1,179	1,662	2,366	2,698	4,464	5,651
80	656	959	1,452	2,042	2,936	3,314	5,354	6,696
100	747	1,074	1,614	2,259	3,228	3,632	5,821	7,310
125	905	1,279	1,880	2,624	3,745	4,186	6,596	8,244
160	1,072	1,486	2,173	3,017	4,276	4,770	7,462	9,331
200	1,261	1,724	2,508	3,466	4,884	5,437	8,452	10,573
250	–	–	3,118	4,254	5,985	6,613	10,258	12,703
320	–	–	3,704	5,039	7,048	7,780	11,990	14,876
400	–	–	4,374	5,937	8,264	9,114	19,970	17,359
Moving load [g]								
0	130	188	329	463	755	810	1,428	1,601
10	145	208	–	–	–	–	–	–
20	159	229	386	539	873	–	–	–
25	167	239	400	558	902	956	1,662	1,834
30	174	249	414	577	956	–	–	–
40	188	269	467	647	1,015	–	–	–
50	203	289	495	685	1,073	1,127	2,012	2,184
80	247	349	604	847	1,373	1,427	2,447	2,620
100	276	389	661	922	1,490	1,544	2,634	2,806
125	364	506	797	1,113	1,785	1,840	3,031	3,203
160	415	576	896	1,246	1,990	2,045	3,358	3,530
200	474	657	1,010	1,397	2,225	2,279	3,731	3,904
250	–	–	1,370	1,842	2,890	2,944	4,796	4,968
320	–	–	1,568	2,107	3,300	3,354	5,450	5,622
400	–	–	1,794	2,411	3,768	3,823	6,197	6,370

Guided drives DFM-N-B, NPT

Technical data

DFM-N-B with recirculating ball bearing guide KF, cushioning P, PPV								
Stroke [mm]	Piston \varnothing [mm]							
	12	16	20	25	32	40	50	63
Product weight [g]								
10	345	543	-	-	-	-	-	-
20	388	596	935	1,395	1,932	-	-	-
25	405	619	974	1,447	1,998	2,366	3,907	5,185
30	427	647	1,012	1,499	2,079	-	-	-
40	470	700	1,105	1,624	2,213	-	-	-
50	513	754	1,181	1,729	2,346	2,753	4,523	5,961
80	641	916	1,428	2,074	2,817	3,270	5,272	6,865
100	723	1,020	1,577	2,276	3,073	3,552	5,682	7,423
125	852	1,190	1,809	2,599	3,490	4,006	6,327	8,226
160	1,002	1,378	2,079	2,966	3,958	4,526	7,094	9,214
200	1,174	1,593	2,388	3,384	4,494	5,121	7,971	10,343
250	-	-	2,905	4,073	5,369	6,072	9,419	12,115
320	-	-	3,445	4,805	6,305	7,112	10,953	14,091
400	-	-	4,063	5,642	7,376	8,301	12,707	16,347
Moving load [g]								
10	168	239	-	-	-	-	-	-
20	178	254	437	631	933	-	-	-
25	183	261	447	646	954	1,082	1,830	2,254
30	188	268	458	661	990	-	-	-
40	198	283	498	716	1,030	-	-	-
50	208	297	520	746	1,071	1,199	2,067	2,491
80	238	341	602	873	1,271	1,400	2,361	2,785
100	259	370	646	934	1,352	1,481	2,492	2,915
125	316	452	748	1,083	1,548	1,677	2,758	3,182
160	352	503	824	1,189	1,690	1,819	2,986	3,410
200	392	561	911	1,310	1,852	1,981	3,247	3,671
250	-	-	1,180	1,656	2,291	2,420	3,953	4,377
320	-	-	1,332	1,868	2,575	2,703	4,410	4,833
400	-	-	1,505	2,111	2,899	3,027	4,931	5,355

Guided drives DFM-N-B, NPT

Technical data

FESTO

Additional weights with precision stroke adjustment AJ – GF, KF

When using the precision stroke adjustment AJ, the following weight must be taken into account in addition to the load specified from page 10.

Product weight [g] – Precision stroke adjustment AJ (piston rod + stop)								
Stroke [mm]	Piston Ø [mm]							
	12	16	20	25	32	40	50	63
10	55.4	58.8	–	–	–	–	–	–
20	57.6	61	75.6	115.4	185.7	–	–	–
25	58.7	62.1	77.6	118.5	190.2	188.7	350.7	350.5
30	59.9	63.3	79.6	121.6	194.7	–	–	–
40	62.1	65.5	83.6	127.8	203.6	–	–	–
50	64.3	67.7	87.5	134	212.5	211	390.4	390.2
80	71	74.4	99.5	152.6	239.3	237.8	438	437.8
100	75.5	78.9	107.5	165	257.2	255.7	469.8	469.6
125	81.1	84.5	117.3	180.5	279.5	278	509.5	509.3
160	88.9	92.3	131.2	202.5	310.8	309.3	565.1	564.9
200	97.8	101.2	147.1	227	346.5	345	628.6	628.4
250	–	–	167	258.1	391.2	389.7	708.1	707.9
320	–	–	194.8	301.5	453.8	452.3	819.2	819
400	–	–	226.5	351.1	525.2	523.7	946.3	946.1

Moving load [g] – Precision stroke adjustment AJ (piston rod + stop)								
Stroke [mm]	Piston Ø [mm]							
	12	16	20	25	32	40	50	63
10	51.5	52.3	–	–	–	–	–	–
20	53.7	54.5	76	116.6	185.9	–	–	–
25	54.8	55.6	78	119.7	190.4	190	351.7	351.7
30	56	56.8	80	122.8	194.9	–	–	–
40	58.2	59	84	129	203.8	–	–	–
50	60.4	61.2	87.9	135.2	212.7	212.7	391.4	391.4
80	67.1	67.9	99.9	153.8	239.5	239.5	439	439
100	71.6	72.4	107.8	166.2	257.4	257.4	470.8	470.8
125	77.2	78	117.7	181.7	279.7	279.7	510.5	510.5
160	85	85.8	131.6	203.4	311	311	566.1	566.1
200	93.9	94.7	147.5	228.2	346.7	346.7	629.6	629.6
250	–	–	167.4	259.3	391.4	391.4	709.1	709.1
320	–	–	195.2	302.7	454	454	820.2	820.2
400	–	–	226.9	352.3	525.4	525.4	947.3	947.3

Guided drives DFM-N-B, NPT

Technical data

FESTO

Additional weights with precision stroke adjustment EJ – GF, KF

When using the precision stroke adjustment EJ, the following weight must be taken into account in addition to the load specified from page 10.

Product weight [g] – Precision stroke adjustment EJ (piston rod + stop)						
Stroke [mm]	Piston Ø [mm]					
	20	25	32	40	50	63
20	55.7	117.1	134.1	–	–	–
25	56.4	119.1	136.1	153.9	302.8	354
30	57.2	121	138	–	–	–
40	58.8	125	142	–	–	–
50	60.3	129	146	163.8	318.3	369.5
80	65	140.9	157.9	175.7	336.9	388.1
100	68.1	148.8	165.8	183.6	349.4	400.6
125	71.9	158.8	175.8	193.6	364.9	416.1
160	77.4	172.7	189.7	207.5	386.6	437.8
200	83.6	188.5	205.5	223.3	411.4	462.6
250	91.3	208.4	225.4	243.2	442.4	493.6
320	102.2	236.2	253.2	271	485.9	537.1
400	114.6	268	285	302.8	535.5	586.7

DFM-N-B with recirculating ball bearing guide KF, cushioning YSRW						
Stroke [mm]	Piston Ø [mm]					
	20	25	32	40	50	63
Product weight [g]						
20	1,684	2,641	3,717	–	–	–
25	1,733	2,707	3,801	4,995	7,594	10,816
30	1,780	2,773	3,884	–	–	–
40	1,874	2,903	4,053	–	–	–
50	1,970	3,035	4,222	5,455	8,275	11,657
80	2,257	3,429	4,720	5,999	9,092	12,629
100	2,444	3,687	5,047	6,352	9,614	13,298
125	2,677	4,008	5,458	6,801	10,294	14,137
160	3,015	4,473	6,050	7,446	11,255	15,319
200	3,401	5,004	6,728	8,183	12,354	16,670
250	3,855	5,641	7,545	9,074	13,700	18,340
320	4,530	6,569	8,730	10,363	15,623	20,704
400	5,302	7,631	10,085	11,837	17,821	23,405
Moving load [g]						
20	874	1,323	1,933	–	–	–
25	894	1,350	1,969	2,386	3,735	4,996
30	914	1,378	2,005	–	–	–
40	953	1,432	2,077	–	–	–
50	993	1,487	2,149	2,566	4,021	5,282
80	1,111	1,650	2,365	2,782	4,365	5,625
100	1,190	1,759	2,509	2,926	4,594	5,855
125	1,289	1,896	2,690	3,106	4,880	6,141
160	1,427	2,087	2,942	3,359	5,281	6,542
200	1,585	2,305	3,230	3,647	5,739	7,000
250	1,782	2,578	3,590	4,007	6,312	7,572
320	2,059	2,959	4,095	4,512	7,114	8,374
400	2,375	3,396	4,671	5,088	8,030	9,290

Guided drives DFM-N-B, NPT

Technical data

Materials

Sectional view

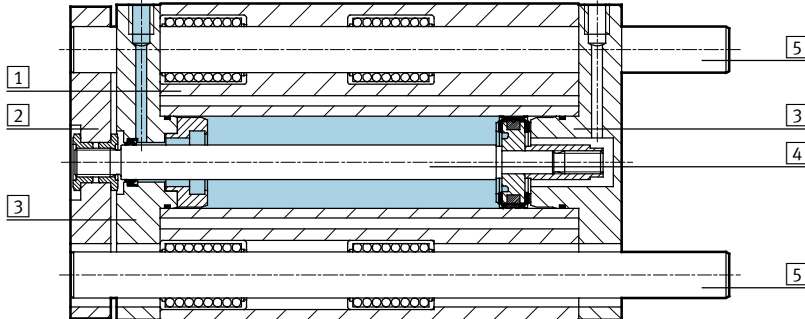

Guided drive	Plain-bearing guide GF	Recirculating ball bearing guide KF	S6
1 Housing	Anodised wrought aluminium alloy	Anodised wrought aluminium alloy	Anodised wrought aluminium alloy
2 Yoke plate	Tempered steel	Tempered steel	Wrought aluminium alloy
3 Bearing and end caps	Anodised wrought aluminium alloy	Anodised wrought aluminium alloy	Anodised wrought aluminium alloy
4 Piston rod	High-alloy stainless steel	High-alloy stainless steel	High-alloy stainless steel
5 Guide rods	High-alloy steel	Tempered steel	High-alloy steel
- Static seals	Nitrile rubber	Nitrile rubber	Fluoro elastomer
- Dynamic seals	Polyurethane	Polyurethane	Fluoro elastomer
Note on material	-	Free of copper, PTFE and silicone	-

Maximum effective load F [N]

Plain-bearing guide GF and recirculating ball bearing guide KF

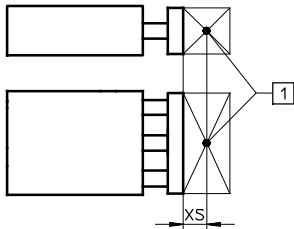

1 Centre of gravity of effective load

Piston Ø [mm]	XS [mm]	Stroke [mm]	Stroke [mm]															
			10	20	25	30	40	50	80	100	125	160	200	250	320	400		
12	GF	25	53	47	45	43	39	36	28	25	23	20	15	-	-	-		
	KF		47	42	40	38	35	32	26	23	20	16	13	-	-	-		
16	GF	50	95	86	83	79	73	67	55	49	37	30	25	-	-	-		
	KF		75	69	66	64	58	56	51	48	30	21	17	-	-	-		
20	GF	50	-	99	96	92	110	103	86	77	71	63	55	47	41	35		
	KF		-	80	77	75	91	88	80	75	65	56	47	40	34	29		
25	GF	50	-	121	116	112	123	115	96	86	86	76	67	53	45	39		
	KF		-	88	86	84	100	97	89	85	80	66	56	46	38	32		
32	GF	50	-	188	180	173	161	150	166	150	168	146	127	106	91	78		
	KF		-	120	118	116	112	109	134	128	144	135	126	135	125	100		
40	GF	50	-	-	180	-	-	150	166	150	168	146	127	106	91	78		
	KF		-	-	118	-	-	109	134	128	144	135	126	135	125	100		
50	GF	50	-	-	257	-	-	216	234	212	229	200	174	145	124	105		
	KF		-	-	182	-	-	168	201	193	211	199	188	179	158	130		
63	GF	50	-	-	257	-	-	216	234	212	229	200	174	145	124	105		
	KF		-	-	182	-	-	168	201	193	211	199	188	179	158	130		

Guided drives DFM-N-B, NPT

Technical data

Permissible torque [Nm]

Plain-bearing guide GF and recirculating ball bearing guide KF

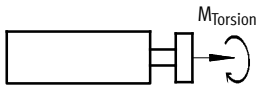

Piston \varnothing [mm]		Stroke [mm]													
		10	20	25	30	40	50	80	100	125	160	200	250	320	400
12	GF	1.10	0.95	0.90	0.85	0.80	0.75	0.60	0.50	0.45	0.40	0.30	-	-	-
	KF	0.95	0.85	0.80	0.75	0.70	0.65	0.50	0.45	0.40	0.30	0.25	-	-	-
16	GF	2.20	2.00	1.90	1.80	1.70	1.50	1.30	1.10	0.85	0.70	0.60	-	-	-
	KF	1.70	1.60	1.50	1.45	1.35	1.30	1.20	1.10	0.70	0.50	0.40	-	-	-
20	GF	-	2.90	2.80	2.70	3.20	3.00	2.50	2.20	2.10	1.80	1.60	1.40	1.20	1.00
	KF	-	2.30	2.20	2.15	2.60	2.55	2.30	2.20	1.90	1.60	1.40	1.20	1.00	0.85
25	GF	-	4.15	3.95	3.80	4.20	3.90	3.25	2.90	2.90	2.60	2.30	1.80	1.50	1.30
	KF	-	3.00	2.92	2.85	3.40	3.30	3.02	2.89	2.70	2.20	1.90	1.50	1.30	1.10
32	GF	-	7.30	7.00	6.70	6.20	5.80	6.40	5.80	6.50	5.70	5.00	4.10	3.50	3.00
	KF	-	4.70	4.60	4.55	4.40	4.25	5.25	5.00	5.60	5.25	4.90	5.20	4.80	3.90
40	GF	-	-	7.90	-	-	6.55	7.25	6.55	7.35	6.40	5.55	4.60	4.0	3.40
	KF	-	-	5.20	-	-	4.80	5.90	5.65	6.35	5.95	5.55	5.95	5.50	4.40
50	GF	-	-	14.15	-	-	11.85	12.85	11.65	12.55	11.00	9.60	7.98	6.82	5.78
	KF	-	-	10.00	-	-	9.30	11.00	10.6	11.60	11.00	10.30	9.82	8.67	7.17
63	GF	-	-	15.90	-	-	13.30	14.45	13.10	14.10	12.30	10.70	9.06	7.75	6.56
	KF	-	-	11.30	-	-	10.50	12.50	12.00	13.20	12.40	11.70	11.16	9.85	8.15

Torsional backlash ρ

Plain-bearing guide GF and recirculating ball bearing guide KF in retracted state, without load

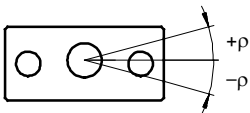

Piston \varnothing		12	16	20	25	32	40	50	63
Torsional backlash [°]	GF	0.09	0.09	0.07	0.07	0.06	0.06	0.05	0.05
	KF	0.08	0.08	0.07	0.07	0.05	0.05	0.05	0.05

Guided drives DFM-N-B, NPT

Technical data

Deflection of piston rod – Plain-bearing guide GF

Mean deflection f_1 due to bearing backlash as a function of stroke l

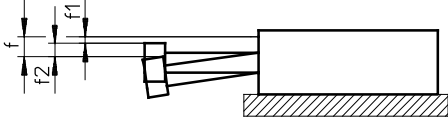

$$f = f_1 + f_2$$

f = Total deflection of piston rod

f_1 = Deflection due to bearing backlash

f_2 = Deflection due to lateral force

DFM-N-GF with 2 bearings per guide rod

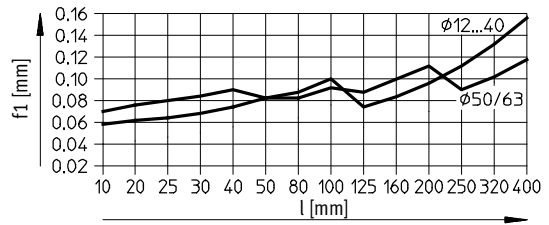

Deflection f_2 due to lateral force F as a function of stroke with plain-bearing guide GF

Stroke 50 mm

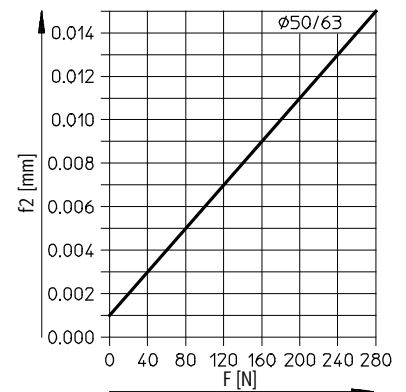
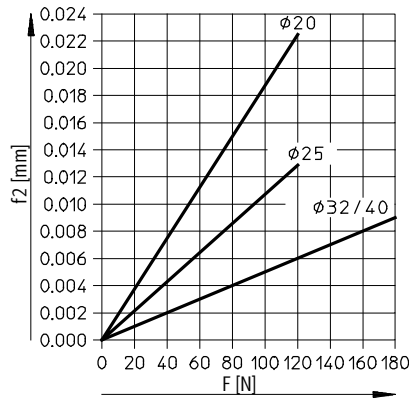
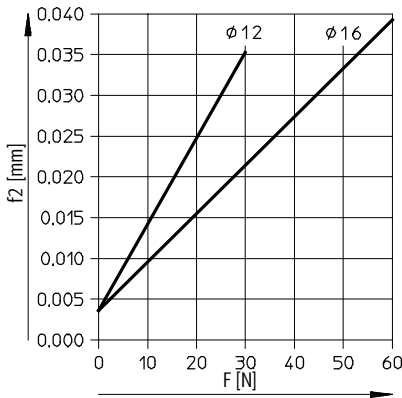

Stroke 100 mm

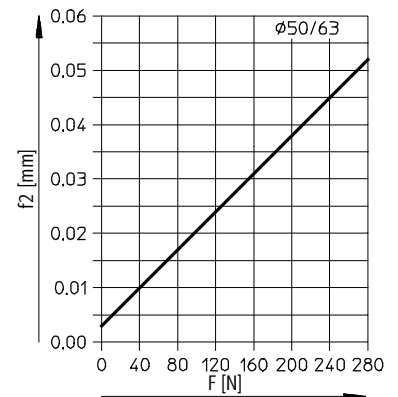
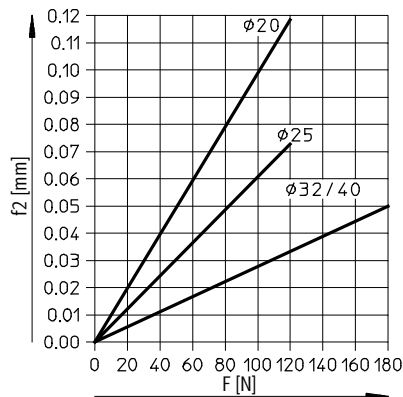
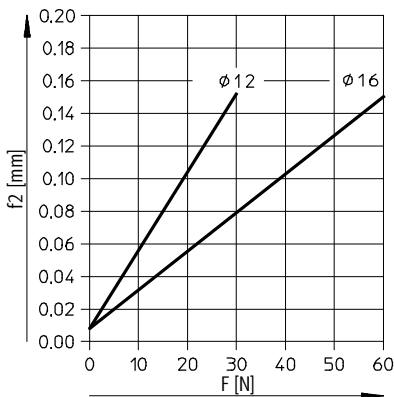

Guided drives DFM-N-B, NPT

Technical data

Deflection of piston rod – Plain-bearing guide GF

Mean deflection f_1 due to bearing backlash as a function of stroke l

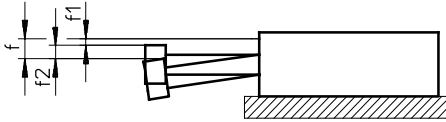

- $f = f_1 + f_2$
- f = Total deflection of piston rod
- f_1 = Deflection due to bearing backlash
- f_2 = Deflection due to lateral force

DFM-N-GF with 2 bearings per guide rod

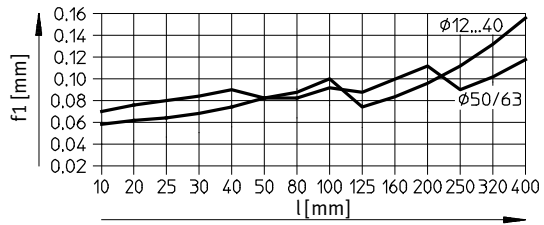

Deflection f_2 due to lateral force F as a function of stroke with plain-bearing guide GF

Stroke 200 mm

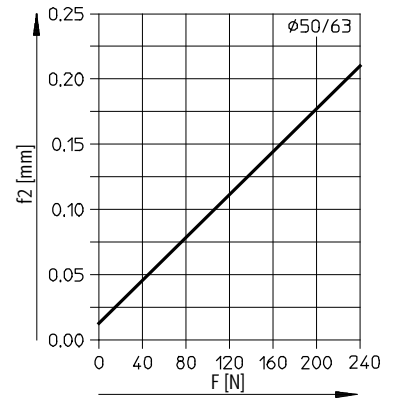
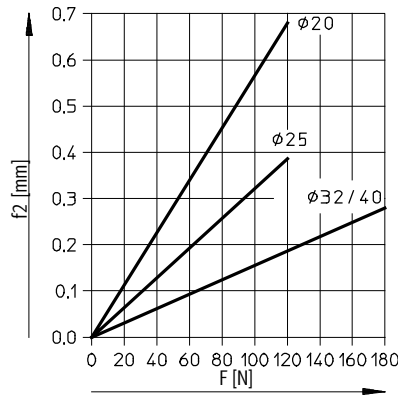
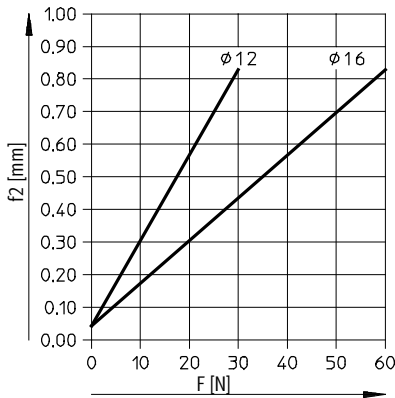

Stroke 400 mm

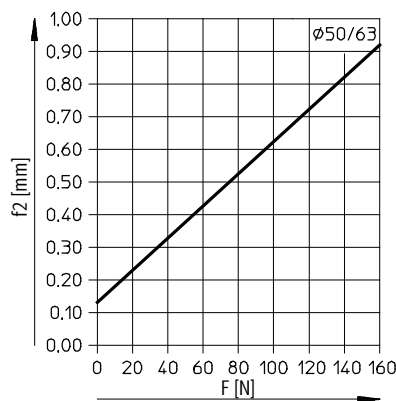
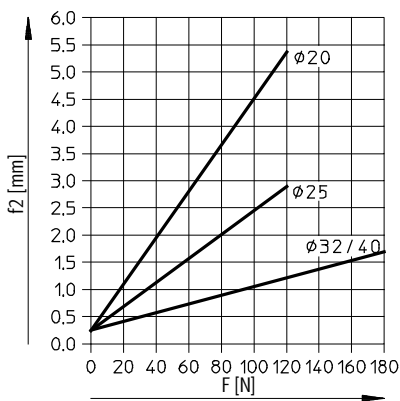

Guided drives DFM-N-B, NPT

Technical data

Deflection of piston rod – Recirculating ball bearing guide KF

Mean deflection f_1 due to bearing backlash as a function of stroke l

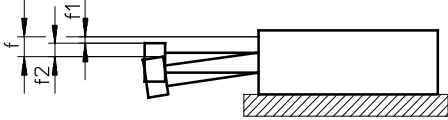

- $f = f_1 + f_2$
- f = Total deflection of piston rod
- f_1 = Deflection due to bearing backlash
- f_2 = Deflection due to lateral force

DFM-N-KF with 2 bearings per guide rod

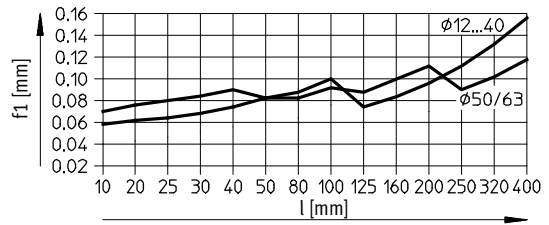

Deflection f_2 due to lateral force F as a function of stroke with recirculating ball bearing guide KF

Stroke 50 mm

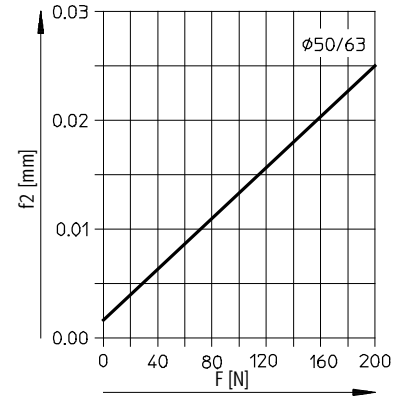
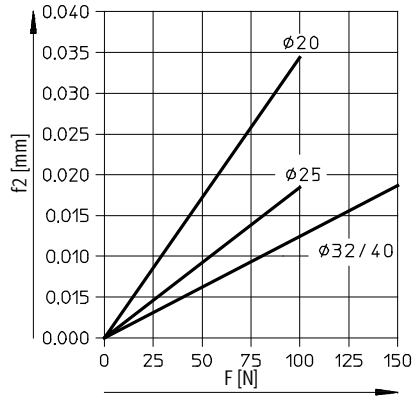
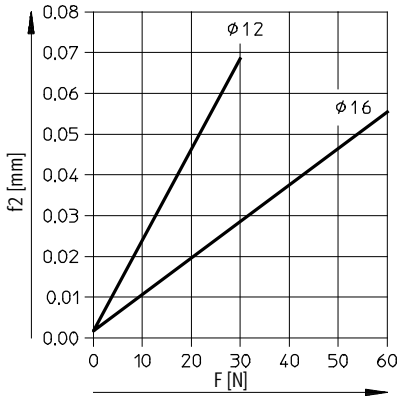

Stroke 100 mm

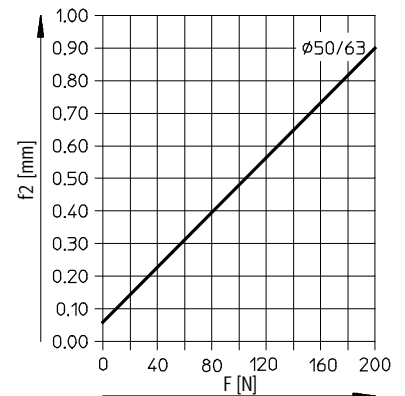
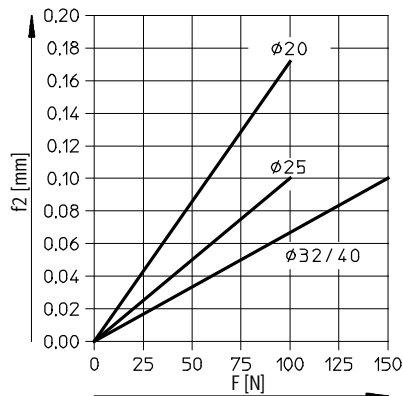
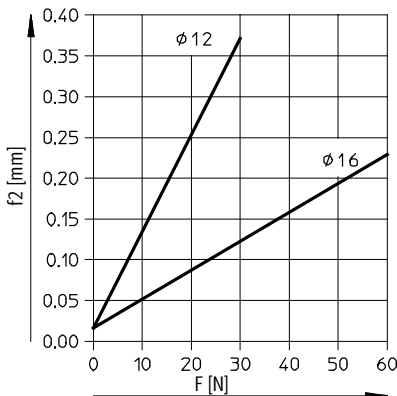

Guided drives DFM-N-B, NPT

Technical data



Deflection of piston rod – Recirculating ball bearing guide KF

Mean deflection f_1 due to bearing backlash as a function of stroke l

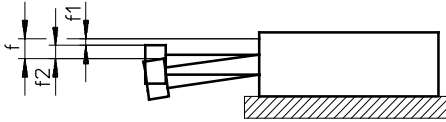

$$f = f_1 + f_2$$

f = Total deflection of piston rod

f_1 = Deflection due to bearing backlash

f_2 = Deflection due to lateral force

DFM-N-KF with 2 bearings per guide rod

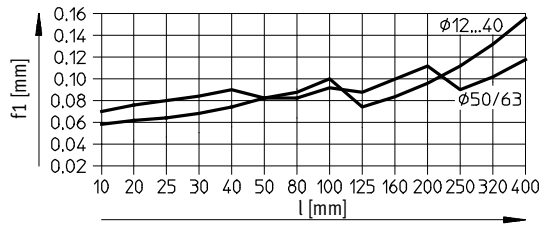

Deflection f_2 due to lateral force F as a function of stroke with recirculating ball bearing guide KF

Stroke 200 mm

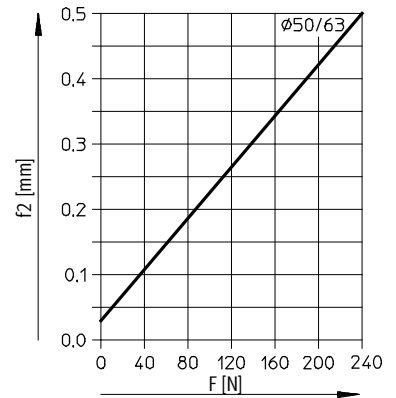
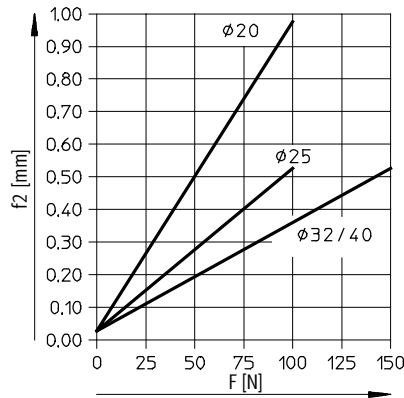
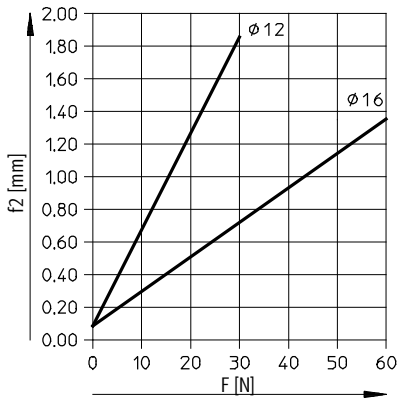

Stroke 400 mm

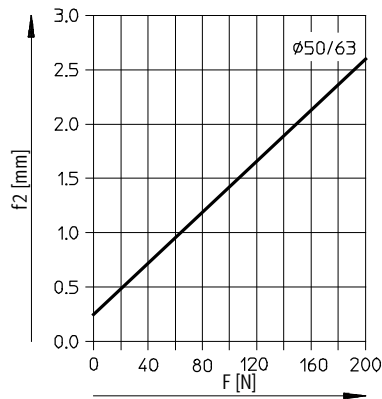
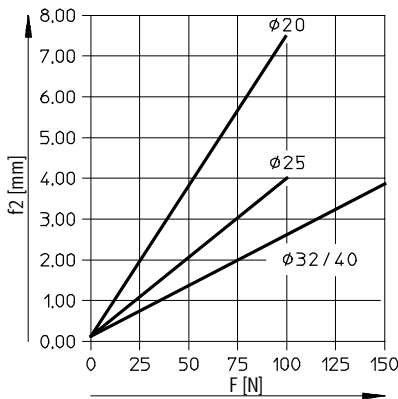

Guided drives DFM-N-B, NPT

Technical data

Used as a lifting cylinder

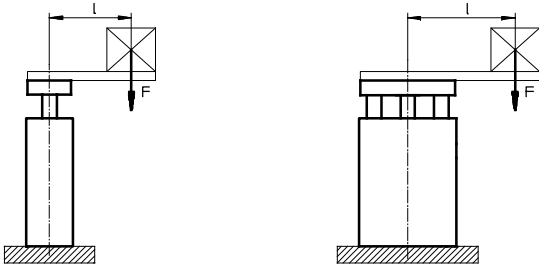

F = Longitudinal force [N]
l = Lever arm [mm]

Permissible load with plain-bearing guide GF

Stroke 40 ... 400 mm

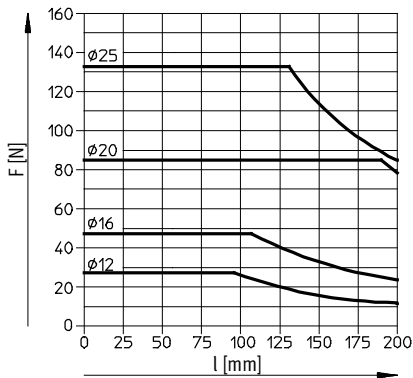

Stroke 250 ... 400 mm

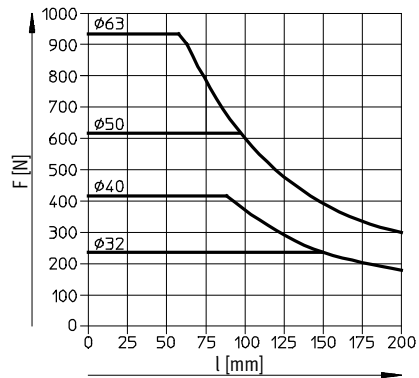

Permissible load with recirculating ball bearing guide KF

Stroke 40 ... 100 mm

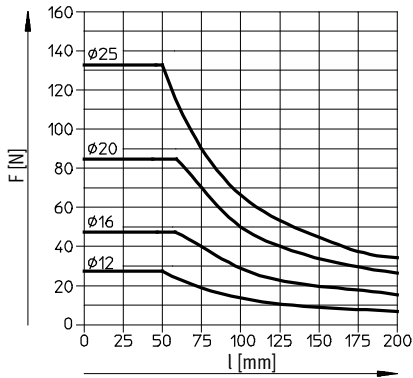

Stroke 125 ... 200 mm

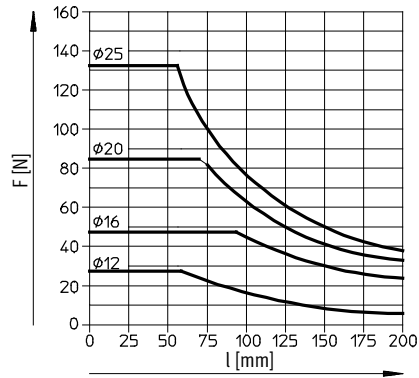

Stroke 250 ... 400 mm

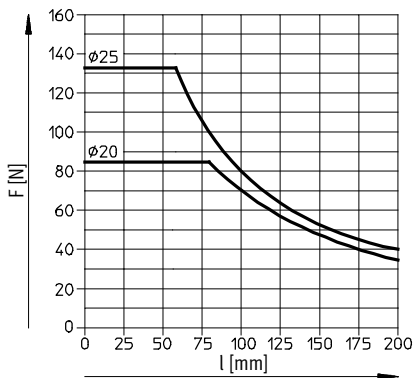

Stroke 200 ... 400 mm

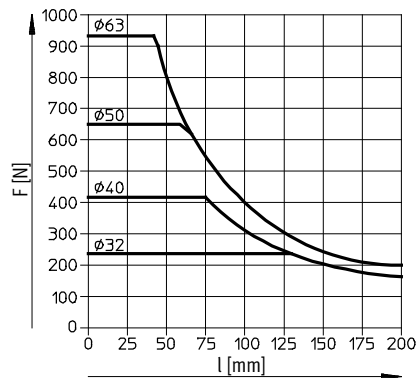

Guided drives DFM-N-B, NPT

Technical data



Permissible load m as a function of permissible speed v

Horizontal operation, cushioning YSRW

DFM-N-20-...-B-YSRW

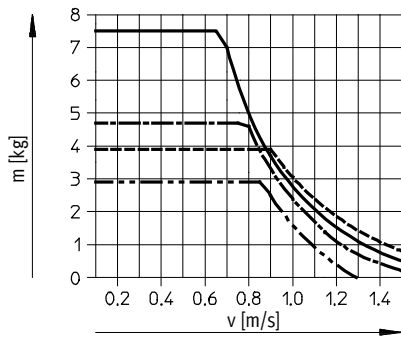

DFM-N-25-...-B-YSRW

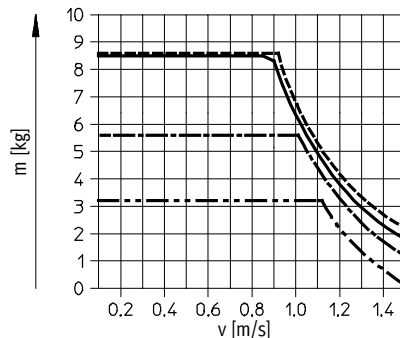

DFM-N-32-...-B-YSRW

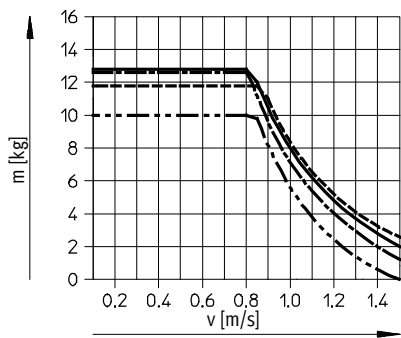

DFM-N-40-...-B-YSRW

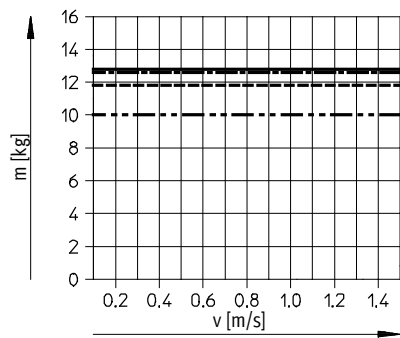

DFM-N-50-...-B-YSRW

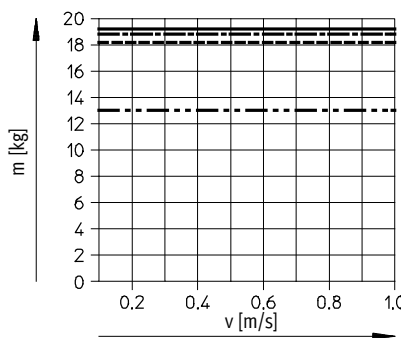

DFM-N-63-...-B-YSRW

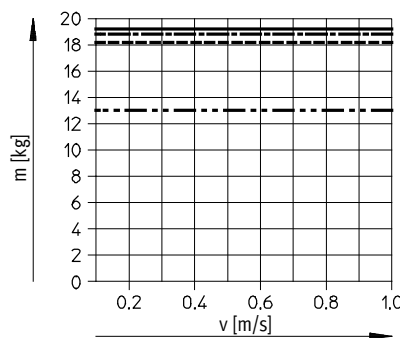

- 25 mm stroke
- 100 mm stroke
- · - · - 200 mm stroke
- · — · — 400 mm stroke

Guided drives DFM-N-B, NPT

Technical data

Permissible load m as a function of permissible speed v

Vertical operation, cushioning YSRW

DFM-N-20-...-B-YSRW

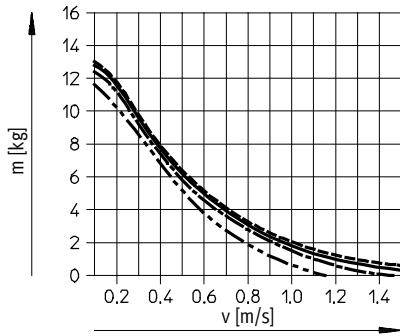

DFM-N-25-...-B-YSRW

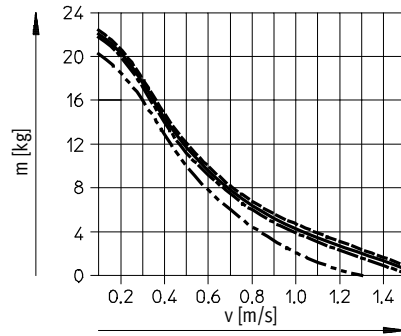

DFM-N-32-...-B-YSRW

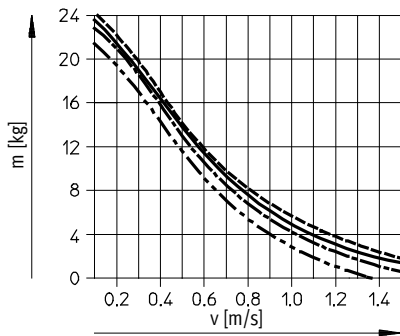

DFM-N-40-...-B-YSRW

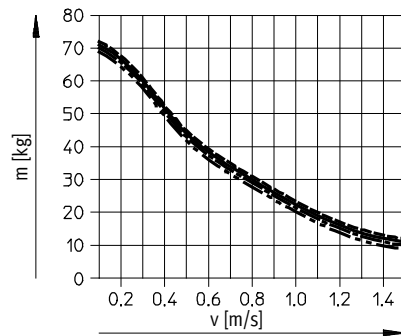

DFM-N-50-...-B-YSRW

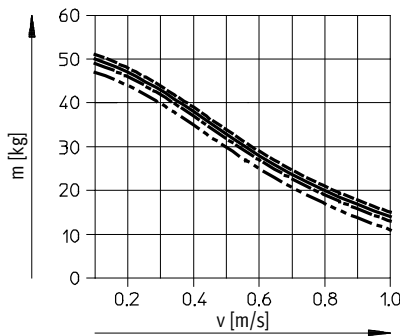

DFM-N-63-...-B-YSRW

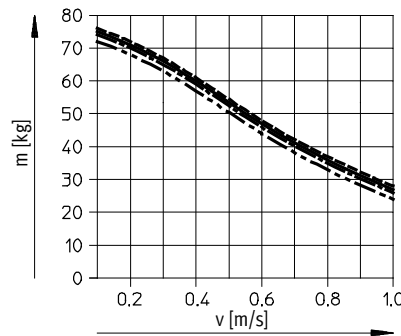

- 25 mm stroke
- 100 mm stroke
- · - · - 200 mm stroke
- · · · · 400 mm stroke

Guided drives DFM-N-B, NPT

Technical data

Dimensions

Download CAD data → www.festo.com

∅ 12, 16 mm

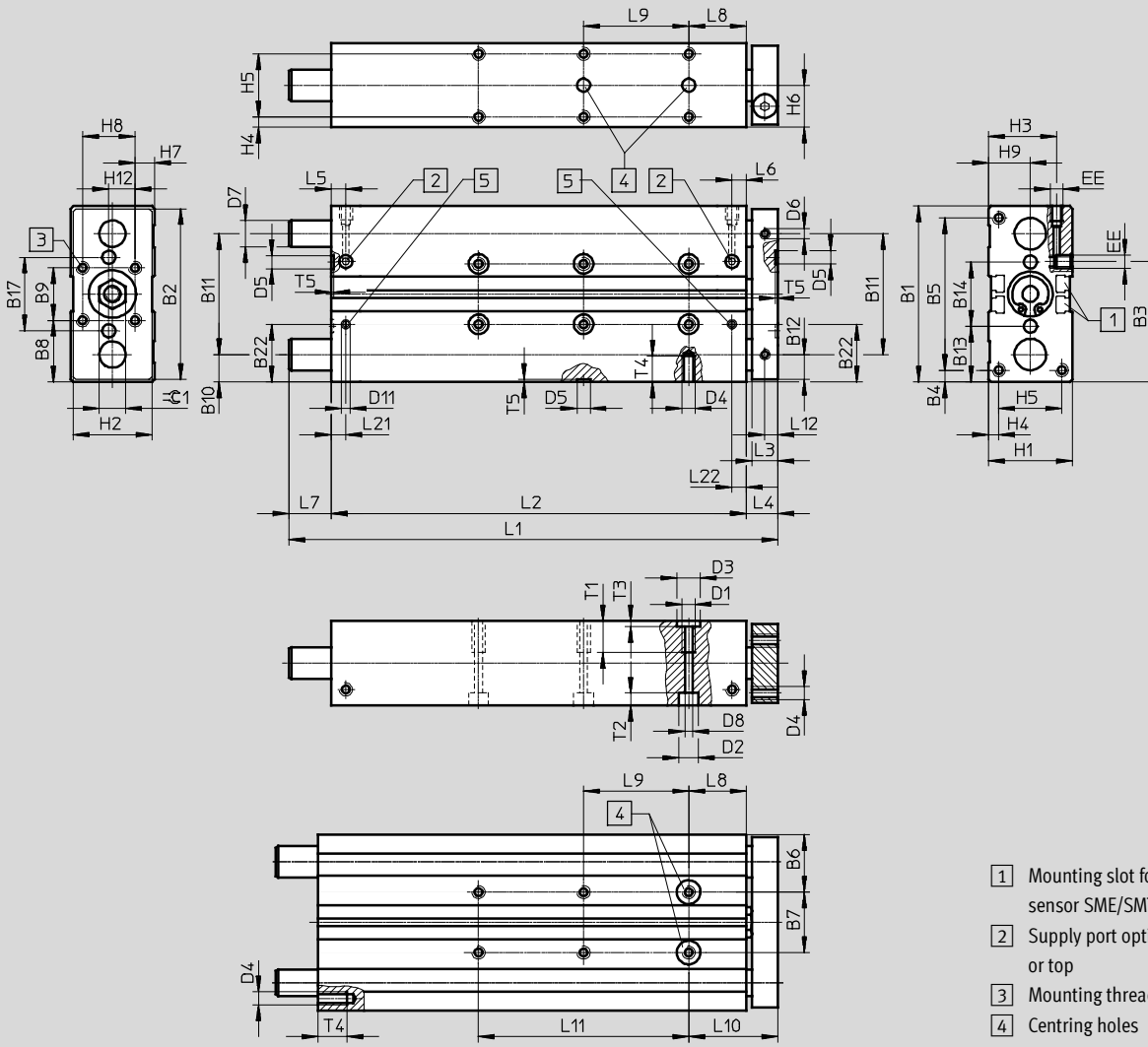

- 1) Mounting slot for proximity sensor SME/SMT-8
- 2) Supply port options at side or top
- 3) Mounting thread
- 4) Centring holes

∅	B1	B2	B3	B4	B5	B6	B7	B8	B9	B10	B11	B12	B13	B14	B17	B22	D1
[mm]							+0.02 ¹⁾							+0.02 ¹⁾			
12	60	58	40.7	4.5	51	20.5	19	20	20	9.5	41	8.5	19.5	21	25	-	M5
16	67	65	45	4.5	58	22	23	23.5	20	10.5	46	9.5	21.3	24.4	28	22.5	M5

∅	D2	D3	D4	D5	D6	D7		D8	D11	EE ²⁾	H1	H2	H3	H4	H5	H6	H7
[mm]	∅	∅		∅	∅	∅	GF	KF	∅	∅							
12	8	9	M4	5	M4	10 _{h8}	8 _{h6}	4.3	-	M5	28	26	24	4	20	14	4
16	7.5	9	M5	5	M4	12 _{h8}	10 _{h6}	4.3	3.3	M5	32	30	26.5	4	24	16	7.4

∅	H8	H9	H12	L3	L4	L5	L6	L8	L10	L12	L21	L22	T1	T2	T3	T4	T5	∅C1
[mm]																		
12	20	14	10	10	13	14.8	11.2	21	34	5	-	-	10	9.4	2.1	8	1.2	10
16	20	16	10	10	12	9.8	9.3	22	34	5	9.8	9.3	12	4.6	2.1	10	1.2	10

1) Tolerance between centring holes
 2) Suitable for 10-32 UNF

Guided drives DFM-N-B, NPT

Technical data

Stroke [mm]	Piston Ø [mm]									
	12					16				
	L1	L2	L7	L9 ±0.02 ¹⁾	L11	L1	L2	L7	L9 ±0.02 ¹⁾	L11
10	74	50	11	-	-	80	68	-	-	-
20	84	60	11	-	-	90	78	-	-	-
25	89	65	11	20	-	95	83	-	20	-
30	94	70	11	20	-	100	88	-	20	-
40	104	80	11	20	-	110	98	-	20	-
50	114	90	11	40	-	120	108	-	40	-
80	144	120	11	40	-	150	138	-	40	-
100	164	140	11	40	80	170	158	-	40	80
125	230	165	52	40	80	229	183	34	40	80
160	265	200	52	40	120	264	218	34	40	120
200	305	240	52	40	160	304	258	34	40	160

1) Tolerance between centring holes

 - Note

If the guide rods project beyond the housing when the unit is in its retracted end position (→ dimension L7), a recess must be provided in the mounting surface if the unit is to be mounted against a surface in order to allow the guide rods to move freely.

When using a variable stroke, the dimensions L1, L2, L7, L9 and L11 correspond to the next longest standard stroke.

Dimensions Download CAD data → www.festo.com

AJ – Precision stroke adjustment, advanced end position
 Ø 12, 16 mm

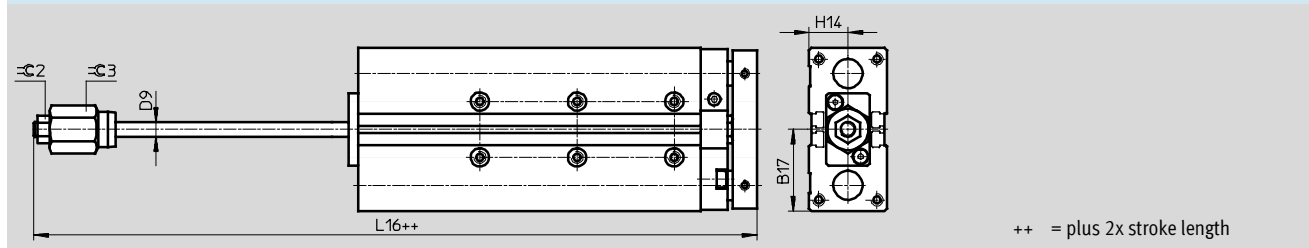

Ø	B17	D9 Ø	H14	L16	⊖C2	⊖C3
12	30.5	6	14	90.6	10	17
16	33.5	6	16	107.9	10	17

Guided drives DFM-N-B, NPT

Technical data



Dimensions

Download CAD data → www.festo.com

∅ 20 ... 40 mm

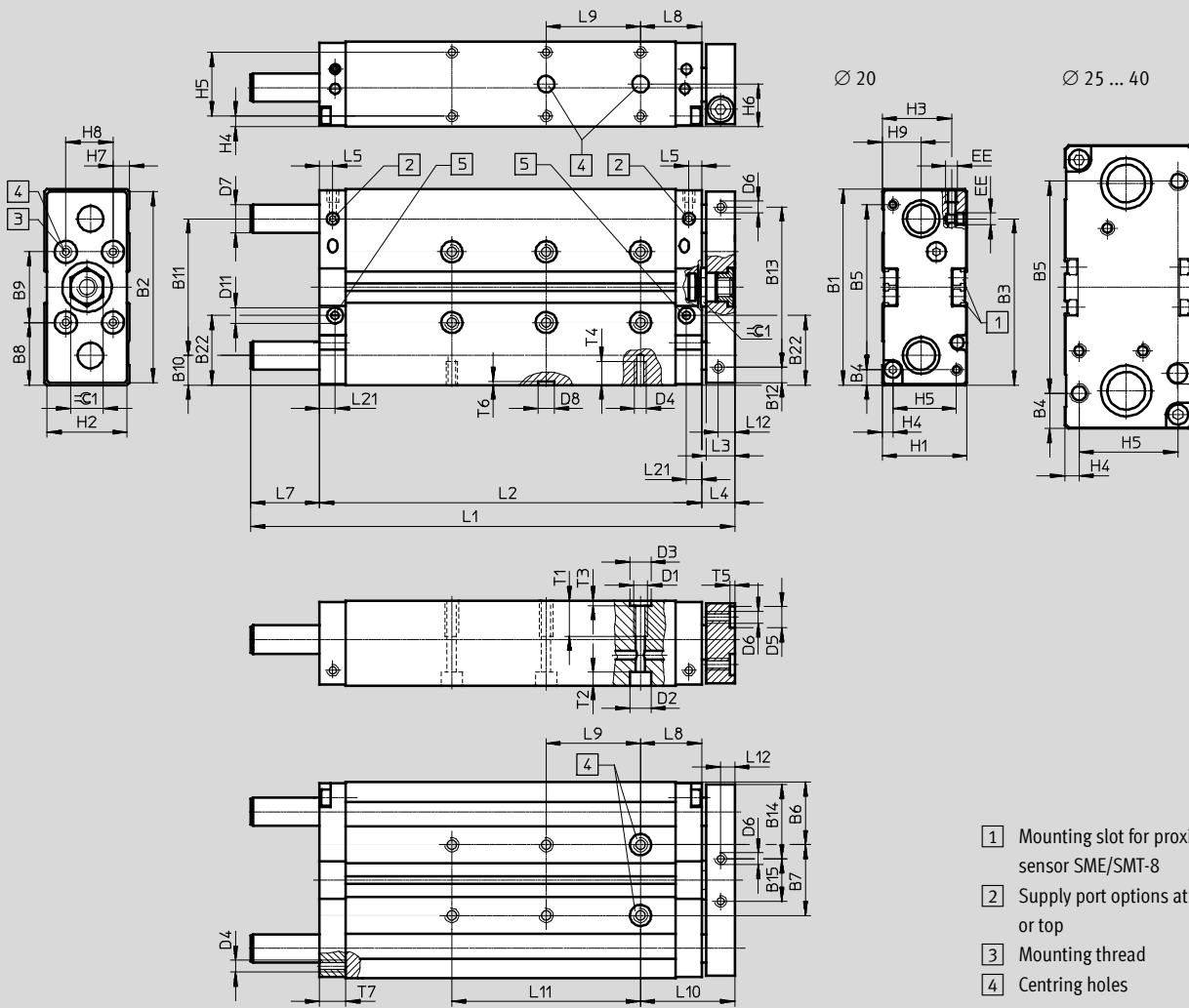

Guided drives DFM-N-B, NPT

Technical data

∅ [mm]	B1	B2	B3	B4	B5	B6	B7 ±0.02 ¹⁾	B8	B9 ±0.02 ¹⁾	B10	B11	B12	B13	B14	B15	B22	D1
20	83	81	70.5	6.5	70	26.5	30	26.5	30	12.5	58	6.5	68	31.5	18	29.5	M6
25	95	93	67	15.5	64	30	35	27.5	40	13.5	68	12.5	68	32.5	28	33.5	M6
32	110	108	77	20	70	33.5	43	35	40	16	78	15	78	41	26	41	M8
40	120	118	86	15	90	34.5	51	35	50	16	88	15	88	41	36	41	M8

∅ [mm]	D2 ∅	D3 ∅ H7	D4	D5 ∅ H7	D6 ∅	D7 ∅		D8 ∅ H7	D11 ∅	EE	H1	H2	H3	H4	H5	H6	H7
						GF	KF										
20	9	9	M5	9	M5	14	12	7	6	M5 ²⁾	36	34	29.5	4.5	27	18	7
25	9	9	M6	9	M6	16	14	7	8	1/8 NPT	44	42	34.8	4.5	35	22	12
32	11	12	M6	9	M6	20	16	9	8	1/8 NPT	49	47	39	6	37	24.5	8.5
40	11	12	M8	9	M6	20	16	9	8	1/8 NPT	54	52	41.5	6	42	27	10

∅ [mm]	H8	H9	L3	L4	L5	L8	L10	L12	L21	T1	T2	T3	T4	T5	T6	T7	≅1
20	20	16.5	12	14	5.5	26	40	6	6,5	12	5.7	2.1	10	2.1	1.6	11	14
25	20	19	12	14	8.5	26	40	6	10	15	5.7	2.1	12	2.1	1.6	15	17
32	30	21	14	16	8.5	29	45	7	10	20	6.8	2.6	11	2.1	2.1	15	17
40	30	26	14	16	8.5	29	45	7	10	20	6.8	2.6	16	2.1	2.1	15	17

Stroke [mm]	Piston ∅ [mm]																				
	20					25					32					40					
	L1	L2	L7	L9 ±0.02 ¹⁾	L11	L1	L2	L7	L9 ±0.02 ¹⁾	L11	L1	L2	L7	L9 ±0.02 ¹⁾	L11	L1	L2	L7	L9 ±0.02 ¹⁾	L11	
20	105	82	9	20	-	111	90	7	20	-	118	95	7	20	-	-	96	-	-	-	
25	110	87				116	95				123	100				123	101	6	20		
30	115	92	19	-	-	121	100	17	20	-	133	105	12	20	-	-	106	-	-	-	
40	135	102				141	110				143	115				153	125	153	126		11
50	145	112	29	-	-	151	120	32	20	-	153	125	37	20	-	153	126	11	-	-	
80	185	142				196	150				208	155				208	156	36			
100	205	162	56	40	80	216	170	62	20	-	228	175	67	20	-	228	176	36	-	80	
125	257	187				271	195				283	200				283	201				
160	292	222	146	40	-	120	306	230	142	20	120	318	235	142	20	120	318	236	66	40	120
200	332	262				160	346	270			160	358	275			160	358	276			
250	472	312	146	40	-	200	476	320	142	20	200	483	325	142	20	200	483	326	141	200	
320	542	382				240	546	390			240	553	395			240	553	396			
400	622	462	320	626	470	320	633	475	320	633	476										

1) Tolerance between centring holes

2) Suitable for 10-32 UNF

-||- Note: This product conforms to ISO 1179-1 and to ISO 228-1

Note

If the guide rods project beyond the housing when the unit is in its retracted end position (→ dimension L7), a recess must be provided in the mounting surface if the unit is to be mounted against a surface in order to allow the guide rods to move freely.

When using a variable stroke, the dimensions L1, L2, L7, L9 and L11 correspond to the next longest standard stroke.

Guided drives DFM-N-B, NPT

Technical data

Dimensions

Download CAD data → www.festo.com

YSRW – Self-adjusting cushioning

∅ 20 ... 40 mm

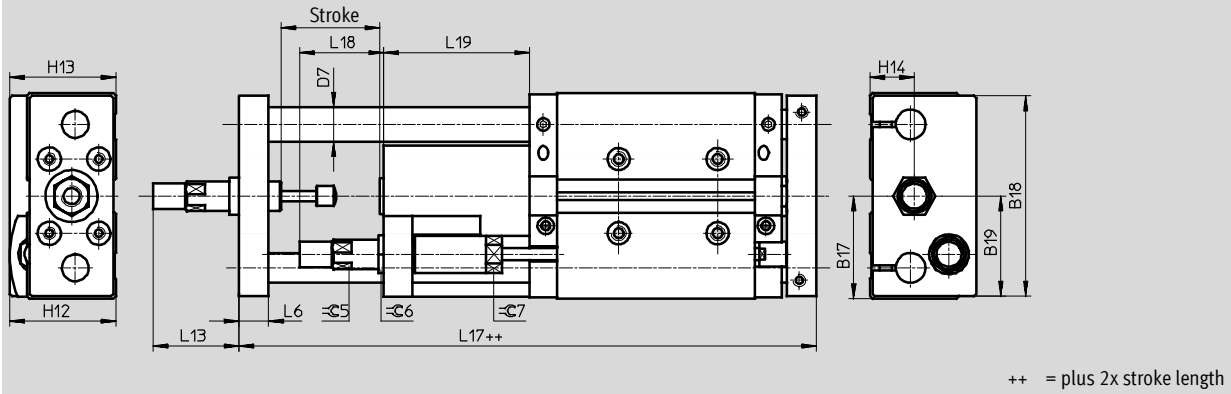

AJ/EJ – Precision stroke adjustment, advanced end position and retracted end position

∅ 20 ... 40 mm

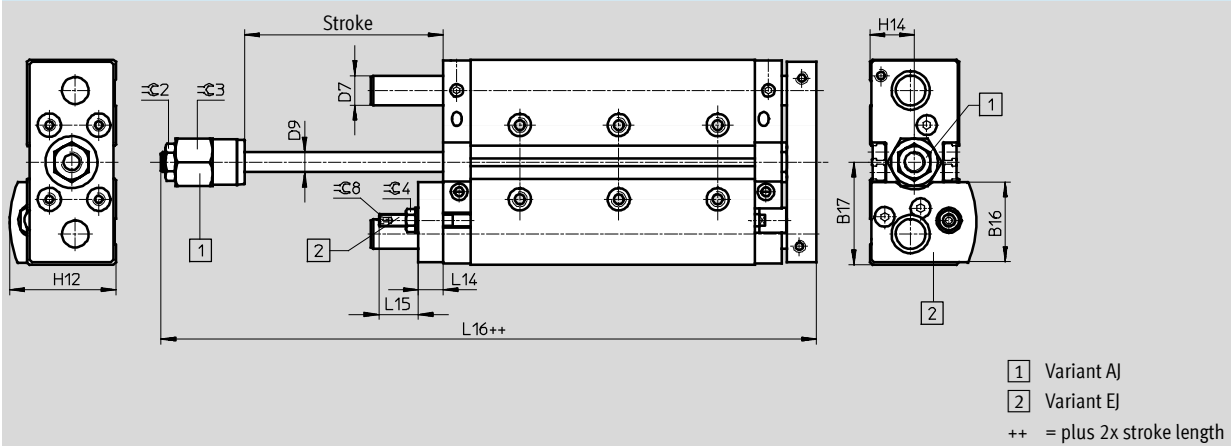

Guided drives DFM-N-B, NPT

Technical data

∅ [mm]	B16	B17	B18	B19	D7 ∅		D9 ∅	H12	H13	H14	L6	L13	L14
					GF	KF							
20	32.5	41.5	81	40.5	14	12	8	43	43	18	12	36.5	10
25	38.6	47.5	90	45	16	14	10	49.5	50.5	22	14	43	12
32	43.4	55	105	52.5	20	16	12	56.5	56	24.5	16	52	12
40	46.2	60	116	58	20	16	12	62.5	63.5	27	16	72	12

∅ [mm]	L15	L16	L17	L18	L19	≈C2	≈C3	≈C4	≈C5	≈C6	≈C7	≈C8
20	16	110	153.5	34	59	13	19	8	11	15	13	2.5
25	23.5	119.5	176.5	37.5	71	17	24	13	13	17	16	4
32	18.5	129.5	190.5	48.5	76	17	30	13	15	17	19	4
40	18.5	132	209.5	55.5	95	17	30	13	20	22	27	4

Guided drives DFM-N-B, NPT

Technical data

FESTO

Dimensions

Download CAD data → www.festo.com

∅ 50 ... 63 mm

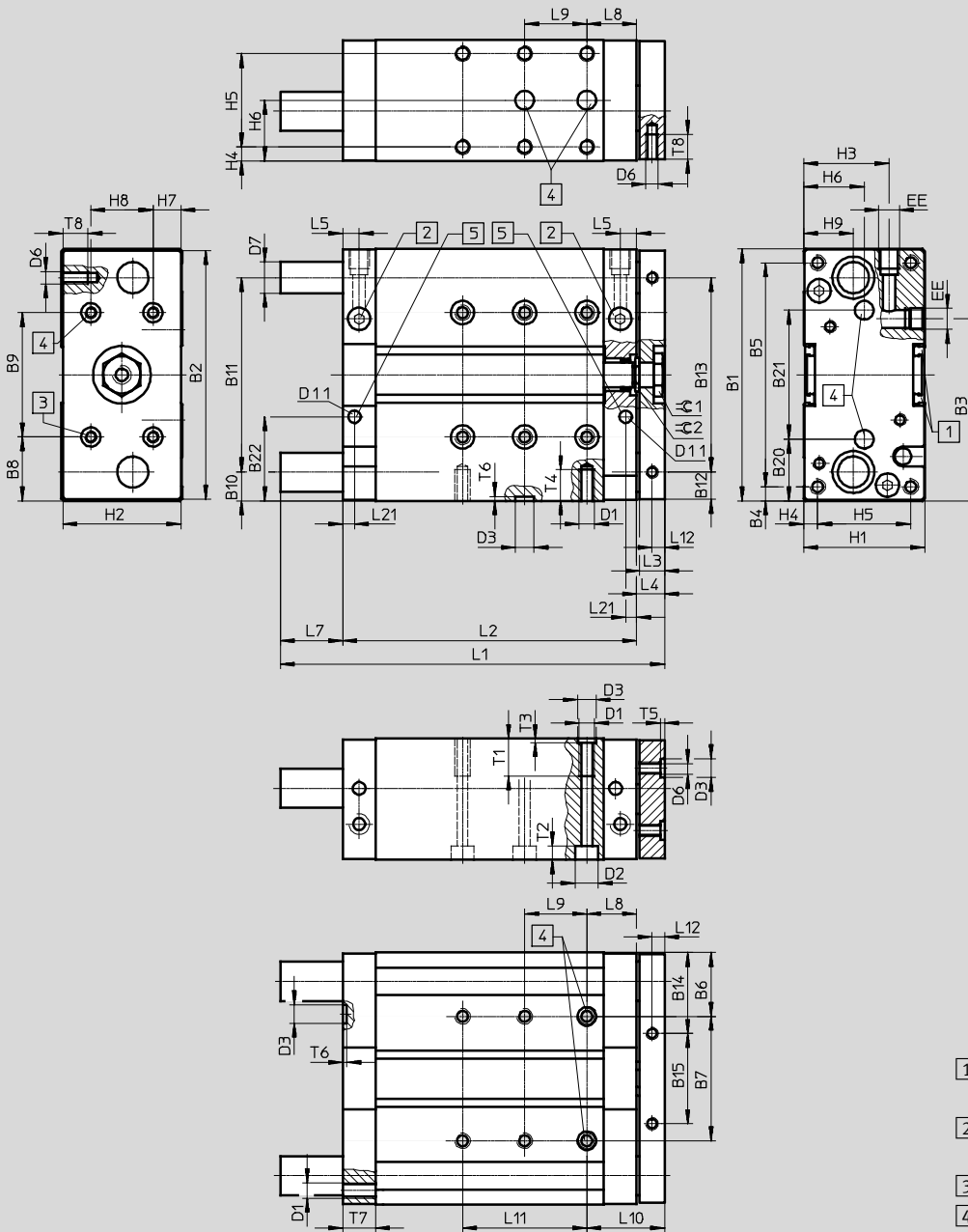

Guided drives DFM-N-B, NPT

Technical data

∅ [mm]	B1	B2	B3	B4	B5	B6	B7 ±0.02 ¹⁾	B8	B9 ±0.02 ¹⁾	B10	B11	B12	B13	B14	B15	B20	B21 ±0.02 ¹⁾
50	148	146	104.5	19	110	42	64	44	60	19	110	18	110	52	42	40	68
63	162	160	117	9	144	41	80	41	80	18.5	125	17.5	125	51	58	39.5	83

∅ [mm]	B22	D1	D2 ∅	D3 ∅ H7	D6 ∅	D7 ∅		D11 ∅	EE ²⁾	H1	H2	H3	H4	H5	H6	H7	H8
						GF	KF										
50	52.5	M8	11	12	M8	25	20	8	¼ NPT	64	62	48.5	7	50	32	12	40
63	54	M10	15	12	M8	25	20	8	¼ NPT	78	76	55	9	60	39	19	40

∅ [mm]	H9	L3	L4	L5	L8	L10	L12	L21	T1	T2	T3	T4	T5	T6	T7	T8	≈C1	≈C2
50	29	16	18	10.5	32	50	8	13.5	20	6.8	2.6	16	2.6	2.6	21	16	24	19
63	32	16	18	10.5	32	50	8	13.5	24	9	2.6	20	2.6	2.6	21	16	24	19

Stroke [mm]	Piston ∅ [mm]									
	50					63				
	L1	L2	L7	L9 ±0.02 ¹⁾	L11	L1	L2	L7	L9 ±0.02 ¹⁾	L11
25	137	113	6	20	-	137	114	5	20	-
50	177	138	21	40		177	139	20	40	
80	227	168	41		40	227	169	61		40
100	247	188		62		40	247		189	
125	293	213	139		40		293	214	138	40
160	328	248		139		40	120	328		
200	368	288	139		40		160	368	138	40
250	495	338		139		40	200	495		
320	565	408	139		40		240	565	138	40
400	645	488		139		40	320	645		

1) Tolerance between centring holes

2) Suitable for 10-32 UNF

-||- Note: This product conforms to ISO 1179-1 and to ISO 228-1

 Note

Since the guide rods project beyond the housing when the unit is in its retracted end position (→ dimension L7), a recess must be provided in the mounting surface if the unit is to be mounted against a surface in order to allow the guide rods to move freely.

When using a variable stroke, the dimensions L1, L2, L7, L9 and L11 correspond to the next longest standard stroke.

Guided drives DFM-N-B, NPT

Technical data



Dimensions

Download CAD data → www.festo.com

YSRW – Self-adjusting cushioning

Ø 50 ... 63 mm

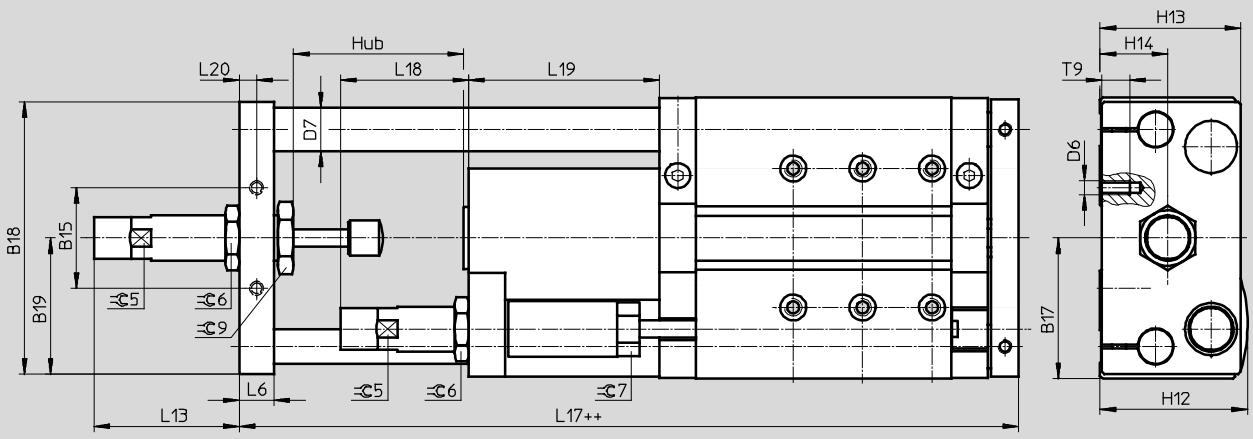

++ = plus 2x stroke length

AJ/EJ – Precision stroke adjustment, advanced end position and retracted end position

Ø 50 ... 63 mm

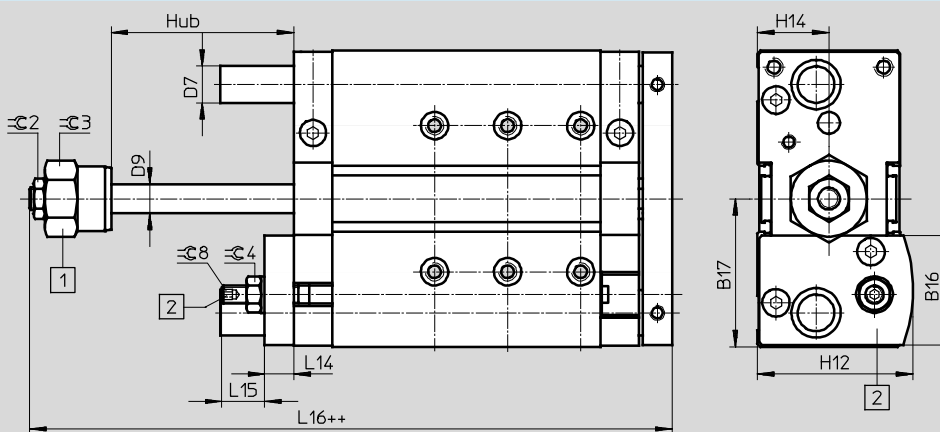

1 Variant AJ

2 Variant EJ

++ = plus 2x stroke length

Ø	B15	B16	B17	B18	B19	D6	D7		D9	H12	H13	H14	L6	L13	L14
							GF	KF							
50	42	57.6	74	157	72	M8	25	20	16	74	71	32	16	67.6	16
63	58	60	81	144	78.5	M8	25	20	16	81	81	39	20	83.3	16

Ø	L15	L16	L17	L18	L19	L20	T9	$\varnothing 2$	$\varnothing 3$	$\varnothing 4$	$\varnothing 5$	$\varnothing 6$	$\varnothing 7$	$\varnothing 8$	$\varnothing 9$
50	24.5	152.1	226.4	58.5	93	8	16	19	36	17	20	27	22	5	30
63	23.5	151.8	249.2	74	110	10	16	19	36	17	24	32	27	5	36

Guided drives DFM-N-B, NPT

Ordering data – Standard types

Ordering data – Plain-bearing guide GF						
Stroke [mm]	Part No. Type		Part No. Type		Part No. Type	
	Ø 12 mm		Ø 16 mm		Ø 20 mm	
10	570 547	DFM-N-12-10-B-P-A-GF	570 555	DFM-N-16-10-B-P-A-GF	–	–
20	570 548	DFM-N-12-20-B-P-A-GF	570 556	DFM-N-16-20-B-P-A-GF	570 563	DFM-N-20-20-B-P-A-GF
25	570 549	DFM-N-12-25-B-P-A-GF	570 557	DFM-N-16-25-B-P-A-GF	570 564	DFM-N-20-25-B-P-A-GF
30	570 550	DFM-N-12-30-B-P-A-GF	570 558	DFM-N-16-30-B-P-A-GF	570 565	DFM-N-20-30-B-P-A-GF
40	570 551	DFM-N-12-40-B-P-A-GF	570 559	DFM-N-16-40-B-P-A-GF	570 566	DFM-N-20-40-B-P-A-GF
50	570 552	DFM-N-12-50-B-P-A-GF	570 560	DFM-N-16-50-B-P-A-GF	570 567	DFM-N-20-50-B-P-A-GF
80	570 553	DFM-N-12-80-B-P-A-GF	570 561	DFM-N-16-80-B-P-A-GF	570 568	DFM-N-20-80-B-P-A-GF
100	570 554	DFM-N-12-100-B-P-A-GF	570 562	DFM-N-16-100-B-P-A-GF	570 569	DFM-N-20-100-B-P-A-GF
125	–	–	–	–	–	–
160	–	–	–	–	–	–
200	–	–	–	–	–	–
	Ø 25 mm		Ø 32 mm		Ø 40 mm	
10	–	–	–	–	–	–
20	570 570	DFM-N-25-20-B-P-A-GF	570 577	DFM-N-32-20-B-P-A-GF	–	–
25	570 571	DFM-N-25-25P-A-GF	570 578	DFM-N-32-25-B-P-A-GF	570 587	DFM-N-40-25-B-P-A-GF
30	570 572	DFM-N-25-30-B-P-A-GF	570 579	DFM-N-32-30-B-P-A-GF	–	–
40	570 573	DFM-N-25-40-B-P-A-GF	570 580	DFM-N-32-40-B-P-A-GF	–	–
50	570 574	DFM-N-25-50-B-P-A-GF	570 581	DFM-N-32-50-B-P-A-GF	570 588	DFM-N-40-50-B-P-A-GF
80	570 575	DFM-N-25-80-B-P-A-GF	570 582	DFM-N-32-80-B-P-A-GF	570 589	DFM-N-40-80-B-P-A-GF
100	570 576	DFM-N-25-100-B-P-A-GF	570 583	DFM-N-32-100-B-P-A-GF	570 590	DFM-N-40-100-B-P-A-GF
125	–	–	570 584	DFM-N-32-125-B-P-A-GF	570 591	DFM-N-40-125-B-P-A-GF
160	–	–	570 585	DFM-N-32-160-B-P-A-GF	570 592	DFM-N-40-160-B-P-A-GF
200	–	–	570 586	DFM-N-32-200-B-P-A-GF	570 593	DFM-N-40-200-B-P-A-GF
	Ø 50 mm		Ø 63 mm			
10	–	–	–	–		
20	–	–	–	–		
25	570 594	DFM-N-50-25-B-P-A-GF	570 601	DFM-N-63-25-B-P-A-GF		
30	–	–	–	–		
40	–	–	–	–		
50	570 595	DFM-N-50-50-B-P-A-GF	570 602	DFM-N-63-50-B-P-A-GF		
80	570 596	DFM-N-50-80-B-P-A-GF	570 603	DFM-N-63-80-B-P-A-GF		
100	570 597	DFM-N-50-100-B-P-A-GF	570 604	DFM-N-63-100-B-P-A-GF		
125	570 598	DFM-N-50-125-B-P-A-GF	570 605	DFM-N-63-125-B-P-A-GF		
160	570 599	DFM-N-50-160-B-P-A-GF	570 606	DFM-N-63-160-B-P-A-GF		
200	570 600	DFM-N-50-200-B-P-A-GF	570 607	DFM-N-63-200-B-P-A-GF		

Guided drives DFM-N-B, with plain-bearing guide GF, NPT



Ordering data – Modular products

M Mandatory data →

Module No.	Function	Thread	Piston Ø	Stroke	Generation	Cushioning	Position sensing	Guide
529 119	DFM	N	12	10 ... 400	B	P PPV	A	GF
529 120								
532 316								
532 317								
532 318								
532 319								
534 769								
534 770								
Ordering example								
532 319	DFM	- N	- 40	- 350	- B	- PPV	- A	- GF

Ordering table

Size	12	16	20	25	32	40	50	63	Condi- tions	Code	Enter code	
M Module No.	529 119	529 120	532 316	532 317	532 318	532 319	534 769	534 770				
Function	Guided drive									DFM	DFM	
Thread	NPT thread									N	-N	
Piston Ø [mm]	12	16	20	25	32	40	50	63		-...		
Stroke [mm]	10	10	-	-	-	-	-	-		-...		
	20	20	20	20	20	-	-	-		-...		
	25	25	25	25	25	25	25	25		-...		
	30	30	30	30	30	-	-	-		-...		
	40	40	40	40	40	-	-	-		-...		
	50	50	50	50	50	50	50	50		-...		
	80	80	80	80	80	80	80	80		-...		
	100	100	100	100	100	100	100	100		-...		
	125	125	125	125	125	125	125	125		-...		
	160	160	160	160	160	160	160	160		-...		
	200	200	200	200	200	200	200	200		-...		
	-	-	250	250	250	250	250	250		-...		
	-	-	320	320	320	320	320	320		-...		
-	-	400	400	400	400	400	400		-...			
Variable stroke [mm]	10 ... 200		20 ... 400			25 ... 400			¹	-		
Generation	B series									-B	-B	
Cushioning	Flexible cushioning rings/pads at both ends									-P		
	-	Pneumatic cushioning, adjustable at both ends									²	-PPV
Position sensing	Via proximity sensor									-A	-A	
Guide	Plain-bearing guide									-GF	-GF	

¹ ... Not with precision adjustment A)

² PPV Not with precision adjustment A), E)

Transfer order code

Guided drives DFM-N-B, with plain-bearing guide GF, NPT

Ordering data – Modular products

→ **0** Options

Temperature resistance	Precision adjustment advanced	Precision adjustment retracted	Accessories	Slot cover for sensor slot	Proximity sensor with cable	Proximity sensor, contactless with cable
S6	AJ	EJ	ZUB	...S	...G	...I
- S6 -	-	-	ZUB -	10S	1G	1I

Ordering table													
Size	12	16	20	25	32	40	50	63	Condi-tions	Code	Enter code		
0 Temperature resistance	Heat-resistant seals up to max. 120 °C								3	S6			
Precision adjustment advanced	Precision adjustment into the end positions, advanced									-AJ			
Precision adjustment retracted	-	-	Precision adjustment into the end positions, retracted									-EJ	
Accessories	Supplied separately									ZUB-	ZUB-		
Slot cover for sensor slot	1 ... 10									...S			
Proximity sensor	With cable, 2.5 m									...G			
	Contactless with cable, 2.5 m									...I			

3 **S6** Not with precision adjustment AJ, EJ

Transfer order code

- - - **ZUB** -

Guided drives DFM-B, with recirculating ball bearing guide KF, NPT

Ordering data – Modular products

M Mandatory data →

Module No.	Function	Thread	Piston Ø	Stroke	Generation	Cushioning	Position sensing	Guide
529 119	DFM	N	12	10 ... 400	B	P PPV YSRW	A	KF
529 120								
532 316								
532 317								
532 318								
532 319								
534 769								
534 770								
Ordering example								
532 319	DFM	N	40	400	B	P	A	KF

Ordering table

Size	12	16	20	25	32	40	50	63	Condi- tions	Code	Enter code
M Module No.	529 119	529 120	532 316	532 317	532 318	532 319	534 769	534 770			
Function	Guided drive									DFM	DFM
Thread	NPT thread									N	-N
Piston Ø [mm]	12	16	20	25	32	40	50	63		-...	
Stroke [mm]	10	10	-	-	-	-	-	-		-...	
	20	20	20	20	20	-	-	-		-...	
	25	25	25	25	25	25	25	25		-...	
	30	30	30	30	30	-	-	-		-...	
	40	40	40	40	40	-	-	-		-...	
	50	50	50	50	50	50	50	50		-...	
	80	80	80	80	80	80	80	80		-...	
	100	100	100	100	100	100	100	100		-...	
	125	125	125	125	125	125	125	125		-...	
	160	160	160	160	160	160	160	160		-...	
	200	200	200	200	200	200	200	200		-...	
	-	-	250	250	250	250	250	250		-...	
	-	-	320	320	320	320	320	320		-...	
-	-	400	400	400	400	400	400		-...		
Variable stroke [mm]	10 ... 200		20 ... 400			25 ... 400			¹	-...	
Generation	B series									-B	-B
Cushioning	Flexible cushioning rings/pads at both ends									-P	
	-	Pneumatic cushioning, adjustable at both ends							²	-PPV	
	-	Shock absorber, self-adjusting, progressive							³	-YSRW	
Position sensing	Via proximity sensor									-A	-A
Guide	Recirculating ball bearing guide									-KF	-KF

¹ ... Not with precision adjustment AJ, cushioning YSRW

³ YSRW Not with precision adjustment AJ, EJ, since already integrated

² PPV Not with precision adjustment AJ, EJ

Transfer order code

DFM - **N** - - - **B** - - **A** - **KF**

Guided drives DFM-B, with recirculating ball bearing guide KF, NPT

Ordering data – Modular products

→ **Options**

Precision adjustment advanced	Precision adjustment retracted	Accessories	Slot cover for sensor slot	Proximity sensor with cable	Proximity sensor, contactless with cable
AJ	EJ	ZUB	...S	...G	...I
- AJ	- EJ	ZUB	- 10S	1G	1I

Ordering table													
Size	12	16	20	25	32	40	50	63	Condi- tions	Code	Enter code		
Options Precision adjustment advanced	Precision adjustment into the end positions, advanced									-AJ			
Precision adjustment retracted	-	-	Precision adjustment into the end positions, retracted									-EJ	
Accessories	Supplied separately									ZUB-	ZUB-		
Slot cover for sensor slot	1 ... 10									...S			
Proximity sensor	With cable, 2.5 m									...G			
	Contactless with cable, 2.5 m									...I			

Transfer order code

- - **ZUB** -

Guided drives DFM-N-B, NPT

Accessories

FESTO

Centring sleeve ZBH

Material:
High-alloy steel

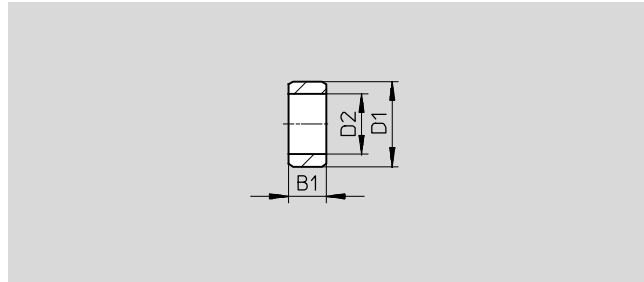

Dimensions and ordering data (repeat order)							
B1	D1	D2	CRC ¹⁾	Weight	Part No.	Type	PU ²⁾
-0.2	∅ h7	∅		[g]			
2.4	5	3.2	2	1	189 652	ZBH-5	10
3	7	5.3	2	1	186 717	ZBH-7	10
4	9	6.4	2	1	150 927	ZBH-9	10
5	12	10.3	2	1	189 653	ZBH-12	10

- 1) Corrosion resistance class 2 to Festo standard 940 070
Components subject to moderate corrosion stress. Externally visible parts with primarily decorative surface requirements which are in direct contact with a normal industrial environment or media such as coolants or lubricating agents
- 2) Packaging unit

Centring sleeves included in the scope of delivery			
DFM-N-B	Piston ∅ [mm]	Centring sleeves	
		For housing	For yoke plate
	12	2x ZBH-5, 2x ZBH-9	2x ZBH-5
	16	2x ZBH-5, 2x ZBH-9	2x ZBH-5
	20	2x ZBH-7, 2x ZBH-9	2x ZBH-9
	25	2x ZBH-7, 2x ZBH-9	2x ZBH-9
	32	2x ZBH-9, 2x ZBH-12	2x ZBH-9
	40	2x ZBH-9, 2x ZBH-12	2x ZBH-9
	50	2x ZBH-12	2x ZBH-12
	63	2x ZBH-12	2x ZBH-12



Ordering data – Slot cover for T-slot				
	Assembly	Length	Part No.	Type
	Insertable from above	2x 0.5 m	151 680	ABP-5-S



Ordering data – Proximity sensors for T-slot, magneto-resistive						Technical data → Internet: smt
	Type of mounting	Switch output	Electrical connection	Cable length [m]	Part No.	Type
N/O contact						
	Insertable in the slot from above, flush with cylinder profile, short design	PNP	Cable, 3-wire	2.5	574335	SMT-8M-A-PS-24V-E-2,5-OE
			Plug M8x1, 3-pin	0.3	574334	SMT-8M-A-PS-24V-E-0,3-M8D
		NPN	Plug M12x1, 3-pin	0.3	574337	SMT-8M-A-PS-24V-E-0,3-M12
			Cable, 3-wire	2.5	574338	SMT-8M-A-NS-24V-E-2,5-OE
			Plug M8x1, 3-pin	0.3	574339	SMT-8M-A-NS-24V-E-0,3-M8D
N/C contact						
	Insertable in the slot from above, flush with cylinder profile, short design	PNP	Cable, 3-wire	7.5	574340	SMT-8M-A-PO-24V-E-7,5-OE

Guided drives DFM-N-B, NPT

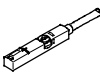
Accessories

FESTO

Ordering data – Proximity sensors for T-slot, magnetic reed						Technical data → Internet: sme	
	Type of mounting	Switching output	Electrical connection	Cable length [m]	Part No.	Type	
N/O contact							
	Insertable in the slot from above, flush with the cylinder profile	Contacting	Cable, 3-wire	2.5	543 862	SME-8M-DS-24V-K-2,5-OE	
				5.0	543 863	SME-8M-DS-24V-K-5,0-OE	
			Plug M8x1, 3-pin	2.5	543 872	SME-8M-ZS-24V-K-2,5-OE	
				0.3	543 861	SME-8M-DS-24V-K-0,3-M8D	
	Insertable in the slot lengthwise, flush with the cylinder profile	Contacting	Cable, 3-wire	2.5	150 855	SME-8-K-LED-24	
				0.3	150 857	SME-8-S-LED-24	
N/C contact							
	Insertable in the slot from above, flush with the cylinder profile	Contacting	Cable, 3-wire	7.5	546 799	SME-8M-DO-24V-K-7,5-OE	

Ordering data – Connecting cables					Technical data → Internet: nebu	
	Electrical connection, left	Electrical connection, right	Cable length [m]	Part No.	Type	
	Straight socket, M8x1, 3-pin	Cable, open end, 3-wire	2.5	541 333	NEBU-M8G3-K-2.5-LE3	
			5	541 334	NEBU-M8G3-K-5-LE3	
	Straight socket, M12x1, 5-pin	Cable, open end, 3-wire	2.5	541 363	NEBU-M12G5-K-2.5-LE3	
			5	541 364	NEBU-M12G5-K-5-LE3	
	Angled socket, M8x1, 3-pin	Cable, open end, 3-wire	2.5	541 338	NEBU-M8W3-K-2.5-LE3	
			5	541 341	NEBU-M8W3-K-5-LE3	
	Angled socket, M12x1, 5-pin	Cable, open end, 3-wire	2.5	541 367	NEBU-M12W5-K-2.5-LE3	
			5	541 370	NEBU-M12W5-K-5-LE3	

Ordering data – One-way flow control valves				Technical data → Internet: grla		
	Connection		Material	Part No.	Type	
	Thread	For tubing O.D. [inch]				
	M5 ¹⁾	1/8	Plastic design ²⁾	564 839	GRLA-10-32-UNF-QB-1/8-U	
		5/32	Metal design ³⁾	564 840	GRLA-10-32-UNF-QB-5/32-U	
		1/4		564 842	GRLA-10-32-UNF-QB-1/4-U	
	1/8 NPT	5/32		534 656	GRLA-1/8-QB-5/32-U	
		1/4		534 658	GRLA-1/8-QB-1/4-U	
		5/16		534 659	GRLA-1/8-QB-5/16-U	
	1/4 NPT	1/4		534 661	GRLA-1/4-QB-1/4-U	
		5/16		534 662	GRLA-1/4-QB-5/16-U	
		3/8		190 947	GRLA-1/4-NPT-QS-3/8-U	

- 1) Suitable for 10-32 UNF
- 2) Operating pressure range -0.95 ... +8 bar
- 3) Operating pressure range 1 ... 9 bar