

Fieldbus modules CTEU/installation system CTEL



Fieldbus modules CTEU/installation system CTEL

Key features

FESTO



The system

- Fieldbus modules CTEU for using valve terminals
 - Festo-specific interface (I-Port)
 - Input modules CTSL for detecting sensor signals
 - Cost savings since less hardware is required for valve terminals with a large number of valves on the fieldbus
 - Direct and simple networking of valve terminals and other devices via fieldbus
 - Wide range of applications thanks to high protection to IP65/67
 - Universal connection technology (Sub-D, M12, terminal strip)
 - Optional, decentralised installation of the bus node for connecting two valve terminals
 - Basic diagnostics: undervoltage, short circuit
- CTEU for universal use of valve terminals. The Festo-specific, uniformly defined interface (I-Port) enables the bus modules to be used for different valve types.
- The following protocols are currently supported:
- CANOpen
 - DeviceNet
 - CC-Link
 - PROFIBUS
 - EtherCAT

Valve terminal configurator

Online via: → www.festo.com

A valve terminal configurator is available online to help you select a suitable valve terminal. Select the valve terminal with I-Port interface and order the associated bus node CTEU. The bus nodes then only

need to be placed on the valve terminal. The ident. code of the valve terminals specifies the valve functions, the number of valves, vacant positions as well as the additional functions and

the type of compressed air supply. As is the case with all Festo products, all valve terminals are supplied:

- Fully pre-assembled
- Equipped with fittings on request

- Tested for electrical function
- Tested for pneumatic function
- Securely packaged
- Manuals can be downloaded free of charge

Fieldbus modules CTEU/installation system CTEL

Key features

Fieldbus systems with CTEU



CANopen

A fieldbus system based on CAN. Standardised by the "CAN in Automation" (CiA) user group. CANopen is characterised by its multi-master capability and high protocol efficiency. It is used throughout industrial automation.



DeviceNet

An open fieldbus system based on CAN technology originally developed for the automotive sector. DeviceNet was developed by Rockwell (Allen-Bradley) and is now an open standard. It is frequently used in OMRON controllers.



CC-Link

"Control and Communications Link" (CC-Link) was developed by Mitsubishi Electric and has been available as an open fieldbus network since 1999.



PROFIBUS

Process fieldbus (PROFIBUS) is a fieldbus developed by Siemens and standardised in the IEC 61158 series of international standards that enables communication between devices without the need for any specific interface adaptations.



EtherCAT

EtherCAT was developed by Beckhoff and the EtherCAT Technology Group (ETG). EtherCAT is an open technology that is standardised in the international standards IEC 61158 and IEC 61784 as well as in ISO 15745-4. It is a high-speed industrial Ethernet system that is also suitable for use in time-critical motion control applications.

Fieldbus modules CTEU/installation system CTEL

Key features

Classification of the I-Port interface/IO-Link

Different bus nodes are used for integration into the control systems of various manufacturers.

The following protocols are supported with the compatible node CTEU:

- CANopen
- DeviceNet
- EtherCAT
- CC-Link
- PROFIBUS

A second valve terminal can be connected via a decentralised electrical sub-base (→ page 5).

System overview, example

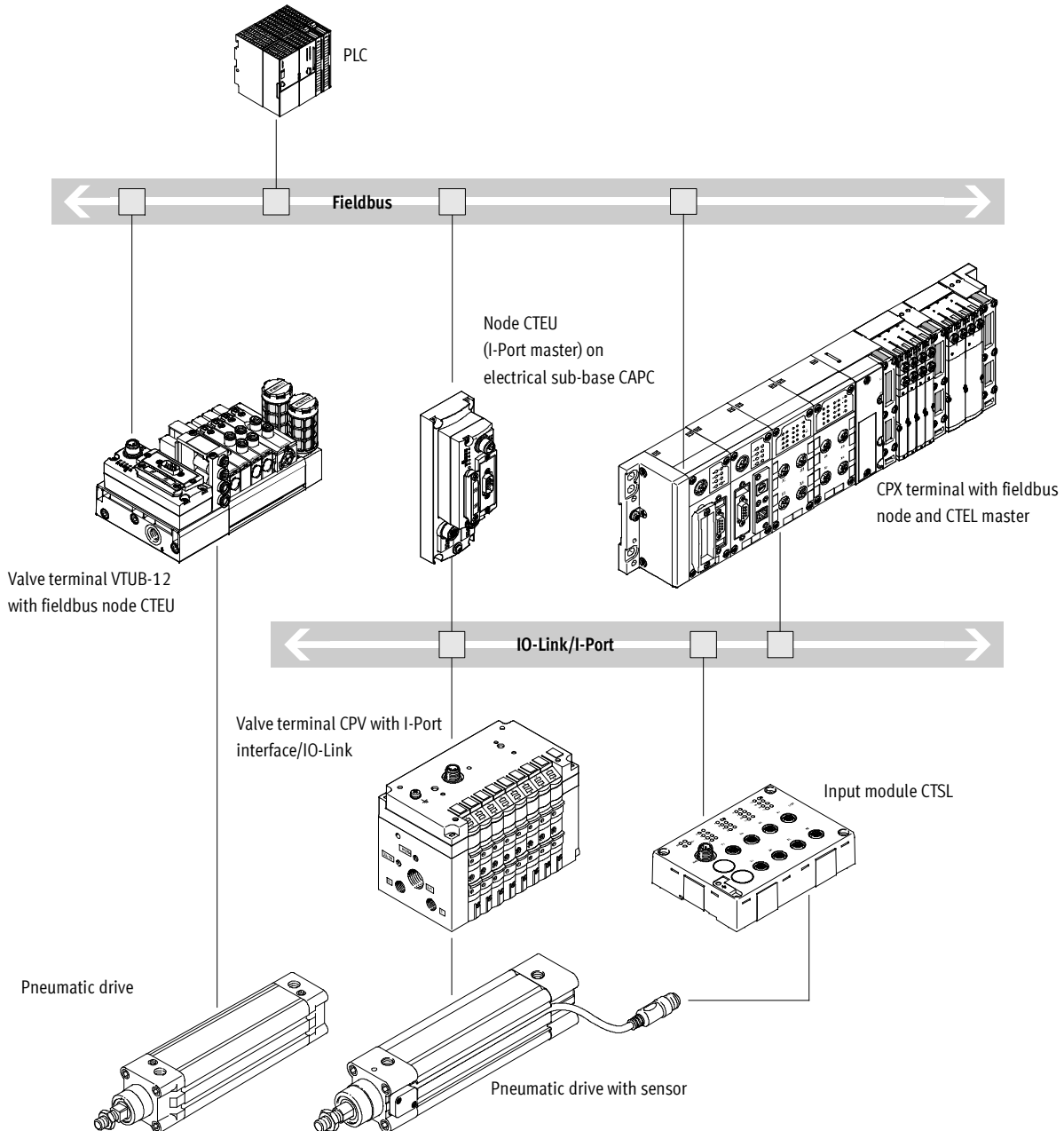

- Communication with higher-level controller via fieldbus
- Use the fieldbus node CTEU compatible with the fieldbus protocol
- Up to 64 inputs/outputs (solenoid coils), depending on the valve terminal

Fieldbus modules CTEU/installation system CTEL

Peripherals overview

Overview of CTEU with valve terminal VTUG

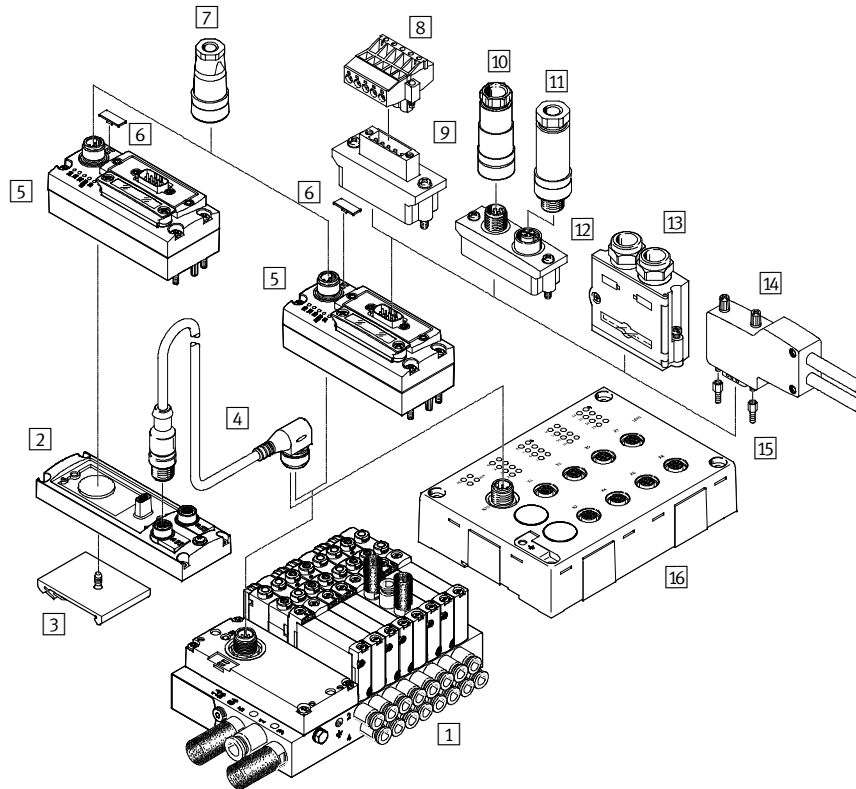

Accessories				
	Type	Brief description	→ Page/Internet	
1	Manifold rail	VABM	With I-Port interface, for connecting max. 35 valves	vtug
2	Electrical sub-base	CAPC	For connecting a further terminal (2 x I-Port interfaces)	12
3	H-rail adapter	CAFM	For electrical sub-base CAPC	12
4	Connecting cable	NEBU	For IO-Link	10, 12
5	Bus node	CTEU	–	14, 18, 24, 28, 34
6	Inscription label	ASLR	For bus nodes	aslr
7	Power supply socket	NTSD	For power supply	17, 22, 27, 32, 36
8	Terminal strip	FBSD-KL	For Open Style connection	17/22
9	Bus connection	FBA-1	Open Style for 5-pin terminal strip	17/22
10	Fieldbus socket	FBSD-GD, NECU	For Micro Style connection, M12, 5-pin	17/22, 32
11	Plug	FBS, NECU	For Micro Style connection, M12, 5-pin	17/22, 32
12	Bus connection	FBA-2	Micro Style, 2xM12, 5-pin	17/22, 32
13	Plug	FBS-SUB-9-BU	Sub-D	17/22, 32
14	Plug	FBS-SUB-9-WS	Sub-D, angled	17, 32
15	Threaded sleeve	UNC	Sub-D mounting bolt	17, 22, 27, 32
16	Input module	CTSL-D-16E	–	53

Fieldbus modules CTEU/installation system CTEL

Key features – Diagnostics

CTEU system diagnostics

Diagnostic LEDs on the fieldbus node CTEU

The fieldbus-specific LEDs indicate the communication status and the fieldbus function.

A further LED indicates the status of the power supply:

- Undervoltage/short circuit
- Power supply guaranteed
- Interruption of voltage

Diagnostic messages via the fieldbus

- Configuration error
- Short circuit/overload of output module
- Short circuit/undervoltage
- Undervoltage/load voltage of valves

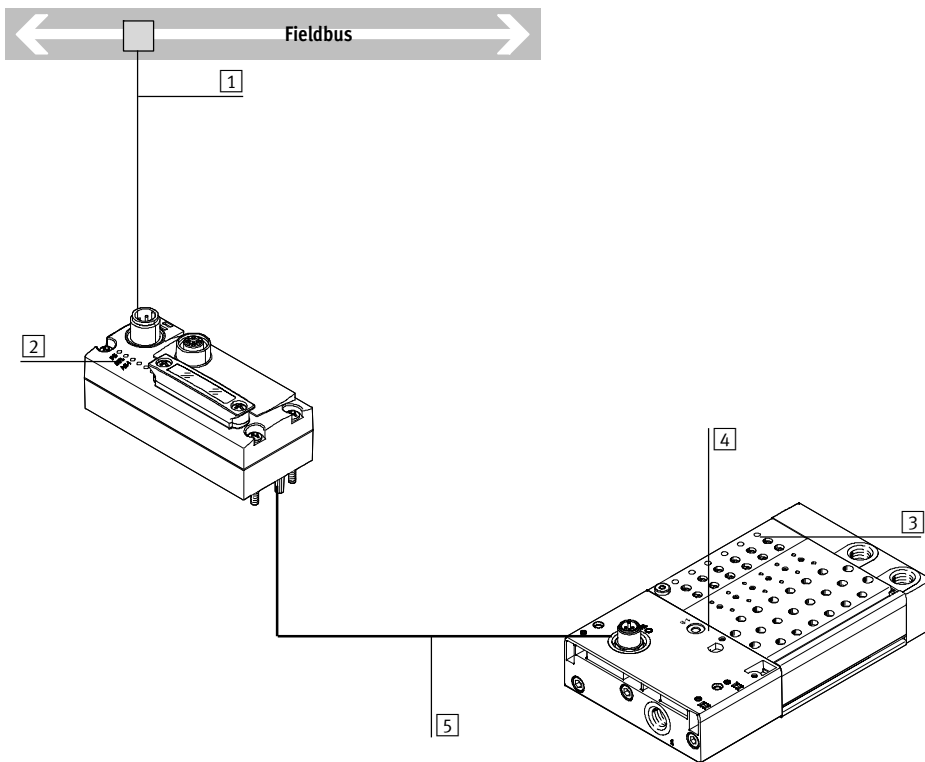

- 1 Diagnostics via fieldbus
- 2 Bus-specific LEDs
- 3 Switching position display via one LED per valve (on the manifold rail)
- 4 Additional communication and voltage status LED for decentralised installation
- 5 I-Port interface with the fieldbus module

Fieldbus modules CTEU/installation system CTEL

Key features – Power supply

Operating voltage and load current supply

The operating voltages for the valve terminal with I-Port interface are centrally connected via a 5-pin M12 plug on the bus node.

The operating voltages are required for the electronics of the fieldbus node and the load supply for the valves (supplied separately from the

electronics supply). The power supplies do not have a common 0 V and are therefore

completely galvanically isolated from each other.

Example of the power supply concept for the CTEU with valve terminal VTUG

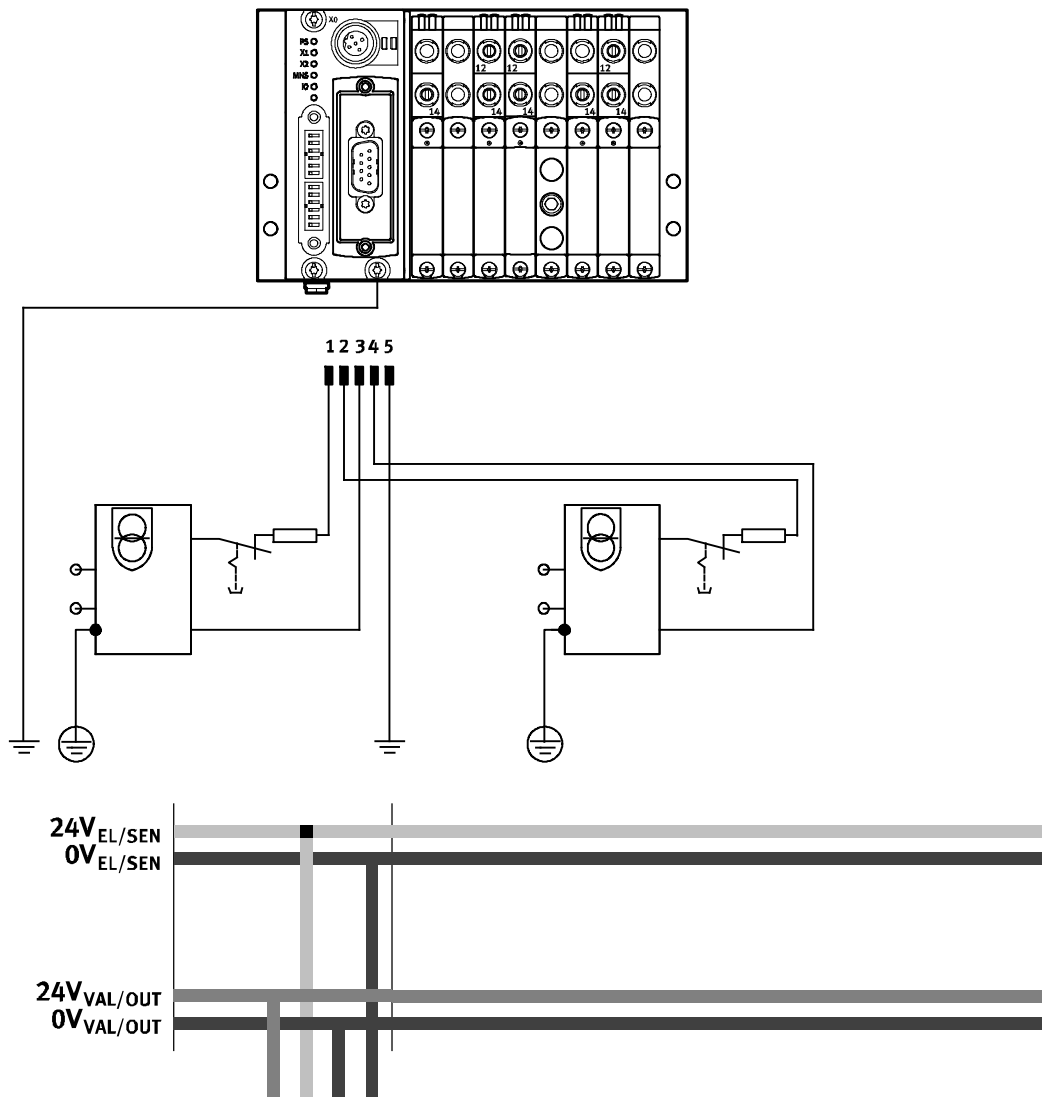

Fieldbus modules CTEU/installation system CTEL

Key features – Power supply

Power supply concept

Example of the power supply concept for the CTEU with decentralised electrical sub-base CAPC and valve terminal VTUG

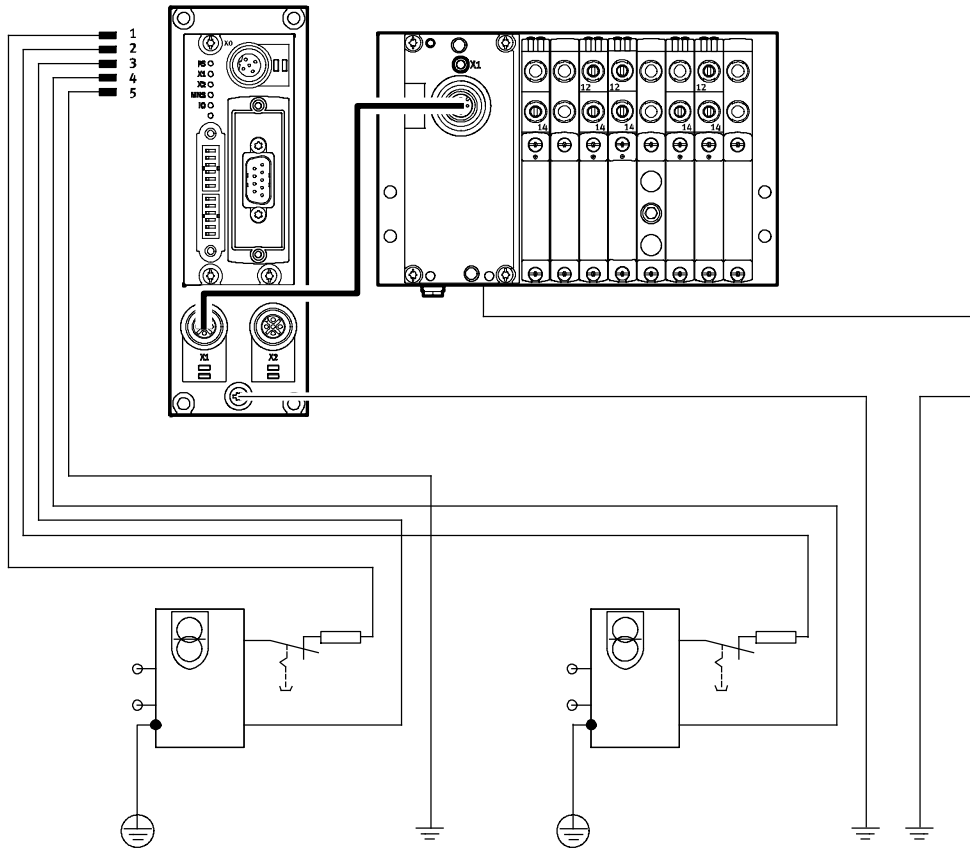

Fieldbus modules CTEU/installation system CTEL

Technical data – I-Port interface/IO-Link of the valve terminal VTUG

Festo-specific, standardised interface for direct connection to the fieldbus by mounting the bus node CTEU or to an IO-Link master via a cable (in IO-Link mode).

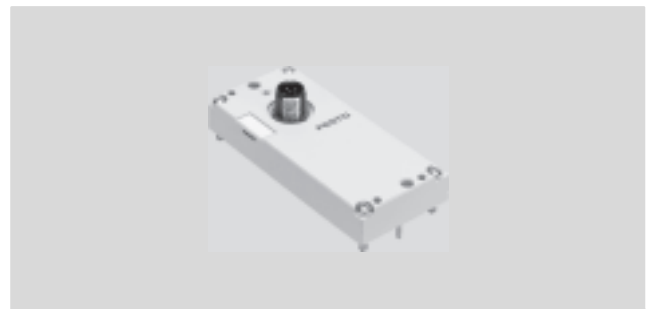

I-Port interface/IO-Link

<p>Versions:</p> <ul style="list-style-type: none"> • I-Port interface for fieldbus nodes (CTEU) • IO-Link mode for direct connection to a higher-level IO-Link master 	<p>The electrical supply/transmission of communication data takes place via an M12 plug.</p>	<p>The following protocols are supported:</p> <ul style="list-style-type: none"> • CANopen • DeviceNet 	<ul style="list-style-type: none"> • CC-Link • PROFIBUS • EtherCAT
--	--	--	---

General technical data

Communication types		IO-Link
Electrical connection		<ul style="list-style-type: none"> • M12 plug, 5-pin • A-coded • Metal thread for screening
Baud rates	COM3	[kbps] 230.4
	COM2	[kbps] 38.4
Intrinsic current consumption, logic supply PS		[mA] 30
Intrinsic current consumption, valve supply PL		[mA] 30
Max. number of solenoid coils	VAEM-L1-S-8-PT	16
	VAEM-L1-S-16-PT	32
	VAEM-L1-S-24-PT	48
Max. number of valve positions	VAEM-L1-S-8-PT	8
	VAEM-L1-S-16-PT	16
	VAEM-L1-S-24-PT	24
Ambient temperature		[°C] -5 ... +50
Protection class to EN 60529		IP67

LED display

	Colour	Status	Function
Status LED X1	Red/green	Off	No 24 V logic
	2	Status green	Everything OK
	3	Flashing green	Communication error (in the I-Port or IO-Link protocol)
	4	Flashing red/green	Load supply fault (undervoltage or no load supply)
	5	Static red	Load supply fault and communication error

Pin allocation – I-Port interface/IO-Link

	Pin	Allocation	Description
	1	24V _{EL/SEN}	Operating voltage supply (electronic, sensors/inputs)
	2	24V _{VAL/OUT}	Load voltage supply (valves/outputs)
	3	0V _{EL/SEN}	Operating voltage supply (electronic, sensors/inputs)
	4	C/Q	Data communication
	5	0V _{VAL/OUT}	Load voltage supply (valves/outputs)

Fieldbus modules CTEU/installation system CTEL

FESTO

Technical data – I-Port interface/IO-Link of the valve terminal VTUG

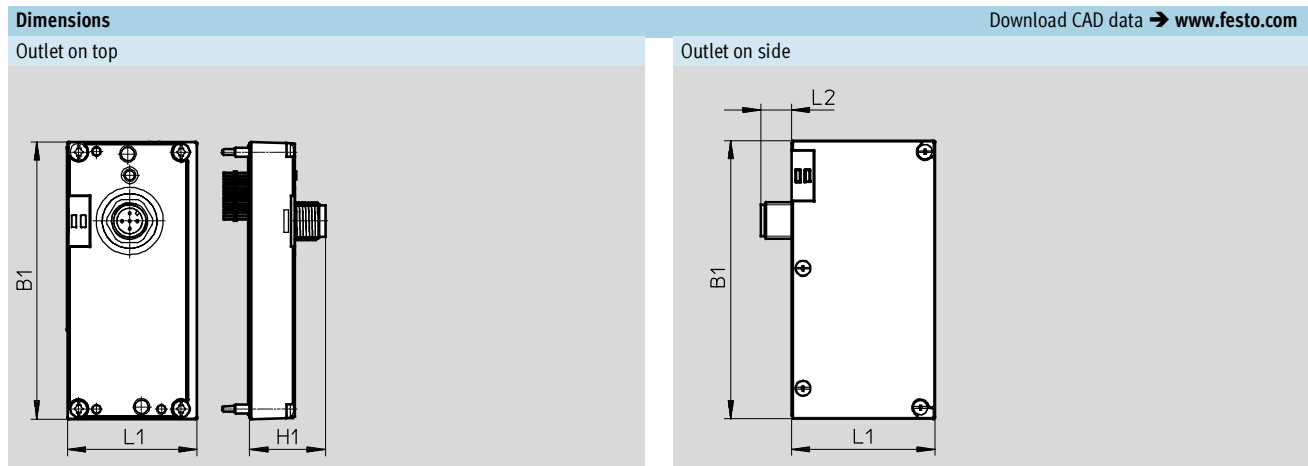

Type	Outlet on top			Outlet on side		
	B1	L1	H1	B1	L1	L2
VAEM-L1-S-...	91	47.1	25	91.5	47.1	10

Accessories – I-Port interface/IO-Link			
	Description	Part No.	Type
Electrical interface for I-Port interface/IO-Link, outlet on top			
	Actuation of up to 8 double solenoid valve positions	573384	VAEM-L1-S-8-PT
	Actuation of up to 16 double solenoid valve positions	573939	VAEM-L1-S-16-PT
	Actuation of up to 24 double solenoid valve positions	573940	VAEM-L1-S-24-PT
Electrical interface for I-Port interface/IO-Link, outlet on side			
	Actuation of up to 8 double solenoid valve positions	574207	VAEM-L1-S-8-PTL
	Actuation of up to 16 double solenoid valve positions	574208	VAEM-L1-S-16-PTL
	Actuation of up to 24 double solenoid valve positions	574209	VAEM-L1-S-24-PTL
Connection technology for I/O-Link			
	T-adapter M12, 5-pin for IO-Link and load supply	171175	FB-TA-M12-5POL
Straight plug, for I-Port/IO-Link			
	Straight plug, M12, 5-pin (in combination with adapter for separate load supply)	175487	SEA-M12-5GS-PG7
Inscription label for I-Port/IO-Link			
	40 pieces in frame	565306	ASLR-C-E4
Connecting cable			
		574321	NEBU-M12G5-E-5-Q8N-M12G5
		574322	NEBU-M12G5-E-7.5-Q8N-M12G5
		574323	NEBU-M12G5-E-10-Q8N-M12G5

Fieldbus modules CTEU/installation system CTEL

Technical data – electrical sub-base CAPC

Function

The electrical sub-base CAPC enables decentralised installation of fieldbus nodes CTEU on a valve terminal or input modules with I-Port interface.

Application

- M12 connection technology (two interfaces)
- Enables installation of valve terminals or other devices over a distance of 20 metres
- Accessory CAFM enables the electrical sub-base to be installed on an H-rail



General technical data		
Type		CAPC-F1-E-M12
Dimensions W x L x H	[mm]	50 x 148 x 28
Fieldbus interface		2x M12 socket, 5-pin
Operating voltage range	[V DC]	18 ... 30
Max. power supply	[A]	2
Nominal operating voltage	[V DC]	24
Product weight	[g]	85
Cable length	[m]	20

Materials	
Housing	PA reinforced
Note on materials	RoHS-compliant

Operating and environmental conditions	
Protection class to EN 60529	IP65, IP67
Ambient temperature	[°C] -5 ... +50
Storage temperature	[°C] -20 ... +70
Corrosion resistance class CRC	2 ¹⁾
CE marking (see declaration of conformity)	To EU EMC Directive ²⁾

1) Corrosion resistance class 2 according to Festo standard 940 070
Components subject to moderate corrosion stress. Externally visible parts with primarily decorative surface requirements which are in direct contact with a normal industrial environment or media such as coolants or lubricating agents.

2) For information about the applicability of the component see the manufacturer's EC declaration of conformity at: www.festo.com → Support → User documentation.
If the component is subject to restrictions on usage in residential, office or commercial environments or small businesses, further measures to reduce the emitted interference may be necessary.

Fieldbus modules CTEU/installation system CTEL

Technical data – electrical sub-base CAPC



Dimensions Download CAD data → www.festo.com

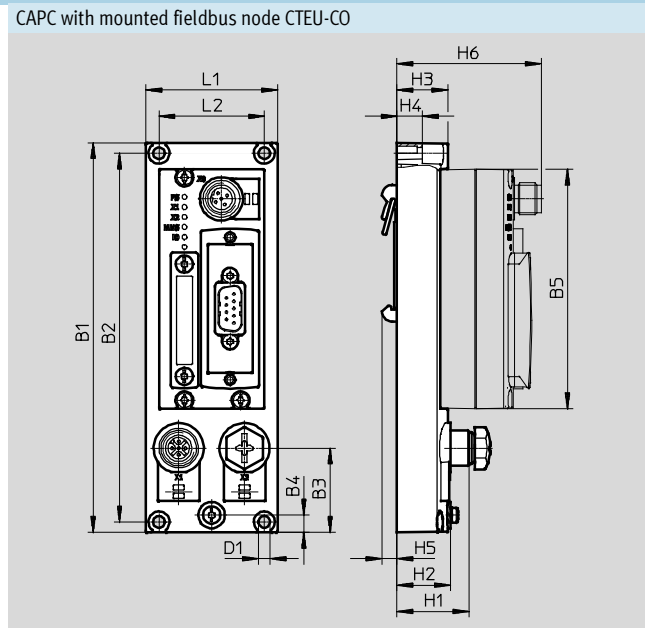
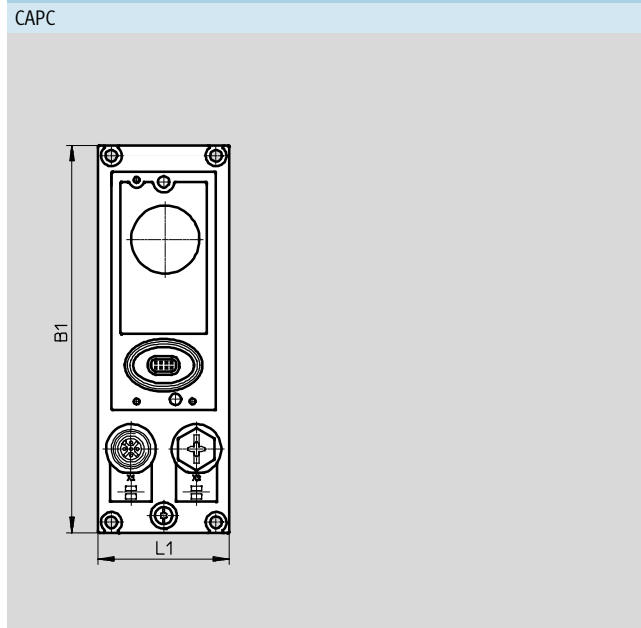

Type	B1	B2	B3	B4	B5	D1-∅	H1	H2	H3	H4	H5	H6	L1	L2
CAPC	148	140	32	6.6	91	4.4	27.3	20.3	19.3	9.6	5.7	54.8	50	40

Pin allocation – Power supply/IO-Link interfaces

	Pin	Allocation	Description
	1	24V _{EL/SEN}	Operating voltage supply (electronic, sensors/inputs)
	2	24V _{VAL/OUT}	Load voltage supply (valves/outputs)
	3	0V _{EL/SEN}	Operating voltage supply (electronic, sensors/inputs)
	4	C/Q	Data communication
	5	0V _{VAL/OUT}	Load voltage supply (valves/outputs)
	Housing, FE		

Accessories – CAPC

	Description	Part No.	Type
Electrical sub-base			
	-	570042	CAPC-F1-E-M12
H-rail mounting			
	-	570043	CAFM-F1-H
Connecting cable			
	-	574321	NEBU-M12G5-E-5-Q8N-M12G5
		574322	NEBU-M12G5-E-7.5-Q8N-M12G5
		574323	NEBU-M12G5-E-10-Q8N-M12G5

Fieldbus modules CTEU/installation system CTEL

Technical data – CTEU-CO



The bus node handles communication between the valve terminal and a higher-level CANopen® master.

The module has basic diagnostic functions. It has 5 integrated LEDs for on-site display. Max. 8 byte inputs and 8 byte outputs are transmitted in the cyclic process image.



Application

Fieldbus connection

The bus connection is established via a 9-pin Sub-D plug (pin) as per the CAN in Automation (CiA) specification DS 102 with additional 24 V CAN transceiver supply (option as per DS 102).

The bus connector plug (with protection class IP65/IP67 from Festo or IP20 from other manufacturers) facilitates the connection of an incoming and an outgoing bus cable.

There are 4 contacts each available for the conductors (CAN_L/CAN_H and 24 V/0 V optional) of the incoming and outgoing bus cables.

The fieldbus parameters and the basic device parameter settings are set on the bus node via DIL switches.

Implementation

Protocol chip used:

- CAN transceiver 82C251

Baud rates supported:

- 125 kbps
- 250 kbps
- 500 kbps
- 1 Mbps

Max. CANopen cable length (trunk cable):

- 40 m at 1 Mbps
- 100 m at 500 kbps
- 250 m at 250 kbps
- 500 m at 125 kbps

Max. branch line length (drop cable):

- 0.30 m at 1 Mbps
- 0.75 m at 500 kbps
- 2.00 m at 250 kbps
- 3.75 m at 125 kbps

The following variants can be realised using an adapter:

- 2x Micro Style M12, protection class IP65, 5-pin, socket and pin
- Open Style plug, protection class IP20, 5-pin, pin

Fieldbus modules CTEU/installation system CTEL

Technical data – CTEU-CO

General technical data			
Fieldbus interface			<ul style="list-style-type: none"> • Sub-D socket, 9-pin • Sub-D plug, for self-assembly • 2x M12x1, 5-pin • Terminal strip, 5-pin
Protocol			CANopen
Baud rates		[kbps]	125, 250, 500 and 1,000
Internal cycle time			1 ms per 1 byte of user data
Operating voltage	Nominal value	[V DC]	24
	Permissible range	[V DC]	18 ... 30
Intrinsic current consumption at nominal operating voltage		[mA]	Typically 65
Max. power supply		[A]	4
Parameterisation			Diagnostic behaviour Fail state
Max. address capacity, inputs			8 byte
Max. address capacity, outputs			8 byte
Additional functions			<ul style="list-style-type: none"> • Emergency message • Acyclic data access via "SDO"
Operating elements			DIL switch
Configuration support			EDS files
Device-specific diagnostics			<ul style="list-style-type: none"> • System diagnostics • Undervoltage • Communication error
LED display	Fieldbus-specific		<ul style="list-style-type: none"> • MNS: Network status • IO: I/O status
	Product-specific		<ul style="list-style-type: none"> • PS: Operating voltage for electronics and load supply • X1: System status of module at I-Port 1 • X2: System status of module at I-Port 2
Protection class to EN 60529			IP65/IP67
Note on materials			RoHS-compliant
Housing materials			<ul style="list-style-type: none"> • PC • PA reinforced
Product weight		[g]	90
Temperature range	Environment	[°C]	-5 ... +50
	Storage	[°C]	-20 ... +70
Dimensions W x L x H		[mm]	40 x 91 x 50
Corrosion resistance class CRC			2 ¹⁾
CE marking			To EU EMC Directive ²⁾
Certification			C-Tick

- 1) Corrosion resistance class 2 according to Festo standard 940 070
Components subject to moderate corrosion stress. Externally visible parts with primarily decorative surface requirements which are in direct contact with a normal industrial environment or media such as coolants or lubricating agents.
- 2) For information about the applicability of the component see the manufacturer's EC declaration of conformity at: www.festo.com → Support → User documentation.
If the component is subject to restrictions on usage in residential, office or commercial environments or small businesses, further measures to reduce the emitted interference may be necessary.

Fieldbus modules CTEU/installation system CTEL

Technical data – CTEU-CO

Dimensions Download CAD data → www.festo.com
 CTEU-CO



Type	B1	H1	L1
CTEU-CO	91	39.8	40

Pin allocation

	Pin	Allocation	Description
Sub-D, 9-pin, CANopen interface			
	1	n.c.	Not connected
	2	CAN_L	Received/transmitted data low
	3	CAN_GND	0 V CAN interface (connected to pin 6)
	4	n.c.	Not connected
	5	CAN_Shld	Optional screened connection
	6	GND	0 V CAN interface, optional (connected to pin 3)
	7	CAN_H	Received/transmitted data high
	8	n.c.	Not connected
	9	CAN_V+	24 V DC supply for CAN interface
Housing			Cable screen, connection to functional earth FE
Power supply, M12, B-coded			
	1	24 V _{EL/SEN}	Operating voltage supply (electronic, sensors/inputs)
	2	24 V _{VAL/OUT}	Load voltage supply (valves/outputs)
	3	0 V _{EL/SEN}	Operating voltage supply (electronic, sensors/inputs)
	4	0 V _{VAL/OUT}	Load voltage supply (valves/outputs)
	5	FE	Functional earth

Fieldbus modules CTEU/installation system CTEL

Technical data – CTEU-CO







Pin allocation – CANopen interface			
Fieldbus plug/adaptor	Pin	Allocation	Description
Bus connection, FBA-2-M12-5POL			
	1	FE	Functional earth
	2	CAN_V+	24 V DC supply for CAN interface
	3	CAN_GND	0 V CAN interface
	4	CAN_H	Received/transmitted data high
	5	CAN_L	Received/transmitted data low
Bus connection, FBA-1-SL-5POL with FBSD-KL-2X5POL			
	1	CAN_GND	0 V CAN interface
	2	CAN_L	Received/transmitted data low
	3	FE	Functional earth
	4	CAN_H	Received/transmitted data high
	5	CAN_V+	24 V DC supply for CAN interface

Connection and display components	
	<ul style="list-style-type: none"> 1 Status LEDs (operating status/diagnostics) 2 DIL switches 3 Power supply for bus node and connected devices (valve terminal) 4 Fieldbus connection (Sub-D plug)

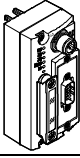
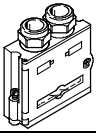
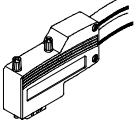
Fieldbus modules CTEU/installation system CTEL

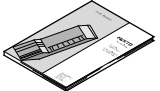

Accessories – CTEU-CO

Ordering data		Part No.	Type
Bus node			
	CANopen bus node	570038	CTEU-CO
Bus connection			
	Sub-D plug, straight, A-coded	532219	FBS-SUB-9-BU-2x5POL-B
	Sub-D plug, angled, A-coded	533783	FBS-SUB-9-WS-CO-K
	Micro Style bus connection, 2xM12, 5-pin, A-coded	525632	FBA-2-M12-5POL
	Fieldbus socket for Micro Style connection	18324	FBSD-GD-9-5POL
	Plug for Micro Style connection, M12, 5-pin	175380	FBS-M12-5GS-PG9
	Open Style bus connection	525634	FBA-1-SL-5POL
	Terminal strip for Open Style connection, 5-pin	525635	FBSD-KL-2x5POL
Fitting			
	Threaded sleeve for Sub-D	533000	UNC4-40/M3X8
Plug socket			
	For power supply	538999	NTSD-GD-9-M12-5POL-RK
Manual			
	Manual Bus node CTEU-CO	German	573767 P.BE-CTEU-CO-OP+MAINT-DE
		English	573768 P.BE-CTEU-CO-OP+MAINT-EN
		Spanish	573769 P.BE-CTEU-CO-OP+MAINT-ES
		French	573770 P.BE-CTEU-CO-OP+MAINT-FR
		Italian	573771 P.BE-CTEU-CO-OP+MAINT-IT
		Chinese	573772 P.BE-CTEU-CO-OP+MAINT-ZH

Fieldbus modules CTEU/installation system CTEL

Technical data – CTEU-DN

FESTO



The bus node handles communication between the valve terminal and a higher-level DeviceNet® master.

The module has basic diagnostic functions. It has 5 integrated LEDs for on-site display. Up to 8 byte inputs and 8 byte outputs are typically transmitted in the cyclic process image.



Application

Fieldbus connection

The bus connection is established via a 9-pin Sub-D socket with a typical allocation (to EN 50170).

The bus connector plug (with protection class IP65/IP67 from Festo or IP20 from other manufacturers) facilitates the connection of an

incoming and an outgoing bus cable. The fieldbus parameters and the basic device parameter settings are

set on the bus node via DIL switches.

Implementation

Protocol chip used:

- CAN transceiver 82C251

Baud rates supported:

- 125 kbps
- 250 kbps
- 500 kbps

Max. DeviceNet cable length (trunk cable):

- 100 m at 500 kbps
- 250 m at 250 kbps
- 500 m at 125 kbps

Max. branch line length (drop cable):

- 6 m at 500 kbps
- 6 m at 250 kbps
- 6 m at 125 kbps

The following variants can be realised using an adapter:

- 2x Micro Style M12, protection class IP65, 5-pin, socket and pin
- Open Style plug, protection class IP20, 5-pin, pin

Fieldbus modules CTEU/installation system CTEL

Technical data – CTEU-DN

General technical data			
Fieldbus interface		<ul style="list-style-type: none"> • Sub-D socket, 9-pin • Sub-D plug, for self-assembly • 2x M12x1, 5-pin • Terminal strip, 5-pin 	
Protocol		DeviceNet	
Baud rates	[kpbs]	125, 250, 500	
Internal cycle time		1 ms per 1 byte of user data	
Operating voltage	Nominal value	[V DC]	24
	Permissible range	[V DC]	18 ... 30
Intrinsic current consumption at nominal operating voltage		[mA]	Typically 120
Max. power supply		[A]	4
Parameterisation		Diagnostic behaviour Failsafe and idle response	
Max. address capacity, inputs		8 byte	
Max. address capacity, outputs		8 byte	
Additional functions		<ul style="list-style-type: none"> • Acyclic data access via "Explicit Message" • Quickconnect • System status can be displayed using process data 	
Operating elements		DIL switch	
Configuration support		EDS files	
Device-specific diagnostics		<ul style="list-style-type: none"> • System diagnostics • Undervoltage • Communication error 	
LED display	Fieldbus-specific		<ul style="list-style-type: none"> • MNS: Network status • IO: I/O status
	Product-specific		<ul style="list-style-type: none"> • PS: Operating voltage for electronics and load supply • X1: System status of module at I-Port 1 • X2: System status of module at I-Port 2
Protection class to EN 60529		IP65/IP67	
Note on materials		RoHS-compliant	
Housing materials		<ul style="list-style-type: none"> • PC • PA reinforced 	
Product weight		[g]	90
Temperature range	Environment		[°C] -5 ... +50
	Storage		[°C] -20 ... +70
Dimensions W x L x H		[mm]	40 x 91 x 50
Corrosion resistance class CRC		2 ¹⁾	
CE marking		To EU EMC Directive ²⁾	
Certification		C-Tick	

- 1) Corrosion resistance class 2 according to Festo standard 940 070
Components subject to moderate corrosion stress. Externally visible parts with primarily decorative surface requirements which are in direct contact with a normal industrial environment or media such as coolants or lubricating agents.
- 2) For information about the applicability of the component see the manufacturer's EC declaration of conformity at: www.festo.com → Support → User documentation.
If the component is subject to restrictions on usage in residential, office or commercial environments or small businesses, further measures to reduce the emitted interference may be necessary.

Fieldbus modules CTEU/installation system CTEL

Technical data – CTEU-DN

Dimensions Download CAD data → www.festo.com
 CTEU-DN

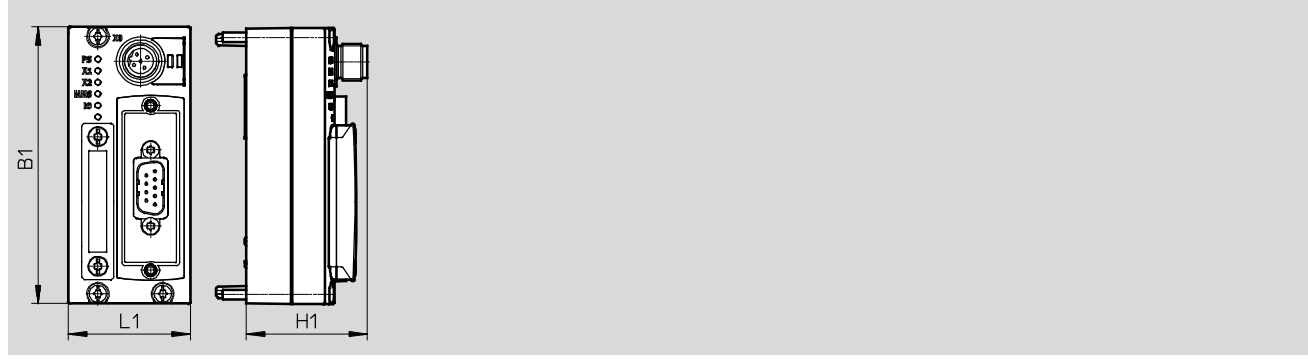

Type	L1	H1	B1
CTEU-DN	91	39.8	40

Pin allocation

	Pin	Allocation	Description
--	-----	------------	-------------

Sub-D, 9-pin, DeviceNet interface			
	1	n.c.	Not connected
	2	CAN_L	Received/transmitted data low
	3	CAN_GND	0 V CAN interface (connected to pin 6)
	4	n.c.	Not connected
	5	CAN_Shld	Optional screened connection
	6	GND	0 V CAN interface, optional (connected to pin 3)
	7	CAN_H	Received/transmitted data high
	8	n.c.	Not connected
	9	CAN_V+	24 V DC supply for CAN interface
	Housing		

Power supply, M12, B-coded			
	1	24 V _{EL/SEN}	Operating voltage supply (electronic, sensors/inputs)
	2	24 V _{VAL/OUT}	Load voltage supply (valves/outputs)
	3	0 V _{EL/SEN}	Operating voltage supply (electronic, sensors/inputs)
	4	0 V _{VAL/OUT}	Load voltage supply (valves/outputs)
	5	FE	Functional earth

Fieldbus modules CTEU/installation system CTEL

Technical data – CTEU-DN

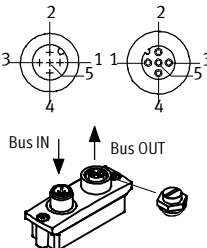
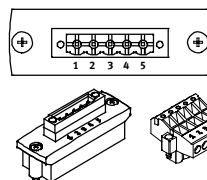

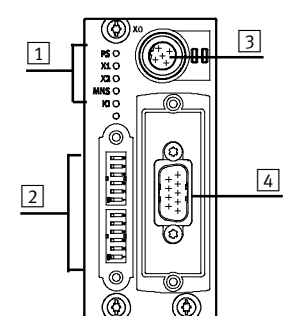



Pin allocation – DeviceNet interface			
Fieldbus plug/adapter	Pin	Allocation	Description
Bus connection, FBA-2-M12-5POL			
	1	FE	Functional earth
	2	CAN_V+	24 V DC supply for CAN interface
	3	CAN_GND	0 V CAN interface
	4	CAN_H	Received/transmitted data high
	5	CAN_L	Received/transmitted data low
Bus connection, FBA-1-SL-5POL with FBSD-KL-2X5POL			
	1	CAN_GND	0 V CAN interface
	2	CAN_L	Received/transmitted data low
	3	FE	Functional earth
	4	CAN_H	Received/transmitted data high
	5	CAN_V+	24 V DC supply for CAN interface

Connection and display components	
	<ol style="list-style-type: none"> 1 Status LEDs (operating status/diagnostics) 2 DIL switch group 3 Power supply for bus node and connected devices (valve terminal) 4 Fieldbus connection (Sub-D plug)

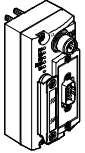
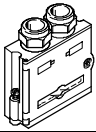
Fieldbus modules CTEU/installation system CTEL

FESTO

Accessories – CTEU-DN

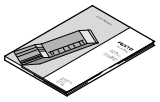
Ordering data		Part No.	Type
Bus node			
	DeviceNet bus node	570039	CTEU-DN
Bus connection			
	Sub-D plug, straight	532219	FBS-SUB-9-BU-2x5POL-B
	Micro Style bus connection, 2xM12, 5-pin, A-coded	525632	FBA-2-M12-5POL
	Fieldbus socket for Micro Style connection, M12, 5-pin	18324	FBSD-GD-9-5POL
	Plug for Micro Style connection, M12, 5-pin	175380	FBS-M12-5GS-PG9
	Open Style bus connection	525634	FBA-1-SL-5POL
	Terminal strip for Open Style connection, 5-pin	525635	FBSD-KL-2x5POL
Fitting			
	Threaded sleeve for Sub-D	533000	UNC4-40/M3X8
Plug socket			
	For power supply	538999	NTSD-GD-9-M12-5POL-RK
Manual			
	Manual Bus node CTEU-DN	German	573744 P.BE-CTEU-DN-OP+MAINT-DE
		English	573745 P.BE-CTEU-DN-OP+MAINT-EN
		Spanish	573746 P.BE-CTEU-DN-OP+MAINT-ES
		French	573747 P.BE-CTEU-DN-OP+MAINT-FR
		Italian	573748 P.BE-CTEU-DN-OP+MAINT-IT
	Chinese	573779 P.BE-CTEU-DN-OP+MAINT-ZH	

Fieldbus modules CTEU/installation system CTEL

Technical data – CTEU-CC



The bus node handles communication between the valve terminal and a higher-level Control & Communication-Link (CC-Link®) master.

The module has basic diagnostic functions. It has 5 integrated LEDs for on-site display. Up to 8 byte inputs and 8 byte outputs are transmitted in the cyclic process image.



Application

Fieldbus connection

The bus connection is established by means of a screw terminal with IP20 protection and a 9-pin Sub-D plug with IP65/IP67 protection from Festo or IP20 protection from other manufacturers.

The module features a system and load supply, a fieldbus connection and a connection to the valve terminal with serial I-Port interface.

Both connection types have the function of an integrated T-distributor and thus support the connection of an incoming and outgoing bus cable.

The integrated interface with RS 485 transmission technology is designed for the typical CC-Link 3-wire connection technology (in accordance with CLPA CC-Link Spec. V1.1).

Implementation

Protocol chip used:

- MFP3 from Mitsubishi

Max. CC-Link cable length (at least 0.2 m between devices):

- 100 m at 10 Mbps
- 150 m at 5 Mbps
- 200 m at 2.5 Mbps
- 600 m at 625 kbps
- 1,200 m at 156 kbps

If using branch lines: max. branch line length 8 m, max. 6 stations per branch line

Main string length:

- 100 m at 625 kbps, total branch line length 50 m
- 500 m at 156 kbps, total branch line length 200 m

Higher baud rate not permitted with branch lines.

The following variants can be realised using an adapter:

- Spring-loaded terminal In/Out with IP65 protection (adapter 532220)
- Screw terminal plug with IP20 protection (adapter 197962)

Fieldbus modules CTEU/installation system CTEL

Technical data – CTEU-CC

General technical data			
Fieldbus interface			<ul style="list-style-type: none"> • Sub-D socket, 9-pin • Sub-D plug, for self-assembly • Screw terminal strip, IP20
Protocol			CC-Link
Baud rates	[kbps]		156 ... 10,000
Internal cycle time			1 ms per 1 byte of user data
Operating voltage	Nominal value	[V DC]	24
	Permissible range	[V DC]	18 ... 30
Intrinsic current consumption at nominal operating voltage		[mA]	Typically 70
Max. power supply		[A]	4
Max. address capacity, inputs			16 byte
Max. address capacity, outputs			16 byte
Operating elements			DIL switch
Device-specific diagnostics			<ul style="list-style-type: none"> • System diagnostics • Undervoltage • Communication error
Additional functions			<ul style="list-style-type: none"> • System status can be displayed using process data
Parameterisation			<ul style="list-style-type: none"> • Activate diagnostics • Failsafe and idle response
LED display	Fieldbus-specific		<ul style="list-style-type: none"> • Err: Data transmission error • Run: Bus active
	Product-specific		<ul style="list-style-type: none"> • PS: Operating voltage for electronics and load supply • X1: System status of module at I-Port 1 • X2: System status of module at I-Port 2
Protection class to EN 60529			IP65/IP67
Note on materials			RoHS-compliant
Housing materials			<ul style="list-style-type: none"> • PC • PA reinforced
Product weight		[g]	90
Temperature range	Environment	[°C]	-5 ... +50
	Storage	[°C]	-20 ... +70
Dimensions W x L x H		[mm]	40 x 91 x 50
Product weight		[g]	90
Certification			cULus listed (OL)
Corrosion resistance class CRC			2 ¹⁾
CE marking			To EU EMC Directive ²⁾
Certification			C-Tick

- 1) Corrosion resistance class 2 according to Festo standard 940 070
Components subject to moderate corrosion stress. Externally visible parts with primarily decorative surface requirements which are in direct contact with a normal industrial environment or media such as coolants or lubricating agents.
- 2) For information about the applicability of the component see the manufacturer's EC declaration of conformity at: www.festo.com → Support → User documentation.
If the component is subject to restrictions on usage in residential, office or commercial environments or small businesses, further measures to reduce the emitted interference may be necessary.

Fieldbus modules CTEU/installation system CTEL

Technical data – CTEU-CC

Dimensions Download CAD data → www.festo.com
 CTEU-CC

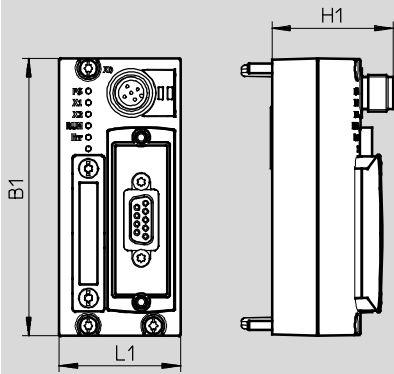

Type	B1	H1	L1
CTEU-CC	91	39.8	40

Pin allocation			
	Pin	Allocation	Description
Sub-D plug, 9-pin, CC Link interface			
	1	n.c.	Not connected
	2	DA	Data A
	3	DG	Data ground
	4	n.c.	Not connected
	5	n.c.	Not connected
	6	n.c.	Not connected
	7	DB	Data B
	8	n.c.	Not connected
	9	n.c.	Not connected
		Housing	
Power supply, M12, A-coded			
	1	24 V _{EL/SEN}	Operating voltage supply (electronic, sensors/inputs)
	2	24 V _{VAL/OUT}	Load voltage supply (valves/outputs)
	3	0 V _{EL/SEN}	Operating voltage supply (electronic, sensors/inputs)
	4	0 V _{VAL/OUT}	Load voltage supply (valves/outputs)
	5	FE	Functional earth

Fieldbus modules CTEU/installation system CTEL



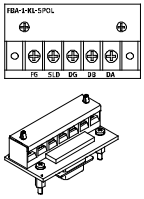
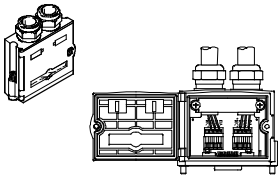

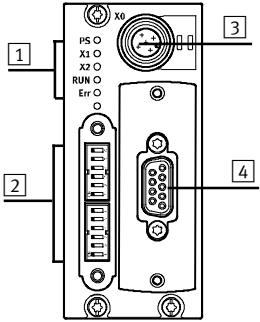
Technical data – CTEU-CC-Link

Pin allocation – CC-Link interface		
Fieldbus plug/adapter	Pin	Description
Bus connection with terminal strip, FBA-1-KL-5POL		
	FE	Functional earth
	SLD	Cable screen
	DG	Data ground
	DB	Data B
	DA	Data A
Bus connection, FBS-SUB-9-GS-24XPOL-B		
	DA	Data A
	DB	Data B
	DG	Data ground
	n.c.	Not connected
	FE	Connected to the housing of the Sub-D plug via the clamp strap

Connection and display components	
	<ol style="list-style-type: none"> 1 Status LEDs (operating status/diagnostics) 2 DIL switches 3 Power supply for bus node and connected devices (valve terminal) 4 Fieldbus connection (Sub-D plug)

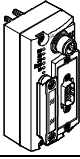
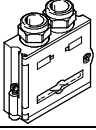
Fieldbus modules CTEU/installation system CTEL

Accessories – CTEU-CC-Link

Ordering data		Part No.	Type
Bus node			
	CC-Link bus node	1544198	CTEU-CC
Bus connection			
	Sub-D plug, straight	532220	FBS-SUB-9-GS-2x4POL-B
	Screw terminal bus connection	197962	FBA-1-KL-5POL
Fitting			
	Threaded sleeve for Sub-D	533000	UNC4-40/M3X8
Plug socket			
	For power supply, M12x1, 5-pin	18324	FBSD-GD-9-5POL

Fieldbus modules CTEU/installation system CTEL

Technical data – CTEU-PB



The bus node handles communication between the valve terminal and a higher-level PROFIBUS DP® master.

The module has basic diagnostic functions. It has 4 integrated LEDs for on-site display. Up to 8 byte inputs and 8 byte outputs are transmitted in the cyclic process image.



Application

Fieldbus connection

The bus connection is established via a 9-pin Sub-D socket with a typical PROFIBUS allocation (to EN 50170).

The bus connector plug (with protection class IP65/IP67 from Festo or IP20 from other manufacturers) facilitates the connection of an incoming and an outgoing bus cable.

An active bus terminal can be connected using the DIL switch integrated in the plug.

The Sub-D interface is designed for controlling network components with a fibre-optic cable connection.

Baud rate/cable length overview

Baud rates supported:

- 9.6 kbps
- 19.2 kbps
- 93.75 kbps
- 187.5 kbps
- 500 kbps
- 1.5 Mbps
- 3 - 12 Mbps

Maximum fieldbus length:

- 1,200 m
- 1,200 m
- 1,200 m
- 1,000 m
- 400 m
- 200 m
- 100 m

Maximum branch line length:

- 500 m
- 500 m
- 100 m
- 33.3 m
- 20 m
- 6.6 m
- –

- RS 485 transceiver used: Analog Devices ADM 2485
- PROFIBUS slave controller used: Profichip VPC+S

Fieldbus modules CTEU/installation system CTEL

Technical data – CTEU-PB

General technical data			
Fieldbus interface			<ul style="list-style-type: none"> • Sub-D socket, 9-pin • Sub-D plug, for self-assembly • 2x M12x1, 5-pin, B-coded
Protocol			PROFIBUS DP
Baud rates		[kbps]	9.6, 19.2, 93.75, 187.5, 500
		[Mbps]	1.5, 12
Internal cycle time			1 ms per 1 byte of user data
Operating voltage	Nominal value	[V DC]	24
	Permissible range	[V DC]	18 ... 30
Intrinsic current consumption at nominal operating voltage		[mA]	Typically 100
Max. power supply		[A]	2
Parameterisation			Diagnostic behaviour Failsafe response
Max. address capacity, inputs			16 byte
Max. address capacity, outputs			16 byte
Additional functions			<ul style="list-style-type: none"> • System status via diagnostic programme • Emergency message
Operating elements			DIL switch
Configuration support			GSD files
Device-specific diagnostics			<ul style="list-style-type: none"> • System diagnostics • Undervoltage • Communication error
LED display	Fieldbus-specific		• BF: Bus error
	Product-specific		<ul style="list-style-type: none"> • PS: Operating voltage for electronics and load supply • X1: System status of module at I-Port 1 • X2: System status of module at I-Port 2
Protection class to EN 60529			IP65/IP67
Note on materials			RoHS-compliant
Housing materials			<ul style="list-style-type: none"> • PC • PA reinforced
Product weight		[g]	90
Temperature range	Environment	[°C]	-5 ... +50
	Storage	[°C]	-20 ... +70
Dimensions W x L x H		[mm]	40 x 91 x 50
Corrosion resistance class CRC			2 ¹⁾
CE marking			To EU EMC Directive ²⁾
Certification			C-Tick

- 1) Corrosion resistance class 2 according to Festo standard 940 070
Components subject to moderate corrosion stress. Externally visible parts with primarily decorative surface requirements which are in direct contact with a normal industrial environment or media such as coolants or lubricating agents.
- 2) For information about the applicability of the component see the manufacturer's EC declaration of conformity at: www.festo.com → Support → User documentation.
If the component is subject to restrictions on usage in residential, office or commercial environments or small businesses, further measures to reduce the emitted interference may be necessary.

Fieldbus modules CTEU/installation system CTEL

Technical data – CTEU-PB

Dimensions Download CAD data → www.festo.com
CTEU-PB

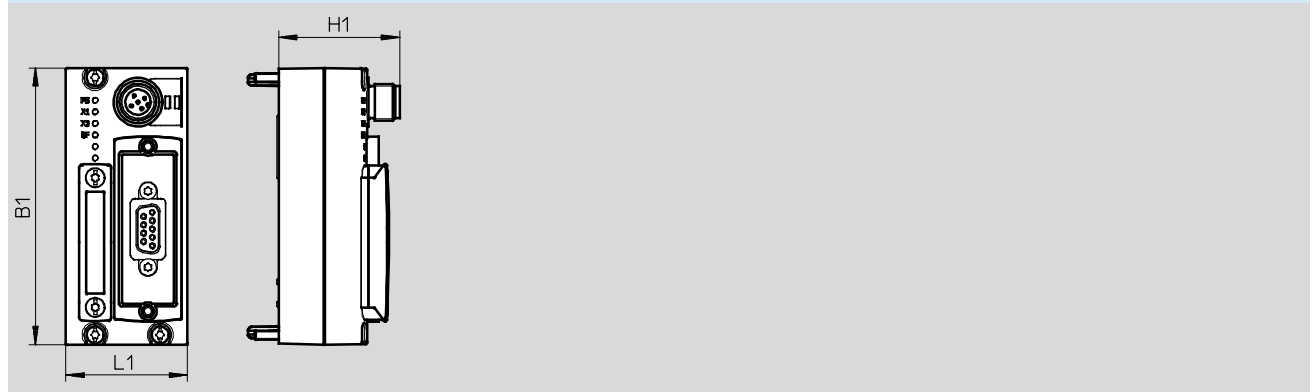

Type	B1	H1	L1
CTEU-PB	91	39.8	40

Pin allocation

	Pin	Allocation	Description
Sub-D plug, 9-pin, PROFIBUS interface			
	1	Screened	Functional earth
	2	n.c.	Not connected
	3	RxD/TxD-P	Received/transmitted data positive
	4	CNTR-P	Repeater control signal
	5	DGND	Data ground GND
	6	VP	Supply voltage - positive (+ 5 V)
	7	n.c.	Not connected
	8	RxD/TxD-N	Received/transmitted data negative
	9	n.c.	Not connected
		Housing	
Power supply, M12, A-coded			
	1	24 V _{EL} /SEN	Operating voltage supply (electronic, sensors/inputs)
	2	24 V _{VAL} /OUT	Load voltage supply (valves/outputs)
	3	0 V _{EL} /SEN	Operating voltage supply (electronic, sensors/inputs)
	4	0 V _{VAL} /OUT	Load voltage supply (valves/outputs)
	5	FE	Functional earth

Fieldbus modules CTEU/installation system CTEL

Technical data – CTEU-PB







Pin allocation – PROFIBUS interface			
Fieldbus adapter	Pin	Bus IN	Bus OUT
Bus connection, FBA-2-M12-5POL-RK			
	1	n.c.	VP
	2	RxD/TxD-N	RxD/TxD-N
	3	n.c.	DGND
	4	RxD/TxD-P	RxD/TxD-P
	5	FE	Functional earth

Connection and display components	
	<ul style="list-style-type: none"> 1 Status LEDs (operating status/diagnostics) 2 DIL switches 3 Power supply for bus node and connected devices (valve terminal) 4 Fieldbus connection (Sub-D plug)

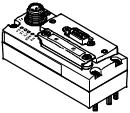
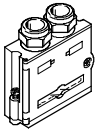
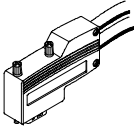
Fieldbus modules CTEU/installation system CTEL

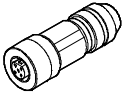
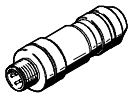
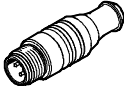
FESTO

Accessories – CTEU-PB

Ordering data		Part No.	Type
Bus node			
	PROFIBUS bus node	570040	CTEU-PB
Bus connection			
	Sub-D plug, straight	532216	FFBS-SUB-9-GS-DP-B
	Sub-D plug, angled	533780	FBS-SUB-9-WS-PB-K
	Bus connection M12 adapter, B-coded	533118	FBA-2-M12-5POL-RK
	Socket M12x1, 5-pin, straight, for self-assembly of a connecting cable, compatible with FBA-2-M12-5POL-RK	1067905	NECU-M-B12G5-C2-PB
	Plug M12x1, 5-pin, straight, for self-assembly of a connecting cable, compatible with FBA-2-M12-5POL-RK	1066354	NECU-M-S-B12G5-C2-PB
	Terminating resistor, M12, B-coded for PROFIBUS	1072128	CACR-S-B12G5-220-PB
Fitting			
	Threaded sleeve for Sub-D	533000	UNC4-40/M3X8
Plug socket			
	For power supply, M12x1, 5-pin	18324	FBSD-GD-9-5POL
Manual			
	Manual Bus node CTEU-PB	German	575392 P.BE-CTEU-PB-OP+MAINT-DE
		English	575393 P.BE-CTEU-PB-OP+MAINT-EN
		Spanish	575394 P.BE-CTEU-PB-OP+MAINT-ES
		French	575395 P.BE-CTEU-PB-OP+MAINT-FR
		Italian	575396 P.BE-CTEU-PB-OP+MAINT-IT
		Chinese	575397 P.BE-CTEU-PB-OP+MAINT-ZH

Fieldbus modules CTEU/installation system CTEL

Technical data – CTEU-EC



The bus node handles communication between the valve terminal and a higher-level EtherCAT® master.

The module has basic diagnostic functions. It has 6 integrated status LEDs for on-site display. Up to 16 byte inputs and 16 byte outputs are transmitted in the cyclic process image.



Application

Fieldbus connection			
<p>The bus connection is established via two M12 sockets, D-coded to IEC61076-2-101 with IP65/67 protection.</p> <p>Both connections are equivalent 100BaseTX Ethernet ports with integrated auto MDI functionality (cross-over and patch cables can be</p>	<p>used) that are brought together via an internal switch.</p> <p>The module features a system and load supply, a fieldbus connection and a connection to the valve terminal with serial I-Port interface.</p>	<p>Note the applicable specifications, for example cable specifications for Ethernet networks to ISO/IEC11801 as well as ANSI/TIA/EIA-568-B.</p>	<ul style="list-style-type: none"> • Maximum cable length (between network stations): 100 m • Baud rate: 100 Mbps • EtherCAT communication chip: ASIC ET1100

EtherCAT bus node

<p>The EtherCAT bus node supports the EtherCAT protocol on the basis of the Ethernet standard and TCP/IP technology to IEEE802.3.</p> <p>This guarantees data exchange with a high data transmission rate, for example I/O data from sensors, actuators or robot controllers, PLCs or process equipment. Furthermore, non</p>	<p>real-time critical information such as diagnostic information, configuration information, etc. can be transferred. The data bandwidth is sufficient to transmit both data types (real-time and non-real-time) in parallel.</p> <p>The bus node features a system and load supply, EtherCAT input and</p>	<p>output port, LEDs for status and diagnostic messages as well as DIL switch elements. Diagnostics are possible directly on the bus node and/or via fieldbus.</p> <p>The bus node has a separate operating and load voltage supply. It is mounted on a Festo device (e.g. valve terminal or electrical</p>	<p>sub-base CAPC) compatible with I-Port and supplies downstream devices connected via the I-Port interface with voltage.</p> <p>Set using DIL switches:</p> <ul style="list-style-type: none"> • Station addresses • Diagnostics on/off • Failstate behaviour
---	---	---	---

Fieldbus modules CTEU/installation system CTEL

Technical data – CTEU-EC

General technical data			
Fieldbus interface		2x M12 socket, D-coded, 4-pin	
Protocol		EtherCAT	
Baud rates		[Mbps]	100
Internal cycle time		1 ms per 1 byte of user data	
Operating voltage (PS)	Nominal value	[V DC]	24
	Permissible range	[V DC]	18 ... 30
	Power failure buffering	[ms]	10
Load voltage (PL)	Max.	[V DC]	30
	Typ. tolerance range	[V DC]	18 ... 30
Max. power supply		[A]	4
Intrinsic current consumption at nominal operating voltage		[mA]	Typically 60
Max. address capacity, inputs		[byte]	16
Max. address capacity, outputs		[byte]	16
LED display	Fieldbus-specific	<ul style="list-style-type: none"> • Run: Operating status (communication status) • L/A2: Network active (connection status) port 2 (Out) • L/A1: Network active (connection status) port 1 (In) 	
	Product-specific	<ul style="list-style-type: none"> • PS: Operating voltage for electronics and load supply • X1: System status of module at I-Port 1 • X2: System status of module at I-Port 2 	
Device-specific diagnostics		<ul style="list-style-type: none"> • System diagnostics • Undervoltage • Communication error 	
Additional functions		<ul style="list-style-type: none"> • Diagnostic object • Acyclic data access via "SDO" • Emergency message • Modular device profile (MDP) 	
Configuration support		XML file	
Parameterisation		<ul style="list-style-type: none"> • Diagnostic behaviour • Failsafe response 	
Operating elements		DIL switch	
Parameterisation via DIL switches		<ul style="list-style-type: none"> • Failsafe and idle response • Diagnostics on/off 	
Protection class to EN 60529		IP65	
Corrosion resistance class CRC		2 ¹⁾	
CE marking (see declaration of conformity)		To EU EMC Directive ²⁾	
Certification		C-Tick	
Temperature range	Operation	[°C]	- 5 ... +50
	Storage/transport	[°C]	-20 ... +70
Note on materials		RoHS-compliant	
Housing materials		<ul style="list-style-type: none"> • PC • PA reinforced 	
Dimensions W x L x H		[mm]	40 x 91 x 50
Product weight		[g]	90

- 1) Corrosion resistance class 2 according to Festo standard 940 070
Components subject to moderate corrosion stress. Externally visible parts with primarily decorative surface requirements which are in direct contact with a normal industrial environment or media such as coolants or lubricating agents.
- 2) For information about the applicability of the component see the manufacturer's EC declaration of conformity at: www.festo.com → Support → User documentation.
If the component is subject to restrictions on usage in residential, office or commercial environments or small businesses, further measures to reduce the emitted interference may be necessary.

Fieldbus modules CTEU/installation system CTEL

Technical data – CTEU-EC

Dimensions Download CAD data → www.festo.com
CTEU-EC



Type			
CTEU-EC	L1	H1	B1
	91	45.3	40

Pin allocation



	Pin	Allocation	Description
EtherCAT interface, M12, D-coded			
	1	TX+	Transmitted data+
	2	RX+	Received data+
	3	TX-	Transmitted data-
	4	RX-	Received data-
	Housing		
Power supply, M12, A-coded			
	1	24 V _{EL/SEN}	Operating voltage supply (electronic, sensors/inputs)
	2	24 V _{VAL/OUT}	Load voltage supply (valves/outputs)
	3	0 V _{EL/SEN}	Operating voltage supply (electronic, sensors/inputs)
	4	0 V _{VAL/OUT}	Load voltage supply (valves/outputs)
	5	FE	Functional earth

Connection and display components

	1	Status LEDs (operating status/diagnostics)
	2	DIL switches
	3	Power supply for bus node and connected devices (valve terminal)
	4	Fieldbus connection (Sub-D plug)

Fieldbus modules CTEU/installation system CTEL

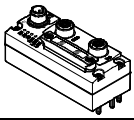
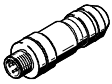
Accessories – CTEU-EC

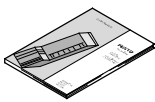
Ordering data		Part No.	Type
Bus node			
	Bus node CTEU-EC (EtherCAT)	572556	CTEU-EC
Bus connection			
	Plug M12x1, 4-pin, D-coded	543109	NECU-M-S-D12G4-C2-ET
Plug socket			
	For power supply, M12x1, 5-pin	18324	FBSD-GD-9-5POL
Manual			
	Manual Bus node CTEU-EC	German	575400 P.BE-CTEU-EC-OP+MAINT-DE
		English	575401 P.BE-CTEU-EC-OP+MAINT-EN
		Spanish	575402 P.BE-CTEU-EC-OP+MAINT-ES
		French	575403 P.BE-CTEU-EC-OP+MAINT-FR
		Italian	575404 P.BE-CTEU-EC-OP+MAINT-IT
		Chinese	575405 P.BE-CTEU-EC-OP+MAINT-ZH

Fieldbus modules CTEU/installation system CTEL

Technical data – Interface CPX-CTEL

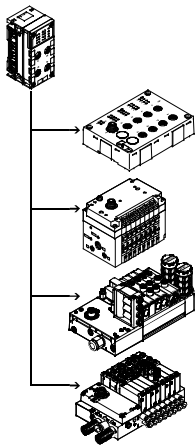

The electrical interface CPX-CTEL master establishes the connection to modules with I-Port interface (device) from the CTEL/CTEU series. The I/O data from the connected devices is transferred to the connected CPX bus node and therefore transferred to the higher-level controller via fieldbus. A maximum of 4 devices can be connected to a CPX-CTEL master via appropriate M12- interfaces.



Application

I-Port interface

As well as transmitting the communication data, the I-Port interfaces of a CPX-CTEL master also transmit the power supply for the

connected sensors and the load supply for the valves (or outputs). Both circuits are supplied separately

with 24 V, with a separate reference potential. The connecting cables used must meet

the increased requirements resulting from their double function as a signal line and power supply cable.

Sample configuration – CPX-CTEL master with CTEL modules

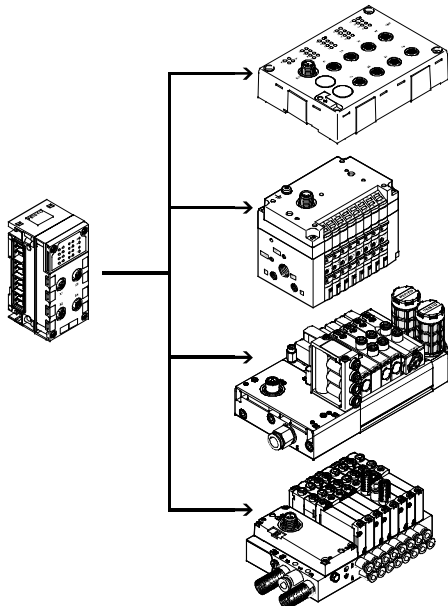

The CPX-CTEL master provides four I-Port interfaces to which one device each can be connected. I-Port is an interface for exchanging serial data for connecting decentralised modules or valve terminals from Festo. The I-Port interface is based on IO-Link and is compatible with it in certain areas.

The connection type corresponds to a star topology. In other words, only one module or valve terminal can be connected to each I-Port.

The restrictions compared to IO-Link include:

- Permanently set baud rate of 230.4 kbps
- SIO mode is not supported
- Max. 32 bytes of input data and 32 bytes of output data
- Only one dump of the master commands is used
- "Festo plug & work" principle, configuration via IO-DD is not supported

Fieldbus modules CTEU/installation system CTEL

Technical data – Interface CPX-CTEL



Implementation

<p>The CPX-CTEL master from Festo enables modules with an I-Port interface to be connected to a CPX system:</p> <ul style="list-style-type: none"> • Max. 4 devices with individual electronic fuse protection • Max. 64 inputs/64 outputs per I-Port interface • The maximum length of a string is 20 m 	<p>The following device variants are available:</p> <ul style="list-style-type: none"> • Input modules with 16 digital inputs (3-pin M8 and 5-pin M12 connection technology) • Valve terminals with I-Port interface (up to 48 solenoid coils, different valve functions) 	<p>The decentralised arrangement of the modules and valve terminals with I-Port enables them to be mounted near the cylinders and actuators/sensors to be controlled. This allows the use of shorter air supply lines and sensor cables or possibly smaller valves, which saves costs.</p>	<p>Several CPX-CTEL masters can be combined in one CPX terminal, depending on the address capacity of the bus node.</p> <p>Example:</p> <ul style="list-style-type: none"> • CPX-FB13 (512 I/O) • Max. 2 CPX-CTEL masters (256 I/O each) possible
---	---	--	---

Configuration

Setting	Manual configuration		Automatic configuration
<p>The precise number of I/O bytes made available is geared towards the requirements of the connected devices and the selected operating mode. The operating mode and configuration presetting of the CPX-CTEL master can be defined by the user. DIL switches are used for selecting the operating mode and making the setting for manual configuration. These DIL switches are not required during operation and are only accessible in unassembled condition.</p>	<p>With manual configuration (tool change mode), the number of inputs and outputs in the process image of the CPX system or higher-level fieldbus can be manually defined via the DIL switches.</p>	<p>The process image then always has the same number of bytes, regardless of the connected devices. The defined I/O length always applies to all four I-Ports (max. 8 bytes per I-Port).</p>	<p>With automatic configuration, the I/O length for each I-Port is individually determined and this value is used to select the appropriate or next highest configuration presetting.</p>

Power supply for I-Port devices

<p>The CPX-CTEL master provides two separate power supplies for the connected devices:</p> <ul style="list-style-type: none"> • One for operating the device and the inputs connected to it • One for outputs and valves connected to the device 	<p>The power supply for devices and inputs comes from the power supply for the electronics and sensors of the CPX terminal. The power supply for outputs and valves comes from the power supply</p>	<p>for the valves of the CPX terminal. The interlinking block with additional power supply enables a separate voltage supply for valves and outputs. This allows this supply voltage to be</p>	<p>switched off separately. In other words, the valves and outputs of the connected I-Port devices can be switched off separately without having to switch off the devices themselves.</p>
--	---	--	--

Fieldbus modules CTEU/installation system CTEL

Technical data – Interface CPX-CTEL

General technical data			
Type		CPX-CTEL-4-M12-5POL	
Protocol		I-Port	
Max. address capacity	Outputs	[bit]	256
	Inputs	[bit]	256
I-Port connection		4x M12 socket, 5-pin, A-coded	
Number of I-Port interfaces		4	
Max. cable length		[m]	20
Internal cycle time		[ms]	1 per 8 bits of user data
Electrical isolation	Channel – channel	No	
	Channel – internal bus	Yes, using an intermediate supply	
LED displays		X1 ... 4 = Status of the I-Port interface 1 ... 4 PS = Electronics supply PL = Load supply L = Module fault	
Diagnostics		<ul style="list-style-type: none"> • Communication error • Module short circuit • Module-oriented diagnostics • Undervoltage 	
Parameterisation		<ul style="list-style-type: none"> • Diagnostic behaviour • Failsafe per channel • Forces per channel • Idle mode per channel • Module parameters • Tool change mode 	
Additional functions		Tool change mode	
Operating elements		DIL switch	
Operating voltage	Nominal value	[V DC]	24 (reverse polarity protected)
	Permissible range	[V DC]	18 ... 30
	Power failure buffering	[ms]	10
Intrinsic current consumption at nominal operating voltage		[mA]	Typically 65
Max. power supply per channel		[A]	4x 1.6
Max. residual output current per channel		[A]	4x 1.6
Protection class to EN 60529		IP65/IP67	
Temperature range	Operating	[°C]	-5 ... +50
	Storage/transport	[°C]	-20 ... +70
Materials		PA reinforced, PC	
Note on materials		RoHS-compliant	
Grid dimension		[mm]	50
Dimensions (incl. interlinking block) W x L x H		[mm]	50 x 107 x 55
Product weight		[g]	110

 Note

Please observe the general limits and guidelines for the system when configuring the electrical modules.

Fieldbus modules CTEU/installation system CTEL

Technical data – Interface CPX-CTEL

Connection and display components

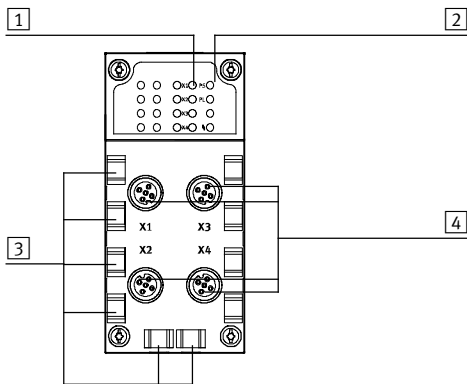

- 1 Status LEDs for I-Port interfaces
- 2 CPX-specific status LEDs
- 3 Holders for inscription labels (IBS 6x10)
- 4 I-Port interfaces for up to 4 devices

Pin allocation – I-Port interface/IO-Link

	Pin	Allocation	Description
	1	24 V _{EL} /SEN	Operating voltage supply (electronic, sensors/inputs)
	2	24 V _{VAL} /OUT	Load voltage supply (valves/outputs)
	3	0 V _{EL} /SEN	Operating voltage supply (electronic, sensors/inputs)
	4	C/Q	Communication signal
	5	0 V _{VAL} /OUT	Load voltage supply (valves/outputs)

Dimensions

Download CAD data → www.festo.com

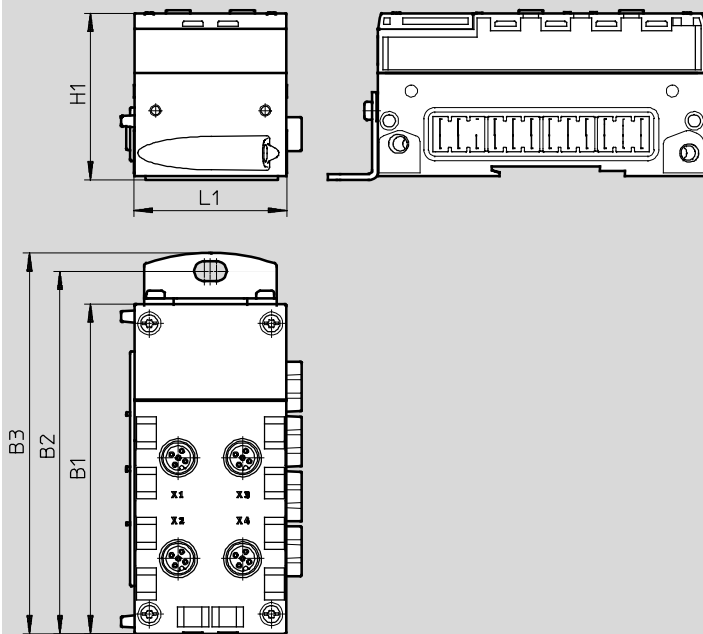



Type	B1	B2	B3	H1	L1
CPX-CTEL-4-M12-5POL	108.1	118.9	124.9	55.1	50

Fieldbus modules CTEU/installation system CTEL



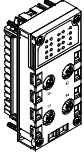

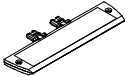
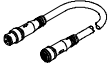
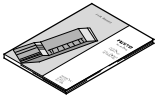
Accessories – Interface CPX-CTEL

Ordering data				
Designation			Part No.	Type
CPX-CTEL master				
	Interface for max. 4 I/O modules and valve terminals with I-Port interface (devices)		1577012	CPX-CTEL-4-M12-5POL
Bus connection				
	Cover cap	M12	165592	ISK-M12
	Inscription label holder for manifold block		536593	CPX-ST-1
Connecting cable				
	-		574321	NEBU-M12G5-E-5-Q8N-M12G5
			574322	NEBU-M12G5-E-7.5-Q8N-M12G5
			574323	NEBU-M12G5-E-10-Q8N-M12G5
Manual				
	Manual CPX-CTEL master	German	574600	P.BE-CPX-CTEL-DE
		English	574601	P.BE-CPX-CTEL-EN
		Spanish	574602	P.BE-CPX-CTEL-ES
		French	574603	P.BE-CPX-CTEL-FR
		Italian	574604	P.BE-CPX-CTEL-IT
		Swedish	574605	P.BE-CPX-CTEL-SV

Fieldbus modules CTEU/installation system CTEL

Technical data – CPV valve terminals

-  Flow rate
CPV10: Up to 400 l/min
CPV14: Up to 800 l/min
-  Valve width
CPV10: 10 mm
CPV14: 14 mm
-  Voltage
24 V DC

I-Port interface for communication between a CPV valve terminal and an I-Port master. It activates a CPV valve terminal with up to 16 solenoid coils on max. 8 valve positions. The connection to a higher-level controller can be realised by:

- Connecting an I-Port master from Festo (CPX-CTEL)
- Mounting a fieldbus node CTEU directly
- Connecting to an IO-Link master (in IO-Link mode)

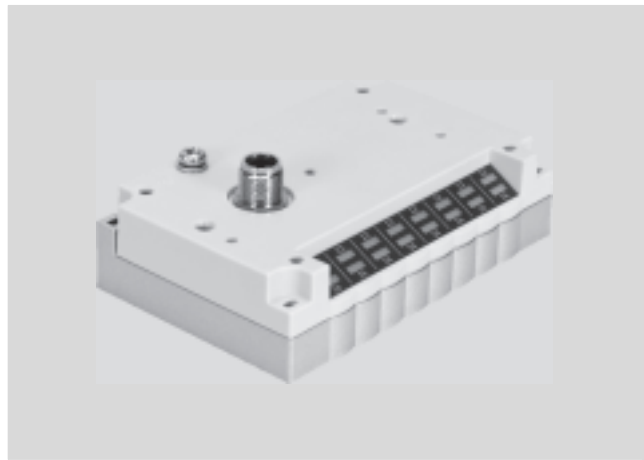

General technical data		
Protocol		IO-Link/I-Port
IO-Link	Connection technology	5-pin
	Protocol	V 1.0
	Communication mode	COM2 (38.4 kB), COM3 (230 kB)
	Port type	B
	Number of ports	1
	Process data width OUT [bit]	16
	Min. cycle time [ms]	3.2
Baud rate	[kbps]	38.4/230.4
Max. number of valve positions		8
Nominal operating voltage	[V DC]	24
Nominal load voltage	[V DC]	24
Operating voltage range	Electronics/sensors	[V DC] 18 ... 30
	Load voltage	[V DC] 21.6 ... 26.4
Intrinsic current consumption	Operating voltage	[mA] 35
	Load voltage	[mA] 700
Reverse polarity protection		For operating voltage
Diagnostics		Undervoltage of load voltage supply
LED display	Bus-specific	1 Communication status
	Product-specific	16 Valve status

Materials	
Cover	PA
Note on materials	RoHS-compliant

Operating and environmental conditions	
Mounting position	Any
Protection class to EN 60529	IP65 (when fully plugged in or fitted with protective cover)
Ambient temperature	[°C] -5 ... +50
Storage temperature	[°C] -20 ... +70
Relative air humidity	[%] 93 (non-condensing)
CE marking (see declaration of conformity)	To EU EMC Directive ¹⁾
Certification	cULus listed (OL)

1) For information about the applicability of the component see the manufacturer's EC declaration of conformity at: www.festo.com → Support → User documentation.
If the component is subject to restrictions on usage in residential, office or commercial environments or small businesses, further measures to reduce the emitted interference may be necessary.

Fieldbus modules CTEU/installation system CTEL

Technical data – CPV valve terminals

Connection and display components

CPV10

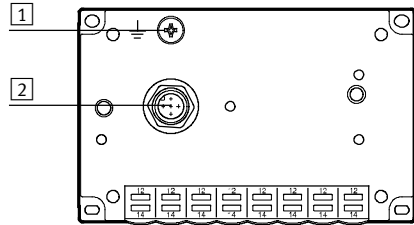

1 Earthing screw

2 I-Port interface/IO-Link

CPV14

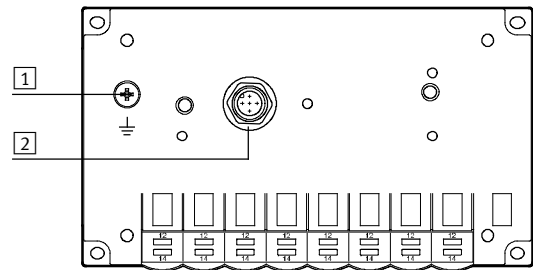

1 Earthing screw

2 I-Port interface/IO-Link

Pin allocation – I-Port interface/IO-Link

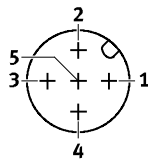

Pin	Allocation	Description
1	24 V _{EL/SEN}	Operating voltage supply (electronic, sensors/inputs)
2	24 V _{VAL/OUT}	Load voltage supply (valves/outputs)
3	0 V _{EL/SEN}	Operating voltage supply (electronic, sensors/inputs)
4	C/Q	Communication signal
5	0 V _{VAL/OUT}	Load voltage supply (valves/outputs)

Dimensions

Download CAD data → www.festo.com

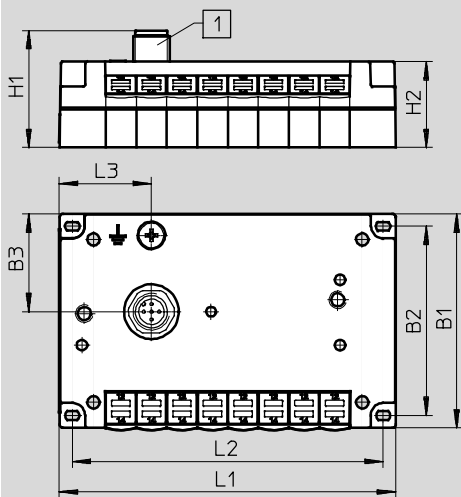



1 I-Port interface/IO-Link

Type	B1	B2	B3	H1	H2	L1	L2	L3
CPV10-GE-PT-8	71	62	32	38.3	26.2	110	101.8	30.2
CPV14-GE-PT-8	89	78	32.4	38.3	26.2	152	142	56.5

Fieldbus modules CTEU/installation system CTEL



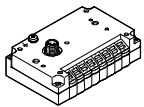

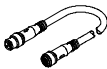
Accessories – CPV valve terminals

Ordering data						
		Type	Device ID	Weight	Part No.	Type
I-Port node						
	Node with I-Port interface/IO-Link and 8 valve positions (max. 8 double solenoid valves)	CPV10	0x 000410	108.5 g	1565761	CPV10-GE-PT-8
		CPV14	0x 000510	200 g	1564984	CPV14-GE-PT-8
Connection technology for I/O-Link						
	T-adapter M12, 5-pin for IO-Link and load voltage supply				171175	FB-TA-M12-5POL
	Straight plug, M12, 5 pin (for T-adapter)				175487	SEA-M12-5GS-PG7
Connecting cable						
	-				574321	NEBU-M12G5-E-5-Q8N-M12G5
					574322	NEBU-M12G5-E-7.5-Q8N-M12G5
					574323	NEBU-M12G5-E-10-Q8N-M12G5

Fieldbus modules CTEU/installation system CTEL

Technical data – MPA-L valve terminals

-  Flow rate
 - VMPA1: Up to 360 l/min
 - VMPA14: Up to 670 l/min
 - VMPA2: Up to 700 l/min

-  Valve width
 - VMPA1: 10 mm
 - VMPA14: 14 mm
 - VMPA2: 20 mm

-  Voltage
 - 24 V DC

I-Port interface for communication between an MPA-L valve terminal and an I-Port master. It activates an MPA-L valve terminal with up to 32 solenoid coils on max. 32 valve positions.

The connection to a higher-level controller can be realised by:

- Connecting an I-Port master from Festo (CPX-CTEL)
- Mounting a fieldbus node CTEU directly
- Connecting to an IO-Link master (in IO-Link mode)



General technical data			
Protocol		IO-Link/I-Port	
IO-Link	Connection technology		5-pin
	Protocol		V 1.0
	Communication mode		COM2 (38.4 kB), COM3 (230 kB)
	Port type		B
	Number of ports		1
	Process data width OUT	[bit]	8 ... 32
	Min. cycle time	[ms]	3.2
Baud rate	[kbps]	38.4/230.4	
Operating pressure	[bar]	-0.9 ... 10	
Pilot pressure	[bar]	3 ... 8	
Nominal operating voltage	[V DC]	24	
Intrinsic current consumption	Operating voltage	[mA]	30
	Load voltage	[mA]	30
Reverse polarity protection		For operating voltage	
Diagnostics		Undervoltage of load voltage supply	
LED display		1 Communication status	

Materials	
End plate	PPA reinforced
Note on materials	RoHS-compliant

Operating and environmental conditions	
Mounting position	Any
Ambient temperature	[°C] -5 ... +50
Storage temperature	[°C] -20 ... +40
Corrosion resistance class CRC ¹⁾	3

1) Corrosion resistance class 3 according to Festo standard 940 070
 Components subject to high corrosion stress. Externally visible parts with primarily functional surface requirements which are in direct contact with a normal industrial environment or media such as solvents and cleaning agents.

Fieldbus modules CTEU/installation system CTEL

Technical data – MPA-L valve terminals

Connection and display components

VMPAL-EPL-IPO32

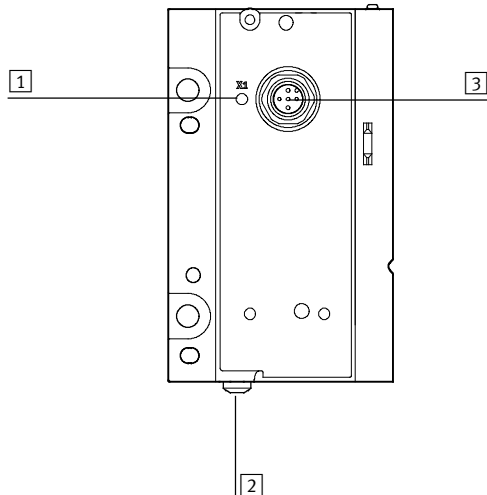

1 Status LED

2 Earthing screw

3 I-Port interface/IO-Link

Pin allocation – I-Port interface/IO-Link

Pin	Allocation	Description
1	24 V _{EL/SEN}	Operating voltage supply (electronic, sensors/inputs)
2	24 V _{VAL/OUT}	Load voltage supply (valves/outputs)
3	0 V _{EL/SEN}	Operating voltage supply (electronic, sensors/inputs)
4	C/Q	Communication signal
5	0 V _{VAL/OUT}	Load voltage supply (valves/outputs)

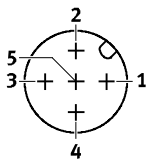

Dimensions

Download CAD data → www.festo.com

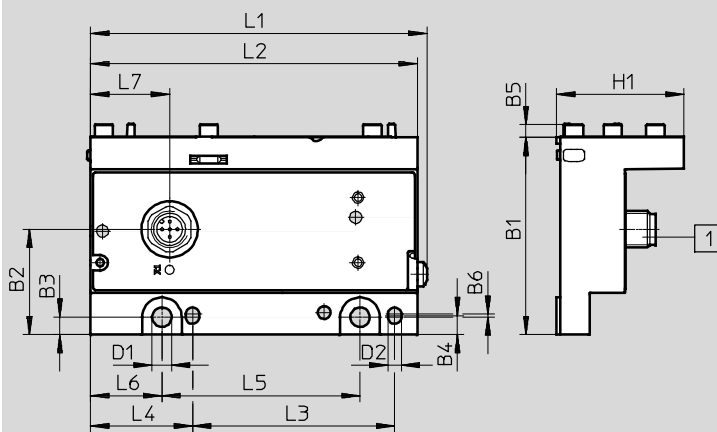



1 I-Port interface/IO-Link

Type	B1	B2	B3	B4	B5	B6	D1	D2	H1	L1	L2	L3	L4	L5	L6	L7
VMPAL-EPL-IPO32	64.8	34.5	5.7	6.2	4	1	6.4	4.5	41.8	110	107	66.3	33.5	65	23.5	26

Fieldbus modules CTEU/installation system CTEL

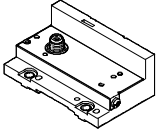
Accessories – MPA-L valve terminals

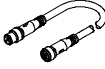
Ordering data				
		Device ID	Weight	Part No. Type
I-Port node				
	Node with I-Port interface/IO-Link and up to 32 valve positions (max. 16 double solenoid valves)	0x 000620	170 g	575667 VMPAL-EPL-IPO32
Connection technology for I/O-Link				
	T-adapter M12, 5-pin for IO-Link and load voltage supply			171175 FB-TA-M12-5POL
	Straight plug, M12, 5 pin (for T-adapter)			175487 SEA-M12-5GS-PG7
Connecting cable				
	-			574321 NEBU-M12G5-E-5-Q8N-M12G5
				574322 NEBU-M12G5-E-7.5-Q8N-M12G5
				574323 NEBU-M12G5-E-10-Q8N-M12G5

Fieldbus modules CTEU/installation system CTSL

Technical data – Input modules CTSL

Function

Digital input modules facilitate the connection of proximity sensors or other 24 V DC sensors (inductive, capacitive, etc.).

Plugs with double allocation are separated using a DUO plug or DUO cable.

Application

- Input modules for 24 V DC sensor signals
- M12 connection technology
- Display of the input states for each input signal via an assigned LED
- Operating voltage supply 24 V DC for all connected sensors
- Diagnostic LED for short circuit/overload of sensor supply
- Labelling options on all sides with large, hinged inscription labels
- Earthing plate and H-rail mounting already integrated



General technical data				
Type		CTSL-D-16E-M8-3	CTSL-D-16E-M12-5	
Electrical connection		16x M8 socket, 3-pin	8x M12 socket, 5-pin	
Protocol		IO-Link/I-Port		
IO-Link	Connection technology	5-pin		
	Protocol	V 1.0		
	Communication mode	COM2 (38.4 kB), COM3 (230 kB)		
	Port type	B		
	Number of ports	1		
	Process data width OUT	[bit]	16	
	Min. cycle time	[ms]	3.2	
	Device ID	[ms]	0x 700410	
Baud rate	[kbps]	38.4/230.4		
Max. number of inputs		16		
Nominal operating voltage		[V DC]	24	
Operating voltage range		[V DC]	18 ... 30	
Current consumption of logic at nominal operating voltage		[mA]	Max. 35	
Max. residual current per module		[mA]	1.2	
Reverse polarity protection		For operating voltage		
Fuse protection (short circuit)		Internal electronic fuse protection for each group		
Electrical isolation, channel – channel		No		
Switching level	Signal 0	[V]	≤5	
	Signal 1	[V]	≥11	
Input debounce time		[ms]	0.5 (3 ms, 10 ms, 20 ms parameterisable)	
Input characteristic		IEC1131 Part 2		
Switching logic at inputs		PNP (positive switching)		
LED display	Bus-specific	X20: I-Port/IO-Link		
	Product-specific	1 Operating voltage		
		16 Channel status		
		2 Group diagnostics		

Fieldbus modules CTEU/installation system CTEL

Technical data – Input modules CTSL

Materials		
Housing		PA reinforced
Cover		PA reinforced
Note on materials		RoHS-compliant
Product weight	[g]	250
Dimensions	(W x L x H) [mm]	143 x 103 x 32

Operating and environmental conditions		
Type of mounting		Optionally via H-rail or through-holes
Protection class to EN 60529		IP65, IP67 (when fully plugged in or fitted with protective cap)
Ambient temperature	[°C]	-5 ... +50
Storage temperature	[°C]	-20 ... +70
Corrosion resistance class CRC ¹⁾		2 ¹⁾
CE marking (see declaration of conformity)		To EU EMC Directive ²⁾
Certification		cULus listed (OL)
		C-Tick

- 1) Corrosion resistance class 2 according to Festo standard 940 070
Components subject to moderate corrosion stress. Externally visible parts with primarily decorative surface requirements which are in direct contact with a normal industrial environment or media such as coolants or lubricating agents.
- 2) For information about the applicability of the component see the manufacturer's EC declaration of conformity at: www.festo.com → Support → User documentation.
If the component is subject to restrictions on usage in residential, office or commercial environments or small businesses, further measures to reduce the emitted interference may be necessary.

Fieldbus modules CTEU/installation system CTEL

Technical data – Input modules CTSL



Connection and display components

CTSL-D-16E-M8-3

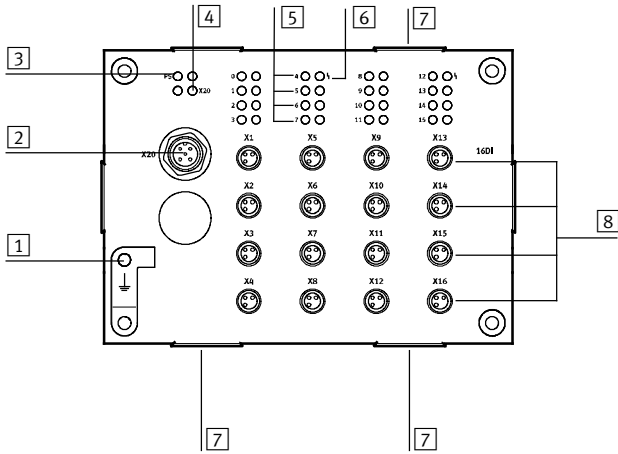

- 1 Earth terminal
- 2 I-Port interface/IO-Link
- 3 Status LED for power supply (PS)
- 4 Status LED for I-Port (X20)
- 5 Status LEDs for inputs (status display, green)
- 6 Status LED (group) for short circuit/overload of sensor supply (red)
- 7 Fixture for inscription label holder ASCF-H-E2
- 8 Sensor connections (1 input per socket)

Pin allocation – I-Port interface/IO-Link

	Pin	Allocation	Description
	1	24 V _{EL/SEN}	Operating voltage supply (electronic, sensors/inputs)
	2	–	–
	3	0 V _{EL/SEN}	Operating voltage supply (electronic, sensors/inputs)
	4	C/Q	Communication signal
	5	–	–

Pin allocation – Sensor connections CTSL-D-16E-M8-3

Pin allocation	Pin	Allocation	Description
	1	24 V	Operating voltage 24 V
	3	0 V	Operating voltage 0 V
	4	I _x *	Sensor signal

* I_x = Input x

Fieldbus modules CTEU/installation system CTEL

Technical data – Input modules CTSL

Connection and display components

CTSL-D-16E-M12-5

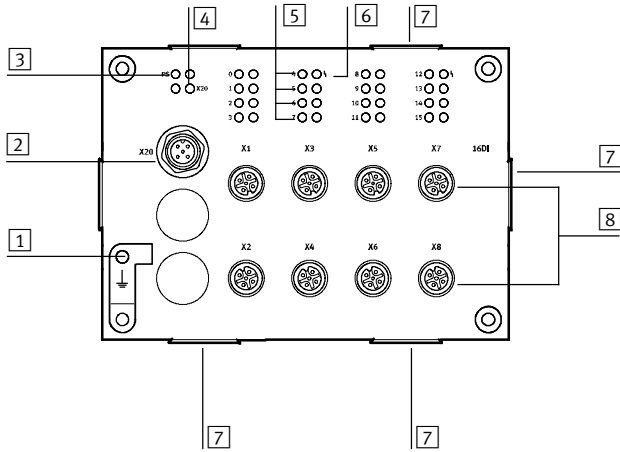

- 1** Earth terminal
- 2** I-Port interface/IO-Link
- 3** Status LED for power supply (PS)
- 4** Status LED for I-Port (X20)
- 5** Status LEDs for inputs (status display, green)
- 6** Status LED (group) for short circuit/overload of sensor supply (red)
- 7** Fixture for inscription label holder ASCF-H-E2
- 8** Sensor connections (2 inputs per socket)

Pin allocation – I-Port interface/IO-Link

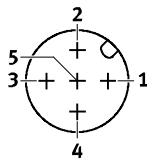

Pin	Allocation	Description
1	24 V _{EL} /SEN	Operating voltage supply (electronic, sensors/inputs)
2	-	-
3	0 V _{EL} /SEN	Operating voltage supply (electronic, sensors/inputs)
4	C/Q	Communication signal
5	-	-

Pin allocation – Sensor connections CTSL-D-16E-M12-5

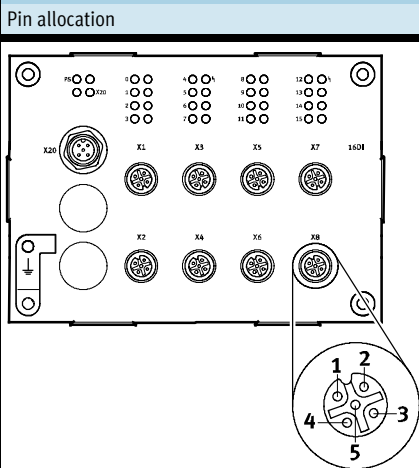

Pin	Allocation	Description
1	24 V	Operating voltage 24 V
2	I _x +1*	Sensor signal
3	0 V	Operating voltage 0 V
4	I _x *	Sensor signal
5	Ground	Earth terminal

* I_x = Input x

Fieldbus modules CTEU/installation system CTEL

Technical data – Input modules CTSL

Dimensions

Download CAD data → www.festo.com

CTSL-D-16E-M8-3

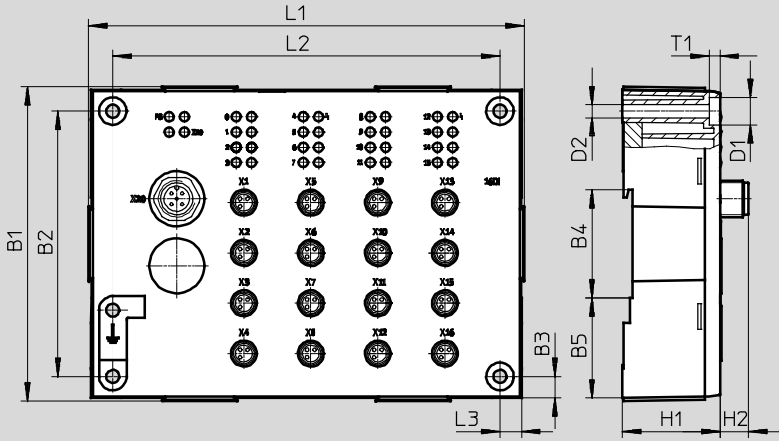



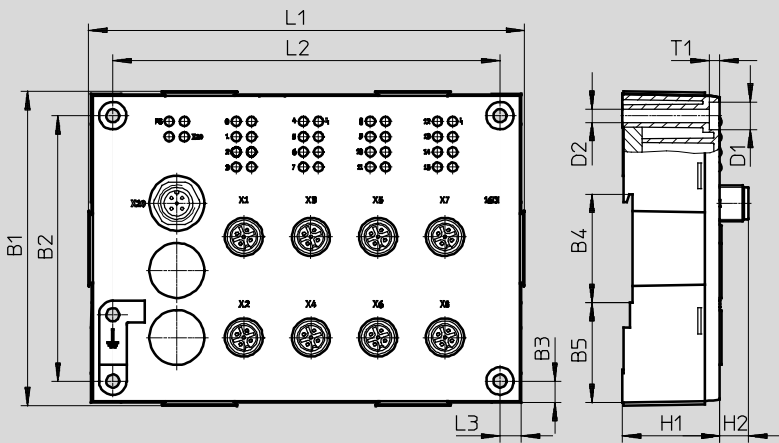

CTSL-D-16E-M12-5

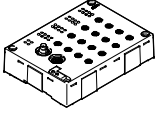

Type	B1	B2	B3	B4	B5	D1	D2	H1	H2	L1	L2	L3	T1
CTSL-D-16E	103	87	7	35.5	32.8	9	4.3	32	9.4	143	127	7	3.5

Fieldbus modules CTEU/installation system CTEL

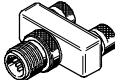
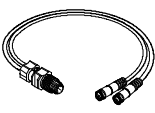
Accessories – Input modules CTSL

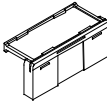
Ordering data				
Designation			Part No.	Type
Input modules				
	16 sensor connections M8, 3-pin, single allocation		1387363	CTSL-D-16E-M8-3
	8 sensor connections M12, 5-pin, double allocation		1387359	CTSL-D-16E-M12-5
Plug connector				
	Straight plug, M12	5-pin, PG7	175487	SEA-M12-5GS-PG7
		4-pin, PG7	18666	SEA-GS-7
		4-pin, 2.5 mm ² O.D.∅	192008	SEA-4GS-7-2,5
	Straight plug, M8	3-pin, solderable	18696	SEA-GS-M8
3-pin, screw-in		192009	SEA-3GS-M8-S	
	Plug for 2 cables, M12, PG11	4-pin	18779	SEA-GS-11-DUO
		5-pin	192010	SEA-5GS-11-DUO
	Push-in T-connector	2x socket M12, 5-pin 1x plug M12, 4-pin	541596	NEDU-M12D5-M12T4
Connecting cables				
	DUO cable, 1x straight plug M12	2x straight socket M8	18685	KM12-DUO-M8-GDGD
		1x straight socket M8 and 1x angled socket M8	18688	KM12-DUO-M8-GDWD
		2x angled socket M8	18687	KM12-DUO-M8-WDWD
	Connecting cable, M12, 4-pin, straight plug-straight socket	2.5 m	539052	NEBU-M12G4-K-2.5-M12G4 ¹⁾
		5.0 m	539052	NEBU-M12G4-K-5-M12G4 ¹⁾
	Connecting cable, M8, 3-pin, straight plug-straight socket	0.5 m	539052	NEBU-M8G3-K-0.5-M8G3 ¹⁾
		1 m	539052	NEBU-M8G3-K-1-M8G3 ¹⁾
		2.5 m	539052	NEBU-M8G3-K-2.5-M8G3 ¹⁾
		5 m	539052	NEBU-M8G3-K-5-M8G3 ¹⁾
	-		574321	NEBU-M12G5-E-5-Q8N-M12G5
			574322	NEBU-M12G5-E-7.5-Q8N-M12G5
			574323	NEBU-M12G5-E-10-Q8N-M12G5
Inscription label holder				
	Inscription label holders for EL modules, bag of 10		547473	ASCF-H-E2

1) Modular product, further information → Internet: nebu

Fieldbus modules CTEU/installation system CTEL

Example of a valve terminal VTUG with I-Port interface

Dimensions – Example of a valve terminal with I-Port interface, size 10

Download CAD data → www.festo.com

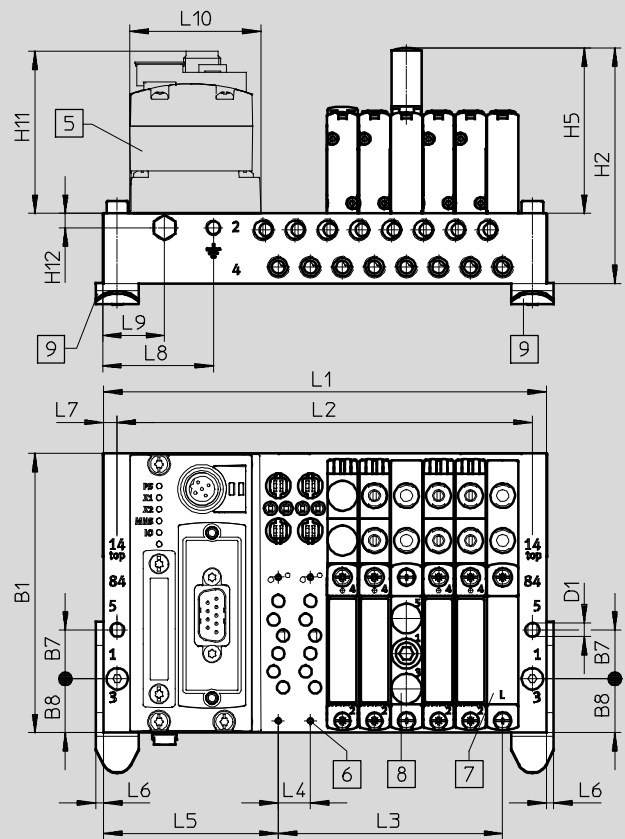
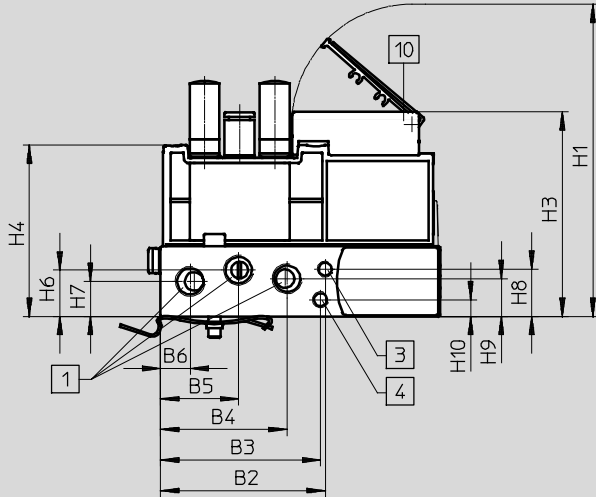

1 Ports 1, 3 and 5: G $\frac{3}{8}$
(at both ends)

3 Ports 12/14: M5 (at both ends)

4 Ports 82/84: M5 (at both ends)

5 CTEU-CANopen
6 For mounting valves/blanking
plates/supply plates on
manifold block: M2

7 Blanking plate
8 Supply plate, ports 1,3 and 5:
M7

9 H-rail mounting
10 Inscription label holder

Fieldbus modules CTEU/installation system CTEL

Example of a valve terminal VTUG with I-Port interface

Type	No. of valve positions	Size 10																
		B1	B2	B3	B4	B5	B6	B7	B8	D1 Ø	H1	H2	H3	H4	H5	H6	H7	H8
VABM	4-24	91.5	54	52.4	41.5	25.6	9.8	16	17.7	4.5	102.3	77.1	67	56.1	54.1	15.2	11.5	15.5

Type	No. of valve positions	Size 10										
		H9	H10	H11	H12	L4	L5	L6	L7	L8	L9	L10
VABM	4-24	12.4	5.5	54.8	4.8	10.5	57.3	2.5	4.5	36	20	42.5

Type	No. of valve positions	Size 10		
		L1	L2	L3
VABM	4	103	94	31.5
	5	113.5	104.5	42
	6	124	115	52.5
	7	134.5	125.5	63
	8	145	136	73.5
	9	155.5	146.5	84
	10	166	157	94.5
	12	187	178	115.5
	16	229	220	157.5
	20	271	262	199.5
24	313	304	241.5	