

Modular electrical terminal CPX



Terminal CPX

Key features

FESTO

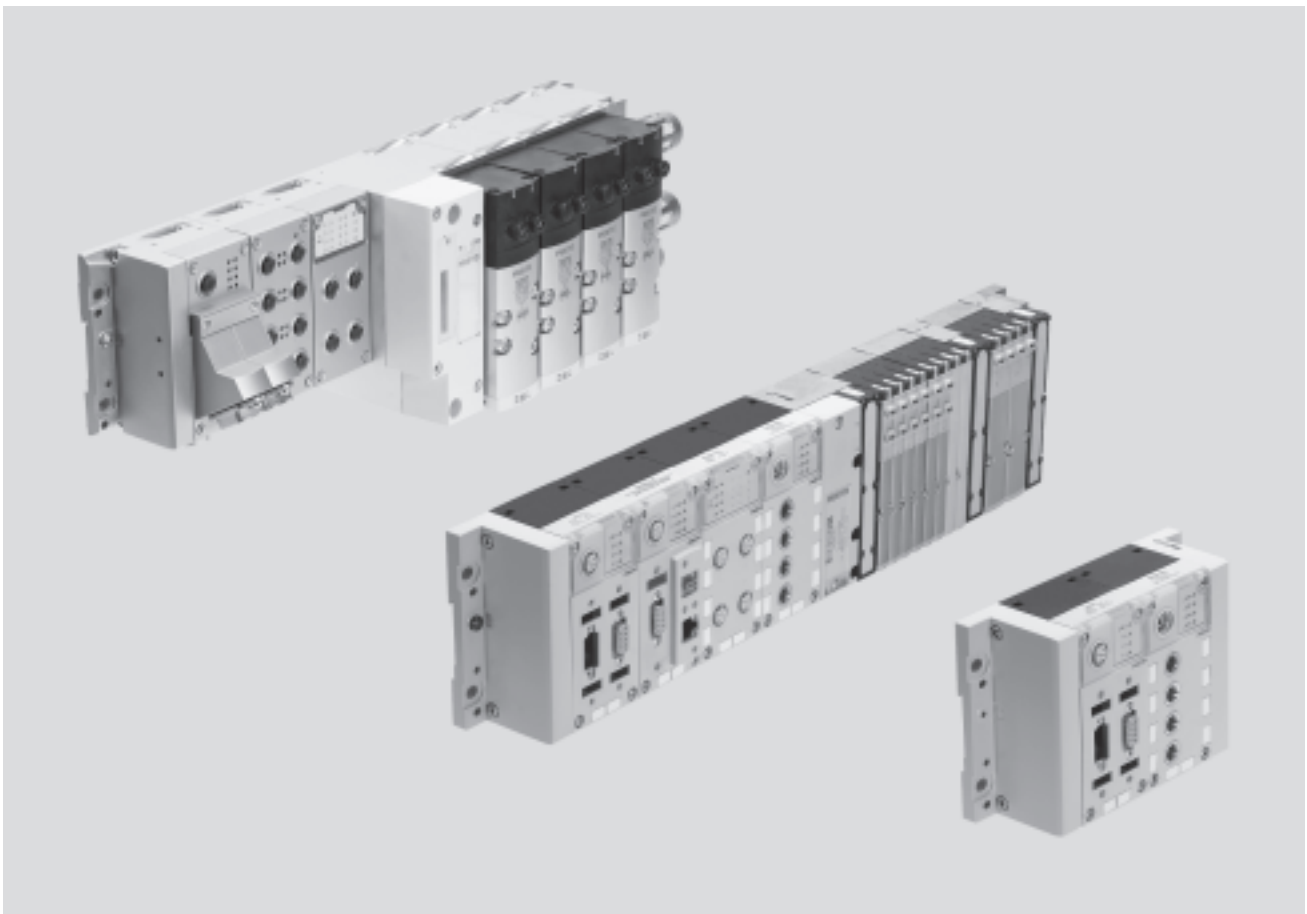

Key features

Installation concept

- Choice of several valve terminal types for different applications:
 - MIDI/MAXI
 - CPA
 - MPA-S
 - MPA-F
 - MPA-L
- Economical from the smallest configuration up to the maximum number of modules
- Up to 9 electrical input/output modules plus bus nodes and pneumatic interface/electronic modules for valves
- Extensive range of functions and connection options for the electrical modules
- Choice of connection technology for technically and economically optimised connections
- Can be used as a dedicated remote I/O module

Electrical components

- High operating voltage tolerance ($\pm 25\%$)
- Choice of M18, 7/8" or AIDA push-pull connection for power supply
- Open to all fieldbus protocols and Ethernet
- Optional function and technology modules for preprocessing
- IT services and TCP/IP such as remote maintenance, remote diagnostics, web server, text message and e-mail alert
- Digital inputs and outputs, 4-/8-/16-way, optionally available with individual channel diagnostics
- Analogue inputs and outputs, 2-/4-way
- Pressure inputs
- Temperature inputs
- Controllers for pneumatic and electrical axes
- IP65 and IP67 or IP20

Assembly

- Wall or H-rail mounting, also on mobile systems
- Conversions/extensions are possible at any time, individual linking with CPX metal design
- Modular system offering a range of configuration options
- Fully assembled and tested unit
- Lower selection, ordering, assembly and commissioning costs thanks to the central CPX terminal
- Choice of pneumatic components for optimised control loop system design
- Decentralised, subordinate CPI installation system improves cycle times by up to 30%
- Safe and convenient earthing thanks to earthing plate

Operation

- Fast troubleshooting thanks to an extensive selection of LEDs (some of which are multi-coloured) on the bus node and on all I/O modules
- Supports module and channel-oriented diagnostics
- On-the-spot diagnostics in plain text via handheld device
- Fieldbus/Ethernet remote diagnostics
- Innovative diagnostic support with integrated web server/web monitor or maintenance tool with USB adapter for PC
- Optimised commissioning thanks to parameterisable functions
- Reliability of service with connection blocks and modules that are quick to replace without changing the wiring

Terminal CPX

Key features

Pneumatic variants of the CPX terminal

The electrical CPX terminal is a modular peripheral system for valve terminals.

The system is specifically designed so that the valve terminal can be adapted to suit different applications.

The modular system design lets you configure the number of valves, inputs and additional outputs to suit the application.

With valve terminal – decentralised

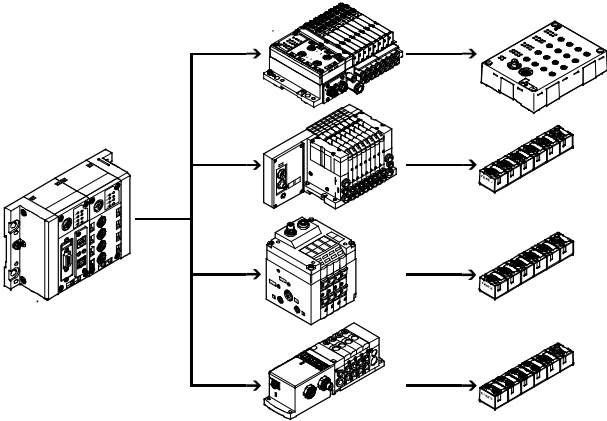

With valve terminal MPA-S – centralised

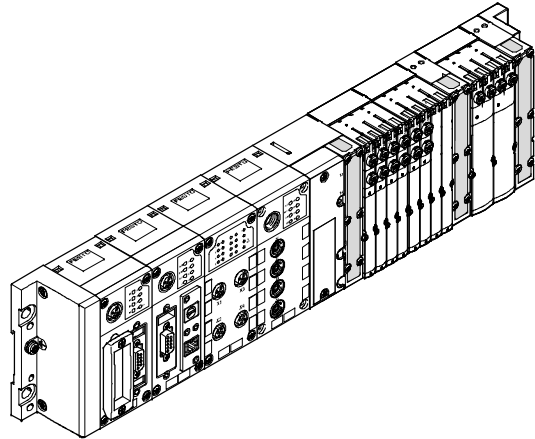

With valve terminal VTSA – centralised

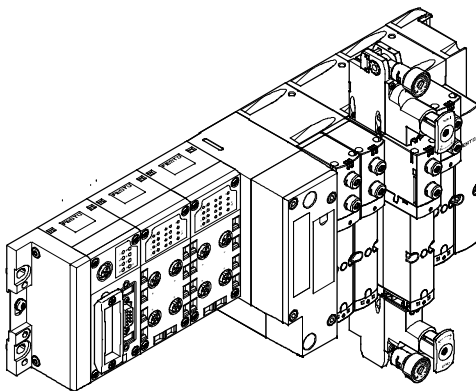

In metal design with valve terminal VTSA – centralised

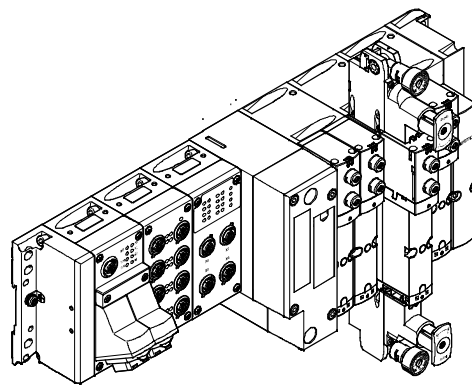

With valve terminal MIDI/MAXI – centralised

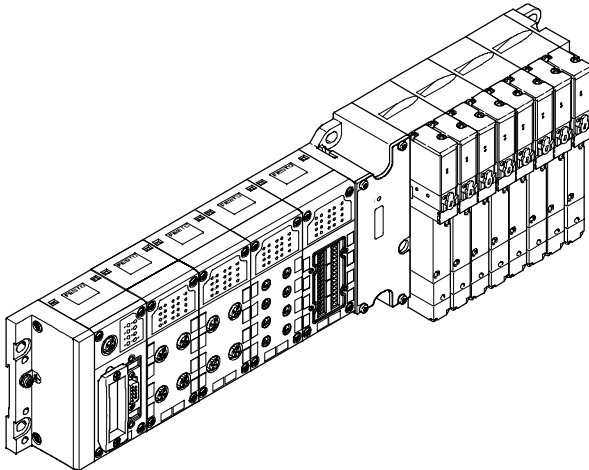

With valve terminal CPA – centralised

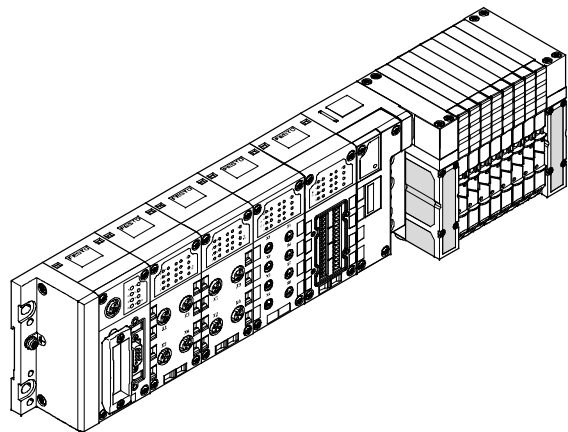

Terminal CPX

Key features

Variants of the CPX terminal controller (with bus node, without preprocessing)

Bus node

Different bus nodes are used to integrate the terminal in the control systems of various manufacturers. The CPX terminal can therefore be operated on over 90% of the most commonly used fieldbus systems:

- PROFIBUS DP
- PROFINET
- INTERBUS

- DeviceNet
- CANopen
- CC-Link

Integration in universal networks based on Ethernet opens up new possibilities. Faster data transmission, real-time capability and above all additional IT services such

as file transfer, web server, web monitor as integrated website in the CPX terminal, text message/e-mail alerts, etc. open up a wide range of synergies.

These include standardised and universal communication technology across all areas, including operating

level, management level and field level in the production environment, with protection to IP65/67.

The following protocols are supported:

- EtherNet/IP
- Modbus/TCP
- PROFINET
- EtherCAT

Bus node

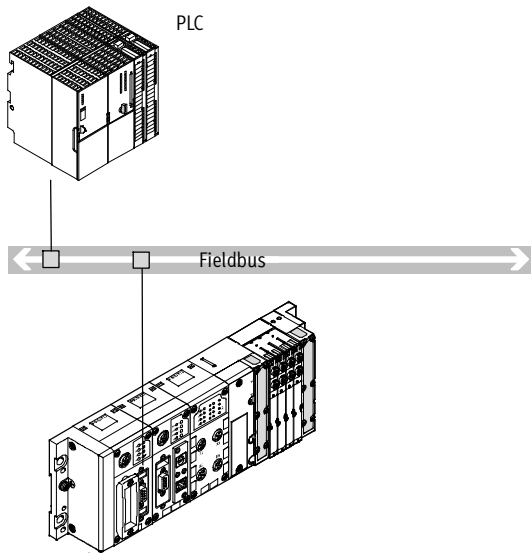

- Communication with higher-order controller via fieldbus
- No preprocessing

- Fieldbus protocol dependent on CPX bus node used
- Up to 90 I/Os, depending on the bus node used

Industrial Ethernet bus node

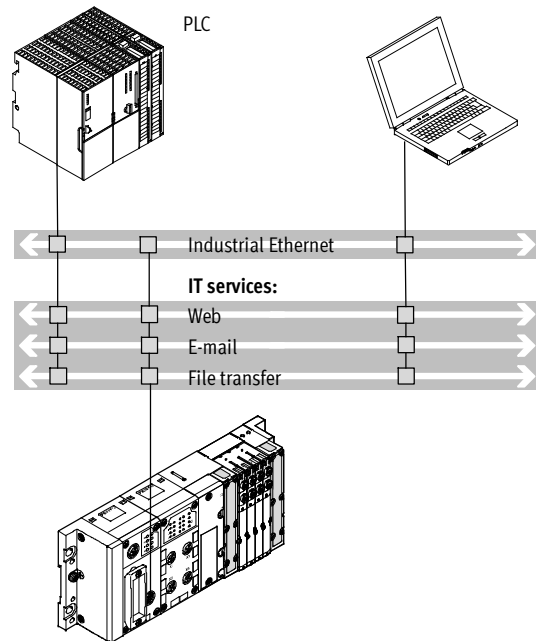

- Connection to a higher-order controller directly via EtherNet/IP, Modbus/TCP or PROFINET
- No preprocessing

- Monitoring via Ethernet and web applications
- Up to 300 I/Os

Note

Every electrical connection can be combined with an appropriate number of I/O modules and/or pneumatic components, depending on its address capacity.

Likewise, every pneumatic variant of the CPX terminal can be operated with every electrical connection variant.

Terminal CPX

Key features

Variants of the CPX terminal controller (with preprocessing in the control block)

Control block

The optional Front End Controllers CPX-FEC and CPX-CEC enable simultaneous access via Ethernet and an integrated web server (in the case

of CPX-FEC), in parallel with a bus node, as well as autonomous preprocessing. Access via Modbus/TCP and EasyIP is also possible.

Commissioning, programming and diagnostics using the Festo software tool FST 4.1 with hardware configurator.

With control block in stand-alone mode

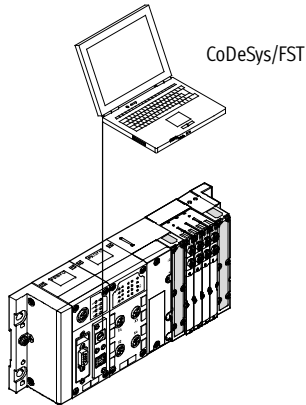

- Decentralised controller with direct machine mounting
- Interaction options via CPX-MMI or Front End Display (FED)
- Downloading of programs via Ethernet (or via the programming interface)
- Supports full expansion of all CPX peripherals
- More than 300 I/Os

Beneficial application areas:

- Stand-alone individual workstations
- Interlinked, stand-alone sub-systems
- Automation using IT technology

With control block in Festo EasyIP mode

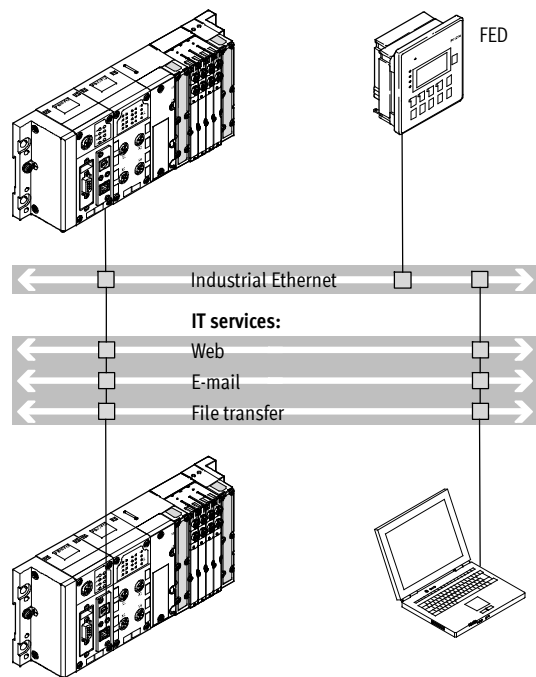

- Fast preprocessing of the CPX peripherals in the control block
- Exchange of any data between the control blocks via EasyIP
- Operation and monitoring of several control blocks via one FED
- Remote diagnostics

- No higher-order controller is required
- More than 300 I/Os per CPX control block

Terminal CPX

Key features

FESTO

Variants of the CPX terminal controller (with preprocessing in the control block)

With control block as remote controller on Ethernet

Remote controller on Ethernet as the preprocessing unit for decentralised, stand-alone subsystems using IT technology.

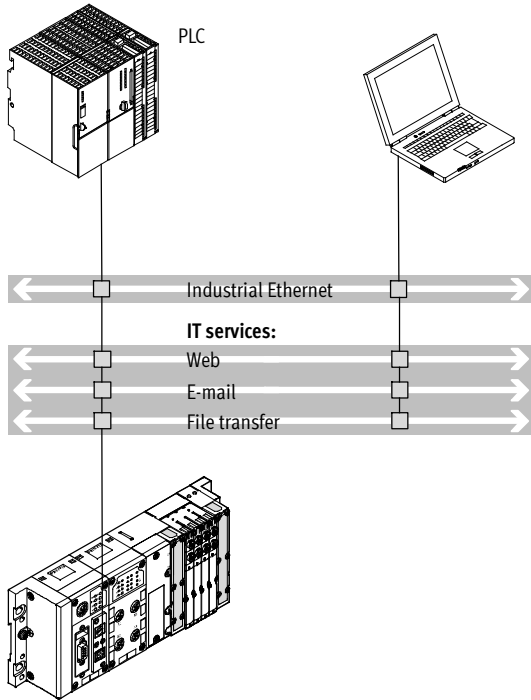

- Connection to a higher-order controller via Ethernet, no further bus node is required
- Monitoring via Ethernet and web applications

- Preprocessing of the CPX peripherals by CPX control block
- More than 300 I/Os

With control block as remote controller on the fieldbus

Fieldbus remote controller (combination with bus nodes for Interbus, PROFIBUS DP, PROFINET, CANopen, DeviceNet, CC-Link or EtherCAT) as the preprocessing unit for decentralised, stand-alone subsystems.

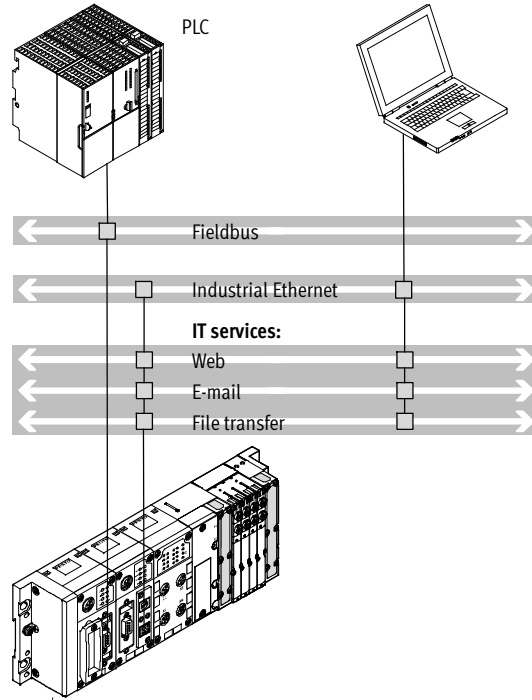

- Fast preprocessing of the CPX peripherals in the control block
- Communication with higher-order controller via fieldbus
- Optional additional monitoring via Ethernet and web applications

- Downloading of programs via programming interface
- More than 300 I/Os, bus node is only used for communication with the higher-order PLC
- Two bus nodes for redundant communication configuration

Terminal CPX

Key features

Variants of the CPX terminal controller (with preprocessing in the control block)

With control block as CANopen fieldbus master

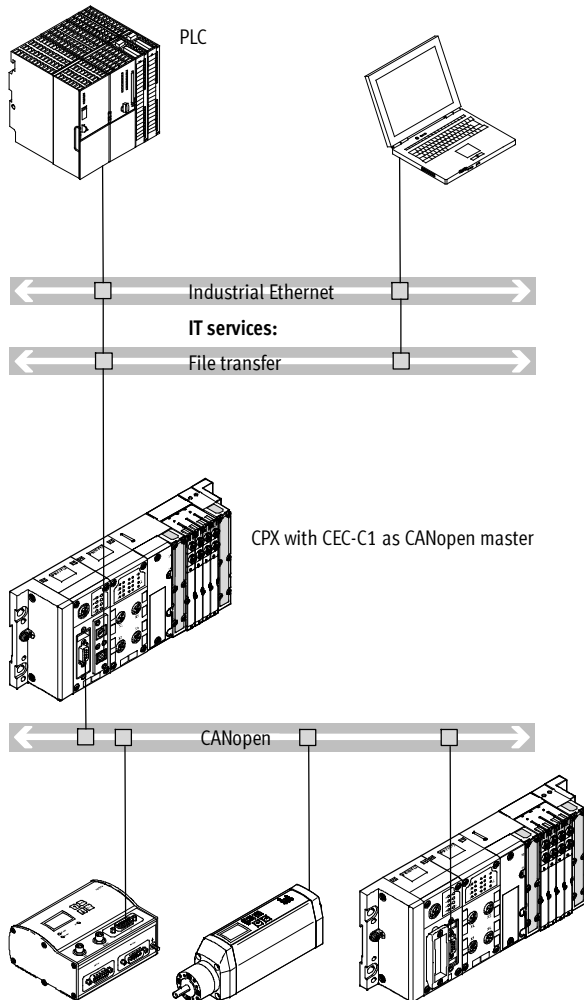

Properties:

- Connection to a higher-order controller via Ethernet, no further bus node is required
- Monitoring via Ethernet
- Preprocessing of the CPX peripherals by CPX control block
- More than 300 I/Os
- Up to 128 stations with repeater technology on CANopen

Operating modes:

- Remote controller on Ethernet
- Control block in Festo EasyIP mode

Terminal CPX

Key features

Connection of inputs and outputs to the CPX terminal

Digital and analogue CPX I/O modules

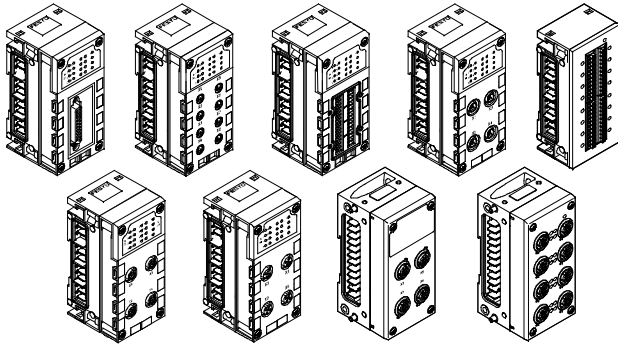

Electrical connection

The connection technology for sensors and additional actuators offers a wide range of digital and analogue input and output modules and is freely selectable – as appropriate to your standard or application. Plastic or metal connection blocks can be combined as required:

- Metal design
 - M12-5POL
- Plastic design:
 - M12-5POL
 - M12-5POL with quick lock and metal thread
 - M12-8POL
 - M8-3POL
 - M8-4POL
 - Sub-D
 - Harax®
 - CageClamp® (with cover also to IP65/67)

With CPX-CP interface

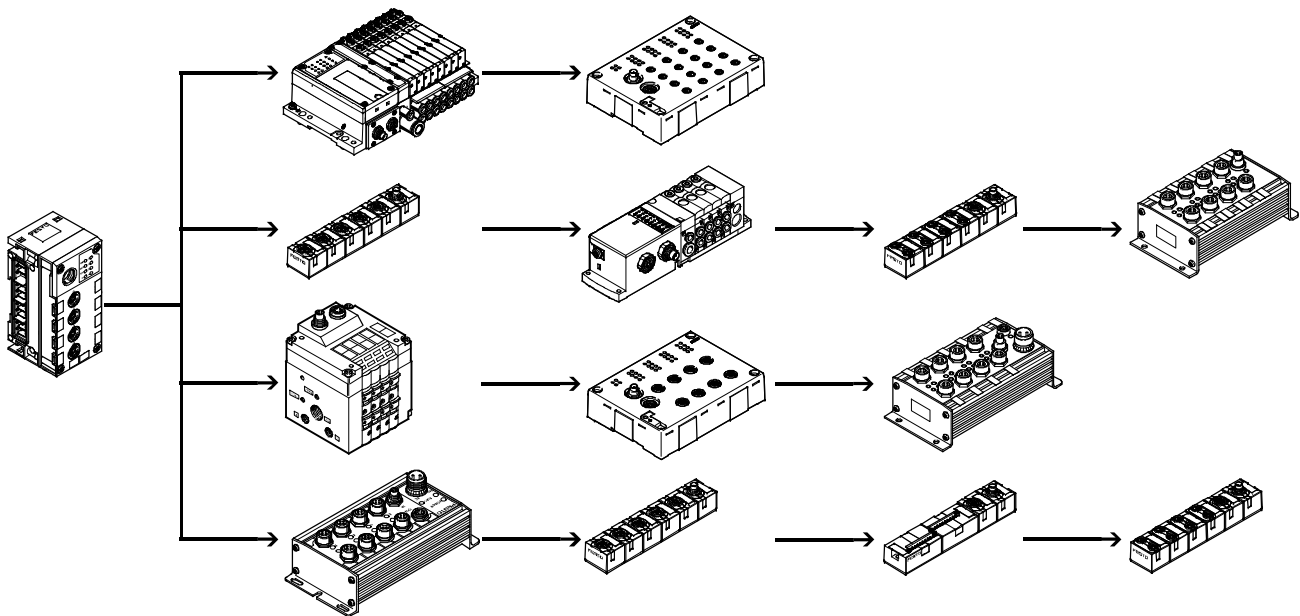

- Up to 4 strings per CP interface possible
- Up to 4 subordinate CP modules can be combined in one string
- Up to 32 I/Os can be connected per string
- Modules with M8, M12 and terminal connection
- Several CP interface modules can be combined in one CPX terminal (depending on the controller used).
- Combination of centralised CPX I/O modules and decentrally mounted I/O modules of the CPI installation system.

Combined centralised and decentralised electrical connection (valve terminal with CP interface/output module)

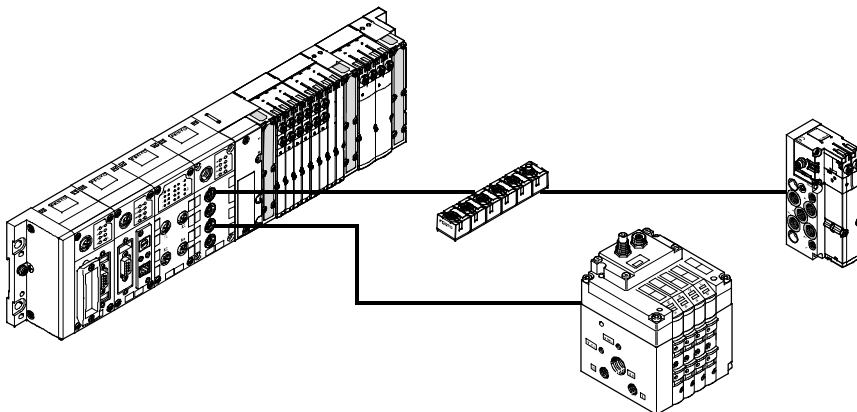

- Scalable to different requirements within a system
- One control interface in the system, reduces installation complexity with closely and widely spaced actuators
- Enables an optimum electrical and pneumatic control chain

Terminal CPX

Key features

FESTO

Connection of inputs and outputs to the CPX terminal with CPX-CTEL interface

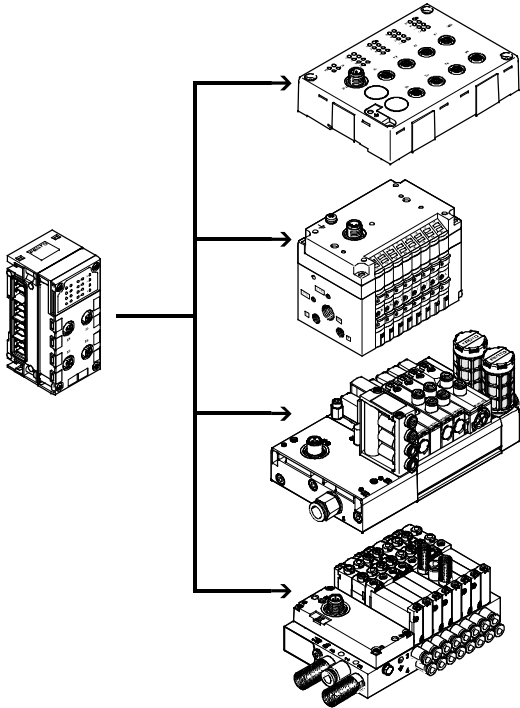

- Up to 4 devices with individual electronic fuse protection per CPX-CTEL master
- Max. 64 inputs/64 outputs per I-Port interface
- The maximum length of a string is 20 m
- Input modules with 16 digital inputs (3-pin M8 and 5-pin M12 connection technology)
- Valve terminals with I-Port interface (up to 48 solenoid coils, different valve functions)

Several CPX-CTEL masters can be combined in one CPX terminal (depending on the controller used). Combination of central CPX I/O modules and decentrally mounted I/O modules with I-Port interface.

Terminal CPX

Key features

Connection of inputs and outputs to the CPX terminal

Electrical drives with CPX-CMXX multi-axis interface

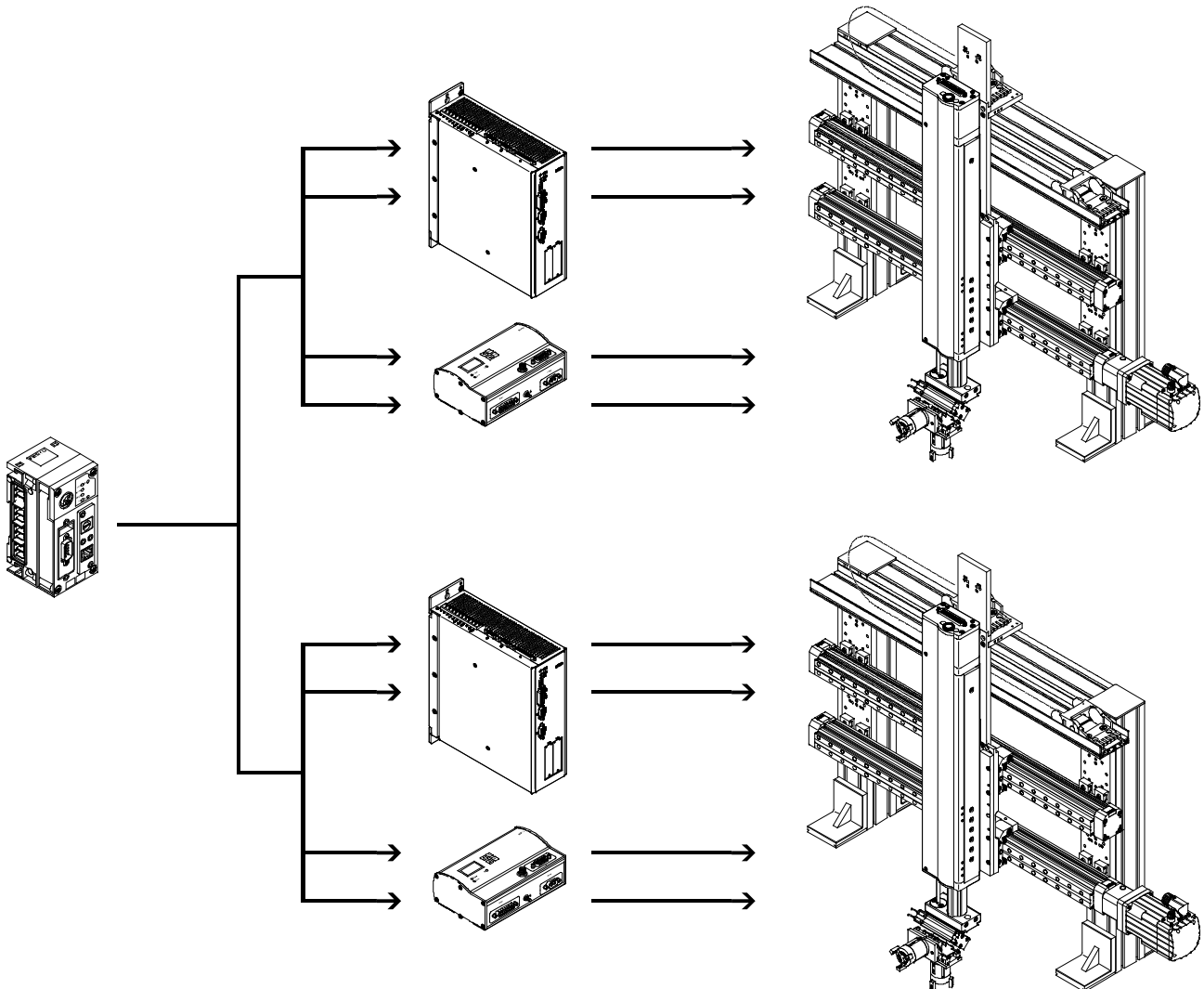

- Two axis groups, each with up to four axes, per CPX-CMXX
- 1,024 positioning records possible per axis group

- 2-axis gantries
- 3-axis gantries

Several CP interface modules can be combined in one CPX terminal (depending on the controller used).

Combination of centralised CPX I/O modules and decently mounted I/O modules of the CPI installation system.

Electrical drives with CPX-CM-HPP axis interface

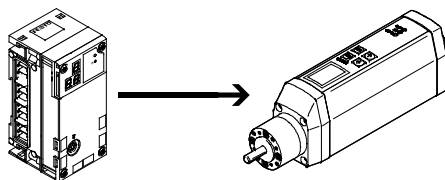

- Max. 4 individual electric axes, per CPX-CM-HPP
- No programming required

- Standardised communication with the drives via the Festo Handling and Positioning Profile (FHPP)

- The control component is independent of the bus node used

- Quick configuration and diagnostics via the operator unit CPX-MMI

Terminal CPX

Key features

Connection of inputs and outputs to the CPX terminal

Pneumatic drives with CPX-CMAX/CMPX

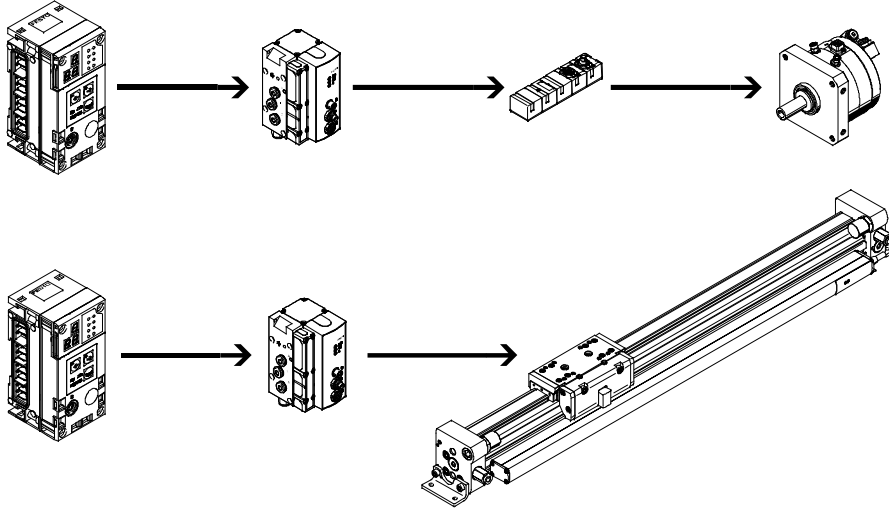

CPX-CMAX

- Position and force control, directly actuated or selected from one of 64 configurable positioning profiles.
- Configurable record continuation enables simple functional sequences to be realised.
- The auto-identification function identifies each station with its device data on the controller.
- Actuation of a brake or clamping unit via the proportional directional control valve VPWP.
- Up to 7 modules (max. 7 axes) can be operated in parallel and independently of each other.
- Commissioning via the Festo configuration software FCT or via fieldbus.

CPX-CMPX

- Fast travel between the mechanical end stops of the cylinder, stopping gently and without impact in the end position.
- Fast commissioning via control panel, fieldbus or handheld unit.
- Improved downtime control.
- Actuation of a brake or clamping unit via the proportional directional control valve VPWP.
- Max. 9 end-position controllers can be actuated depending on the fieldbus.
- All system data can be read and written via the fieldbus, including the mid positions, for example.

Ordering

The CPX terminal with valve terminal is fully assembled according to your order specifications and individually tested. The finished valve terminal consists of the electrical peripherals including the desired actuation and the selected components of the VTSA (ISO), VTSA-F, CPA, MPA-S, MPA-F, MPA-L or MIDI/MAXI modules.

The CPX terminal with valve terminal is ordered using two separate order codes. One order code defines the electrical peripherals type CPX, while the other specifies the pneumatic components of the valve terminal.

The electrical peripherals type CPX can also be configured without a valve terminal and can be used on a fieldbus. For this order, only the order code for the electrical peripherals is required.

The order lists for the pneumatic components can be found on

- ➔ Internet: vtsa (valve terminal VTSA)
- ➔ Internet: vtsa-f (valve terminal VTSA-F)
- ➔ Internet: cpa10 (valve terminal CPA)
- ➔ Internet: mpa-s (valve terminal MPA-S)
- ➔ Internet: mpa-f (valve terminal MPA-F)
- ➔ Internet: mpa-l (valve terminal MPA-L)
- ➔ Internet: visb (valve terminal VIMP-/VIFB-03)

The order lists for the CP/CPI components can be found on

- ➔ Internet: ctec (CPI installation system)

The order lists for the CTEU/CTEL components can be found on

- ➔ Internet: cteu (I-Port interface/IO-Link)

Complete overview of modules

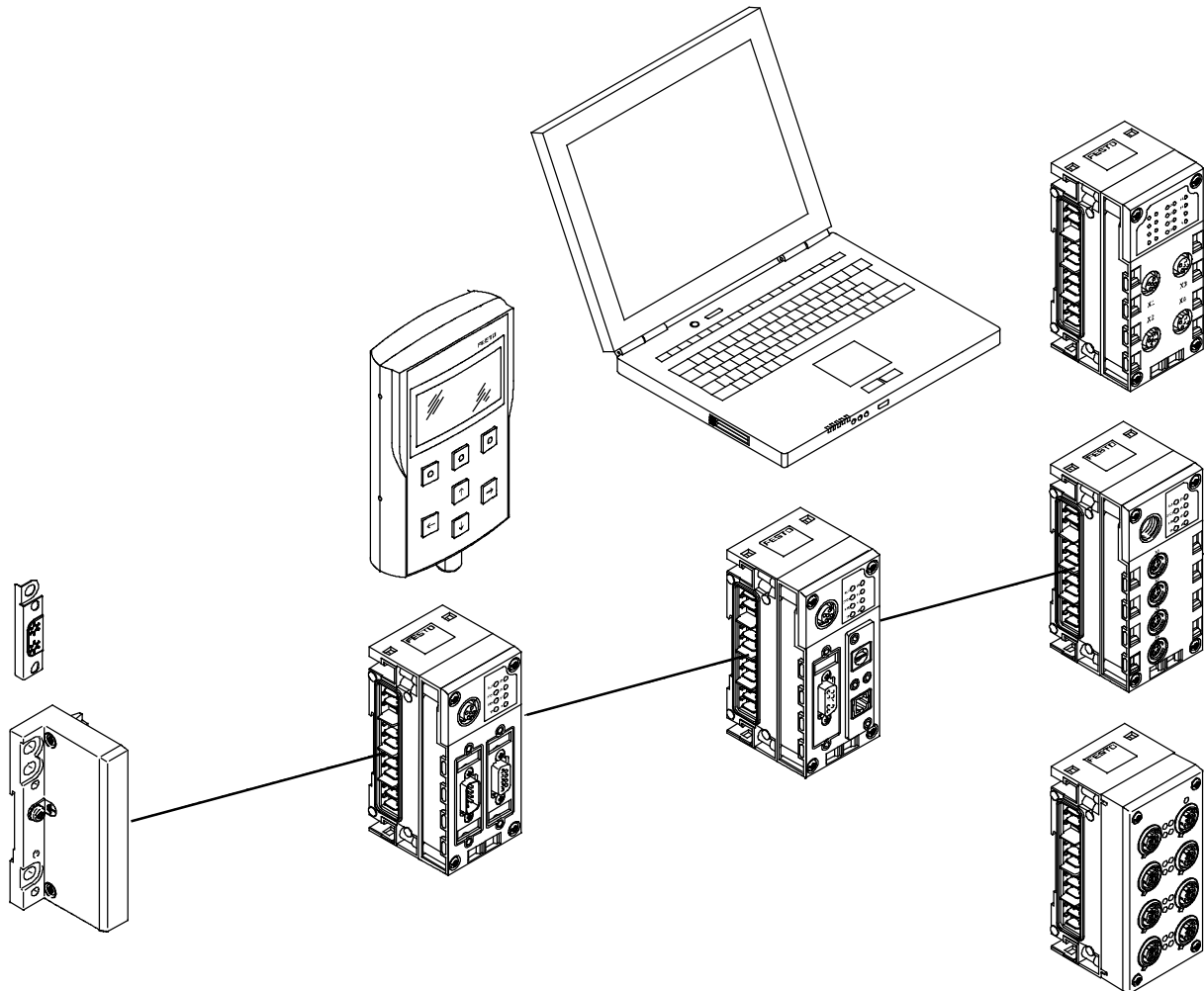

End plate

- Mounting holes for wall mounting
- Functional earth connection
- Special earthing plate for safe and easy connection to the machine bed or H-rail
- External power supply for the entire system

Bus node

- Fieldbus/Industrial Ethernet connection using various types of connection technology
- Setting of fieldbus parameters via DIL switch
- Display of fieldbus and peripheral equipment status via LED
- PROFINET to AIDA standard in metal housing, fast start-up

Operator unit

- Connection to bus nodes or control block
- Display and modification of parameter settings
- Plain-text display for texts, messages (e.g. individual channel diagnostics, condition monitoring), menus, etc.

Control block

- Pre-processing, stand-alone controller or remote unit CPX-FEC/CPX-CEC
- Connection via Ethernet TCP/IP or Sub-D programming interface
- Setting of operating modes via DIL switch and program selection via rotary switch
- CPX-CMX products for controlling axes

Web monitor

- Website integrated in the CPX terminal
- Dynamic status display
- Online diagnostics
- SMS/e-mail alert

CP interface/CTEL interface

- Interfaces for decentralised installation systems, thus optimising the pneumatic control chains (short tubes/short cycle times)
- Actuation for I/O modules and valve terminals
- Power supply and bus interface via the same cable

Input/output modules

- Combination of
- Interlinking block
 - Electronics module
 - Connection block

Terminal CPX

Peripherals overview

FESTO

Complete overview of modules

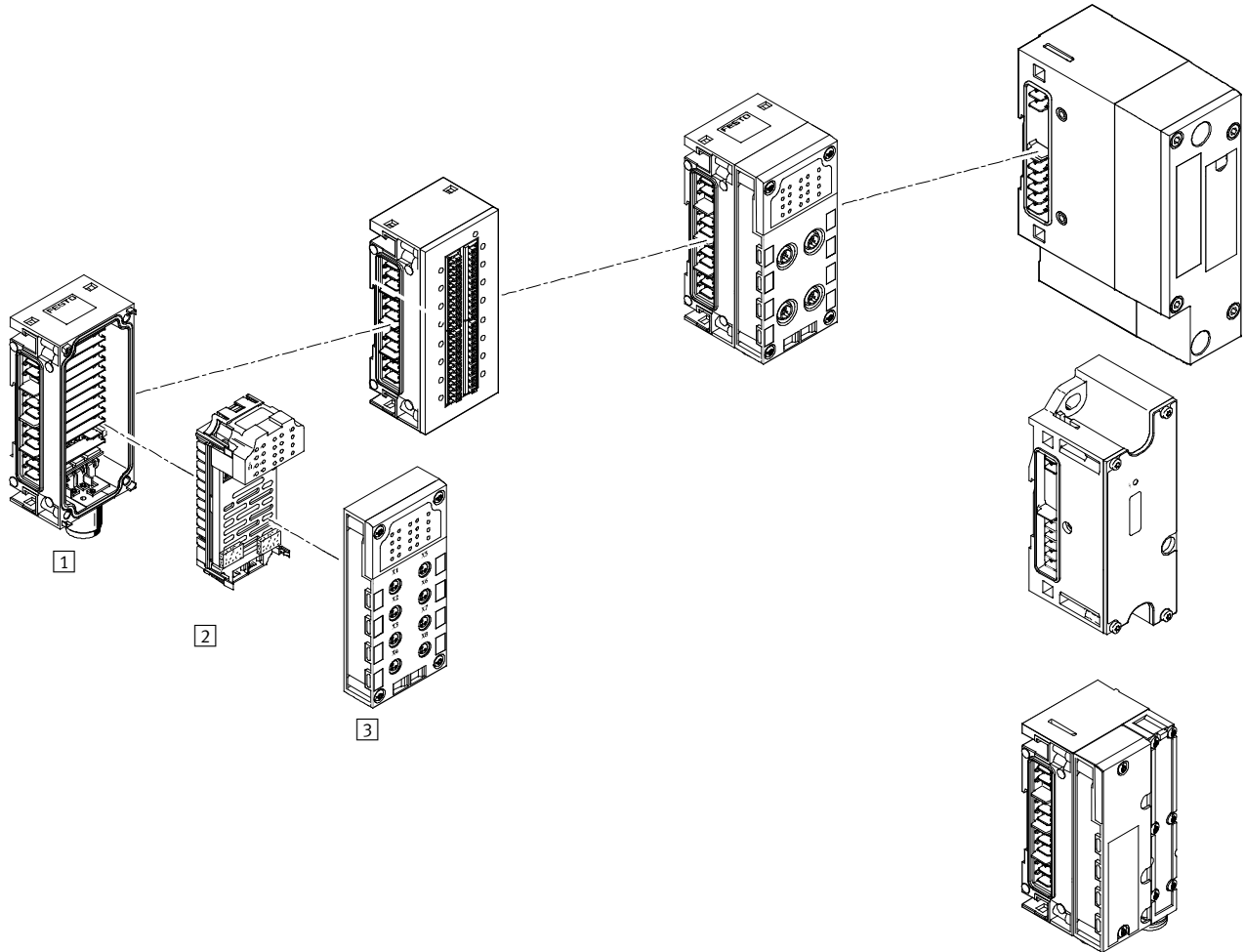

Input/output modules

1 Interlinking block

- Internal linking of the power supply and serial communication
- External power supply for the entire system
- Additional power supply for outputs or valves
- Connection accessories for M18, 7/8" or AIDA push-pull
- Plastic design: linking with tie rods
- Metal design: individual linking with M6 screws, individually expandable

2 Electronics module

- Digital inputs for connecting the sensors
- Digital outputs for activating additional actuators
- Analogue inputs
- Temperature inputs (analogue)
- Analogue outputs
- PROFI-safe shut-off module with two digital outputs for shutting off the supply voltage for valves

3 Connection block

- Choice of 8 connection technology variants
- Protection class IP65/IP67 or IP20
- Can be combined with the electronics modules
- M8/M12/Sub-D/quick connection
- M8/M12/Sub-D, etc. connecting cables
- Modular system for M8/M12 connecting cables
- M12 connection technology for the metal design

Pneumatics interface

- MPA-S
- MPA-F
- MPA-L
- VTSA/VTSA-F
- MIDI/MAXI
- CPA10/14

Individual overview of modules

Bus node

→ 69

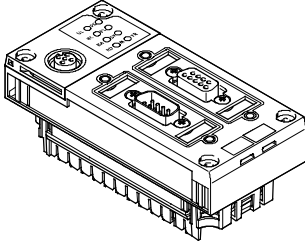

Bus node for

- PROFIBUS DP
- INTERBUS
- DeviceNet
- CANopen
- CC-LINK
- Ethernet/IP
(integrated web server)
- PROFINET
(integrated web server)
- EtherCAT

Control block

→ 59

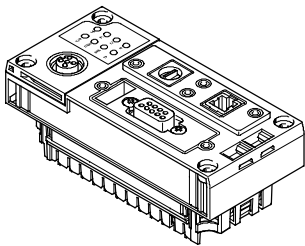

CPX-FEC

- Programming with FST
- Ethernet interface
- Modbus/TCP
- EasyIP
- Integrated web server
- Sub-D programming interface

CPX-CEC

- Programming with CoDeSys
- Ethernet interface
- Modbus/TCP
- EasyIP
- CANopen master

CP interface

→ 118

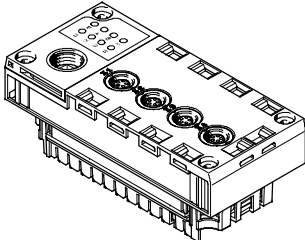

Interface CPX-CP

- 4 CP strings
- Max. 4 modules per string
- 32 inputs/32 outputs per string
- CPI functionality

CTEL interface

→ 123

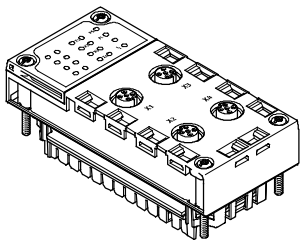

CPX-CTEL interface

- CTEL master
- Max. 4 devices with individual electronic fuse protection
- Max. 64 inputs/64 outputs per I-Port interface
- The maximum length of a string is 20 m

Terminal CPX

Peripherals overview

Individual overview of modules

Modules for actuating electric drive units

→ 128

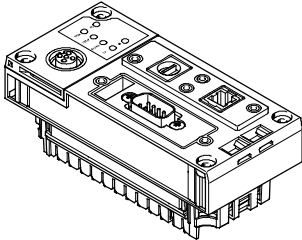

CPX-CMXX

- Multi-axis interface
- Ethernet interface
- 2 axis groups with max. 4 axes per group
- Max. 1024 positioning records per axis group

CPX-CM-HPP

- Axis interface
- CAN bus for up to 4 individual electric axes

Modules for controlling pneumatic drive units

→ 135

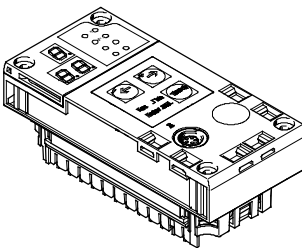

CPX-CMAX

- Axis controller
- Position and force control
- 64 configurable positioning records
- Auto-identification
- Control of a brake or clamping unit via the proportional directional control valve VPWP

CPX-CMPX

- End-position controller
- Fast travel between the mechanical end stops of the cylinder
- Smooth travel into the end position
- Improved control of downtime
- Control of a brake via the proportional directional control valve VPWP

CPX-CMIX

- Measuring module
- CAN input (Festo specification) for measuring signal
- Recording of the absolute position values or speed values of the connected drive

Plastic connection block

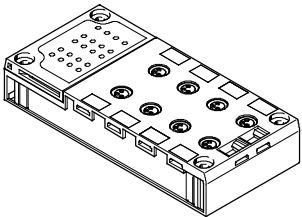

Direct machine mounting (protection class IP65/IP67)

- M8-3POL
- M8-4POL
- M12-5POL
- M12-5POL quick lock, metal thread screened
- M12-8POL
- Sub-D
- Quick connector
- Spring-loaded terminal with cover

Protected fitting space (protection class IP20)

- Spring-loaded terminal

Screening concept

- Optional screening plate for connection blocks with M12 connection technology

Metal manifold block

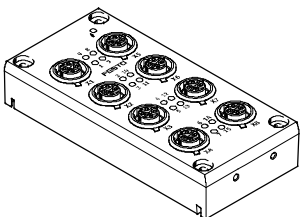

Direct machine mounting (protection class IP65/IP67)

- M12-5POL

Connection block including electronics module and interlinking block

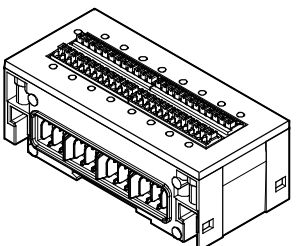

Installation in the control cabinet (protection class IP20)

- Plastic connection block
- Spring-loaded terminal
- Digital input module with 16 inputs
- Digital I/O module with 8 inputs and 8 outputs

Individual overview of modules

Digital electronics module for inputs/outputs

→ 144

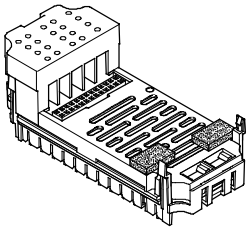

Digital inputs

- 4 digital inputs
- 8 digital inputs NPN
- 8 digital inputs PNP
- 8 digital inputs PNP with individual channel diagnostics
- 16 digital inputs
- 16 digital inputs with individual channel diagnostics

Digital outputs

- 4 digital outputs (1 A per channel, individual channel diagnostics)
- 8 digital outputs (0.5 A per channel, individual channel diagnostics)
- 8 digital outputs (2.1 A/50 W lamp load per channel pair, individual channel diagnostics)

Multi I/O modules

- 8 digital inputs and 8 digital outputs
- 2 digital inputs (counter channels, connection to various encoders) and 2 digital outputs (directly controlled by the input values)

Analogue electronics module for inputs/outputs

→ 171

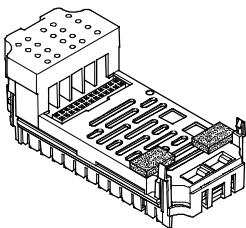

Analogue inputs

- 2 analogue inputs (0 ... 10 V DC, 0 ... 20 mA, 4 ... 20 mA)
- 4 analogue inputs (1 ... 5 V, 0 ... 10 V, -5 ... +5 V, -10 ... +10 V, 0 ... 20 mA, 4 ... 20 mA, -20 ... +20 mA)

Analogue temperature inputs

- 4 analogue inputs for temperature measurement (Pt100, Pt200, Pt500, Pt1000, Ni100, Ni120, Ni500, Ni1000)
- 4 analogue inputs for temperature measurement (thermocoupler and PT1000 sensor for cold-junction compensation)

Analogue outputs

- 2 analogue outputs (0 ... 10 V DC, 0 ... 20 mA, 4 ... 20 mA)

PROFIsafe shut-off module

→ 190

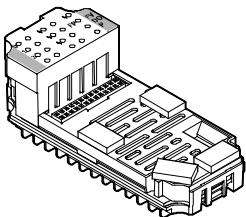

Digital outputs

- 2 digital outputs
- Supply voltage for valves can be shut off

Analogue electronics module for pressure inputs

→ 176

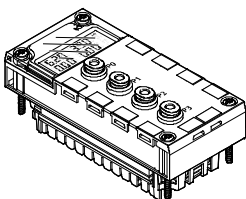

Analogue inputs

- 4 analogue supply ports (0 ... 10 bar, -1 ... +1 bar)

Terminal CPX

Peripherals overview

FESTO

Individual overview of modules

Plastic interlinking block – Interlinking by means of tie rods

→ 199

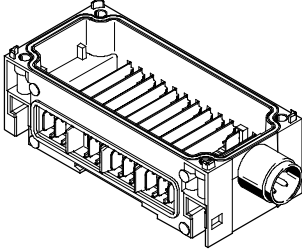

System linking

- Different voltages for supplying the modules
- Serial communication between the modules

In addition to system linking, power supply for the

- electronics plus sensors (16 A)
- valves plus actuators (16 A)

Power supply for the

- valves (16 A per supply)

System supply

- M18 4-pin
- 7/8" 4-pin or 5-pin

Additional power supply

In addition to system linking, power supply for the

- actuators (16 A per supply)

Expandability

- Can be expanded using an interlinking block with tie-rod extension CPX-ZA-1-E

Metal interlinking block – Individual linking

→ 199

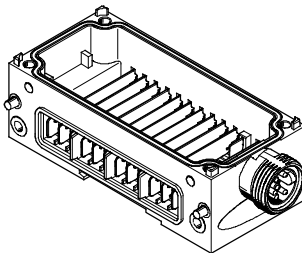

System linking

- Different voltages for supplying the modules
- Serial communication between the modules

In addition to system linking, power supply for the

- electronics plus sensors (16 A)
- valves plus actuators (16 A)

Power supply for the

- valves (16 A per supply)

System supply

- 7/8" 4-pin or 5-pin
- AIDA push-pull

Additional power supply

In addition to system linking, power supply for the

- actuators (16 A per supply)

Expandability

- Can be expanded as required by up to 10 interlinking blocks

- Note

Plastic interlinking blocks (tie rods) and metal interlinking blocks (individual linking) cannot be combined due to their different interlinking systems.

- Note

The 7/8" supply is subject to the following restriction due to the available accessories:

- 5-pin 8 A
- 4-pin 10 A

- Note

The usage of appropriate interlinking blocks (CPX-...-VL) is required for use in ATEX environments as per approval certificate (→ 46). The maximum supply is limited to 8 A for these modules.

Individual overview of modules

Pneumatic interface MPA-S

→ 213

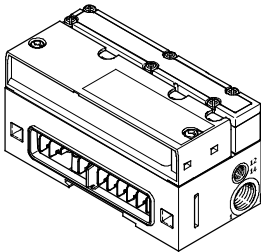

Valve terminal

- MPA1 (360 l/min)
- MPA2 (700 l/min)
- Up to 128 solenoid coils
- Up to 16 modules can be configured
- For CPX plastic design
- For CPX metal design

Pneumatic interface MPA-L

→ 215

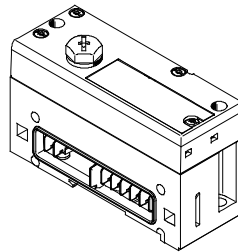

Valve terminal

- MPA1 (360 l/min)
- MPA14 (670 l/min)
- MPA2 (870 l/min)
- Up to 32 solenoid coils
- For CPX plastic design

Pneumatic interface MPA-F

→ 216

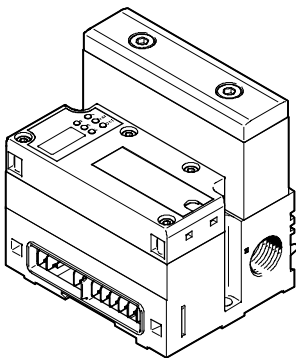

Valve terminal

- MPAF1 (360 l/min)
- MPAF2 (900 l/min)
- Up to 128 solenoid coils
- Up to 16 modules can be configured
- With integrated pressure sensor for channel 1
- For CPX plastic design
- For CPX metal design

Pneumatic interface VTSA/VTSA-F

→ 218

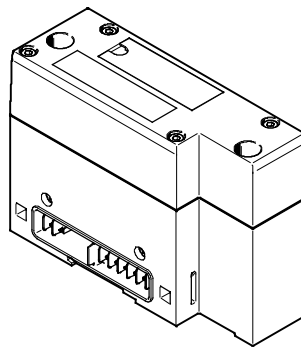

Valve terminal (valve flow rate according to width)

- 18 mm (700 l/min)
- 26 mm (1,350 l/min)
- 42 mm (1,300 l/min)
- 52 mm (2,900 l/min)
- 65 mm (4,000 l/min)
- Max. 32 valve positions/
max. 32 solenoid coils
- For CPX plastic design
- For CPX metal design

Pneumatic interface MIDI/MAXI

→ 219

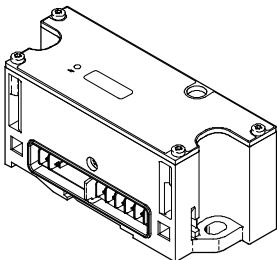

Valve terminal

- MIDI valves (500 l/min)
and/or
MAXI valves (1250 l/min)
- Up to 26 solenoid coils
- Setting of the number of valves via
DIL switch
- For CPX plastic design
- For CPX metal design

Pneumatic interface CPA

→ 221

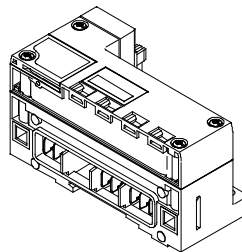

Valve terminal

- CPA10 (300 l/min)
- CPA14 (600 l/min)
- Up to 22 solenoid coils
- Setting of the number of valves via
DIL switch
- For CPX plastic design

Terminal CPX

Peripherals overview

FESTO

Individual overview of modules

End plate for plastic/metal design

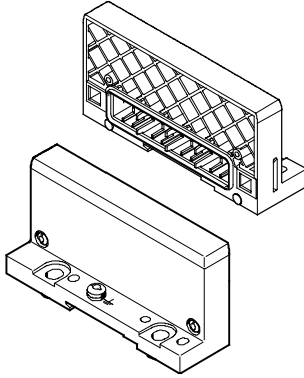

End plate

- Left-hand
- Right-hand (for using of the CPX terminal without valves)

End plate with system power supply

→ 195

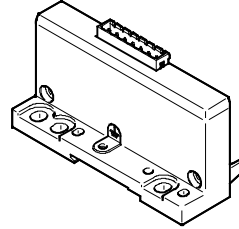

End plate

- Left-hand
- For plastic design
- Different voltages for supplying the CPX terminal

End plate with extension

→ 197

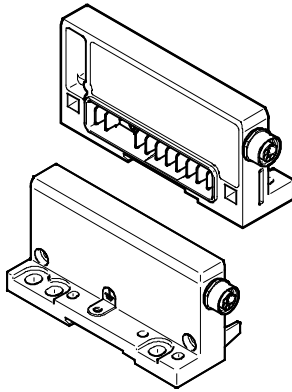

End plate

- Left-hand
- Right-hand
- Enables the CPX terminal to be separated into two interconnected units (series)
- Simplifies control cabinet installation
- For plastic or metal design

Earthing plate (for end plate for plastic design)

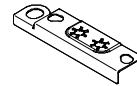

Earthing plate

- For safe and easy connection to the machine bed or H-rail, suitable for right-hand and left-hand end plate
- Assembly and earthing in a single processing step, which means:
 - 50% time saving
 - No additional material required

Terminal CPX

Peripherals overview

General basic data and guidelines

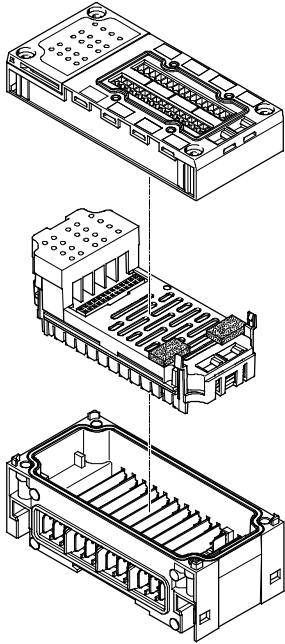

Max. 11 modules in total:

- One bus node and/or one control block, freely positionable
- Up to 9 additional input/output modules, freely positionable
- An additional pneumatic interface always positioned as the last module on the right-hand side
 - With VTSA, VTSA-F, MPA-F, CPA and MIDI/MAXI: fixed operating range, set using DIL switch
 - With MPA-S: 16 MPA modules can be configured
 - With MPA-L: fixed operating range, set using rotary switch
- Address capacity max. 512 inputs and 512 outputs, depending on bus node or control block
- One interlinking block with system supply
- Multiple interlinking blocks with additional power supply, always positioned to the right of the interlinking block with system supply
- The connection blocks can, with just a few exceptions, be freely combined with the electronics modules for inputs/outputs, either in metal or plastic (→ table below)
- The electronics modules for inputs/outputs can be combined with various interlinking blocks
- Plastic interlinking blocks (tie rods) and metal interlinking blocks (individual linking) cannot be combined due to their different interlinking systems

Combinations of connection blocks and digital input modules

	Digital electronics modules						
	CPX-4DE	CPX-8DE	CPX-16DE	CPX-L-16DE	CPX-M-16DE-D	CPX-8DE-D	CPX-8NDE
Connection blocks, plastic design							
CPX-AB-8-M8-3POL	■	■	–	–	–	■	■
CPX-AB-8-M8X2-4POL	–	–	■	–	–	–	–
CPX-AB-4-M12x2-5POL	■	■	–	–	–	■	■
CPX-AB-4-M12x2-5POL-R	■	■	–	–	–	■	■
CPX-AB-4-M12-8POL	–	–	–	–	–	–	–
CPX-AB-8-KL-4POL	■	■	■	–	–	■	■
CPX-AB-1-SUB-BU-25POL	■	■	■	–	–	■	■
CPX-AB-4-HAR-4POL	■	■	–	–	–	■	■
Connection blocks, metal design							
CPX-M-AB-4-M12X2-5POL	■	■	–	–	–	■	■
CPX-M-AB-8-M12X2-5POL	–	–	–	–	■	–	–

Terminal CPX

Peripherals overview



Combinations of connection blocks and digital output modules/multi I/O modules								
	Digital electronics modules							
	CPX-4DA	CPX-8DA	CPX-8DA-H	CPX-8DE-8DA	CPX-L-8DE-8DA	CPX-2ZE2DA	CPX-FVDA-P	CPX-FVDA-P2
Connection blocks, plastic design								
CPX-AB-8-M8-3POL	■	■	-	-	-	-	-	-
CPX-AB-8-M8X2-4POL	■	■	■	-	-	-	-	-
CPX-AB-4-M12x2-5POL	■	■	-	-	-	-	-	-
CPX-AB-4-M12x2-5POL-R	■	■	■	-	-	-	-	-
CPX-AB-4-M12-8POL	-	-	-	■	-	-	-	-
CPX-AB-8-KL-4POL	■	■	■	■	-	-	-	■
CPX-AB-1-SUB-BU-25POL	■	■	■	■	-	-	-	-
CPX-AB-4-HAR-4POL	■	■	-	-	-	-	-	-
Connection blocks, metal design								
CPX-M-AB-4-M12X2-5POL	■	■	■	-	-	-	■	■
CPX-M-AB-8-M12X2-5POL	-	-	-	-	-	-	-	-

Combinations of connection blocks and analogue electronics modules for inputs/outputs								
	Analogue electronics modules							
	CPX-2AE-U-I	CPX-4AE-U-I	CPX-4AE-I	CPX-2AA-U-I	CPX-4AE-P	CPX-4AE-T	CPX-4AE-TC	
Connection blocks, plastic design								
CPX-AB-8-M8-3POL	-	-	-	-	-	-	-	-
CPX-AB-8-M8X2-4POL	-	-	-	-	-	-	-	-
CPX-AB-4-M12x2-5POL	■	■	■	■	-	■	■	
CPX-AB-4-M12x2-5POL-R	■	■	■	■	-	■	■	
CPX-AB-4-M12-8POL	-	-	-	-	-	-	-	
CPX-AB-8-KL-4POL	■	■	■	■	-	■	■	
CPX-AB-1-SUB-BU-25POL	■	■	■	■	-	-	-	
CPX-AB-4-HAR-4POL	-	-	-	-	-	■	-	
Connection blocks, metal design								
CPX-M-AB-4-M12X2-5POL	■	■	■	■	-	■	■	
CPX-M-AB-8-M12X2-5POL	-	-	-	-	-	-	-	

Terminal CPX

Key features – Electrical components

Electrical connection – Connection block

CPX-AB-8-M8-3POL with M8-3POL connection

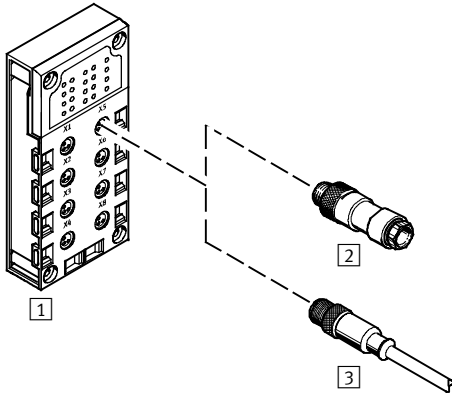

- Compact for pre-assembled individual connection
- 8 sockets
- 3-pin design for connecting 1 channel per socket



Note

Festo delivers pre-assembled M8/M12 connecting cables (NEBU modular system) on request:

- Tailored to the application
- Perfect fit
- Saves installation space

Combination of connection block and electrical connection technology

Connection block	Connection technology	Plug connector/connecting cable	Selectable connection technology
1 CPX-AB-8-M8-3POL	Socket, M8, 3-pin	2 SEA-GS-M8	Solder lugs
		2 SEA-3GS-M8-S	Screw terminals
		3 KM8-M8-GSGD-... (pre-assembled connecting cable)	Socket, M8, 3-pin
		3 NEBU-...-M8G3 (modular system for choice of connecting cables)	Socket, M5, 3-pin
			Socket, M8, 3-pin
Socket, M8, 4-pin			
			Socket, M12, 5-pin
			Open cable end

Terminal CPX

Key features – Electrical components

Electrical connection – Connection block

CPX-AB-8-M8X2-4POL with M8-4POL connection

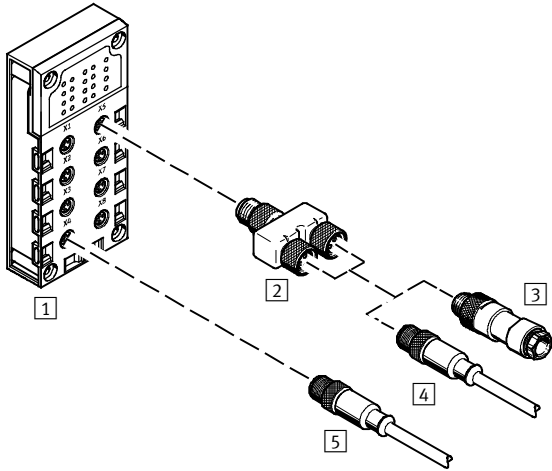

- Compact for pre-assembled individual connection
- 8 sockets
- 4-pin design for connecting 2 channels per socket

Combination of connection block and electrical connection technology								
Connection block	Connection technology	Plug connector/ connecting cable	Selectable connection technology	Plug connector/ connecting cable	Selectable connection technology			
1 CPX-AB-8-M8X2-4POL	Socket, M8, 4-pin	4 NEBU-...-M8G4 (modular system for choice of connecting cables)	Socket, M5, 3-pin	–	–			
			Socket M8, 3-pin	–	–			
			Socket, M8, 4-pin	–	–			
			Socket, M12, 5-pin	–	–			
			Open cable end	–	–			
		2 NEDU-M8D3-M8T4 (T-adaptor)	1x plug M8, 4-pin to 2x socket M8, 3-pin	3 SEA-GS-M8	Solder lugs	3 SEA-3GS-M8-S	Screw terminals	
					4 KM8-M8-GSGD-... (pre-assembled connecting cable)	Socket, M8, 3-pin	4 NEBU-...-M8G3 (modular system for choice of connecting cables)	Socket, M5, 3-pin
						Socket, M8, 3-pin		Socket, M8, 3-pin
						Socket, M8, 4-pin		Socket, M8, 4-pin
					Socket, M12, 5-pin	Socket, M12, 5-pin		
Open cable end	Open cable end							

Terminal CPX

Key features – Electrical components

FESTO

Electrical connection – Connection block

CPX-AB-4-M12x2-5POL and CPX-AB-4-M12x2-5POL-R with M12-5POL connection

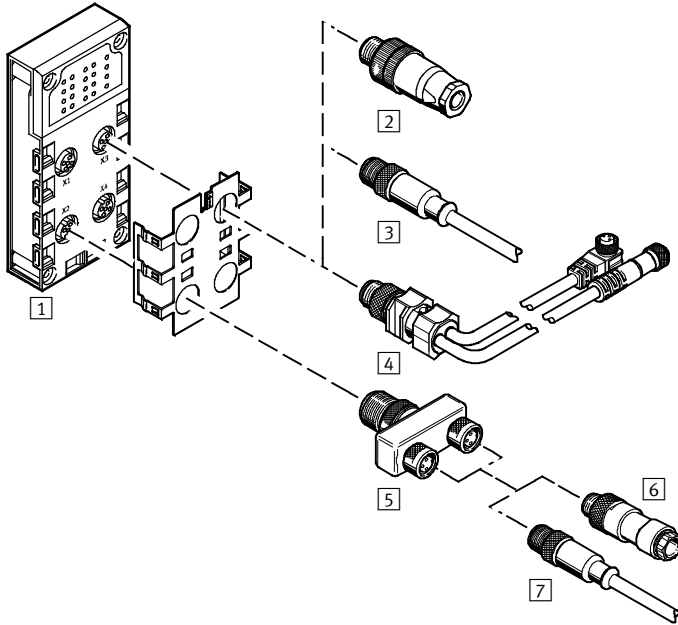

- Suitable for self-assembly and sturdy with 2 channels per socket
- 4 sockets
- 5-pin design per socket
- Version ...-R with quick lock technology and metal thread for screening
- With two channels per socket, the corresponding input signals can be easily connected via a T-adaptor and conventional cable with M8 connection

Terminal CPX

Key features – Electrical components

Combination of connection block and electrical connection technology							
Connection block	Connection technology	Plug connector/ connecting cable	Connection technology	Plug connector/ connecting cable	Connection technology		
1 CPX-AB-4-M12x2-5POL CPX-AB-4-M12x2-5POL-R	Socket, M12, 5-pin	2 SEA-GS-7	Screw terminals	-	-		
		2 SEA-4GS-7-2,5	Screw terminals	-	-		
		2 SEA-GS-9	Screw terminals	-	-		
		2 SEA-M12-5GS-PG7	Screw terminals	-	-		
		2 SEA-GS-11-DUO	Screw terminals, for two cables	-	-		
		2 SEA-5GS-11-DUO	Screw terminals, for two cables	-	-		
		3 KM12-M12-... (pre-assembled connecting cable)	Socket, M12, 4-pin	-	-		
		3 NEBU-...-M12G4	Socket, M5, 4-pin	-	-		
		3 NEBU-...-M12G5	Socket, M8, 4-pin	-	-		
			Socket, M12, 5-pin	-	-		
			Open cable end	-	-		
		4 KM12-DUO-M8-... (pre-assembled connecting cable)	Plug M12, 4-pin to 2x socket M8, 3-pin	6 SEA-GS-M8	Solder lugs		
		5 NEDU-M8D3-M12T4 (T-adapter)		6 SEA-3GS-M8-S	Screw terminals		
		5 NEDU-M12D5-M12T4 (T-adapter)				7 KM8-M8-GSGD-... (pre-assembled connecting cable)	Socket, M8, 3-pin
						7 NEBU-...-M8G3 (modular system for choice of connecting cables)	Socket, M5, 3-pin
							Socket, M8, 3-pin
							Socket, M8, 4-pin
							Socket, M12, 5-pin
						Open cable end	
						6 SEA-GS-7	Screw terminals
						6 SEA-4GS-7-2,5	Screw terminals
						6 SEA-GS-9	Screw terminals
						6 SEA-M12-5GS-PG7	Screw terminals
		6 SEA-GS-11-DUO	Screw terminals, for two cables				
6 SEA-5GS-11-DUO	Screw terminals, for two cables						
7 KM12-M12-... (pre-assembled connecting cable)	Socket, M12, 4-pin						
7 NEBU-...-M12G4 (modular system for choice of connecting cables)	Socket, M5, 4-pin						
7 NEBU-...-M12G5 (modular system for choice of connecting cables)	Socket, M8, 4-pin						
	Socket, M12, 5-pin						
	Open cable end						

Terminal CPX

Key features – Electrical components

FESTO

Electrical connection – Connection block (metal design)

CPX-M-AB-4-M12X2-5POL with M12-5POL connection

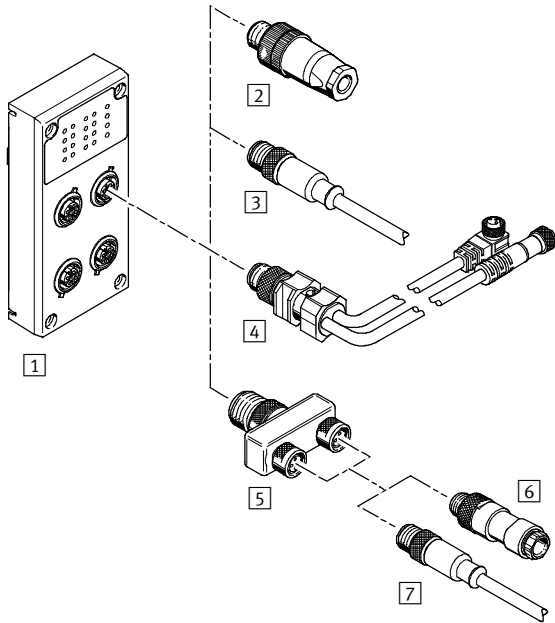

- Suitable for self-assembly and sturdy with 2 channels per socket
- 4 sockets
- 5-pin design per socket
- With two channels per socket, the corresponding input signals can be easily connected via a T-adapter and conventional cable with M8 connection

CPX-M-AB-8-M12X2-5POL with M12-5POL connection

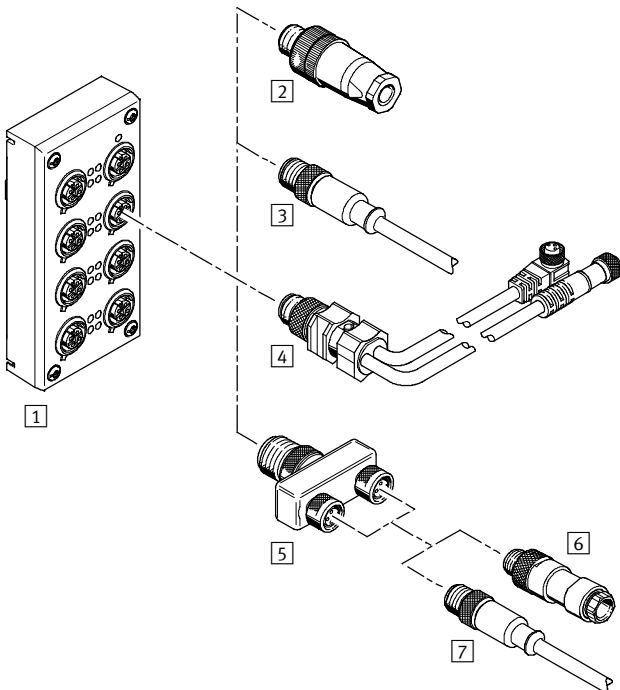

- Suitable for self-assembly and sturdy with 2 channels per socket
- 8 sockets
- 5-pin design per socket
- With two channels per socket, the corresponding input signals can be easily connected via a T-adapter and conventional cable with M8 connection

- - Note

Max. 4 T-adapters (NEDU) can be mounted on a connection block CPX-M-AB-8-M12X2-5POL.

Terminal CPX

Key features – Electrical components

Combination of connection block and electrical connection technology							
Connection block	Connection technology	Plug connector/ connecting cable	Connection technology	Plug connector/ connecting cable	Connection technology		
1 CPX-M-AB-4-M12X2-5POL CPX-M-AB-8-M12X2-5POL	Socket, M12, 5-pin	2 SEA-GS-7	Screw terminals	-	-		
		2 SEA-4GS-7-2,5	Screw terminals	-	-		
		2 SEA-GS-9	Screw terminals	-	-		
		2 SEA-M12-5GS-PG7	Screw terminals	-	-		
		2 SEA-GS-11-DUO	Screw terminals, for two cables	-	-		
		2 SEA-5GS-11-DUO	Screw terminals, for two cables	-	-		
		3 KM12-M12-... (pre-assembled connecting cable)	Socket, M12, 4-pin	-	-		
		3 NEBU-...-M12G4	Socket, M5, 4-pin	-	-		
		3 NEBU-...-M12G5	Socket, M8, 4-pin	-	-		
			Socket, M12, 5-pin	-	-		
			Open cable end	-	-		
		4 KM12-DUO-M8-... (pre-assembled connecting cable)	Plug M12, 4-pin to 2x socket M8, 3-pin	6 SEA-GS-M8	Solder lugs		
		5 NEDU-M8D3-M12T4 (T-adapter)		6 SEA-3GS-M8-S	Screw terminals		
				7 KM8-M8-GSGD-... (pre-assembled connecting cable)	Socket, M8, 3-pin		
				7 NEBU-...-M8G3 (modular system for choice of connecting cables)	Socket, M5, 3-pin		
					Socket, M8, 3-pin		
		Socket, M8, 4-pin					
		5 NEDU-M12D5-M12T4 (T-adapter)				7 NEBU-...-M8G3 (modular system for choice of connecting cables)	Socket, M12, 5-pin
						Open cable end	
						6 SEA-GS-7	Screw terminals
						6 SEA-4GS-7-2,5	Screw terminals
						6 SEA-GS-9	Screw terminals
						6 SEA-M12-5GS-PG7	Screw terminals
						6 SEA-GS-11-DUO	Screw terminals, for two cables
6 SEA-5GS-11-DUO	Screw terminals, for two cables						
7 KM12-M12-... (pre-assembled connecting cable)	Socket, M12, 4-pin						
7 NEBU-...-M12G4 (modular system for choice of connecting cables)	Socket, M5, 4-pin						
7 NEBU-...-M12G5 (modular system for choice of connecting cables)	Socket, M8, 4-pin						
	Socket, M12, 5-pin						
Open cable end							

Terminal CPX

Key features – Electrical components

Electrical connection – Connection block

CPX-AB-4-M12-8POL with M12-8POL connection

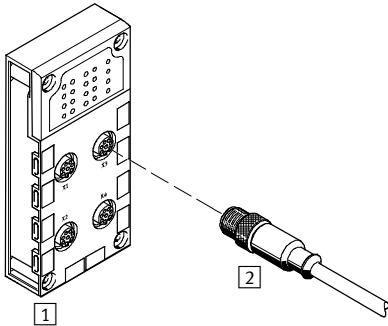

- Connection to cylinder/valve combinations with max. 3 inputs and 2 outputs
- 4 sockets
- 8-pin design per socket

Combination of connection block and electrical connection technology

Connection block	Connection technology	Plug connector/connecting cable	Selectable connection technology
1 CPX-AB-4-M12-8POL	Socket, M12, 8-pin	2 KM12-8GD8GS-2-PU (pre-assembled connecting cable)	Socket, M12, 8-pin

CPX-AB-8-KL-4POL, CPX-2ZE2DA with spring-loaded terminal connection

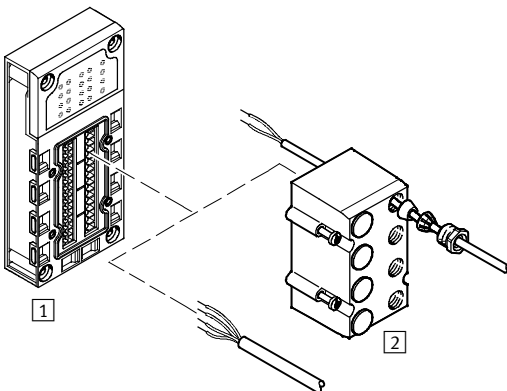

- Quick connection technology for use in control cabinets
- 32 spring-loaded terminals
- 4 spring-loaded terminals per channel
- Wire cross sections 0.05 ... 1.5 mm²
- Optional cover with fittings for IP65/67 connection
 - 8 through-holes M9
 - 1 through-hole M16
 - Blanking plug
 - For I/O distributors, consoles or individual sensors/actuators

Combination of connection block and electrical connection technology

Connection block	Connection technology	Plug connector/connecting cable	Selectable connection technology
1 CPX-AB-8-KL-4POL CPX-2ZE2DA	Spring-loaded terminals, 32-pin	2 AK-8KL (cover)	–

Terminal CPX

Key features – Electrical components

Electrical connection – Connection block

CPX-AB-1-SUB-BU-25POL with Sub-D connection

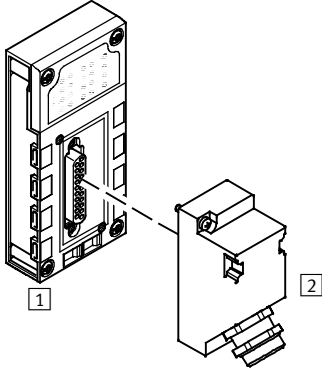

- Multi-pin plug connection for I/O distributor or console
- One socket
- 25-pin design

Combination of connection block and electrical connection technology

Connection block	Connection technology	Plug connector/connecting cable	Selectable connection technology
1 CPX-AB-1-SUB-BU-25POL	Socket, Sub-D, 25-pin	2 SD-SUB-D-ST25	Crimp contacts

CPX-AB-4-HAR-4POL with quick connection

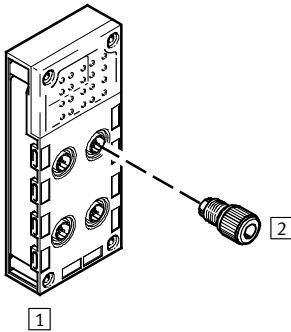

- Sturdy quick connection technology for individual connections
- 4 sockets
- 4-pin design per socket

Combination of connection block and electrical connection technology

Connection block	Connection technology	Plug connector/connecting cable	Selectable connection technology
1 CPX-AB-4-HAR-4POL	Socket, quick connection, 4-pin	2 SEA-GS-HAR-4POL	Insulation displacement connectors

Terminal CPX

Key features – Assembly

FESTO

Hood

Description

→ 234

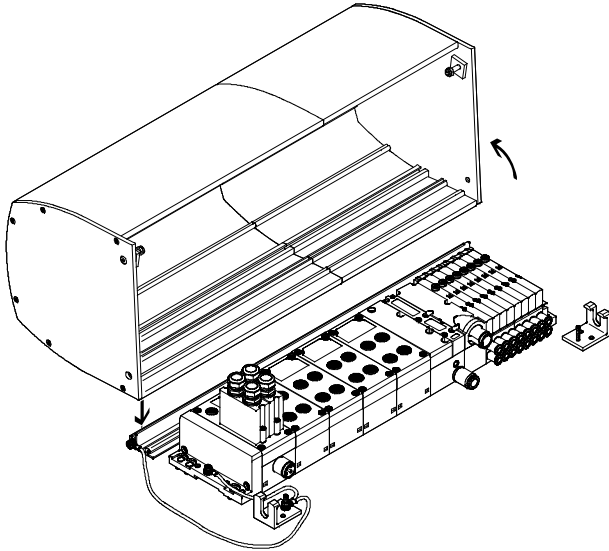

The CPX hood CAFC is a space- and cost-saving alternative to a control cabinet. It is designed as an extruded aluminium profile and is installed on a mounting plate. The valve terminal (CPX with MPA-S or MPA-L) is well protected and is quick to install without the need for complex control cabinet installation for cables and tubing.

The rail and the two mounting brackets are mounted on a base plate. The hood is attached to the retaining rail and secured with two screws. There is also a stand-by position (locking of the hood in the open position). The hood is locked using two side screws (which meet the requirements for a special lock in compliance with ATEX). The CPX hood can be ordered online using the valve terminal configurator.

Advantages of the CPX hood

- Impact protection (min. 7 J) for the underlying modules in combination with a suitable mounting plate provided by the user
- Protection against electrostatic discharge through the use of electrically conductive materials and the option of connecting an earth wire
- Protection against disconnection of live plug connectors (by securing the hood with at least one special lock to EN 600079-0, 9.2 and 20)
- UV protection for the underlying CPX and MPA modules

Points to note when using the CPX hood

- Only in combination with valve terminal MPA-S and MPA-L
- No bus nodes with push-pull connection (CPX-M-FB34, CPX-M-FB35)
- CPX power supply via angled plugs, no T-plugs, no push-pull
- Electrical supply plate/additional power supply only possible with angled plug
- No MPA vertical stacking
- Use of larger QS fittings (for tubing O.D. larger than 12 mm) only possible with the angled design
- Ducted exhaust air only with elbow connector
- The permissible ambient temperature of the valve terminal is reduced by 5 °C

Note

The CPX hood has no influence on the ATEX classification of the valve terminal or of the CPX terminal.

The CPX hood has no influence on the IP protection class of the valve terminal or of the CPX terminal.

The CPX hood does not protect against the effects of the weather in installations that are not in closed spaces.

Terminal CPX

Key features – Assembly

FESTO

Hood

Mounting

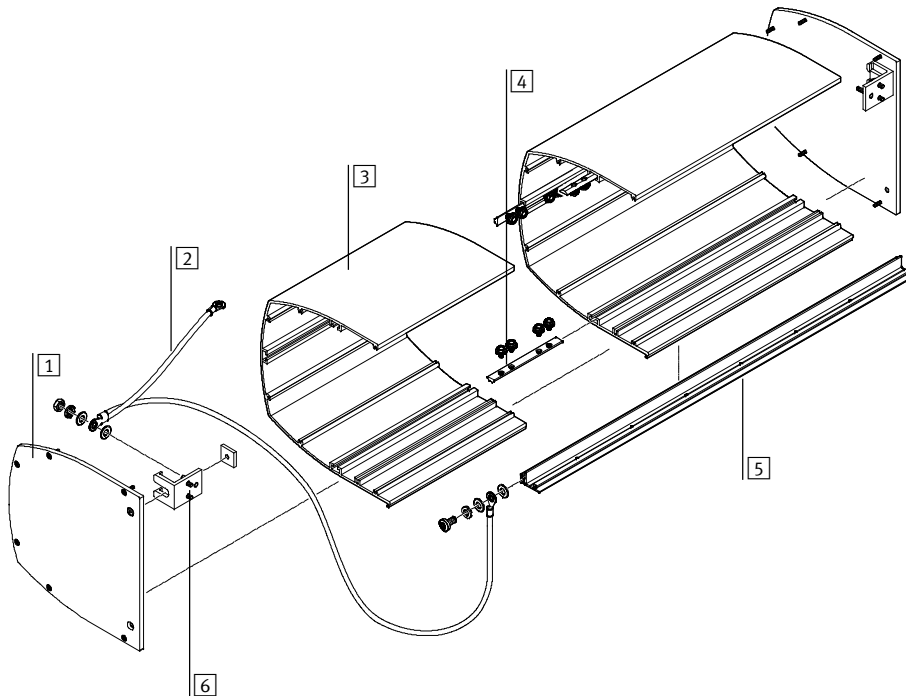

Procedure:

- Assemble the rail and mounting bracket included in the mounting kit
- Attach the earth cable
- Assemble the hood (if applicable, screw together several hood sections before attaching the side pieces)
- Attach and secure the hood

- 1 Side piece
- 2 Earth cable
- 3 Hood section
- 4 Slot nut with screws, for joining the hood sections
- 5 Rail
- 6 Mounting bracket

Technical data

Weight:

- Hood: approx. 500 g per 100 mm of length
- Mounting rail: approx. 550 g per 1000 mm of length
- Side pieces: approx. 500 g per side

- Ambient temperature $-5 \dots +50 \text{ }^{\circ}\text{C}$
- RoHS-compliant

Terminal CPX

Key features – Assembly

Extension

Functional principle

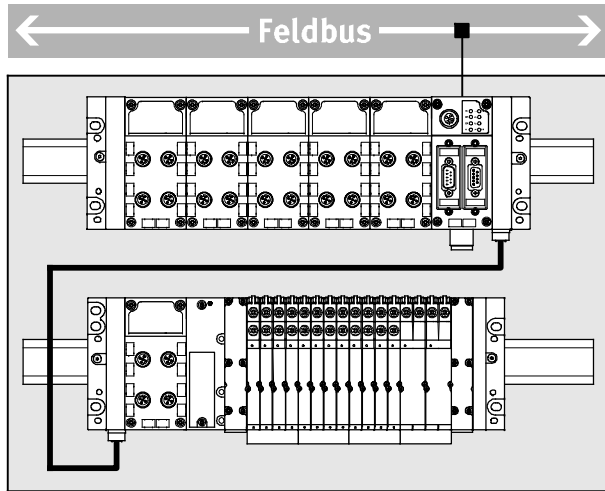

The extension enables the CPX terminal to be separated into or configured as two interconnected units (series). The two parts are controlled by a common bus node or control block. An extensive CPX terminal can fit into limited installation spaces more easily in the form of two compact units.

Applications:

- Installation in a control cabinet on two levels, one beneath the other
- Installation in two separate control cabinets, or inside and outside a control cabinet
- Installation of part of the CPX terminal inside and part outside the control cabinet
- Spatial separation of electrics and pneumatics

Performance limits

- A maximum of 10 CPX modules are permitted on the first row
 - A maximum of 8 CPX modules and a pneumatic interface are permitted in the second row
- The number of CPX modules and solenoid coils is additionally limited by:
- the address space made available by the control block/bus node
 - their address requirement
 - their current consumption

Optimisation

- The maximum possible performance or maximum number of modules can only be achieved if the following conditions are observed:
- The control block/bus node is installed in the first row, on the far right, on an interlinking block with system supply
 - The connecting cable between the first and second row is max. 2 m long
 - An interlinking block with additional power supply for valves is situated in the second row

Configuration rules

- The extension limits the power supply for the sensors and electronics for the CPX terminal as a whole as follows:
- first row max. 6 A
 - second row max. 2 A
 - first and second row together, max. 6 A
- If the 3 m connecting cable is used, the following restrictions are in place:
- There can only be one CPX module in the second row
 - An additional power supply for valves is required in order to connect a valve terminal
- Positioning output modules in the second row requires a corresponding power supply in the second row:
- Install interlinking block with additional power supply for outputs in the second row to the left of the first output module

Terminal CPX

Key features – Assembly

Extension – Permissible CPX modules			
	Type	First row	Second row
Control blocks	CPX-FEC CPX-CEC	Permissible, at least one control block or bus node required	Not permissible
Bus node	CPX-FB CPX-M-FB	Permissible, at least one control block or bus node required	Not permissible
Technology modules	CPX-CP CPX-CTEL CPX-CMXX CPX-CM-HPP CPX-CMAX CPX-CMPX CPX-CMIX	Permissible	Not permissible
Input/output modules	CPX	Permissible	Permissible
PROFIsafe shut-off module	CPX-FVDA-P CPX-FVDA-P2	Not permissible	Not permissible
Interlinking block/end plate with system supply	CPX-EPL-EV-S CPX-GE-EV-S CPX-M-GE-EV-S	Permissible, at least one interlinking block/end plate with system supply required	Not permissible
Interlinking block with additional power supply	CPX-GE-EV-Z CPX-M-GE-EV-Z CPX-GE-EV-V	Permissible	Permissible
Interlinking block without supply	CPX-GE-EV CPX-M-GE-EV	Permissible	Permissible
Pneumatics interface	VMPA-FB	Not permissible	Permissible
	VMPAL-EPL-CPX	Not permissible	Permissible
	VMPAF-FB	Not permissible	Permissible
	VABA-S6-1	Not permissible	Permissible
	CPX-GP-03-4,0	Not permissible	Not permissible
	CPX-M-GP-03-4,0	Not permissible	Not permissible
	CPX-GP-CPA	Not permissible	Not permissible

Terminal CPX

Key features – Assembly

Extension – Maximum number of CPX modules/solenoid coils		
Special features of the design	First row	Second row
CPX terminal with valve terminal		
Connecting cable 3 m	10 CPX modules	Valve terminal MPA-S with: <ul style="list-style-type: none"> • Pneumatic interface for CPX metal interlinking module • Electrical air supply plate VMPA-FB-SP directly after the pneumatic interface • Electronics modules with galvanic isolation • 128 solenoid coils (64 valve positions)
		Valve terminal VTSA/VTSA-F with: <ul style="list-style-type: none"> • 1 CPX module with interlinking block with additional power supply for valves • 32 solenoid coils (32 valve positions)
CPX terminal without valve terminal		
• Control block/bus node not in position on the far right of the first row	10 CPX modules	• 2 ... 5 CPX modules, depending on the control block/bus node used
• Control block/bus node in position on the far right of the first row	10 CPX modules	• 4 ... 8 CPX modules, depending on the control block/bus node used
CPX terminal with valve terminal MPA-S		
–	10 CPX modules	• 2 ... 5 CPX modules and manifold blocks MPA-S, depending on the control block/bus node used
<ul style="list-style-type: none"> • Electrical air supply plates VMPA-FB-SP • Electronics modules with galvanic isolation 	10 CPX modules	<ul style="list-style-type: none"> • 2 ... 5 CPX modules, depending on the control block/bus node used • Up to 128 solenoid coils (64 valve positions)
<ul style="list-style-type: none"> • Control block/bus node in position on the far right of the first row • CPX-FB11 or CPX-CEC not possible 	10 CPX modules	• 4 ... 5 CPX modules and manifold blocks MPA-S, depending on the control block/bus node used
<ul style="list-style-type: none"> • CPX-FB13 or CPX-FB36 • Control block/bus node in position on the far right of the first row • Interlinking block with system supply in position on the far right of the first row 	10 CPX modules	• 8 CPX modules and manifold blocks MPA-S
<ul style="list-style-type: none"> • CPX-FB13 or CPX-FB36 • Control block/bus node in position on the far right of the first row • Interlinking block with additional power supply for valves in position on the far right of the first row 	10 CPX modules	• 8 CPX modules and manifold blocks MPA-S
<ul style="list-style-type: none"> • CPX-FB13 or CPX-FB36 • Control block/bus node in position on the far right of the first row • Interlinking block with additional power supply for valves in second row 	10 CPX modules	• 8 CPX modules and manifold blocks MPA-S

Terminal CPX

Key features – Assembly

Extension – Maximum number of CPX modules/solenoid coils		
Special features of the design	First row	Second row
CPX terminal with valve terminal MPA-F		
–	10 CPX modules	<ul style="list-style-type: none"> • 2 CPX modules • 8 manifold blocks MPA-F
<ul style="list-style-type: none"> • Interlinking block with additional power supply for valves in second row • Electronics modules with galvanic isolation 	10 CPX modules	<ul style="list-style-type: none"> • 2 CPX modules • 128 solenoid coils (64 valve positions)
<ul style="list-style-type: none"> • Electrical air supply plates VMPAF-FB-SP • Electronics modules with galvanic isolation 	10 CPX modules	<ul style="list-style-type: none"> • 2 CPX modules • 128 solenoid coils (64 valve positions)
CPX terminal with valve terminal MPA-L		
–	10 CPX modules	<ul style="list-style-type: none"> • 2 CPX modules (at least one CPX module required) • 16 solenoid coils (valve widths 10 mm and 14 mm) or 8 solenoid coils (valve width 20 mm)
<ul style="list-style-type: none"> • Interlinking block with additional power supply for valves in second row 	10 CPX modules	<ul style="list-style-type: none"> • 2 CPX modules (at least one CPX module required) • 32 solenoid coils (32 valve positions)
CPX terminal with valve terminal VTSA/VTSA-F		
–	10 CPX modules	<ul style="list-style-type: none"> • 2 CPX modules • 12 solenoid coils (valve widths 18 mm and 26 mm and 42 mm) or 6 solenoid coils (valve widths 52 mm and 65 mm)
<ul style="list-style-type: none"> • Interlinking block with additional power supply for valves in second row 	10 CPX modules	<ul style="list-style-type: none"> • 2 CPX modules • 32 solenoid coils (32 valve positions)

Terminal CPX

Key features – Assembly

FESTO

Mounting options

Valve terminals with CPX terminal support different mounting options for direct machine mounting a high

degree of high protection and control cabinet installation.

H-rail mounting

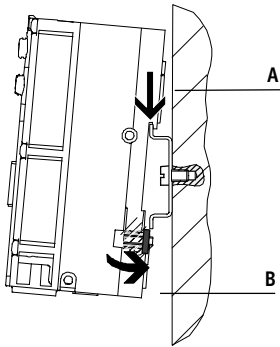

The H-rail mounting is part of the reverse profile of the CPX interlinking blocks. The CPX terminal can be attached to the H-rail using the H-rail mounting kit.

The CPX terminal is mounted on the H-rail for this purpose (see arrow A).

It is then swivelled onto the H-rail and secured in place with the clamping component (see arrow B).

The optional earthing plate enables a connection to be established to the machine potential/earth in one easy step.

For H-rail mounting you will need the following mounting kit:

- CPX-CPA-BG-NRH

This facilitates mounting of the CPX terminal on H-rails to EN 60715.

An additional mounting kit is required for combination with valve terminals.

Wall mounting, plastic design

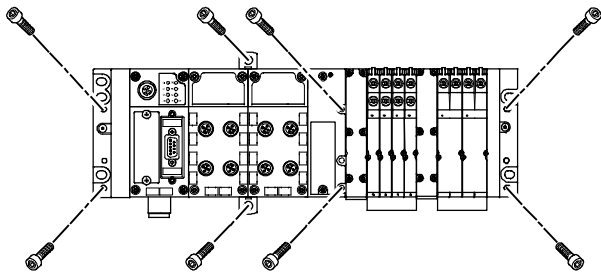

The end plates of the CPX terminal, the valve terminal and the pneumatic interface include mounting holes for wall mounting. Additional mountings for the CPX terminal are available for longer valve terminals. These mountings differ depending on the design of the CPX terminal (plastic or metal).

Wall mounting, metal design

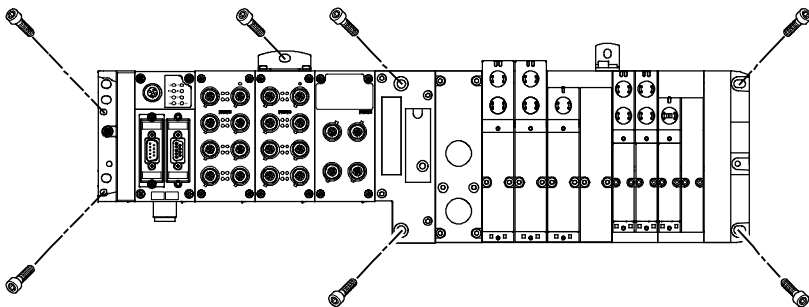

Terminal CPX

Key features – Assembly

Plastic design CPX terminal

Additional mountings

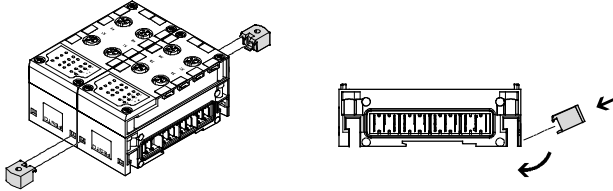

For longer valve terminals, there are additional mounting components for the CPX terminal that can be fitted between two modules.



Note

In the case of CPX terminals with 4 and more interlinking blocks, additional mountings of the type CPX-BG-RW must be used every 100 or 150 mm. These are supplied pre-assembled.

Interlinking with tie rods

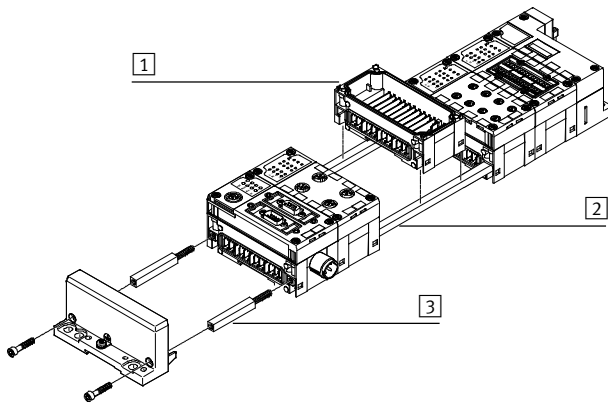

The CPX modules are mechanically connected using special tie rods **2**. Two screws in the end plates are all that are needed to assemble the entire unit.

The tie rod ensures that the unit resists high mechanical loads and is therefore the mechanical backbone of the CPX terminal.

The open design enables interlinking blocks **1** to be replaced in the assembled state.

The tie rod expansion kit **3** enables an extra module to be added to the CPX terminal.

CPX terminal in metal design

Additional mountings

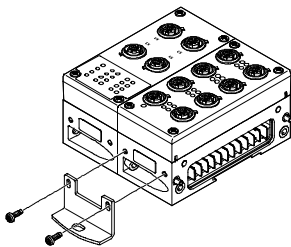

For longer valve terminals, there are additional mounting brackets for the CPX terminal that can be screwed onto the interlinking blocks.

The mounting bracket CPX-M-BG-VT-2X enables a CPX terminal with valve terminal VTSA/VTSA-F to be mounted on a support system.



Note

In the case of CPX terminals with 4 and more interlinking blocks, additional mounting brackets of the type CPX-M-BG-RW must be used every 100 or 150 mm. These are supplied pre-assembled.

Linking with screws

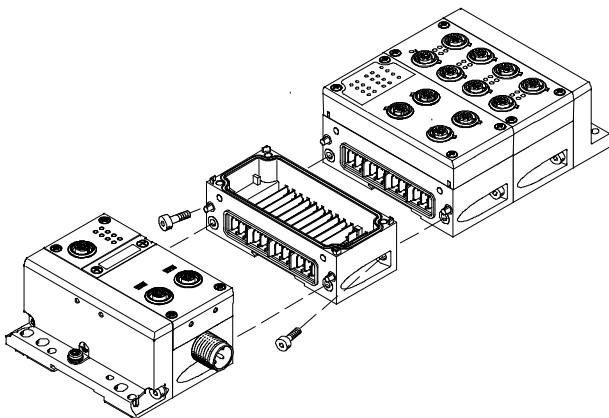

The CPX modules are mechanically connected using a special angled fitting.

The CPX terminal can thus be expanded at any time.

Terminal CPX

Key features – Power supply

Power supply concept

General

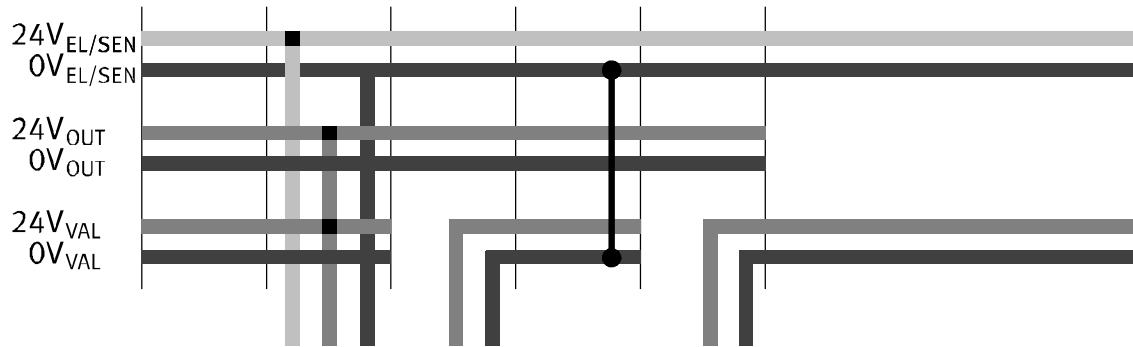
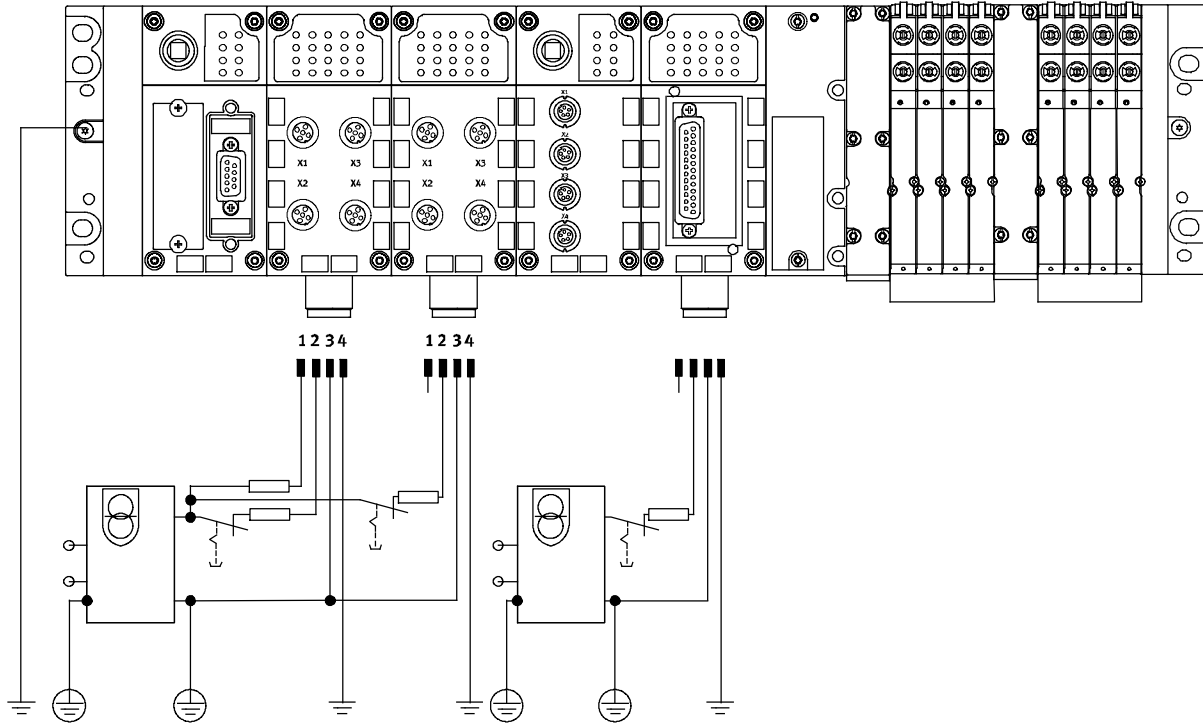

The use of decentralised devices on the fieldbus – particularly with a high degree protection for direct machine mounting – demands a flexible power

supply concept. A valve terminal with CPX can, in principle, supply all voltages via a single socket. A distinction is made between the

supply for

- Electronics plus sensors
- Valves plus actuators

in this case.

Selectable connection technology:

- M18
- 7/8"
- AIDA push-pull

Interlinking blocks

Interlinking blocks represent the backbone of the CPX terminal with all supply lines. They provide the power supply for the modules used on them

as well as their bus connections. Many applications require the CPX terminal to be segmented into voltage zones. This applies in particular to the

separate disconnection of solenoid coils and outputs. The interlinking blocks provide either a space-saving central power supply

for the entire CPX terminal or galvanically isolated, all-pin disconnectable potential groups/voltage segments.

Terminal CPX

Key features – Power supply

Interlinking blocks

With system supply

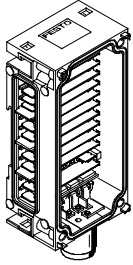

Type for plastic design

- CPX-GE-EV-S
- CPX-GE-EV-S-7/8-4POL
- CPX-GE-EV-S-7/8-5POL

Connection technology

- M18 4-pin
- 7/8" 4-pin
- 7/8" 5-pin

Power supply

- For CPX terminal modules and connected sensors
- For valves that are connected to the CPX terminal via a pneumatic interface
- For actuators that are connected to the output modules of the CPX terminal

Type for metal design

- CPX-M-GE-EV-S-7/8-CIP-4P
- CPX-M-GE-EV-S-7/8-5POL
- CPX-M-GE-EV-S-PP-5POL

Connection technology

- 7/8" 4-pin
- 7/8" 5-pin
- AIDA push-pull, 5-pin

Without power supply

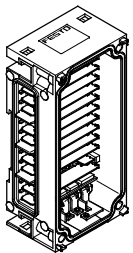

Type for plastic design

- CPX-GE-EV

–

–

Type for metal design

- CPX-M-GE-EV
- CPX-M-GE-EV-FVO

–

With additional power supply for outputs

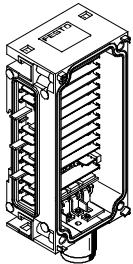

Type for plastic design

- CPX-GE-EV-Z
- CPX-GE-EV-Z-7/8-4POL
- CPX-GE-EV-Z-7/8-5POL

Connection technology

- M18 4-pin
- 7/8" 4-pin
- 7/8" 5-pin

Power supply

- For actuators that are connected to the output modules of the CPX terminal

Type for metal design

- CPX-M-GE-EV-Z-7/8-5POL
- CPX-M-GE-EV-Z-PP-5POL

Connection technology

- 7/8" 5-pin
- AIDA push-pull, 5-pin

With additional power supply for valves

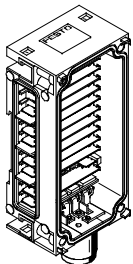

Type for plastic design

- CPX-GE-EV-V
- CPX-GE-EV-V-7/8-4POL

Connection technology

- M18 4-pin
- 7/8" 4-pin

Power supply

- For valves that are connected to the CPX terminal via a pneumatic interface

-  - Note

For 7/8":
– Commercially available accessories are often limited to max. 8 A

-  - Note

Valve terminal MPA-S has either a 7/8" 5-pin, 7/8" 4-pin, 3-pin M18 or 5-pin AIDA push-pull power supply for one or more valve voltage zones. Galvanically isolated, all pins disconnectable with voltage monitoring in the following MPA module.

-  - Note

Suitable versions of the interlinking blocks with M18 and 7/8", 5-pin connection are available (CPX-GE-EV-...-VL and CPX-M-GE-EV-...-VL) for use in ATEX environments as per certification (→ 46). The maximum current supply for these interlinking blocks is 8 A.

Terminal CPX

Key features – Diagnostics

Diagnostics

System performance

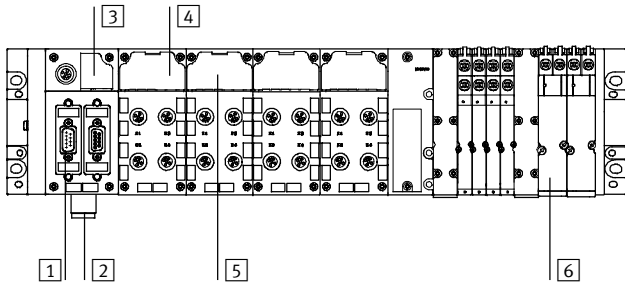

- 1 Diagnostics via bus interface
- 2 Undervoltage monitoring
- 3 Diagnostic overview LED
 - Fieldbus status
 - CPX status
- 4 Status and diagnostic LED for module and I/O channels
- 5 Module and channel-specific diagnostics
- 6 Valve-specific diagnostics for module and solenoid coils

Detailed diagnostic functions are needed in order to quickly locate the causes of errors in the electrical installation and therefore reduce downtimes in production plants. A basic distinction is made between on-the-spot diagnostics using LEDs or an operator unit and diagnostics using a bus interface.

The CPX terminal supports on-the-spot diagnostics via a row of LEDs. This is separate from the connection area and therefore provides good visual access to status and diagnostic information.

Module and channel-specific diagnosis is supported, for example

- Undervoltage detection for outputs and valves
- Short circuit detection for sensors, outputs and valves
- Open-load detection for a missing solenoid coil
- Storage of the last 40 causes of errors with error start and error end

The diagnostic messages can be read out via the bus interface in the higher-order controller and visualised for the central recording and evaluation of error causes. This is done using the individual fieldbus-specific channels. The CPX-FEC and CPX-CEC also offer the option of access via the integrated Ethernet interface (remote maintenance via PC/web applications).

Overview of LEDs on the bus node

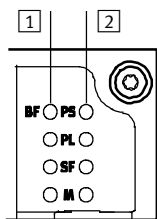

- 1 Fieldbus-specific LEDs

On each bus node, a maximum of 4 fieldbus-specific LEDs display the fieldbus communication status of the CPX terminal with the higher-order controller.
- 2 CPX-specific LEDs

A further 4 CPX-specific LEDs provide non-fieldbus-specific information about the status of the CPX terminal, for example

 - Power system
 - Power load
 - System fault
 - Modification parameters

Input/output module status and diagnostic LEDs

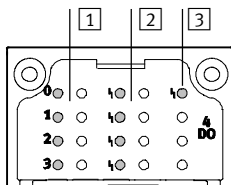

- 1 Status LEDs for the inputs and outputs

Each input and output channel is assigned a status LED.
- 2 Channel-oriented diagnostic LEDs

Depending on the module design, another diagnostic LED is available for each I/O channel
- 3 Group diagnostic LEDs

An LED displays the group diagnostics for each module

Terminal CPX

Key features – Parameterisation

Diagnostics

Display on the operator unit

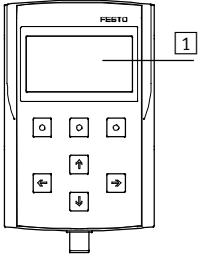

- 1 LCD graphical display for on-site plain-text diagnostics
 - Fault location and type
 - Without programming

Display on a PC

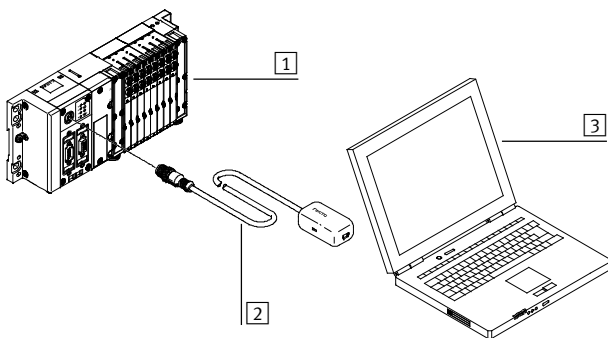

- 1 CPX terminal with valve terminal
 - Fault location and type
- 2 Adapter diagnostic interface to USB
 - Without programming
 - Storing the configuration
- 3 Laptop/portable device with USB interface and installed FMT software
 - Preparing screenshots

Parameterisation

Changes to the application are often required during commissioning. The parameterisable characteristics of the CPX modules mean that functions can be very easily changed by means of configuration software. This reduces

the number of modules needed and, consequently, the amount of storage space required.

It is therefore possible, for example, to reduce the switch-on debounce time for an input module – normally 3 ms –

to 0.1 ms on a "fast" input module for faster processes, or to set the response of a valve following a fieldbus interrupt.

Depending on the modules used, parameterisation can be performed

via the following interfaces:

- Ethernet
- Fieldbus
- Control block direct interface (programming interface)
- Operator unit CPX-MMI

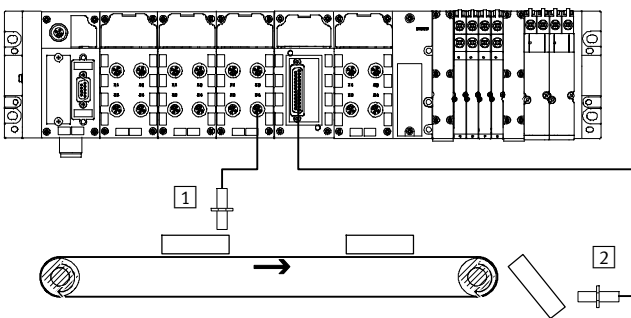

- 1 Input debounce time 3 ms
- 2 Input debounce time 0.1 ms

Terminal CPX

Key features – Addressing

Addressing

The various CPX modules occupy a different number of I/O addresses within the CPX system. The maximum address space for bus nodes depends on the performance of the fieldbus systems.

Maximum system configuration:

- 1 bus node or control block
- 9 I/O modules
- 1 pneumatic interface (e.g. pneumatic interface MPA-S with up to 16 MPA manifold blocks)

The maximum system configuration can be limited in individual cases by exceeding the address space.



Please refer to the detailed description of the configuration/addressing rules in the technical data for CPX bus nodes.

Overview – Address space for CPX bus node and control block

	Protocol	Max. total		Max. digital		Max. analogue	
		Inputs	Outputs	Inputs	Outputs	Inputs	Outputs
CPX-FEC	<ul style="list-style-type: none"> • TCP/IP • Easy IP • Modbus TCP • HTTP 	512 bits	512 bits	512 DI	512 DO	32 AI	18 AO
CPX-CEC	<ul style="list-style-type: none"> • CoDeSys level 2 • TCP/IP • Easy IP • Modbus TCP 	512 bits	512 bits	512 DI	512 DO	32 AI	18 AO
CPX-FB6	INTERBUS	96 bits	96 bits	96 DI	96 DO	6 AI	6 AO
CPX-FB11	DeviceNet	512 bits	512 bits	512 DI	512 DO	32 AI	18 AO
CPX-FB13	PROFIBUS	512 bits	512 bits	512 DI	512 DO	32 AI	18 AO
CPX-FB14	CANOpen	256 bits	256 bits	64 DI (+ 64 DI)	64 DO (+ 64 DO)	8 AI (+ 8 AI)	8 AO (+ 8 AO)
CPX-M-FB20	INTERBUS (LWL)	96 bits	96 bits	96 DI	96 DO	6 AI	6 AO
CPX-M-FB21	INTERBUS (LWL)	96 bits	96 bits	96 DI	96 DO	6 AI	6 AO
CPX-FB23-24	CC-Link	512 bits	512 bits	512 DI	512 DO	32 AI	18 AO
CPX-FB32	EtherNet/IP	512 bits	512 bits	512 DI	512 DO	32 AI	18 AO
CPX-FB33	PROFINET RT	512 bits	512 bits	512 DI	512 DO	32 AI	18 AO
CPX-M-FB34	PROFINET RT	512 bits	512 bits	512 DI	512 DO	32 AI	18 AO
CPX-M-FB35	PROFINET RT	512 bits	512 bits	512 DI	512 DO	32 AI	18 AO
CPX-FB36	EtherNet/IP	512 bits	512 bits	512 DI	512 DO	32 AI	18 AO
CPX-FB38	EtherCAT	512 bits	512 bits	512 DI	512 DO	32 AI	18 AO



The bandwidth of the bus nodes can be restricted by the choice of module and the maximum number of modules.

Example CPX-FB6 (INTERBUS)

	Digital inputs	Digital outputs	Notes
3x CPX-8DE	24	–	<ul style="list-style-type: none"> • The address space is occupied by 7 CPX I/O modules plus pneumatic interface • No additional modules can be configured
1x CPX-8DE-8DA	8	8	
2x CPX-2AE	64	–	
1x CPX-2AA	–	32	
3x VMPA1	–	24	
Allocated address space	96	96	

DI = Digital inputs (1 bit)

DO = Digital outputs (1 bit)

AO = Analogue outputs (16 bits)

AI = Analogue inputs (16 bits)

Terminal CPX

Key features – Addressing

Overview – Allocated addresses for CPX modules		
	Inputs [bit]	Outputs [bit]
CPX-CP-4-FB	16, 32, 48, 64, 80, 96, 128 ¹⁾	16, 32, 48, 64, 80, 96, 128 ¹⁾
CPX-CTEL-4-M12-5POL	0, 64, 128, 192, 256 ¹⁾	0, 64, 128, 192, 256 ¹⁾
CPX-CMXX	2 x 64	2 x 64
CPX-CM-HPP	256	256
CPX-CMAX-C1-1	64	64
CPX-CMPX-C-1-H1	48	48
CPX-CMIX-M1-1	48	48
CPX-4DE	4	–
CPX-8DE	8	–
CPX-8DE-D	8	–
CPX-8NDE	8	–
CPX-16DE	16	–
CPX-M-16DE-D	16	–
CPX-L-16DE-16-KL-3POL	16	–
CPX-4DA	–	4
CPX-8DA	–	8
CPX-8DA-H	–	8
CPX-8DE-8DA	8	8
CPX-L-8DE-8DA-16-KL-3POL	8	8
CPX-2ZE2DA	96	96
CPX-2AE-U-I	2 x 16	–
CPX-4AE-U-I	4 x 16	–
CPX-4AE-I	4 x 16	–
CPX-4AE-P-B2	4 x 16	–
CPX-4AE-P-D10	4 x 16	–
CPX-4AE-T	4 x 16	–
CPX-4AE-TC	4 x 16	–
CPX-2AA-U-I	–	2 x 16
CPX-FVDA-P	48	48
CPX-FVDA-P2	48	48
VMPA1-FB-EMS-8	–	8
VMPA1-FB-EMG-8	–	8
VMPA2-FB-EMS-4	–	4
VMPA2-FB-EMG-4	–	4
VMPA1-FB-EMS-D2-8	–	8
VMPA1-FB-EMG-D2-8	–	8
VMPA2-FB-EMS-D2-4	–	4
VMPA2-FB-EMG-D2-4	–	4
VMPA-FB-PS-1	16	–
VMPA-FB-PS-3/5	16	–
VMPA-FB-PS-P1	16	–
VMPA-FB-EMG-P1	16	16
VMPAL-EPL-CPX	–	4, 8, 16, 24, 32 ¹⁾
VMPAF-FB-EPL-PS	16	–
VMPAF-FB-EPLM-PS	16	–
VABA-S6-1-X1	–	8, 16, 24, 32 ¹⁾
VABA-S6-1-X2	–	8, 16, 24, 32 ¹⁾
VABA-S6-1-X2-D	8, 16, 24, 32 ¹⁾	8, 16, 24, 32 ¹⁾
CPX-GP-03-4,0	–	8, 16, 24, 32 ¹⁾
CPX-M-GP-03-4,0	–	8, 16, 24, 32 ¹⁾
CPX-GP-CPA-10	–	8, 16, 24 ¹⁾
CPX-GP-CPA-14	–	8, 16, 24 ¹⁾

1) Dependent on the DIL switch setting on the module

Terminal CPX

Technical data

FESTO

-  - Module width
50 mm



-  - Note
The data given here apply to the CPX system. If components that conform to lower values are used in the system, the specification for the entire system is reduced to the values of those components used.

Example
Protection class IP65/IP67 applies only to the fully assembled system with fitted plugs or covers (which must also conform to IP65/67). If components with a lower protection class are used, the protection level of the entire system is reduced to the protection class of the component with the lowest protection level, for example CageClamp connection block with IP20 protection or MPA pneumatics with IP65 protection.

General technical data			
Module No.		197330	
Max. no. of modules ¹⁾	Control block	1	
	Bus node	1	
	I/O modules/CP interface/CTEL interface/ multi-axis interface	9	
	Pneumatic interface	1	
Max. address capacity	Inputs	[byte]	64
	Outputs	[byte]	64
Internal cycle time		[ms]	< 1
Configuration support	Fieldbus-specific		
LED displays	Bus node/control block	Up to 4 LEDs, bus-specific 4 LEDs, CPX-specific • PS = Power system • PL = Power load • SF = System fault • M = Modify parameter/forcing active	
	I/O modules	Min. one group diagnostic LED Channel-oriented status and diagnostic LED, depending on module	
	Pneumatic interface	One group diagnostic LED Valve status LED on valve	
Diagnostics	<ul style="list-style-type: none"> • Channel and module-oriented diagnostics for inputs/outputs and valves • Detection of module undervoltage for the different voltage potential values • Storage of the last 40 errors with timestamp (asynchronous access) 		

1) A maximum of 11 modules in total can be combined
(e.g. 1 control block + 9 I/O modules + 1 pneumatic interface, or 1 control block + 1 bus node + 8 I/O modules + 1 pneumatic interface)

Terminal CPX

Technical data

FESTO

General technical data		
Module No.	197330	
Parameterisation	Module-specific and entire system, for example: <ul style="list-style-type: none"> • Diagnostic behaviour • Condition monitoring • Profile of inputs • Fail-safe response of outputs and valves 	
Commissioning support	Forcing of inputs and outputs	
Protection class to EN 60529	IP65/IP67	
Nominal operating voltage	[V DC]	24
Operating voltage range	[V DC]	18 ... 30
Current supply	Interlinking block with system supply for electronics plus sensors	[A] 16 (8/10 with 7/8" supply, 5-pin/4-pin)
	actuators plus valves	[A] 16 (8/10 with 7/8" supply, 5-pin/4-pin)
	Additional power supply for actuators	[A] 16 (8/10 with 7/8" supply, 5-pin/4-pin)
	Additional power supply for valves	[A] 16 (10 with 7/8" supply, 4-pin)
Current consumption	Depending on system configuration	
Power failure bridging (bus electronics only)	[ms]	10
Power supply connection	M18, 4-pin	
	7/8", 5-pin	
	7/8", 4-pin	
	AIDA push-pull, 5-pin	
Fuse concept	Per module with electronic fuses	
Tests	Vibration test to DIN IEC 68	<ul style="list-style-type: none"> • With wall mounting: Severity level 2 • With H-rail mounting: Severity level 1
	Shock test to DIN IEC 68	<ul style="list-style-type: none"> • With wall mounting: Severity level 2 • With H-rail mounting: Severity level 1
PWIS classification	PWIS-free (free of paint-wetting impairment substances)	
Interference immunity	EN 61000-6-2 (industry)	
Interference emission	EN 61000-6-4 (industry)	
Isolation test for galvanically isolated circuits to IEC 1131 Part 2	[V DC]	500
Galvanic isolation of electrical voltages	[V DC]	80
Protection against direct and indirect contact	PELV (Protective Extra-Low Voltage)	
Materials	End plates: Die-cast aluminium	
Grid dimension	[mm]	50

Operating and environmental conditions		
Module No.	197330	
Ambient temperature	[°C]	-5 ... +50
Storage temperature	[°C]	-20 ... +70

Terminal CPX

Technical data

FESTO

Certifications – Maximum permissible values	
Module No.	197330
ATEX category gas	II 3G
Ex-ignition protection type gas	Ex nA IIC T4 X Gc
ATEX ambient temperature [°C]	-5 ≤ Ta ≤ +50
CE mark (see declaration of conformity)	To EU Explosion Protection Directive (ATEX) To EU EMC Directive ¹⁾
Protection class to EN 60529	IP65, IP67
Certification	c UL us - Recognized (OL) C-Tick
Explosion protection certification outside the EU	EPL Gc (Ru)

1) For information about the applicability of the component see the manufacturer's EC declaration of conformity at: www.festo.com → Support → User documentation.
If the component is subject to restrictions on usage in residential, office or commercial environments or small businesses, further measures to reduce the emitted interference may be necessary.

 - Note

The values indicated represent the maximum performance limits that can be achieved with the fully assembled product. Depending on the individual components used, the value actually achieved for the overall product may be lower.

You can select e.g. the individual components required to achieve the ATEX category by choosing the corresponding features in the online product configurator: → Internet:cpx

Weight [g]					
Control block	FEC	140.0	Interlinking block, metal	Without power supply	162.0
	CEC	155.0		With system supply, 7/8" 4-pin	228.0
Bus node	FB6	125.0	Tie rod	With system supply, 7/8" 5-pin	187.0
	FB11	120.0		With system supply, Push-pull	245.0
	FB13	115.0		1-fold	19.0 ±2.5
	FB14	115.0		2-fold	32.5 ±2.5
	FB20	1070.0	3-fold	46.0 ±2.5	
	FB21	1255.0	4-fold	59.5 ±2.5	
	FB23-24	115.0	5-fold	73.0 ±2.5	
	FB32	125.0	6-fold	86.5 ±2.5	
	FB33	280.0	7-fold	100.0 ±2.5	
	FB34	280.0	8-fold	113.5 ±2.5	
	FB35	280.0	9-fold	127.0 ±2.5	
	FB36	125.0	10-fold	140.5 ±2.5	
	FB38	125.0	End plate for plastic version	Left-hand	77.0
	I/O module	CPX	38.0	Right-hand, with system supply	145.0
CPX-L		170.0	Right-hand	70.0	
Counter module	2ZE2DA	130.0	End plate for metal version	Left-hand	113.0
CP interface	CP	140.0	Right-hand	113.0	
CTEL interface	CTEL	110.0	End plate with extension	Left-hand	190.0
Multi-axis interface	CMXX	155.0	Right-hand	175.0	
Axis interface	CM-HPP	140.0	Pneumatic interface	MPA-S	238.4
Axis controller	CMAx	140.0		MPA-F	690.0
End-position controller	CMPX	140.0		VTSA/VTSA-F	485.0
Measuring module	CMIX	140.0		MIDI/MAXI	390.0
Connection block	Plastic	70.0	CPA	150.0	
	Metal	175.0			
Interlinking block, plastic	Without power supply	100.0			
	With system supply	125.0			

Terminal CPX

Accessories

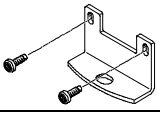
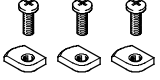
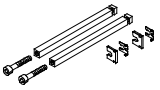
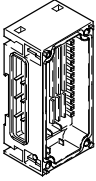
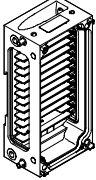

FESTO

Ordering data – Accessories			
Designation		Part No.	Type
Mounting			
	Attachment for wall mounting (for long valve terminals, 10 pieces), design for plastic manifold sub-bases	529040	CPX-BG-RW-10x
	Attachment for wall mounting, design for metal manifold sub-bases	2 mounting brackets and 4 screws	550217 CPX-M-BG-RW-2X
		1 mounting bracket and 2 screws	2721419 CPX-M-BG-VT-2X
	Mounting for H-rail	CPX without pneumatic components	526032 CPX-CPA-BG-NRH
		CPX-VTSA	
		CPX-VTSA-F	
		CPX-MPA	
		CPX-CPA	
		CPX-MIDI	526033 CPX-03-4,0
	CPX-MAXI	526034 CPX-03-7,0	
Tie rod			
	Tie rod CPX	Extension 1-fold	525418 CPX-ZA-1-E
		1-fold	195718 CPX-ZA-1
		2-fold	195720 CPX-ZA-2
		3-fold	195722 CPX-ZA-3
		4-fold	195724 CPX-ZA-4
		5-fold	195726 CPX-ZA-5
		6-fold	195728 CPX-ZA-6
		7-fold	195730 CPX-ZA-7
		8-fold	195732 CPX-ZA-8
		9-fold	195734 CPX-ZA-9
		10-fold	195736 CPX-ZA-10
Plastic interlinking block			
	Without power supply	–	195742 CPX-GE-EV
	With system supply	M18	195746 CPX-GE-EV-S
		M18, for ATEX environment	8022170 CPX-GE-EV-S-VL
		7/8" – 5-pin	541244 CPX-GE-EV-S-7/8-5POL
		7/8" – 5-pin, for ATEX environment	8022172 CPX-GE-EV-S-7/8-5POL-VL
		7/8" – 4-pin	541248 CPX-GE-EV-S-7/8-4POL
	With additional power supply for outputs	M18	195744 CPX-GE-EV-Z
		M18, for ATEX environment	8022166 CPX-GE-EV-Z-VL
		7/8" – 5-pin	541248 CPX-GE-EV-Z-7/8-5POL
		7/8" – 5-pin, for ATEX environment	8022173 CPX-GE-EV-Z-7/8-5POL-VL
		7/8" – 4-pin	541250 CPX-GE-EV-Z-7/8-4POL
	With additional power supply for valves	M18	533577 CPX-GE-EV-V
		M18, for ATEX environment	8022171 CPX-GE-EV-V-VL
7/8" – 4-pin		541252 CPX-GE-EV-V-7/8-4POL	
Metal interlinking block			
	Without power supply	–	550206 CPX-M-GE-EV
	With system supply	7/8" – 5-pin	550208 CPX-M-GE-EV-S-7/8-5POL
		7/8" – 5-pin, for ATEX environment	8022165 CPX-M-GE-EV-S-7/8-5POL-VL
		7/8" – 4-pin	568956 CPX-M-GE-EV-S-7/8-CIP-4P
		Push-pull – 5-pin	563057 CPX-M-GE-EV-S-PP-5POL
		7/8" – 5-pin	550210 CPX-M-GE-EV-Z-7/8-5POL
	With additional power supply for outputs	7/8" – 5-pin, for ATEX environment	8022158 CPX-M-GE-EV-Z-7/8-5POL-VL
		Push-pull – 5-pin	563058 CPX-M-GE-EV-Z-PP-5POL

Terminal CPX

Accessories

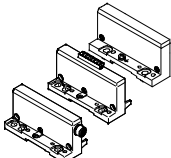
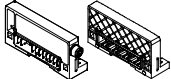
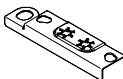
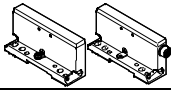
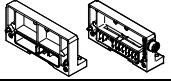
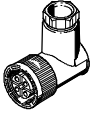
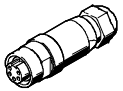
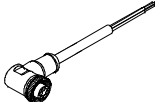
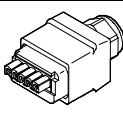

FESTO

Ordering data – Accessories				
Designation			Part No.	Type
Mounting accessories				
	Screws for mounting the bus node/connection block on a plastic interlinking block	Bus node/metal connection block	550218	CPX-DPT-30X32-S-4X
	Screws for mounting the bus node/connection block on a metal interlinking block	Bus node/plastic connection block	550219	CPX-M-M3x22-4x
		Bus node/metal connection block	550216	CPX-M-M3x22-S-4x
End plates for plastic version				
	End plate, left-hand	–	195716	CPX-EPL-EV
		With system supply	576315	CPX-EPL-EV-S
		With extension	576314	CPX-EPL-EV-X
	End plate, right-hand	–	195714	CPX-EPR-EV
		With extension	576313	CPX-EPR-EV-X
	Earthing element for right-hand/left-hand end plate	5 pieces	538892	CPX-EPFE-EV
End plates for metal version				
	End plate, left-hand	–	550212	CPX-M-EPL-EV
		With extension	576317	CPX-M-EPL-EV-X
	End plate, right-hand	–	550214	CPX-M-EPR-EV
		With extension	576316	CPX-M-EPR-EV-X
Power supply				
	Plug socket for mains connection M18x1, straight, 4-pin	For 1.5 mm ²	18493	NTSD-GD-9
		For 2.5 mm ²	18526	NTSD-GD-13,5
	Plug socket for mains connection M18x1, angled, 4-pin	For 1.5 mm ²	18527	NTSD-WD-9
		For 2.5 mm ²	533119	NTSD-WD-11
	Plug socket for mains connection 7/8", straight, 5-pin	0.25 ... 2.0 mm ²	543107	NECU-G78G5-C2
		0.25 ... 2.0 mm ²	543108	NECU-G78G4-C2
	Plug socket for mains connection 7/8", angled, 5-pin – open cable end, 5-pin	2 m	573855	NEBU-G78W5-K-2-N-LE5
	Connection socket AIDA push-pull, spring-loaded terminal	5-pin	563059	NECU-M-PPG5-C1
	Straight plug, spring-loaded terminal, for end plate left-hand with system supply	7-pin	576319	NECU-L3G7-C1

Terminal CPX

Accessories

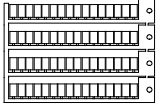
FESTO

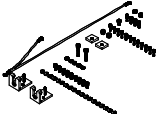
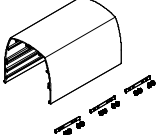
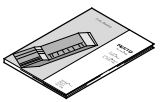
Ordering data – Accessories				
Designation		Part No.	Type	
Inscription labels				
	Inscription labels 6x10, 64 pieces, in frames	18576	IBS-6x10	
Hood				
	Mounting rail for securing the cover	1,000 mm	572256	CAFC-X1-S
	Mounting kit for CPX cover		572257	CAFC-X1-BE
	Hood section for CPX terminal including mounting attachments for connecting several hood sections in series	200 mm	572258	CAFC-X1-GAL-200
		300 mm	572259	CAFC-X1-GAL-300
Manual				
	CPX System Manual	German	526445	P.BE-CPX-SYS-DE
		English	526446	P.BE-CPX-SYS-EN
		Spanish	526447	P.BE-CPX-SYS-ES
		French	526448	P.BE-CPX-SYS-FR
		Italian	526449	P.BE-CPX-SYS-IT
		Swedish	526450	P.BE-CPX-SYS-SV
	Operator unit CPX-MMI-1	German	534824	P.BE-CPX-MMI-1-DE
		English	534825	P.BE-CPX-MMI-1-EN
		French	534827	P.BE-CPX-MMI-1-FR
		Italian	534828	P.BE-CPX-MMI-1-IT
		Swedish	534829	P.BE-CPX-MMI-1-SV
		Spanish	534826	P.BE-CPX-MMI-1-ES

Terminal CPX

Accessories

User manuals – General information

Comprehensive user manuals are vital for the fast and reliable use of fieldbus components. The manuals provided by Festo contain step-by-step instructions for using CPX terminals:

1. Installation
2. Commissioning and parameterisation
3. Diagnostics

Application-oriented explanations are provided for integration of the CPX terminal in the programming and configuration software of the various controller manufacturers.

Use the order code to select the language you want. The manual for the configuration you have ordered is supplied automatically.

The documents can be quickly and easily downloaded from the Festo website.

➔ www.festo.com



Overview – User manuals		
Type	Title	Description
Pneumatic components		
P.BE-VTSA-44-...	Valve terminals with VTSA and VTSA-F pneumatics	Instructions on assembly, installation, commissioning and diagnostics of the VTSA and VTSA-F pneumatic components.
P.BE-CPA-...	Valve terminals with CPA pneumatics	Instructions on assembly, installation, commissioning and diagnostics of the CPA pneumatic components.
P.BE-Midi/Maxi-03-...	Valve terminals with MIDI/MAXI pneumatics	Instructions on assembly, installation, commissioning and diagnostics of the MIDI/MAXI pneumatic components.
P.BE-MPA-...	Valve terminals with MPA-S pneumatics	Instructions on assembly, installation, commissioning and diagnostics of the MPA-S pneumatic components.
P.BE-MPAF-...	Valve terminals with MPA-F pneumatics	Instructions on assembly, installation, commissioning and diagnostics of the MPA-F pneumatic components.
P.BE-MPAL-...	Valve terminals	Instructions on assembly, installation, commissioning and diagnostics of the MPA-L pneumatic components.

Terminal CPX

Accessories

FESTO

Overview – User manuals		
Type	Title	Description
Electronic components		
P.BE-CPX-SYS-...	System description, installation and commissioning	Overview of the design, components and mode of operation of the CPX terminal; installation and commissioning instructions as well as basic principles of parameterisation
P.BE-CPX-FVDA-P-...	PROFIsafe shut-off module	Connection technology and instructions on mounting, installing and commissioning for the PROFIsafe shut-off module of the type CPX-FVDA-P
P.BE-CPX-FVDA-P2-...	PROFIsafe shut-off module	Connection technology and instructions on mounting, installing and commissioning for the PROFIsafe shut-off module of the type CPX-FVDA-P2
P.BE-CPX-EA-...	CPX-EA modules, digital	Connection technology and assembly, installation and commissioning instructions for digital input and output modules of the type CPX-... as well as CPA, MIDI/MAXI, VTSA/VTSA-F and MPA-S/F/L pneumatic interface
P.BE-CPX-2ZE2DA-...	EA module CPX-2ZE2DA	Connection technology and instructions on mounting, installing and commissioning for the counter module of the type CPX-2ZE2DA
P.BE-CPX-AX-...	CPX-EA modules, analogue	Connection technology and assembly, installation and commissioning instructions for analogue input and output modules of the type CPX-...
P.BE-CPX-CP-...	CPX CP interface	Instructions on assembly, installation, commissioning and diagnostics of the CP interface
P.BE-CPX-CTEL-...	CPX CTEL interface	Instructions on assembly, installation, commissioning and diagnostics of the CPX CTEL master
P.BE-CPX-CMXX-...	CPX multi-axis interface	Instructions on assembly, installation, commissioning and diagnostics of the CPX multi-axis interface (CMXX)
P.BE-CPX-CM-HPP-...	CPX axis interface	Instructions on assembly, installation, commissioning and diagnostics of the CPX axis interface (CM-HPP)
P.BE-CPX-CMAX-SYS-...	CPX axis controller	Instructions on assembly, installation, commissioning and diagnostics of the CPX axis controller (CMAX)
P.BE-CPX-CMAX-CONTROL-...	CPX axis controller	Information on controlling, diagnosing and parameterising the axis controller via the fieldbus
P.BE-CPX-CMPX-SYS-...	CPX end-position controller	Instructions on assembly, installation, commissioning and diagnostics of the CPX end-position controller (CMPX)
P.BE-CPX-CMIX-...	CPX measuring module	Instructions on assembly, installation, commissioning and diagnostics of the CPX measuring module (CMIX)
P.BE-CPX-FB-...	CPX bus node	Instructions on assembly, installation, commissioning and diagnostics of the relevant bus nodes
P.BE-CPX-PNIO-...	CPX bus node for PROFINET	Instructions on assembly, installation, commissioning and diagnostics of the relevant bus nodes
P.BE-CPX-FEC-...	CPX control block	Instructions on assembly, installation, commissioning and diagnostics of the relevant control block
P.BE-CPX-CEC-...	CPX CoDeSys controller (control block)	Instructions on assembly, installation, commissioning and diagnostics of the relevant control block
P.BE-CPX-MMI-1-...	Universal handheld type CPX-MMI-1	Instructions on assembly, installation, commissioning and diagnostics of the CPX operator unit

User manuals – GSD, EDS, etc.

Device description files and icons are used to explain the integration of the CPX terminal in the configuration software of the various controller manufacturers.

These can be downloaded quickly and easily from www.festo.com.

Terminal CPX

Technical data – Operator unit CPX-MMI-1

FESTO

-  - Width
81 mm

The operator unit is a small, convenient commissioning and service device for the CPX terminal. It provides data polling, configuration and diagnostic functions for CPX terminals. Its extremely flexible application range means that data can be read in or out at any location. IP65 compatibility makes it suitable for use in harsh industrial environments.



Application

Functions

- Advance commissioning through the monitoring/forcing of inputs and outputs without fieldbus master/PLC
- Test function for parameter settings, for example fail-safe of the outputs or switch-on delay of the inputs
- Plain-text diagnostics of module and channel-oriented errors
- Condition monitoring: preselection/loading of counters, activation of the channels to be monitored
- Display of the last 40 error occurrences with timestamp
- Identification of sporadic causes of errors through display of the diagnostic history
- Password protection

Connection

The operator unit is connected to the CPX bus nodes or control block, as appropriate, using a pre-assembled M12 cable.

The voltage for the operator unit is supplied by the CPX component

Communication

Once connected to the CPX terminal, the operator unit loads the available configuration for the I/O modules, valves, etc.

This ensures the availability of up-to-date texts, messages, menus and displays. Status information, diagnostic messages and parameter bits are then exchanged during operation.

Assembly

A mounting bracket for the operator unit offers the option of wall or H-rail mounting.

The mounting bracket also has an option for temporary mounting using a hanging device.

Terminal CPX

Technical data – Operator unit CPX-MMI-1

Connection

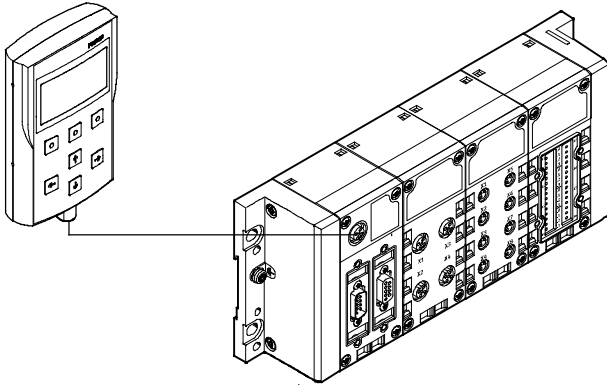

The operator unit is connected to the CPX terminal using pre-assembled cables.

Function examples

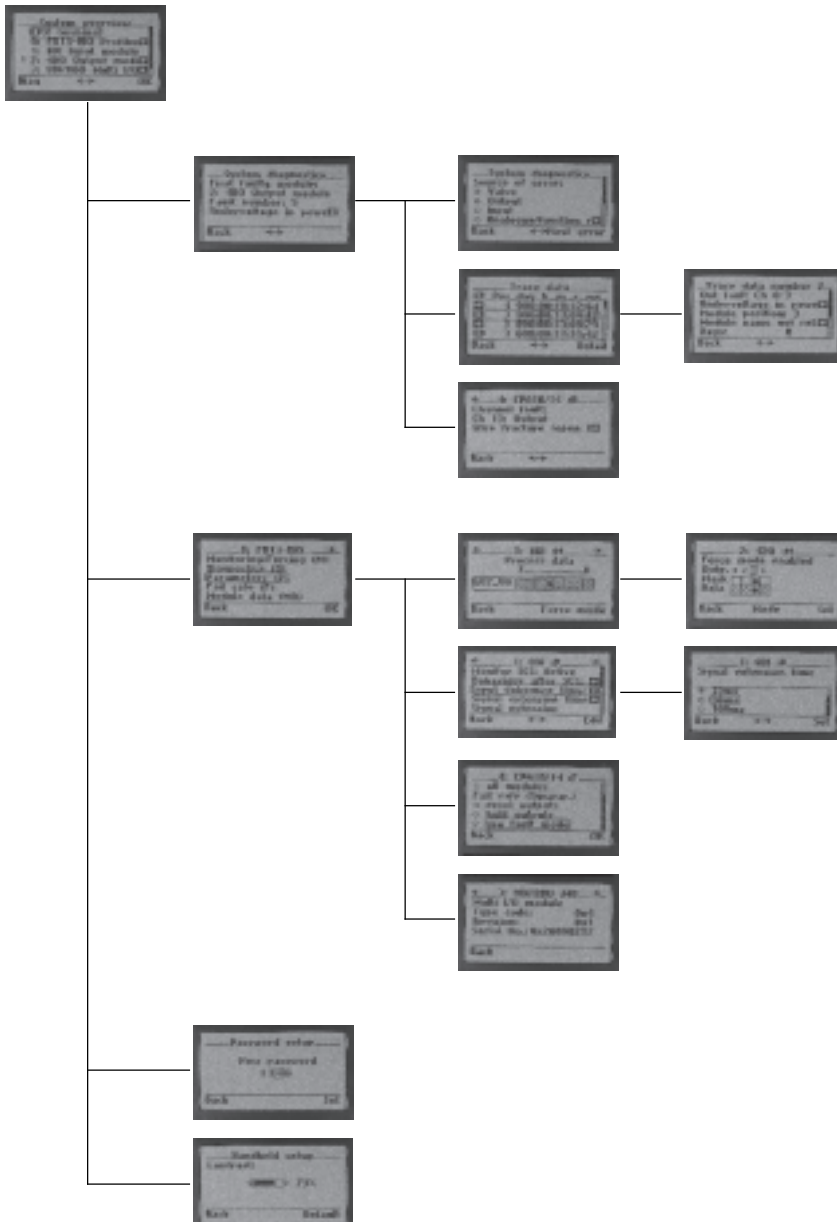

System overview

- Overview of configured modules and current diagnostic messages

Diagnostics

- Fast access to the diagnostic history and the modules with diagnostic messaging
- Display of the last 40 diagnostic messages with timestamp
- Display of the current diagnostic message for a module

Commissioning

- Selection of module-specific data and parameters
- Display and modification of the current status of the inputs and outputs of a module
- Display and modification of the current settings for module-specific parameters

Setup

- Setting of access permission (password)
- Contrast setting of the display

Terminal CPX

Technical data – Operator unit CPX-MMI-1

FESTO

General technical data		
Type	CPX-MMI-1	
Data interface	RS232 interface, 57.6 kBaud, M12 socket, 4-pin	
Display component	LCD graphical display with background illumination (128 x 64 pixels)	
Control elements	7 keys: 4 arrow keys and 3 function keys, touch-sensitive keypad	
Electromagnetic compatibility	Interference emission tested to DIN EN 61000-6-4, industry	
	Interference immunity tested to DIN EN 61000-6-2, industry	
Nominal operating voltage	[V DC]	24, supplied by the connected device
Operating voltage range	[V DC]	18 ... 30
Current consumption	[mA]	50 ... 60
Protection class to IEC 60529	IP65	
Relative air humidity	[%]	90, non-condensing
Vibration resistance	Tested to DIN/IEC 68/EN 60068, Part 2-6	
	<ul style="list-style-type: none"> • With wall mounting: Severity level 2 • With H-rail mounting: Severity level 1 	
Shock resistance	Tested to DIN/IEC 68/EN 60068, Part 2-27	
	<ul style="list-style-type: none"> • With wall mounting: Severity level 2 • With H-rail mounting: Severity level 1 	
Materials	Reinforced polyamide	
Dimensions (W x H x D)	[mm]	81 x 137 x 28
Weight	[g]	150

Operating and environmental conditions		
Ambient temperature	[°C]	0 ... 50
CE mark (see declaration of conformity)	To EU EMC Directive ¹⁾	
	In accordance with EU Explosion Protection Directive (ATEX)	
ATEX category	Gas	II 3 G
	Dust	II 3 D
EX-ignition protection type	Gas	Ex nA IIC T6 X Gc
	Dust	Ex tc IIIC T60°C X Dc IP65
ATEX ambient temperature	[°C]	-5 ≤ Ta ≤ +50

- 1) For information about the applicability of the component see the manufacturer's EC declaration of conformity at: www.festo.com → Support → User documentation.
If the component is subject to restrictions on usage in residential, office or commercial environments or small businesses, further measures to reduce the emitted interference may be necessary.

 Note



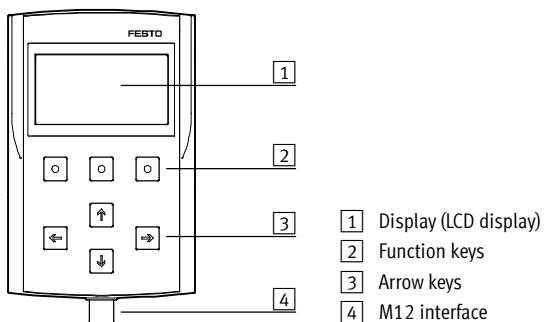

When operating device combinations in hazardous areas, the lowest common zone, temperature class and ambient temperature of the individual devices determine the possible use of the entire module.

Connection and display components

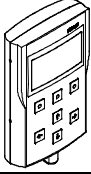

Terminal CPX

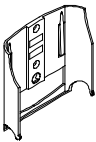
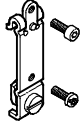
Accessories – Operator unit CPX-MMI-1

Ordering data			
Designation		Part No.	Type
Operator unit			
	Provides data polling, configuration and diagnostic functions for CPX terminals	529043	CPX-MMI-1
Connecting cable			
	Connecting cable M12-M12, specially for CPX-MMI	1.5 m	529044 KV-M12-M12-1,5
		3.5 m	530901 KV-M12-M12-3,5
Mounting			
	Bracket	534705	CPX-MMI-1-H
	Mounting for H-rail	536689	CPX-MMI-1-NRH
User manual			
	User manual for operator unit CPX-MMI-1	German	534824 P.BE-CPX-MMI-1-DE
		English	534825 P.BE-CPX-MMI-1-EN
		French	534827 P.BE-CPX-MMI-1-FR
		Italian	534828 P.BE-CPX-MMI-1-IT
		Swedish	534829 P.BE-CPX-MMI-1-SV
		Spanish	534826 P.BE-CPX-MMI-1-ES

Terminal CPX

Technical data – CPX Maintenance Tool

Function

CPX Maintenance Tool (CPX-FMT) combines service software with a connecting adapter. The service software is a tool for the design, parameterisation and online diagnostics of the CPX terminal. The USB-to-M12 adapter features built-in galvanic isolation (between CPX and PC) and enables a PC to be connected to the diagnostic interface of the CPX terminal.

- Adapter
- Software on CD-ROM

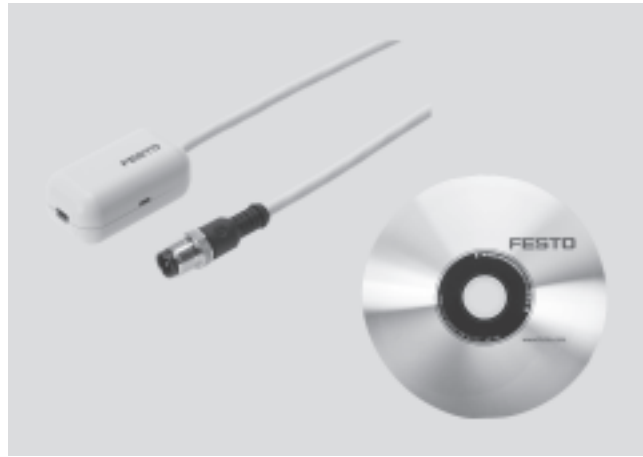

Application

Only from Festo

The CPX-FMT software enables access to CPX valve terminals via Ethernet with the control block CPX-FEC and the bus nodes EtherNet/IP (FB 32) and PROFINET (FB 33, FB 34, FB 35). The bus nodes or control block can be connected directly to the PC via a USB adapter from Festo. Similar to the CPX-MMI, diagnostic data such as

the error trace or module diagnostics can be read out and parameters can be modified in plain text. In contrast to the CPX-MMI, the data can be used directly on a PC. There is an option, for example, to send screenshots of a configuration or the current error trace directly via e-mail. In addition, CPX configurations can also be saved

and archived directly as a CPX-FMT project. Undocumented changes can subsequently be identified using the online/offline comparison function. On-site tests such as the actuation of valves or the emulation of sensor feedback (in both cases called “forcing”), for example, can be

performed without an existing controller infrastructure. It must be noted that with both the CPX-FMT and the CPX-MMI, only local parameters on the CPX valve terminal can be changed and saved. The configuration of the networks or controller software cannot be influenced.

General technical data		
Type	NEFC-M12G5-0.3-U1G5	
System requirements	PC	IBM-compatible
	Drive	CD-ROM
	Interfaces	USB port (specification USB 1.1 or higher)
	Operating system	Microsoft Windows 2000 or XP
Functional range	<ul style="list-style-type: none"> • Configuration and parameterisation • Reading out of system, module, channel diagnostics and error trace • Saving of the configuration as a project • Integration of plug-ins/links to self-executing programs 	
Scope of delivery	<ul style="list-style-type: none"> • Adapter M12, 5-pin to mini USB socket • CD-ROM with installation program 	
Type of mounting	Screw-in	
Electrical connection	Plug M12x1, 5-pin	
Adapter cable composition	4 x 0.34 mm ²	
Cable length	[m]	0.3
Protection class to EN 60529	IP20	
CE mark (see declaration of conformity)	To EU EMC Directive	
Ambient temperature	[°C]	-5 ... +50
Material	Housing	Acrylic butadiene styrene
	Cable sheath	Polyurethane
	Pin contact	Gold-plated brass
Note on materials	RoHS-compliant	

Terminal CPX

Technical data – CPX Maintenance Tool

Display components

Creating a device configuration using the editor

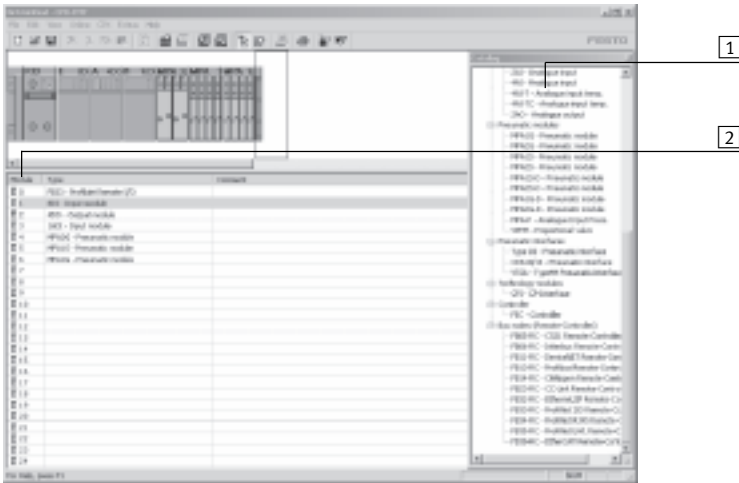

The device configuration can be conveniently generated, parameterised and saved using the drag & drop feature. You can insert and move modules.

- 1 Module numbers from the graphic system overview
- 2 Catalogue for selecting required modules

Module overview for a selected module

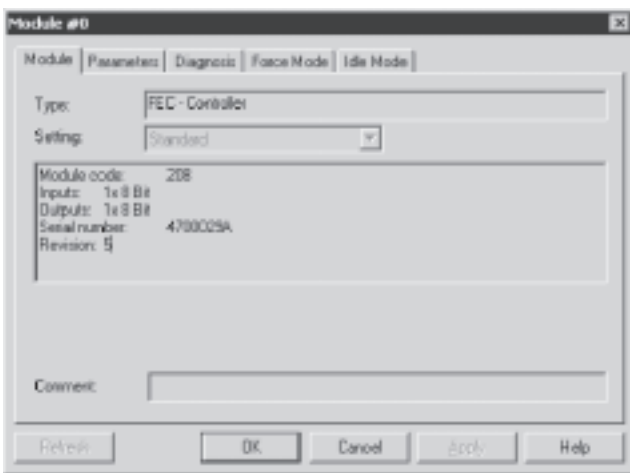

Displays important module data as well as the number of allocated inputs and outputs.

Diagnostic memory

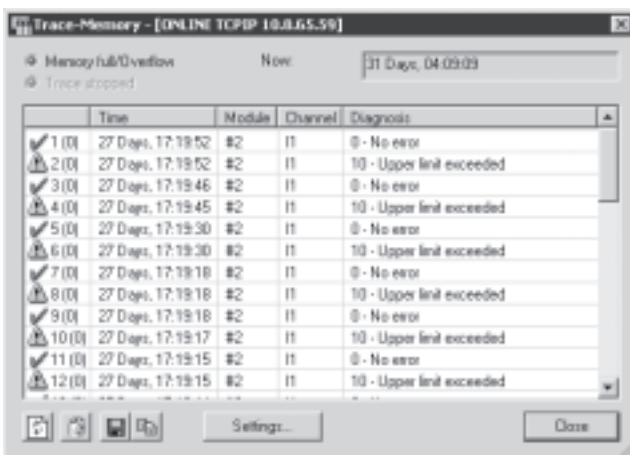

Faults which occur during operation are entered in a diagnostic memory. The first or the last 40 entries are saved, as well as the respective time measured from the moment the power supply was switched on.

Terminal CPX

Technical data – CPX Maintenance Tool

FESTO

Dimensions

Download CAD data → www.festo.com

Adapter

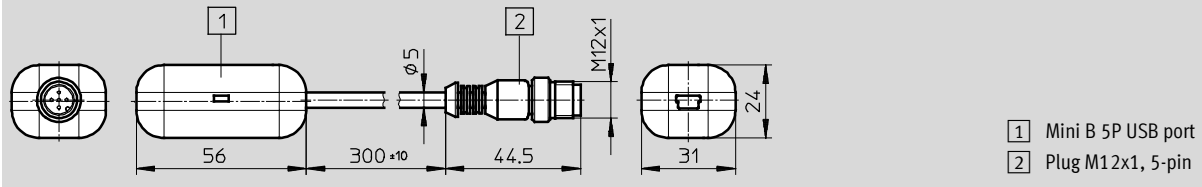

Ordering data

Designation	Part No.	Type
 CPX Maintenance Tool (CPX-FMT), software and USB-to-M12 adapter	547432	NEFC-M12G5-0.3-U1G5

Terminal CPX

Technical data – Control block CPX-FEC

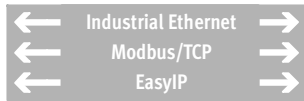

IT services:



Powerful control block for pre-processing actuation of the CPX modules.

The power supply to and communication with other modules takes place via the interlinking block.

In addition to the connection for the Ethernet interface in RJ45 and a programming interface in Sub-D, LEDs are also provided for the bus status, operating status of the PLC and CPX peripherals information, as are switching elements and a diagnostic interface for CPX-MMI and CPX-FMT.



Application

Bus connection	Modbus/TCP (code T05)
The CPX-FEC is a remote controller that can be connected to a master PLC via the bus nodes of the CPX terminal or via Ethernet. At the same time, it is possible to operate the CPX-FEC as a compact stand-alone controller directly on the machine.	Transmits data in binary format within TCP/IP packets. This ensures good data throughput.

Operating modes	Communication protocols
<ul style="list-style-type: none"> Stand-alone/EasyIP Fieldbus remote controller Modbus/TCP remote controller Remote I/O Modbus/TCP 	<ul style="list-style-type: none"> PROFIBUS, PROFINET, DeviceNet, INTERBUS, CANopen, EtherCAT and CC-Link via CPX bus node Modbus/TCP EasyIP IP TCP UDP SMTP HTTP DHCP BootP TFTP

Setting options

CPX-FEC has the following interfaces for monitoring, programming and commissioning:	<ul style="list-style-type: none"> For the CPX-MMI/-FMT Serial interface RS232, for example, for a Front End Display (FED) Ethernet interface for IT applications Remote diagnostics 	The operating mode and fieldbus protocol are set using the DIL switch on the CPX-FEC.	The integrated web server offers a convenient means of querying data saved in the CPX-FEC.
---	--	---	--

Terminal CPX

Technical data – Control block CPX-FEC

FESTO

General technical data		
Type	CPX-FEC-1-IE	
Ethernet interface	RJ45 (8-pin, socket)	
Data interface	RS232 (Sub-D, 9-pin, socket)	
MMI/FMT interface	M12, 5-pin, socket	
Baud rate	Ethernet interface	[Mbit/s] 10/100 (to IEEE802.3, 10BaseT)
	Data interface	[kbit/s] 9.6 ... 115.2
	MMI/FMT interface	[kbit/s] 56.6
Protocol	<ul style="list-style-type: none"> • TCP/IP • Easy IP • Modbus TCP • HTTP 	
Processing time for 1,024 binary instructions	[ms]	Approx. 1
Flags	M0.0 ... M9999, addressable as bits or words	
	No. of time flags	T0 ... T255
	Time range	[s] 0.01 to 655.35
	No. of counting flags	Z0 ... Z255
	Counting range	0 to 65535
Register	R0 ... R255, addressable as words	
Special FE	FE 0 ... 255, init flag	
IP address setting	BOOTP/DHCP via FST or via MMI/FMT	
Max. address capacity	Inputs	[byte] 64
	Outputs	[byte] 64
Program memory	User program	[kB] 250
	Web applications	[kB] 550
Programming language	<ul style="list-style-type: none"> • IL • LD 	
Arithmetic functions	+, -, *, /, ; further functions via functional modules	
Functional modules	<ul style="list-style-type: none"> • CPX diagnostic status • Copy CPX diagnostic trace • Read CPX module diagnostics • Write CPX module parameter • ... 	
No. of programs/tasks	P0 ... P63	
LED displays (FEC-specific)	RUN = Program is being executed/Modbus connection active STOP = Program is stopped/no Modbus connection ERR = Error in the program execution TP = Status of the Ethernet connection	
Device-specific diagnostics	Module and channel-oriented diagnostics via peripherals error	
Parameterisation	<ul style="list-style-type: none"> • Start-up parameterisation via FST • Parameterisation during the operating time via functional module 	
Control elements	<ul style="list-style-type: none"> • DIL switch for setting the operating mode • Rotary switch for program selection/program start 	
Additional functions	<ul style="list-style-type: none"> • Storage of the last 40 errors with timestamp (access via PCP) • 8-bit system status in image table for inputs • 2-byte inputs and 2-byte outputs, system diagnostics in image table 	

Terminal CPX

Technical data – Control block CPX-FEC

General technical data			
Operating voltage	Nominal value	[V DC]	24 (reverse polarity protected)
	Permissible range	[V DC]	18 ... 30
	Power failure buffering	[ms]	10
Residual ripple		[Vss]	4
Current consumption		[mA]	Max. 200
Interference emission	To EN 61000-6-4 (industry)		
Interference immunity	To EN 61000-6-2 (industry)		
Protection class to EN 60529	IP65/IP67		
Temperature range	Operation	[°C]	-5 ... +50
	Storage/transport	[°C]	-20 ... +70
Materials	Polymer		
Grid dimension		[mm]	50
Dimensions (incl. interlinking block) W x L x H		[mm]	50 x 107 x 55
Weight		[g]	140

 Note

Please observe the general limits and guidelines for the system when configuring the electrical modules.

Overview of the operating modes	Stand-alone	Remote controller		Remote I/O
		Ethernet	Fieldbus	Modbus/TCP
CPX-FEC function	Control	Control and communication		Ethernet slave
CPX module controlled by	CPX-FEC	CPX-FEC		Higher-order controller
Pre-processing of data in the FEC	Yes	Yes		No
Communication with higher-order controller	No	Via Ethernet • EasyIP • Modbus/TCP	Via fieldbus	Via Ethernet • EasyIP • Modbus/TCP
Web server	Possible	Possible		Possible
Configuration	FST 4.1 or higher	FST 4.1 or higher		Higher-order controller
Parameterisation	Via FST, CPX-MMI/-FMT	Via FST, CPX-MMI/-FMT		Via CPX-MMI/-FMT, Modbus
Order code	T03	T03		T05
Addressing	Changeable	Changeable		Preset
Memory	• 250 kB for user program • 550 kB for web applications	• 250 kB for user program • 550 kB for web applications		• 800 kB for web applications
CPX-MMI/-FMT	Can be connected to CPX-FEC	Can be connected to CPX-FEC		Can be connected to CPX-FEC

Terminal CPX

Technical data – Control block CPX-FEC

Connection and display components

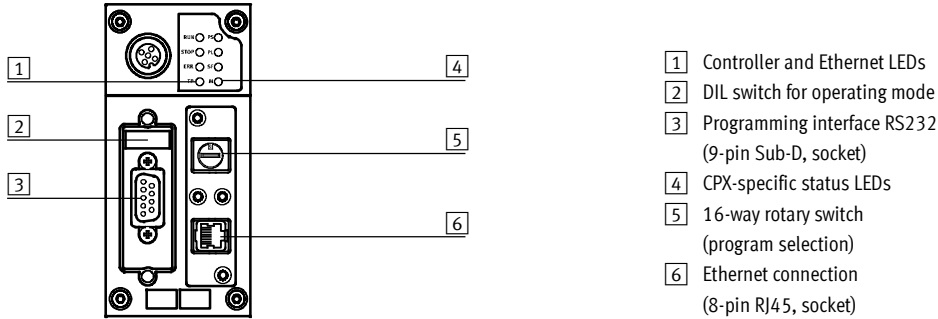

Pin allocation for the programming interface (RS232)

Pin allocation	Pin	Signal	Designation
Sub-D socket			
	1	n.c.	Not connected
	2	RxD	Received data
	3	TxD-P	Transmitted data
	4	n.c.	Not connected
	5	GND	Data reference potential
	6	n.c.	Not connected
	7	n.c.	Not connected
	8	n.c.	Not connected
	9	n.c.	Not connected
	Housing	Screened	Connection to functional earth (FE)

Pin allocation for the Ethernet interface

Pin allocation	Pin	Signal	Designation
RJ45 plug			
	1	TD+	Transmitted data+
	2	TD-	Transmitted data-
	3	RD+	Received data+
	4	n.c.	Not connected
	5	n.c.	Not connected
	6	RD-	Received data-
	7	n.c.	Not connected
	8	n.c.	Not connected
Housing	Screened	Screened	







Ordering data

Designation	Part No.	Type
Control block		
<p>For pre-processing actuation of the CPX modules</p>	529041	CPX-FEC-1-IE

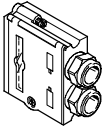
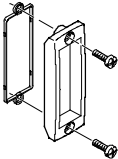
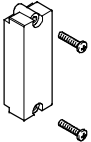
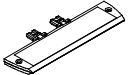
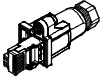
Terminal CPX

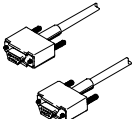
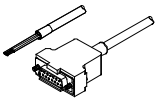
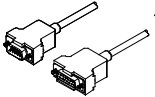
Accessories – Control block CPX-FEC

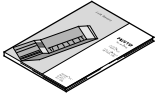

Ordering data			
Designation		Part No.	Type
Bus connection			
	Sub-D plug	534497	FBS-SUB-9-GS-1x9POL-B
	Inspection cover, transparent	533334	AK-SUB-9/15-B
	Inspection cover	557010	AK-SUB-9/15
	Inscription label holder for connection block	536593	CPX-ST-1
	RJ45/plug	534494	FBS-RJ45-8-GS
	Cover for RJ45 connection	534496	AK-RJ45
	Programming cable	151915	KDI-PPA-3-BU9
	Connecting cable FED	539642	FEC-KBG7
	Connecting cable FED	539643	FEC-KBG8
	Adapter from 5-pin M12 to mini USB socket and controller software	547432	NEFC-M12G5-0.3-U1G5
User manual			
	User manual for control block CPX-FEC	German	538474 P.BE-CPX-FEC-DE
		English	538475 P.BE-CPX-FEC-EN
		Spanish	538476 P.BE-CPX-FEC-ES
		French	538477 P.BE-CPX-FEC-FR
		Italian	538478 P.BE-CPX-FEC-IT
		Swedish	538479 P.BE-CPX-FEC-SV
Software			
	Programming software	German	537927 P.SW-FST4-CD-DE
		English	537928 P.SW-FST4-CD-EN

Control block CPX-CEC

Technical data



The CoDeSys controller is a modern control system for CPX terminals that enables programming with CoDeSys to IEC 61131-3.

- Easy actuation of valve terminal configurations with MPA, VTSA
- Connection to all fieldbuses as a remote controller and for preprocessing
- Actuation of electric drives as individual axes via CANopen (CPX-CEC-C1/-M1)

- Diagnostics with flexible monitoring options for pressure, flow rate, cylinder operating time, air consumption
- Early warnings and visualisation options
- Actuation of decentralised installation systems on the basis of CPI actuation of applications in proportional pneumatics
- Servopneumatic applications
- AS-interface actuation via gateway

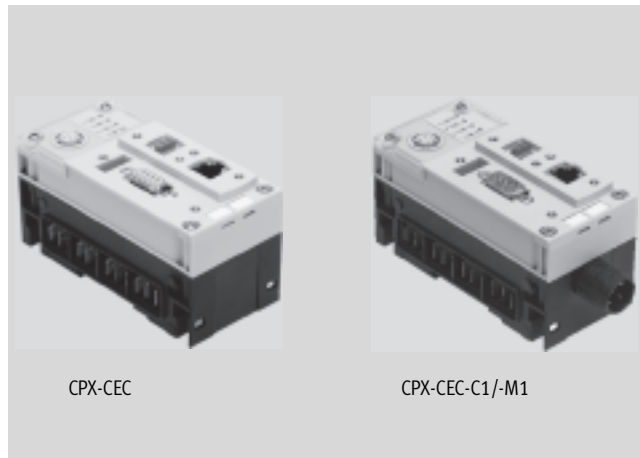

General technical data			
Type	CPX-CEC-C1	CPX-CEC-M1	CPX-CEC
Protocol	CoDeSys level 2		
	EasyIP		
	Modbus TCP		
	TCP/IP		
CPU data	32 MB RAM		
	32 MB flash		
	400 MHz processor		
Control interface	CAN bus		-
Processing time	Approx. 200 µs/1k instruction		
Baud rate	10/100 bps to IEEE 802.3 (10BaseT) or 802.3u (100BaseTx)		
Programming software	CoDeSys provided by Festo		
Programming language	SFC, IL, FCH, LD and ST to IEC 61131-3		
	Additionally CFC		
Programming, operating language	German		
	English		
Programming, support for file handling	Yes		
Program memory	4 MB user program		
Flags	30 kB remanent memory		
	8 MB global data memory		
	CoDeSys variable concept		
Device-specific diagnostics	Diagnostic memory		
	Channel and module-oriented diagnostics		
	Undervoltage/short circuit of modules		
LED displays (bus-specific)	TP: Link/traffic		
LED displays (product-specific)	RUN: PLC status		
	STOP: PLC status		
	ERR: PLC runtime error		
	PS: Electronics supply, sensor supply		
	PL: Load supply		
	SF: System fault		
	M: Modify/forcing active		
Parameterisation	CoDeSys		
Configuration support	CoDeSys		
IP address setting	DHCP		
	Via CoDeSys		
	Via MMI		
Control elements	DIL switch for CAN termination		-
	Rotary switch for RUN/STOP		

Control block CPX-CEC

Technical data

FESTO

General technical data			
Type	CPX-CEC-C1	CPX-CEC-M1	CPX-CEC
Function blocks	CPX diagnostic status, copy CPX diagnostic trace, read CPX module diagnostics And others		
Additional functions	Diagnostic functions Motion functions for electric drives SoftMotion functions for electric drives Communication functions RS232		
Total number of axes	31	31 (recommended: max. 8)	–
Nominal operating voltage [V DC]	24		
Nominal operating voltage of the load voltage [V DC]	24		
	18 ... 30, without pneumatics		
	21.6 ... 26.4, with pneumatics type midi/maxi		
	20.4 ... 26.4, with pneumatics type CPA		
	18 ... 30, with pneumatics type MPA		
Power failure bridging [ms]	10		
Intrinsic current consumption at nominal operating voltage [mA]	Typically 85		
Protection class	IP65, IP67		
Dimensions W x L x H (incl. interlinking block) [mm]	50 x 107 x 55		
Product weight [g]	155		
Materials			
Housing	Reinforced polyamide, polycarbonate		
Note on materials	RoHS-compliant		

Technical data – Interfaces			
Type	CPX-CEC-C1	CPX-CEC-M1	CPX-CEC
Ethernet			
Number	1		
Ethernet interface	RJ45		
Connector plug	RJ45 socket, 8-pin		
Data transmission speed [Mbps]	10/100		
Supported protocols	TCP/IP Easy IP Modbus TCP (Server)		
Fieldbus interface			
Type	CAN bus		–
Connection technology	Sub-D plug, 9-pin		
Transmission rate [kbps]	125; 250; 500; 800; 1,000	125; 250; 500; 1,000	
	Adjustable via software	Adjustable via software	
Electrical isolation	Yes		
RS232 interface			
Data interface	–		Sub-D socket, 9-pin 9.6 ... 230.4 kbps Electrically isolated

Operating and environmental conditions	
Ambient temperature [°C]	–5 ... +50
Storage temperature [°C]	–20 ... +70
Relative air humidity [%]	95, non-condensing
Corrosion resistance class CRC ¹⁾	2

1) Corrosion resistance class 2 according to Festo standard 940 070
Components subject to moderate corrosion stress. Externally visible parts with primarily decorative surface requirements which are in direct contact with a normal industrial environment or media such as coolants or lubricating agents

Control block CPX-CEC

Technical data

Connection and display components

CPX-CEC-C1/-M1

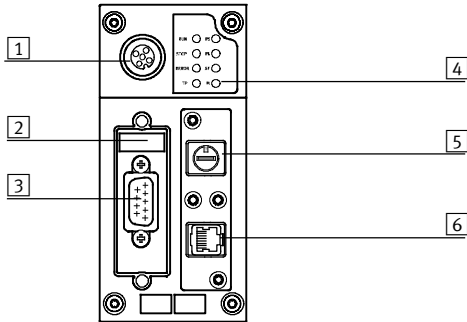

- 1 CPX-MMI connection
- 2 DIL switch
- 3 Fieldbus interface (plug, Sub-D, 9-pin)
- 4 Status LEDs, bus-specific and product-specific
- 5 RUN/STOP rotary switch
- 6 Ethernet interface (RJ45, socket, 8-pin)

CPX-CEC

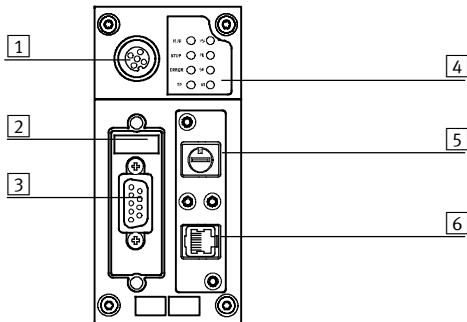

- 1 CPX-MMI connection
- 2 DIL switch
- 3 RS232 interface (socket, Sub-D, 9-pin)
- 4 Status LEDs, bus-specific and product-specific
- 5 RUN/STOP rotary switch
- 6 Ethernet interface (RJ45, socket, 8-pin)

Pin allocation – Fieldbus interface (CPX-CEC-C1/-M1)

	Pin	Signal	Meaning
Sub-D plug			
	1	n.c.	Not connected
	2	CAN_L	CAN low
	3	CAN_GND	CAN ground
	4	n.c.	Not connected
	5	CAN_SHLD	Connection to functional earth (FE)
	6	CAN_GND	CAN ground (optional) ¹⁾
	7	CAN_H	CAN high
	8	n.c.	Not connected
	9	n.c.	Not connected
	Housing	Screened	Plug housing must be connected to FE

1) If a drive controller is connected to an external power supply, CAN ground (optional), pin 6, cannot be used on the CPX-CEC-C1/-M1.

Pin allocation – RS232 interface (CPX-CEC)

	Pin	Signal	Meaning
Sub-D socket			
	1	n.c.	Not connected
	2	RxD	Received data
	3	TxD	Transmitted data
	4	n.c.	Not connected
	5	GND	Data reference potential
	6	n.c.	Not connected
	7	n.c.	Not connected
	8	n.c.	Not connected
	9	n.c.	Not connected
	Screened	Screened	Connection to functional earth

Control block CPX-CEC

Technical data

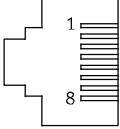





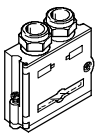
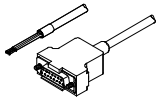
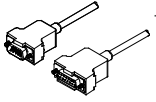

Pin allocation – Ethernet interface			
	Pin	Signal	Meaning
RJ45 plug			
	1	TD+	Transmitted data+
	2	TD-	Transmitted data-
	3	RD+	Received data+
	4	n.c.	Not connected
	5	n.c.	Not connected
	6	RD-	Received data-
	7	n.c.	Not connected
	8	n.c.	Not connected
	Housing	Screened	Screened

Ordering data		
Designation	Part No.	Type
	Control block	567347 CPX-CEC-C1
		567348 CPX-CEC-M1
		567346 CPX-CEC

Control block CPX-CEC

Accessories

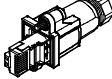
FESTO

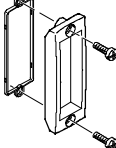
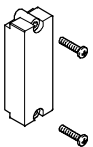
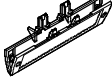
Ordering data – Bus connection			
Designation		Part No.	Type
	Sub-D plug, 9-pin (for CPX-CEC-C1/-M1)	532219	FBS-SUB-9-BU-2x5POL-B
	Connecting cable FED (for CPX-CEC)	539642	FEC-KBG7
	Connecting cable FED (for CPX-CEC)	539643	FEC-KBG8
	Bus connection, plug 2xM12, 5-pin	525632	FBA-2-M12-5POL
	Plug socket for fieldbus connection, M12, 5-pin	18324	FBSD-GD-9-5POL
	Plug, M12, 5-pin	175380	FBS-M12-5GS-PG9
	Bus connection, 5-pin	525634	FBA-1-SL-5POL
	Bus connection, screw terminal, 5-pin	525635	FBSD-KL-2x5POL
	RJ45 plug, 8-pin	534494	FBS-RJ45-8-GS
	Cover for RJ45 connection	534496	AK-RJ45
	Inspection cover, transparent for Sub-D plug/socket	533334	AK-SUB-9/15-B
	Cover for Sub-D plug/socket	557010	AK-SUB-9/15
	Inscription label holder for manifold block	536593	CPX-ST-1

Documentation			
Designation		Language	Part No. Type
	Manual for control block CPX-CEC	German	569121 P.BE-CPX-CEC-DE
		English	569122 P.BE-CPX-CEC-EN

Terminal CPX

Technical data – Bus node CPX-FB6



Bus node for handling communication between the electrical CPX terminal and a higher-order master via INTERBUS.

The bus node is provided with system supply via the interlinking block and processes communication with the I/O modules.

The status of the CPX terminal is displayed as a common message via four CPX-specific LEDs.

The fieldbus communication status is displayed via four INTERBUS-specific LEDs.



Application

Bus connection

The bus connection is established via a 9-pin Sub-D socket and a 9-pin Sub-D plug with a typical INTERBUS pin allocation.

The bus connector plugs (with IP65/IP67 protection from Festo or IP20 protection from other manufacturers) facilitate the connection of the incoming and outgoing bus cable.

The outgoing bus plug contains the typical INTERBUS RBST bridge for identification of the outgoing bus connection.

The Sub-D interfaces are designed for controlling network components with a fibre-optic cable connection.

INTERBUS implementation

The CPX-FB6 supports the INTERBUS protocol to EN 50254.

In addition to synchronous I/O exchange, the optional PCP channel can be used for parameterisation and diagnostic functions.

The PCP channel provides access to advanced system information and assigns operation parameters while the controller is running via the user program.

An example of this is access to the integrated diagnostic memory function, i.e. storage of the last 40 errors with timestamp, module, channel and error type.

With its address capacity of 96 inputs and 96 outputs, the CPX-FB6 supports a large number of I/O module configurations, including pneumatic interface.

 Note
If the PCP channel is used, the maximum number of possible process data bits is reduced by 16.

Special points in combination with CPX-FEC/CPX-CEC

When a bus node is combined with a control block (CPX-FEX, CPX-CEC, in the fieldbus remote controller operating mode), the connected I/Os and/or valves, sensors and actuators are controlled via the CPX control block.

In this case, the bus node only provides the communication interface to the PLC. Communication between the control block and CPX bus node is established

via the interlinking of the CPX modules and occupies an address capacity of the CPX system of:

- 8 byte outputs
- 8 byte inputs

The remaining address capacity of the control block or CPX system for actuating the peripherals is:

- 56 byte inputs
- 56 byte outputs

Terminal CPX

Technical data – Bus node CPX-FB6

FESTO

General technical data			CPX-FB6
Type			
Fieldbus interface			Sub-D, 9-pin, socket and pin
Baud rate		[Mbit/s]	0.5 and 2
Bus type			Remote bus
Ident. code			1, 2 or 3 (configuration-specific) 243 (PCP-channel activated)
Profile			12 (I/O device)
PCP channel			Yes, 16 bit (optional via DIL switch)
Configuration support			Icons for CMD software
Max. no. of process data bits	Inputs	[bit]	96
	Outputs	[bit]	96
LED displays (bus-specific)			UL = Operating voltage for INTERBUS interface RC = Remotebus check BA = Bus active RD = Remotebus disable TR = Transmit/receive
Device-specific diagnostics			Via peripherals error
Parameterisation			<ul style="list-style-type: none"> Start-up parameterisation via user functions (CMD) Via PCP communication
Additional functions			<ul style="list-style-type: none"> Storage of the last 40 errors with timestamp (access via PCP) 8-bit system status in image table for inputs 2-byte inputs and 2-byte outputs, system diagnostics in image table
Control elements			DIL switch
Operating voltage	Nominal value	[V DC]	24 (reverse polarity protected)
	Permissible range	[V DC]	18 ... 30
	Power failure buffering	[ms]	10
Current consumption			[mA] Typically 200
Protection class to EN 60529			IP65/IP67
Temperature range	Operation	[°C]	-5 ... +50
	Storage/transport	[°C]	-20 ... +70
Materials			Polymer
Grid dimension			[mm] 50
Dimensions (incl. interlinking block) W x L x H			[mm] 50 x 107 x 50
Weight			[g] 125

 Note

Please observe the general limits and guidelines for the system when configuring the electrical modules.

Terminal CPX

Technical data – Bus node CPX-FB6

Connection and display components

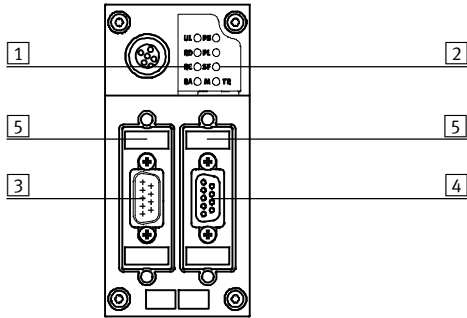

- 1 INTERBUS-specific LEDs
- 2 CPX-specific status LEDs
- 3 Fieldbus connection, incoming (9-pin Sub-D pin)
- 4 Fieldbus connection, outgoing (9-pin Sub-D socket)
- 5 DIL switch

Pin allocation for the INTERBUS interface

Pin allocation for Sub-D	Pin	Signal	Designation	Pin	Pin allocation for M12
Incoming					
	1	DO1	Data out	1	
	2	DI1	Data in	3	
	3	GND	Reference conductor/ground	5	
	4	n.c.	Not connected	2	
	5	n.c.	Not connected	4	
	6	/DO1	Data out inverse		
	7	/DI1	Data in inverse		
	8	n.c.	Not connected		
	9	n.c.	Not connected		
	Hous- ing	Screened	Connection to FE (functional earth) via R/C combination	Hous- ing	
Outgoing					
	1	DO2	Data out	1	
	2	DI2	Data in	3	
	3	GND	Reference conductor/ground	5	
	4	n.c.	Not connected	2	
	5	+5 V	Station detection ¹⁾	4	
	6	/DO2	Data out inverse		
	7	/DI2	Data in inverse		
	8	n.c.	Not connected		
	9	RBST	Station detection ¹⁾		
	Hous- ing	Screened	Connection to FE (functional earth)	Hous- ing	





The incoming interface is galvanically isolated from the CPX peripherals. The plug housing is connected to the functional earth FE of the CPX terminal via an R/C combination.

1) The CPX terminal contains the protocol chip SUPI 3 OPC. This ensures automatic detection of additional connected INTERBUS stations. There is therefore no need for a bridge between pin 5 and pin 9.

Terminal CPX

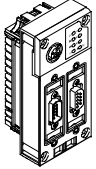
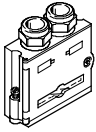
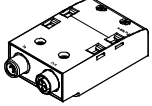
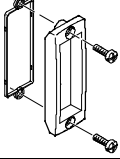
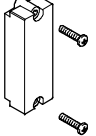
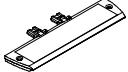
Accessories – Bus node CPX-FB6

FESTO

Ordering data			
Designation		Part No.	Type
Bus node			
	INTERBUS bus node	195748	CPX-FB6
Bus connection			
	Sub-D plug	Incoming	532218 FBS-SUB-9-BU-IB-B
		Outgoing	532217 FBS-SUB-9-GS-IB-B
	Connection block M12 adapter (B-coded)	534505	CPX-AB-2-M12-RK-IB
	Inspection cover, transparent	533334	AK-SUB-9/15-B
	Inspection cover	557010	AK-SUB-9/15
	Inscription label holder for connection block	536593	CPX-ST-1
	Threaded sleeve, 4 pieces	533000	UNC4-40/M3x6
	Adapter from 5-pin M12 to mini USB socket and controller software	547432	NEFC-M12G5-0.3-U1G5
User manual			
	User manual for bus node CPX-FB6	German	526433 P.BE-CPX-FB6-DE
		English	526434 P.BE-CPX-FB6-EN
		Spanish	526435 P.BE-CPX-FB6-ES
		French	526436 P.BE-CPX-FB6-FR
		Italian	526437 P.BE-CPX-FB6-IT
		Swedish	526438 P.BE-CPX-FB6-SV

Terminal CPX

Technical data – Bus node CPX-FB11



Bus node for handling communication between the electrical CPX terminal and a DeviceNet network. The bus node is provided with system supply via the interlinking block and processes communication with the I/O modules. The status of the CPX terminal is displayed as a common message via four CPX-specific LEDs. The fieldbus communication status is displayed via the three DeviceNet-specific LEDs.



Application

Bus connection

The bus connection can be selected when ordering, either Micro Style as 2xM12 round connectors or OpenStyle as a terminal strip with IP20 protection.

Both connection types have the function of an integrated T-distributor with incoming and outgoing bus line.

DeviceNet implementation

The CPX-FB11 operates with the “Predefined Master/Slave Connection Set” as a “Group 2 Only Server”. The polled I/O, change of state or synchronous method is used for the transmission of synchronous I/O data. The type of transmission can be selected in the network configuration.

The device diagnostics for all bus nodes CPX-FB11 is effectively gathered via strobed I/O and displayed in the input table of the controller. In addition to synchronous data transmission, asynchronous communication is supported through explicit messaging, which enables detailed device diagnostics and parameterisation.

A comprehensive EDS file supports the display of asynchronous data. It is also possible to display system information and assign parameters while the controller is running via the user program or the configuration software.

An example of this is access to the integrated diagnostic memory function, i.e. storage of the last 40 errors with timestamp, module, channel and error type. With its address capacity of 64 byte inputs and 64 byte outputs, the CPX-FB11 supports any configuration of I/O modules, including pneumatic interface.

Special points in combination with CPX-FEC/CPX-CEC

When a bus node is combined with a control block (CPX-FEX, CPX-CEC, in the fieldbus remote controller operating mode), the connected I/Os and/or valves, sensors and actuators are controlled via the CPX control block.

In this case, the bus node only provides the communication interface to the PLC. Communication between the control block and CPX bus node is established via the interlinking of the CPX modules and occupies an address capacity of the CPX system of:

- 8 byte outputs
- 8 byte inputs

The remaining address capacity of the control block or CPX system for actuating the peripherals is:

- 56 byte inputs
- 56 byte outputs

Terminal CPX

Technical data – Bus node CPX-FB11

FESTO

General technical data			
Type		CPX-FB11	
Fieldbus interface		Either <ul style="list-style-type: none"> • Micro Style bus connection: 2xM12 with IP65/IP67 protection • Open Style bus connection: 5-pin terminal strip, IP20 	
Baud rate	[kbps]	125, 250, 500	
Addressing range		0 ... 63 Set using DIL switch	
Product	Type	Communication adapter (12 dec.)	
	Code	4554 dec.	
Communication types		Polled I/O, change of state/synchronous, strobed I/O and explicit messaging	
Configuration support		EDS file and bitmaps	
Max. address capacity	Inputs	[byte]	64
	Outputs	[byte]	64
LED displays (bus-specific)		MS = Module status NS = Network status IO = I/O status	
Device-specific diagnostics		Module and channel-oriented diagnostics by means of manufacturer-specific diagnostic object	
Parameterisation		<ul style="list-style-type: none"> • Module and system parameterisation via configuration interface in plain text (EDS) • Online in run or program mode 	
Additional functions		<ul style="list-style-type: none"> • Storage of the last 40 errors with timestamp (access via EDS) • 8-bit system status in image table for inputs • 2-byte inputs and 2-byte outputs, system diagnostics in image table 	
Control elements		DIL switch	
Operating voltage	Nominal value	[V DC]	24
	Permissible range	[V DC]	18 ... 30
	Power failure buffering	[ms]	10
Current consumption		[mA]	Typically 200
Protection class to EN 60529		IP65/IP67	
Temperature range	Operation	[°C]	-5 ... +50
	Storage/transport	[°C]	-20 ... +70
Materials		Polymer	
Grid dimension		[mm]	50
Dimensions (incl. interlinking block) W x L x H		[mm]	50 x 107 x 50
Weight		[g]	120

 Note

Please observe the general limits and guidelines for the system when configuring the electrical modules.

Terminal CPX

Technical data – Bus node CPX-FB11

Connection and display components

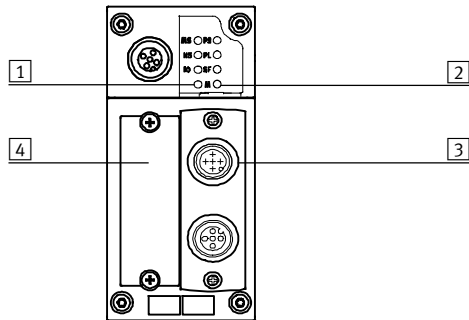

- 1 Bus-specific LEDs
- 2 CPX-specific status LEDs
- 3 Selectable fieldbus connection
Micro Style
Open Style
- 4 DIL switch cover

Pin allocation for the DeviceNet interface









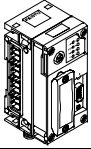
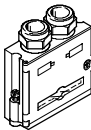

Pin allocation	Pin	Signal-specific core colour ¹⁾	Signal	Designation
Sub-D plug				
	1	–	n.c.	Not connected
	2	Blue	CAN_L	Received/transmitted data low
	3	Black	0 V bus	0 V CAN interface
	4	–	n.c.	Not connected
	5	Blank	Screened	Connection to housing
	6	–	n.c.	Not connected
	7	White	CAN_H	Received/transmitted data high
	8	–	n.c.	Not connected
	9	Red	24 V DC bus	24 V DC supply for CAN interface
Micro Style bus connection (M12), incoming/outgoing				
Incoming 	1	Blank	Screened	Connection to housing
	2	Red	24 V DC bus	24 V DC supply for CAN interface
	3	Black	0 V bus	0 V CAN interface
	4	White	CAN_H	Received/transmitted data high
	5	Blue	CAN_L	Received/transmitted data low
Outgoing 	1	Blank	Screened	Connection to housing
	2	Red	24 V DC bus	24 V DC supply for CAN interface
	3	Black	0 V bus	0 V CAN interface
	4	White	CAN_H	Received/transmitted data high
	5	Blue	CAN_L	Received/transmitted data low
Open Style bus connection				
	1	Black	0 V bus	0 V CAN interface
	2	Blue	CAN_L	Received/transmitted data low
	3	Blank	Screened	Connection to housing
	4	White	CAN_H	Received/transmitted data high
	5	Red	24 V DC bus	24 V DC supply for CAN interface
Bus connection 7/8¹⁾				
	1	Black	Screened	Connection to housing
	2	Blue	24 V DC	24 V DC supply for CAN interface
	3	Blank	0 V	0 V CAN interface
	4	White	CAN_H	Received/transmitted data high
	5	Red	CAN_L	Received/transmitted data low

1) Typical for DeviceNet cables

Terminal CPX

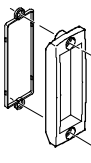
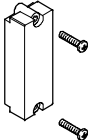
Accessories – Bus node CPX-FB11

FESTO

Ordering data			
Designation		Part No.	Type
Bus node			
	DeviceNet bus node	526172	CPX-FB11
Bus connection			
	Sub-D plug	532219	FBS-SUB-9-BU-2x5POL-B
	Connection block, socket Sub-D 9-pin, plug 7/8", 5-pin	571052	CPX-AB-1-7/8-DN
	Micro Style bus connection, 2xM12	525632	FBA-2-M12-5POL
	Socket for MicroStyle connection, M12	18324	FBSD-GD-9-5POL
	Plug for Micro Style connection, M12	175380	FBS-M12-5GS-PG9
	Open Style bus connection for 5-pin terminal strip	525634	FBA-1-SL-5POL
	Terminal strip for Open Style connection, 5-pin	525635	FBSD-KL-2x5POL
	Inspection cover, transparent	533334	AK-SUB-9/15-B
	Inspection cover	557010	AK-SUB-9/15
	Inscription label holder for connection block	536593	CPX-ST-1
	Adapter from 5-pin M12 to mini USB socket and controller software	547432	NEFC-M12G5-0.3-U1G5
User manual			
	User manual for bus node CPX-FB11	German	526421 P.BE-CPX-FB11-DE
		English	526422 P.BE-CPX-FB11-EN
		Spanish	526423 P.BE-CPX-FB11-ES
		French	526424 P.BE-CPX-FB11-FR
		Italian	526425 P.BE-CPX-FB11-IT
		Swedish	526426 P.BE-CPX-FB11-SV

Terminal CPX

Technical data – Bus node CPX-FB13



Bus node for handling communication between the electrical CPX terminal and a higher-order master via PROFIBUS DP.

The bus node is provided with system supply via the interlinking block and processes communication with the I/O modules.

The status of the CPX terminal is displayed as a common message via four CPX-specific LEDs.

The fieldbus communication status is displayed via the PROFIBUS-specific error LED.



Application

Bus connection

The bus connection is established via a 9-pin Sub-D socket with a typical PROFIBUS allocation (to EN 50170).

The bus connector plug (with IP65/IP67 protection from Festo or IP20 protection from other manufacturers) facilitates the connection of an incoming and an outgoing bus cable.

An active bus terminal can be connected using the DIL switch integrated in the plug.

The Sub-D interface is designed for controlling network components with a fibre-optic cable connection.

PROFIBUS DP implementation

The CPX-FB13 supports the PROFIBUS DP protocol to EN 50170 Volume 2 for synchronous I/O exchange, parameterisation and diagnostic functions (DPV0).

In addition to DPV0, asynchronous communication to the advanced specification DPV1 is supported. DPV1 provides asynchronous access to advanced system information and assigns operation parameters while the controller is running via the user program.

An example of this is access to the integrated diagnostic memory function, i.e. storage of the last 40 errors with timestamp, module, channel and error type.

With its address capacity of 64 byte inputs and 64 byte outputs, the CPX-FB13 supports any configuration of I/O modules, including pneumatic interface.

Special points in combination with CPX-FEC/CPX-CEC

When a bus node is combined with a control block (CPX-FEX, CPX-CEC, in the fieldbus remote controller operating mode), the connected I/Os and/or valves, sensors and actuators are controlled via the CPX control block.

In this case, the bus node only provides the communication interface to the PLC. Communication between the control block and CPX bus node is established

via the interlinking of the CPX modules and occupies an address capacity of the CPX system of:

- 8 byte outputs
- 8 byte inputs

The remaining address capacity of the control block or CPX system for actuating the peripherals is:

- 56 byte inputs
- 56 byte outputs

Terminal CPX

Technical data – Bus node CPX-FB13

General technical data			
Type		CPX-FB13	
Fieldbus interface		Sub-D socket, 9-pin (EN 50 170) Galvanically isolated 5 V	
Baud rate	[Mbit/s]	0.0096 ... 12	
Addressing range		1 ... 125 Set using DIL switch	
Product range		4: Valves	
Ident. number		0x059E	
Communication types		DPV0: Synchronous communication DPV1: Asynchronous communication	
Configuration support		GSD file and bitmaps	
Max. address capacity	Inputs	[byte]	64
	Outputs	[byte]	64
LED displays (bus-specific)		BF: Bus fault	
Device-specific diagnostics		Identifier and channel-oriented diagnostics to EN 50170 (PROFIBUS standard)	
Parameterisation		<ul style="list-style-type: none"> Start-up parameterisation via configuration interface in plain text (GSD) Asynchronous parameterisation via DPV1 	
Additional functions		<ul style="list-style-type: none"> Storage of the last 40 errors with timestamp (access via DPV1) 8-bit system status in image table for inputs 2-byte inputs and 2-byte outputs, system diagnostics in image table 	
Control elements		DIL switch	
Operating voltage	Nominal value	[V DC]	24
	Permissible range	[V DC]	18 ... 30
	Power failure buffering	[ms]	10
Current consumption		[mA]	Typically 200
Protection class to EN 60529		IP65/IP67	
Temperature range	Operation	[°C]	-5 ... +50
	Storage/transport	[°C]	-20 ... +70
Materials		Polymer	
Grid dimension		[mm]	50
Dimensions (incl. interlinking block) W x L x H		[mm]	50 x 107 x 50
Weight		[g]	115

 - Note
Please observe the general limits and guidelines for the system when configuring the electrical modules.

Terminal CPX

Technical data – Bus node CPX-FB13

Connection and display components

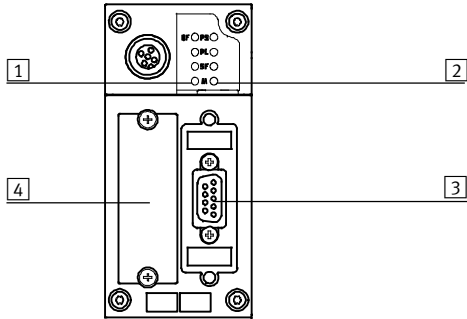

- 1 Bus status LEDs/bus fault
- 2 CPX-specific status LEDs
- 3 Fieldbus connection (9-pin Sub-D socket)
- 4 DIL switch cover

Pin allocation for PROFIBUS DP interface





Pin allocation	Pin	Signal	Designation
Sub-D plug			
	1	n.c.	Not connected
	2	n.c.	Not connected
	3	RxD/TxD-P	Received/transmitted data P
	4	CNTR-P ¹⁾	Repeater control signal
	5	DGND	Data reference potential (M5V)
	6	VP	Supply voltage (P5V)
	7	n.c.	Not connected
	8	RxD/TxD-N	Received/transmitted data N
	9	n.c.	Not connected
	Housing	Screened	Connection to housing
Bus connection M12 adapter (B-coded)			
Incoming			
	1	n.c.	Not connected
	2	RxD/TxD-N	Received/transmitted data N
	3	n.c.	Not connected
	4	RxD/TxD-P	Received/transmitted data P
	5 and M12	Screened	Connection to FE (functional earth)
Outgoing			
	1	VP	Supply voltage (P5V)
	2	RxD/TxD-N	Received/transmitted data N
	3	DGND	Data reference potential (M5V)
	4	RxD/TxD-P	Received/transmitted data P
	5 and M12	Screened	Connection to FE (functional earth)

1) The repeater control signal CNTR-P is realised as a TTL signal.

Terminal CPX

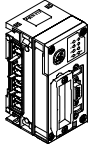
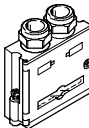
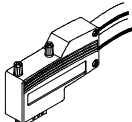
Accessories – Bus node CPX-FB13

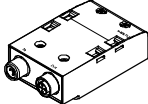
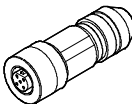
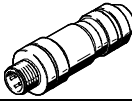
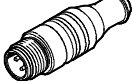
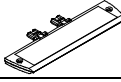
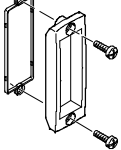
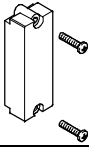
FESTO

Ordering data		Part No.	Type
Designation			
Bus node			
	PROFIBUS bus node	195740	CPX-FB13
Bus connection			
	Sub-D plug, straight	532216	FBS-SUB-9-GS-DP-B
	Sub-D plug, angled	533780	FBS-SUB-9-WS-PB-K
	Bus connection M12 adapter (B-coded)	533118	FBA-2-M12-5POL-RK
	Connection block M12 adapter (B-coded)	541519	CPX-AB-2-M12-RK-DP
	Socket M12x1, 5-pin, straight, for self-assembly of a connecting cable for FBA-2-M12-5POL-RK and CPX-AB-2-M12-RK-DP	1067905	NECU-M-B12G5-C2-PB
	Plug M12x1, 5-pin, straight, for self-assembly of a connecting cable for FBA-2-M12-5POL-RK and CPX-AB-2-M12-RK-DP	1066354	NECU-M-S-B12G5-C2-PB
	Terminating resistor, M12, B-coded for PROFIBUS	1072128	CACR-S-B12G5-220-PB
	Inscription label holder for connection block M12	536593	CPX-ST-1
	Inspection cover, transparent	533334	AK-SUB-9/15-B
	Inspection cover	557010	AK-SUB-9/15
	Adapter from 5-pin M12 to mini USB socket and controller software	547432	NEFC-M12G5-0.3-U1G5

Terminal CPX

Accessories – Bus node CPX-FB13

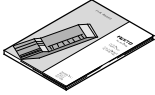
Ordering data				
Designation			Part No.	Type
User manual				
	User manual for bus node CPX-FB13	German	526427	P.BE-CPX-FB13-DE
		English	526428	P.BE-CPX-FB13-EN
		Spanish	526429	P.BE-CPX-FB13-ES
		French	526430	P.BE-CPX-FB13-FR
		Italian	526431	P.BE-CPX-FB13-IT
		Swedish	526432	P.BE-CPX-FB13-SV

Terminal CPX

Technical data – Bus node CPX-FB14



Bus node for handling communication between the electrical CPX terminal and a CANopen network master or CANopen network. The bus node is provided with system supply via the interlinking block and processes communication with the I/O modules. The status of the CPX terminal is displayed as a common message via four CPX-specific LEDs. The different CANopen statuses and the fieldbus communication status are displayed via three additional LEDs.



Application

Bus connection

<p>The bus connection is established via a 9-pin Sub-D plug (pin) as per the CAN in Automation (CiA) specification DS 102 with additional 24 V CAN transceiver supply (option as per DS 102).</p>	<p>The bus connector plug (with IP65/IP67 protection from Festo or IP20 protection from other manufacturers) facilitates the connection of an incoming and an outgoing bus cable.</p>	<p>There are four contacts available for the four wires (CAN_L, CAN_H, 24 V, 0 V) of the incoming and outgoing bus cables.</p>
---	---	--

CANopen implementation

<p>The CPX-FB14 supports the CANopen protocol in accordance with the specifications DS 301 V4.01 and DS 401 V2.0. Implementation is based on the CiA Pre-defined Connection Set. There are four PDOs available for fast I/O data exchange.</p>	<p>Advanced system information can also be accessed by means of SDO communication. SDO communication also facilitates parameterisation before network startup or while the controller is running via the user program. An example of this is access to the integrated diagnostic memory function, i.e. storage of the last 40 errors with timestamp, module, channel and error type.</p>	<p>With its address capacity, the CPX-FB14 supports a large number of I/O module configurations, including pneumatic interface. By default, 8 byte digital inputs and 8 byte digital outputs can be addressed via PDO 1.</p>	<p>8 analogue input channels and 8 analogue output channels can be addressed via PDO 2 and 3. Status and diagnostic information can be evaluated via PDO 4. Additional 8 byte digital inputs and outputs as well as 8 analogue input and output channels can be addressed via mapping.</p>
--	--	--	--

Special points in combination with CPX-FEC/CPX-CEC

<p>When a bus node is combined with a control block (CPX-FEX, CPX-CEC, in the fieldbus remote controller operating mode), the connected I/Os and/or valves, sensors and actuators are controlled via the CPX control block.</p>	<p>In this case, the bus node only provides the communication interface to the PLC. Communication between the control block and CPX bus node is established</p>	<p>via the interlinking of the CPX modules and occupies an address capacity of the CPX system of:</p> <ul style="list-style-type: none"> • 8 byte outputs • 8 byte inputs 	<p>The remaining address capacity of the control block or CPX system for actuating the peripherals is:</p> <ul style="list-style-type: none"> • 56 byte inputs • 56 byte outputs
---	---	---	--

Terminal CPX

Technical data – Bus node CPX-FB14

General technical data			
Type		CPX-FB14	
Fieldbus interface		Sub-D pin, 9-pin (to DS 102) Bus interface galvanically isolated via optocoupler 24 V supply for CAN interface via bus	
Baud rate	[kbit/s]	125; 250; 500 and 1,000 can be set via DIL switch	
Addressing range		Node ID 1 ... 127 Set using DIL switch	
Product range		Digital inputs and outputs	
Communication profile		DS 301, V4.01	
Device profile		DS 401, V2.0	
Number	PDO	4 Tx/4 Rx	
	SDO	1 server SDO	
Configuration support		EDS file and bitmaps	
Max. address capacity	Inputs	[byte]	16 digital, 16 analogue channels
	Outputs	[byte]	16 digital, 16 analogue channels
LED displays (bus-specific)		MS = Module status NS = Network status IO = I/O status	
Device-specific diagnostics		Via emergency message Object 1001, 1002 and 1003	
Parameterisation		Via SDO	
Additional functions		<ul style="list-style-type: none"> • Storage of the last 40 errors with timestamp (access via SDO) • 8-bit system status via transmit PDO 4 (default) • 2-byte inputs and 2-byte outputs, system diagnostics via PDO 4 • Minimum boot-up • Variable PDO mapping • Emergency message • Node guarding • Heart beat 	
Control elements		DIL switch	
Operating voltage	Nominal value	[V DC]	24
	Permissible range	[V DC]	18 ... 30
	Power failure buffering	[ms]	10
Current consumption		[mA]	Typically 200
Protection class to EN 60529		IP65/IP67	
Temperature range	Operation	[°C]	-5 ... +50
	Storage/transport	[°C]	-20 ... +70
Materials		Polymer	
Grid dimension		[mm]	50
Dimensions (incl. interlinking block) W x L x H		[mm]	50 x 107 x 50
Weight		[g]	115

 Note

Please observe the general limits and guidelines for the system when configuring the electrical modules.

Terminal CPX

Technical data – Bus node CPX-FB14

Connection and display components

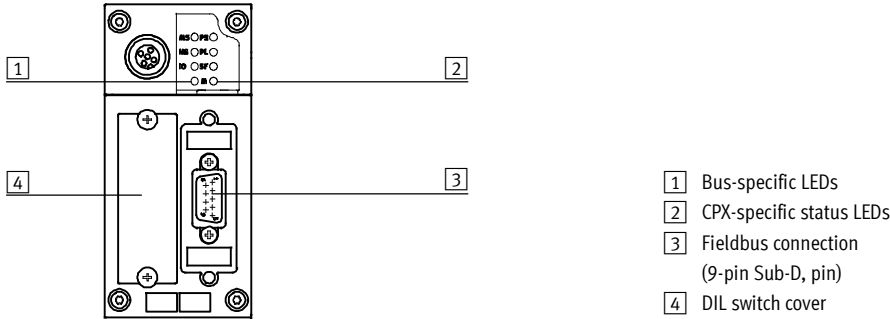

Pin allocation for the CANopen interface





Pin allocation	Pin	Signal	Designation
Sub-D plug			
	1	n.c.	Not connected
	2	CAN_L	Received/transmitted data low
	3	CAN_GND	0 V CAN interface
	4	n.c.	Not connected
	5	CAN_Shld	Optional screened connection
	6	GND	Ground ¹⁾
	7	CAN_H	Received/transmitted data high
	8	n.c.	Not connected
	9	CAN_V+	24 V DC supply for CAN interface
	Housing	Screened	Connection to FE (functional earth)
Micro Style bus connection (M12)			
Incoming 	1	Screened	Connection to FE (functional earth)
	2	CAN_V+	24 V DC supply for CAN interface
	3	CAN_GND	0 V CAN interface
	4	CAN_H	Received/transmitted data high
	5	CAN_L	Received/transmitted data low
Outgoing 	1	Screened	Connection to FE (functional earth)
	2	CAN_V+	24 V DC supply for CAN interface
	3	CAN_GND	0 V CAN interface
	4	CAN_H	Received/transmitted data high
	5	CAN_L	Received/transmitted data low
Open Style bus connection			
	1	CAN_GND	0 V CAN interface
	2	CAN_L	Received/transmitted data low
	3	Screened	Connection to FE (functional earth)
	4	CAN_H	Received/transmitted data high
	5	CAN_V+	24 V DC supply for CAN interface

1) Connected internally via Pin 3

Terminal CPX

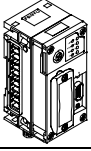
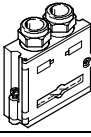
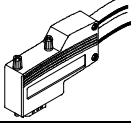
Accessories – Bus node CPX-FB14

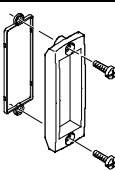
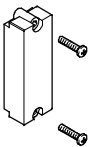
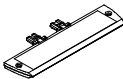
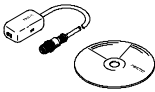
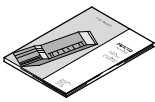

Ordering data			
Designation		Part No.	Type
Bus node			
	CANopen bus node	526174	CPX-FB14
Bus connection			
	Sub-D plug	532219	FBS-SUB-9-BU-2x5POL-B
	Sub-D plug, angled	533783	FBS-SUB-9-WS-CO-K
	Micro Style bus connection, 2xM12, 5-pin	525632	FBA-2-M12-5POL
	Fieldbus socket for Micro Style connection, M12, 5-pin	18324	FBSD-GD-9-5POL
	Plug for Micro Style connection, M12, 5-pin	175380	FBS-M12-5GS-PG9
	Open Style bus connection	525634	FBA-1-SL-5POL
	Terminal strip for Open Style connection, 5-pin	525635	FBSD-KL-2x5POL
	Inspection cover, transparent	533334	AK-SUB-9/15-B
	Inspection cover	557010	AK-SUB-9/15
	Inscription label holder for connection block	536593	CPX-ST-1
	Adapter from 5-pin M12 to mini USB socket and controller software	547432	NEFC-M12G5-0.3-U1G5
User manual			
	User manual for bus node CPX-FB14	German	526409 P.BE-CPX-FB14-DE
		English	526410 P.BE-CPX-FB14-EN
		Spanish	526411 P.BE-CPX-FB14-ES
		French	526412 P.BE-CPX-FB14-FR
		Italian	526413 P.BE-CPX-FB14-IT
		Swedish	526414 P.BE-CPX-FB14-SV

Terminal CPX

Technical data – Bus node CPX-M-FB20/CPX-M-FB21



Bus node for handling communication between the electrical terminal CPX and a higher-order master via INTERBUS.
 The bus node processes communication with the I/O modules.
 The status of the terminal CPX is displayed as a common message via 4 CPX-specific LEDs.
 The fieldbus communication status is displayed via 6 INTERBUS-specific LEDs.



Application

Bus connection

The bus connection is established via a socket with INTERBUS Rugged Line connection technology and the associated plug, with fibre-optic cables used for the power supply to the valve terminal and data transmission.

The fieldbus node is used as a remote I/O. It supports processing of max. 96 inputs and 96 outputs or max. 6 analogue I/O channels.

The I/O area is divided into:

- Digital I/O
- Analogue I/O

- System status/system diagnostics (optional)
- PCP channel (optional)

INTERBUS implementation

The CPX-M-FB20 and CPX-M-FB21 support the INTERBUS protocol to EN 50254.
 In addition to cyclic I/O exchange, the optional PCP channel can be used for parameterisation and diagnostic functions.

An example of this is access to the integrated diagnostic memory function, i.e. storage of the last 40 errors with timestamp, module, channel and error type.

The PCP channel provides access to advanced system information and assigns operation parameters while the controller is running via the user program.

Note
 If the PCP channel is used, the maximum number of possible process data bits is reduced by 16.

Special features in combination with CPX-FB20/CPX-FB21

- Remote Controller operating mode is not supported. A CPX-FEC/CPX-CEC cannot be used in combination with CPX FB20/CPX-FB21 in a terminal CPX.
- Power is supplied via the fieldbus connection. It is therefore not possible to use an interlinking block with system supply within a terminal CPX with CPX-M-FB20/CPX-M-FB21.
- Only the valve terminals VTSA and VTSA-F with pneumatic interface VABA-S6-1-X2 can be selected as the pneumatic part.

Terminal CPX

Technical data – Bus node CPX-M-FB20/CPX-M-FB21

General technical data			
Type		CPX-M-FB20/CPX-M-FB21	
Fieldbus interface		Rugged Line fibre-optic cable connection	
Baud rate	[Mbit/s]	0.5 and 2	
Bus type		Remote bus	
Max. address capacity	Inputs	[bit]	96
	Outputs	[bit]	96
LED displays	INTERBUS-specific		BA = Bus active FO1 = Fibre-optic cable 1 FO2 = Fibre-optic cable 2 RC = Remotebus check RD = Remotebus disable UL = Operating voltage for INTERBUS interface
	CPX-specific		M = Parameterisation SF = System fault US1 = Electronics supply, sensor supply US2 = Load supply
Device-specific diagnostics		<ul style="list-style-type: none"> • Diagnostic memory • Channel and module-oriented diagnostics • Module undervoltage 	
Parameterisation		<ul style="list-style-type: none"> • Diagnostic behaviour • Fail-safe response • Forcing of channels • Signal setup • System parameters 	
Additional functions		<ul style="list-style-type: none"> • Module and system parameterisation via operator units • System status can be represented using process data • Additional diagnostic interface for operator units 	
Operating elements		DIL switches	
Operating voltage	Nominal value	[V DC]	24 (polarity-safe)
	Permissible range	[V DC]	18 ... 30
Intrinsic current consumption at nominal operating voltage		[mA]	Typically 90
Protection class to EN 60529		IP65/IP67	
Temperature range	Operation	[°C]	-5 ... +50
	Storage/transport	[°C]	-20 ... +70
CE marking (see declaration of conformity)		To EU EMC Directive	
Housing materials		Aluminium	
Note on materials		RoHS-compliant	
Grid dimension		[mm]	50
Dimensions (incl. interlinking block) W x L x H		[mm]	100 x 110 x 130
Product weight	CPX-FB20	[g]	1,070
	CPX-FB21	[g]	1,255

 Note

Please observe the general limits and guidelines for the system when configuring the electrical modules.

Terminal CPX

Technical data – Bus node CPX-M-FB20/CPX-M-FB21

Connection and display components

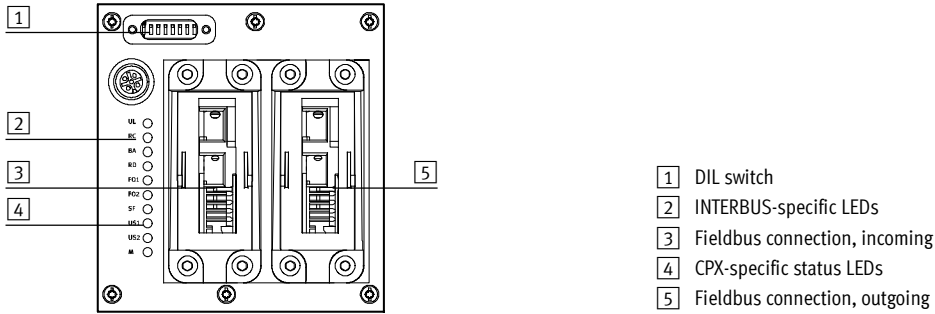



Pin allocation for INTERBUS interface

FOC pin allocation	Pin	Wire colour	Designation
Incoming			
	A	Black	Transmitted data
	B	Orange	Received data
	1	–	24 V supply for electronics and inputs
	2	–	0 V supply for electronics and inputs
	3	–	24 V supply for valves and outputs
4	–	0 V supply for valves and outputs	
5	–	Functional earth	
Outgoing			
	A	Orange	Transmitted data
	B	Black	Received data
	1	–	24 V supply for electronics and inputs
	2	–	0 V supply for electronics and inputs
	3	–	24 V supply for valves and outputs
4	–	0 V supply for valves and outputs	
5	–	Functional earth	

Terminal CPX

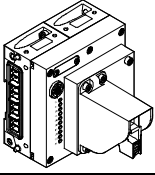
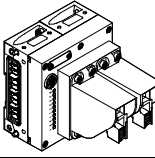
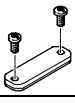
Accessories – Bus node CPX-M-FB20/CPX-M-FB21

Ordering data			
Designation		Part No.	Type
Bus node			
	INTERBUS bus node, incoming fieldbus connection	572334	CPX-M-FB20
	INTERBUS bus node, incoming and outgoing fieldbus connection	572221	CPX-M-FB21
Bus connection			
	Blanking plate for covering the DIL switches	572818	CPX-M-FB21-IB-RL
Manual			
	Manual – Bus nodes CPX-M-FB20 and CPX-M-FB21	German	575107 P.BE-CPX-FB20/21-DE
		English	575108 P.BE-CPX-FB20/21-EN
		Spanish	575109 P.BE-CPX-FB20/21-ES
		French	575110 P.BE-CPX-FB20/21-FR
		Italian	575111 P.BE-CPX-FB20/21-IT
		Swedish	575112 P.BE-CPX-FB20/21-SV

Terminal CPX

Technical data – Bus node CPX-FB23-24



Bus node for handling communication between the electrical CPX terminal and a higher-order master for Control & Communication-Link (CC-Link) from Mitsubishi.

The bus node is provided with system supply via the interlinking block and processes communication with the I/O modules.

The status of the CPX terminal is displayed as a common message via 4 CPX-specific LEDs.

The fieldbus communication status is displayed via 4 CC-Link-specific LEDs.



Application

Bus connection

<p>The bus connection can be selected when ordering and is established by means of a screw terminal with IP20</p>	<p>protection, a Sub-D plug with IP65/IP67 protection from Festo or IP20 protection from other</p>	<p>manufacturers. Both connection types have the function of an integrated T-distributor and</p>	<p>thus support the connection of an incoming and outgoing bus cable.</p>
---	--	--	---

CC-Link implementation

<p>The CPX bus node CPX-FB23-24 optionally supports the CC-Link versions 2.0 (as function module F24) and 1.1. (as function module F23). These designations are also found in the system diagram for the CPX Maintenance Tool (CPX-FMT) or in the operator unit (CPX-MMI-1) from Festo.</p>	<p>Function module F24 corresponds to CC-Link version 2.0 and supports a maximum of four stations per slave, up to an address capacity 32 bytes of digital I/O and 14 bytes of analogue I/O each. It is possible to optimise the configuration of the addressing in terms of either cycle time or station.</p>	<p>Function module F23 corresponds to CC-Link version 1.1 and supports a maximum of four stations per slave, up to an address capacity 64 bytes of digital I/O and 64 bytes of analogue I/O each.</p>	<p>The function module and option are set using the DIL switch on the CPX bus nodes.</p>
---	--	---	--

Points to note in connection with CPX-FEC/CPX-CEC

<p>When a bus node is combined with a control block (CPX-FEC, CPX-CEC, in the fieldbus remote controller operating mode), the connected I/Os and/or valves, sensors and actuators are controlled via the CPX control block.</p>	<p>In this case, the bus node only provides the communication interface to the PLC. Communication between the control block and CPX bus node takes place by interlinking of the CPX modules and</p>	<p>takes up the following address capacity in the CPX system:</p> <ul style="list-style-type: none"> • 8 byte outputs • 8 byte inputs <p>The following address capacity</p>	<p>remains in the control block or CPX system for actuation of the peripherals:</p> <ul style="list-style-type: none"> • 56 byte inputs • 56 byte outputs
---	---	---	---

Terminal CPX

Technical data – Bus node CPX-FB23-24

General technical data				
Type				CPX-FB23-24
Fieldbus interface				Either <ul style="list-style-type: none"> • Sub-D socket, 9-pin • Sub-D plug, for self-assembly • Screw terminal strip, IP20
Baud rates			[kbps]	156 ... 10,000
Protocol				CC-Link
Max. address capacity, inputs	FB23	RWr	[byte]	32
		Rx	[byte]	14
	FB24	RWr	[byte]	64
		Rx	[byte]	64
Max. address capacity, outputs	FB23	RWw	[byte]	32
		Ry	[byte]	14
	FB24	RWw	[byte]	64
		Ry	[byte]	64
LED displays (bus-specific)				RUN = Communication status ERROR = Communication error SD = Send data RD = Receive data
Device-specific diagnostics				<ul style="list-style-type: none"> • Diagnostic memory • Channel and module-oriented diagnostics • Module undervoltage
Parameterisation				<ul style="list-style-type: none"> • Diagnostic behaviour • Fail-safe response • Forcing of channels • Signal setup • System parameters
Additional functions				<ul style="list-style-type: none"> • System status can be displayed using process data • Additional diagnostic interface for operator units
Control elements				DIL switches
Operating voltage	Nominal value		[V DC]	24
	Permissible range		[V DC]	18 ... 30
Current consumption			[mA]	Typically 200
Protection class to EN 60529				IP65/IP67
Temperature range	Operation		[°C]	-5 ... +50
	Storage/transport		[°C]	-20 ... +70
Materials				PA reinforced, PC
Grid dimension			[mm]	50
Dimensions (incl. interlinking block) W x L x H			[mm]	50 x 107 x 50
Product weight			[g]	115

 Note

Please observe the general limits and guidelines for the system when configuring the electrical modules.

Terminal CPX

Technical data – Bus node CPX-FB23-24

Connection and display components

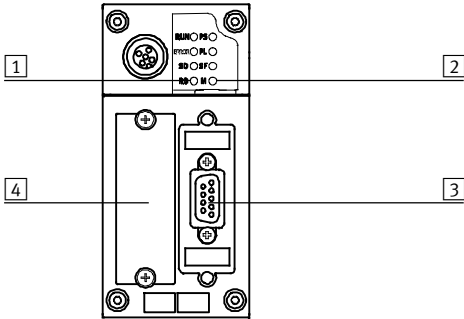

- 1 Bus-specific status LEDs
- 2 CPX-specific status LEDs
- 3 Fieldbus connection (9-pin, Sub-D socket)
- 4 DIL switch cover





Pin allocation for the CC-Link interface

Pin allocation	Pin	Signal	Designation
Sub-D socket			
	1	n.c.	Not connected
	2	DA	Data A
	3	DG	Data reference potential
	4	n.c.	Not connected
	5	FE ¹⁾	Functional earth
	6	n.c.	Not connected
	7	DB	Data B
	8	n.c.	Not connected
	9	n.c.	Not connected
Screw terminal bus connection			
	1	FG	Functional earth/housing
	2	SLD	Screening
	3	DG	Data reference potential
	4	DB	Data B
	5	DA	Data A

Terminal CPX

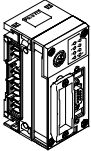
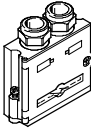
Accessories – Bus node CPX-FB23-24

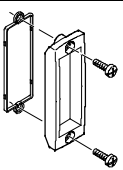
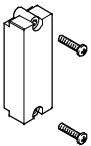
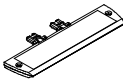

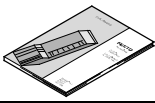
Ordering data			
Description		Part No.	Type
Bus node			
	CC-Link bus node	526176	CPX-FB23-24
Bus connection			
	Sub-D plug	532220	FBS-SUB-9-GS-2x4POL-B
	Screw terminal bus connection	197962	FBA-1-KL-5POL
	Inspection cover, transparent	533334	AK-SUB-9/15-B
	Inspection cover	557010	AK-SUB-9/15
	Inscription label holder for connection block	536593	CPX-ST-1
	Adapter from 5-pin M12 to mini USB socket and controller software	547432	NEFC-M12G5-0.3-U1G5
User documentation			
	User documentation for bus node CPX-FB23-24	German	526403 P.BE-CPX-FB23-24-DE
		English	526404 P.BE-CPX-FB23-24-EN
		Chinese	8026069 P.BE-CPX-FB23-24-ZH

Terminal CPX

Technical data – Bus node CPX-FB32



Bus node for handling communication between the electrical CPX terminal and the EtherNet/IP network.

The bus node is provided with system supply via the interlinking block and processes communication with the I/O modules.

The status of the CPX terminal is displayed as a common message via four CPX-specific LEDs.



Application

Bus connection
The bus connection is established via an M12 plug, D-coded to IEC947-5-2 with IP65/67 protection. EtherNet/IP is an open bus system based on the Ethernet standard and TCP/IP technology (IEEE802.3).

EtherNet/IP implementation
The CPX-FB32 supports the two remote I/O and remote controller operating modes. In remote I/O operating mode, all functions of the CPX valve terminal are directly controlled by the EtherNet/IP master (host). In addition to actuation via a bus system, it is possible to use IT technologies. An integrated web server enables diagnostic data to be visualised via HTML. Various programs support direct access to the data of the device from the automation network. The EtherNet/IP node for CPX supports the transmission technology that conforms to DIN EN 50173/CAT 5.

Special points in combination with CPX-FEC/CPX-CEC
When a bus node is combined with a control block (CPX-FEX, CPX-CEC, in the fieldbus remote controller operating mode), the connected I/Os and/or valves, sensors and actuators are controlled via the CPX control block. In this case, the bus node only provides the communication interface to the PLC. Communication between the control block and CPX bus node is established via the interlinking of the CPX modules and occupies an address capacity of the CPX system of:

- 8 byte outputs
- 8 byte inputs

 The remaining address capacity of the control block or CPX system for actuating the peripherals is:

- 56 byte inputs
- 56 byte outputs

Terminal CPX

Technical data – Bus node CPX-FB32

General technical data		
Type	CPX-FB32	
Fieldbus interface	Plug connector M12, D-coded, 4-pin	
Baud rate	[Mbit/s]	10/100, full/half duplex
IP addressing	Via DHCP, DIL switch or network software	
Max. address capacity, inputs	[byte]	64
Max. address capacity, outputs	[byte]	64
LED displays (bus-specific)	MS = Module status NS = Network status IO = I/O status TP = Link/traffic	
Device-specific diagnostics	System, module and channel-oriented diagnostics	
Parameterisation	<ul style="list-style-type: none"> Start-up parameterisation Asynchronous parameterisation via Explicit Messaging 	
Additional functions	<ul style="list-style-type: none"> Storage of the last 40 errors with timestamp (access via system diagnostics) 8-bit system status in image table for inputs 2-byte I/O, system diagnostics via image table 	
Control elements	DIL switch	
Operating voltage	Nominal value	[V DC] 24
	Permissible range	[V DC] 18 ... 30
	Power failure buffering	[ms] 10
Current consumption	[mA]	Typically 65
Protection class to EN 60529	IP65/IP67	
Temperature range	Operation	[°C] - 5... +50
	Storage/transport	[°C] -20 ... +70
Materials	Polymer	
Grid dimension	[mm]	50
Dimensions (incl. interlinking block) W x L x H	[mm]	50 x 107 x 50
Weight	[g]	125

 - Note

Please observe the general limits and guidelines for the system when configuring the electrical modules.

Terminal CPX

Technical data – Bus node CPX-FB32

Connection and display components

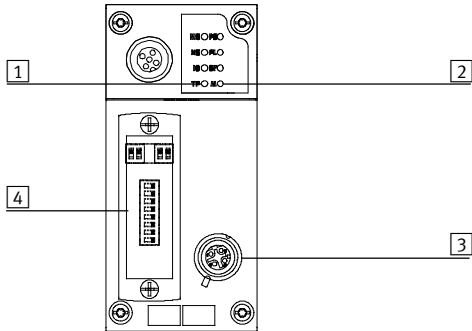

- 1 Bus-specific status LEDs
- 2 CPX-specific status LEDs
- 3 Fieldbus connection
(4-pin socket M12, D-coded)
- 4 Transparent DIL switch cover



Pin allocation for the fieldbus interface

Pin allocation	Pin	Signal	Designation
M12 socket, D-coded			
	1	TD+	Transmitted data+
	2	RD+	Received data+
	3	TD-	Transmitted data-
	4	RD-	Received data-
	Housing		Screened

Terminal CPX

Accessories – Bus node CPX-FB32

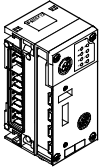
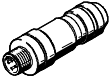
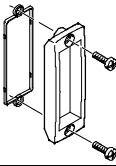
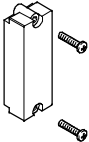
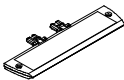

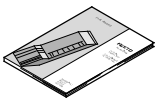
Ordering data			
Designation		Part No.	Type
Bus node			
	EtherNet/IP bus node	541302	CPX-FB32
Bus connection			
	Plug M12x1, 4-pin, D-coded	543109	NECU-M-S-D12G4-C2-ET
	Inspection cover, transparent	533334	AK-SUB-9/15-B
	Inspection cover	557010	AK-SUB-9/15
	Inscription label holder for connection block	536593	CPX-ST-1
	Adapter from 5-pin M12 to mini USB socket and controller software	547432	NEFC-M12G5-0.3-U1G5
User manual			
	User manual for bus node CPX-FB32	German	693134 P.BE-CPX-FB32-DE
		English	693135 P.BE-CPX-FB32-EN
		Spanish	693136 P.BE-CPX-FB32-ES
		French	693137 P.BE-CPX-FB32-FR
		Italian	693138 P.BE-CPX-FB32-IT
		Swedish	693139 P.BE-CPX-FB32-SV

Terminal CPX

Technical data – Bus node CPX-FB33



Bus node for operating the CPX valve terminal on PROFINET.
 The bus node is provided with system supply via the interlinking block and processes communication with the I/O modules.
 The status of the CPX terminal is displayed as a common message via four CPX-specific LEDs.
 The fieldbus communication status is displayed via three bus-specific LEDs.



Application

Bus connection			
The bus connection is established via two M12 sockets, D-coded to IEC61076-2-101 with IP65/67 protection.	Both connections are equivalent 100BaseTX Ethernet ports with integrated auto MDI functionality	(cross-over and patch cables can be used) that are brought together via an internal switch.	<ul style="list-style-type: none"> • Maximum segment length 100 m • Transmission rate 100 Mbit/s

PROFINET implementation

The CPX-FB33 supports the PROFINET protocol on the basis of the Ethernet standard and TCP/IP technology to IEEE802.3. This guarantees a data exchange with a high data transmission rate, for example I/O data from sensors, actuators or robot controllers, PLCs	or process equipment. In addition, non-real-time critical information such as diagnostic information, configuration information, etc. can be transferred. The Ethernet bandwidth is sufficient to transfer both data types (real-time and non-real-time) in parallel.	The bus node features LEDs for bus status and CPX peripheral information as well as switch elements, memory stick and a diagnostic interface. The purpose of the memory stick is to guarantee fast replacement of the bus node in the event of an error. PROFINET provides the user with	access to all peripherals, diagnostic data and parameter data of the CPX valve terminal. The bus node can be used as a remote I/O or remote controller. All information relevant to the CPX can be read out and, depending on the function, changed via an MMI.
---	---	--	---

Special points in combination with CPX-FEC/CPX-CEC

When a bus node is combined with a control block (CPX-FEX, CPX-CEC, in the fieldbus remote controller operating mode), the connected I/Os and/or valves, sensors and actuators are controlled via the CPX control block.	In this case, the bus node only provides the communication interface to the PLC. Communication between the control block and CPX bus node is established	via the interlinking of the CPX modules and occupies an address capacity of the CPX system of: <ul style="list-style-type: none"> • 8 byte outputs • 8 byte inputs 	The remaining address capacity of the control block or CPX system for actuating the peripherals is: <ul style="list-style-type: none"> • 56 byte inputs • 56 byte outputs
--	--	--	---

Terminal CPX

Technical data – Bus node CPX-FB33

General technical data			
Type		CPX-FB33	
Fieldbus interface		2x socket M12, D-coded, 4-pin	
Baud rate		[Mbit/s]	100
Protocol		PROFINET RT	
Max. address capacity	Inputs	[byte]	64
	Outputs	[byte]	64
LED displays	(bus-specific)	NF = Network fault TP1 = Network active port 1 TP2 = Network active port 2	
	(product-specific)	M = Modify, parameterisation PL = Load supply PS = Electronic supply, sensor supply SF = System fault	
Device-specific diagnostics		<ul style="list-style-type: none"> Channel and module-oriented diagnostics Undervoltage of modules Diagnostic memory 	
Configuration support		GSDML file	
Parameterisation		<ul style="list-style-type: none"> System parameters Diagnostic behaviour Signal setup Fail-safe response Forcing of channels 	
Additional functions		<ul style="list-style-type: none"> Start-up parameterisation in plain text via fieldbus Fast startup (FSU) Channel-oriented diagnostics via fieldbus Asynchronous data access via fieldbus System status can be represented using process data Additional diagnostic interface for operator units Asynchronous data access via Ethernet 	
Control elements		<ul style="list-style-type: none"> DIL switch Optional memory card 	
Operating voltage	Nominal value	[V DC]	24
	Permissible range	[V DC]	18 ... 30
Current consumption		[mA]	Typically 120
Temperature range	Operation	[°C]	- 5... +50
	Storage/transport	[°C]	-20 ... +70
Materials	Housing	Die-cast aluminium	
Grid dimension		[mm]	50
Dimensions (incl. interlinking block) W x L x H		[mm]	50 x 107 x 50
Weight		[g]	280

 Note
Please observe the general limits and guidelines for the system when configuring the electrical modules.

 Note
Always use screws appropriate to the interlinking block (metal or plastic):

- Self-tapping screws for plastic interlinking blocks
- Screws with metric thread for metal interlinking blocks

Terminal CPX

Technical data – Bus node CPX-FB33

Connection and display components

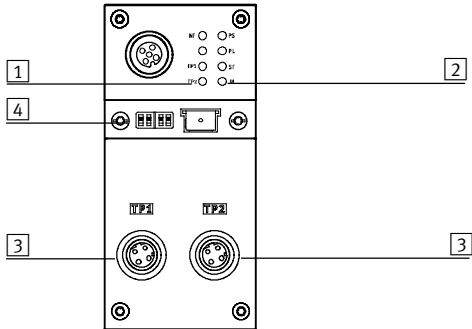

- 1 Bus-specific status LEDs
- 2 CPX-specific status LEDs
- 3 Fieldbus connection
(4-pin socket M12, D-coded)
- 4 Transparent cover for DIL switch
and memory card



Pin allocation for the fieldbus interface

Pin allocation	Pin	Signal	Designation
M12 socket, D-coded			
	1	TD+	Transmitted data+
	2	RD+	Received data+
	3	TD-	Transmitted data-
	4	RD-	Received data-
	Housing		

Terminal CPX

Accessories – Bus node CPX-FB33

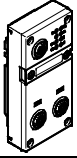
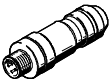
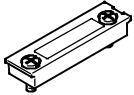
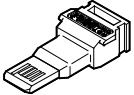
FESTO

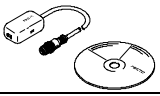
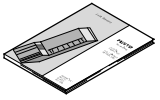
Ordering data			
Designation		Part No.	Type
Bus node			
	PROFINET bus node	548755	CPX-FB33
Bus connection			
	Plug M12x1, 4-pin, D-coded	543109	NECU-M-S-D12G4-C2-ET
	Transparent cover for DIL switch and memory card	548757	CPX-AK-P
	Memory card for PROFINET bus node, 2 MB	568647	CPX-SK-2
	Cover cap for sealing unused bus connections (10 pieces)	165592	ISK-M12
	Screws for attaching an inscription label holder to the bus node (12 pieces)	550222	CPX-M-M2,5X8-12X
	Adapter from 5-pin M12 to mini USB socket and controller software	547432	NEFC-M12G5-0.3-U1G5
User manual			
	Electronics manual, CPX bus node, type CPX-FB33	German	548759 P.BE-CPX-PNIO-DE
		English	548760 P.BE-CPX-PNIO-EN
		Spanish	548761 P.BE-CPX-PNIO-ES
		French	548762 P.BE-CPX-PNIO-FR
		Italian	548763 P.BE-CPX-PNIO-IT
		Swedish	548764 P.BE-CPX-PNIO-SV

Terminal CPX

Technical data – Bus node CPX-M-FB34



Bus node for operating the CPX valve terminal on PROFINET IO. The bus node is provided with system supply via the interlinking block and processes communication with the I/O modules. The status of the CPX terminal is displayed as a common message via four CPX-specific LEDs. The fieldbus communication status is displayed via three bus-specific LEDs.



Application

Bus connection			
The bus connection is established via two RJ45 push-pull sockets to IEC61076-3-106 and IEC60603 with IP65/67 protection.	Both connections are equivalent 100BaseTX Ethernet ports with integrated auto MDI functionality	(cross-over and patch cables can be used) that are brought together via an internal switch.	<ul style="list-style-type: none"> • Maximum segment length 100 m • Transmission rate 100 Mbit/s

PROFINET implementation

The CPX-M-FB34 supports the PROFINET IO protocol based on the Ethernet standard and the TCP/IP technology to IEEE802.3. This guarantees a data exchange with a high data transmission rate, for example I/O data from sensors, actuators or robot controllers, PLCs	or process equipment. In addition, non-real-time critical information such as diagnostic information, configuration information, etc. can be transferred. The Ethernet bandwidth is sufficient to transmit both data types (real-time and non-real-time) in parallel.	The bus node features LEDs for bus status and CPX peripheral information as well as switch elements, memory stick and a diagnostic interface. The purpose of the memory stick is to guarantee fast replacement of the bus node in the event of an error. PROFINET provides the user with	access to all peripherals, diagnostic data and parameter data of the CPX valve terminal. The bus node can be used as a remote I/O or remote controller. All information relevant to the CPX can be read out and, depending on the function, changed via an MMI.
---	---	--	---

Special points in combination with CPX-FEC/CPX-CEC

When a bus node is combined with a control block (CPX-FEX, CPX-CEC, in the fieldbus remote controller operating mode), the connected I/Os and/or valves, sensors and actuators are controlled via the CPX control block.	In this case, the bus node only provides the communication interface to the PLC. Communication between the control block and CPX bus node is established	via the interlinking of the CPX modules and occupies an address capacity of the CPX system of: <ul style="list-style-type: none"> • 8/16 byte outputs • 8/16 byte inputs 	The remaining address capacity of the control block or CPX system for actuating the peripherals is: <ul style="list-style-type: none"> • 56/48 byte inputs • 56/48 byte outputs
--	--	--	---

Terminal CPX

Technical data – Bus node CPX-M-FB34

General technical data			
Type		CPX-M-FB34	
Fieldbus interface		2x RJ45 push-pull socket, AIDA	
Baud rate	[Mbit/s]	100	
Protocol		PROFINET RT	
Max. address capacity	Inputs	[byte]	64
	Outputs	[byte]	64
LED displays	(bus-specific)	NF = Network fault TP1 = Network active port 1 TP2 = Network active port 2	
	(product-specific)	M = Modify, parameterisation PL = Load supply PS = Electronic supply, sensor supply SF = System fault	
Device-specific diagnostics		<ul style="list-style-type: none"> Channel and module-oriented diagnostics Undervoltage of modules Diagnostic memory 	
Configuration support		GSDML file	
Parameterisation		<ul style="list-style-type: none"> System parameters Diagnostic behaviour Signal setup Fail-safe response Forcing of channels 	
Additional functions		<ul style="list-style-type: none"> Start-up parameterisation in plain text via fieldbus Fast startup (FSU) Channel-oriented diagnostics via fieldbus Asynchronous data access via fieldbus and via Ethernet System status can be represented using process data Additional diagnostic interface for operator units 	
Control elements		DIL switch, optional memory card	
Operating voltage	Nominal value	[V DC]	24
	Permissible range	[V DC]	18 ... 30
Intrinsic current consumption at nominal operating voltage		[mA]	Typically 120
Protection class to EN 60529		IP65, IP67	
Temperature range	Operation	[°C]	- 5... +50
	Storage/transport	[°C]	-20 ... +70
Material of housing		Die-cast aluminium	
Grid dimension		[mm]	50
Dimensions (incl. interlinking block) W x L x H		[mm]	50 x 107 x 80
Weight		[g]	280

 Note
Please observe the general limits and guidelines for the system when configuring the electrical modules.

 Note
Always use screws appropriate to the interlinking block (metal or plastic):

- Self-tapping screws for plastic interlinking blocks
- Screws with metric thread for metal interlinking blocks

Terminal CPX

Technical data – Bus node CPX-M-FB34

Connection and display components

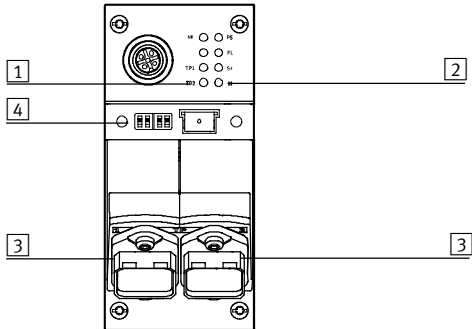

- 1 Bus-specific status LEDs
- 2 CPX-specific status LEDs
- 3 Fieldbus connection (8-pin RJ45 socket)
- 4 DIL switch and memory card





Pin allocation for the fieldbus interface

Pin allocation	Pin	Signal	Designation
RJ45 plug			
	1	TD+	Transmitted data+
	2	TD-	Transmitted data-
	3	RD+	Received data+
	4	n.c.	Not connected
	5	n.c.	Not connected
	6	RD-	Received data-
	7	n.c.	Not connected
	8	n.c.	Not connected
Housing	Screened	Screened	Screened

Terminal CPX

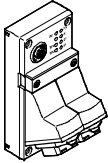
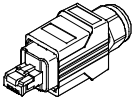
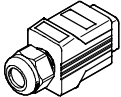
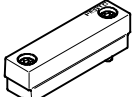
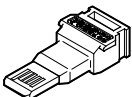
Accessories – Bus node CPX-M-FB34

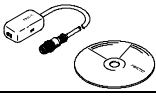

Ordering data			
Designation		Part No.	Type
Bus node			
	PROFINET IO bus node	548751	CPX-M-FB34
Bus connection			
	RJ45 plug, 8-pin, push-pull	552000	FBS-RJ45-PP-GS
	Cover cap for bus connection	548753	CPX-M-AK-C
	Cover for DIL switch and memory card	548754	CPX-M-AK-M
	Memory card for PROFINET bus node, 2 MB	568647	CPX-SK-2
	Screws for attaching an inscription label holder to the bus node (12 pieces)	550222	CPX-M-M2,5X8-12X
	Adapter from 5-pin M12 to mini USB socket and controller software	547432	NEFC-M12G5-0.3-U1G5
User manual			
	Electronics manual, CPX bus node, type CPX-M-FB34	German	548759 P.BE-CPX-PNIO-DE
		English	548760 P.BE-CPX-PNIO-EN
		Spanish	548761 P.BE-CPX-PNIO-ES
		French	548762 P.BE-CPX-PNIO-FR
		Italian	548763 P.BE-CPX-PNIO-IT
		Swedish	548764 P.BE-CPX-PNIO-SV

Terminal CPX

Technical data – Bus node CPX-M-FB35



Bus node for operating the CPX valve terminal on PROFINET IO.
 The bus node is provided with system supply via the interlinking block and processes communication with the I/O modules.
 The status of the CPX terminal is displayed as a common message via four CPX-specific LEDs.
 The fieldbus communication status is displayed via three bus-specific LEDs.



Application

Bus connection			
The bus connection is established via two SCRJ push-pull sockets to IEC61754-24 (fibre-optic cable, AIDA standard) to IP65/67.	Both connections are equivalent 100BaseFX Ethernet ports that are brought together via an internal switch.	Fibre-optic cables made from plastic (POF, 980/1000 µm) are suitable for use as the transmission medium.	<ul style="list-style-type: none"> • Maximum segment length 50 m • Baud rate 100 Mbit/s • Supports LLDP and SNMP

PROFINET implementation

The CPX-M-FB35 supports the PROFINET IO protocol based on the Ethernet standard and the TCP/IP technology to IEEE802.3. This guarantees data exchange with a high data transmission rate, for example I/O data from sensors, actuators or robot controllers, PLCs or	process equipment. Furthermore, non real-time critical information such as diagnostic information, configuration information, etc. can be transferred. The Ethernet bandwidth is sufficient to transmit both data types (real-time and non real-time) in parallel.	The bus node features LEDs for bus status and CPX peripheral information as well as switch elements, memory stick and a diagnostic interface. The purpose of the memory stick is to guarantee fast replacement of the bus node in the event of an error. PROFINET provides the user with	access to all peripherals, diagnostic data and parameter data of the CPX valve terminal. The bus node can be used as a remote I/O or remote controller. All information relevant to the CPX can be read out and, depending on the function, changed via an MMI.
--	--	--	---

Points to note in connection with CPX-FEC/CPX-CEC

When combining a fieldbus node with a control block (CPX-FEC, CPX-CEC, in bus remote controller operating mode), the connected I/Os or valves, sensors and actuators are controlled via the CPX control block.	In this case, the bus node only provides the communication interface to the PLC. Communication between the control block and CPX bus node takes place	via interlinking of the CPX modules and takes up the following address capacity in the CPX system: <ul style="list-style-type: none"> • 8/16 byte outputs • 8/16 byte inputs 	The following address capacity remains in the control block or CPX system for actuation of the peripherals: <ul style="list-style-type: none"> • 56/48 byte inputs • 56/48 byte outputs
--	---	--	---

Terminal CPX

Technical data – Bus node CPX-M-FB35

General technical data			
Type		CPX-M-FB35	
Fieldbus interface		2x SCRJ push-pull socket, AIDA	
Baud rate		[Mbit/s]	100
Protocol		PROFINET RT	
Max. address capacity	Inputs	[byte]	64
	Outputs	[byte]	64
LED displays	(bus-specific)	NF = Network fault TP1 = Network active port 1 TP2 = Network active port 2	
	(product-specific)	M = Modify, parameterisation PL = Load supply PS = Electronic supply, sensor supply SF = System fault	
Device-specific diagnostics		<ul style="list-style-type: none"> • Channel and module-oriented diagnostics • Undervoltage of modules • Diagnostic memory 	
Configuration support		GSDML file	
Parameterisation		<ul style="list-style-type: none"> • System parameters • Diagnostic behaviour • Signal setup • Fail-safe response • Forcing of channels 	
Additional functions		<ul style="list-style-type: none"> • Start-up parameterisation in plain text via fieldbus • Fast start-up (FSU) • Channel-oriented diagnostics via fieldbus • Acyclic data access via fieldbus and via Ethernet • System status can be represented using process data • Additional diagnostic interface for operator unit 	
Operating elements		DIL switch, optional memory card	
Operating voltage	Nominal value	[V DC]	24
	Permissible range	[V DC]	18 ... 30
Intrinsic current consumption at nominal operating voltage		[mA]	Typically 150
Protection class to EN 60529		IP65, IP67	
Temperature range	Operation	[°C]	- 5 ... +50
	Storage/transport	[°C]	-20 ... +70
Housing material		Die-cast aluminium	
Note on materials		RoHS-compliant	
Grid dimension		[mm]	50
Dimensions (incl. interlinking block) W x L x H		[mm]	50 x 107 x 80
Product weight		[g]	280

 - Note
Please observe the general limits and guidelines for the system when configuring the electrical modules.

 - Note
Always use screws appropriate to the interlinking block (metal or plastic):

- Self-tapping screws for plastic interlinking blocks
- Screws with metric thread for metal interlinking blocks

Terminal CPX

Technical data – Bus node CPX-M-FB35

Connection and display components

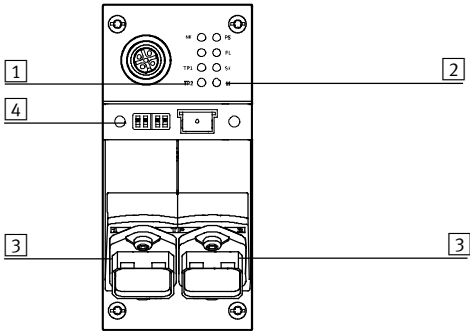

- 1 Bus-specific status LEDs
- 2 CPX-specific status LEDs
- 3 Fieldbus connection (2-pin SCRJ socket)
- 4 DIL switch and memory card



Pin allocation for the fieldbus interface

Pin allocation	Pin	Signal	Designation
	1	Tx	Outgoing
	2	Rx	Incoming

Terminal CPX

Accessories – Bus node CPX-M-FB35

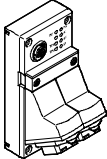
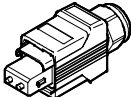
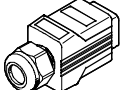
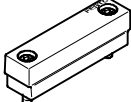
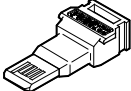
FESTO

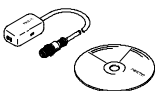
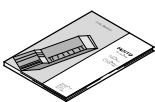
Ordering data			
Designation		Part No.	Type
Bus node			
	PROFINET IO bus node	548749	CPX-M-FB35
Bus connection			
	Plug SCRJ, 2-pin, push-pull	571017	FBS-SCRJ-PP-GS
	Cover cap for bus connection	548753	CPX-M-AK-C
	Cover for DIL switch and memory card	548754	CPX-M-AK-M
	Memory card for PROFINET bus node, 2 MB	568647	CPX-SK-2
	Screws for attaching an inscription label holder to the bus node (12 pieces)	550222	CPX-M-M2,5X8-12X
	Adapter from 5-pin M12 to mini USB socket and controller software	547432	NEFC-M12G5-0.3-U1G5
Manual			
	Electronics manual, CPX bus node, type CPX-M-FB35	German	548759 P.BE-CPX-PNIO-DE
		English	548760 P.BE-CPX-PNIO-EN
		Spanish	548761 P.BE-CPX-PNIO-ES
		French	548762 P.BE-CPX-PNIO-FR
		Italian	548763 P.BE-CPX-PNIO-IT
		Swedish	548764 P.BE-CPX-PNIO-SV

Terminal CPX

Technical data – Bus node CPX-FB36



IT services:



Bus node for handling communication between the electrical terminal CPX and the EtherNet/IP network.

The bus node is provided with system supply via the interlinking block and processes communication with the I/O modules.

The status of the terminal CPX is displayed as a common message via 4 CPX-specific LEDs.



Application

Bus connection

The bus connection is established via an M12 plug, D-coded to IEC947-5-2 with IP65/67 protection.

EtherNet/IP is an open bus system based on the Ethernet standard and TCP/IP technology (IEEE802.3).

EtherNet/IP implementation

The CPX-FB36 supports the two operating modes: remote I/O and remote controller. In remote I/O operating mode, all functions of the CPX valve terminal are

directly controlled by the EtherNet/IP master (host). In addition to actuation via a bus system, it is possible to use IT technologies. An integrated web server

enables diagnostic data to be visualised via HTML. Various programs support direct access to the data of the device from the automation

network. The EtherNet/IP node for CPX supports the transmission technology that conforms to DIN EN 50173/CAT 5.

Points to note in connection with CPX-FEC/CPX-CEC

When combining a bus node with a control block (CPX-FEC, CPX-CEC, in fieldbus remote controller operating mode), the connected I/Os or valves, sensors and actuators are controlled via the CPX control block.

In this case, the bus node only provides the communication interface to the PLC. Communication between the control block and CPX bus node takes place via interlinking of the CPX modules

and takes up the following address capacity in the CPX system:

- 8 byte outputs
- 8 byte inputs

The following address capacity

remains in the control block or CPX system for actuation of the peripherals:

- 56 byte inputs
- 56 byte outputs

Terminal CPX

Technical data – Bus node CPX-FB36

General technical data			
Type	CPX-FB36		
Fieldbus interface	2x M12x1 socket, D-coded, 4-pin		
Baud rates	[Mbit/s]	10/100	
IP addressing	Via DHCP, DIL switch or network software		
Max. address capacity, inputs	[byte]	64	
Max. address capacity, outputs	[byte]	64	
LED displays (bus-specific)	MS = Module status NS = Network status TP1 = Network active port 1 TP2 = Network active port 2		
Device-specific diagnostics	<ul style="list-style-type: none"> • Module and channel-oriented diagnostics • Module undervoltage • Diagnostic memory 		
Parameterisation	<ul style="list-style-type: none"> • Diagnostic behaviour • Fail-safe response • Forcing of channels • Idle mode characteristics • Signal setup • System parameters 		
Additional functions	<ul style="list-style-type: none"> • EtherNet/IP Quickconnect • Ring topology (DLR) • Acyclic data access via "Explicit Message" and Ethernet • Integrated switch • Channel-oriented diagnostics via fieldbus • Start-up parameterisation in plain text via fieldbus • System status can be represented using process data • Additional diagnostic interface for operator units 		
Control elements	DIL switches		
Operating voltage	Nominal value	[V DC]	24
	Permissible range	[V DC]	18 ... 30
Current consumption (at nominal voltage, without MMI)	[mA]	Typically 100	
Protection class to EN 60529	IP65, IP67		
Temperature range	Operation	[°C]	-5 ... +50
	Storage/transport	[°C]	-20 ... +70
Materials	PA reinforced		
Note on materials	RoHS-compliant		
Grid dimension	[mm]	50	
Dimensions (incl. interlinking block) W x L x H	[mm]	50 x 107 x 50	
Product weight	[g]	125	

 **Note**

Please observe the general limits and guidelines for the system when configuring the electrical modules.

Terminal CPX

Technical data – Bus node CPX-FB36

Connection and display components

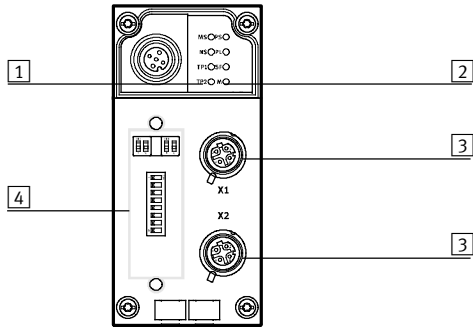

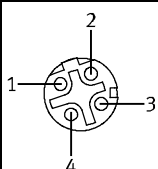

- 1 Bus-specific status LEDs
- 2 CPX-specific status LEDs
- 3 Fieldbus connection (4-pin socket M12, D-coded)
- 4 Transparent DIL switch cover

Pin allocation for the fieldbus interface

Pin allocation	Pin	Signal	Designation
M12 socket, D-coded			
	1	TD+	Transmitted data+
	2	RD+	Received data+
	3	TD-	Transmitted data-
	4	RD-	Received data-
	Housing	FE	Screening

Terminal CPX

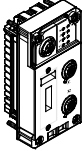
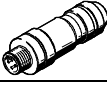
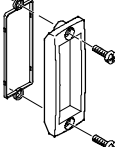
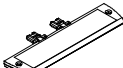
Accessories – Bus node CPX-FB36

Ordering data				
Designation		Part No.	Type	
Bus node				
	EtherNet/IP bus node	1912451	CPX-FB36	
Bus connection				
	Plug M12x1, 4-pin, D-coded	543109	NECU-M-S-D12G4-C2-ET	
	Inspection cover, transparent	533334	AK-SUB-9/15-B	
	Inscription label holder for connection block	536593	CPX-ST-1	
	5-pin M12 to mini USB socket adapter and controller software	547432	NEFC-M12G5-0.3-U1G5	
Manual				
	Electronics manual, CPX bus node, type CPX-FB36	German	8024074	P.BE-CPX-FB36-DE
		English	8024075	P.BE-CPX-FB36-EN
		Spanish	8024076	P.BE-CPX-FB36-ES
		French	8024077	P.BE-CPX-FB36-FR
		Italian	8024078	P.BE-CPX-FB36-IT
		Chinese	8024079	P.BE-CPX-FB36-ZH

Terminal CPX

Technical data – Bus node CPX-FB38



Bus node for operating the CPX valve terminal on EtherCAT. The bus node is provided with system supply via the interlinking block and processes communication with the I/O modules. The status of the CPX terminal is displayed as a common message via four CPX-specific LEDs. The fieldbus communication status is displayed via four bus-specific LEDs.



Application

Bus connection			
The bus connection is established via two M12 sockets, D-coded to IEC61076-2-101 with IP65/67 protection.	Both connections are equivalent 100BaseTX Ethernet ports with integrated auto MDI functionality	(cross-over and patch cables can be used) that are brought together via an internal switch.	<ul style="list-style-type: none"> • Maximum segment length 100 m • Transmission rate 100 Mbit/s

EtherCAT implementation

The CPX-FB38 supports the EtherCAT protocol based on the Ethernet standard and the TCP/IP technology to IEEE802.3. This guarantees a data exchange with a high data transmission rate, for example I/O data from sensors,	actuators or robot controllers, PLCs or process equipment. In addition, non-real-time critical information such as diagnostic information, configuration information, etc. can be transferred.	<p>The data bandwidth is sufficient to transmit both data types (real-time and non-real-time) in parallel.</p> <p>The bus node features LEDs for bus status and CPX peripheral information as well as switch elements and</p>	a diagnostic interface. The bus node can be used as a remote I/O or remote controller. All information relevant to the CPX can be read out and, dependent on the function, changed via an MMI/FMT.
---	--	---	--

Special points in combination with CPX-FEC/CPX-CEC

When a bus node is combined with a control block (CPX-FEX, CPX-CEC, in the fieldbus remote controller operating mode), the connected I/Os and/or valves, sensors and actuators are controlled via the CPX control block.	<p>In this case, the bus node only provides the communication interface to the PLC.</p> <p>Communication between the control block and CPX bus node is established</p>	<p>via the interlinking of the CPX modules and occupies an address capacity of the CPX system of:</p> <ul style="list-style-type: none"> • 8 byte outputs • 8 byte inputs 	<p>The remaining address capacity of the control block or CPX system for actuating the peripherals is:</p> <ul style="list-style-type: none"> • 56 byte inputs • 56 byte outputs
--	--	---	--

Terminal CPX

Technical data – Bus node CPX-FB38

General technical data			
Type	CPX-FB38		
Fieldbus interface	Two plug connectors M12, D-coded, 4-pin		
Baud rate	[Mbit/s]	100	
Max. address capacity, inputs	[byte]	64	
Max. address capacity, outputs	[byte]	64	
LED displays	(bus-specific)	Error = Communication error L/A1 = Network active port 1 L/A2 = Network active port 2 Run = Communication status	
	(product-specific)	M = Modify, parameterisation PL = Load supply PS = Electronic supply, sensor supply SF = System fault	
Device-specific diagnostics	<ul style="list-style-type: none"> • Channel and module-oriented diagnostics • Undervoltage of modules • Diagnostic memory 		
Configuration support	XML file		
Parameterisation	<ul style="list-style-type: none"> • System parameters • Diagnostic behaviour • Signal setup • Fail-safe response • Forcing of channels 		
Additional functions	<ul style="list-style-type: none"> • System status can be represented using process data • Additional diagnostic interface for operator units 		
Control elements	DIL switch		
Operating voltage	Nominal value	[V DC]	24
	Permissible range	[V DC]	18 ... 30
	Power failure buffering	[ms]	10
Current consumption	[mA]		Typically 100
Protection class to EN 60529	IP65/IP67		
Temperature range	Operation	[°C]	- 5... +50
	Storage/transport	[°C]	-20 ... +70
Materials	Housing	Reinforced polyamide	
Grid dimension	[mm]	50	
Dimensions (incl. interlinking block) W x L x H	[mm]	50 x 107 x 50	
Weight	[g]	125	

 Note

Please observe the general limits and guidelines for the system when configuring the electrical modules.

 Note

Always use screws appropriate to the interlinking block (metal or plastic):

- Self-tapping screws for plastic interlinking blocks

- Screws with metric thread for metal interlinking blocks

Terminal CPX

Technical data – Bus node CPX-FB38

Connection and display components

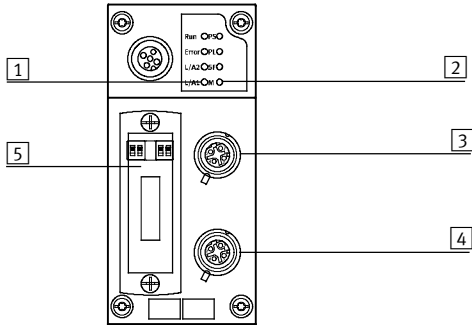





- 1 Bus-specific status LEDs
- 2 CPX-specific status LEDs
- 3 Fieldbus connection, output (4-pin socket M12, D-coded)
- 4 Fieldbus connection, input (4-pin socket M12, D-coded)
- 5 Transparent DIL switch cover

Pin allocation for the fieldbus interface

Pin allocation	Pin	Signal	Designation
M12 socket, D-coded			
	1	TD+	Transmitted data+
	2	RD+	Received data+
	3	TD-	Transmitted data-
	4	RD-	Received data-
	Housing		

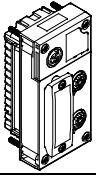
Terminal CPX

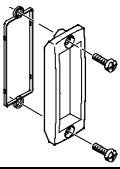
Accessories – Bus node CPX-FB38

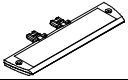
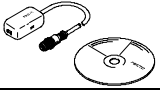
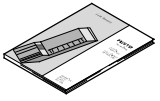
Ordering data			
Designation		Part No.	Type
Bus node			
	EtherCAT bus node	552046	CPX-FB38
Bus connection			
	M12x1 plug, 4-pin, D-coded	543109	NECU-M-S-D12G4-C2-ET
	Inspection cover, transparent	533334	AK-SUB-9/15-B
	Cover cap for sealing unused bus connections (10 pieces)	165592	ISK-M12
	Inscription label holder for connection block	536593	CPX-ST-1
	Adapter from 5-pin M12 to mini USB socket and controller software	547432	NEFC-M12G5-0.3-U1G5
User manual			
	Electronics manual, CPX bus node, type CPX-FB38	German	562524 P.BE-CPX-FB38-DE
		English	562525 P.BE-CPX-FB38-EN
		Spanish	562526 P.BE-CPX-FB38-ES
		French	562527 P.BE-CPX-FB38-FR
		Italian	562528 P.BE-CPX-FB38-IT
		Swedish	562529 P.BE-CPX-FB38-SV

Terminal CPX

Technical data – CPX-CP interface

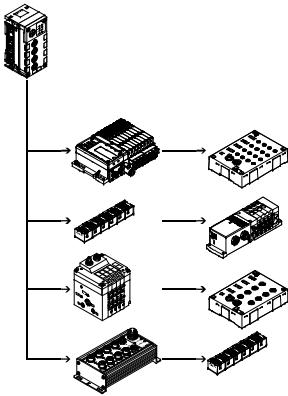

The CPX-CP electrical interface establishes the connection to CP modules of the CPI installation system via prefabricated cables. The I/O data of the connected valve terminals with CP string extension and CP input and output modules are transferred to the connected CPX bus node and thus via fieldbus to the higher-order controller. This enables modular centralised and compact decentralised concepts to be established with one system. The CP electrical interface is supported by all CPX bus nodes and the CPX-FEC.



Application

CP connection

As well as transmitting the communication data, the max. four CP strings of a CPX-CP interface also transmit the supply voltage to the connected sensors and the load supply to the valves (or outputs). Both circuits are

supplied separately with 24 V, but with a common reference potential. The valve terminals with CP string extension (or outputs) are supplied with voltage for the electronics and valves by the interlinking block.

The following combinations are made possible by the CP interface:

- Centralised analogue and digital inputs and outputs of the CPX terminal
- Decentralised digital inputs and outputs of the CP installation system
- Valve/valve terminals that can be connected both centrally and decentrally

Configuration example – CP interface with CP modules

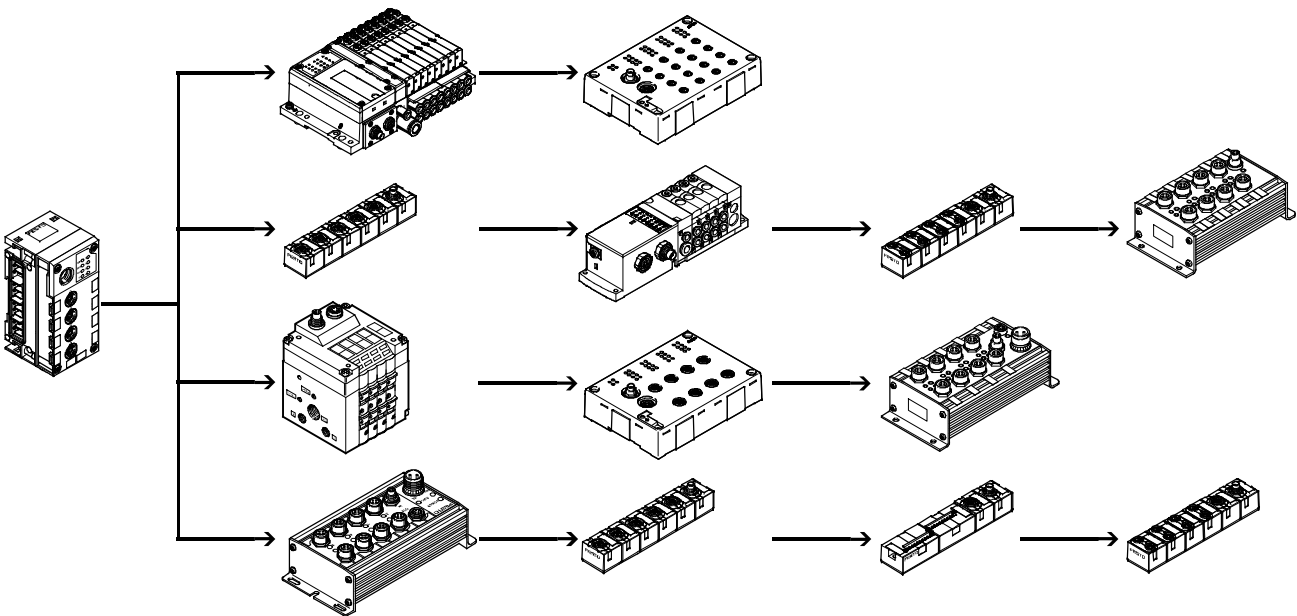

Terminal CPX

Technical data – CPX-CP interface

FESTO

Implementation

The CPX-CP interface supports the CPI system:

- Max. 4 individual electronically protected CP strings
- Max. 4 CP modules per string
- Max. 32 inputs/32 outputs per string
- The maximum length of a string is 10 m. If the CP interface is positioned centrally, the CP system can cover an area of 20 m in diameter
- Modules with CPI functionality

The following CP module variants are available:

- Input modules with 8 or 16 digital inputs (connection technology M8, M12 and CageClamp)
- Output modules with 4 or 8 digital outputs (connection technology M12)
- Valve terminals with CP string extension (up to 32 solenoid coils, different valve functions)

CPI modules support the following functions:

- Module-oriented diagnostics
- Module/channel-oriented parameterisation
- Support for all functions by the CPX-MMI or CPX-FMT operator unit
- Module can be positioned anywhere within the string

Several CP interface modules can be combined in one CPX terminal, depending on the address capacity of the bus node.

Example:

- CPX-FB13 (512 I/O)
- Max. 4 CP interface modules (128 I/O each) possible

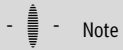

Note

When arranging the CP modules it should be taken into consideration that CP input modules without CPI functionality should always be placed at the end of a string.

Configuration

The following rules apply for a string of a CPX-CP interface:

- Max. one output module or one valve terminal without CPI functionality
- Max. one output module without CPI functionality or one valve terminal with CP string extension
- Any number of CP modules with CPI functionality, up to the maximum limit of 4 modules and/ or 32 inputs/32 outputs per string

Maximum extension:

- 4 input modules and 4 valve terminals/output modules without CPI functionality
- 16 CP modules with CPI functionality

The configuration of the strings with respect to the module type and position of the modules in the string is entered by activating the SAVE key in the CPX-CP interface and saved there permanently.

Saved data are retained even when the CP interface is isolated from the voltage supply.

The representation of the CP interface within a CPX terminal and thus at the fieldbus is dependent on the characteristics of the relevant fieldbus system. In addition to input and output addressing, this also applies to the representation of the diagnostics and parameterisation of the CP module and the characteristics of the CPI system.



Note

The remanent saving of configuration data means that changes in the configuration or faulty modules are still displayed even after a voltage failure.

Terminal CPX

Technical data – CPX-CP interface

FESTO

General technical data			
Type	CPX-CP-4-FB		
Brief description		CP interface	
Max. number of	CP strings	4	
	CP modules per string	4	
	Outputs per string	32	
	Inputs per string	32	
CP connection		M9 socket, 5-pin	
Baud rate	[kbit/s]	1,000	
Cycle time	CP modules without CPI functionality	[ms]	4
	CP modules with CPI functionality	[ms]	2
LED displays		L1 ... 4 = Status of the CP string 1 ... 4 PS = Electronic supply, sensor supply PL = Load supply RN = Status of the CP system SF = System fault	
Device-specific diagnostics		Via bus node	
Operating voltage	Nominal value	[V DC]	24 (reverse polarity protected)
	Permissible range	[V DC]	18 ... 30
	Power failure buffering	[ms]	20
Supply voltage of sensors		[V DC]	24 ±25% coming from bus node
Load voltage of actuators		[V DC]	24 ±10% coming from bus node
Current consumption	Without CP modules	[A]	Max. 0.2
	Per CP string	[A]	Max. 1.6
Protection class to EN 60529		IP65/IP67	
Temperature range	Operation	[°C]	-5 ... +50
	Storage/transport	[°C]	-20 ... +70
Materials		Polyamide	
Grid dimension		[mm]	50
Dimensions (incl. interlinking block) W x L x H		[mm]	50 x 107 x 45
Weight		[g]	140

-  - Note

Please observe the general limits and guidelines for the system when configuring the electrical modules.

Terminal CPX

Accessories CPX-CP interface

Connection and display components

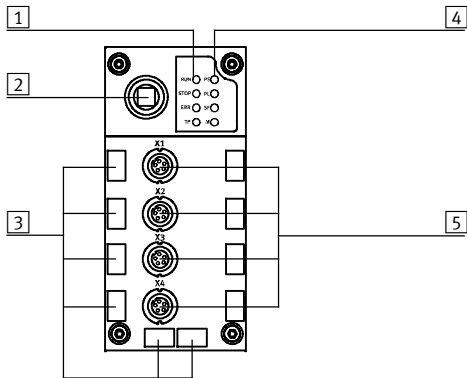

- 1 CP string LEDs
- 2 SAVE key
- 3 Holders for inscription labels (IBS 6x10)
- 4 CPX-specific status LEDs
- 5 CP connections for up to 4 strings (0 ... 3)

Power supply

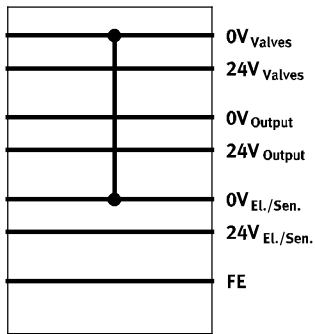





The module combines the 0 V potential of the power supply for electronics and sensors with the 0 V potential of the power supply for valves.
 If all poles of the valves of a pneumatic interface connected to the right of the CP interface are to be switched off, an appropriate interlinking block with additional power supply must be used to the right of the CP interface.

Terminal CPX

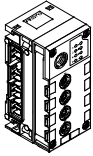
Accessories CPX-CP interface

FESTO

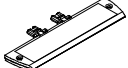
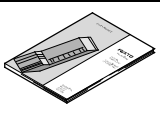
Ordering data				
Designation			Part No.	Type
CP interface				
	Interface for max. 16 I/O modules and valve terminals of the CPI system		526705	CPX-CP-4-FB
Bus connection				
	Cover cap	M9	356684	FLANSCHDOSE SER.712
		M12	165592	ISK-M12
	Connecting cable WS-WD	0.25 m	540327	KVI-CP-3-WS-WD-0,25
		0.5 m	540328	KVI-CP-3-WS-WD-0,5
		2 m	540329	KVI-CP-3-WS-WD-2
		5 m	540330	KVI-CP-3-WS-WD-5
		8 m	540331	KVI-CP-3-WS-WD-8
	Connecting cable GS-GD	2 m	540332	KVI-CP-3-GS-GD-2
		5 m	540333	KVI-CP-3-GS-GD-5
		8 m	540334	KVI-CP-3-GS-GD-8
	Inscription label holder for connection block		536593	CPX-ST-1
User manual				
	User manual for CPX-CP interface	German	539293	P.BE-CPX-CP-DE
		English	539294	P.BE-CPX-CP-EN
		Spanish	539295	P.BE-CPX-CP-ES
		French	539296	P.BE-CPX-CP-FR
		Italian	539297	P.BE-CPX-CP-IT
		Swedish	539298	P.BE-CPX-CP-SV

Terminal CPX

Technical data – Interface CPX-CTEL

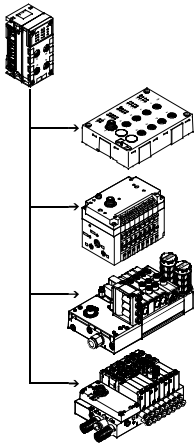

The electrical interface CPX-CTEL master establishes the connection to modules with I-Port interface (device) from the CTEL/CTEU series. The I/O data from the connected devices is transferred to the connected CPX bus node and therefore transferred to the higher-level controller via fieldbus. A maximum of 4 devices can be connected to a CPX-CTEL master via appropriate M12- interfaces.



Application

I-Port interface

As well as transmitting the communication data, the I-Port interfaces of a CPX-CTEL master also transmit the power supply for the

connected sensors and the load supply for the valves (or outputs). Both circuits are supplied separately

with 24 V, with a separate reference potential. The connecting cables used must meet

the increased requirements resulting from their double function as a signal line and power supply cable.

Sample configuration – CPX-CTEL master with CTEL modules

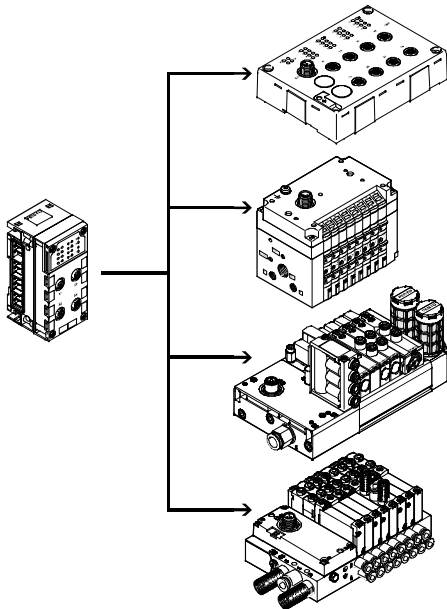

The CPX-CTEL master provides four I-Port interfaces to which one device each can be connected. I-Port is an interface for exchanging serial data for connecting decentralised modules or valve terminals from Festo. The I-Port interface is based on IO-Link and is compatible with it in certain areas. The connection type corresponds to a star topology. In other words, only one module or valve terminal can be connected to each I-Port.

The restrictions compared to IO-Link include:

- Permanently set baud rate of 230.4 kbit/s
- SIO mode is not supported
- Max. 32 bytes of input data and 32 bytes of output data
- Only one dump of the master commands is used
- Configuration via IODD is not supported

Terminal CPX

Technical data – Interface CPX-CTEL

Implementation

<p>The CPX-CTEL master from Festo enables modules with an I-Port interface to be connected to a CPX system:</p> <ul style="list-style-type: none">• Max. 4 devices with individual electronic fuse protection• Max. 64 inputs/64 outputs per I-Port interface• The maximum length of a string is 20 m	<p>The following device variants are available:</p> <ul style="list-style-type: none">• Input modules with 16 digital inputs (3-pin M8 and 5-pin M12 connection technology)• Valve terminals with I-Port interface (up to 48 solenoid coils, different valve functions)	<p>The decentralised arrangement of the modules and valve terminals with I-Port enables them to be mounted near the cylinders and actuators/sensors to be controlled. This allows the use of shorter air supply lines and sensor cables or possibly smaller valves, which saves costs.</p>	<p>Several CPX-CTEL masters can be combined in one CPX terminal, depending on the address capacity of the bus node.</p> <p>Example:</p> <ul style="list-style-type: none">• CPX-FB13 (512 I/O)• Max. 2 CPX-CTEL masters (256 I/O each) possible
---	--	--	--

Configuration

Setting	Manual configuration	Automatic configuration	
<p>The precise number of I/O bytes made available is geared towards the requirements of the connected devices and the selected operating mode. The operating mode and configuration presetting of the CPX-CTEL master can be defined by the user. DIL switches are used for selecting the operating mode and making the setting for manual configuration. These DIL switches are not required during operation and are only accessible in unassembled condition.</p>	<p>With manual configuration (tool change mode), the number of inputs and outputs in the process image of the CPX system or higher-level fieldbus can be manually defined via the DIL switches.</p>	<p>The process image then always has the same number of bytes, regardless of the connected devices. The defined I/O length always applies to all four I-Ports (max. 8 bytes per I-Port).</p>	<p>With automatic configuration, the I/O length for each I-Port is individually determined and this value is used to select the appropriate or next highest configuration presetting.</p>

Power supply for I-Port devices

<p>The CPX-CTEL master provides two separate power supplies for the connected devices:</p> <ul style="list-style-type: none">• One for operating the device and the inputs connected to it• One for outputs and valves connected to the device	<p>The power supply for devices and inputs comes from the power supply for the electronics and sensors of the CPX terminal. The power supply for outputs and valves comes from the power supply</p>	<p>for the valves of the CPX terminal. The interlinking block with additional power supply enables a separate voltage supply for valves and outputs. This allows this supply voltage to be</p>	<p>switched off separately. In other words, the valves and outputs of the connected I-Port devices can be switched off separately without having to switch off the devices themselves.</p>
---	---	--	--

Terminal CPX

Technical data – Interface CPX-CTEL

FESTO

General technical data			
Type		CPX-CTEL-4-M12-5POL	
Protocol		I-Port	
Max. address capacity	Outputs	[bit]	256
	Inputs	[bit]	256
I-Port connection		4x M12 socket, 5-pin, A-coded	
Number of I-Port interfaces		4	
Max. cable length		[m]	20
Internal cycle time		[ms]	1 per 8 bits of user data
Electrical isolation	Channel – channel		No
	Channel – internal bus		Yes, using an intermediate supply
LED displays		X1 ... 4 = Status of the I-Port interface 1 ... 4 PS = Electronics supply PL = Load supply L = Module fault	
Diagnostics		<ul style="list-style-type: none"> • Communication error • Module short circuit • Module-oriented diagnostics • Undervoltage 	
Parameterisation		<ul style="list-style-type: none"> • Diagnostic behaviour • Failsafe per channel • Forces per channel • Idle mode per channel • Module parameters • Tool change mode 	
Additional functions		Tool change mode	
Operating elements		DIL switch	
Operating voltage	Nominal value		[V DC] 24 (reverse polarity protected)
	Permissible range		[V DC] 18 ... 30
	Power failure buffering		[ms] 10
Intrinsic current consumption at nominal operating voltage		[mA]	Typically 65
Max. power supply per channel		[A]	4x 1.6
Max. residual output current per channel		[A]	4x 1.6
Protection class to EN 60529		IP65/IP67	
Temperature range	Operating		[°C] –5 ... +50
	Storage/transport		[°C] –20 ... +70
Materials		PA reinforced, PC	
Note on materials		RoHS-compliant	
Grid dimension		[mm]	50
Dimensions (incl. interlinking block) W x L x H		[mm]	50 x 107 x 55
Product weight		[g]	110

 Note

Please observe the general limits and guidelines for the system when configuring the electrical modules.

Terminal CPX

Technical data – Interface CPX-CTEL

Connection and display components

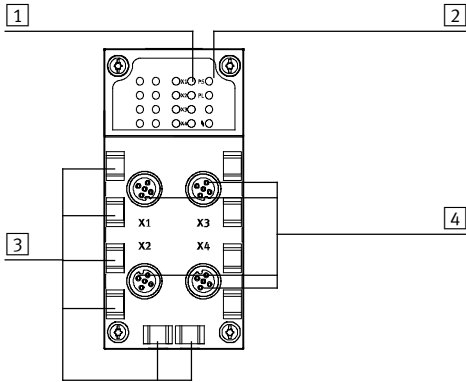

- 1 Status LEDs for I-Port interfaces
- 2 CPX-specific status LEDs
- 3 Holders for inscription labels (IBS 6x10)
- 4 I-Port interfaces for up to 4 devices

Pin allocation – I-Port interface

Pin allocation	Pin	Signal	Designation
	1	24 V _{SEN}	24 V DC supply voltage for electronics and inputs
	2	24 V _{VAL}	24 V DC load voltage supply for valves and outputs
	3	0 V _{SEN}	0 V DC supply voltage for electronics and sensors
	4	C/Q I-Port	Communication signal C/Q, data cable
	5	0 V _{VALVES}	0 V DC load voltage supply for valves and outputs

Dimensions



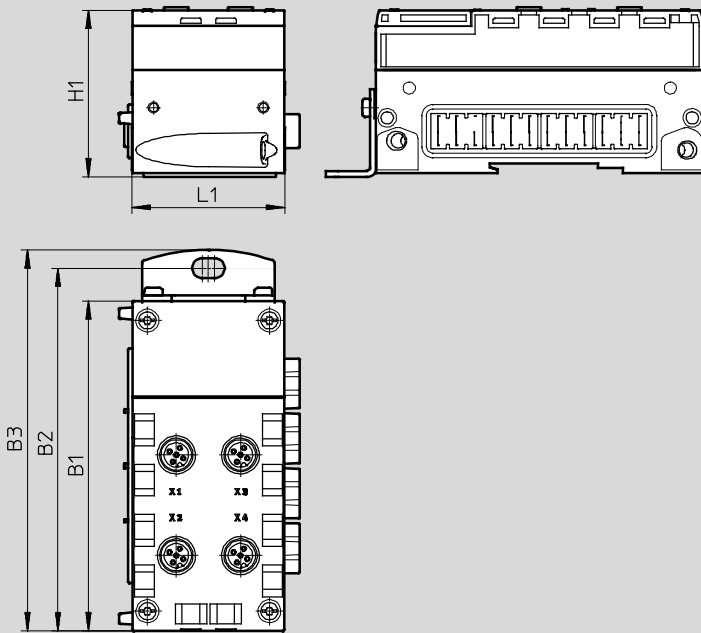

Download CAD data → www.festo.com

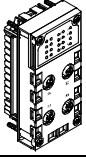

Type	B1	B2	B3	H1	L1
CPX-CTEL-4-M12-5POL	108.1	118.9	124.9	55.1	50

Terminal CPX

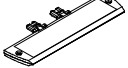
Accessories – Interface CPX-CTEL

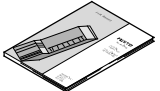
Ordering data				
Designation			Part No.	Type
CPX-CTEL master				
	Interface for max. 4 I/O modules and valve terminals with I-Port interface (devices)		1577012	CPX-CTEL-4-M12-5POL
Bus connection				
	Cover cap	M12	165592	ISK-M12
	Inscription label holder for manifold block		536593	CPX-ST-1
Connecting cable				
	-		574321	NEBU-M12G5-E-5-Q8N-M12G5
			574322	NEBU-M12G5-E-7.5-Q8N-M12G5
			574323	NEBU-M12G5-E-10-Q8N-M12G5
Manual				
	Manual CPX-CTEL master	German	574600	P.BE-CPX-CTEL-DE
		English	574601	P.BE-CPX-CTEL-EN
		Spanish	574602	P.BE-CPX-CTEL-ES
		French	574603	P.BE-CPX-CTEL-FR
		Italian	574604	P.BE-CPX-CTEL-IT
		Swedish	574605	P.BE-CPX-CTEL-SV

Control block CPX-CMXX

Technical data



The control block CPX-CMXX is an intelligent module in the CPX terminal for controlling electric drive units. Individual axis and simple multi-axis applications can easily be implemented. Programming is not necessary. Configuration, parameterisation and commissioning of the application is easily achieved with the Festo Configuration Tool (FCT).

- Configuration of two axes groups with up to four axes each is possible
- There are 1024 position sets available per axes group
- Input or Teach-In of positions in specified set structure
- Parameterisation via Ethernet
- Communication protocol: FHPP-MAX, Festo handling and positioning profile for multi-axis movements.
- Control of drive units via CANopen



General technical data		
Protocol		FHPP-MAX
Maximum address volume for inputs	[byte]	16
Maximum address volume for outputs	[byte]	16
LED displays (bus-specific)	RUN:	Program is executed
	STOP:	Program is stopped
	ERR:	Error in the program execution
	TP:	Status of Ethernet connection
LED displays (product-specific)	M:	Modify, parameterisation
	PS:	Electronic supply, sensor supply
Device-specific diagnostics	Diagnostic memory	
	Channel and module-oriented diagnostics	
	Undervoltage/short circuit of modules	
Parameterisation	System parameters	
Operating elements	Rotary switch for RUN/STOP	
Configuration support	Festo Configuration Tool (FCT)	
Additional functions	System status can be displayed using process data	
	Additional diagnostic interface for FCT	
Supported kinematic system	2-axis gantries (X-Z / Y-Z / X-Y)	
	3-axis gantries (X-Y-Z)	
Total number of axes	8	
Distribution of axes	2 groups with max. 4 axes	
Nominal operating voltage	[V DC]	24
Operating voltage range	[V DC]	18 ... 30
Power failure bridging	[ms]	10
Intrinsic current consumption at nominal operating voltage	[mA]	Typ. 85
Protection class to EN 60529	IP65/IP67	
Dimensions W x L x H (including interlinking block)	[mm]	50 x 107 x 55
Product weight	[g]	155
Materials		
Housing	Reinforced polyamide, polycarbonate	
Note on materials	RoHS-compliant	

Control block CPX-CMXX

Technical data

Technical data – Interfaces		
Ethernet		
Ethernet interface	Socket RJ45, 8-pin, for configuration only	
Interface		
Control interface	CAN bus	
Baud rate	[Mbit/s]	1

Operating and environmental conditions		
Ambient temperature	[°C]	-5 ... +50
Storage temperature	[°C]	-20 ... +70

Connection and display components



Pin allocation – Control interface			
	Pin	Signal	Meaning
Sub-D plug			
	1	n.c.	Not connected
	2	CAN_L	CAN low
	3	CAN_GND	CAN ground
	4	n.c.	Not connected
	5	CAN_SHLD	Connection to functional earth (FE)
	6	CAN_GND	CAN ground (optional) ¹⁾
	7	CAN_H	CAN high
	8	n.c.	Not connected
	9	n.c.	Not connected
	Housing	Screened	Plug housing must be connected to FE

1) If a drive controller is connected to an external power supply, CAN ground (optional), pin 6, cannot be used on the CPX-CMXX.

Control block CPX-CMXX

Technical data

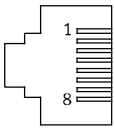

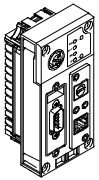



Pin allocation – Ethernet interface			
	Pin	Signal	Meaning
Plug RJ45			
	1	TD+	Transmitted data+
	2	TD-	Transmitted data-
	3	RD+	Received data+
	4	n.c.	Not connected
	5	n.c.	Not connected
	6	RD-	Received data-
	7	n.c.	Not connected
	8	n.c.	Not connected
	Housing	Screened	Screened

Ordering data			
Designation		Part No.	Type
	Control block	555667	CPX-CMXX

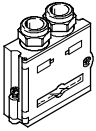
Control block CPX-CMXX

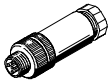
Accessories

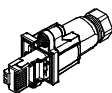
FESTO

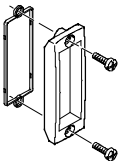
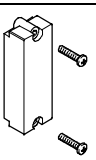
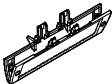
Ordering data – Bus connection			
Designation		Part No.	Type
	Sub-D plug, 9-pin	532219	FBS-SUB-9-BU-2x5POL-B
	Bus connection, plug 2xM12, 5-pin	525632	FBA-2-M12-5POL
	Plug socket for fieldbus connection, M12, 5-pin	18324	FBSD-GD-9-5POL
	Plug M12, 5-pin	175380	FBS-M12-5GS-PG9
	Bus connection, 5-pin	525634	FBA-1-SL-5POL
	Bus connection, screw terminal, 5-pin	525635	FBSD-KL-2x5POL
	Plug RJ45, 8-pin	534494	FBS-RJ45-8-GS
	Cover for RJ45 connection	534496	AK-RJ45
	Inspection cover, transparent for plug/socket Sub-D	533334	AK-SUB-9/15-B
	Cover for plug/socket Sub-D	557010	AK-SUB-9/15
	Inscription label holder for connection block	536593	CPX-ST-1

Documentation			
Designation		Language	Part No. Type
	Description of control block CPX-CMXX	German	564221 P.BE-CPX-CMXX-DE
		English	564222 P.BE-CPX-CMXX-EN
	Description of Festo handling and positioning profile for multi-axis movements FHPP-MAX	German	564223 P.BE-CMXX-FHPP-SW-DE
		English	564224 P.BE-CMXX-FHPP-SW-EN

Control block CPX-CM-HPP

Technical data



The control block CPX-CM-HPP is a module in the CPX terminal for controlling electric drives.

The control component is independent of the bus node used. This means that Festo's electric drive technology is compatible with all industrial communication interfaces.

The control block does not need to be programmed.

- Max. 4 individual electric axes can be controlled via CAN bus
- No programming required
- Standardised communication with the drives via the Festo Handling and Positioning Profile (FHPP)
- Quick configuration and diagnostics via the operator unit CPX-MMI
- Simple, flexible and cost-effective



General technical data		
Fieldbus interface		1x socket M9, 5-pin
Protocol		FHPP
Max. address volume for inputs	[byte]	32
Max. address volume for outputs	[byte]	32
LED display (product-specific)	Error:	Error
	PL:	Power supply
Device-specific diagnostics		Diagnostic memory
		Channel and module-oriented diagnostics
		Undervoltage/short circuit of modules
Parameterisation		Forcing of channels
		System parameters
Configuration support		Operator unit CPX-MMI
Total number of axes		4
Nominal operating voltage	[V DC]	24
Operating voltage range	[V DC]	18 ... 30
Power failure buffering	[ms]	10
Intrinsic current consumption at nominal operating voltage	[mA]	Typically 80
Protection class to EN 60529 (plug connector plugged in)		IP65/IP67
Dimensions W x L x H (incl. interlinking block)	[mm]	50 x 107 x 55
Product weight (without interlinking block)	[g]	140
Materials		
Housing		PA, reinforced
		PC
Note on materials		RoHS-compliant

Technical data – Interfaces		
Interface		
Control interface		CAN-Bus
Baud rate	[Mbps]	1

Operating and environmental conditions		
Ambient temperature	[°C]	-5 ... +50
Storage temperature	[°C]	-20 ... +70
CE mark (see declaration of conformity)		To EU Low Voltage Directive

Control block CPX-CM-HPP

Technical data

Connection and display components

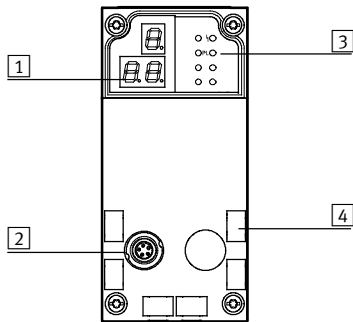

- 1 3-digit display
- 2 Control interface
- 3 LED display, product-specific
- 4 Inscription labels

Pin allocation – Control interface

	Pin	Signal	Meaning
Plug M9, 5-pin			
	1	n.c.	Not connected
	2	n.c.	Not connected
	3	CAN_GND	CAN ground
	4	CAN_H	CAN high
	5	CAN_L	CAN low
	Housing	Screened	Cable screen must be connected to functional earth (FE)

Permitted bus nodes/FEC

Bus node/FEC	Protocol	Max. no. of CPX-CM-HPP modules
CPX-FEC	–	2
CPX-CEC	–	0
CPX-CEC-C1	–	0
CPX-CEC-M1	–	0
CPX-FB6	INTERBUS	0
CPX-FB11	DeviceNet	2
CPX-FB13	PROFIBUS-DP	2
CPX-FB14	CANopen	1
CPX-M-FB20	INTERBUS	0
CPX-M-FB21	INTERBUS	0
CPX-FB23-24	CC-Link	1 (function module F23)
		0 (function module F24)
CPX-FB32	EtherNet/IP	2
CPX-FB33	PROFINET, M12	2
CPX-M-FB34	PROFINET, RJ45	2
CPX-M-FB35	PROFINET, SCRJ	2
CPX-FB36	EtherNet/IP	0
CPX-FB38	EtherCAT	2

Ordering data

Designation	Part No.	Type
 Control block	562214	CPX-CM-HPP

Control block CPX-CM-HPP

Accessories

FESTO

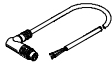
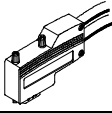
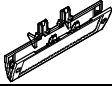
Ordering data – Bus connection				
Designation		Cable length [m]	Part No.	Type
	Connecting cable	2	563711	NEBC-M9W5-K-2-N-LE3
		5	563712	NEBC-M9W5-K-5-N-LE3
	Plug for CAN bus interface, Sub-D, 9-pin, without terminating resistor		533783	FBS-SUB-9-WS-CO-K
	Inscription label holder for manifold block		536593	CPX-ST-1

Documentation				
Designation		Language	Part No.	Type
	Manual – Control block CPX-CM-HPP	German	568683	P.BE-CPX-CM-HPP-DE
		English	568684	P.BE-CPX-CM-HPP-EN

Axis controllers CPX-CMAX

Technical data

The axis controller CPX-CMAX is intended exclusively for valve terminals CPX.



General technical data			
Operating voltage			
Operating voltage range	[V DC]	18 ... 30	
Nominal operating voltage	[V DC]	24	
Current consumption at nominal operating voltage	[mA]	200	
Fuse protection (short circuit)		Electronic	
Power failure bridging	[ms]	10	
Load voltage			
Load voltage range	[V DC]	20 ... 30	
Nominal load voltage	[V DC]	24	
Perm. load current	[A]	2.5	
Fuse protection (short circuit)		Electronic	
Number of axis strings		1	
Axes per string		1	
Length of connecting cable to axis	[m]	≤ 30	
Max. no. of modules		7	
Display		7-segment display	
Assigned addresses	Outputs	[bit]	8x8
	Inputs	[bit]	8x8
Operating modes		Record Select mode Direct mode	
Controller types		Position control	
		Force control	
Diagnostics		Module-orientated	
		Via local 7-segment display	
Status display		Module status	
		Power Load	
		Display/Error Axis X	
		MC Axis X	
Control interface			
Data		CAN bus with Festo protocol	
		Digital	
Electrical connection		5-pin	
		M9	
		Socket	
Materials: Housing		Reinforced polyamide	
Note on materials		RoHS-compliant	
Product weight	[g]	140	
Dimensions	Length	[mm]	107
	Width	[mm]	50
	Height	[mm]	55

Axis controllers CPX-CMAX

Technical data

FESTO

Operating and environmental conditions		
Ambient temperature	[°C]	-5 ... +50
Relative air humidity	[%]	5 ... 95, non-condensing
Protection class to IEC 60529		IP65

Connection and display components

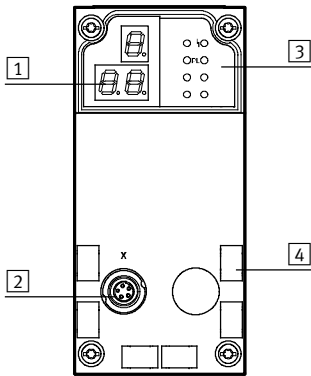

- 1 3-digit display
- 2 Control interface
- 3 Status LEDs
- 4 Inscription labels

Pin allocation – plug 2			
	Pin	Signal	Designation
	1	+24 V	Nominal operating voltage
	2	+24 V	Load voltage
	3	0 V	Ground
	4	CAN_H	CAN high
	5	CAN_L	CAN low
	Housing	Screened	Cable screening

Permitted bus nodes/FEC		
Bus node/FEC	Protocol	Max. no. of CMAX modules
CPX-FEC	–	8
CPX-CEC	–	8
CPX-CEC-C1	–	8
CPX-CEC-M1	–	8
CPX-FB6	INTERBUS	1
CPX-FB11	DeviceNet ¹⁾	8
CPX-FB13	PROFIBUS-DP ²⁾	8
CPX-FB14	CANopen	4
CPX-M-FB20	INTERBUS	1
CPX-M-FB21	INTERBUS	1
CPX-FB23-24	CC-Link	4 (function module F23)
		8 (function module F24)
CPX-FB32	EtherNet/IP	8
CPX-FB33	PROFINET, M12	8
CPX-M-FB34	PROFINET, RJ45	8
CPX-M-FB35	PROFINET, SCRJ	8
CPX-FB36	EtherNet/IP	8
CPX-FB38	EtherCAT	8

1) With Revision 20 (R20)

2) With Revision 23 (R23)

PROFIBUS®, DeviceNet®, CANopen®, INTERBUS®, CC-LINK®, EtherCAT®, PROFINET®, EtherNet/IP® is a registered trademark of its respective trademark holder in certain countries.

Axis controllers CPX-CMAX

Accessories

FESTO

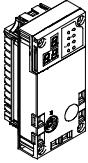
Ordering data – Axis controllers			
	Brief description	Part No.	Type
	Order code in the CPX configurator: T21	548932	CPX-CMAX-C1-1

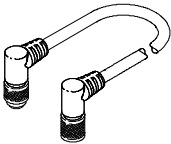
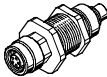
Ordering data – Connecting cables			
	Brief description	Cable length [m]	Part No. Type
	Connecting cable with angled plug and angled socket	0.25	540327 KVI-CP-3-WS-WD-0,25
		0.5	540328 KVI-CP-3-WS-WD-0,5
		2	540329 KVI-CP-3-WS-WD-2
		5	540330 KVI-CP-3-WS-WD-5
		8	540331 KVI-CP-3-WS-WD-8
	Connecting cable with straight plug and straight socket	2	540332 KVI-CP-3-GS-GD-2
5		540333 KVI-CP-3-GS-GD-5	
8		540334 KVI-CP-3-GS-GD-8	
	Connector for control cabinet through-feed	–	543252 KVI-CP-3-SSD

Ordering data – Screws			
	Brief description	Part No.	Type
	For mounting on the metal interlinking block	550219	CPX-M-M3X22-4X

Ordering data – Inscription labels			
	Brief description	Number	Part No. Type
	Inscription labels 6x10, in frames	64	18576 IBS-6X10

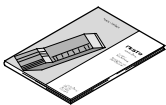
Documentation ¹⁾			
	Language	Part No.	Type
	DE	559750	P.BE-CPX-CMAX-SYS-DE
	EN	559751	P.BE-CPX-CMAX-SYS-EN
	ES	559752	P.BE-CPX-CMAX-SYS-ES
	FR	559753	P.BE-CPX-CMAX-SYS-FR
	IT	559754	P.BE-CPX-CMAX-SYS-IT
	SV	559755	P.BE-CPX-CMAX-SYS-SV

1) Manual in paper form is not included in the scope of delivery.

End-position controllers CPX-CMPX

Technical data

The end-position controller CPX-CMPX is intended exclusively for use in valve terminals CPX.



General technical data			
Operating voltage			
Operating voltage range	[V DC]	18 ... 30	
Nominal operating voltage	[V DC]	24	
Current consumption at nominal operating voltage	[mA]	80	
Load voltage			
Load voltage range	[V DC]	20 ... 30	
Nominal load voltage	[V DC]	24	
Perm. load current	[A]	2.5	
Number of axes per module		1	
Length of connecting cable to axis	[m]	≤ 30	
Max. no. of modules		9	
Display		7-segment display	
Control elements		3 keys	
Assigned addresses	Outputs	[bit]	6x8
	Inputs	[bit]	6x8
Diagnostics	Module-orientated		
	Via local 7-segment display		
	Via operator unit CPX-MMI-1		
Status display	Module status		
	Power Load		
Control interface			
Data	CAN bus with Festo protocol		
	Digital		
Electrical connection	5-pin		
	M9		
	Socket		
Materials: Housing	Reinforced polyamide		
Product weight	[g]	240	
Dimensions	Length	[mm]	107
	Width	[mm]	50
	Height	[mm]	55

End-position controllers CPX-CMPX

Technical data

FESTO

Operating and environmental conditions		
Ambient temperature	[°C]	-5 ... +50
Relative air humidity	[%]	5 ... 95, non-condensing
Protection class to IEC 60529		IP65
CE mark (see declaration of conformity)		To EU EMC Directive

Connection and display components

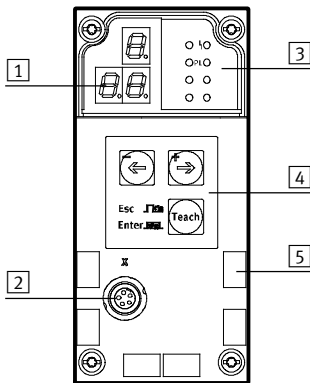

- 1 3-digit display
- 2 Control interface
- 3 Status LEDs
- 4 Operating buttons
- 5 Inscription labels

Pin allocation – plug 2			
	Pin	Signal	Designation
	1	+24 V	Nominal operating voltage
	2	+24 V	Load voltage
	3	0 V	Ground
	4	CAN_H	CAN high
	5	CAN_L	CAN low
	Housing	Screened	Cable screening

Permitted bus nodes/FEC		
Bus node/FEC	Protocol	Max. no. of CMPX modules
CPX-FEC	-	9
CPX-CEC	-	9
CPX-CEC-C1	-	9
CPX-CEC-M1	-	9
CPX-FB6	INTERBUS	2
CPX-FB11	DeviceNet ¹⁾	9
CPX-FB13	PROFIBUS-DP ²⁾	9
CPX-FB14	CANopen	5
CPX-M-FB20	INTERBUS	2
CPX-M-FB21	INTERBUS	2
CPX-FB23-24	CC-Link	5 (function module F23)
		9 (function module F24)
CPX-FB32	EtherNet/IP	9
CPX-FB33	PROFINET, M12	9
CPX-M-FB34	PROFINET, RJ45	9
CPX-M-FB35	PROFINET, SCRJ	9
CPX-FB36	EtherNet/IP	9
CPX-FB38	EtherCAT	9

1) With Revision 20 (R20)

2) With Revision 23 (R23)



PROFIBUS®, DeviceNet®, CANopen®, INTERBUS®, CC-LINK®, EtherCAT®, PROFINET®, EtherNet/IP® is a registered trademark of its respective trademark holder in certain countries.

End-position controllers CPX-CMPX

Accessories

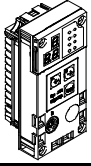
FESTO

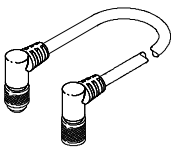
Ordering data – End-position controllers			
	Brief description	Part No.	Type
	Order code in the CPX configurator: T20	548931	CPX-CMPX-C-1-H1

Ordering data – Connecting cables			
	Brief description	Cable length [m]	Part No. Type
	Connecting cable with angled plug and angled socket	0.25	540327 KVI-CP-3-WS-WD-0,25
		0.5	540328 KVI-CP-3-WS-WD-0,5
		2	540329 KVI-CP-3-WS-WD-2
		5	540330 KVI-CP-3-WS-WD-5
		8	540331 KVI-CP-3-WS-WD-8
	Connecting cable with straight plug and straight socket	2	540332 KVI-CP-3-GS-GD-2
5		540333 KVI-CP-3-GS-GD-5	
8		540334 KVI-CP-3-GS-GD-8	
	Connector for control cabinet through-feed	–	543252 KVI-CP-3-SSD

Ordering data – Screws			
	Brief description	Part No.	Type
	For mounting on the metal interlinking block	550219	CPX-M-M3X22-4X

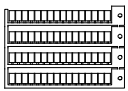
Ordering data – Inscription labels			
	Brief description	Number	Part No. Type
	Inscription labels 6x10, in frames	64	18576 IBS-6X10

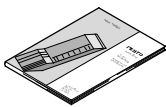
Documentation ¹⁾			
	Language	Part No.	Type
	DE	555479	P.BE-CPX-CMPX-SYS-DE
	EN	555480	P.BE-CPX-CMPX-SYS-EN
	ES	555481	P.BE-CPX-CMPX-SYS-ES
	FR	555482	P.BE-CPX-CMPX-SYS-FR
	IT	555483	P.BE-CPX-CMPX-SYS-IT
	SV	555484	P.BE-CPX-CMPX-SYS-SV

1) Manual in paper form is not included in the scope of delivery

Measuring modules CPX-CMIX

Technical data

The measuring module CPX-CMIX is intended exclusively for use in valve terminals CPX.



General technical data		
Operating voltage		
Operating voltage range	[V DC]	18 ... 30
Nominal operating voltage	[V DC]	24
Current consumption at nominal operating voltage	[mA]	80
Protection against short circuit		Yes
Power failure bridging	[ms]	10
No. of axis strings		1
Axes per string		1
Length of connecting cable to axis	[m]	≤ 30
Max. no. of modules		9
Display		7-segment display
Assigned addresses	Outputs	[bit] 6x8
	Inputs	[bit] 6x8
Diagnostics		Channel and module-oriented
		Via local 7-segment display
		Undervoltage of modules
		Undervoltage of measuring system
Status display		Power Load
		Error
Control interface		
Data		CAN bus with Festo protocol
		Digital
Electrical connection		5-pin
		M9
		Socket
Materials: Housing		Reinforced polyamide
Note on materials		RoHS-compliant
Product weight	[g]	140
Dimensions	Length	[mm] 107
	Width	[mm] 50
	Height	[mm] 55

Measuring modules CPX-CMIX

Technical data

FESTO

Operating and environmental conditions		
Ambient temperature	[°C]	-5 ... +50
Relative air humidity	[%]	5 ... 95, non-condensing
Protection class to IEC 60529		IP65

Connection and display components

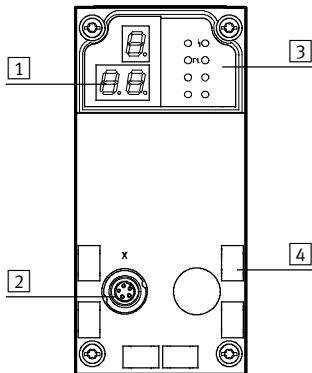

- 1 3-digit display
- 2 Control interface
- 3 Status LEDs
- 4 Inscription labels

Pin allocation – Plug 2			
	Pin	Signal	Designation
	1	+24 V	Nominal operating voltage
	2	+24 V	Load voltage
	3	0 V	Ground
	4	CAN_H	CAN high
	5	CAN_L	CAN low
	Housing	Screened	Cable screening

Permitted bus nodes/FEC		
Bus node/FEC	Protocol	Max. no. of CMIX modules
CPX-FEC	-	9
CPX-CEC	-	9
CPX-CEC-C1	-	9
CPX-CEC-M1	-	9
CPX-FB6	INTERBUS	2
CPX-FB11	DeviceNet ¹⁾	9
CPX-FB13	PROFIBUS-DP ²⁾	9
CPX-FB14	CANopen	5
CPX-M-FB20	INTERBUS	2
CPX-M-FB21	INTERBUS	2
CPX-FB23-24	CC-Link	5 (function module F23)
		9 (function module F24)
CPX-FB32	EtherNet/IP	9
CPX-FB33	PROFINET, M12	9
CPX-M-FB34	PROFINET, RJ45	9
CPX-M-FB35	PROFINET, SCRJ	9
CPX-FB36	EtherNet/IP	9
CPX-FB38	EtherCAT	9

1) With Revision 20 (R20)

2) With Revision 23 (R23)

PROFIBUS®, DeviceNet®, CANopen®, INTERBUS®, CC-LINK®, EtherCAT®, PROFINET®, EtherNet/IP® is a registered trademark of its respective trademark holder in certain countries.

Measuring modules CPX-CMIX

Accessories

FESTO

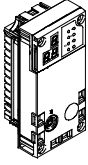
Ordering data – Measuring module			
	Brief description	Part No.	Type
	Order code in the CPX configurator: T23	567417	CPX-CMIX-M1-1

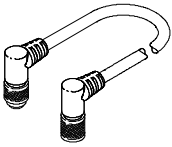
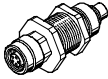
Ordering data – Connecting cables			
	Brief description	Cable length [m]	Part No. Type
	Connecting cable with angled plug and angled socket	0.25	540327 KVI-CP-3-WS-WD-0,25
		0.5	540328 KVI-CP-3-WS-WD-0,5
		2	540329 KVI-CP-3-WS-WD-2
		5	540330 KVI-CP-3-WS-WD-5
		8	540331 KVI-CP-3-WS-WD-8
	Connecting cable with straight plug and straight socket	2	540332 KVI-CP-3-GS-GD-2
5		540333 KVI-CP-3-GS-GD-5	
8		540334 KVI-CP-3-GS-GD-8	
	Connector for control cabinet through-feed	–	543252 KVI-CP-3-SSD

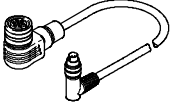
Connection between linear drive DGPI, DGPIIL or displacement encoder MME and measuring module CPX-CMIX			
	For linear drive DGPI, DGPIIL	2	575898 NEBP-M16W6-K-2-M9W5

Ordering data – Screws			
	Brief description	Part No.	Type
	For mounting on the metal interlinking block	550219	CPX-M-M3X22-4X

Ordering data – Inscription labels			
	Brief description	Number	Part No. Type
	Inscription labels 6x10, in frames	64	18576 IBS-6X10

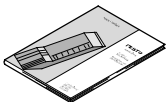
Documentation ¹⁾			
	Language	Part No.	Type
	DE	567053	P.BE-CPX-CMIX-DE
	EN	567054	P.BE-CPX-CMIX-EN
	ES	567055	P.BE-CPX-CMIX-ES
	FR	567056	P.BE-CPX-CMIX-FR
	IT	567057	P.BE-CPX-CMIX-IT
	SV	567058	P.BE-CPX-CMIX-SV

1) Manual in paper form is not included in the scope of delivery

Terminal CPX

Technical data – Input module, digital

Function

Digital input modules enable the connection of two-wire and three-wire sensors (proximity sensors, inductive or capacitive sensors, etc). Depending on the connection block selected, the module supports various connection concepts with different numbers of sockets (single or double allocation).

Applications

- Input modules for 24 V DC sensor supply voltage
- PNP or NPN logic
- Supports connection blocks with M12, M8, Sub-D, Harax and terminal connection
- Module features can be parameterised
- The input module receives the voltage supply for the electronics and the sensors from the interlinking block
- Module protection and diagnostics through integrated electronic fuse protection



General technical data					
Type		CPX-4DE	CPX-8DE	CPX-8DE-D	CPX-8NDE
No. of inputs		4	8	8	8
Max. residual current of inputs per module	[A]	0.7	1	0.7	0.7
Fuse protection		Internal electronic fuse for each module	Internal electronic fuse for each module	Internal electronic fuse for each channel	Internal electronic fuse for each module
Intrinsic current consumption at operating voltage	[mA]	Typically 15			
Operating voltage	Nominal value	24			
	Permissible range	18 ... 30			
Electrical isolation	Channel – channel	No			
	Channel – internal bus	No			
Switching level	Signal 0	≤ 5			≥ 11
	Signal 1	≥ 11			≤ 5
Input debounce time	[ms]	3 (0.1, 10, 20 parameterisable)			
Input characteristic curve		IEC 1131 Part 2			
Switching logic		Positive logic (PNP)			Negative logic (NPN)
LED displays	Group diagnostics	1	1	1	1
	Channel diagnostics	–	–	8	–
	Channel status	4	8	8	8
Diagnostics		Short circuit/overload per channel			
Parameterisation		<ul style="list-style-type: none"> • Module monitoring • Behaviour after short circuit • Input debounce time • Signal stretching time 			
Protection class to EN 60529		Depending on connection block			
Temperature range	Operation	–5 ... +50			
	Storage/transport	–20 ... +70			
Materials		Reinforced polyamide, polycarbonate			
Grid dimension	[mm]	50			
Dimensions (incl. interlinking block and connection block) W x L x H	[mm]	50 x 107 x 50			
Weight	[g]	38			

Terminal CPX

Technical data – Input module, digital

Connection and display components

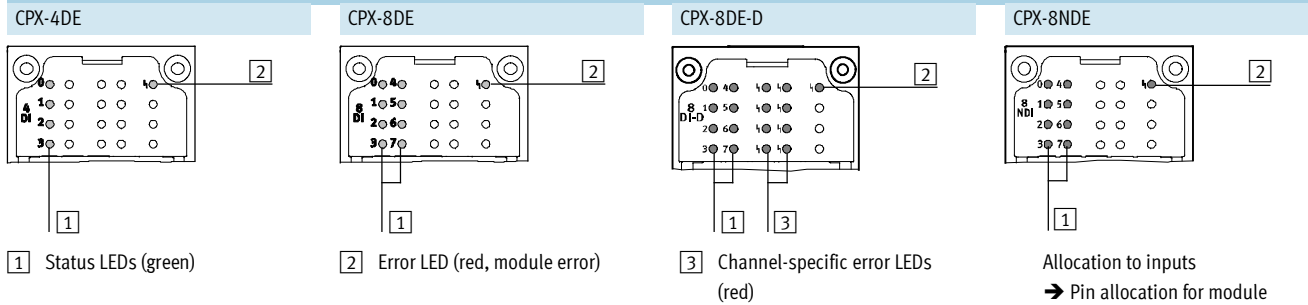

Connection block/digital input module combinations

Connection blocks	Part No.	Digital input modules			
		CPX-4DE	CPX-8DE	CPX-8DE-D	CPX-8NDE
CPX-AB-8-M8-3POL	195706	■	■	■	■
CPX-AB-4-M12X2-5POL	195704	■	■	■	■
CPX-AB-4-M12X2-5POL-R	541254	■	■	■	■
CPX-AB-8-KL-4POL	195708	■	■	■	■
CPX-AB-1-SUB-BU-25POL	525676	■	■	■	■
CPX-AB-4-HAR-4POL	525636	■	■	■	■
CPX-M-AB-4-M12x2-5POL	549367	■	■	■	■

Pin allocation

Connection block inputs	CPX-4DE	CPX-8DE, CPX-8DE-D and CPX-8NDE		
CPX-AB-8-M8-3POL				
	X1.1: 24 V _{SEN} X1.3: 0 V _{SEN} X1.4: Input x X2.1: 24 V _{SEN} X2.3: 0 V _{SEN} X2.4: Input x+1 X3.1: 24 V _{SEN} X3.3: 0 V _{SEN} X3.4: Input x+1 X4.1: 24 V _{SEN} X4.3: 0 V _{SEN} X4.4: n.c.	X5.1: 24 V _{SEN} X5.3: 0 V _{SEN} X5.4: Input x+2 X6.1: 24 V _{SEN} X6.3: 0 V _{SEN} X6.4: Input x+3 X7.1: 24 V _{SEN} X7.3: 0 V _{SEN} X7.4: Input x+3 X8.1: 24 V _{SEN} X8.3: 0 V _{SEN} X8.4: n.c.	X1.1: 24 V _{SEN} x X1.3: 0 V _{SEN} x X1.4: Input x X2.1: 24 V _{SEN} x+1 X2.3: 0 V _{SEN} x+1 X2.4: Input x+1 X3.1: 24 V _{SEN} x+2 X3.3: 0 V _{SEN} x+2 X3.4: Input x+2 X4.1: 24 V _{SEN} x+3 X4.3: 0 V _{SEN} x+3 X4.4: Input x+3	X5.1: 24 V _{SEN} x+4 X5.3: 0 V _{SEN} x+4 X5.4: Input x+4 X6.1: 24 V _{SEN} x+5 X6.3: 0 V _{SEN} x+5 X6.4: Input x+5 X7.1: 24 V _{SEN} x+6 X7.3: 0 V _{SEN} x+6 X7.4: Input x+6 X8.1: 24 V _{SEN} x+7 X8.3: 0 V _{SEN} x+7 X8.4: Input x+7
CPX-AB-4-M12X2-5POL, CPX-AB-4-M12X2-5POL-R¹⁾ and CPX-M-AB-4-M12X2-5POL				
	X1.1: 24 V _{SEN} X1.2: Input x+1 X1.3: 0 V _{SEN} X1.4: Input x X1.5: FE X2.1: 24 V _{SEN} X2.2: n.c. X2.3: 0 V _{SEN} X2.4: Input x+1 X2.5: FE	X3.1: 24 V _{SEN} X3.2: Input x+3 X3.3: 0 V _{SEN} X3.4: Input x+2 X3.5: FE X4.1: 24 V _{SEN} X4.2: n.c. X4.3: 0 V _{SEN} X4.4: Input x+3 X4.5: FE	X1.1: 24 V _{SEN} x X1.2: Input x+1 X1.3: 0 V _{SEN} x X1.4: Input x X1.5: FE X2.1: 24 V _{SEN} x+2 X2.2: Input x+3 X2.3: 0 V _{SEN} x+2 X2.4: Input x+2 X2.5: FE	X3.1: 24 V _{SEN} x+4 X3.2: Input x+5 X3.3: 0 V _{SEN} x+4 X3.4: Input x+4 X3.5: FE X4.1: 24 V _{SEN} x+6 X4.2: Input x+7 X4.3: 0 V _{SEN} x+6 X4.4: Input x+6 X4.5: FE

1) Speedcon quick lock, screening additionally on metal thread

Terminal CPX

Technical data – Input module, digital







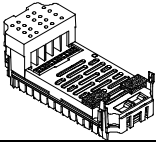
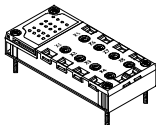
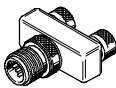

Pin allocation					
Connection block inputs		CPX-4DE	CPX-8DE, CPX-8DE-D and CPX-8NDE		
CPX-AB-8-KL-4POL					
		X1.0: 24 V _{SEN} X1.1: 0 V _{SEN} X1.2: Input x X1.3: FE X2.0: 24 V _{SEN} X2.1: 0 V _{SEN} X2.2: Input x+1 X2.3: FE X3.0: 24 V _{SEN} X3.1: 0 V _{SEN} X3.2: Input x+1 X3.3: FE X4.0: 24 V _{SEN} X4.1: 0 V _{SEN} X4.2: n.c. X4.3: FE	X5.0: 24 V _{SEN} X5.1: 0 V _{SEN} X5.2: Input x+2 X5.3: FE X6.0: 24 V _{SEN} X6.1: 0 V _{SEN} X6.2: Input x+3 X6.3: FE X7.0: 24 V _{SEN} X7.1: 0 V _{SEN} X7.2: Input x+3 X7.3: FE X8.0: 24 V _{SEN} X8.1: 0 V _{SEN} X8.2: n.c. X8.3: FE	X1.0: 24 V _{SEN} x X1.1: 0 V _{SEN} x X1.2: Input x X1.3: FE X2.0: 24 V _{SEN} x+1 X2.1: 0 V _{SEN} x+1 X2.2: Input x+1 X2.3: FE X3.0: 24 V _{SEN} x+2 X3.1: 0 V _{SEN} x+2 X3.2: Input x+2 X3.3: FE X4.0: 24 V _{SEN} x+3 X4.1: 0 V _{SEN} x+3 X4.2: Input x+3 X4.3: FE	X5.0: 24 V _{SEN} x+4 X5.1: 0 V _{SEN} x+4 X5.2: Input x+4 X5.3: FE X6.0: 24 V _{SEN} x+5 X6.1: 0 V _{SEN} x+5 X6.2: Input x+5 X6.3: FE X7.0: 24 V _{SEN} x+6 X7.1: 0 V _{SEN} x+6 X7.2: Input x+6 X7.3: FE X8.0: 24 V _{SEN} x+7 X8.1: 0 V _{SEN} x+7 X8.2: Input x+7 X8.3: FE
CPX-AB-1-SUB-BU-25POL					
		1: Input x 2: Input x+1 3: Input x+1 4: n.c. 5: 24 V _{SEN} 6: 0 V _{SEN} 7: 24 V _{SEN} 8: 0 V _{SEN} 9: 24 V _{SEN} 10: 24 V _{SEN} 11: 0 V _{SEN} 12: 0 V _{SEN} 13: FE	14: Input x+2 15: Input x+3 16: Input x+3 17: n.c. 18: 24 V _{SEN} 19: 24 V _{SEN} 20: 24 V _{SEN} 21: 24 V _{SEN} 22: 0 V _{SEN} 23: 0 V _{SEN} 24: 0 V _{SEN} 25: FE Socket: FE	1: Input x 2: Input x+1 3: Input x+2 4: Input x+3 5: 24 V _{SEN} x+1 6: 0 V _{SEN} x+1 7: 24 V _{SEN} x+3 8: 0 V _{SEN} x+3 9: 24 V _{SEN} x 10: 24 V _{SEN} x+2 11: 0 V _{SEN} x 12: 0 V _{SEN} x+2 13: FE	14: Input x+4 15: Input x+5 16: Input x+6 17: Input x+7 18: 24 V _{SEN} x+4 19: 24 V _{SEN} x+5 20: 24 V _{SEN} x+6 21: 24 V _{SEN} x+7 22: 0 V _{SEN} x+2 and 3 23: 0 V _{SEN} x+2 and 3 24: 0 V _{SEN} x+2 and 3 25: FE Socket: FE
CPX-AB-4-HAR-4POL					
		X1.1: 24 V _{SEN} X1.2: Input x+1 X1.3: 0 V _{SEN} X1.4: Input x X2.1: 24 V _{SEN} X2.2: n.c. X2.3: 0 V _{SEN} X2.4: Input x+1	X3.1: 24 V _{SEN} X3.2: Input x+3 X3.3: 0 V _{SEN} X3.4: Input x+2 X4.1: 24 V _{SEN} X4.2: n.c. X4.3: 0 V _{SEN} X4.4: Input x+3	X1.1: 24 V _{SEN} x X1.2: Input x+1 X1.3: 0 V _{SEN} x X1.4: Input x X2.1: 24 V _{SEN} x+2 X2.2: Input x+3 X2.3: 0 V _{SEN} x+2 X2.4: Input x+2	X3.1: 24 V _{SEN} x+4 X3.2: Input x+5 X3.3: 0 V _{SEN} x+4 X3.4: Input x+4 X4.1: 24 V _{SEN} x+6 X4.2: Input x+7 X4.3: 0 V _{SEN} x+6 X4.4: Input x+6

Terminal CPX

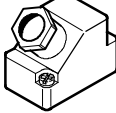
Accessories – Input module, digital

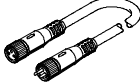

FESTO

Ordering data			
Designation		Part No.	Type
Input module, digital			
	4 digital inputs, positive logic (PNP)	195752	CPX-4DE
	8 digital inputs, positive logic (PNP)	195750	CPX-8DE
	8 digital inputs, positive logic (PNP), advanced diagnostic function	541480	CPX-8DE-D
	8 digital inputs, negative logic (NPN)	543813	CPX-8NDE
Connection block			
	Plastic	8x socket, M8, 3-pin	195706 CPX-AB-8-M8-3POL
		4x socket, M12, 5-pin	195704 CPX-AB-4-M12X2-5POL
		4x socket, M12 with quick-lock technology, 5-pin	541254 CPX-AB-4-M12X2-5POL-R
		Spring clip terminal, 32-pin	195708 CPX-AB-8-KL-4POL
		1x Sub-D socket, 25-pin	525676 CPX-AB-1-SUB-BU-25POL
		4x socket, quick connection, 4-pin	525636 CPX-AB-4-HAR-4POL
	Metal	4x socket, M12, 5-pin	549367 CPX-M-AB-4-M12X2-5POL
Plug			
	Push-in T-connector	2x socket, M12, 5-pin 1x plug, M12, 4-pin	541596 NEDU-M12D5-M12T4
		2x socket, M8, 3-pin 1x plug, M12, 4-pin	541597 NEDU-M8D3-M12T4
	Plug	M8, 3-pin, solderable	18696 SEA-GS-M8
		M8, 3-pin, screw-in	192009 SEA-3GS-M8-S
		M12, 4-pin, PG7	18666 SEA-GS-7
		M12, PG7, 4-pin for cable Ø 2.5 mm	192008 SEA-4GS-7-2,5
		M12, 4-pin, PG9	18778 SEA-GS-9
		M12, 4 pin for 2 cables	18779 SEA-GS-11-DUO
		M12 for 2 cables, 5-pin	192010 SEA-5GS-11-DUO
	HARAX plug, 4-pin	M12, 5-pin	175487 SEA-M12-5GS-PG7
			525928 SEA-GS-HAR-4POL
	Sub-D plug, 25-pin		527522 SD-SUB-D-ST25
Connecting cable			
	Connecting cable M8-M8	0.5 m	175488 KM8-M8-GSGD-0,5
		1.0 m	175489 KM8-M8-GSGD-1
		2.5 m	165610 KM8-M8-GSGD-2,5
		5.0 m	165611 KM8-M8-GSGD-5
	Connecting cable M12-M12	2.5 m	18684 KM12-M12-GSGD-2,5
		5.0 m	18686 KM12-M12-GSGD-5
1.0 m		185499 KM12-M12-GSWD-1-4	
	Modular system for connecting cables		– NEBU-... → Internet: nebu
	DUO cable M12	2x straight socket	18685 KM12-DUO-M8-GDGD
		2x straight/angled socket	18688 KM12-DUO-M8-GDWD
		2x angled socket	18687 KM12-DUO-M8-WDWD

Terminal CPX

Accessories – Input module, digital

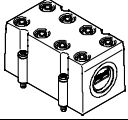
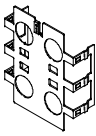
FESTO

Ordering data			
Designation		Part No.	Type
Cover			
	Cover for CPX-AB-8-KL-4POL (IP65/67) – 8 cable through-feeds M9 – 1 cable through-feed for multi-pin plug	538219	AK-8KL
	Fittings kit	538220	VG-K-M9
Screening plate			
	Screening plate for M12 connections	526184	CPX-AB-S-4-M12
User manual			
	User manual	German	526439 P.BE-CPX-EA-DE
		English	526440 P.BE-CPX-EA-EN
		Spanish	526441 P.BE-CPX-EA-ES
		French	526442 P.BE-CPX-EA-FR
		Italian	526443 P.BE-CPX-EA-IT
		Swedish	526444 P.BE-CPX-EA-SV

Terminal CPX

Technical data – Input module, digital, 16 inputs

Function

Digital input modules enable the connection of two-wire and three-wire sensors (proximity sensors, inductive or capacitive sensors, etc.).

Depending on the connection block selected, the module supports various connection concepts with different numbers of sockets (single or double allocation).

Application

- Input modules for 24 V DC sensor supply voltage
- PNP logic
- Module features can be parameterised
- The input module receives the voltage supply for the electronics and the sensors from the interlinking block
- Module protection and diagnostics through integrated electronic fuse protection

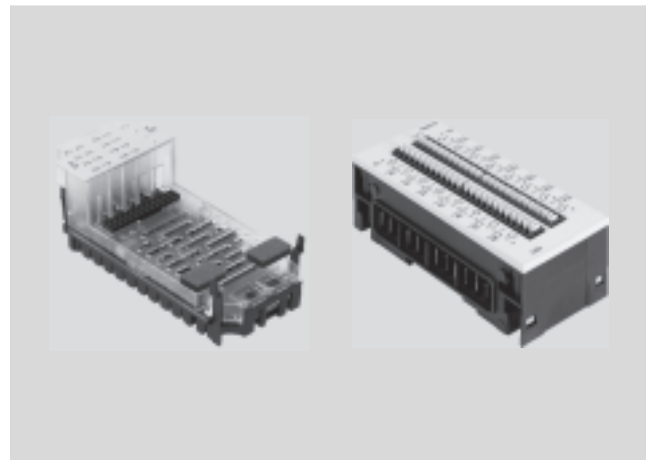

General technical data				
Type		CPX-16DE	CPX-M-16DE-D	CPX-L-16DE
Number of inputs		16	16	16
Max. residual current of inputs per module	[A]	1.8	1.8	1.8
Intrinsic current consumption at operating voltage	[mA]	Typically 15	Typically 34	Typically 15
Fuse protection		Internal electronic fuse per module	Internal electronic fuse per channel pair, additional safety fuse	Internal electronic fuse per module
Nominal operating voltage	[V DC]	24	24	24
Operating voltage range	[V DC]	18 ... 30	18 ... 30	18 ... 30
Electrical isolation	Channel – channel	No	No	No
	Channel – internal bus	No	No	No
Switching level	Signal 0	[V DC] ≤ 5	≤ 5	≤ 5
	Signal 1	[V DC] ≥ 11	≥ 11	≥ 15
Input debounce time	[ms]	3 (0.1 ms, 10 ms, 20 ms parameterisable)		
Input characteristic		IEC 1131-T2	IEC 1131-T2	IEC 1131-T2, type 01
Switching logic		Positive logic (PNP)	Positive logic (PNP)	Positive logic (PNP)
LED displays	Group diagnostics	1	1	1
	Channel diagnostics	–	16	–
	Channel status	16	16	16
Diagnostics		Short circuit/overload per channel		
Parameterisation		<ul style="list-style-type: none"> • Module monitoring • Behaviour after short circuit • Input debounce time • Signal extension time 		
Protection class to EN 60529		Depending on connection block	Depending on connection block	IP20
Temperature range	Operation	[°C] –5 ... +50	–5 ... +50	–5 ... +50
	Storage/transport	[°C] –20 ... +70	–20 ... +70	–20 ... +70
Materials		Reinforced PA, PC	Reinforced PA, PC	Reinforced PA
Note on materials		–	–	RoHS-compliant
Grid dimension	[mm]	50	50	50
Dimensions (incl. interlinking block and connection block) W x L x H	[mm]	50 x 107 x 50	50 x 107 x 50	50 x 107 x 41
Product weight	[g]	38	38	Approx. 170

Terminal CPX

Technical data – Input module, digital, 16 inputs

Connection and display components

CPX-16DE

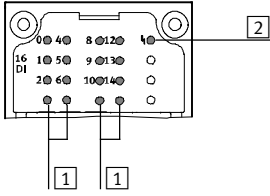

- 1 Status LEDs (green)
For allocation to inputs
→ pin allocation for module
- 2 Error LED (red, module error)

CPX-M-16DE-D

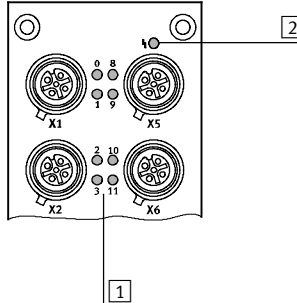

- 1 Status LEDs (green)
for each input signal
- 2 Error LED (red, module error)

CPX-L-16DE

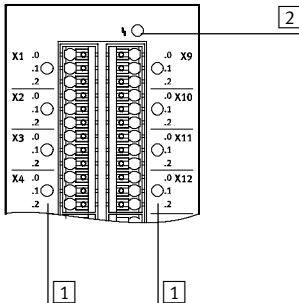

- 1 Status LEDs (green)
for each input signal
- 2 Error LED (red, module error)

Connection block/digital input module combinations

Connection blocks	Part No.	Digital input modules		
		CPX-16DE	CPX-M-16DE-D	CPX-L-16DE
CPX-AB-8-M8X2-4POL	541256	■	-	-
CPX-AB-8-KL-4POL	195708	■	-	-
CPX-AB-1-SUB-BU-25POL	525676	■	-	-
CPX-M-AB-8-M12X2-5POL	549335	-	■	-

Terminal CPX

Technical data – Input module, digital, 16 inputs

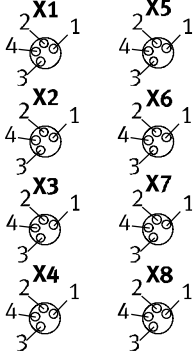
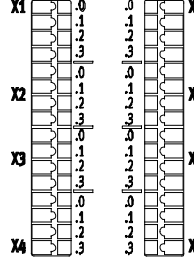
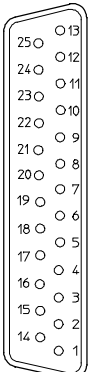
Pin allocation		
Connection block inputs	CPX-16DE	
CPX-AB-8-M8x2-4POL		
	<p>X1.1: 24 V_{SEN} X1.2: Input x+1 X1.3: 0 V_{SEN} X1.4: Input x</p> <p>X2.1: 24 V_{SEN} X2.2: Input x+3 X2.3: 0 V_{SEN} X2.4: Input x+2</p> <p>X3.1: 24 V_{SEN} X3.2: Input x+5 X3.3: 0 V_{SEN} X3.4: Input x+4</p> <p>X4.1: 24 V_{SEN} X4.2: Input x+7 X4.3: 0 V_{SEN} X4.4: Input x+6</p>	<p>X5.1: 24 V_{SEN} X5.2: Input x+9 X5.3: 0 V_{SEN} X5.4: Input x+8</p> <p>X6.1: 24 V_{SEN} X6.2: Input x+11 X6.3: 0 V_{SEN} X6.4: Input x+10</p> <p>X7.1: 24 V_{SEN} X7.2: Input x+13 X7.3: 0 V_{SEN} X7.4: Input x+12</p> <p>X8.1: 24 V_{SEN} X8.2: Input x+15 X8.3: 0 V_{SEN} X8.4: Input x+14</p>
CPX-AB-8-KL-4POL		
	<p>X1.0: Input x+8 X1.1: 24 V_{SEN} X1.2: Input x X1.3: FE</p> <p>X2.0: Input x+9 X2.1: 24 V_{SEN} X2.2: Input x+1 X2.3: FE</p> <p>X3.0: Input x+10 X3.1: 24 V_{SEN} X3.2: Input x+2 X3.3: FE</p> <p>X4.0: Input x+11 X4.1: 24 V_{SEN} X4.2: Input x+3 X4.3: FE</p>	<p>X5.0: Input x+12 X5.1: 0 V_{SEN} X5.2: Input x+4 X5.3: FE</p> <p>X6.0: Input x+13 X6.1: 0 V_{SEN} X6.2: Input x+5 X6.3: FE</p> <p>X7.0: Input x+14 X7.1: 0 V_{SEN} X7.2: Input x+6 X7.3: FE</p> <p>X8.0: Input x+15 X8.1: 0 V_{SEN} X8.2: Input x+7 X8.3: FE</p>
CPX-AB-1-SUB-BU-25POL		
	<p>1: Input x 2: Input x+1 3: Input x+2 4: Input x+3 5: Input x+9 6: 24 V_{SEN} 7: Input x+11 8: 24 V_{SEN} 9: Input x+8 10: Input x+10 11: 24 V_{SEN} 12: 24 V_{SEN} 13: FE</p>	<p>14: Input x+4 15: Input x+5 16: Input x+6 17: Input x+7 18: Input x+12 19: Input x+13 20: Input x+14 21: Input x+15 22: 0 V_{SEN} 23: 0 V_{SEN} 24: 0 V_{SEN} 25: FE Housing: FE</p>

Terminal CPX

Technical data – Input module, digital, 16 inputs

Pin allocation		CPX-M-16DE-D	
CPX-M-AB-8-M12X2-5POL			
	<p>X1.1: $24 V_{Sx}$ X1.2: Input x+1 X1.3: $0 V_{Sx}$ X1.4: Input x X1.5: FE</p> <p>X2.1: $24 V_{Sx+2}$ X2.2: Input x+3 X2.3: $0 V_{Sx+2}$ X2.4: Input x+2 X2.5: FE</p> <p>X3.1: $24 V_{Sx+4}$ X3.2: Input x+5 X3.3: $0 V_{Sx+4}$ X3.4: Input x+4 X3.5: FE</p> <p>X4.1: $24 V_{Sx+6}$ X4.2: Input x+7 X4.3: $0 V_{Sx+6}$ X4.4: Input x+6 X4.5: FE</p>	<p>X5.1: $24 V_{Sx+8}$ X5.2: Input x+9 X5.3: $0 V_{Sx+8}$ X5.4: Input x+8 X5.5: FE</p> <p>X6.1: $24 V_{Sx+10}$ X6.2: Input x+11 X6.3: $0 V_{Sx+10}$ X6.4: Input x+10 X6.5: FE</p> <p>X7.1: $24 V_{Sx+12}$ X7.2: Input x+13 X7.3: $0 V_{Sx+12}$ X7.4: Input x+12 X7.5: FE</p> <p>X8.1: $24 V_{Sx+14}$ X8.2: Input x+15 X8.3: $0 V_{Sx+14}$ X8.4: Input x+14 X8.5: FE</p>	

Terminal CPX





Technical data – Input module, digital, 16 inputs

Pin allocation		CPX-L-16DE	
Connection block inputs			
	X1.0: 24 V _{SEN}	X9.0: 24 V _{SEN}	
	X1.1: Input x	X9.1: Input x+8	
	X1.2: 0 V _{SEN}	X9.2: 0 V _{SEN}	
	X2.0: 24 V _{SEN}	X10.0: 24 V _{SEN}	
	X2.1: Input x+1	X10.1: Input x+9	
	X2.2: 0 V _{SEN}	X10.2: 0 V _{SEN}	
	X3.0: 24 V _{SEN}	X11.0: 24 V _{SEN}	
	X3.1: Input x+2	X11.1: Input x+10	
	X3.2: 0 V _{SEN}	X11.2: 0 V _{SEN}	
	X4.0: 24 V _{SEN}	X12.0: 24 V _{SEN}	
	X4.1: Input x+3	X12.1: Input x+11	
	X4.2: 0 V _{SEN}	X12.2: 0 V _{SEN}	
	X5.0: 24 V _{SEN}	X13.0: 24 V _{SEN}	
	X5.1: Input x+4	X13.1: Input x+12	
	X5.2: 0 V _{SEN}	X13.2: 0 V _{SEN}	
	X6.0: 24 V _{SEN}	X14.0: 24 V _{SEN}	
X6.1: Input x+5	X14.1: Input x+13		
X6.2: 0 V _{SEN}	X14.2: 0 V _{SEN}		
X7.0: 24 V _{SEN}	X15.0: 24 V _{SEN}		
X7.1: Input x+6	X15.1: Input x+14		
X7.2: 0 V _{SEN}	X15.2: 0 V _{SEN}		
X8.0: 24 V _{SEN}	X16.0: 24 V _{SEN}		
X8.1: Input x+7	X16.1: Input x+15		
X8.2: 0 V _{SEN}	X16.2: 0 V _{SEN}		

Terminal CPX

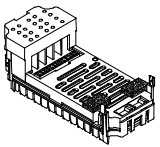
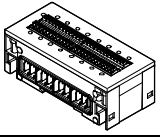
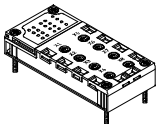
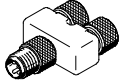
FESTO

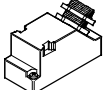
Accessories – Input module, digital, 16 inputs

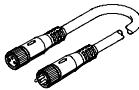
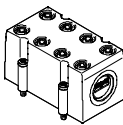
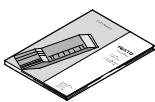
Ordering data				
Designation			Part No.	Type
Input module, digital				
	16 digital inputs, internal electronic fuse per module		543815	CPX-16DE
	16 digital inputs, internal electronic fuse per channel pair, for CPX in metal		550202	CPX-M-16DE-D
	16 digital inputs, internal electronic fuse per module, for CPX in plastic, including interlinking block and connection block with spring-loaded terminals		572606	CPX-L-16DE-16-KL-3POL
Connection block				
	Plastic	8x socket, M8, 4-pin	541256	CPX-AB-8-M8X2-4POL
		Spring-loaded terminal, 32-pin	195708	CPX-AB-8-KL-4POL
		1x socket, Sub-D, 25-pin	525676	CPX-AB-1-SUB-BU-25POL
	Metal	8x socket, M12, 5-pin	549335	CPX-M-AB-8-M12X2-5POL
Plug				
	Push-in T-connector	2x socket, M8, 3-pin	544391	NEDU-M8D3-M8T4
		1x plug, M8, 4-pin		
	Plug, M8, 3-pin	Solderable	18696	SEA-GS-M8
		Screw-in	192009	SEA-3GS-M8-S
	Plug, Sub-D, 25-pin		527522	SD-SUB-D-ST25
Connecting cable				
	Connecting cable M8-M8	0.5 m	175488	KM8-M8-GSGD-0,5
		1.0 m	175489	KM8-M8-GSGD-1
		2.5 m	165610	KM8-M8-GSGD-2,5
		5.0 m	165611	KM8-M8-GSGD-5
	Modular system for connecting cables		-	NEBU-... → Internet: nebu
Cover				
	Cover for CPX-AB-8-KL-4POL (IP65/67) – 8 cable through-feeds M9 – 1 cable through-feed for multi-pin plug		538219	AK-8KL
	Fittings kit		538220	VG-K-M9
Manual				
	Manual	German	526439	P.BE-CPX-EA-DE
		English	526440	P.BE-CPX-EA-EN
		Spanish	526441	P.BE-CPX-EA-ES
		French	526442	P.BE-CPX-EA-FR
		Italian	526443	P.BE-CPX-EA-IT
	Swedish	526444	P.BE-CPX-EA-SV	

Terminal CPX

Technical data – Output module, digital

Function

Digital outputs control actuators such as individual valves, hydraulic valves, heating controllers and many more. Separate circuits are created using an additional power supply. Parallel connection of the outputs of a module enables consuming devices to be controlled with up to 4 A.

Applications

- Output module for 24 V DC supply voltage
- PNP logic
- Module features can be parameterised
- The output module receives the voltage supply for the electronics and the outputs from the interlinking block
- Module protection and diagnostics through integrated electronic fuse protection in each channel



General technical data				
Type		CPX-4DA	CPX-8DA	CPX-8DA-H
No. of outputs		4	8	8
Max. power supply	Per module	4		8.4
	Per channel	1 (24 W lamp load, 4 channels can be connected in parallel)	0.5 (12 W lamp load, 8 channels can be connected in parallel)	2.1 (50 W lamp load, per channel pair)
Fuse protection (short circuit)		Internal electronic fuse for each channel		
Module current consumption (voltage supply for electronics)	[mA]	Typically 16		Typically 34
Operating voltage	Nominal value	24		
	Permissible range	18 ... 30		
Electrical isolation	Channel – channel	No		
	Channel – internal bus	Yes, using an intermediate supply		
Output characteristic curve		To IEC 1131-2		
Switching logic		Positive logic (PNP)		
LED displays	Group diagnostics	1	1	1
	Channel diagnostics	4	8	8
	Channel status	4	8	8
Diagnostics		<ul style="list-style-type: none"> • Short circuit/overload, channel x • Undervoltage of outputs 		
Parameterisation		<ul style="list-style-type: none"> • Module monitoring • Behaviour after short circuit • Fail-safe channel x • Forcing channel x • Idle mode channel x 		
Protection class to EN 60529		Depending on connection block		
Temperature range	Operation	–5 ... +50		
	Storage/transport	–20 ... +70		
Materials		Reinforced polyamide, polycarbonate		
Grid dimension	[mm]	50		
Dimensions (incl. interlinking block and connection block) W x L x H	[mm]	50 x 107 x 50		
Weight	[g]	38		

Terminal CPX

Technical data – Output module, digital

Connection and display components

CPX-4DA

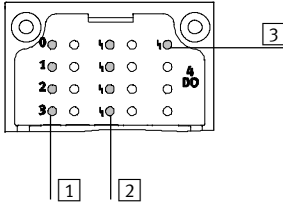

CPX-8DA

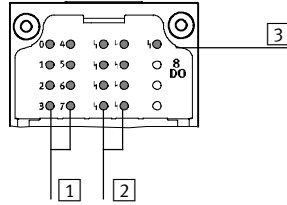

- 1 Status LEDs (yellow)
Allocation to outputs
→ Pin allocation for module
- 2 Channel-specific error LEDs (red)
- 3 Error LED (red, module error)

Connection block/digital output module combinations

Connection blocks	Part No.	Digital output module		
		CPX-4DA	CPX-8DA	CPX-8DA-H
CPX-AB-8-M8-3POL	195706	■	■	–
CPX-AB-8-M8X2-4POL	541256	■	■	■
CPX-AB-4-M12X2-5POL	195704	■	■	–
CPX-AB-4-M12X2-5POL-R	541254	■	■	■
CPX-AB-8-KL-4POL	195708	■	■	■
CPX-AB-1-SUB-BU-25POL	525676	■	■	■
CPX-AB-4-HAR-4POL	525636	■	■	–
CPX-M-AB-4-M12x2-5POL	549367	■	■	■

Pin allocation

Connection block outputs	CPX-4DA	CPX-8DA
CPX-AB-8-M8-3POL		
	X1.1: n.c. X1.3: 0 V _{OUT} X1.4: Output x X2.1: n.c. X2.3: 0 V _{OUT} X2.4: Output x+1 X3.1: n.c. X3.3: 0 V _{OUT} X3.4: Output x+1 X4.1: n.c. X4.3: 0 V _{OUT} X4.4: n.c.	X5.1: n.c. X5.3: 0 V _{OUT} X5.4: Output x+2 X6.1: n.c. X6.3: 0 V _{OUT} X6.4: Output x+3 X7.1: n.c. X7.3: 0 V _{OUT} X7.4: Output x+3 X8.1: n.c. X8.3: 0 V _{OUT} X8.4: n.c.
		X1.1: n.c. X1.3: 0 V _{OUT} X1.4: Output x X2.1: n.c. X2.3: 0 V _{OUT} X2.4: Output x+1 X3.1: n.c. X3.3: 0 V _{OUT} X3.4: Output x+2 X4.1: n.c. X4.3: 0 V _{OUT} X4.4: Output x+3
		X5.1: n.c. X5.3: 0 V _{OUT} X5.4: Output x+4 X6.1: n.c. X6.3: 0 V _{OUT} X6.4: Output x+5 X7.1: n.c. X7.3: 0 V _{OUT} X7.4: Output x+6 X8.1: n.c. X8.3: 0 V _{OUT} X8.4: Output x+7

Terminal CPX

Technical data – Output module, digital

Pin allocation					
Connection block outputs		CPX-4DA		CPX-8DA and CPX-8DA-H	
CPX-AB-8-M8X2-4POL					
		X1.1: 0 V _{OUT} X1.2: Output x+1 X1.3: 0 V _{OUT} X1.4: Output x X2.1: 0 V _{OUT} X2.2: n.c. X2.3: 0 V _{OUT} X2.4: Output x+1 X3.1: 0 V _{OUT} X3.2: Output x+3 X3.3: 0 V _{OUT} X3.4: Output x+2 X4.1: 0 V _{OUT} X4.2: n.c. X4.3: 0 V _{OUT} X4.4: Output x+3	X5.1: 0 V _{OUT} X5.2: n.c. X5.3: 0 V _{OUT} X5.4: n.c. X6.1: 0 V _{OUT} X6.2: n.c. X6.3: 0 V _{OUT} X6.4: n.c. X7.1: 0 V _{OUT} X7.2: n.c. X7.3: 0 V _{OUT} X7.4: n.c. X8.1: 0 V _{OUT} x+1 X8.2: n.c. X8.3: 0 V _{OUT} x+3 X8.4: n.c.	X1.1: 0 V _{OUT} X1.2: Output x+1 X1.3: 0 V _{OUT} X1.4: Output x X2.1: 0 V _{OUT} X2.2: Output x+3 X2.3: 0 V _{OUT} X2.4: Output x+2 X3.1: 0 V _{OUT} X3.2: Output x+5 X3.3: 0 V _{OUT} X3.4: Output x+4 X4.1: 0 V _{OUT} X4.2: Output x+7 X4.3: 0 V _{OUT} X4.4: Output x+6	X5.1: 0 V _{OUT} X5.2: n.c. X5.3: 0 V _{OUT} X5.4: n.c. X6.1: 0 V _{OUT} X6.2: n.c. X6.3: 0 V _{OUT} X6.4: n.c. X7.1: 0 V _{OUT} X7.2: n.c. X7.3: 0 V _{OUT} X7.4: n.c. X8.1: 0 V _{OUT} X8.2: n.c. X8.3: 0 V _{OUT} X8.4: n.c.
CPX-AB-4-M12X2-5POL¹⁾ and CPX-AB-4-M12X2-5POL-R²⁾					
		X1.1: n.c. X1.2: Output x+1 X1.3: 0 V _{OUT} X1.4: Output x X1.5: FE X2.1: n.c. X2.2: n.c. X2.3: 0 V _{OUT} X2.4: Output x+1 X2.5: FE	X3.1: n.c. X3.2: Output x+3 X3.3: 0 V _{OUT} X3.4: Output x+2 X3.5: FE X4.1: n.c. X4.2: n.c. X4.3: 0 V _{OUT} X4.4: Output x+3 X4.5: FE	X1.1: n.c. X1.2: Output x+1 X1.3: 0 V _{OUT} X1.4: Output x X1.5: FE X2.1: n.c. X2.2: Output x+3 X2.3: 0 V _{OUT} X2.4: Output x+2 X2.5: FE	X3.1: n.c. X3.2: Output x+5 X3.3: 0 V _{OUT} X3.4: Output x+4 X3.5: FE X4.1: n.c. X4.2: Output x+7 X4.3: 0 V _{OUT} X4.4: Output x+6 X4.5: FE
CPX-AB-8-KL-4POL					
		X1.0: n.c. X1.1: 0 V _{OUT} X1.2: Output x X1.3: FE X2.0: n.c. X2.1: 0 V _{OUT} X2.2: Output x+1 X2.3: FE X3.0: n.c. X3.1: 0 V _{OUT} X3.2: Output x+1 X3.3: FE X4.0: n.c. X4.1: 0 V _{OUT} X4.2: n.c. X4.3: FE	X5.0: n.c. X5.1: 0 V _{OUT} X5.2: Output x+2 X5.3: FE X6.0: n.c. X6.1: 0 V _{OUT} X6.2: Output x+3 X6.3: FE X7.0: n.c. X7.1: 0 V _{OUT} X7.2: Output x+3 X7.3: FE X8.0: n.c. X8.1: 0 V _{OUT} X8.2: n.c. X8.3: FE	X1.0: n.c. X1.1: 0 V _{OUT} X1.2: Output x X1.3: FE X2.0: n.c. X2.1: 0 V _{OUT} X2.2: Output x+1 X2.3: FE X3.0: n.c. X3.1: 0 V _{OUT} X3.2: Output x+2 X3.3: FE X4.0: n.c. X4.1: 0 V _{OUT} X4.2: Output x+3 X4.3: FE	X5.0: n.c. X5.1: 0 V _{OUT} X5.2: Output x+4 X5.3: FE X6.0: n.c. X6.1: 0 V _{OUT} X6.2: Output x+5 X6.3: FE X7.0: n.c. X7.1: 0 V _{OUT} X7.2: Output x+6 X7.3: FE X8.0: n.c. X8.1: 0 V _{OUT} X8.2: Output x+7 X8.3: FE

1) Not suitable for CPX-8DA-H.
 2) Speedcon quick lock, screening additionally on metal thread

Terminal CPX

Technical data – Output module, digital

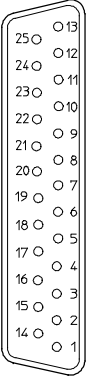
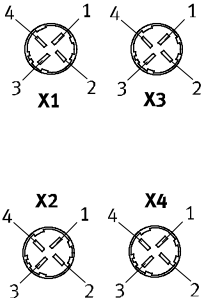



Pin allocation				
Connection block outputs	CPX-4DA		CPX-8DA and CPX-8DA-H	
CPX-AB-1-SUB-BU-25POL				
	1: Output x 2: Output x+1 3: Output x+1 4: n.c. 5: n.c. 6: 0 V _{OUT} 7: n.c. 8: 0 V _{OUT} 9: n.c. 10: n.c. 11: 0 V _{OUT} 12: 0 V _{OUT} 13: FE	14: Output x+2 15: Output x+3 16: Output x+3 17: n.c. 18: n.c. 19: n.c. 20: n.c. 21: n.c. 22: 0 V _{OUT} 23: 0 V _{OUT} 24: 0 V _{OUT} 25: FE Socket: FE	1: Output x 2: Output x+1 3: Output x+2 4: Output x+3 5: n.c. 6: 0 V _{OUT} 7: n.c. 8: 0 V _{OUT} 9: n.c. 10: n.c. 11: 0 V _{OUT} 12: 0 V _{OUT} 13: FE	14: Output x+4 15: Output x+5 16: Output x+6 17: Output x+7 18: n.c. 19: n.c. 20: n.c. 21: n.c. 22: 0 V _{OUT} 23: 0 V _{OUT} 24: 0 V _{OUT} 25: FE Socket: FE
CPX-AB-4-HAR-4POL¹⁾				
	X1.1: n.c. X1.2: Output x+1 X1.3: 0 V _{OUT} X1.4: Output x X2.1: n.c. X2.2: n.c. X2.3: 0 V _{OUT} X2.4: Output x+1	X3.1: n.c. X3.2: Output x+3 X3.3: 0 V _{OUT} X3.4: Output x+2 X4.1: n.c. X4.2: n.c. X4.3: 0 V _{OUT} X4.4: Output x+3	X1.1: n.c. X1.2: Output x+1 X1.3: 0 V _{OUT} X1.4: Output x X2.1: n.c. X2.2: Output x+3 X2.3: 0 V _{OUT} X2.4: Output x+2	X3.1: n.c. X3.2: Output x+5 X3.3: 0 V _{OUT} X3.4: Output x+4 X4.1: n.c. X4.2: Output x+7 X4.3: 0 V _{OUT} X4.4: Output x+6

1) Not suitable for CPX-8DA-H.

Terminal CPX

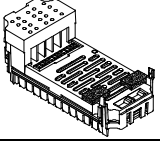
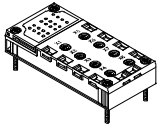
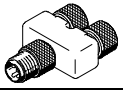
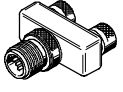
Accessories – Output module, digital

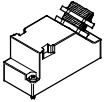

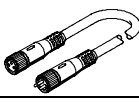
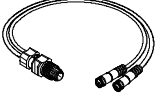
FESTO

Ordering data			
Designation		Part No.	Type
Output module, digital			
	4 digital outputs, power supply 1 A per channel	195754	CPX-4DA
	8 digital outputs, power supply 0.5 A per channel	541482	CPX-8DA
	8 digital outputs, power supply 2.1 A per channel pair	550204	CPX-8DA-H
Connection block			
	Plastic	8x socket, M8, 3-pin	195706 CPX-AB-8-M8-3POL
		8x socket, M8, 4-pin	541256 CPX-AB-8-M8X2-4POL
		4x socket, M12, 5-pin	195704 CPX-AB-4-M12X2-5POL
		4x socket, M12 with quick-lock technology, 5-pin	541254 CPX-AB-4-M12X2-5POL-R
		Spring clip terminal, 32-pin	195708 CPX-AB-8-KL-4POL
		1x Sub-D socket, 25-pin	525676 CPX-AB-1-SUB-BU-25POL
		4x socket, quick connection, 4-pin	525636 CPX-AB-4-HAR-4POL
	Metal	4x socket, M12, 5-pin	549367 CPX-M-AB-4-M12X2-5POL
Plug			
	Push-in T-connector	2x socket M8, 3-pin 1x plug M8, 4-pin	544391 NEDU-M8D3-M8T4
			Push-in T-connector
	Plug		
		M8, 3-pin, solderable	18696 SEA-GS-M8
M8, 3-pin, screw-in		192009 SEA-3GS-M8-S	
M12, PG7		18666 SEA-GS-7	
M12, PG7, 4-pin for cable Ø 2.5 mm		192008 SEA-4GS-7-2,5	
M12, PG9		18778 SEA-GS-9	
M12 for 2 cables		18779 SEA-GS-11-DUO	
M12 for 2 cables, 5-pin		192010 SEA-5GS-11-DUO	
	HARAX plug, 4-pin	M12, 5-pin	175487 SEA-M12-5GS-PG7
			525928 SEA-GS-HAR-4POL
	Sub-D plug, 25-pin		527522 SD-SUB-D-ST25
Connecting cable			
	Connecting cable M8-M8	0.5 m	175488 KM8-M8-GSGD-0,5
		1.0 m	175489 KM8-M8-GSGD-1
		2.5 m	165610 KM8-M8-GSGD-2,5
		5.0 m	165611 KM8-M8-GSGD-5
	Connecting cable M12-M12	2.5 m	18684 KM12-M12-GSGD-2,5
		5.0 m	18686 KM12-M12-GSGD-5
1.0 m		185499 KM12-M12-GSWD-1-4	
	Modular system for connecting cables		- NEBU-... → Internet: nebu
	DUO cable M12	2x straight socket	18685 KM12-DUO-M8-GDGD
		2x straight/angled socket	18688 KM12-DUO-M8-GDWD
		2x angled socket	18687 KM12-DUO-M8-WDWD

Terminal CPX

Accessories – Output module, digital

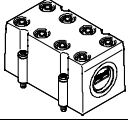
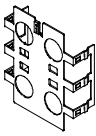
FESTO

Ordering data			
Designation		Part No.	Type
Cover			
	Cover for CPX-AB-8-KL-4POL (IP65/67) – 8 cable through-feeds M9 – 1 cable through-feed for multi-pin plug	538219	AK-8KL
	Fittings kit	538220	VG-K-M9
Screening plate			
	Screening plate for M12 connections	526184	CPX-AB-S-4-M12
User manual			
	User manual	German	526439 P.BE-CPX-EA-DE
		English	526440 P.BE-CPX-EA-EN
		Spanish	526441 P.BE-CPX-EA-ES
		French	526442 P.BE-CPX-EA-FR
		Italian	526443 P.BE-CPX-EA-IT
		Swedish	526444 P.BE-CPX-EA-SV

Terminal CPX

Technical data – Input/output module, digital

Application

- Digital multi I/O module for 24 V DC supply voltage
- Supports connection blocks with Sub-D, terminal connection and M12 connection (8-pin)
- As CPX-L with connection via spring-loaded terminals
- Module features can be parameterised
- The inputs receive the voltage supply for the electronics and the sensors from the interlinking block
- The outputs receive the voltage supply for the electronics and the outputs from the interlinking block
- Module protection and diagnostics through integrated electronic fuse protection for the sensor power supply and integrated electronic fuse protection in each output channel

Function

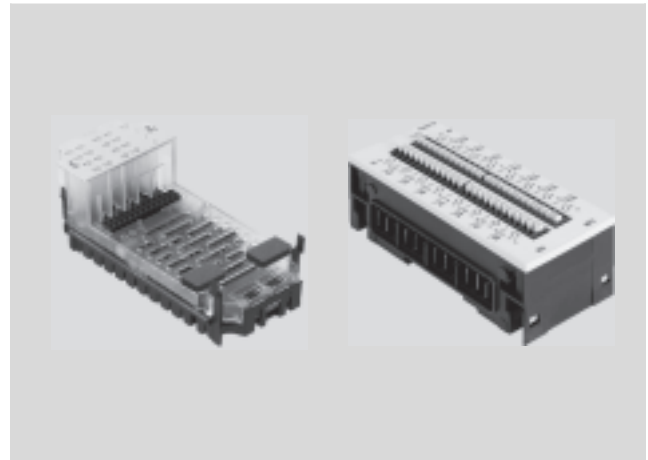
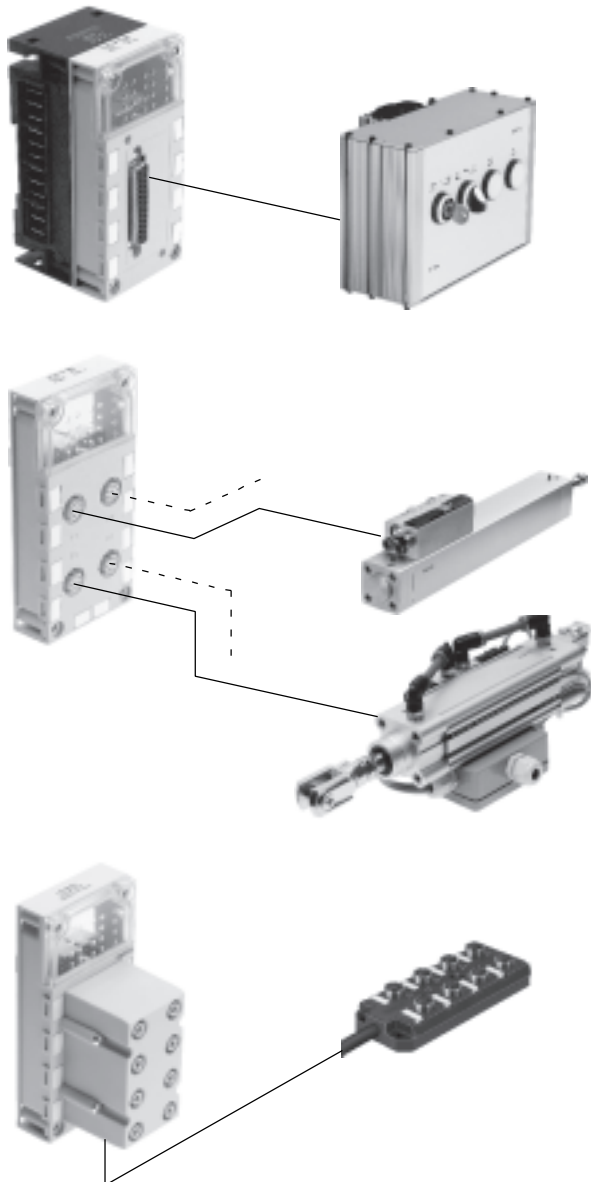

The multi I/O module controls devices with a high number of inputs and outputs per connection point. Since the module supports Sub-D connection blocks, consoles with pushbuttons and lamps can be connected to the terminal CPX using a minimal amount of installation space.

Up to 8 inputs and 8 outputs can be connected to one connection point with high protection to IP65.

Since the module supports the M12 connection block (8-pin), up to 4 cylinder/valve combinations with integrated sensors can be connected. Each cylinder/valve combination is supported by 2 inputs and 2 outputs per socket. It is therefore possible to control max. 2 solenoid coils and record signals from 2 sensors with a pre-assembled cable.

Two inputs on 2 sockets are bridged to provide support for the diagnostic module of the cylinder/valve combination. This means that 3 inputs and 2 outputs are available at 2 sockets.

As an alternative to the Sub-D and M12 connection block (8-pin) for installation with high protection to IP65, the terminal connection block produces an identical result for installation with IP20 protection – or with IP65/67 protection with additional cover.

Subordinate I/O modules with multi-pin plug connection (Sub-D plug or multi-pin cable for self-assembly) support the cost-effective and space-saving integration of critical installation areas such as energy chains or upstream functions.

Terminal CPX

Technical data – Input/output module, digital

FESTO

General technical data				
Type		CPX-8DE-8DA	CPX-L-8DE-8DA	
Number	Inputs	8	8	
	Outputs	8	8	
Max. power supply per module	Sensor supply [A]	0.7	1.8	
	Outputs [A]	4	2	
Max. power supply per channel		[A]	0.5 (12 W lamp load, channels 00 ... 003 can be connected in parallel to 04 ... 07)	0.25 (6 W lamp load)
Fuse protection (short circuit)		Internal electronic fuse per channel		
Intrinsic current consumption at nominal operating voltage		[mA]	Typically 22	Typically 15
Operating voltage	Nominal value [V DC]	24	24	
	Permissible range [V DC]	18 ... 30	18 ... 30	
Electrical isolation, inputs	Channel – channel	No	No	
	Channel – internal bus	No	No	
Electrical isolation, outputs	Channel – channel	No	No	
	Channel – internal bus	Yes, using an intermediate supply	No	
Characteristic	Inputs	IEC 1131-T2	IEC 1131-T2, type 01	
	Outputs	IEC 1131-T2	IEC 1131-T2	
Switching level, inputs	Signal 0 [V DC]	≤ 5	≤ 5	
	Signal 1 [V DC]	≥ 11	≥ 15	
Input debounce time		[ms]	3 (0.1 ms, 10 ms, 20 ms parameterisable)	
Switching logic			Positive logic (PNP)	Positive logic (PNP)
LED displays	Group diagnostics	1	1	
	Channel diagnostics	–	–	
	Channel status	16	16	
Diagnostics			<ul style="list-style-type: none"> • Short circuit/overload per channel • Undervoltage at outputs 	
Parameterisation			<ul style="list-style-type: none"> • Input debounce time • Failsafe per channel • Forces per channel • Idle mode per channel • Signal extension time • Module monitoring • Behaviour after short circuit 	
Protection class to EN 60529			Depending on connection block	IP20
Temperature range	Operation [°C]	–5 ... +50	–5 ... +50	
	Storage/transport [°C]	–20 ... +70	–20 ... +70	
Materials			Reinforced PA, PC	Reinforced PA
Note on materials			–	RoHS-compliant
Grid dimension		[mm]	50	50
Dimensions (incl. interlinking block and connection block)		[mm]	50 x 107 x 50	50 x 107 x 41
W x L x H				
Product weight		[g]	38	Approx. 170

Terminal CPX

Technical data – Input/output module, digital

Connection and display components

CPX-8DE-8DA

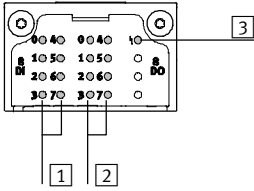

- 1 Status LEDs (green)
For allocation to inputs
→ pin allocation for module
- 2 Status LEDs (yellow)
For allocation to outputs
→ pin allocation for module
- 3 Error LED (red)
(module error)

CPX-L-8DE-8DA

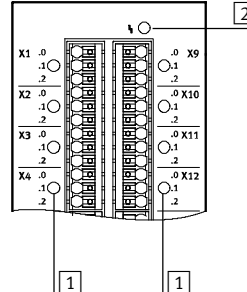

- 1 Status LEDs (green)
for each input signal
- 2 Error LED (red, module error)

Connection block/digital I/O module combinations

Connection blocks	Part No.	Digital I/O module	
		CPX-8DE-8DA	CPX-L-8DE-8DA
CPX-AB-4-M12-8POL	526178	■	–
CPX-AB-8-KL-4POL	195708	■	–
CPX-AB-1-SUB-BU-25POL	525676	■	–

Pin allocation

Connection block inputs/outputs	CPX-8DE-8DA	
CPX-AB-4-M12-8POL		
	<p>X1.1: 24 V_{SEN} X1.2: Input x X1.3: Input x+1 X1.4: 0 V_{SEN} X1.5: Output x X1.6: Output x+1 X1.7: Input x+4 X1.8: 0 V_{OUT}</p> <p>X2.1: 24 V_{SEN} X2.2: Input x+2 X2.3: Input x+3 X2.4: 0 V_{SEN} X2.5: Output x+2 X2.6: Output x+3 X2.7: Input x+6 X2.8: 0 V_{OUT}</p>	<p>X3.1: 24 V_{SEN} X3.2: Input x+4 X3.3: Input x+5 X3.4: 0 V_{SEN} X3.5: Output x+4 X3.6: Output x+5 X3.7: n.c. X3.8: 0 V_{OUT}</p> <p>X4.1: 24 V_{SEN} X4.2: Input x+6 X4.3: Input x+7 X4.4: 0 V_{SEN} X4.5: Output x+6 X4.6: Output x+7 X4.7: n.c. X4.8: 0 V_{OUT}</p>

Terminal CPX

Technical data – Input/output module, digital

Pin allocation																																	
Connection block inputs/outputs	CPX-8DE-8DA																																
CPX-AB-8-KL-4POL																																	
	<table border="0"> <tr> <td>X1.0: 24 V_{SEN}</td> <td>X5.0: Output x+4</td> </tr> <tr> <td>X1.1: 0 V_{SEN}</td> <td>X5.1: 0 V_{OUT}</td> </tr> <tr> <td>X1.2: Input x</td> <td>X5.2: Output x</td> </tr> <tr> <td>X1.3: FE</td> <td>X5.3: FE</td> </tr> <tr> <td>X2.0: Input x+4</td> <td>X6.0: Output x+5</td> </tr> <tr> <td>X2.1: Input x+5</td> <td>X6.1: 0 V_{OUT}</td> </tr> <tr> <td>X2.2: Input x+1</td> <td>X6.2: Output x+1</td> </tr> <tr> <td>X2.3: FE</td> <td>X6.3: FE</td> </tr> <tr> <td>X3.0: 24 V_{SEN}</td> <td>X7.0: Output x+6</td> </tr> <tr> <td>X3.1: 0 V_{SEN}</td> <td>X7.1: 0 V_{OUT}</td> </tr> <tr> <td>X3.2: Input x+2</td> <td>X7.2: Output x+2</td> </tr> <tr> <td>X3.3: FE</td> <td>X7.3: FE</td> </tr> <tr> <td>X4.0: Input x+6</td> <td>X8.0: Output x+7</td> </tr> <tr> <td>X4.1: Input x+7</td> <td>X8.1: 0 V_{OUT}</td> </tr> <tr> <td>X4.2: Input x+3</td> <td>X8.2: Output x+3</td> </tr> <tr> <td>X4.3: FE</td> <td>X8.3: FE</td> </tr> </table>	X1.0: 24 V _{SEN}	X5.0: Output x+4	X1.1: 0 V _{SEN}	X5.1: 0 V _{OUT}	X1.2: Input x	X5.2: Output x	X1.3: FE	X5.3: FE	X2.0: Input x+4	X6.0: Output x+5	X2.1: Input x+5	X6.1: 0 V _{OUT}	X2.2: Input x+1	X6.2: Output x+1	X2.3: FE	X6.3: FE	X3.0: 24 V _{SEN}	X7.0: Output x+6	X3.1: 0 V _{SEN}	X7.1: 0 V _{OUT}	X3.2: Input x+2	X7.2: Output x+2	X3.3: FE	X7.3: FE	X4.0: Input x+6	X8.0: Output x+7	X4.1: Input x+7	X8.1: 0 V _{OUT}	X4.2: Input x+3	X8.2: Output x+3	X4.3: FE	X8.3: FE
X1.0: 24 V _{SEN}	X5.0: Output x+4																																
X1.1: 0 V _{SEN}	X5.1: 0 V _{OUT}																																
X1.2: Input x	X5.2: Output x																																
X1.3: FE	X5.3: FE																																
X2.0: Input x+4	X6.0: Output x+5																																
X2.1: Input x+5	X6.1: 0 V _{OUT}																																
X2.2: Input x+1	X6.2: Output x+1																																
X2.3: FE	X6.3: FE																																
X3.0: 24 V _{SEN}	X7.0: Output x+6																																
X3.1: 0 V _{SEN}	X7.1: 0 V _{OUT}																																
X3.2: Input x+2	X7.2: Output x+2																																
X3.3: FE	X7.3: FE																																
X4.0: Input x+6	X8.0: Output x+7																																
X4.1: Input x+7	X8.1: 0 V _{OUT}																																
X4.2: Input x+3	X8.2: Output x+3																																
X4.3: FE	X8.3: FE																																
CPX-AB-1-SUB-BU-25POL																																	
	<table border="0"> <tr> <td>1: Input x</td> <td>14: Output x</td> </tr> <tr> <td>2: Input x+1</td> <td>15: Output x+1</td> </tr> <tr> <td>3: Input x+2</td> <td>16: Output x+2</td> </tr> <tr> <td>4: Input x+3</td> <td>17: Output x+3</td> </tr> <tr> <td>5: Input x+4</td> <td>18: Output x+4</td> </tr> <tr> <td>6: Input x+5</td> <td>19: Output x+5</td> </tr> <tr> <td>7: Input x+6</td> <td>20: Output x+6</td> </tr> <tr> <td>8: Input x+7</td> <td>21: Output x+7</td> </tr> <tr> <td>9: 24 V_{SEN}</td> <td>22: 0 V_{OUT}</td> </tr> <tr> <td>10: 24 V_{SEN}</td> <td>23: 0 V_{OUT}</td> </tr> <tr> <td>11: 0 V_{SEN}</td> <td>24: 0 V_{OUT}</td> </tr> <tr> <td>12: 0 V_{SEN}</td> <td>25: FE</td> </tr> <tr> <td>13: FE</td> <td>Socket: FE</td> </tr> </table>	1: Input x	14: Output x	2: Input x+1	15: Output x+1	3: Input x+2	16: Output x+2	4: Input x+3	17: Output x+3	5: Input x+4	18: Output x+4	6: Input x+5	19: Output x+5	7: Input x+6	20: Output x+6	8: Input x+7	21: Output x+7	9: 24 V _{SEN}	22: 0 V _{OUT}	10: 24 V _{SEN}	23: 0 V _{OUT}	11: 0 V _{SEN}	24: 0 V _{OUT}	12: 0 V _{SEN}	25: FE	13: FE	Socket: FE						
1: Input x	14: Output x																																
2: Input x+1	15: Output x+1																																
3: Input x+2	16: Output x+2																																
4: Input x+3	17: Output x+3																																
5: Input x+4	18: Output x+4																																
6: Input x+5	19: Output x+5																																
7: Input x+6	20: Output x+6																																
8: Input x+7	21: Output x+7																																
9: 24 V _{SEN}	22: 0 V _{OUT}																																
10: 24 V _{SEN}	23: 0 V _{OUT}																																
11: 0 V _{SEN}	24: 0 V _{OUT}																																
12: 0 V _{SEN}	25: FE																																
13: FE	Socket: FE																																

Terminal CPX



Technical data – Input/output module, digital

Pin allocation		
Connection block inputs	CPX-L-8DE-8DA	
	<p>X1.0: 24 V_{SEN} X1.1: Input x X1.2: 0 V_{SEN+out}</p> <p>X2.0: 24 V_{SEN} X2.1: Input x+1 X2.2: 0 V_{SEN+out}</p> <p>X3.0: 24 V_{SEN} X3.1: Input x+2 X3.2: 0 V_{SEN+out}</p> <p>X4.0: 24 V_{SEN} X4.1: Input x+3 X4.2: 0 V_{SEN+out}</p> <p>X5.0: 24 V_{SEN} X5.1: Input x+4 X5.2: 0 V_{SEN+out}</p> <p>X6.0: 24 V_{SEN} X6.1: Input x+5 X6.2: 0 V_{SEN+out}</p> <p>X7.0: 24 V_{SEN} X7.1: Input x+6 X7.2: 0 V_{SEN+out}</p> <p>X8.0: 24 V_{SEN} X8.1: Input x+7 X8.2: 0 V_{SEN+out}</p>	<p>X9.0: 24 V_{SEN} X9.1: Output x X9.2: 0 V_{SEN+out}</p> <p>X10.0: 24 V_{SEN} X10.1: Output x+1 X10.2: 0 V_{SEN+out}</p> <p>X11.0: 24 V_{SEN} X11.1: Output x+2 X11.2: 0 V_{SEN+out}</p> <p>X12.0: 24 V_{SEN} X12.1: Output x+3 X12.2: 0 V_{SEN+out}</p> <p>X13.0: 24 V_{SEN} X13.1: Output x+4 X13.2: 0 V_{SEN+out}</p> <p>X14.0: 24 V_{SEN} X14.1: Output x+5 X14.2: 0 V_{SEN+out}</p> <p>X15.0: 24 V_{SEN} X15.1: Output x+6 X15.2: 0 V_{SEN+out}</p> <p>X16.0: 24 V_{SEN} X16.1: Output x+7 X16.2: 0 V_{SEN+out}</p>
Interlinking block	CPX-L-8DE-8DA	
	<p>The module combines the 0 V potential of the power supply for electronics and sensors with the 0 V potential of the power supply for outputs in the CPX interlinking module.</p>	<p>If all poles of the outputs of an output module connected to the right of the input/output module are to be switched off, an appropriate interlinking block with additional power supply for outputs must be used to the right of the input/output module.</p>

Terminal CPX

Accessories – Input/output module, digital

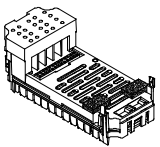
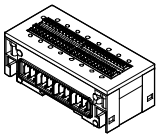
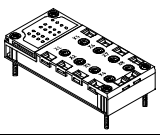
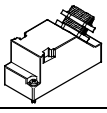
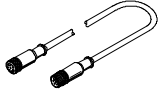
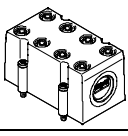
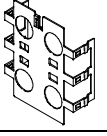
FESTO

Ordering data			
Designation		Part No.	Type
Input/output module, digital			
	8 digital inputs, 8 digital outputs	526257	CPX-8DE-8DA
	8 digital inputs, 8 digital outputs, for CPX in plastic, including interlinking block and connection block with spring-loaded terminals	572607	CPX-L-8DE-8DA-16-KL-3POL
Connection block			
	Plastic	4x socket, M12, 8-pin	526178 CPX-AB-4-M12-8POL
		Spring-loaded terminal, 32-pin	195708 CPX-AB-8-KL-4POL
		1x socket, Sub-D, 25-pin	525676 CPX-AB-1-SUB-BU-25POL
Plug			
	Plug, Sub-D, 25-pin	527522	SD-SUB-D-ST25
Connecting cable			
	Connecting cable M12	525617	KM12-8GD8GS-2-PU
Cover			
	Cover for CPX-AB-8-KL-4POL (IP65/67) – 8 cable through-feeds M9 – 1 cable through-feed for multi-pin plug	538219	AK-8KL
	Fittings kit	538220	VG-K-M9
Screening plate			
	Screening plate for M12 connections	526184	CPX-AB-S-4-M12
Manual			
	Manual	German	526439 P.BE-CPX-EA-DE
		English	526440 P.BE-CPX-EA-EN
		Spanish	526441 P.BE-CPX-EA-ES
		French	526442 P.BE-CPX-EA-FR
		Italian	526443 P.BE-CPX-EA-IT
		Swedish	526444 P.BE-CPX-EA-SV

Terminal CPX

Technical data – Counter module, digital

Function

The counter module has two channels. Depending on the parameterisation, these can independently be used as counter inputs or as incremental value encoder inputs or SSI. The counter module additionally has one output per channel. The outputs can either be controlled by a counter channel or an incremental value encoder channel, i.e. through an event such as "Comparative value reached". Alternatively, outputs can also be controlled via process data.

Application

- Continuous counting
- One-off counting to count limit
- One-off counting to count limit, return to load value
- Periodic counting
- Measurement of frequencies
- Measurement of rotational speeds
- Measurement of duty cycle
- Measurement of position
- Measurement of speed
- Measurement with pulse generators
- Measurement with pulse generators and direction encoders
- Measurement with incremental encoders
- Measurement with SSI absolute encoders



Description

Applications

- | | | | |
|---|--|--|---|
| <ul style="list-style-type: none"> • Recording travel and speed of a conveyor • Position and speed synchronisation of conveyors and pick & place applications • Counting goods e.g. in packaging installations | <ul style="list-style-type: none"> • Systems for filling by weight and volume • Monitoring motor speeds • Measuring equipment for determining the position of axis systems (linear, rotational) | <ul style="list-style-type: none"> • Control of fast-switching valves • Control of the opening time of a valve • Activation of semiconductor relays | <ul style="list-style-type: none"> • Temperature monitoring and rotational speed control for drives • Change of direction in fast drives • Control of motors with pulse-width modulation (PWM) |
|---|--|--|---|

Supported devices

- | | | | |
|---|--|--|--|
| <ul style="list-style-type: none"> • 5 V incremental encoder, single-ended or differential, with two 90° phase offset tracks | <ul style="list-style-type: none"> • 24 V incremental encoder, single-ended, with two 90° phase offset tracks | <ul style="list-style-type: none"> • 24 V pulse generator with or without direction level • 24 V direct current motors | <ul style="list-style-type: none"> • Absolute encoder with SSI interface (13 bits to 25 bits) |
|---|--|--|--|

Terminal CPX

Technical data – Counter module, digital

General technical data			
Type		CPX-2ZE2DA	
Number	Inputs	2	
	Outputs	2	
Max. power supply per module	Inputs	[A]	2
	Outputs	[A]	10
Max. power supply per channel		[A]	5 (adjustable, 20 W lamp load)
Max. cable length		[m]	30
Fuse protection (short circuit)	Internal electronic fuse per channel		
Intrinsic current consumption at nominal operating voltage		[mA]	Typically 35
Operating voltage	Nominal value	[V DC]	24
	Permissible range	[V DC]	18 ... 30
Electrical isolation, inputs	Channel – channel	No	
	Channel – internal bus	No	
Electrical isolation, outputs	Channel – channel	No	
	Channel – internal bus	Yes, using an intermediate supply	
Characteristic curve	Inputs	To IEC 1131-2, Type 02	
	Outputs	IEC 1131-T2	
Switching level	Signal 0	[V DC]	≤ 5
	Signal 1	[V DC]	≥ 11
Input debounce time		[μs]	0.1 (0.2μs, 0.4μs, 0.8μs, 1μs, 2μs, 4μs, 8μs, 10μs, 50μs, 100μs, 500μs, 1ms, 3ms, 10ms, 20ms parameterisable)
Switching logic	Inputs	Positive logic (PNP)	
	Outputs	<ul style="list-style-type: none"> • Negative logic (NPN) • Positive logic (PNP) • Push-pull driver 	
LED displays	Group diagnostics	1	
	Channel diagnostics	2	
	Channel status	10	
	Module diagnostics	2	
Diagnostics	Operating mode-dependent diagnostics		
Parameterisation	<ul style="list-style-type: none"> • Switch-on/off delay • Frequency output • Speed measurement • Pulse output • Pulse train • Rotational speed measurement • Frequency measurement • Duty cycle measurement • Engine operating mode • Determination of position • Pulse width modulation • One-off counting • Continuous counting • Periodic counting 		
Protection class to EN 60529	IP65/IP67		
Temperature range	Operation	[°C]	-5 ... +50
	Storage/transport	[°C]	-20 ... +70
Housing material information	Plastic		
Note on materials	RoHS-compliant		
Grid dimension		[mm]	50
Dimensions (incl. interlinking block and connection block) W x L x H		[mm]	50 x 107 x 50
Product weight		[g]	130

Terminal CPX

Technical data – Counter module, digital

Connection and display components

CPX-2ZE2DA

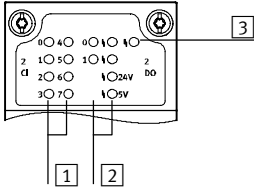

- 1 Status LEDs (green)
For allocation to inputs
→ Pin allocation for module
- 2 Status LEDs (yellow, red)
For allocation to outputs
→ Pin allocation for module
- 3 Error LED (red)
(module error)

Pin allocation

Inputs/outputs	CPX-2ZE2DA	
	Channel 0	Channel 1
	<p>Channel 0</p> <p>X1.0: Input X1.1: Input X1.2: Input X1.3: Input</p> <p>X2.0: Input X2.1: Input X2.2: 5 V DC X2.3: 0 V</p> <p>X3.0: 24 V DC X3.1: 0 V X3.2: 24 V DC for digital input DI X3.3: Digital input DI</p> <p>X4.0: 0 V for digital input DI X4.1: Digital output DO X4.2: Reference potential for DO X4.3: FE</p>	<p>Channel 1</p> <p>X5.0: Input X5.1: Input X5.2: Input X5.3: Input</p> <p>X6.0: Input X6.1: Input X6.2: 5 V DC X6.3: 0 V</p> <p>X7.0: 24 V DC X7.1: 0 V X7.2: 24 V DC for digital input DI X7.3: Digital input DI</p> <p>X8.0: 0 V for digital input DI X8.1: Digital output DO X8.2: Reference potential for DO X8.3: FE</p>

Note

The allocation and designation of inputs differs fundamentally depending on which type of encoder is connected. Appropriate allocation diagrams can be found in the user documentation for the counter module.

Terminal CPX

Accessories – Counter module, digital

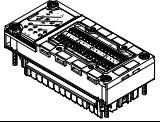
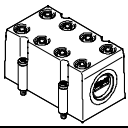
Ordering data			
Description		Part No.	Type
Counter module, digital			
	2 digital inputs, 2 digital outputs	576046	CPX-2ZE2DA
Cover			
	Cover for CPX-2ZE2DA (IP65/67) – 8 cable through-feeds M9 – 1 cable through-feed for multi-pin plug	538219	AK-8KL
	Fittings kit	538220	VG-K-M9

Terminal CPX

Technical data – Analogue module for inputs

Function

Analogue modules control devices with a standardised analogue interface such as sensors for pressure, temperature, flow rate, filling level, etc.

The analogue module supports various connection concepts with different numbers of sockets or terminals as appropriate to the connection block selected.

Application

- Analogue module for 0 ... 10 V, 0 ... 20 mA or 4 ... 20 mA
- Supports connection blocks with Sub-D, terminal connection and M12 connection
- Analogue module features can be parameterised
- Different data formats available
- Operation with and without galvanic isolation possible
- The analogue module receives the voltage supply for the electronics and the sensors from the interlinking block
- Analogue module protection and diagnostics through integrated electronic fuse protection



General technical data					
Type	CPX-2AE-U-I		CPX-4AE-U-I		CPX-4AE-I
	Voltage input	Current input	Voltage input	Current input	Current input
No. of analogue inputs	2		4		2 or 4
Max. power supply per module [A]	0.7				
Fuse protection	Internal electronic fuse				
Current consumption from 24 V sensor supply (quiescent current) [mA]	Typically 50				
Current consumption from 24 V sensor supply (at full load) [A]	Max. 0.7				
Nominal operating voltage, load voltage [V DC]	24 ±2%				
Nominal operating voltage [V DC]	24				
Operating voltage range [V DC]	18 ... 30				
Signal range (parameterisable for each channel by means of DIL switch or software)	0 ... 10 V	0 ... 20 mA 4 ... 20 mA	1 ... 5 V 0 ... 10 V -5 ... +5 V -10 ... +10 V	0 ... 20 mA 4 ... 20 mA -20 ... +20 mA	0 ... 20 mA 4 ... 20 mA
Operational error limit [%]	±0.5	–	±0.3	±0.3	±0.6
Basic error limit (at 25 °C) [%]	±0.3	–	±0.2	±0.2	±0.5
Repetition accuracy (at 25 °C) [%]	0.15	0.15	0.1	0.1	0.15
Input resistance	100 kΩ	≤ 100 Ω	100 kΩ	≤ 100 Ω	≤ 100 Ω
Max. permissible input voltage [V DC]	30	–	-30 ... +30	–	–
Max. permissible input current [mA]	–	40	–	Internally limited to 60	40
Conversion time per channel [μs]	Typically 150				
Cycle time (module) [ms]	≤ 4		≤ 0.5		≤ 10
Data format	12 bit + prefix		15 bit + prefix		12 bit + prefix
	Scalable to 15 bit		Scalable to 15 bit		Scalable to 15 bit
Cable length [m]	Max. 30 (shielded)				

Terminal CPX

Technical data – Analogue module for inputs

General technical data		CPX-2AE-U-I	CPX-4AE-U-I	CPX-4AE-I
Electrical isolation	Channel – channel	No		
	Channel – internal bus	Yes, with external sensor supply		
LED displays	Group diagnostics	1		
	Channel diagnostics	Via flashing frequency of group diagnostics	4	Via flashing frequency of group diagnostics
Diagnostics	Wire break per channel			
	Limit value violation per channel			
	Parameterisation error			
	Short circuit, input signal	Overload at input	Short circuit, input signal	
	–	Overflow/underflow	–	
	–	Short circuit in sensor supply	–	
Parameterisation	Data format			
	Forces per channel			
	Limit value monitoring per channel			
	Measured value smoothing			
	Signal range per channel			
	Wire break monitoring per channel			
	Behaviour after short circuit			
	–	Behaviour after overload at input	–	
	–	Sensor supply active	–	
	Protection class to EN 60529	Depending on connection block		
Temperature range	Operation	[°C] –5 ... +50		
	Storage/transport	[°C] –20 ... +70		
Materials	Reinforced PA, PC			
Note on materials	–		RoHS-compliant	–
Grid dimension	[mm]		50	
Dimensions (incl. interlinking block and connection block) W x L x H	[mm]		50 x 107 x 50	
Product weight	[g]		38	46
			38	

Internal structure, basic representation

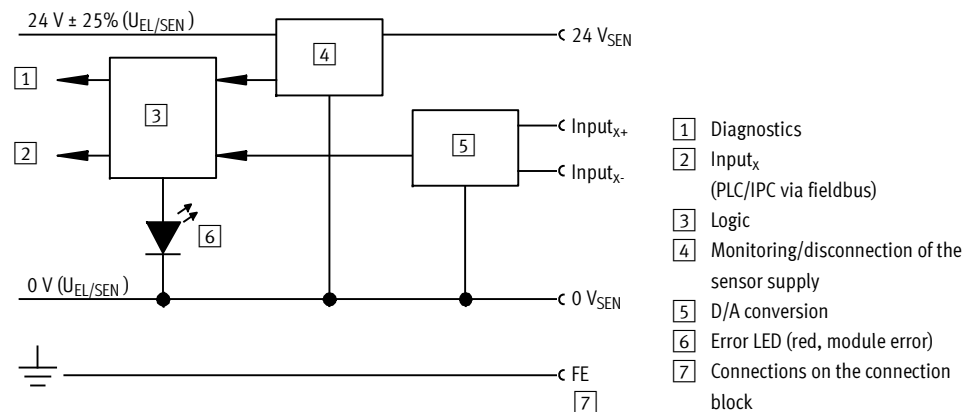

Terminal CPX

Technical data – Analogue module for inputs

Connection and display components

CPX-2AE-U-I and CPX-4AE-I

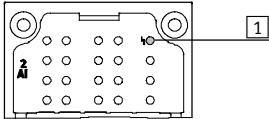

1 Error LED (red, module error)

CPX-4AE-U-I

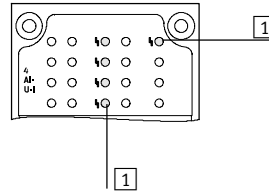

1 Error LED (red, module error)
2 Channel-related error LEDs (red)

Connection block/analogue module combinations

Connection blocks	Part No.	Analogue module		
		CPX-2AE-U-I	CPX-4AE-U-I	CPX-4AE-I
CPX-AB-4-M12X2-5POL	195704	■	■	■
CPX-AB-4-M12X2-5POL-R	541254	■	■	■
CPX-AB-8-KL-4POL	195708	■	■	■
CPX-AB-1-SUB-BU-25POL	525676	■	■	■
CPX-M-AB-4-M12X2-5POL	549367	■	■	■

Pin allocation

Connection block inputs	CPX-2AE-U-I	CPX-4AE-U-I	CPX-4AE-I
CPX-AB-4-M12X2-5POL, CPX-AB-4-M12X2-5POL-R¹⁾ and CPX-M-AB-4-M12X2-5POL			
	X1.1: 24 V _{SEN} X1.2: Input U0+ X1.3: 0 V _{SEN} X1.4: Input U0- X1.5: FE ²⁾	X3.1: 24 V _{SEN} X3.2: Input U1+ X3.3: 0 V _{SEN} X3.4: Input U1- X3.5: FE ²⁾	X1.1: 24 V _{SEN} X1.2: Input 0+ X1.3: 0 V _{SEN} X1.4: Input 0- X1.5: FE ²⁾
	X2.1: 24 V _{SEN} X2.2: Input I0+ X2.3: 0 V _{SEN} X2.4: Input I0- X2.5: FE ²⁾	X4.1: 24 V _{SEN} X4.2: Input I1+ X4.3: 0 V _{SEN} X4.4: Input I1- X4.5: FE ²⁾	X3.1: 24 V _{SEN} X3.2: Input 2+ X3.3: 0 V _{SEN} X3.4: Input 2- X3.5: FE ²⁾
			X1.1: 24 V _{SEN} X1.2: Input I0+ X1.3: 0 V _{SEN} X1.4: Input I0- X1.5: FE ²⁾
			X3.1: 24 V _{SEN} X3.2: Input I2+ X3.3: 0 V _{SEN} X3.4: Input I2- X3.5: FE ²⁾
CPX-AB-8-KL-4POL			
	X1.0: 24 V _{SEN} X1.1: 0 V _{SEN} X1.2: Input U0- X1.3: FE	X5.0: 24 V _{SEN} X5.1: 0 V _{SEN} X5.2: Input U1- X5.3: FE	X1.0: 24 V _{SEN} X1.1: 0 V _{SEN} X1.2: Input 0- X1.3: FE
	X2.0: n.c. X2.1: n.c. X2.2: Input U0+ X2.3: FE	X6.0: n.c. X6.1: n.c. X6.2: Input U1+ X6.3: FE	X5.0: 24 V _{SEN} X5.1: 0 V _{SEN} X5.2: Input 2- X5.3: FE
			X1.0: 24 V _{SEN} X1.1: 0 V _{SEN} X1.2: Input I0- X1.3: FE
			X3.0: 24 V _{SEN} X3.1: 0 V _{SEN} X3.2: Input I0- X3.3: FE
			X5.0: 24 V _{SEN} X5.1: 0 V _{SEN} X5.2: Input 2+ X5.3: FE
			X1.0: 24 V _{SEN} X1.1: 0 V _{SEN} X1.2: Input I0+ X1.3: FE
			X3.0: 24 V _{SEN} X3.1: 0 V _{SEN} X3.2: Input I1- X3.3: FE
			X5.0: 24 V _{SEN} X5.1: 0 V _{SEN} X5.2: Input 3+ X5.3: FE
			X1.0: 24 V _{SEN} X1.1: 0 V _{SEN} X1.2: Input I1- X1.3: FE
			X3.0: 24 V _{SEN} X3.1: 0 V _{SEN} X3.2: Input I3- X3.3: FE
			X5.0: 24 V _{SEN} X5.1: 0 V _{SEN} X5.2: Input I2+ X5.3: FE
			X1.0: 24 V _{SEN} X1.1: 0 V _{SEN} X1.2: Input I2- X1.3: FE
			X3.0: 24 V _{SEN} X3.1: 0 V _{SEN} X3.2: Input I3- X3.3: FE
			X5.0: 24 V _{SEN} X5.1: 0 V _{SEN} X5.2: Input I3+ X5.3: FE
			X1.0: 24 V _{SEN} X1.1: 0 V _{SEN} X1.2: Input I3- X1.3: FE
			X3.0: 24 V _{SEN} X3.1: 0 V _{SEN} X3.2: Input I3+ X3.3: FE
			X5.0: 24 V _{SEN} X5.1: 0 V _{SEN} X5.2: Input I3+ X5.3: FE
			X1.0: 24 V _{SEN} X1.1: 0 V _{SEN} X1.2: Input I3+ X1.3: FE
			X3.0: 24 V _{SEN} X3.1: 0 V _{SEN} X3.2: Input I3+ X3.3: FE
			X5.0: 24 V _{SEN} X5.1: 0 V _{SEN} X5.2: Input I3+ X5.3: FE

1) Speedcon quick lock, shield additionally on metal thread
2) FE/shield additionally on metal thread

Terminal CPX

Technical data – Analogue module for inputs

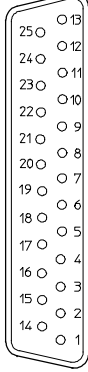

Pin allocation							
Connection block inputs	CPX-2AE-U-I		CPX-4AE-U-I		CPX-4AE-I		
CPX-AB-1-SUB-BU-25POL							
	1: Input U0-	14: Input U1-	1: Input 0-	14: Input 2-	1: Input I0-	14: Input I2-	
	2: Input U0+	15: Input U1+	2: Input 0+	15: Input 2+	2: Input I0+	15: Input I2+	
	3: Input I0-	16: Input I1-	3: Input 1-	16: Input 3-	3: Input I1-	16: Input I3-	
	4: Input I1+	17: Input I1+	4: Input 1+	17: Input 3+	4: Input I1+	17: Input I3+	
	5: n.c.	18: 24 V _{SEN}	5: n.c.	18: 24 V _{SEN}	5: n.c.	18: 24 V _{SEN}	
	6: n.c.	19: n.c.	6: n.c.	19: n.c.	6: n.c.	19: n.c.	
	7: n.c.	20: 24 V _{SEN}	7: n.c.	20: 24 V _{SEN}	7: n.c.	20: 24 V _{SEN}	
	8: n.c.	21: n.c.	8: n.c.	21: n.c.	8: n.c.	21: n.c.	
	9: 24 V _{SEN}	22: 0 V _{SEN}	9: 24 V _{SEN}	22: 0 V _{SEN}	9: 24 V _{SEN}	22: 0 V _{SEN}	
	10: 24 V _{SEN}	23: 0 V _{SEN}	10: 24 V _{SEN}	23: 0 V _{SEN}	10: 24 V _{SEN}	23: 0 V _{SEN}	
	11: 0 V _{SEN}	24: 0 V _{SEN}	11: 0 V _{SEN}	24: 0 V _{SEN}	11: 0 V _{SEN}	24: 0 V _{SEN}	
	12: 0 V _{SEN}	25: FE	12: 0 V _{SEN}	25: FE	12: 0 V _{SEN}	25: FE	
	13: Shield ¹⁾	Socket: FE	13: Shield ¹⁾	Socket: FE	13: Shield ¹⁾	Socket: FE	

1) Connect shield to functional earth FE

Terminal CPX

Accessories – Analogue module for inputs

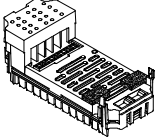
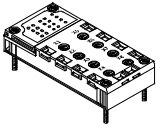
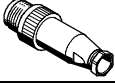
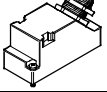
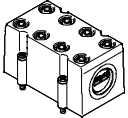
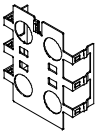
FESTO

Ordering data		Part No.	Type
Input module, analogue			
	2 analogue current or voltage inputs	526168	CPX-2AE-U-I
	4 analogue current or voltage inputs	573710	CPX-4AE-U-I
	2 or 4 analogue current inputs	541484	CPX-4AE-I
Connection block			
	Plastic	4x socket, M12, 5-pin	195704 CPX-AB-4-M12X2-5POL
		4x socket, M12 with quick-lock technology, 5-pin	541254 CPX-AB-4-M12X2-5POL-R
		Spring-loaded terminal, 32-pin	195708 CPX-AB-8-KL-4POL
		1x socket, Sub-D, 25-pin	525676 CPX-AB-1-SUB-BU-25POL
	Metal	4x socket, M12, 5-pin	549367 CPX-M-AB-4-M12X2-5POL
Plug			
	Plug, M12, 5 pin	175487	SEA-M12-5GS-PG7
	Plug, Sub-D, 25-pin	527522	SD-SUB-D-ST25
Cover			
	Cover for CPX-AB-8-KL-4POL (IP65/67) – 8 cable through-feeds M9 – 1 cable through-feed for multi-pin plug	538219	AK-8KL
	Fittings kit	538220	VG-K-M9
Screening plate			
	Screening plate for M12 connections	526184	CPX-AB-S-4-M12
Manual			
	Manual	German	526415 P.BE-CPX-AX-DE
		English	526416 P.BE-CPX-AX-EN
		Spanish	526417 P.BE-CPX-AX-ES
		French	526418 P.BE-CPX-AX-FR
		Italian	526419 P.BE-CPX-AX-IT
		Swedish	526420 P.BE-CPX-AX-SV

Terminal CPX

Technical data – Analogue input module with pressure sensors

Function

The pressure input modules enable a maximum of four pressures to be processed. The internal measured value of the sensor (analogue value with 10 bit resolution) is converted into an internal numerical format as appropriate to the parameterisation and made available to the bus node as an image table. It is also possible to combine two channels into one differential pressure channel.

Applications

- Measuring range 0 ... 10 bar or -1 ... +1 bar
- Choice of units of measurement
- Processing of max. four pressures per module
- Pressure indication via LCD display
- Direct connection via QS4 push-in connectors
- Error message via CPX
- Channel-oriented diagnostics



General technical data			
Type	CPX-4AE-P-B2		CPX-4AE-P-D10
No. of analogue inputs	4		
Pneumatic connection	QS-4		
Nominal operating voltage	[V DC]	24	
Operating voltage range	[V DC]	18...30	
Intrinsic current consumption	[mA]	Typically 50	
Measured variable	4x relative or 2x differential pressure measurement		
Displayable units	<ul style="list-style-type: none"> • kPa • mbar • psi 		
Pressure measuring range	Starting value	[bar]	-1
	Final value	[bar]	1
			0
			10
Internal cycle time	[ms]	5	
Data format	<ul style="list-style-type: none"> • 15 bits + prefix • Binary representation in mbar, kPa, psi 		
LED displays	Group diagnostics		
Diagnostics	<ul style="list-style-type: none"> • Limit value violation per channel • Parameterisation error • Sensor limit per channel 		
Parameterisation	<ul style="list-style-type: none"> • Diagnostic delay per channel • Hysteresis per module • Unit of measurement • Measured value smoothing per channel • Limit value monitoring per channel • Sensor limit per channel • Measurement of relative/differential pressure 		
Protection class to EN 60529	IP65/IP67		
Operating medium	Compressed air in accordance with ISO 8573-1:2010 [7:4:4]		
Note on operating/pilot medium	Operation with lubricated medium possible (in which case lubricated operation will always be required)		
Ambient temperature	[°C]	-5... 50	
Storage temperature	[°C]	-20 ... 70	
Temperature of medium	[°C]	0... 50	
Note on materials	RoHS-compliant		
Materials	Reinforced polyamide, polycarbonate		
Grid dimension	[mm]	50	
Dimensions (incl. interlinking block) W x L x H	[mm]	50 x 107 x 55	
Weight	[g]	112	

-  - Note

Extreme pneumatic conditions, for example high cycle frequency with large pressure amplitudes, can damage the sensors.



Terminal CPX

Accessories – Analogue input module with pressure sensors

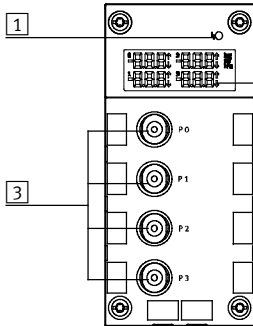
Connection and display components

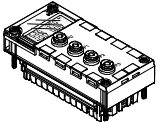
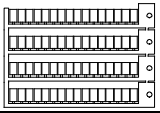

- 1 Error LED (red, module error)
- 2 LCD display with permanent display of the four measured pressures, unit of measurement and if applicable limit value violation
- 3 QS connections

Ordering data		Part No.	Type
Designation			
Input module, analogue			
	4 analogue pressure inputs, pressure range -1 ... +1 bar	560361	CPX-4AE-P-B2
	4 analogue pressure inputs, pressure range 0 ... 10 bar	560362	CPX-4AE-P-D10
Inscription labels			
	Inscription labels 6x10, 64 pieces, in frames	18576	IBS-6x10
User manual			
	User manual	German	526415 P.BE-CPX-AX-DE
		English	526416 P.BE-CPX-AX-EN
		Spanish	526417 P.BE-CPX-AX-ES
		French	526418 P.BE-CPX-AX-FR
		Italian	526419 P.BE-CPX-AX-IT
		Swedish	526420 P.BE-CPX-AX-SV

Terminal CPX

Technical data – Analogue module for temperature inputs

Function

The CPX-PT100 analogue input module with 4 channels for temperature measurement enables the connection of up to 4 temperature sensors of the type PT100-PT1000, Ni100-Ni1000, etc. The temperature module supports various connection concepts with different numbers of sockets or terminals as appropriate to the connection block selected.

Applications

- Temperature module for temperature sensors PT100, PT200, PT500, PT1000, Ni100, Ni120, Ni500, Ni1000
- Supports connection blocks with M12, Harax and terminal connection
- Temperature module features can be parameterised
- 2-wire, 3-wire and 4-wire connection
- The temperature module is provided with voltage supply for the electronics and the sensors via the interlinking block
- Temperature module protection and diagnostics through integrated electronic fuse protection



General technical data			
Type		CPX-4AE-T	
		Temperature input	
No. of analogue inputs		Choice of 2 or 4	
Max. power supply per module		[A]	0.7
Fuse protection		Internal electronic fuse for sensor supply	
Current consumption from 24 V sensor supply (quiescent current)		[mA]	Typically 50
Supply voltage of sensors		[V DC]	24 ±25%
Sensor type (parameterisable for each channel by means of DIL switch)		PT100, PT200, PT500, PT1000 Ni100, Ni120, Ni500, Ni1000	
Temperature range	Pt standard	[°C]	-200 ... +850
	Pt climatic	[°C]	-120 ... +130
	Ni	[°C]	-60 ... +180
Sensor connection technology		2-wire, 3-wire and 4-wire technology	
Resolution		15 bit + prefix	
Operating error limit relative to input range		[%]	±0.06
Basic error limit (25 °C)	Standard	[K]	±0.6
	Pt climatic	[K]	±0.2
Temperature errors relative to input range		[%]	±0.001
Linearity errors (no software scaling)		[%]	±0.02
Repetition accuracy (at 25 °C)		[%]	±0.05
Max. line resistance per wire		[Ω]	10
Max. permissible input voltage		[V]	±30
Cycle time (module)		[ms]	≤ 250

Terminal CPX

Technical data – Analogue module for temperature inputs

General technical data		
Data format		15 bit + prefix, complement of two, binary notation in tenths of a degree
Cable length	[m]	Max. 200 (screened)
Electrical isolation	Channel – channel	No
	Channel – internal bus	Yes
LED displays	Group diagnostics	1
	Channel diagnostics	4
Diagnostics		<ul style="list-style-type: none"> • Short circuit/overload, channel • Parameterisation error • Value falling below nominal range/full-scale value • Value exceeding nominal range/full-scale value • Wire break
Parameterisation		<ul style="list-style-type: none"> • Unit of measurement and interference frequency suppression • Diagnostic message in the event of a wire break or short circuit • Limit monitoring per channel • Sensor connection technology • Sensor type/temperature coefficient, temperature range • Limit value per channel • Measured value smoothing
Protection class to EN 60529		Depending on connection block
Temperature range	Operation	[°C] –5 ... +50
	Storage/transport	[°C] –20 ... +70
Materials		Polymer
Grid dimension	[mm]	50
Dimensions (incl. interlinking block and connection block) W x L x H	[mm]	50 x 107 x 50
Weight	[g]	38

Connection and display components

CPX-4AE-T

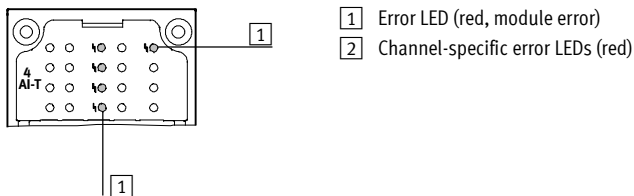

Connection block/analogue module combinations		
Connection blocks	Part No.	Temperature module
		CPX-4AE-T
CPX-AB-4-M12X2-5POL	195704	■
CPX-AB-4-M12X2-5POL-R	541254	■
CPX-AB-8-KL-4POL	195708	■
CPX-AB-4-HAR-4POL	525636	■
CPX-M-AB-4-M12X2-5POL	549367	■

Terminal CPX

Technical data – Analogue module for temperature inputs





Pin allocation		
Connection block inputs	CPX-4AE-T	
CPX-AB-4-M12X2-5POL, CPX-AB-4-M12X2-5POL-R ¹⁾ and CPX-M-AB-4-M12X2-5POL		
	<p>X1.1: Input I0+</p> <p>X1.2: Input U0+</p> <p>X1.3: Input I0-</p> <p>X1.4: Input U0-</p> <p>X1.5: FE²⁾</p> <p>X2.1: Input I1+</p> <p>X2.2: Input U1+</p> <p>X2.3: Input I1-</p> <p>X2.4: Input U1-</p> <p>X2.5: FE²⁾</p>	<p>X3.1: Input I2+</p> <p>X3.2: Input U2+</p> <p>X3.3: Input I2-</p> <p>X3.4: Input U2-</p> <p>X3.5: FE²⁾</p> <p>X4.1: Input I3+</p> <p>X4.2: Input U3+</p> <p>X4.3: Input I3-</p> <p>X4.4: Input U3-</p> <p>X4.5: FE²⁾</p>
CPX-AB-8-KL-4POL		
	<p>X1.0: Input I0+</p> <p>X1.1: Input I0-</p> <p>X1.2: Input U0-</p> <p>X1.3: FE</p> <p>X2.0: n.c.</p> <p>X2.1: n.c.</p> <p>X2.2: Input U0+</p> <p>X2.3: FE</p> <p>X3.0: Input I1+</p> <p>X3.1: Input I1-</p> <p>X3.2: Input U1-</p> <p>X3.3: FE</p> <p>X4.0: n.c.</p> <p>X4.1: n.c.</p> <p>X4.2: Input U1+</p> <p>X4.3: FE</p>	<p>X5.0: Input I2+</p> <p>X5.1: Input I2-</p> <p>X5.2: Input U2-</p> <p>X5.3: FE</p> <p>X6.0: n.c.</p> <p>X6.1: n.c.</p> <p>X6.2: Input U12+</p> <p>X6.3: FE</p> <p>X7.0: Input I3+</p> <p>X7.1: Input I3-</p> <p>X7.2: Input U3-</p> <p>X7.3: FE</p> <p>X8.0: n.c.</p> <p>X8.1: n.c.</p> <p>X8.2: Input U3+</p> <p>X8.3: FE</p>
CPX-AB-4-HAR-4POL		
	<p>X1.1: Input I0+</p> <p>X1.2: Input U0+</p> <p>X1.3: Input I0-</p> <p>X1.4: Input U0-</p> <p>X2.1: Input I1+</p> <p>X2.2: Input U1+</p> <p>X2.3: Input I1-</p> <p>X2.4: Input U1-</p>	<p>X3.1: Input I2+</p> <p>X3.2: Input U2+</p> <p>X3.3: Input I2-</p> <p>X3.4: Input U2-</p> <p>X4.1: Input I3+</p> <p>X4.2: Input U3+</p> <p>X4.3: Input I3-</p> <p>X4.4: Input U3-</p>

1) Speedcon quick lock, screening additionally on metal thread

2) FE/screening additionally on metal thread

Terminal CPX

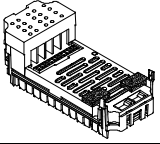
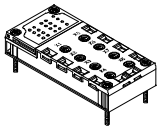
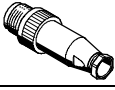
Accessories – Analogue module for temperature inputs

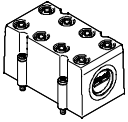
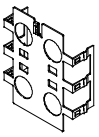
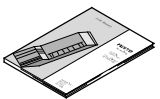
Ordering data			
Designation		Part No.	Type
Input module, analogue			
	2 or 4 analogue temperature inputs	541486	CPX-4AE-T
Connection block			
	Plastic	4x socket, M12, 5-pin	195704 CPX-AB-4-M12X2-5POL
		4x socket, M12 with quick-lock technology, 5-pin	541254 CPX-AB-4-M12X2-5POL-R
		Spring clip terminal, 32-pin	195708 CPX-AB-8-KL-4POL
		4x socket, quick connection, 4-pin	525636 CPX-AB-4-HAR-4POL
	Metal	4x socket, M12, 5-pin	549367 CPX-M-AB-4-M12X2-5POL
Plug			
	M12 plug, 5-pin	175487	SEA-M12-5GS-PG7
	HARAX plug, 4-pin	525928	SEA-GS-HAR-4POL
Cover			
	Cover for CPX-AB-8-KL-4POL (IP65/67) – 8 cable through-feeds M9 – 1 cable through-feed for multi-pin plug	538219	AK-8KL
	Fittings kit	538220	VG-K-M9
Screening plate			
	Screening plate for M12 connections	526184	CPX-AB-S-4-M12
User manual			
	User manual	German	526415 P.BE-CPX-AX-DE
		English	526416 P.BE-CPX-AX-EN
		Spanish	526417 P.BE-CPX-AX-ES
		French	526418 P.BE-CPX-AX-FR
		Italian	526419 P.BE-CPX-AX-IT
		Swedish	526420 P.BE-CPX-AX-SV

Terminal CPX

Technical data – Analogue module for thermocoupler

Function

The CPX-4AE-TC analogue input module with four channels for temperature measurement enables up to four thermocoupler sensors to be connected. The channels feature wire break and short circuit detection. If no cold junction compensation sensor is being used, an internal theoretical value of 25 °C can be used (accuracy is impaired).

Applications

- Supports connection blocks with M12 and terminal connection
- Temperature module features can be parameterised
- 2-wire connection
- 2-wire connection for a PT1000 sensor for cold junction compensation
- The temperature module is provided with voltage supply for the electronics and the sensors via the interlinking block
- Temperature module protection and diagnostics through integrated electronic fuse protection



General technical data		
Type		CPX-4AE-TC
		Temperature input
No. of analogue inputs		4
Fuse protection (short circuit)		Internal electronic fuse for each channel
Nominal operating voltage	[V DC]	24
Operating voltage range	[V DC]	18 ... 30
Sensor type (parameterisable for each channel by means of software)		<ul style="list-style-type: none"> • Type B +400 ... +1,820 °C, 8 µV/°C • Type E -270 ... +900 °C, 60 µV/°C • Type J -200 ... +1,200 °C, 51 µV/°C • Type K -200 ... +1,370 °C, 40 µV/°C • Type N -200 ... +1,300 °C, 38 µV/°C • Type R 0 ... +1,760 °C, 12 µV/°C • Type S 0 ... +1,760 °C, 11 µV/°C • Type T -200 ... +400 °C, 40 µV/°C
Sensor connection technology		2-wire technology
Operating error limit relative to ambient temperature	[%]	Max. ±0.6
Basic error limit (at 25 °C)	[%]	Max. ±0.4
Repetition accuracy (at 25 °C)	[%]	±0.05
Max. line resistance per wire	[Ω]	10
Max. residual current per module	[mA]	30
Max. permissible input voltage	[V]	±30
Internal cycle time (module)	[ms]	250

Terminal CPX

Technical data – Analogue module for thermocoupler

General technical data		
Data format		<ul style="list-style-type: none"> • 15 bit + prefix, complement of two • Binary notation in tenths of a degree
Cable length	[m]	Max. 50 (screened)
Electrical isolation	Channel – channel	No
	Channel – internal bus	Yes
LED displays	Group diagnostics	1
	Channel diagnostics	4
Diagnostics		<ul style="list-style-type: none"> • Parameterisation error • Wire break per channel • Limit value violation per channel
Parameterisation		<ul style="list-style-type: none"> • Wire break monitoring per channel • Unit of measurement • Cold junction compensation • Sensor type per channel • Limit value monitoring per channel • Measured value smoothing
Protection class to EN 60529		Depending on connection block
Temperature range	Operation [°C]	-5 ... +50
	Storage/transport [°C]	-20 ... +70
Materials		Reinforced polyamide, polycarbonate
Grid dimension	[mm]	50
Dimensions (incl. interlinking block and connection block) W x L x H	[mm]	50 x 107 x 50
Weight	[g]	38

Connection and display components

CPX-4AE-TC

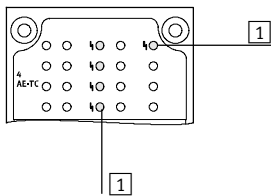

- 1 Error LED (red, module error)
- 2 Channel-specific error LEDs (red)

Connection block/analogue module combinations

Connection blocks	Part No.	Temperature module
		CPX-4AE-TC
CPX-AB-4-M12X2-5POL	195704	■
CPX-AB-4-M12X2-5POL-R	541254	■
CPX-AB-8-KL-4POL	195708	■
CPX-M-AB-4-M12x2-5POL	549367	■

Terminal CPX

Technical data – Analogue module for thermocoupler

Pin allocation		
Connection block inputs	CPX-4AE-TC	
CPX-AB-4-M12X2-5POL, CPX-AB-4-M12X2-5POL-R ¹⁾ and CPX-M-AB-4-M12X2-5POL		
	<p>X1.1: Input I0+</p> <p>X1.2: Input U0+</p> <p>X1.3: Input I0-</p> <p>X1.4: Input U0-</p> <p>X1.5: FE²⁾</p> <p>X2.1: Input I1+</p> <p>X2.2: Input U1+</p> <p>X2.3: Input I1-</p> <p>X2.4: Input U1-</p> <p>X2.5: FE²⁾</p>	<p>X3.1: Input I2+</p> <p>X3.2: Input U2+</p> <p>X3.3: Input I2-</p> <p>X3.4: Input U2-</p> <p>X3.5: FE²⁾</p> <p>X4.1: Input I3+</p> <p>X4.2: Input U3+</p> <p>X4.3: Input I3-</p> <p>X4.4: Input U3-</p> <p>X4.5: FE²⁾</p>
CPX-AB-8-KL-4POL		
	<p>X1.0: Input I0+</p> <p>X1.1: Input I0-</p> <p>X1.2: Input U0+</p> <p>X1.3: FE</p> <p>X2.0: n.c.</p> <p>X2.1: n.c.</p> <p>X2.2: Input U0+</p> <p>X2.3: FE</p> <p>X3.0: Input I1+</p> <p>X3.1: Input I1-</p> <p>X3.2: Input U1-</p> <p>X3.3: FE</p> <p>X4.0: n.c.</p> <p>X4.1: n.c.</p> <p>X4.2: Input U1+</p> <p>X4.3: FE</p>	<p>X5.0: Input I2+</p> <p>X5.1: Input I2-</p> <p>X5.2: Input U2-</p> <p>X5.3: FE</p> <p>X6.0: n.c.</p> <p>X6.1: n.c.</p> <p>X6.2: Input U12+</p> <p>X6.3: FE</p> <p>X7.0: Input I3+</p> <p>X7.1: Input I3-</p> <p>X7.2: Input U3-</p> <p>X7.3: FE</p> <p>X8.0: n.c.</p> <p>X8.1: n.c.</p> <p>X8.2: Input U3+</p> <p>X8.3: FE</p>

1) Speedcon quick lock, screening additionally on metal thread

2) FE/screening additionally on metal thread

Terminal CPX

Accessories – Analogue module for thermocoupler

FESTO

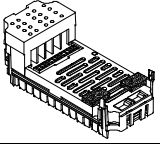
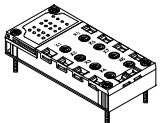
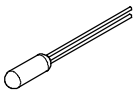
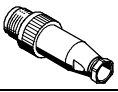
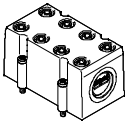
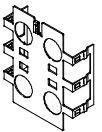
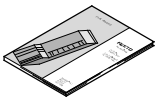
Ordering data			
Designation		Part No.	Type
Input module, analogue			
	4 analogue temperature inputs, with 2-wire connection for a PT1000 sensor for cold junction compensation		553594 CPX-4AE-TC
Connection block			
	Plastic	4x socket, M12, 5-pin	195704 CPX-AB-4-M12X2-5POL
		4x socket, M12 with quick-lock technology, 5-pin	541254 CPX-AB-4-M12X2-5POL-R
		Spring clip terminal, 32-pin	195708 CPX-AB-8-KL-4POL
	Metal	4x socket, M12, 5-pin	549367 CPX-M-AB-4-M12X2-5POL
Cold junction compensation			
	PT1000 temperature sensor for cold junction compensation		553596 CPX-W-PT1000
Plug			
	M12 plug, 5-pin		175487 SEA-M12-5GS-PG7
Cover			
	Cover for CPX-AB-8-KL-4POL (IP65/67) – 8 cable through-feeds M9 – 1 cable through-feed for multi-pin plug		538219 AK-8KL
	Fittings kit		538220 VG-K-M9
Screening plate			
	Screening plate for M12 connections		526184 CPX-AB-S-4-M12
User manual			
	User manual	German	526415 P.BE-CPX-AX-DE
		English	526416 P.BE-CPX-AX-EN
		Spanish	526417 P.BE-CPX-AX-ES
		French	526418 P.BE-CPX-AX-FR
		Italian	526419 P.BE-CPX-AX-IT
		Swedish	526420 P.BE-CPX-AX-SV

Terminal CPX

Technical data – Analogue module for outputs

Function

Analogue modules control devices with a standard analogue interface such as proportional valves, etc. The analogue module supports various connection concepts with different numbers of sockets or terminals as appropriate to the connection block selected.

Applications

- Analogue module for 0 ... 10 V, 0 ... 20 mA or 4 ... 20 mA
- Supports connection blocks with M12, Sub-D and terminal connection
- Analogue module features can be parameterised
- Different data formats available
- Operation with and without galvanic isolation possible
- The analogue module receives the voltage supply for the electronics and the actuators from the interlinking block
- Analogue module protection and diagnostics through integrated electronic fuse protection



General technical data				
Type		CPX-2AA-U-I		
		Voltage output	Current output	
No. of analogue outputs		2		
Max. actuator supply per module	[A]	2.8		
Fuse protection		Internal electronic fuse for actuator supply		
Current consumption from 24 V sensor supply (at full load)	[mA]	Max. 150		
Current consumption from 24 V actuator supply (at full load)	[A]	4 ... 10		
Supply voltage of actuators	[V DC]	24 ±25%		
Signal range (parameterisable for each channel by means of DIL switch or software)		0 ... 10 V DC	0 ... 20 mA 4 ... 2 mA	
Resolution	[bit]	12		
No. of units		4,096		
Absolute accuracy	[%]	±0.6		
Linearity errors (no software scaling)	[%]	±0.1		
Repetition accuracy (at 25 °C)	[%]	0.05		
Encoder selection	Load resistance for ohmic load	[kΩ]	Min. 1	Max. 0.5
	Load resistance for capacitive load	[μF]	Max. 1	–
	Load resistance for inductive load	[mH]	–	Max. 1
	Short circuit protection analogue output		Yes	–
	Short circuit current analogue output	[mA]	Approx. 20	–
	Open circuit voltage	[V DC]	–	18
	Destruction limit against externally applied voltage	[V DC]	15	
	Actuator connection		2 wires	
Cycle time (module)	[ms]	≤ 4		

Terminal CPX

Technical data – Analogue module for outputs

General technical data				
Type		CPX-2AA-U-I		
		Voltage output	Current output	
Response time	For ohmic load	[ms]	0.1	0.1
	For capacitive load	[ms]	0.7	–
	For inductive load	[ms]	–	0.5
Data format	15 bit + prefix, linear scaling 12 bit right-justified 12 bit left-justified, S7 compatible 12 bit left-justified, S5 compatible			
Cable length	[m]	Max. 30 (screened)		
LED displays	Group diagnostics	1		
	Channel diagnostics	Yes, by means of flashing frequency of group diagnostics		
Diagnostics	<ul style="list-style-type: none"> • Short circuit/overload, actuator supply • Parameterisation error • Value falling below nominal range/full-scale value • Value exceeding nominal range/full-scale value • Wire break 			
Parameterisation	<ul style="list-style-type: none"> • Short circuit monitoring, actuator supply • Short circuit monitoring, analogue output • Behaviour after short circuit, actuator supply • Data format • Lower limit value/full-scale value • Upper limit value/full-scale value • Monitoring of value falling below nominal range/full-scale value • Monitoring of value exceeding nominal range/full-scale value • Wire break monitoring • Signal range 			
Protection class to EN 60529	Depending on connection block			
Temperature range	Operation	[°C]	–5 ... +50	
	Storage/transport	[°C]	–20 ... +70	
Materials	Polymer			
Grid dimension	[mm]	50		
Dimensions (incl. interlinking block and connection block) W x L x H	[mm]	50 x 107 x 50		
Weight	[g]	38		

Connection and display components

CPX-2AA-U-I

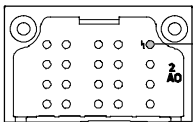

1 Error LED (red, module error)

Connection block/analogue module combinations			
Connection blocks	Part No.	Analogue module	
		CPX-2AA-U-I	
CPX-AB-4-M12X2-5POL	195704		■
CPX-AB-4-M12X2-5POL-R	541254		■
CPX-AB-8-KL-4POL	195708		■
CPX-AB-1-SUB-BU-25POL	525676		■
CPX-M-AB-4-M12X2-5POL	549367		■

Terminal CPX

Technical data – Analogue module for outputs

Pin allocation		
Connection block outputs	CPX-2AA-U-I	
CPX-AB-4-M12X2-5POL, CPX-AB-4-M12X2-5POL-R ¹⁾ and CPX-M-AB-4-M12X2-5POL		
	<p>X1.1: 24 V_{OUT} X1.2: Output U0+ X1.3: 0 V_{OUT} X1.4: Output GND X1.5: FE²⁾</p> <p>X2.1: 24 V_{OUT} X2.2: Output I0+ X2.3: 0 V_{OUT} X2.4: Output GND X2.5: FE²⁾</p>	<p>X3.1: 24 V_{OUT} X3.2: Output U1+ X3.3: 0 V_{OUT} X3.4: Output GND X3.5: FE²⁾</p> <p>X4.1: 24 V_{OUT} X4.2: Output I1+ X4.3: 0 V_{OUT} X4.4: Output GND X4.5: FE²⁾</p>
CPX-AB-8-KL-4POL		
	<p>X1.0: 24 V_{OUT} X1.1: 0 V_{OUT} X1.2: Output GND X1.3: FE</p> <p>X2.0: n.c. X2.1: n.c. X2.2: Output U0+ X2.3: FE</p> <p>X3.0: 24 V_{OUT} X3.1: 0 V_{OUT} X3.2: Output GND X3.3: FE</p> <p>X4.0: n.c. X4.1: n.c. X4.2: Output I0+ X4.3: FE</p>	<p>X5.0: 24 V_{OUT} X5.1: 0 V_{OUT} X5.2: Output GND X5.3: FE</p> <p>X6.0: n.c. X6.1: n.c. X6.2: Output U1+ X6.3: FE</p> <p>X7.0: 24 V_{OUT} X7.1: 0 V_{OUT} X7.2: Output GND X7.3: FE</p> <p>X8.0: n.c. X8.1: n.c. X8.2: Output I1+ X8.3: FE</p>
CPX-AB-1-SUB-BU-25POL		
	<p>1: Output GND 2: Output U0+ 3: Output GND 4: Output I0+ 5: n.c. 6: n.c. 7: n.c. 8: n.c. 9: 24 V_{OUT} 10: 24 V_{OUT} 11: 0 V_{OUT} 12: 0 V_{OUT} 13: Screening³⁾</p>	<p>14: Output GND 15: Output U1+ 16: Output GND 17: Output I1+ 18: 24 V_{OUT} 19: n.c. 20: 24 V_{OUT} 21: n.c. 22: 0 V_{OUT} 23: 0 V_{OUT} 24: 0 V_{OUT} 25: FE Socket: FE</p>

1) Speedcon quick lock, screening additionally on metal thread
 2) FE/screening additionally on metal thread
 3) Connect screening to functional earth FE

Terminal CPX

Accessories – Analogue module for outputs

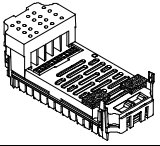
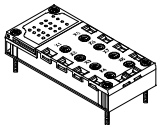
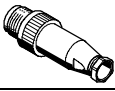
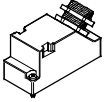
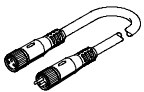
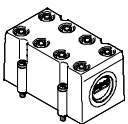
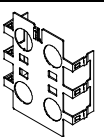
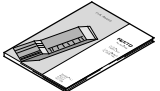
Ordering data			
Designation		Part No.	Type
Output module, analogue			
	2 analogue current or voltage outputs	526170	CPX-2AA-U-I
Connection block			
	Plastic	4x socket, M12, 5-pin	195704 CPX-AB-4-M12X2-5POL
		4x socket, M12 with quick-lock technology, 5-pin	541254 CPX-AB-4-M12X2-5POL-R
		Spring clip terminal, 32-pin	195708 CPX-AB-8-KL-4POL
		1x Sub-D socket, 25-pin	525676 CPX-AB-1-SUB-BU-25POL
	Metal	4x socket, M12, 5-pin	549367 CPX-M-AB-4-M12X2-5POL
Plug			
	M12 plug, 5-pin	175487	SEA-M12-5GS-PG7
	Sub-D plug, 25-pin	527522	SD-SUB-D-ST25
Connecting cable			
	Modular system for connecting cables	–	NEBU-... → Internet: nebu
Cover			
	Cover for CPX-AB-8-KL-4POL (IP65/67) – 8 cable through-feeds M9 – 1 cable through-feed for multi-pin plug	538219	AK-8KL
	Fittings kit	538220	VG-K-M9
Screening plate			
	Screening plate for M12 connections	526184	CPX-AB-S-4-M12
User manual			
	User manual	German	526415 P.BE-CPX-AX-DE
		English	526416 P.BE-CPX-AX-EN
		Spanish	526417 P.BE-CPX-AX-ES
		French	526418 P.BE-CPX-AX-FR
		Italian	526419 P.BE-CPX-AX-IT
		Swedish	526420 P.BE-CPX-AX-SV

Terminal CPX

Technical data – PROFIsafe shut-off module

Function

The PROFIsafe shut-off module interrupts the contact rails of the interlinking block for valves and outputs. The supply voltage for valves can be switched by the module within the CPX terminal and via a connection block to two consuming devices. Actuation takes place via the fieldbus node (PROFINET) of the CPX terminal.

Scope of application

- Output module for 24 V DC supply voltage
- Shut-off module for supply voltage for valves
- Can only be used with PROFINET or PROFIBUS bus node
- The shut-off module is supplied with voltage for the electronics and the outputs by the interlinking block
- The outputs are supplied from the power supply for valves (V_{Valves})

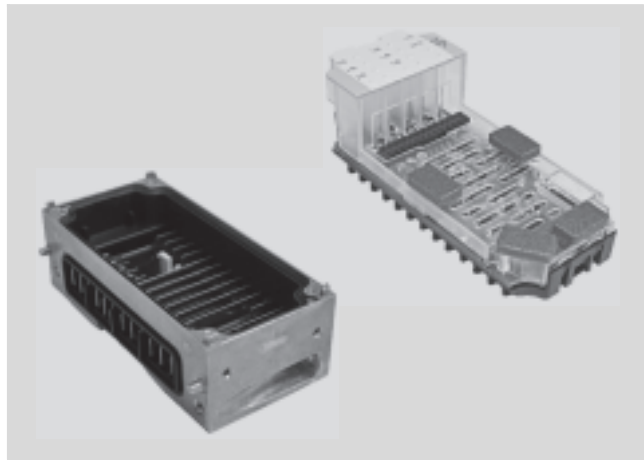

General technical data			
Type		CPX-FVDA-P	CPX-FVDA-P2
Number of outputs		2	
Note on outputs		1 internal channel for shutting off the supply voltage for valves 2 external outputs	
Max. power supply	Per module	[A]	5
	Per channel	[A]	0.5 (12 W lamp load) 1.5
Fuse protection (short circuit)		Internal electronic fuse for each channel	
Current consumption of module		[mA]	Typ. 65 (power supply for valves)
		[mA]	Typ. 25 (power supply for electronics)
Operating voltage	Nominal value	[V DC]	24
	Permissible range	[V DC]	20.4 ... 28.8
Voltage drop per channel		[V]	0.6
Residual ripple		[Vss]	2 within voltage range
Load capacity to FE		[nF]	100 400
Max. response time to shut-off command		[ms]	16 23
Electrical isolation	Channel – channel		No
	Channel – internal bus		Yes, using an intermediate supply
Switching logic	Outputs		P-M switching
Safety integrity level			Safe shut off, SIL 3
Performance level			Safe shut off/category 3, performance level e
Failure rate per hour (PFH)			1.3×10^{-10} 1.0×10^{-9}
Certificate issuing authority			01/205/5074/10 01/205/50294/13
LED displays	Group diagnostics		1
	Channel diagnostics		3
	Channel status		3
	Failsafe protocol active		1
Diagnostics			<ul style="list-style-type: none"> • Short circuit/overload per channel • Undervoltage of valves • Cross circuit • Wire break per channel
Parameterisation			<ul style="list-style-type: none"> • Wire break monitoring per channel • Diagnostic behaviour
Protection class to EN 60529			Depending on connection block
Materials			PA reinforced, PC
Note on materials			RoHS-compliant
Grid dimension		[mm]	50
Dimensions (incl. interlinking block and connection block) W x L x H		[mm]	50 x 107 x 50 50 x 107 x 55

Terminal CPX

Technical data – PROFIsafe shut-off module

Operating and environmental conditions		
Ambient temperature	[°C]	-5 ... +50
Storage temperature	[°C]	-20 ... +70
CE mark (see declaration of conformity)		To EU Machinery Directive
Certification		c UL us - Recognized (OL)

Connection and display components

CPX-FVDA-P

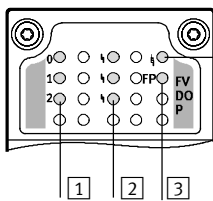

- | | |
|--|---|
| 1 Status LEDs (yellow):
0: Supply voltage for valves
1: X1
2: X2 | 2 Channel-specific error LEDs (red)
3 Failsafe protocol active (green)
4 Error LED (red, module error) |
|--|---|

Bus node/control block	Part No.	PROFIsafe shut-off module	
		CPX-FVDA-P	CPX-FVDA-P2
CPX-FEC-1-IE	529041	-	-
CPX-CEC-C1	567347	-	-
CPX-CEC-M1	567348	-	-
CPX-CEC	567346	-	-
CPX-FB6	195748	-	-
CPX-FB11	526172	-	-
CPX-FB13	195740	-	■
CPX-FB14	526174	-	-
CPX-FB23	526176	-	-
CPX-FB32	541302	-	-
CPX-FB33	548755	■	■
CPX-M-FB34	548751	■	■
CPX-M-FB35	548749	■	■
CPX-FB36	1912451	-	-
CPX-FB38	552046	-	-



Note

The PROFIsafe shut-off module CPX-FVDA-P can only be interfaced as of software release 18.



Note

The PROFIsafe shut-off module CPX-FVDA-P2 can only be interfaced as of software release 21 or release 30 (CPX-FB13).

Terminal CPX

Technical data – PROFI-safe shut-off module

Combinations of connection blocks and PROFI-safe shut-off module			
Connection blocks	Part No.	PROFI-safe shut-off module	
		CPX-FVDA-P	CPX-FVDA-P2
CPX-M-AB-4-M12X2-5POL	549367	■	■
CPX-AB-8-KL-4POL	195708	-	■

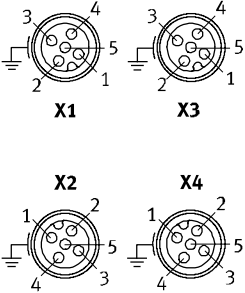
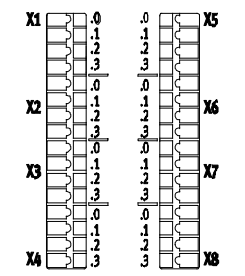
Pin allocation				
Connection block outputs	CPX-FVDA-P		CPX-FVDA-P2	
CPX-M-AB-4-M12X2-5POL				
	<p>X1.1: 0 V_{OUT} 1 (cannot be shut off)</p> <p>X1.2: 24 V_{OUT} 1 (cannot be shut off)</p> <p>X1.3: 0 V_{OUT} 1 (can be shut off via fieldbus)</p> <p>X1.4: 24 V_{OUT} 1 (can be shut off via fieldbus)</p> <p>X1.5: FE (earth)</p> <p>X2.1: 0 V_{OUT} 2 (cannot be shut off)</p> <p>X2.2: 24 V_{OUT} 2 (cannot be shut off)</p> <p>X2.3: 0 V_{OUT} 2 (can be shut off via fieldbus)</p> <p>X2.4: 24 V_{OUT} 2 (can be shut off via fieldbus)</p> <p>X2.5: FE (earth)</p>	<p>X3.1: n.c.</p> <p>X3.2: n.c.</p> <p>X3.3: n.c.</p> <p>X3.4: n.c.</p> <p>X3.5: FE (earth)</p> <p>X4.1: n.c.</p> <p>X4.2: n.c.</p> <p>X4.3: n.c.</p> <p>X4.4: n.c.</p> <p>X4.5: FE (earth)</p>	<p>X1.1: 0 V_{OUT} 1 (cannot be shut off)</p> <p>X1.2: 24 V_{OUT} 1 (cannot be shut off)</p> <p>X1.3: 0 V_{OUT} 1 (can be shut off via fieldbus)</p> <p>X1.4: 24 V_{OUT} 1 (can be shut off via fieldbus)</p> <p>X1.5: FE (earth)</p> <p>X2.1: 0 V_{OUT} 2 (cannot be shut off)</p> <p>X2.2: 24 V_{OUT} 2 (cannot be shut off)</p> <p>X2.3: 0 V_{OUT} 2 (can be shut off via fieldbus)</p> <p>X2.4: 24 V_{OUT} 2 (can be shut off via fieldbus)</p> <p>X2.5: FE (earth)</p>	<p>X3.1: n.c.</p> <p>X3.2: n.c.</p> <p>X3.3: n.c.</p> <p>X3.4: n.c.</p> <p>X3.5: FE (earth)</p> <p>X4.1: n.c.</p> <p>X4.2: n.c.</p> <p>X4.3: n.c.</p> <p>X4.4: n.c.</p> <p>X4.5: FE (earth)</p>
CPX-AB-8-KL-4POL				
	-	-	<p>X1.0: 0 V_{OUT} 1 (cannot be shut off)</p> <p>X1.1: 0 V_{OUT} 1 (can be shut off via fieldbus)</p> <p>X1.2: 24 V_{OUT} 1 (can be shut off via fieldbus)</p> <p>X1.3: FE (earth)</p> <p>X2.0: n.c.</p> <p>X2.1: n.c.</p> <p>X2.2: 24 V_{OUT} 1 (cannot be shut off)</p> <p>X2.3: FE (earth)</p> <p>X3.0: 0 V_{OUT} 2 (cannot be shut off)</p> <p>X3.1: 0 V_{OUT} 2 (can be shut off via fieldbus)</p> <p>X3.2: 24 V_{OUT} 2 (can be shut off via fieldbus)</p> <p>X3.3: FE (earth)</p> <p>X4.0: n.c.</p> <p>X4.1: n.c.</p> <p>X4.2: 24 V_{OUT} 2 (cannot be shut off)</p> <p>X4.3: FE (earth)</p>	<p>X5.0: n.c.</p> <p>X5.1: n.c.</p> <p>X5.2: n.c.</p> <p>X5.3: n.c.</p> <p>X6.0: n.c.</p> <p>X6.1: n.c.</p> <p>X6.2: n.c.</p> <p>X6.3: n.c.</p> <p>X7.0: n.c.</p> <p>X7.1: n.c.</p> <p>X7.2: n.c.</p> <p>X7.3: n.c.</p> <p>X8.0: n.c.</p> <p>X8.1: n.c.</p> <p>X8.2: n.c.</p> <p>X8.3: n.c.</p>

Terminal CPX

Technical data – PROFIsafe shut-off module

FESTO

Combinations of interlinking blocks and PROFIsafe shut-off module			
Interlinking blocks	Part No.	PROFIsafe shut-off module	
		CPX-FVDA-P	CPX-FVDA-P2
CPX-GE-EV-S	195746	–	–
CPX-GE-EV-S-7/8-4POL	541248	–	–
CPX-GE-EV-S-7/8-5POL	541244	–	–
CPX-M-GE-EV-S-7/8-CIP-4P	568956	–	–
CPX-M-GE-EV-S-7/8-5POL	550208	–	–
CPX-M-GE-EV-S-PP-5POL	563057	–	–
CPX-GE-EV	195742	–	–
CPX-M-GE-EV	550206	–	–
CPX-M-GE-EV-FVO	567806	■	■
CPX-GE-EV-Z	195744	–	–
CPX-GE-EV-Z-7/8-4POL	541250	–	–
CPX-GE-EV-Z-7/8-5POL	541246	–	–
CPX-M-GE-EV-Z-7/8-5POL	550210	–	–
CPX-M-GE-EV-Z-PP-5POL	563058	–	–
CPX-GE-EV-V	533577	–	–
CPX-GE-EV-V-7/8-4POL	541252	–	–

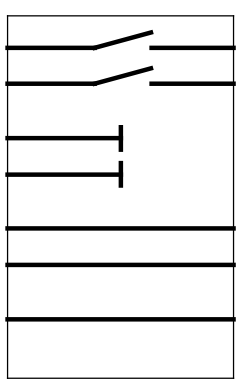

General technical data		
Type		CPX-M-GE-EV-FVO
Nominal operating voltage	[V DC]	24
Acceptable current load (per contact/contact rail)	[A]	16
Protection class to EN 60529		Depending on connection block
Ambient temperature	[°C]	–5 ... +50
Material declaration		RoHS-compliant
Note on materials		Die-cast aluminium
Type of mounting		Angled fitting
Grid dimension	[mm]	50
Dimensions W x L x H	[mm]	50 x 107 x 35
Product weight	[g]	170

Pin allocation			
Circuitry		Pin	Allocation
 <p>0V Valves 24V Valves 0V Output 24V Output 0V El./Sen. 24V El./Sen. FE</p>		–	–
		–	–
		–	–
		–	–
		–	–
		–	–
		–	–
		–	–
		–	–
		–	–

Terminal CPX

Accessories – PROFIsafe shut-off module

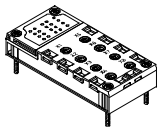
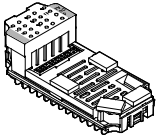
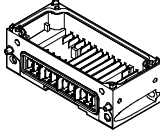
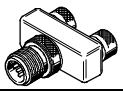
FESTO

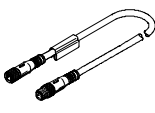
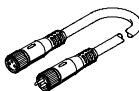
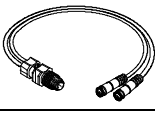
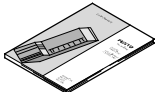
Ordering data					
	Description		Part No.	Type	
PROFIsafe shut-off module					
	Metal connection block	4x socket, M12, 5-pin	549367	CPX-M-AB-4-M12X2-5POL	
	Plastic connection block	Spring-loaded terminal, 32-pin	195708	CPX-AB-8-KL-4POL	
	Electronics module (can only be used with CPX-M-GE-EV-FVO)	PROFINET	567039	CPX-FVDA-P	
		PROFINET, PROFIBUS	1971599	CPX-FVDA-P2	
	Metal interlinking block (only for CPX-FVDA-P and CPX-FVDA-P2)		567806	CPX-M-GE-EV-FVO	
Plug					
	Push-in T-connector	2x socket M12, 5-pin 1x plug M12, 4-pin	541596	NEDU-M12D5-M12T4	
	Plug	M12, PG7	18666	SEA-GS-7	
		M12, PG7, 4-pin for cable Ø 2.5 mm	192008	SEA-4GS-7-2,5	
		M12, PG9	18778	SEA-GS-9	
		M12 for 2 cables	18779	SEA-GS-11-DUO	
		M12 for 2 cables, 5-pin	192010	SEA-5GS-11-DUO	
		M12, 5-pin	175487	SEA-M12-5GS-PG7	
Connecting cable					
	Connecting cable M12-M12	Straight plug – straight socket	2.5 m	18684	KM12-M12-GSGD-2,5
			5.0 m	18686	KM12-M12-GSGD-5
		Straight plug – angled socket	1.0 m	185499	KM12-M12-GSWD-1-4
	Modular system for connecting cables		–	NEBU-... → Internet: nebu	
	DUO cable M12	2x straight socket	18685	KM12-DUO-M8-GDGD	
		2x straight/angled socket	18688	KM12-DUO-M8-GDWD	
		2x angled socket	18687	KM12-DUO-M8-WDWD	
Manual					
	Manual for PROFIsafe shut-off module	CPX-FVDA-P	German	570843	P.BE-CPX-SYS-F-DE
			English	570844	P.BE-CPX-SYS-F-EN
			Spanish	570845	P.BE-CPX-SYS-F-ES
			French	570846	P.BE-CPX-SYS-F-FR
			Italian	570847	P.BE-CPX-SYS-F-IT
			Swedish	570848	P.BE-CPX-SYS-F-SV
		Chinese	8025339	P.BE-CPX-FVDA-P-ZH	
		CPX-FVDA-P2	German	8022606	P.BE-CPX-FVDA-P2-DE
			English	8022607	P.BE-CPX-FVDA-P2-EN
			Spanish	8022608	P.BE-CPX-FVDA-P2-ES
			French	8022609	P.BE-CPX-FVDA-P2-FR
			Italian	8022610	P.BE-CPX-FVDA-P2-IT
			Chinese	8022611	P.BE-CPX-FVDA-P2-ZH

Terminal CPX

Technical data – End plate with system power supply

Function

End plates form the outer edge of the CPX terminal.

The earth connection and mounting holes for wall or H-rail mounting are located on the left end plate.

The end plate with system power supply has contact rails from which the other CPX components on the interlinking modules are supplied with power.

Application

- 24 V DC supply voltage for the electronics of the CPX terminal
- 24 V DC supply voltage for inputs
- 24 V DC supply voltage for valves
- 24 V DC supply voltage for outputs

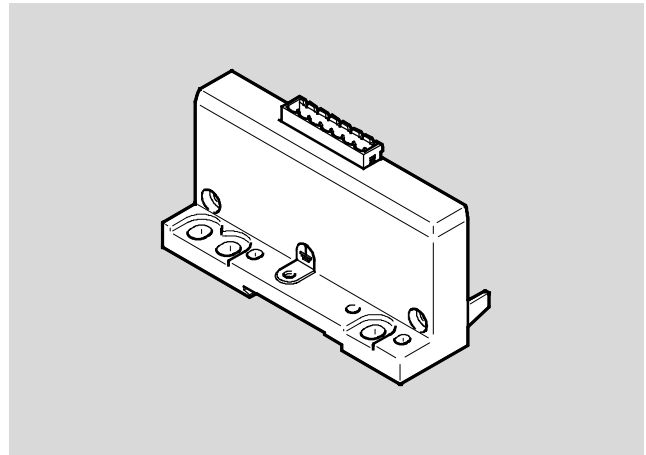

General technical data		
Electrical connection	Plug, 7-pin	
Type of mounting	Tie rod	
Power supply	System power supply	
Maximum power supply	[A]	12
Product weight	[g]	145

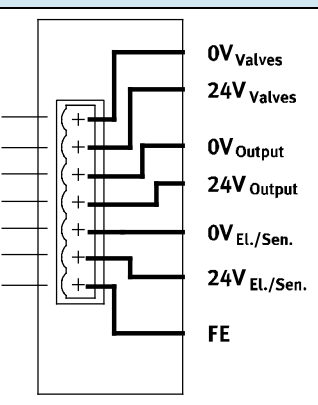
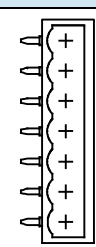

Materials	
Housing	Die-cast aluminium, painted
Note on materials	RoHS-compliant

Operating and environmental conditions	
Approval certificate	cULus Recognized (OL)

Pin allocation																	
Circuitry		Pin	Allocation														
Plug, 7-pin																	
<table border="1"> <tr><td>0V</td><td>1</td></tr> <tr><td>24V</td><td>2</td></tr> <tr><td>0V</td><td>3</td></tr> <tr><td>24V</td><td>4</td></tr> <tr><td>0V</td><td>5</td></tr> <tr><td>24V</td><td>6</td></tr> <tr><td>FE</td><td>7</td></tr> </table> 	0V	1	24V	2	0V	3	24V	4	0V	5	24V	6	FE	7		1	0 V power supply for valves
0V	1																
24V	2																
0V	3																
24V	4																
0V	5																
24V	6																
FE	7																
		2	24 V DC load voltage supply for valves														
		3	0 V power supply for outputs														
		4	24 V DC load voltage supply for outputs														
		5	0 V power supply for electronics and sensors														
		6	24 V DC power supply for electronics and sensors														
		7	FE														

Terminal CPX

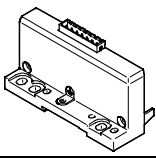
Accessories – End plate with system power supply

Ordering data		Part No.	Type
End plate with system power supply			
	End plate for CPX terminal in plastic design	576315	CPX-EPL-EV-S
Terminal strip			
	Plug, 7-pin, straight	Spring-loaded terminal 576319	NECU-L3G7-C1

Terminal CPX

Technical data – End plate with extension

Function

End plates form the outer edge of the CPX terminal.

The earth connection and mounting holes for wall or H-rail mounting are located on the left end plates.

The end plates with extension enable the CPX terminal to be separated into two interconnected terminals. Control is provided via a common bus node or control block.

Application

- Separation of long CPX terminals into two shorter units
- Adaptation for installation in a control cabinet

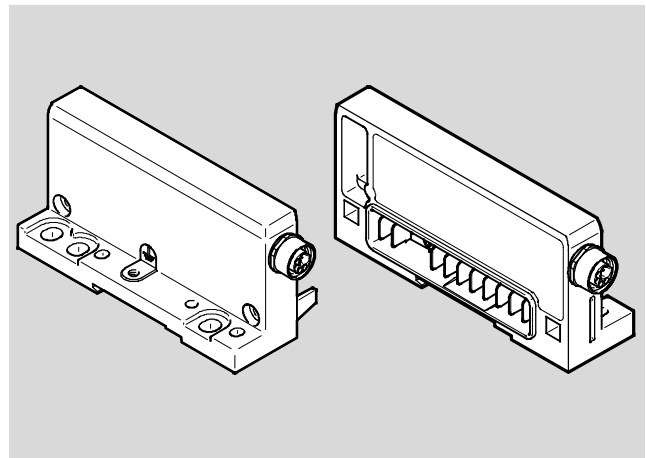

General technical data		
Type	CPX-EP...	CPX-M-EP...
Type of mounting	Tie rod	Angled fitting
Maximum power supply [A]	6	6

Materials		
Type	CPX-EP...	CPX-M-EP...
Housing	Die-cast aluminium, painted	Die-cast aluminium
Note on materials	RoHS-compliant	RoHS-compliant

Operating and environmental conditions	
Approval certificate	cULus Recognized (OL)

Terminal CPX

Technical data – End plate with extension

Pin allocation – End plate with extension					
Circuitry	Pin	Allocation	Pin	Circuitry	
Right-hand end plate	Round plug, 8-pin			Left-hand end plate	
M12					
0V Valves	1	0 V DC supply voltage for electronics and sensors	1	0V Valves	
24V Valves	2	0 V DC load voltage supply for valves	2	24V Valves	
0V Output	3	24 V DC load voltage supply for valves	3	0V Output	
24V Output	4	24 V DC supply voltage for electronics and sensors	4	24V Output	
0V El./Sen.	5	Bus signal	5	0V El./Sen.	
24V El./Sen.	6	Bus signal	6	24V El./Sen.	
FE	7	Bus signal	7	FE	
	8	Bus signal	8		
	Housing	FE	Housing		

Ordering data						
				Weight [g]	Part No.	Type
End plate with extension						
	For CPX terminal in plastic design	Left-hand	190	576313	CPX-EPR-EV-X	
		Right-hand	175	576314	CPX-EPL-EV-X	
	For CPX terminal in metal design	Left-hand	190	576316	CPX-M-EPR-EV-X	
		Right-hand	175	576317	CPX-M-EPL-EV-X	
Connecting cable						
	8-pin	2 m	–	576015	NEBC-F12G8-KH-2-N-S-F12G8	
		3 m	–	576636	NEBC-F12G8-KH-3-N-S-F12G8	

Terminal CPX

Technical data – Interlinking block with system supply

Function

Interlinking blocks ensure the electrical supply of all other CPX modules. They have contact rails, from which the other CPX components on the interlinking modules are supplied with current.

Internal division of the power supply makes it possible to switch off specific areas of the sensors and actuators individually.

Applications

- 24 V DC supply voltage for electronics of the CPX terminal
- 24 V DC supply voltage for inputs
- 24 V DC supply voltage for valves
- 24 V DC supply voltage for outputs



General technical data		
Nominal operating voltage	[V DC]	24
Protection class to EN 60529		Depending on connection block
Ambient temperature	[°C]	-5 ... +50
Note on materials		RoHS-compliant
Grid dimension	[mm]	50
Dimensions W x L x H	[mm]	50 x 107 x 35

Technical data – Plastic interlinking blocks							
Type		CPX-GE-EV-S					
			-VL	-7/8-4POL	-7/8-5POL	-7/8-5POL-VL	
Electrical connection		M18	M18	7/8", 4-pin	7/8", 5-pin	7/8", 5-pin	
Current supply	Sensors and electronics	[A]	Max. 16	Max. 8	Max. 10	Max. 8	Max. 8
	Valves and outputs	[A]	Max. 16	Max. 8	Max. 10	Max. 8	Max. 8
Materials			PA, reinforced				
Product weight		[g]	125				

Technical data – Metal interlinking blocks							
Type		CPX-M-GE-EV-S					
		-7/8-CIP-4P	-7/8-5POL	-7/8-5POL-VL	-PP-5POL		
Electrical connection		7/8", 4-pin	7/8", 5-pin	7/8", 5-pin	AIDA push-pull, 5-pin		
Current supply	Sensors and electronics	[A]	Max. 10	Max. 8	Max. 8	Max. 16	
	Valves and outputs	[A]	Max. 10	Max. 8	Max. 8	Max. 16	
Materials			Die-cast aluminium				
Product weight		[g]	187	187	187	245	

-  - Note

Note the following points about the interlinking block

CPX-M-GE-EV-S-7/8-CIP-4P:

- Must be mounted as the first module to the right of the left-hand end plate

- Only permitted as an interlinking block to a bus node
- The functional earth (FE) must be connected via the left-hand end plate

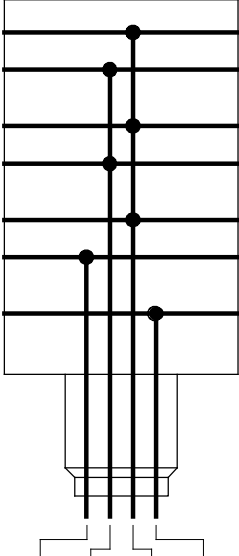
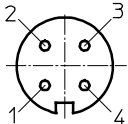
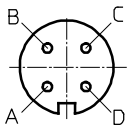
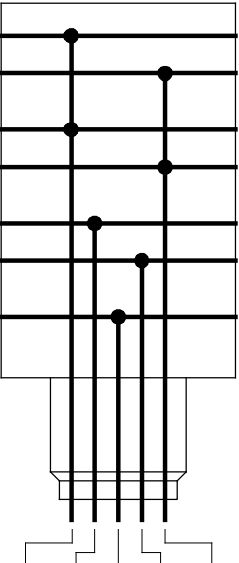
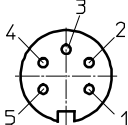

Terminal CPX

Technical data – Interlinking block with system supply

Pin allocation – Plastic interlinking blocks		Pin	Allocation																																		
Circuitry																																					
Round connector, 4-pin																																					
	0V Valves 24V Valves 0V Output 24V Output 0V El./Sen. 24V El./Sen. FE	M18		<table border="1"> <tr><td>1</td><td>24 V DC supply voltage for electronics and sensors</td></tr> <tr><td>2</td><td>24 V DC load voltage supply for valves and outputs</td></tr> <tr><td>3</td><td>0 V</td></tr> <tr><td>4</td><td>FE</td></tr> </table>	1	24 V DC supply voltage for electronics and sensors	2	24 V DC load voltage supply for valves and outputs	3	0 V	4	FE																									
		1	24 V DC supply voltage for electronics and sensors																																		
2	24 V DC load voltage supply for valves and outputs																																				
3	0 V																																				
4	FE																																				
<table border="1"> <tr><td>M18</td><td>1</td><td>2</td><td>3</td><td>4</td></tr> <tr><td>7/8"</td><td>A</td><td>B</td><td>D</td><td>C</td></tr> <tr><td></td><td>24V</td><td>24V</td><td>0V</td><td>FE</td></tr> </table>	M18	1	2	3	4	7/8"	A	B	D	C		24V	24V	0V	FE	<table border="1"> <tr><td>7/8"</td><td>A</td><td>B</td><td>D</td><td>C</td></tr> <tr><td></td><td>24V</td><td>24V</td><td>0V</td><td>FE</td></tr> </table>	7/8"	A	B	D	C		24V	24V	0V	FE	7/8"		<table border="1"> <tr><td>A</td><td>24 V DC supply voltage for electronics and sensors</td></tr> <tr><td>B</td><td>24 V DC load voltage supply for valves and outputs</td></tr> <tr><td>C</td><td>FE</td></tr> <tr><td>D</td><td>0V</td></tr> </table>	A	24 V DC supply voltage for electronics and sensors	B	24 V DC load voltage supply for valves and outputs	C	FE	D	0V
M18	1	2	3	4																																	
7/8"	A	B	D	C																																	
	24V	24V	0V	FE																																	
7/8"	A	B	D	C																																	
	24V	24V	0V	FE																																	
A	24 V DC supply voltage for electronics and sensors																																				
B	24 V DC load voltage supply for valves and outputs																																				
C	FE																																				
D	0V																																				
Round connector, 5-pin																																					
	0V Valves 24V Valves 0V Output 24V Output 0V El./Sen. 24V El./Sen. FE	7/8"		<table border="1"> <tr><td>1</td><td>0 V valves and outputs</td></tr> <tr><td>2</td><td>0 V electronics and sensors</td></tr> <tr><td>3</td><td>FE</td></tr> <tr><td>4</td><td>24 V DC supply voltage for electronics and sensors</td></tr> <tr><td>5</td><td>24 V DC load voltage supply for valves and outputs</td></tr> </table>	1	0 V valves and outputs	2	0 V electronics and sensors	3	FE	4	24 V DC supply voltage for electronics and sensors	5	24 V DC load voltage supply for valves and outputs																							
		1	0 V valves and outputs																																		
2	0 V electronics and sensors																																				
3	FE																																				
4	24 V DC supply voltage for electronics and sensors																																				
5	24 V DC load voltage supply for valves and outputs																																				
<table border="1"> <tr><td>7/8"</td><td>1</td><td>2</td><td>3</td><td>4</td><td>5</td></tr> <tr><td></td><td>0V</td><td>0V</td><td>FE</td><td>24V</td><td>24V</td></tr> </table>	7/8"	1	2	3	4	5		0V	0V	FE	24V	24V	<table border="1"> <tr><td>7/8"</td><td>1</td><td>2</td><td>3</td><td>4</td><td>5</td></tr> <tr><td></td><td>0V</td><td>0V</td><td>FE</td><td>24V</td><td>24V</td></tr> </table>	7/8"	1	2	3	4	5		0V	0V	FE	24V	24V	<table border="1"> <tr><td>1</td><td>0 V valves and outputs</td></tr> <tr><td>2</td><td>0 V electronics and sensors</td></tr> <tr><td>3</td><td>FE</td></tr> <tr><td>4</td><td>24 V DC supply voltage for electronics and sensors</td></tr> <tr><td>5</td><td>24 V DC load voltage supply for valves and outputs</td></tr> </table>	1	0 V valves and outputs	2	0 V electronics and sensors	3	FE	4	24 V DC supply voltage for electronics and sensors	5	24 V DC load voltage supply for valves and outputs	
7/8"	1	2	3	4	5																																
	0V	0V	FE	24V	24V																																
7/8"	1	2	3	4	5																																
	0V	0V	FE	24V	24V																																
1	0 V valves and outputs																																				
2	0 V electronics and sensors																																				
3	FE																																				
4	24 V DC supply voltage for electronics and sensors																																				
5	24 V DC load voltage supply for valves and outputs																																				

Terminal CPX

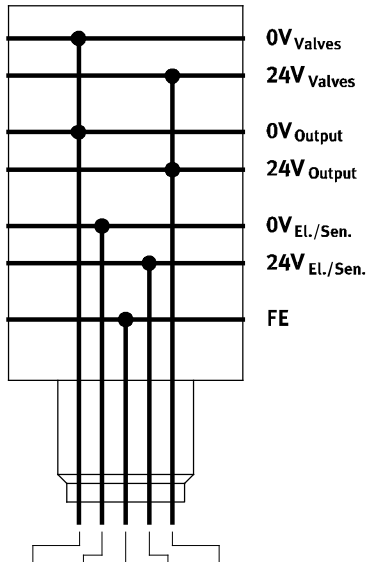
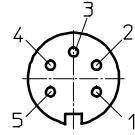
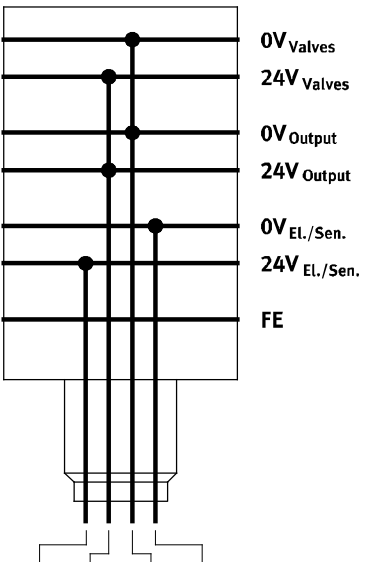
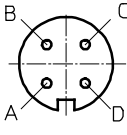
Technical data – Interlinking block with system supply

Pin allocation – Metal interlinking blocks		Pin	Allocation												
Round connector, 5-pin															
	7/8"														
		1	0 V Valves and outputs												
	2	0 V electronics and sensors													
	3	FE													
	4	24 V DC supply voltage for electronics and sensors													
	5	24 V DC load voltage supply for valves and outputs													
<table border="1" data-bbox="159 1008 478 1086"> <tr> <td>7/8"</td> <td>1</td> <td>2</td> <td>3</td> <td>4</td> <td>5</td> </tr> <tr> <td></td> <td>0V</td> <td>0V</td> <td>FE</td> <td>24V</td> <td>24V</td> </tr> </table>	7/8"	1	2	3	4	5		0V	0V	FE	24V	24V			
7/8"	1	2	3	4	5										
	0V	0V	FE	24V	24V										
Round connector, 4-pin															
	7/8"														
		A	24 V DC supply voltage for electronics and sensors												
	B	24 V DC load voltage supply for valves and outputs													
	C	0 V DC supply voltage for electronics and sensors													
	D	0 V DC load voltage supply for valves and outputs													
	<p>-  - Note</p> <p>The functional earth (FE) must be connected via the left-hand end plate</p>														
<table border="1" data-bbox="167 1736 438 1803"> <tr> <td>7/8"</td> <td>A</td> <td>B</td> <td>D</td> <td>C</td> </tr> <tr> <td></td> <td>24V</td> <td>24V</td> <td>0V</td> <td>0V</td> </tr> </table>	7/8"	A	B	D	C		24V	24V	0V	0V					
7/8"	A	B	D	C											
	24V	24V	0V	0V											

Terminal CPX

Technical data – Interlinking block with system supply

Pin allocation – Metal interlinking blocks														
Circuitry	Pin	Allocation												
Push-pull plug, 5-pin														
<table border="1" style="margin-top: 10px;"> <tr> <td>PP</td> <td>1</td> <td>2</td> <td>3</td> <td>4</td> <td>5</td> </tr> <tr> <td></td> <td>24V</td> <td>0V</td> <td>24V</td> <td>0V</td> <td>FE</td> </tr> </table>	PP	1	2	3	4	5		24V	0V	24V	0V	FE	Plug pattern to PROFINET specification 	
	PP	1	2	3	4	5								
	24V	0V	24V	0V	FE									
	1	24 V DC supply voltage for electronics and sensors												
	2	0 V electronics and sensors												
	3	24 V DC load voltage supply for valves and outputs												
	4	0 V valves and outputs												
	5	FE												

Terminal CPX

Accessories – Interlinking block with system supply

FESTO

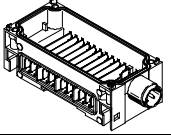
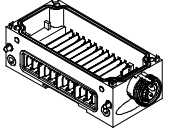
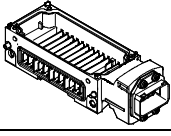
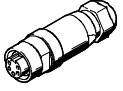
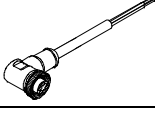
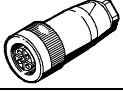
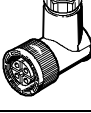
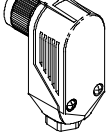
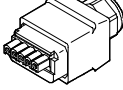
Ordering data						
Designation				Part No.	Type	
Interlinking block with system supply						
	Connection M18, plastic interlinking block	4-pin	–	195746	CPX-GE-EV-S	
			For ATEX environment	8022170	CPX-GE-EV-S-VL	
	Connection 7/8", plastic interlinking block	4-pin	–	541248	CPX-GE-EV-S-7/8-4POL	
			5-pin	–	541244	CPX-GE-EV-S-7/8-5POL
				For ATEX environment	8022172	CPX-GE-EV-S-7/8-5POL-VL
	Connection 7/8", metal interlinking block	4-pin	–	568956	CPX-M-GE-EV-S-7/8-CIP-4P	
			5-pin	–	550208	CPX-M-GE-EV-S-7/8-5POL
For ATEX environment				8022165	CPX-M-GE-EV-S-7/8-5POL-VL	
	Connection push-pull plug (AIDA), metal interlinking block	5-pin	–	563057	CPX-M-GE-EV-S-PP-5POL	
7/8" connection sockets						
	Power supply socket	5-pin		543107	NECU-G78G5-C2	
			4-pin		543108	NECU-G78G4-C2
	Angled socket, 5-pin – Open cable end, 5-pin	2 m		573855	NEBU-G78W5-K-2-N-LE5	
M18 connection sockets						
	Straight socket, screw terminal	4-pin	PG9	18493	NTSD-GD-9	
			PG13.5	18526	NTSD-GD-13,5	
	Angled socket, screw terminal	4-pin	PG9	18527	NTSD-WD-9	
	Angled socket, screw terminal	4-pin	PG11	533119	NTSD-WD-11	
Connection socket AIDA push-pull						
	Socket, spring-loaded terminal	5-pin		563059	NECU-M-PPG5-C1	

Terminal CPX

Accessories – Interlinking block with system supply

Ordering data				
Designation			Part No.	Type
Mounting accessories				
	Screws for mounting the bus node/connection block on a plastic interlinking block	Bus node/metal connection block	550218	CPX-DPT-30X32-S-4X
	Screws for mounting the bus node/connection block on a metal interlinking block	Bus node/plastic connection block	550219	CPX-M-M3x22-4x
		Bus node/metal connection block	550216	CPX-M-M3x22-S-4x

Terminal CPX

Technical data – Interlinking block

Function

Interlinking blocks ensure the electrical supply of all other CPX modules. They have contact rails, from which the other CPX components on the interlinking modules are supplied with current.

Internal division of the power supply makes it possible to switch off specific areas of the sensors and actuators individually.

Applications

- All voltages are fed through to the next module by means of an interlinking system.
- The connected electronics module for inputs/outputs or bus node taps off the required voltage.





General technical data		
Type	CPX-GE-EV	CPX-M-GE-EV
Electrical connection	–	–
Nominal operating voltage [V DC]	24	24
Acceptable current load (per contact/contact rail) [A]	16	8
Protection class to EN 60529	Depending on connection block	
Ambient temperature [°C]	–5 ... +50	
Note on materials	RoHS-compliant	
Materials	Polymer	Aluminium
Grid dimension [mm]	50	
Dimensions W x L x H [mm]	50 x 107 x 35	
Weight [g]	100	162

Pin allocation																	
Circuitry		Pin	Allocation														
<table border="1" style="border-collapse: collapse; width: 100%;"> <tr><td style="width: 20px; height: 15px;"></td><td style="padding-left: 5px;">0V Valves</td></tr> <tr><td style="width: 20px; height: 15px;"></td><td style="padding-left: 5px;">24V Valves</td></tr> <tr><td style="width: 20px; height: 15px;"></td><td style="padding-left: 5px;">0V Output</td></tr> <tr><td style="width: 20px; height: 15px;"></td><td style="padding-left: 5px;">24V Output</td></tr> <tr><td style="width: 20px; height: 15px;"></td><td style="padding-left: 5px;">0V El./Sen.</td></tr> <tr><td style="width: 20px; height: 15px;"></td><td style="padding-left: 5px;">24V El./Sen.</td></tr> <tr><td style="width: 20px; height: 15px;"></td><td style="padding-left: 5px;">FE</td></tr> </table>		0V Valves		24V Valves		0V Output		24V Output		0V El./Sen.		24V El./Sen.		FE		–	–
		0V Valves															
		24V Valves															
		0V Output															
		24V Output															
		0V El./Sen.															
		24V El./Sen.															
		FE															
		–	–														
		–	–														
		–	–														

Terminal CPX

Accessories – Interlinking block

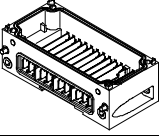
FESTO

Ordering data – Mounting accessories			
Designation		Part No.	Type
Interlinking block without supply			
	Plastic interlinking block	195742	CPX-GE-EV
	Metal interlinking block	550206	CPX-M-GE-EV
Mounting accessories			
	Screws for mounting the bus node/connection block on a plastic interlinking block	Bus node/metal connection block	550218 CPX-DPT-30X32-S-4X
	Screws for mounting the bus node/connection block on a metal interlinking block	Bus node/plastic connection block	550219 CPX-M-M3x22-4x
		Bus node/metal connection block	550216 CPX-M-M3x22-S-4x

Terminal CPX

Technical data – Interlinking block with additional power supply for outputs

Function

Interlinking blocks ensure the electrical supply of all other CPX modules. They have contact rails, from which the other CPX components on the interlinking modules are supplied with current.

Internal division of the power supply makes it possible to switch off specific areas of the sensors and actuators individually.

Applications

- 24 V DC supply voltage for outputs

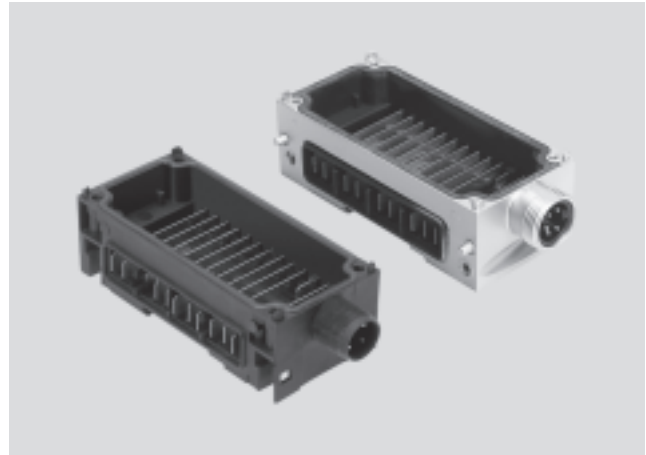

General technical data		
Nominal operating voltage	[V DC]	24
Protection class to EN 60529		Depending on connection block
Ambient temperature	[°C]	-5 ... +50
Note on materials		RoHS-compliant
Grid dimension	[mm]	50
Dimensions W x L x H	[mm]	50 x 107 x 35

Technical data – Plastic interlinking blocks							
Type	CPX-GE-EV-Z						
		-VL	-7/8-4POL	-7/8-5POL	-7/8-5POL-VL		
Electrical connection	M18	M18	7/8", 4-pin	7/8", 5-pin	7/8", 5-pin		
Current supply	Outputs	[A]	Max. 16	Max. 8	Max. 10	Max. 8	Max. 8
Materials	PA, reinforced						
Product weight	[g]	125					

Technical data – Metal interlinking blocks					
Type	CPX-M-GE-EV-Z				
	-7/8-5POL	-7/8-5POL-VL	-PP-5POL		
Electrical connection	7/8", 5-pin	7/8", 5-pin	AIDA push-pull, 5-pin		
Current supply	Outputs	[A]	Max. 8	Max. 8	Max. 16
Materials	Die-cast aluminium				
Product weight	[g]	187	187	245	

Terminal CPX

Technical data – Interlinking block with additional power supply for outputs

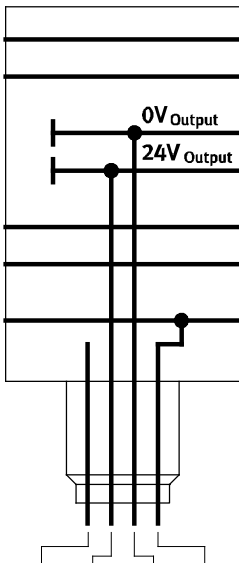
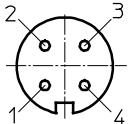
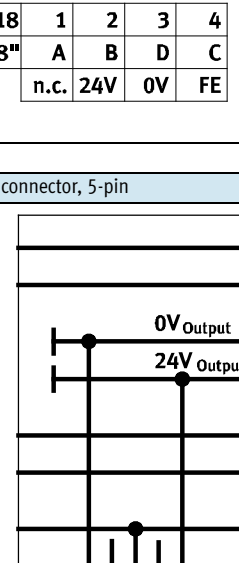
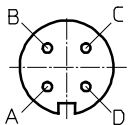
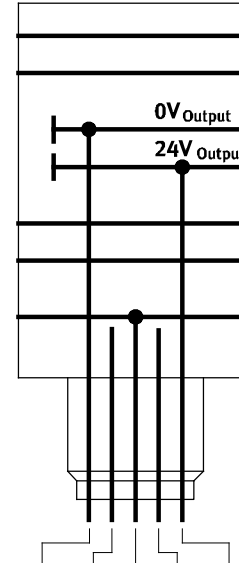
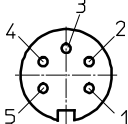
Pin allocation – Plastic interlinking blocks		Pin	Allocation															
Round connector, 4-pin																		
	<p>0V Valves 24V Valves 0V Output 24V Output 0V El./Sen. 24V El./Sen. FE</p>	M18																
			<table border="1"> <tr><td>1</td><td>n.c.</td></tr> <tr><td>2</td><td>24 V DC load voltage supply for outputs</td></tr> <tr><td>3</td><td>0 V</td></tr> <tr><td>4</td><td>FE</td></tr> </table>	1	n.c.	2	24 V DC load voltage supply for outputs	3	0 V	4	FE							
1	n.c.																	
2	24 V DC load voltage supply for outputs																	
3	0 V																	
4	FE																	
	<p>0V Valves 24V Valves 0V Output 24V Output 0V El./Sen. 24V El./Sen. FE</p>	7/8"																
			<table border="1"> <tr><td>A</td><td>n.c.</td></tr> <tr><td>B</td><td>24 V DC load voltage supply for outputs</td></tr> <tr><td>C</td><td>FE</td></tr> <tr><td>D</td><td>0V</td></tr> </table>	A	n.c.	B	24 V DC load voltage supply for outputs	C	FE	D	0V							
A	n.c.																	
B	24 V DC load voltage supply for outputs																	
C	FE																	
D	0V																	
Round connector, 5-pin																		
	<p>0V Valves 24V Valves 0V Output 24V Output 0V El./Sen. 24V El./Sen. FE</p>	7/8"																
			<table border="1"> <tr><td>1</td><td>0 V outputs</td></tr> <tr><td>2</td><td>n.c.</td></tr> <tr><td>3</td><td>FE</td></tr> <tr><td>4</td><td>n.c.</td></tr> <tr><td>5</td><td>24 V DC load voltage supply for outputs</td></tr> </table>	1	0 V outputs	2	n.c.	3	FE	4	n.c.	5	24 V DC load voltage supply for outputs					
1	0 V outputs																	
2	n.c.																	
3	FE																	
4	n.c.																	
5	24 V DC load voltage supply for outputs																	
<table border="1"> <tr><td>M18</td><td>1</td><td>2</td><td>3</td><td>4</td></tr> <tr><td>7/8"</td><td>A</td><td>B</td><td>D</td><td>C</td></tr> <tr><td></td><td>n.c.</td><td>24V</td><td>0V</td><td>FE</td></tr> </table>	M18	1	2	3	4	7/8"	A	B	D	C		n.c.	24V	0V	FE			
M18	1	2	3	4														
7/8"	A	B	D	C														
	n.c.	24V	0V	FE														
<table border="1"> <tr><td>7/8"</td><td>1</td><td>2</td><td>3</td><td>4</td><td>5</td></tr> <tr><td></td><td>0V</td><td>n.c.</td><td>FE</td><td>n.c.</td><td>24V</td></tr> </table>	7/8"	1	2	3	4	5		0V	n.c.	FE	n.c.	24V						
7/8"	1	2	3	4	5													
	0V	n.c.	FE	n.c.	24V													

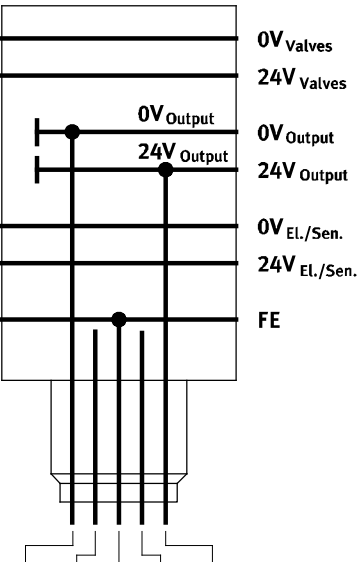
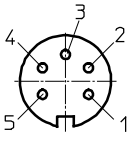
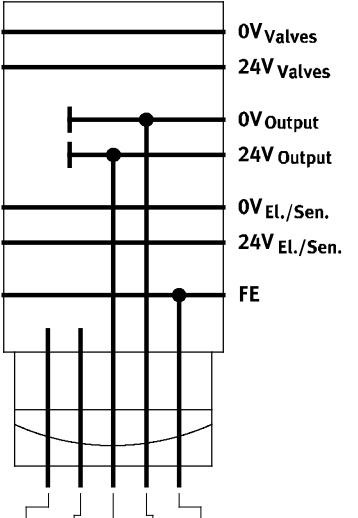
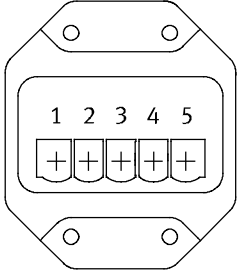

Terminal CPX

Technical data – Interlinking block with additional power supply for outputs

Pin allocation – Metal interlinking blocks																
Circuitry		Pin	Allocation													
Round connector, 5-pin																
	7/8"			1	0 V outputs											
				2	n.c.											
			3	FE												
			4	n.c.												
			5	24 V DC load voltage supply for outputs												
<table border="1" data-bbox="167 1008 478 1075"> <tr> <td>7/8"</td> <td>1</td> <td>2</td> <td>3</td> <td>4</td> <td>5</td> </tr> <tr> <td></td> <td>0V</td> <td>n.c.</td> <td>FE</td> <td>n.c.</td> <td>24V</td> </tr> </table>	7/8"	1	2	3	4	5		0V	n.c.	FE	n.c.	24V				
7/8"	1	2	3	4	5											
	0V	n.c.	FE	n.c.	24V											
Push-pull plug, 5-pin																
	Plug pattern to PROFINET specification															
		1	n.c.													
2		n.c.														
	3	24 V DC load voltage supply for outputs														
	4	0 V outputs														
	5	FE														
<table border="1" data-bbox="167 1691 470 1758"> <tr> <td>PP</td> <td>1</td> <td>2</td> <td>3</td> <td>4</td> <td>5</td> </tr> <tr> <td></td> <td>n.c.</td> <td>n.c.</td> <td>24V</td> <td>0V</td> <td>FE</td> </tr> </table>	PP	1	2	3	4	5		n.c.	n.c.	24V	0V	FE				
PP	1	2	3	4	5											
	n.c.	n.c.	24V	0V	FE											

Terminal CPX

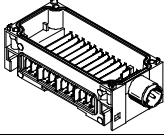
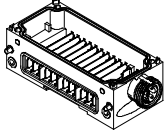
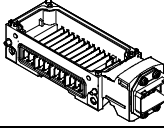
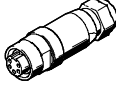
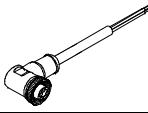
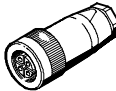
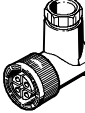
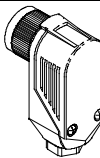
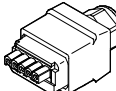
Accessories – Interlinking block with additional power supply for outputs

Ordering data					
Designation				Part No.	Type
Interlinking block with additional power supply for outputs					
	Connection M18, plastic interlinking block	4-pin	–	195744	CPX-GE-EV-Z
			For ATEX environment	8022166	CPX-GE-EV-Z-VL
	Connection 7/8", plastic interlinking block	4-pin	–	541250	CPX-GE-EV-Z-7/8-4POL
		5-pin	–	541246	CPX-GE-EV-Z-7/8-5POL
	Connection 7/8", metal interlinking block	5-pin	–	550210	CPX-M-GE-EV-Z-7/8-5POL
			For ATEX environment	8022158	CPX-M-GE-EV-Z-7/8-5POL-VL
	Connection push-pull plug (AIDA), metal interlinking block	5-pin	–	563058	CPX-M-GE-EV-Z-PP-5POL
7/8" connection sockets					
	Power supply socket	5-pin		543107	NECU-G78G5-C2
		4-pin		543108	NECU-G78G4-C2
	Angled socket, 5-pin – Open cable end, 5-pin	2 m		573855	NEBU-G78W5-K-2-N-LE5
M18 connection sockets					
	Straight socket, screw terminal	4-pin	PG9	18493	NTSD-GD-9
			PG13.5	18526	NTSD-GD-13,5
	Angled socket, screw terminal	4-pin	PG9	18527	NTSD-WD-9
	Angled socket, screw terminal	4-pin	PG11	533119	NTSD-WD-11
Connection socket AIDA push-pull					
	Socket, spring-loaded terminal	5-pin		563059	NECU-M-PPG5-C1
Mounting accessories					
	Screws for mounting the bus node/connection block on a plastic interlinking block	Bus node/metal connection block		550218	CPX-DPT-30X32-S-4X
		Bus node/plastic connection block		550219	CPX-M-M3x22-4x
	Screws for mounting the bus node/connection block on a metal interlinking block	Bus node/metal connection block		550216	CPX-M-M3x22-S-4x

Terminal CPX

Technical data – Interlinking block with additional power supply for valves

Function

Interlinking blocks ensure the electrical supply of all other CPX modules. They have contact rails, from which the other CPX components on the interlinking modules are supplied with current.

Internal division of the power supply makes it possible to switch off specific areas of the sensors and actuators individually.

Applications

- 24 V DC supply voltage for valves





General technical data			
Type	CPX-GE-EV-V	CPX-GE-EV-V-VL	CPX-GE-EV-V-7/8-4POL
Electrical connection	M18		7/8", 4-pin
Nominal operating voltage [V DC]	24		
Acceptable current load (per contact/contact rail) [A]	16	8	10
Protection class to EN 60529	Depending on connection block		
Ambient temperature [°C]	-5 ... +50		
Note on materials	RoHS-compliant		
Materials	Polymer		
Grid dimension [mm]	50		
Dimensions W x L x H [mm]	50 x 107 x 35		
Weight [g]	125		

Pin allocation – Plastic interlinking blocks																		
Circuitry		Pin	Allocation															
Round connector, 4-pin																		
	M18																	
			1	n.c.														
			2	24 V DC load voltage supply for valves														
			3	0 V														
			4	FE														
	7/8"																	
			A	n.c.														
			B	24 V DC load voltage supply for valves														
			C	FE														
			D	0V														
<table border="1"> <tr> <td>M18</td> <td>1</td> <td>2</td> <td>3</td> <td>4</td> </tr> <tr> <td>7/8"</td> <td>A</td> <td>B</td> <td>D</td> <td>C</td> </tr> <tr> <td></td> <td>n.c.</td> <td>24V</td> <td>0V</td> <td>FE</td> </tr> </table>		M18	1	2	3	4	7/8"	A	B	D	C		n.c.	24V	0V	FE		
M18	1	2	3	4														
7/8"	A	B	D	C														
	n.c.	24V	0V	FE														

Terminal CPX

FESTO

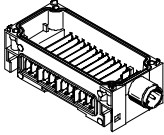
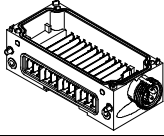
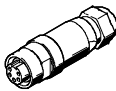
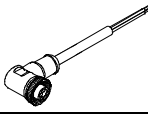
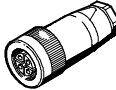
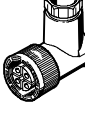
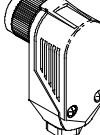
Accessories – Interlinking block with additional power supply for valves

Ordering data					
Designation				Part No.	Type
Interlinking block with additional power supply for valves					
	Connection M18, plastic interlinking block	4-pin	–	533577	CPX-GE-EV-V
			For ATEX environment	8022171	CPX-GE-EV-V-VL
	Connection 7/8", plastic interlinking block	4-pin	–	541252	CPX-GE-EV-V-7/8-4POL
7/8" connection sockets					
	Power supply socket	5-pin		543107	NECU-G78G5-C2
		4-pin		543108	NECU-G78G4-C2
	Angled socket, 5-pin – Open cable end, 5-pin	2 m		573855	NEBU-G78W5-K-2-N-LE5
M18 connection sockets					
	Straight socket, screw terminal	4-pin	PG9	18493	NTSD-GD-9
		4-pin	PG13.5	18526	NTSD-GD-13,5
	Angled socket, screw terminal	4-pin	PG9	18527	NTSD-WD-9
	Angled socket, screw terminal	4-pin	PG11	533119	NTSD-WD-11
Mounting accessories					
	Screws for mounting the bus node/connection block on a plastic interlinking block	Bus node/metal connection block		550218	CPX-DPT-30X32-S-4X

Terminal CPX

Technical data – Pneumatic interface VMPA-FB

Function

The pneumatic interface VMPA-FB establishes the electromechanical connection between the CPX terminal and the valve terminal MPA-S. The signals from the bus node are forwarded to the control electronics in the electrical modules of the valve terminal MPA-S via the integrated CPX bus. The bus signal for activation of the solenoid coils is converted in the electronics module for max. 8 coils. From a technical point of view, the individual MPA pneumatic modules each represent a separate electrical module with digital outputs. Valves, which are galvanically isolated, can be supplied with power via the interlinking block CPX-GE-EV-V.

Applications

- Interface to the valve terminal MPA-S
- Max. 128 solenoid coils
- Features of the electronics module of the valve terminal MPA-S can be parameterised, for example status of the solenoid coils in the event of fieldbus communication being interrupted (fail-safe), individual channel diagnostics can be activated, condition monitoring can be activated individually for each valve
- The pneumatic interface receives the voltage for the electronics and the supply voltage for the valves from the left-hand interlinking block and feeds them through to the electronics modules of the valve terminal MPA-S
- Electronics modules of the valve terminal MPA-S:
 - Undervoltage of valves
 - Short circuit of valves
 - Open load of valves
 - Counter preset reached in condition monitoring



General technical data		
Type	VMPA-FB-EPL-G	VMPA-FB-EPL-E
No. of solenoid coils	128	
Pilot air supply	Internal	External
Pilot air connection 12/14	–	M7
Pneumatic connection 1	G $\frac{1}{4}$	G $\frac{1}{4}$
Operating pressure [bar]	3 ... 8	–0.9 ... 10
Pilot pressure [bar]	3 ... 8	3 ... 8
Nominal operating voltage [V DC]	24	
Protection class to EN 60529	IP65	
Ambient temperature [°C]	–5 ... +50	
Materials	Cover	Polyamide
	Housing	Die-cast aluminium
Weight [g]	Approx. 320	

Terminal CPX

Accessories – Pneumatic interface VMPA-FB

FESTO

Overview – Pneumatic interface VMPA-FB

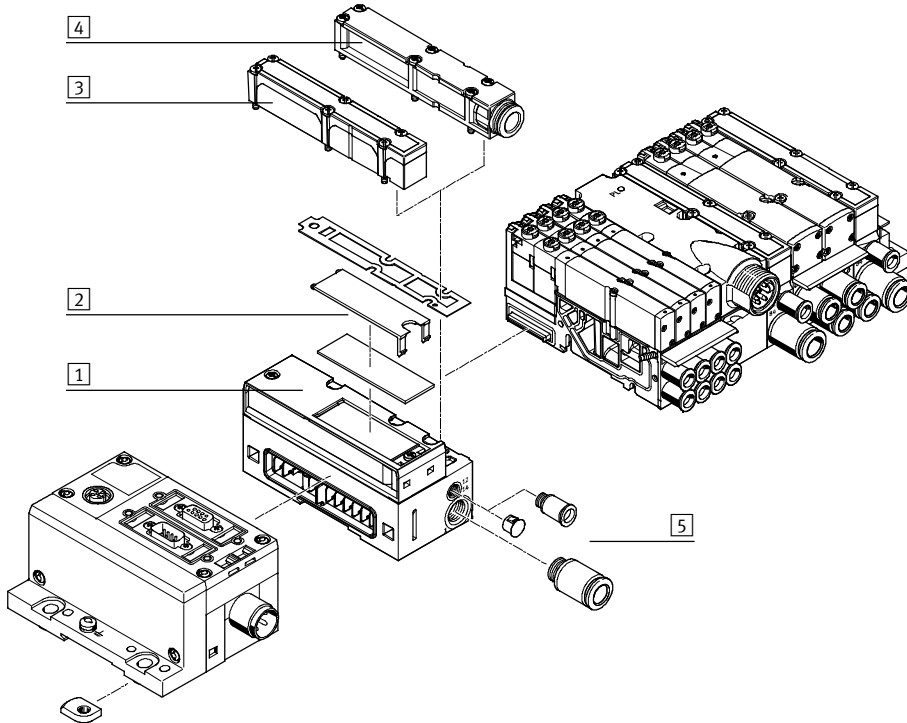

- 1 Pneumatic interface VMPA-FB
- 2 Inscription label
- 3 Flat plate silencer
- 4 Exhaust plate for ducted exhaust air
- 5 Fittings

Ordering data

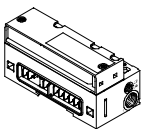
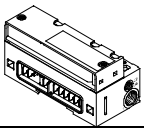
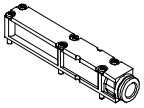
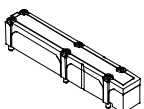
Designation	Part No.	Type
Pneumatic interface for CPX plastic interlinking module		
	Ducted exhaust air, internal pilot air	533370 VMPA-FB-EPL-G
	Ducted exhaust air, external pilot air	533369 VMPA-FB-EPL-E
	Flat plate silencer, internal pilot air	533372 VMPA-FB-EPL-GU
	Flat plate silencer, external pilot air	533371 VMPA-FB-EPL-EU
Pneumatic interface for CPX metal interlinking module		
	Ducted exhaust air, internal pilot air	552286 VMPA-FB-EPLM-G
	Ducted exhaust air, external pilot air	552285 VMPA-FB-EPLM-E
	Flat plate silencer, internal pilot air	552288 VMPA-FB-EPLM-GU
	Flat plate silencer, external pilot air	552287 VMPA-FB-EPLM-EU
Exhaust plate		
	For ducted exhaust air, with 10 mm push-in connector	533375 VMPA-AP
	For ducted exhaust air, with QS-3/8 connector	541629 VMPA-AP-3/8
	Flat plate silencer	533374 VMPA-APU

Terminal CPX

Technical data – Pneumatic interface VMPAL

Function

The pneumatic interface VMPAL establishes the electromechanical connection between the terminal CPX and the valve terminal MPA-L.

The bus signal for actuating the solenoid coils is converted in the pneumatic interface for the entire valve terminal.

The interlinking within the valve terminal is identical with the interlinking with multi-pin plug connections.

Application

- Actuation of the valve terminal MPA-L
- Max. 32 solenoid coils
- The pneumatic interface receives the voltage for the electronics and the supply voltage for the valves from the left-hand interlinking block and feeds them through to the electric modules of the valve terminal MPA-L



General technical data	
Type	VMPAL-EPL-CPX
Number of solenoid coils	32
Operating pressure [bar]	-0.9 ... 10
Pilot pressure [bar]	3 ... 8
Nominal operating voltage [V DC]	24
Protection class to EN 60529	IP67
Ambient temperature [°C]	-5 ... +50
Note on materials	RoHS-compliant

Overview – Pneumatic interface VMPAL

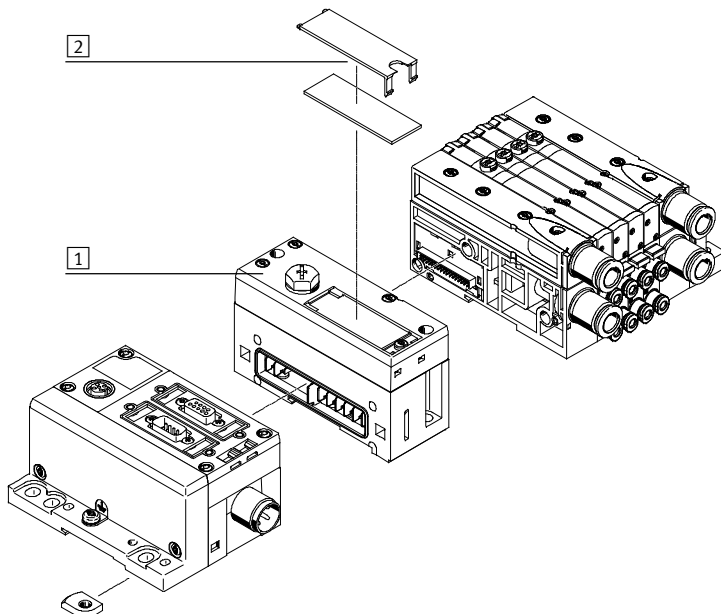

- 1 Pneumatic interface VMPAL
- 2 Inscription label

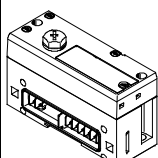
Ordering data		
Designation	Part No.	Type
 Pneumatic interface for CPX plastic interlinking module	570783	VMPAL-EPL-CPX

Terminal CPX

Technical data – Pneumatic interface VMPAF

Function

The pneumatic interface VMPAF establishes the electromechanical connection between the CPX terminal and the valve terminal MPA-F. The signals from the bus node are forwarded to the control electronics in the electrical modules of the valve terminal MPA-F via the integrated CPX bus. The bus signal for activation of the solenoid coils is converted in the electronics module for max. 8 coils. From a technical point of view, the individual MPA-F pneumatic modules each represent a separate electrical module with digital outputs. Valves, which are galvanically isolated, can be supplied with power via the interlinking block CPX-GE-EV-V.

Applications

- Interface to the valve terminal MPA-F
- Max. 128 solenoid coils
- Electronics module can be parameterised, for example status of the solenoid coils in the event of fieldbus communication being interrupted (fail-safe), individual channel diagnostics, condition monitoring can be activated individually for each valve
- In the version with pressure sensor, display of the numerical pressure value, unit and adherence to setpoint value. Parameterisation via PLC or handheld unit (CPX-MMI)
- Voltage for electronics and valves supplied from the left-hand interlinking block
- Electronics modules of the valve terminal MPA-F:
 - Undervoltage of valves
 - Short circuit of valves
 - Open load of valves
 - Counter preset reached in condition monitoring



General technical data		
Type	VMPAF-FB-EPL	VMPAF-FB-EPL-PS
Version	–	With integrated pressure sensor for channel 1
No. of solenoid coils	128	
Pneumatic connection 1	G1/2	
Operating pressure [bar]	–0.9 ... 10	0 ... 10
Accuracy FS [%]	–	2.5
Nominal operating voltage [V DC]	24	
Protection class to EN 60529	IP65	
Ambient temperature [°C]	–5 ... +50	
CE mark (see declaration of conformity)	To EU EMC Directive	
Note on materials	RoHS-compliant	
Weight [g]	690	



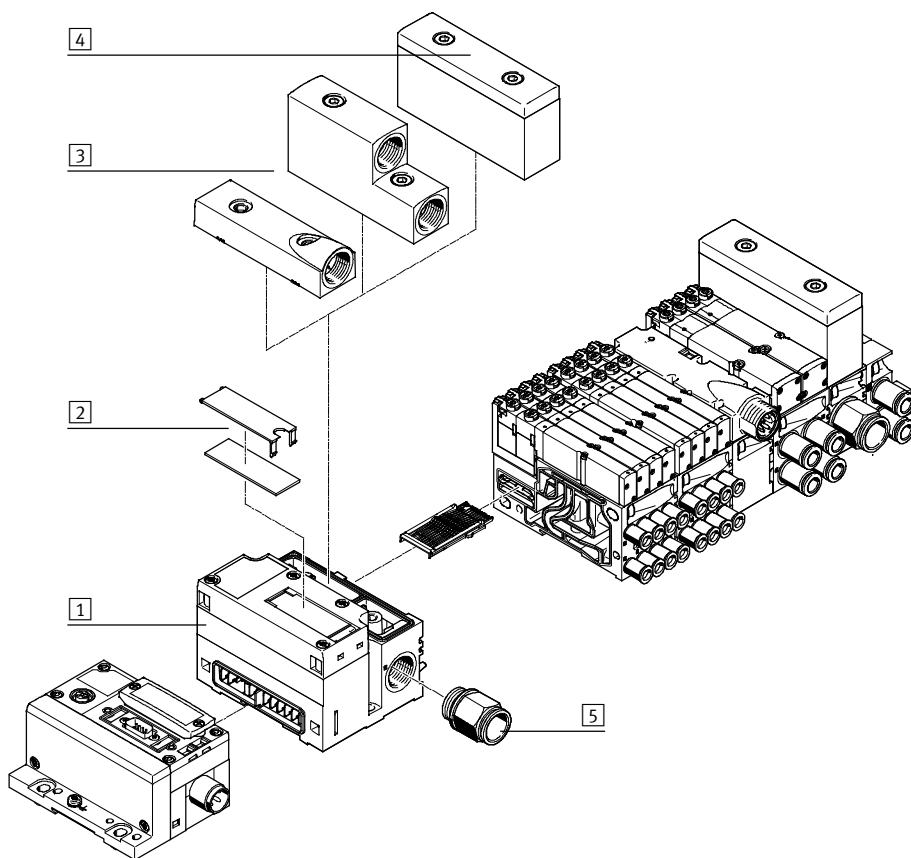

Terminal CPX

Accessories – Pneumatic interface VMPAF

Overview – Pneumatic interface VMPAF

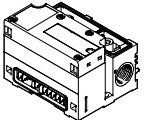
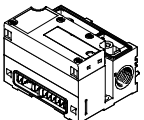

- 1 Pneumatic interface VMPAF
- 2 Inscription label
- 3 Exhaust plate for ducted exhaust air
- 4 Flat plate silencer
- 5 Fittings

Ordering data		
Designation	Part No.	Type
Pneumatic interface for CPX plastic interlinking module		
	Without exhaust plate, without flat plate silencer	544399 VMPAF-FB-EPL
	Without exhaust plate, without flat plate silencer, with integrated pressure sensor for channel 1	547491 VMPAF-FB-EPL-PS
Pneumatic interface for CPX metal interlinking module		
	Without exhaust plate, without flat plate silencer	552279 VMPAF-FB-EPLM
	Without exhaust plate, without flat plate silencer, with integrated pressure sensor for channel 1	552280 VMPAF-FB-EPLM-PS
Exhaust plate		
	For ducted exhaust air, ducts 3/5 common	544411 VMPAF-AP-1
	For ducted exhaust air, duct 3 and duct 5 separated	544412 VMPAF-AP-2
	Flat plate silencer	544410 VMPAF-APU

Terminal CPX

Technical data – Pneumatic interface VTSA/VTSA-F

Function

The pneumatic interface VTSA provides the electromechanical connection between the terminal CPX and valve terminal VTSA/VTSA-F.

A complete pneumatic control loop system (FB-valve-drive-sensor-FB) can therefore be connected to the fieldbus using the input modules of the terminal CPX.

Different circuits for valves and electrical outputs are implemented using an additional power supply. The integrated valve diagnostic functions enable the causes of errors to be found quickly, therefore increasing system availability.

Application

- Interface to the valve terminal VTSA and VTSA-F
- Max. 32 solenoid coils
- Address space allocation (configuration) of valve terminals can be set using integrated DIL switches
- Properties of the pneumatic interface can be parameterised, e.g. status of the solenoid coil when fieldbus communication is interrupted (failsafe)
- The pneumatic interface receives the voltage for the electronics and the supply voltage for the valves from the left-hand interlinking block
- Detection of missing solenoid coils and short circuit monitoring for the valves



General technical data			
Number of solenoid coils		32	
Electrical actuation		Fieldbus	
Electrical connection		Via CPX	
Diagnostics		Undervoltage at valves	
Parameterisation		<ul style="list-style-type: none"> • Failsafe per channel • Forces per channel • Idle mode per channel • Module monitoring 	
LED displays		<ul style="list-style-type: none"> • 1 Group diagnostics • Channel status (on each valve) 	
Fuse protection (short circuit)		Internal electronic fuse per valve output	
Electrical isolation channel – internal bus		Yes, when using an additional power supply for the valves	
Nominal operating voltage		[V DC]	24
Operating voltage range		[V DC]	21.6 ... 26.4
Intrinsic current consumption at nominal operating voltage	Electronic components	[mA]	Typically 15
	Valves	[mA]	Typically 50
Max. power supply per channel		[A]	0.2
Max. residual current per module		[A]	4
Protection class		<ul style="list-style-type: none"> • IP65 (to EN 60529) • NEMA 4 	
Ambient temperature		[°C]	-5 ... +50
Materials	Housing	Die-cast aluminium	
	Bearing and end cap	PA	
Note on materials		RoHS-compliant	
Product weight		[g]	590

Ordering data				
Designation		Part No.	Type	
	For plastic interlinking block	543416	VABA-S6-1-X1	
	For metal interlinking block	Diagnostics via fieldbus	550663	VABA-S6-1-X2
		Diagnostics via image table	573613	VABA-S6-1-X2-D

Terminal CPX

Technical data – Pneumatic interface MIDI/MAXI

Function

The pneumatic interface MIDI/MAXI connects the valve terminal MIDI/MAXI to the supported fieldbus protocols of the CPX terminal. A complete pneumatic control loop system (FB-valve-drive-sensor-FB) can therefore be connected to the fieldbus using the input modules of the CPX terminal. Different circuits for valves and electrical outputs are implemented using an additional power supply. The integrated valve diagnostic functions enable the causes of errors to be found quickly, therefore increasing system availability.

Applications

- Interface to valve terminals MIDI/MAXI
- Max. 26 solenoid coils
- Address space allocation (configuration) of valve terminals can be set using integrated DIL switches
- Pneumatic interface features can be parameterised, for example status of the solenoid coils in the event of fieldbus communication being interrupted (fail-safe)
- The pneumatic interface receives the voltage for the electronics and the supply voltage for the valves from the left-hand interlinking block

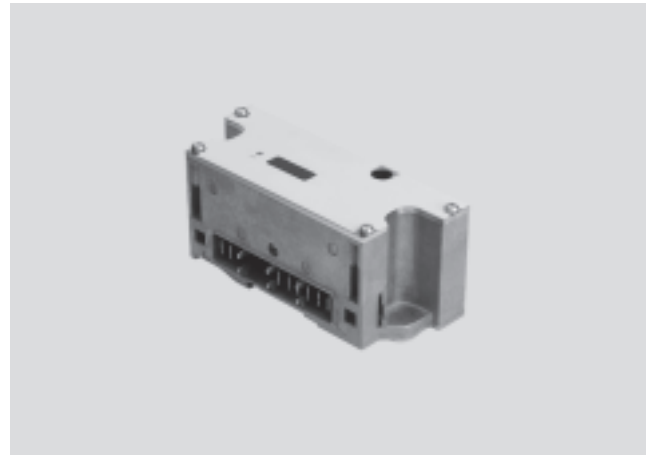

General technical data			CPX-GP-03-4,0	CPX-M-GP-03-4,0
Type			Plastic	Metal
Connection for CPX interlinking blocks made of				
No. of solenoid coils			26	
Max. power supply	Per module	[A]	4	
	Per channel	[A]	0.2	
Fuse protection			Internal electronic fuse for each valve output	
Current consumption of modules for electronics		[mA]	Typically 15	
Current consumption of modules for valves		[mA]	Typically 30	
Nominal operating voltage		[V DC]	24	
Operating voltage range		[V DC]	21.6 ... 26.4	
Electrical isolation	Channel – channel		No	
	Channel – internal bus		Yes, using an additional power supply for valves	
LED displays	Group diagnostics		1	
	Channel diagnostics		–	
	Channel status		– (on valves)	
Diagnostics			<ul style="list-style-type: none"> • Undervoltage of valves 	
Parameterisation			<ul style="list-style-type: none"> • Module monitoring • Fail-safe behaviour, channel x 	
Protection class to EN 60529			IP65	
Ambient temperature		[°C]	–5 ... +50	
Materials	Cover		Steel	
			Die-cast aluminium	
Grid dimension		[mm]	50	
Dimensions W x L x H		[mm]	50 x 132 x 55	
Weight		[g]	390	

Terminal CPX

Accessories – Pneumatic interface MIDI/MAXI

FESTO

Connection and display components

CPX-GP-03-4,0

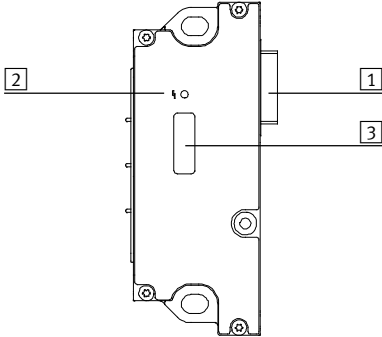

- 1 Connecting plug to valves
- 2 Error LED (red)
- 3 DIL switch under transparent cover

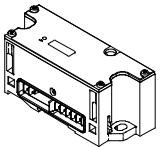
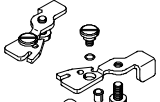
Ordering data			
Designation		Part No.	Type
Pneumatic interface MIDI/MAXI			
	For plastic interlinking block	195738	CPX-GP-03-4,0
	For metal interlinking block	556775	CPX-M-GP-03-4,0
H-rail mounting			
	For mounting CPX terminal and valve terminal MIDI on H-rail	526033	CPX-03-4,0
	For mounting CPX terminal and valve terminal MAXI on H-rail	526034	CPX-03-7,0

Terminal CPX

Technical data – Pneumatic interface CPA

Function

The pneumatic interface CPA connects the valve terminal CPA to the supported fieldbus protocols of the CPX terminal. A complete pneumatic control loop system (FB-valve-drive-sensor-FB) can therefore be connected to the fieldbus using the input modules of the CPX terminal. Different circuits for valves and electrical outputs are implemented using an additional power supply. The integrated valve diagnostic functions enable the causes of errors to be found quickly, therefore increasing system availability.

Applications

- Interface to valve terminals CPA10 and CPA14
- Max. 22 solenoid coils
- Address space allocation (configuration) of valve terminals can be set using integrated DIL switches
- Pneumatic interface features can be parameterised, for example status of the solenoid coils in the event of fieldbus communication being interrupted (fail-safe)
- The pneumatic interface receives the voltage for the electronics and the supply voltage for the valves from the left-hand interlinking block
- Detection of missing solenoid coils and short circuit monitoring for the valves



General technical data			
No. of solenoid coils			22
Max. power supply	Per module	[A]	4
	Per channel	[A]	0.2
Fuse protection			Internal electronic fuse for each valve output
Current consumption of module from electronics/sensor supply		[mA]	Typically 15
Supply voltage for valves		[V DC]	24 +10% -15%
Electrical isolation	Channel – channel		No
	Channel – internal bus		Yes, using an additional power supply for valves (in preparation)
LED displays	Group diagnostics		1
	Channel diagnostics		–
	Channel status		– (on valves)
Diagnostics			<ul style="list-style-type: none"> • Load voltage of valves • Short circuit, solenoid coils (channel-oriented) • Wire break, solenoid coils (channel-oriented quiescent current detection for solenoid coils)
Parameterisation			<ul style="list-style-type: none"> • Module monitoring • Wire break monitoring, channel x • Fail-safe behaviour, channel x
Protection class to EN 60529			IP65
Temperature range	Operation	[°C]	–5 ... +50
	Storage/transport	[°C]	–20 ... +70
Materials			Polymer
Grid dimension		[mm]	50
Dimensions W x L x H		[mm]	50 x 110 x 58
Weight		[g]	150

- 1 - Type discontinued
Available up until 2015

FESTO

Terminal CPX

Accessories – Pneumatic interface CPA

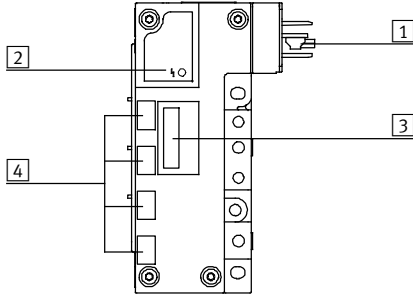

Connection and display components

CPX-GP-CPA-...

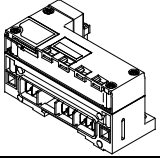

- 1 Connecting plug to valves
- 2 Error LED (red)
- 3 DIL switch under transparent cover
- 4 Inscription fields for addresses

Ordering data

Designation	Part No.	Type
Pneumatic interface CPA		
 For CPA in 10 mm width	195710	CPX-GP-CPA-10
For CPA in 14 mm width	195712	CPX-GP-CPA-14
H-rail mounting		
 For mounting CPX terminal and valve terminal CPA on H-rail	526032	CPX-CPA-BG-NRH

Terminal CPX

Technical data

FESTO

Dimensions – Metal interlinking block

Download CAD data → www.festo.com

With bus nodes and connection blocks

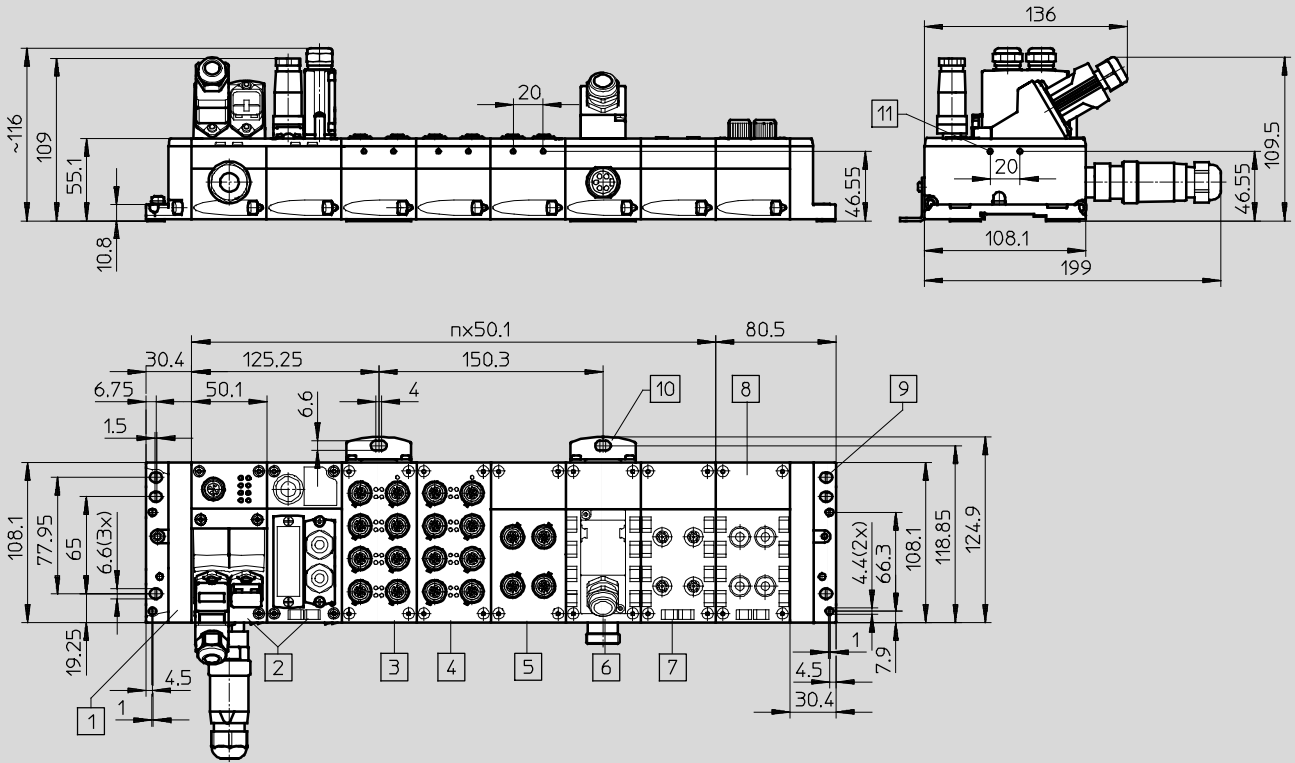

- | | | | | | | | |
|---|---|---|---|----|---------------------------------------|---|--|
| 1 | Left-hand end plate | 6 | Connection block
CPX-AB-1-SUB-BU-25POL | 9 | Right-hand end plate | n | Number of bus nodes and
connection blocks for CPX |
| 2 | Bus nodes | 7 | Connection block CPX-
AB-4-M12-8POL | 10 | Mounting bracket for wall
mounting | | |
| 3 | Connection block
CPX-M-AB-8-M12X2-5POL | 8 | Connection block
CPX-AB-4-HAR-4POL | 11 | Hole for self-tapping screw
M2.5 | | |
| 4 | Connection block
CPX-M-AB-8-M12X2-5POL | | | | | | |
| 5 | Connection block
CPX-M-AB-4-M12X2-5POL | | | | | | |

Terminal CPX

Technical data

FESTO

Dimensions

Download CAD data → www.festo.com

With bus nodes and valve terminal VTSA

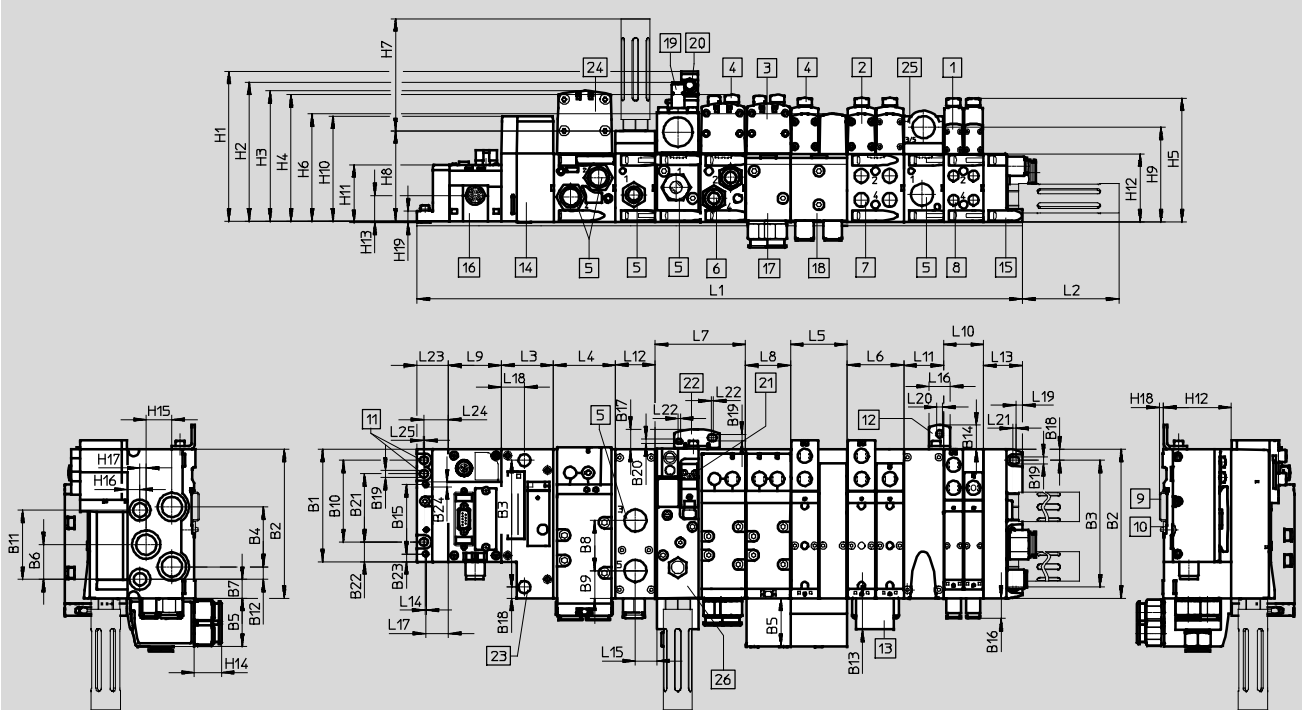

- | | | | |
|---------------------------------------|--|---|---|
| 1 Solenoid valve, width 18 mm | 10 H-rail mounting | 20 Plug socket M12x1 | n02 Number of manifold sub-bases 38 mm |
| 2 Solenoid valve, width 26 mm | 11 Mounting hole | 21 Electrical connection to EN 175301-803, type C | n01 Number of manifold sub-bases 54 mm |
| 3 Solenoid valve, width 42 mm | 12 Additional mounting bracket | 22 Additional mounting bracket | n1 Number of manifold sub-bases 43 mm |
| 4 Cover cap/manual override | 13 Inscription label holder | 23 Hole for additional mounting, diameter 6.4 2x | n2 Number of manifold sub-bases 59 mm |
| 5 Threaded connection G $\frac{1}{2}$ | 14 Pneumatic interface CPX | 24 Solenoid valve, width 52 mm | n Number of supply plates (only with end plate with pilot air selector) |
| 6 Threaded connection G $\frac{3}{8}$ | 15 End plate | 25 Supply plate | m Number of CPX modules |
| 7 Threaded connection G $\frac{1}{4}$ | 16 CPX module/bus node | 26 Soft-start valve | |
| 8 Threaded connection G $\frac{1}{8}$ | 17 90° connection plate 43 mm, G $\frac{3}{8}$ | | |
| 9 H-rail | 18 90° connection plate 54 mm, G $\frac{1}{4}$ | | |
| | 19 Proximity sensor M12x1 | | |

Dim.	B1	B2	B3	B4	B5	B6	B7	B8	B9	B10	B11	B12	B13	B14	B16	B18	B19	B20	B21	B22	B23	B24
[mm]	107.3	142	121	57	46	33	18	48	26	78	66	12	29.6	23	19.5	10.5	6.6	4.5	65	18.9	7.5	4.4

Dim.	L2	L3	L4	L5	L6	L7	L8	L9	L10	L11	L12	L13	L14	L15	L16	L17	L18	L19	L20	L21	L22
[mm]	92.4	50	n2x59	n01x54	54	n1x43	43	mx20.1	n02x38	nx38	38	37.3	1	20.5	20	22	22	6.3	5.5	3	2

Dim.	L23	L24	L25	H1	H2	H3	H4	H5	H6	H7	H8	H9	H10	H11	H12	H13	H14	H15	H16	H17	H18	H19
[mm]	30.4	23.7	1.5	143.9	133.3	125	121.3	118.2	103	106.8	87	90.3	101.4	55.1	65	25.8	25.7	24.5	12	6	3.5	10.8

Width	L1
18 mm	$30.4 + m \times 50.1 + 50 + n02 \times 38 + n \times 38 + 37.3$
26 mm	$30.4 + m \times 50.1 + 50 + n01 \times 54 + n \times 38 + 37.3$
42 mm	$30.4 + m \times 50.1 + 50 + n1 \times 43 + n \times 38 + 37.3$
52 mm	$30.4 + m \times 50.1 + 50 + n2 \times 59 + n \times 38 + 37.3$
Mixture of 18 mm, 26 mm, 42 mm and 52 mm	$30.4 + m \times 50.1 + 50 + n02 \times 38 + n01 \times 54 + n1 \times 43 + n2 \times 59 + n \times 38 + 37.3$

— Note: This product conforms to ISO 1179-1 and to ISO 228-1

Terminal CPX

Technical data

FESTO

Dimensions

Download CAD data → www.festo.com

With bus nodes and valve terminal VTSA-F

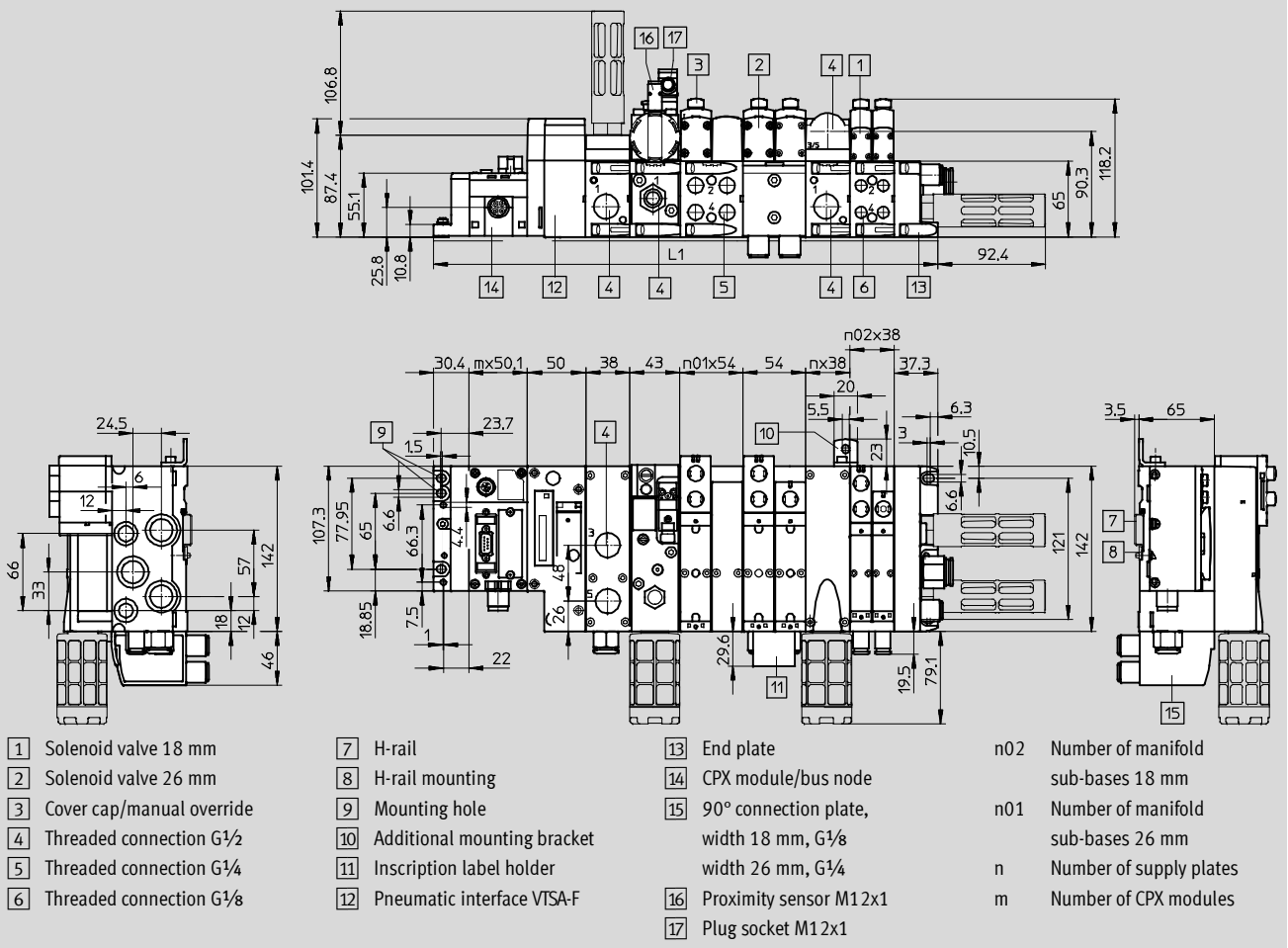

Width	L1
18 mm	$30.4 + m \times 50.1 + 50 + n02 \times 38 + n \times 38 + 37.3$
26 mm	$30.4 + m \times 50.1 + 50 + n01 \times 54 + n \times 38 + 37.3$
Mixture of 18 mm and 26 mm	$30.4 + m \times 50.1 + 50 + n02 \times 38 + n01 \times 54 + n \times 38 + 37.3$

- 7 - Type discontinued
Available up until 2015

FESTO

Terminal CPX

Technical data

Dimensions

Download CAD data → www.festo.com

With bus nodes, connection blocks and valve terminal CPA

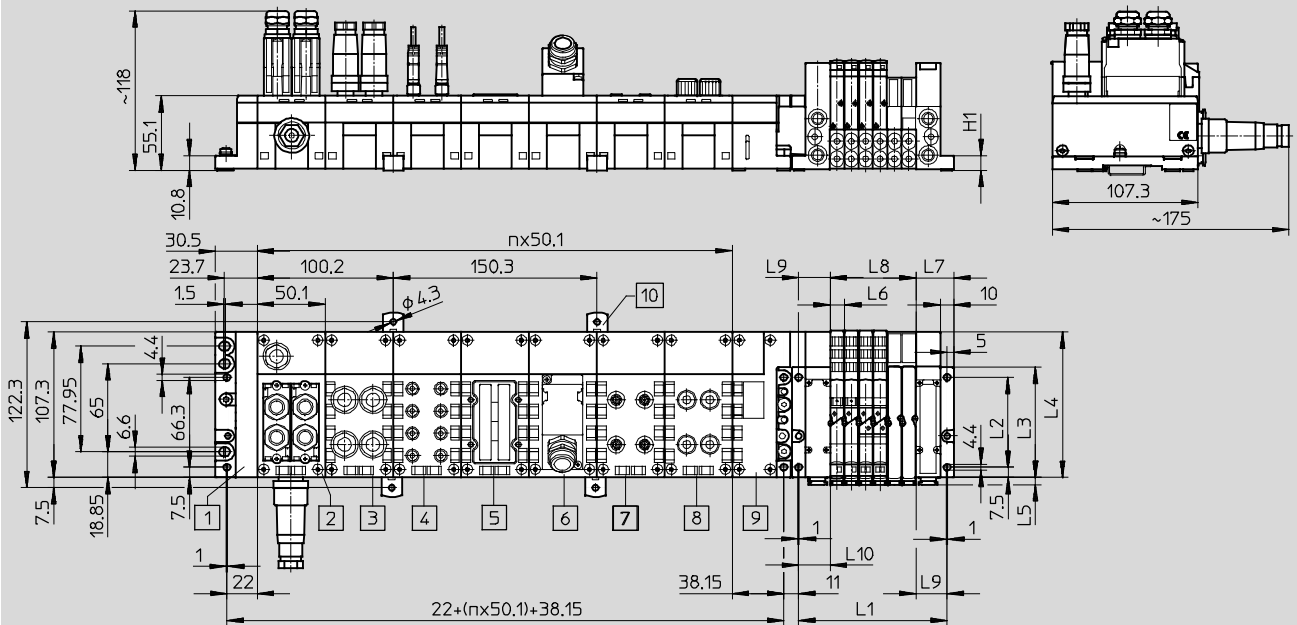

- | | | | |
|---|---|---|--|
| 1 Left-hand end plate | 6 Connection block
CPX-AB-1-SUB-BU-25POL | 9 Pneumatic interface CPA | n Number of bus nodes and
connection blocks for CPX |
| 2 Bus nodes | 7 Connection block
CPX-AB-4-HAR-4POL | 10 Mounting clip for wall
mounting (required every
2 ... 3 connection blocks) | |
| 3 Connection block
CPX-AB-4-M12-8POL | 8 Connection block
CPX-AB-4-M12x2-5POL | | |
| 4 Connection block
CPX-AB-8-M8-3POL | | | |
| 5 Connection block
CPX-AB-8-KL-4POL | | | |

Type	L1 ¹⁾	L2 ±0.1	L3	L4	L5	L6	L7	L8 ¹⁾	L9 ±0.1	H1
CPA10	46 + (m x 10.6)	66.3	81.3	108.3	5.5	10.6	28	m x 10.6	23	10.8
CPA14	51 + (m x 14.6)	76.1	91.1	118.1	6.5	14.6	31	m x 14.6	26	13

1) m = Number of valves

Terminal CPX

Technical data

FESTO

Dimensions

Download CAD data → www.festo.com

With bus nodes and valve terminal MPA-S

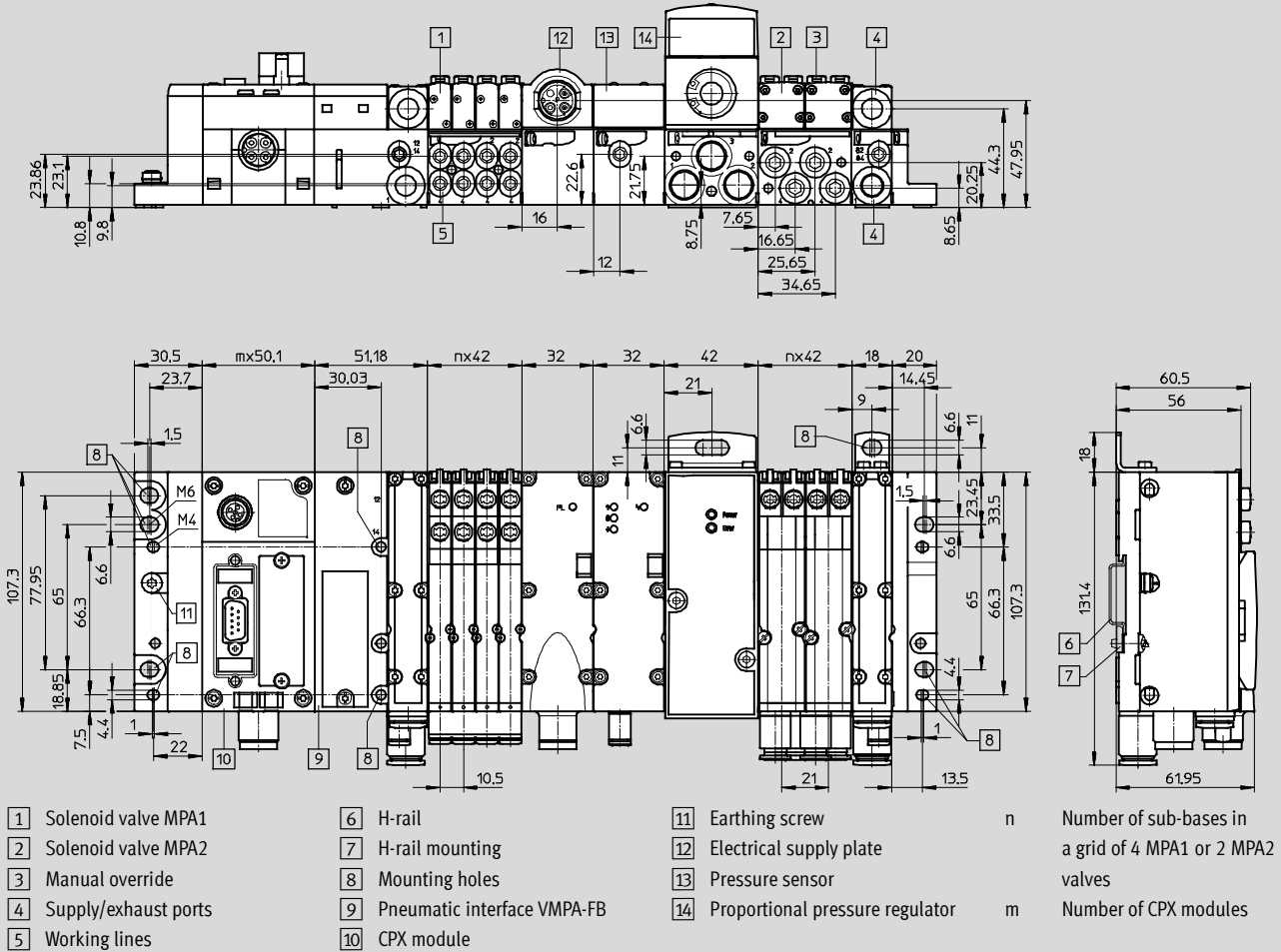

Terminal CPX

Technical data

Dimensions

Download CAD data → www.festo.com

With bus node and valve terminal MPA-L

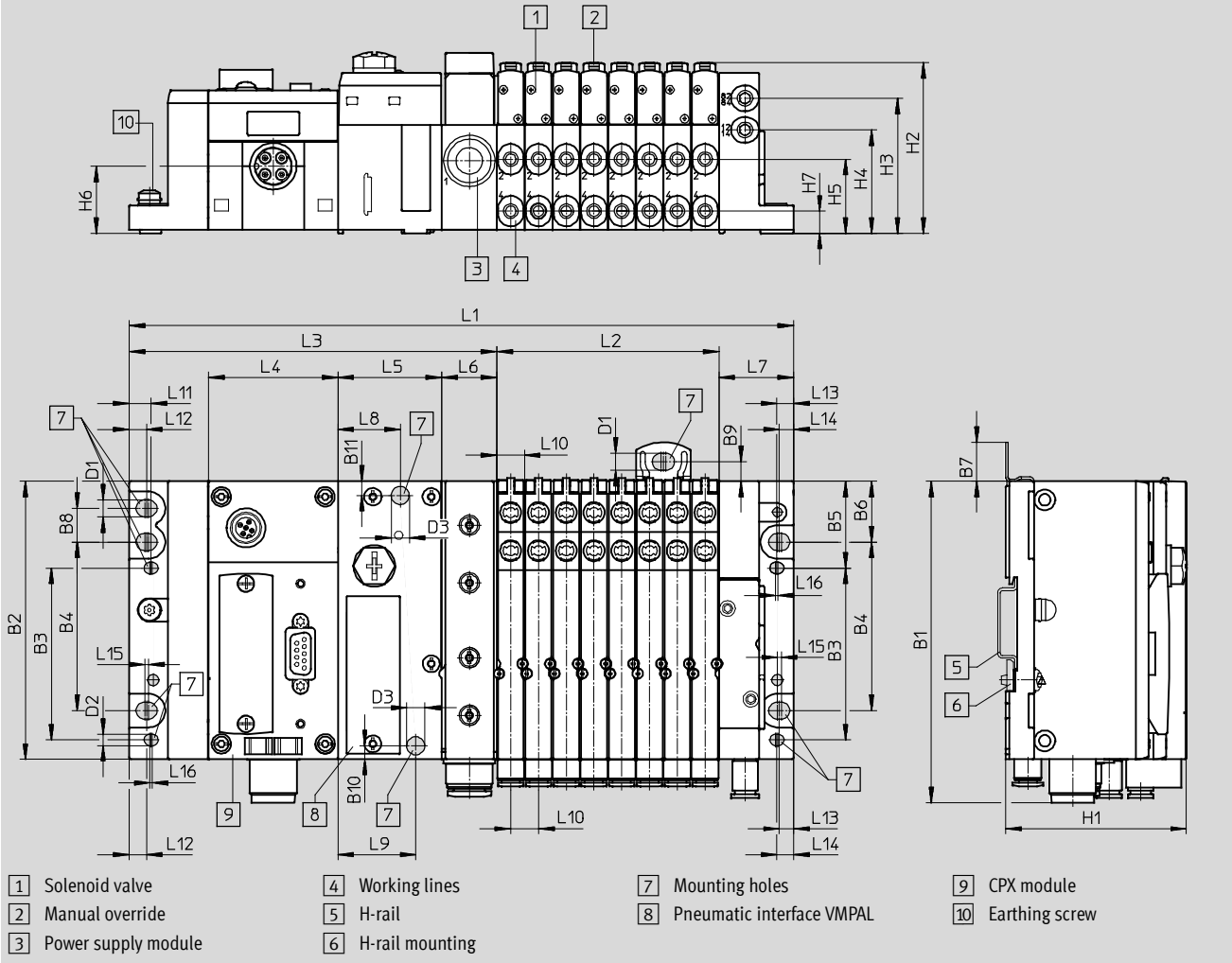

Type	L1 ¹⁾	L2 ¹⁾	L3	L4	L5	L6	L7	L8	L9	L10	L11	L12	L13	L14	D1	D2	D3
MPA-L	170.9 + n x 10.70	n x 10.70	142.1	50	40.1	21.2	28.8	24	30	10.7	8.5	6.8	5.6	6.5	6.6	4.4	7

Type	B1	B2	B3	B4	B5	B6	B7	B8	B9	B10	B11	H1	H2	H3	H4	H5	H6	H7
MPA-L	124	107.3	66.3	65	33.5	23.5	15	13	7.5	5.3	5.5	69.6	65.7	52	39.8	28.5	25.8	8.5

1) n = Number of sub-bases/valve positions

-  - Type discontinued
Available up until 2019

Terminal CPX

Technical data

FESTO

Dimensions

Download CAD data → www.festo.com

With bus nodes and valve terminal MPA-F

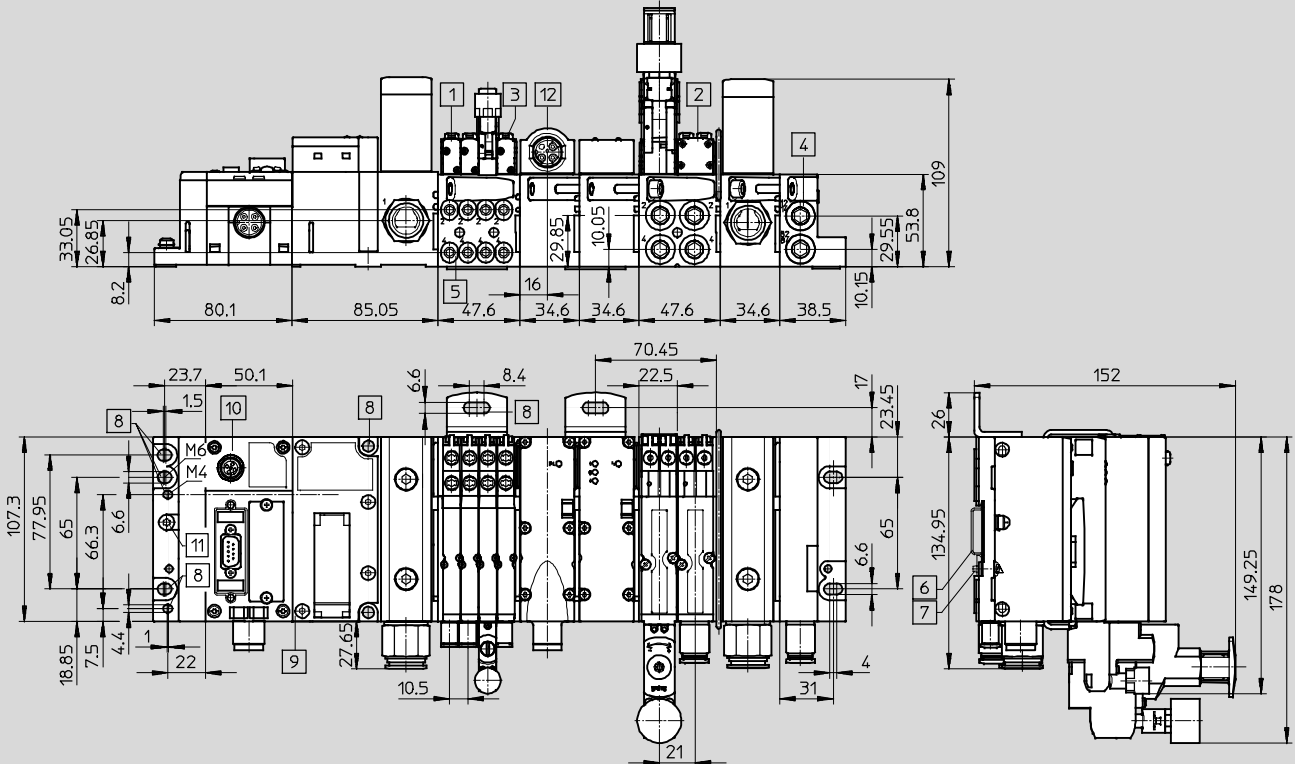

- | | | | |
|--|-------------------|-----------------------------|----------------------------|
| 1 Solenoid valve MPA1 | 5 Working lines | 8 Mounting holes | 11 Earthing screw |
| 2 Solenoid valve MPA2 | 6 H-rail | 9 Pneumatic interface VMPAF | 12 Electrical supply plate |
| 3 Manual override | 7 H-rail mounting | 10 CPX module | |
| 4 Pilot air supply,
pilot exhaust air | | | |

Terminal CPX

Technical data

Dimensions

Download CAD data → www.festo.com

With bus nodes, connection blocks and valve terminal MIDI/MAXI

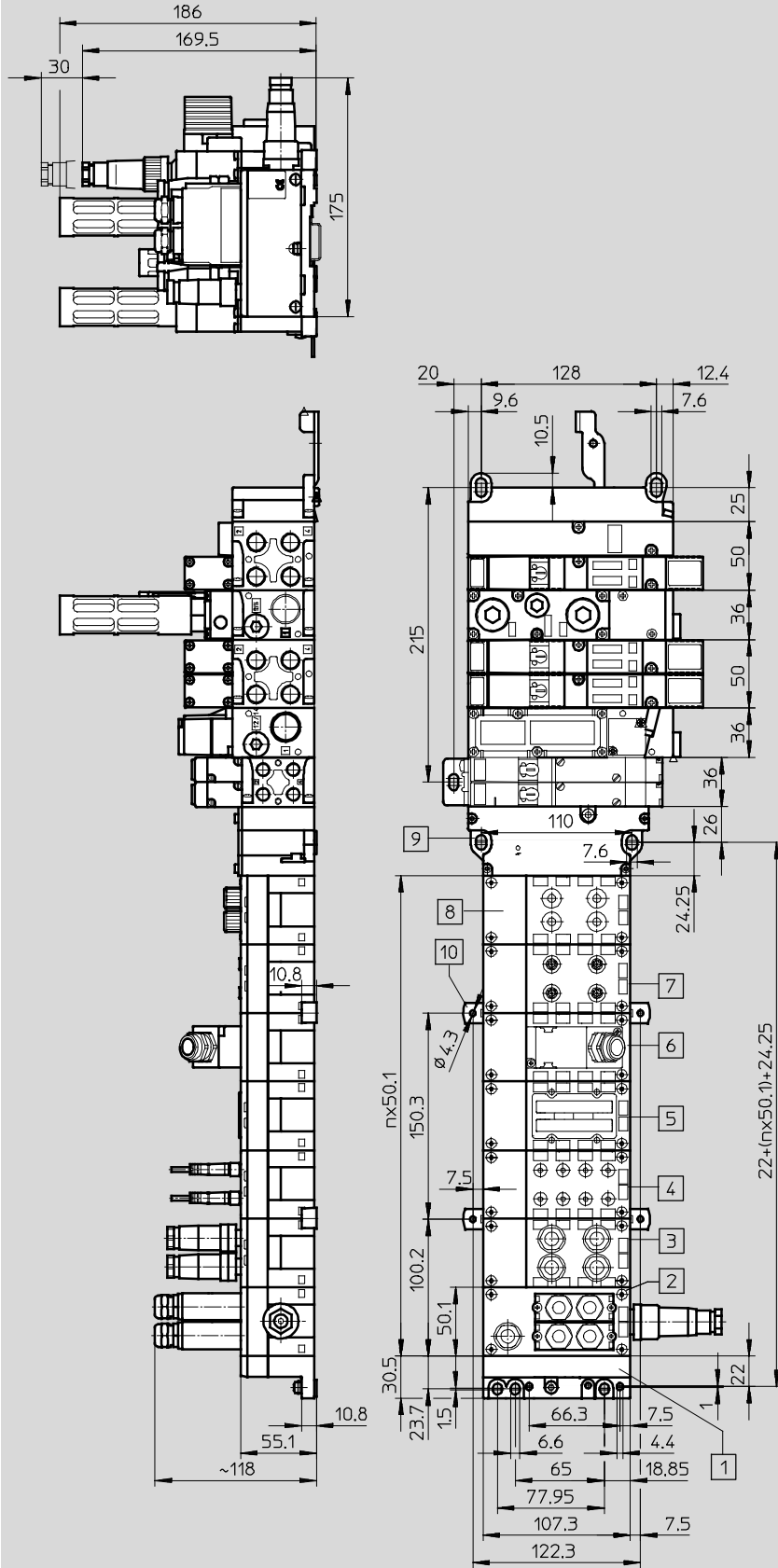









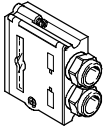

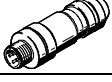

- | | | | |
|----|--|---|---|
| 1 | Left-hand end plate | n | Number of bus nodes and connection blocks for CPX |
| 2 | Bus nodes | | |
| 3 | Connection block
CPX-AB-4-M12-8POL | | |
| 4 | Connection block
CPX-AB-8-M8-3POL | | |
| 5 | Connection block
CPX-AB-8-KL-4POL | | |
| 6 | Connection block
CPX-AB-1-SUB-BU-25POL | | |
| 7 | Connection block
CPX-AB-4-HAR-4POL | | |
| 8 | Connection block
CPX-AB-4-M12X2-5POL | | |
| 9 | Pneumatic interface
MIDI/MAXI | | |
| 10 | Mounting clip for wall mounting (required every 2 ... 3 connection blocks) | | |

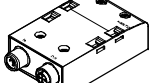
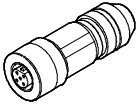
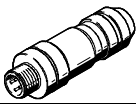
Terminal CPX

Accessories



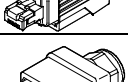
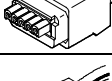



FESTO

Ordering data – Accessories				
Designation			Part No.	Type
Plug connectors and accessories				
	Sub-D plug for INTERBUS	Incoming	532218	FBS-SUB-9-BU-IB-B
		Outgoing	532217	FBS-SUB-9-GS-IB-B
	Sub-D plug for DeviceNet/CANopen		532219	FBS-SUB-9-BU-2x5POL-B
	Sub-D plug for PROFIBUS DP		532216	FBS-SUB-9-GS-DP-B
	Sub-D plug for CC-Link		532220	FBS-SUB-9-GS-2x4POL-B
	Sub-D plug		534497	FBS-SUB-9-GS-1x9POL-B
	Bus connection M12 adapter (B-coded) for PROFIBUS DP		533118	FBA-2-M12-5POL-RK
	Micro Style bus connection, 2xM12 for DeviceNet/CANopen		525632	FBA-2-M12-5POL
	Socket for Micro Style connection, M12		18324	FBSD-GD-9-5POL
	Plug for Micro Style connection, M12		175380	FBS-M12-5GS-PG9
	M12x1 bus connection, 4-pin (D-coded) for Ethernet		543109	NECU-M-S-D12G4-C2-ET
	Connection block, Sub-D socket, 9-pin, plug 7/8", 5-pin for DeviceNet		571052	CPX-AB-1-7/8-DN
	Connection block M12 adapter (B-coded) for PROFIBUS DP		541519	CPX-AB-2-M12-RK-DP
	Connection block M12 adapter (B-coded) for INTERBUS		534505	CPX-AB-2-M12-RK-IB
	Socket M12x1, 5-pin, straight, for self-assembly of a connecting cable for FBA-2-M12-5POL-RK and CPX-AB-2-M12-RK-DP		1067905	NECU-M-B12G5-C2-PB
	Plug M12x1, 5-pin, straight, for self-assembly of a connecting cable for FBA-2-M12-5POL-RK and CPX-AB-2-M12-RK-DP		1066354	NECU-M-S-B12G5-C2-PB
	Open Style bus connection for 5-pin terminal strip for DeviceNet/CANopen		525634	FBA-1-SL-5POL
	Terminal strip for Open Style connection, 5-pin		525635	FBSD-KL-2x5POL
	Screw terminal bus connection for CC-Link		197962	FBA-1-KL-5POL
	RJ45/plug		534494	FBS-RJ45-8-GS
	RJ45 plug, 8-pin, push-pull		552000	FBS-RJ45-PP-GS
	SCRJ plug, 2-pin, push-pull, for CPX-M-FB35		571017	FBS-SCRJ-PP-GS
	Socket/spring-loaded terminal, 5-pin, AIDA push-pull		563059	NECU-M-PPG5-C1
	Plug for CAN-Bus interface, Sub-D, 9-pin, without terminating resistor		533783	FBS-SUB-9-WS-CO-K

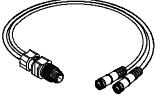
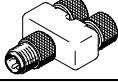
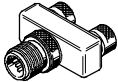
Terminal CPX

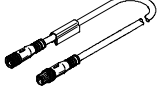
Accessories



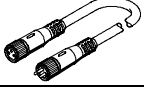
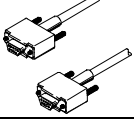
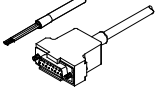
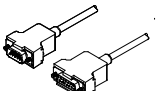

FESTO

Ordering data – Accessories				
Designation			Part No.	Type
Connecting cables				
	DUO cable M12-2xM8, 4-pin/2x3-pin	2x straight socket	18685	KM12-DUO-M8-GDGD
		2x straight/angled socket	18688	KM12-DUO-M8-GDWD
		2x angled socket	18687	KM12-DUO-M8-WDWD
	Push-in T-connector	2x socket M8, 3-pin 1x plug M8, 4-pin	544391	NEDU-M8D3-M8T4
		2x socket M12, 5-pin 1x plug M12, 4-pin	541596	NEDU-M12D5-M12T4
	Push-in T-connector		2x socket M8, 3-pin 1x plug M12, 4-pin	541597
		2x socket M9, 5-pin, angled plug-open cable end 3-pin	2 m	563711
	Connecting cable M9, 5-pin, angled plug-open cable end 3-pin		5 m	563712
			Connecting cable M8-M8, straight plug-straight socket	0.5 m
1.0 m	175489			KM8-M8-GSGD-1
2.5 m	165610			KM8-M8-GSGD-2,5
5.0 m	165611			KM8-M8-GSGD-5
Connecting cable M12-M12, 4-pin, straight plug-straight socket	2.5 m		18684	KM12-M12-GSGD-2,5
	5.0 m		18686	KM12-M12-GSGD-5
Connecting cable M12-M12, 5-pin, straight plug-straight socket	1.5 m		529044	KV-M12-M12-1,5
	3.5 m		530901	KV-M12-M12-3,5
Connecting cable for CPX-CTEL, M12-M12, 5-pin, straight plug-straight socket	5 m		574321	NEBU-M12G5-E-5-Q8N-M12G5
	7.5 m		574322	NEBU-M12G5-E-7.5-Q8N-M12G5
	10 m	574323	NEBU-M12G5-E-10-Q8N-M12G5	
	Connecting cable M12-M12, 8-pin, straight plug-straight socket	2.0 m	525617	KM12-8GD8GS-2-PU
		Connecting cable M12-M12, 4-pin, straight plug-angled socket	1.0 m	185499
	Connecting cable M9, angled plug-angled socket		0.25 m	540327
		0.5 m	540328	KVI-CP-3-WS-WD-0,5
		2 m	540329	KVI-CP-3-WS-WD-2
		5 m	540330	KVI-CP-3-WS-WD-5
		8 m	540331	KVI-CP-3-WS-WD-8
	Connecting cable M9, straight plug-straight socket	2 m	540332	KVI-CP-3-GS-GD-2
		5 m	540333	KVI-CP-3-GS-GD-5
		8 m	540334	KVI-CP-3-GS-GD-8
	Modular system for connecting cables		-	NEBU-... → Internet: nebu
	Programming cable		151915	KDI-PPA-3-BU9
	Connecting cable FED (for CPX-CEC)		539642	FEC-KBG7
	Connecting cable FED (for CPX-CEC)		539643	FEC-KBG8

Terminal CPX

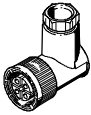
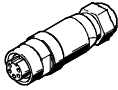
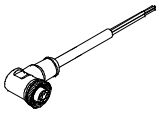
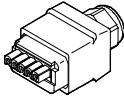
Accessories

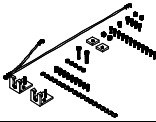
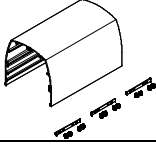
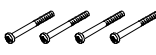



FESTO

Ordering data – Accessories				
Designation			Part No.	Type
Plug connectors and accessories – Power supply				
	Plug socket for mains connection M18, straight	For 1.5 mm ²	18493	NTSD-GD-9
		For 2.5 mm ²	18526	NTSD-GD-13.5
	Plug socket for mains connection M18, angled	For 1.5 mm ²	18527	NTSD-WD-9
		For 2.5 mm ²	533119	NTSD-WD-11
	Power supply socket	7/8" connection, 5-pin	543107	NECU-G78G5-C2
		7/8" connection, 4-pin	543108	NECU-G78G4-C2
	Angled socket, 5-pin – Open cable end, 5-pin	2 m	573855	NEBU-G78W5-K-2-N-LE5
	Connection socket AIDA push-pull, spring-loaded terminal	5-pin	563059	NECU-M-PPG5-C1
	Straight plug, spring-loaded terminal, for end plate left-hand with system supply	7-pin	576319	NECU-L3G7-C1
Hood				
	Mounting rail for securing the cover	1,000 mm	572256	CAFC-X1-S
	Mounting kit for CPX cover		572257	CAFC-X1-BE
	Hood section for CPX terminal including mounting attachments for connecting several hood sections in series	200 mm	572258	CAFC-X1-GAL-200
		300 mm	572259	CAFC-X1-GAL-300
Screws				
	Screws for mounting the bus node/connection block on a plastic interlinking block	Bus node/metal connection block	550218	CPX-DPT-30X32-S-4X
	Screws for mounting the bus node/connection block on a metal interlinking block	Bus node/plastic connection block	550219	CPX-M-M3x22-4x
		Bus node/metal connection block	550216	CPX-M-M3x22-S-4x
	Screws for attaching an inscription label holder to the bus node (CPX-FB33, CPX-M-FB34, CPX-M-FB35)	12 pieces	550222	CPX-M-M2,5X8-12X

Terminal CPX

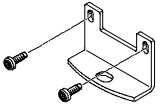
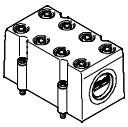
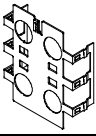
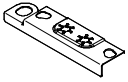
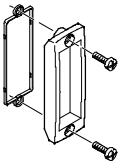
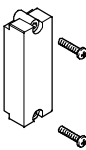
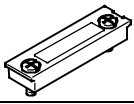
Accessories

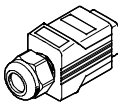

FESTO

Ordering data – Accessories			
Designation		Part No.	Type
Mounting			
	Attachment for wall mounting (for long valve terminals, 10 pieces)	Design for plastic manifold sub-bases	529040 CPX-BG-RW-10x
	Attachment for wall mounting, design for metal manifold sub-bases	2 mounting brackets and 4 screws	550217 CPX-M-BG-RW-2X
		1 mounting bracket and 2 screws	2721419 CPX-M-BG-VT-2X
Covers and attachments			
	Cover for CPX-AB-8-KL-4POL (IP65/67) – 8 cable through-feeds M9 – 1 cable through-feed for multi-pin plug		538219 AK-8KL
	Fittings kit		538220 VG-K-M9
	Screening plate for M12 connections		526184 CPX-AB-S-4-M12
	Earthing component (5 pieces), for right-hand/left-hand plastic end plate (interlinking blocks made from polymer material)		538892 CPX-EPFE-EV
	Inspection cover, transparent		533334 AK-SUB-9/15-B
	Inspection cover		557010 AK-SUB-9/15
	Transparent cover for DIL switch and memory card		548757 CPX-AK-P
	Cover for DIL switch and memory card		548754 CPX-M-AK-M
	Blanking plate for covering the DIL switches of CPX-M-FB20/CPX-M-FB21		572818 CPX-M-FB21-IB-RL
	Cover for RJ45 connection		534496 AK-Rj45
	Cover for RJ45 push-pull connection		548753 CPX-M-AK-C
	Cover cap for sealing unused sockets (10 pieces)	For M8 connections	177672 ISK-M8
		M9	356684 FLANSCHDOSE SER.712
		For M12 connections	165592 ISK-M12

Terminal CPX

Accessories

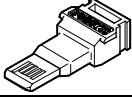
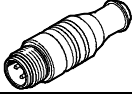
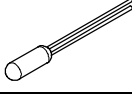
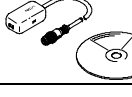
FESTO

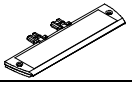
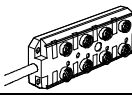
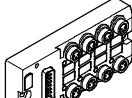
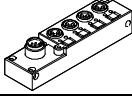
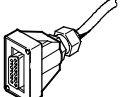
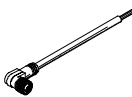
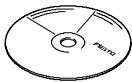
Ordering data – Accessories			
Designation		Part No.	Type
Functional modules			
	Memory card for PROFINET bus node (CPX-FB33, CPX-M-FB34, CPX-M-FB35), 2 MB	568647	CPX-SK-2
	Terminating resistor, M12, B-coded for PROFIBUS	1072128	CACR-S-B12G5-220-PB
	PT1000 temperature sensor for cold junction compensation	553596	CPX-W-PT1000
	Adapter from 5-pin M12 to mini USB socket and controller software	547432	NEFC-M12G5-0.3-U1G5
Inscription labels			
	Inscription labels 6x10, 64 pieces, in frames	18576	IBS-6x10
	Inscription label holder for connection block	536593	CPX-ST-1
Multi-pin plug distributors			
	Open cable end, 11-pin	8x socket M12, 5-pin	177671 MPV-E/A08-M12
	Sub-D plug, 15-pin	8x socket M8, 3-pin	177669 MPV-E/A08-M8
		12x socket M8, 3-pin	177670 MPV-E/A12-M8
	Plug M12, 8-pin	4x socket M8, 3-pin	574586 NEDU-L4R1-M8G3L-M12G8
		6x socket M8, 3-pin	574587 NEDU-L6R1-M8G3L-M12G8
Connecting cable for multi-pin plug distributors			
	Sub-D socket, 15-pin, open cable end, 15-wire	5 m	177673 KMPV-SUB-D-15-5
		10 m	177674 KMPV-SUB-D-15-10
	Angled socket M12, 8-pin, open cable end, 8-wire	Length 2 m	542256 NEBU-M12W8-2-N-LE8
		Length 5 m	542257 NEBU-M12W8-5-N-LE8
		Length 10 m	570007 NEBU-M12W8-10-N-LE8
	Straight socket M12, 8-pin, open cable end, 8-wire	Length 2 m	525616 SIM-M12-8GD-2-PU
		Length 5 m	525618 SIM-M12-8GD-5-PU
		Length 10 m	570008 SIM-M12-8GD-10-PU
Software			
	Programming software	German	537927 P.SW-FST4-CD-DE
		English	537928 P.SW-FST4-CD-EN