

**Motor controllers CMMS-ST, for stepper motors**



# Motor controllers CMMS-ST, for stepper motors



Key features

Comparison of motor controllers				
Motor controller for motor type	CMMD-AS Servo motor	CMMS-AS Servo motor	CMMP-AS Servo motor	CMMS-ST Stepper motor
Positioning records	2x 63	63	255	63
Measuring system	Incremental/absolute		Analogue/incremental/absolute	Incremental
Extended I/O interface	4 working modes		Flexibly configurable	4 working modes
Notification of remaining distance	1 for n		Separately for all positions	1 for n
Torque reduction	No		Separately for all positions	No
Set linking	Linear		With branching	Linear
STO/SS1	To EN 61800-5-2		To EN 61800-5-2	To EN 61800-5-2

## Performance characteristics

Compactness	Motion control
<ul style="list-style-type: none"> <li>• Small dimensions</li> <li>• Full integration of all components for controller and power section, including RS232 and CANopen interface</li> <li>• Integrated brake chopper</li> <li>• Integrated EMC filters</li> </ul>	<ul style="list-style-type: none"> <li>• Automatic actuation for a holding brake</li> <li>• Adheres to the current CE and EN standards without additional external measures (motor cable length of up to 15 m)</li> </ul>
	<ul style="list-style-type: none"> <li>• Can be operated as a torque, speed or position controller</li> <li>• Integrated positioning controller</li> <li>• Time-optimised (trapezoidal) or jerk-free (S-shaped) positioning</li> <li>• Absolute and relative movements</li> <li>• Point-to-point positioning with and without approximate positioning</li> </ul>
	<ul style="list-style-type: none"> <li>• Position synchronisation</li> <li>• Electronic gear unit</li> <li>• 63 position sets</li> <li>• 8 travel profiles</li> <li>• Wide range of homing methods</li> </ul>

## Fieldbus interfaces

Integrated:	Optional:
	 

## Input/output

- Freely programmable I/Os
- High-resolution 12-bit analogue input
- Jog/teach mode
- Simple linking to a higher-level controller via I/O or fieldbus
- Synchronous operation
- Master/slave mode

## Integrated sequence control

- Automatic sequence of position sets without a higher-level controller
- Linear and cyclic position sequences
- Adjustable delay times

## Integrated safety functions

- The motor controller CMMS-ST support "Safe Torque off (STO)" and "Safe Stop 1 (SS1)" functions with protection against unexpected startup in accordance with EN 61800-5-2
- Protection against unexpected start-up
- Two-channel disconnection of the output stage
- Shorter response times in the event of an error

## Interpolating multi-axis movement

- With a suitable controller, the CMMS-ST can perform path movements with interpolation via CANopen. The controller specifies setpoint position values in a fixed time pattern to this end. In between, the servo positioning controller independently interpolates the data values between two data points.

PROFIBUS®, DeviceNet®, CANopen® is a registered trademark of its respective trademark holder in certain countries.

# Motor controllers CMMS-ST, for stepper motors

Key features

## Performance characteristics

### Servo mode

- Encoder option (closed loop), in other words no step losses, following errors are corrected

## Travel program

- Linking of any number of position sets into a travel program
- Step criteria for the travel program possible via digital inputs, for example  
MC – motion complete  
I/O – digital inputs

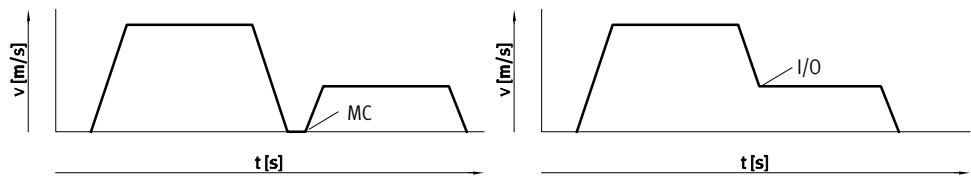

## Library for EPLAN



EPLAN macros for fast and reliable planning of electrical projects in combination with motor controllers,

motors and cables. This enables a high level of planning reliability, standardisation of documentation,

no need to create symbols, graphics and master data.

# Motor controllers CMMS-ST, for stepper motors

Key features



## FCT software – Festo Configuration Tool

Software platform for electric drives from Festo

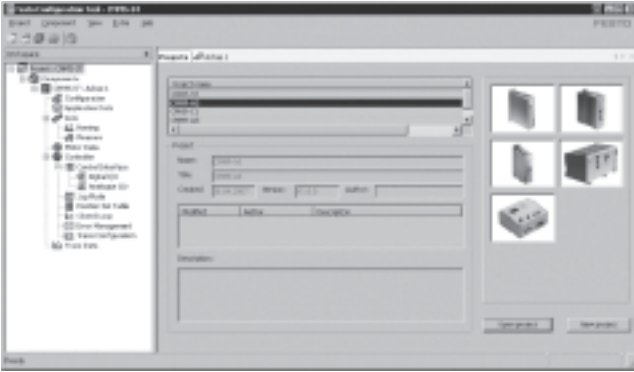

- All drives in a system can be managed and archived in a common project
- Project and data management for all supported device types
- Simple to use thanks to graphically-supported parameter entry
- Universal mode of operation for all drives
- Working offline at your desk or online at the machine

## FHPP – Festo Handling and Positioning Profile

Optimised data profile

Festo has developed an optimised data profile, the “Festo Handling and Positioning Profile (FHPP)”, that is tailored to handling and positioning applications.

The FHPP data profile permits the actuation of Festo motor controllers, using a fieldbus interface, via standardised control and status bytes.

The following are defined, among others:

- Operating modes
- I/O data structure
- Parameter objects
- Sequence control

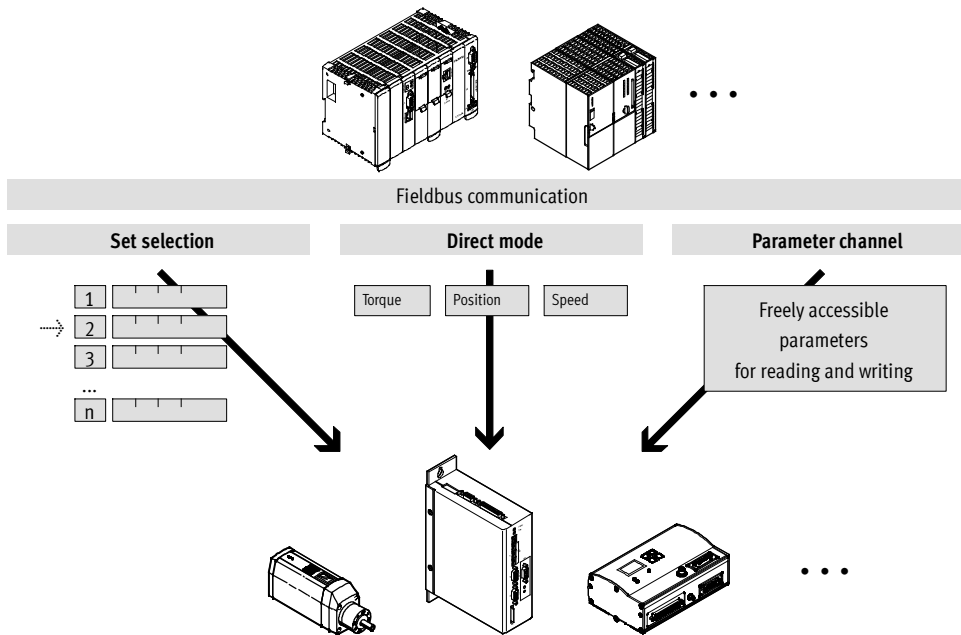

# Motor controllers CMMS-ST, for stepper motors

Type codes

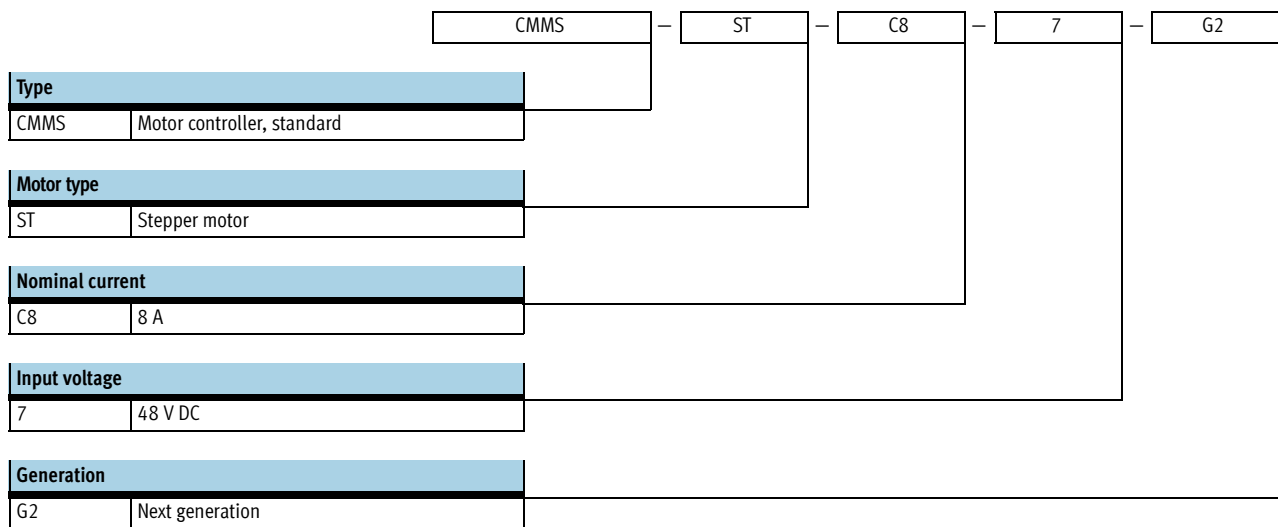

# Motor controllers CMMS-ST, for stepper motors

Technical data

Fieldbus interfaces

CANopen

PROFIBUS DP

DeviceNet



General technical data	
Type of mounting	Screwed to a mounting plate
Operating mode	PWM MOSFET power amplifier
Motor actuation	Sinusoidal current impressing
Cycle rate [kHz]	Constant 50
Rotary position generator	Encoder
Display	7-segment display
Parameterisation interface	RS232 (9,600 ... 115,000 bits/s)
Encoder interface input	As speed/position specification for the slave drive in synchronous mode RS422
Encoder interface output	Setpoint specification for downstream slave drive
Brake resistor, integrated [ $\Omega$ ]	17
Pulse power of braking resistor [kVA]	0.5
Bus terminating resistor	Integrated
Impedance of setpoint input [k $\Omega$ ]	20
Number of analogue outputs	1
Operating range of analogue outputs [V]	$\pm 10$
Characteristics of digital logic outputs	Freely configurable in some cases
Number of analogue inputs	1
Operating range of analogue inputs [V]	$\pm 10$
Mains filter	Integrated
Product weight [g]	900

Technical data – Fieldbus interface				
Interfaces	I/O	CANopen	PROFIBUS DP	DeviceNet
Communication profile	–	DS301, FHPP	DP-V0 / FHPP	FHPP
	–	DS301, DSP402	–	
Max. fieldbus transmission rate [Mbit/s]	–	1	12	0.5
Interface	Integrated	■	■	–
	Optional	–	–	■ → 10

# Motor controllers CMMS-ST, for stepper motors

Technical data

Function blocks for PLC programming				
Programming software	Controller manufacturer	Interfaces		
		CANopen	PROFIBUS DP	DeviceNet
CoDeSys	Festo			
	Beckhoff	■	■	■
	Other manufacturers			
RSLogix5000	Rockwell Automation	-	-	■
Step 7	Siemens	-	■	-

Electrical data		
General		
Nominal current setting		Via software
Max. peak current duration	[s]	2
Max. intermediate circuit voltage	[V DC]	48
Load supply		
Nominal voltage	[V DC]	24 ... 48
Nominal current	[A]	8
Peak current	[A]	12
Logic supply		
Nominal voltage	[V DC]	24 ±20%
Nominal current	[A]	0.3
Max. current of digital logic outputs	[mA]	100

Operating and environmental conditions	
Digital logic outputs	Not electrically separated
Logic inputs	Electrically separated
Protection class	IP20
Protective function	I <sup>2</sup> t monitoring
	Current monitoring
	Voltage failure detection
	Following error monitoring
	Temperature monitoring
Ambient temperature	[°C] 0 ... +50
Storage temperature	[°C] -25 ... +70
Relative humidity	[%] 0 ... 90 (non-condensing)
CE mark (see declaration of conformity)	To EU EMC Directive <sup>1)</sup>
	To EU Machinery Directive
Certification	c UL us - Listed (OL)
	C-Tick
	BIA
Certificate issuing authority	BG MFS 09031
Safety function	Safe Torque off (STO)
Safety Integrity Level (SIL)	Safe Torque off (STO) / SIL 2
Performance Level (PL)	Safe Torque off (STO) / category 3, performance level d
Note on materials	RoHS-compliant

1) For information about the applicability of the component see the manufacturer's EC declaration of conformity at: [www.festo.com](http://www.festo.com) → Support → User documentation.  
If the component is subject to restrictions on usage in residential, office or commercial environments or small businesses, further measures to reduce the emitted interference may be necessary.

# Motor controllers CMMS-ST, for stepper motors

Technical data

## View of motor controller

From the front

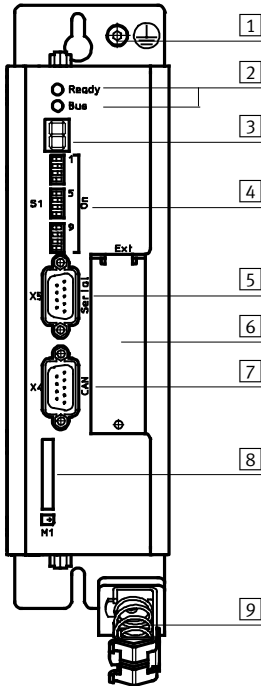

- 1 Earthing
- 2 Ready/bus LED
- 3 Status display
- 4 Fieldbus settings and boot loader
- 5 Interface: RS232/RS485
- 6 Technology module slot
- 7 Interface: CAN bus
- 8 SD memory card
- 9 Screened connection

From above

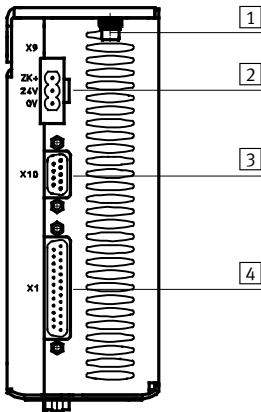

- 1 Earthing screw
- 2 Power supply
- 3 Incremental encoder interface (bidirectional)
- 4 I/O interface

From underneath

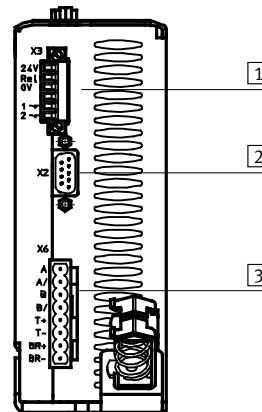

- 1 Safe stop
- 2 Increment encoder input for motor
- 3 Motor connection



# Motor controllers CMMS-ST, for stepper motors

Technical data

## Installation clearance for motor controller

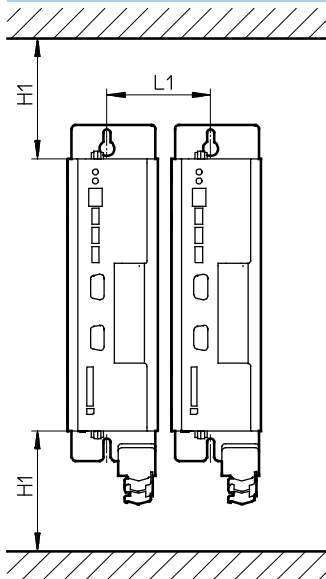

H1	L1
100	69

## Dimensions

Download CAD data → [www.festo.com](http://www.festo.com)

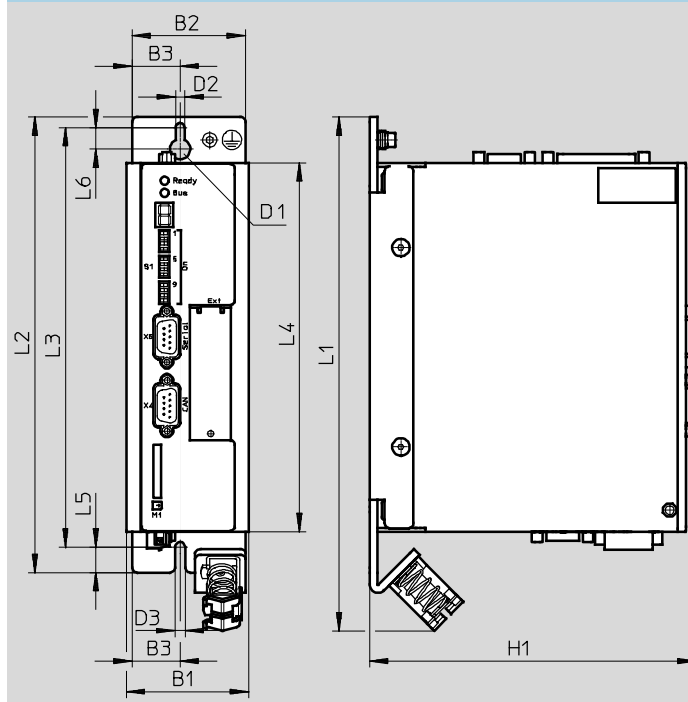

Type	B1	B2	B3	D1	D2	D3	H1
CMMS-ST	60	56	24	10	4.5	5	161

Type	L1	L2	L3	L4	L5	L6
CMMS-ST	252	224	206.25	181	12.5	15.75

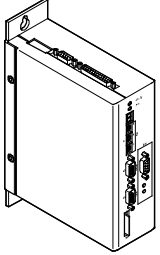

# Motor controllers CMMS-ST, for stepper motors

Technical data and accessories

Ordering data			
	Brief description	Part No.	Type
	The plug range NEKM (→ 10) and the operating package (→ 11) are included in the scope of delivery	572211	CMMS-ST-C8-7-G2

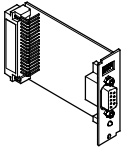
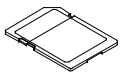
## Accessories

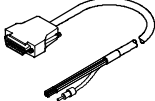
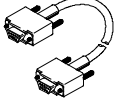
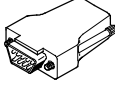
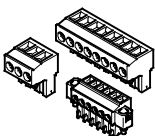
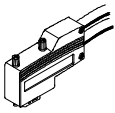
Ordering data – Plug-in cards			
	Brief description	Part No.	Type
	Interface, for PROFIBUS interface	547450	CAMC-PB
	Interface, for DeviceNet interface	547451	CAMC-DN
	Memory card, for data backup and firmware downloads	1436343	CAMC-M-S-F10-V1

Ordering data – Cables and plugs				
	Brief description	Cable length [m]	Part No.	Type
	Control cable, for I/O interface to any controller	2.5	552254	NEBC-S1G25-K-2.5N-LE26
	Programming cable	1.5	160786	PS1-ZK11-NULLMODEM-1,5M
	Encoder plug, for incremental encoder interface	–	564264	NECC-A-S-S1G9-C2M
	The plug range is included in the scope of delivery	–	547452	NEKM-C-1
	Plug for PROFIBUS interface	–	533780	FBS-SUB-9-WS-PB-K
	Plug for CANopen interface	–	533783	FBS-SUB-9-WS-CO-K
	Plug for DeviceNet interface	–	525635	FBSD-KL-2X5POL

# Motor controllers CMMS-ST, for stepper motors

Accessories

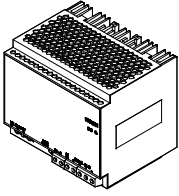
Ordering data – Power supply units						
	Brief description	Input voltage range [V AC]	Nominal output voltage [V DC]	Nominal output current [A]	Part No.	Type
	Power supply for motor controller	100 ... 240	24	5	547867	SVG-1/230VAC-24VDC-5A
				10	547868	SVG-1/230VAC-24VDC-10A
		400 ... 500	48	5	542403	SVG-1/230VAC-48VDC-5A
				10	542404	SVG-1/230VAC-48VDC-10A
				20	542405	SVG-3/400VAC-48VDC-20A

 - Note

If a common power supply unit is used to supply the power section and the control section, the voltage tolerances for the supply to the control section cannot be maintained at high braking power. This can result in damage to the control section. Always use separate power supply units to supply the power section and the control section.

Ordering data – Software and documentation			
	Brief description	Part No.	Type
	Operating package contains: – CD-ROM – with user documentation for CMMS-ST, in de, en, es, fr, it, sv – with FCT (Festo Configuration Tool) configuration software, in de, en – Brief description This package is included in the scope of delivery	573960	GSIB-CMMS-ST-G2-ML

# Motor controllers CMMS-ST, for stepper motors

Accessories

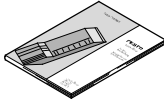
Ordering data – Documentation <sup>1)</sup>					
	Language	Part No.	Type		
		for motor controller		Part No.	Type
				Festo Handling and Positioning Profile (FHPP) for the motor controller family CMM...	
	DE	573124	P.BE-CMMS-ST-G2-HW-DE	555695	P.BE-CMM-FHPP-SW-DE
	EN	573125	P.BE-CMMS-ST-G2-HW-EN	555696	P.BE-CMM-FHPP-SW-EN
	ES	573126	P.BE-CMMS-ST-G2-HW-ES	555697	P.BE-CMM-FHPP-SW-ES
	FR	573127	P.BE-CMMS-ST-G2-HW-FR	555698	P.BE-CMM-FHPP-SW-FR
	IT	573128	P.BE-CMMS-ST-G2-HW-IT	555699	P.BE-CMM-FHPP-SW-IT
	SV	573129	P.BE-CMMS-ST-G2-HW-SV	555700	P.BE-CMM-FHPP-SW-SV
		for CANopen interface		for PROFIBUS interface	
DE	554351	P.BE-CMMS-FHPP-CO-SW-DE		554345	P.BE-CMMS-FHPP-PB-SW-DE
EN	554352	P.BE-CMMS-FHPP-CO-SW-EN		554346	P.BE-CMMS-FHPP-PB-SW-EN
ES	554353	P.BE-CMMS-FHPP-CO-SW-ES		554347	P.BE-CMMS-FHPP-PB-SW-ES
FR	554354	P.BE-CMMS-FHPP-CO-SW-FR		554348	P.BE-CMMS-FHPP-PB-SW-FR
IT	554355	P.BE-CMMS-FHPP-CO-SW-IT		554349	P.BE-CMMS-FHPP-PB-SW-IT
SV	554356	P.BE-CMMS-FHPP-CO-SW-SV		554350	P.BE-CMMS-FHPP-PB-SW-SV
		for DeviceNet interface			
DE	554357	P.BE-CMMS-FHPP-DN-SW-DE			
EN	554358	P.BE-CMMS-FHPP-DN-SW-EN			
ES	554359	P.BE-CMMS-FHPP-DN-SW-ES			
FR	554360	P.BE-CMMS-FHPP-DN-SW-FR			
IT	554361	P.BE-CMMS-FHPP-DN-SW-IT			
SV	554362	P.BE-CMMS-FHPP-DN-SW-SV			

1) User documentation in paper form is not included in the scope of delivery