

# Motor controllers CMMS-AS, for servo motors



# Motor controllers CMMS-AS, for servo motors

Key features

Comparison of motor controllers				
Motor controller for motor type	CMMD-AS Servo motor	CMMS-AS Servo motor	CMMP-AS Servo motor	CMMS-ST Stepper motor
Positioning records	2x 63	63	255	63
Measuring system	Incremental/absolute		Analogue/incremental/absolute	Incremental
Extended I/O interface	4 working modes		Flexibly configurable	4 working modes
Notification of remaining distance	1 for n		Separately for all positions	1 for n
Torque reduction	No		Separately for all positions	No
Set linking	Linear		With branching	Linear
STO/SS1	To EN 61800-5-2		To EN 61800-5-2	To EN 61800-5-2

## Performance characteristics

Compactness	Motion control
<ul style="list-style-type: none"> <li>• Small dimensions</li> <li>• Full integration of all components for controller and power section, including RS232 and CANopen interface</li> <li>• Integrated brake chopper</li> <li>• Integrated EMC filters</li> </ul>	<ul style="list-style-type: none"> <li>• Automatic actuation for a holding brake</li> <li>• Adheres to the current CE and EN standards without additional external measures (motor cable length of up to 15 m)</li> </ul>
	<ul style="list-style-type: none"> <li>• Digital absolute shaft encoder in single-turn and multi-turn versions</li> <li>• Can be operated as a torque, speed or position controller</li> <li>• Integrated positioning controller</li> <li>• Time-optimised (trapezoidal) or jerk-free (S-shaped) positioning</li> <li>• Absolute and relative movements</li> </ul>
	<ul style="list-style-type: none"> <li>• Point-to-point positioning with and without approximate positioning</li> <li>• Position synchronisation</li> <li>• Electronic gear unit</li> <li>• 63 position sets</li> <li>• 8 travel profiles</li> <li>• Wide range of homing methods</li> </ul>

## Fieldbus interfaces

Integrated:



Optional:



## Input/output

- Freely programmable I/Os
- High-resolution 12-bit analogue input
- Jog/teach mode
- Simple linking to a higher-level controller via I/O or fieldbus
- Synchronous operation
- Master/slave mode

## Integrated sequence control

- Automatic sequence of position sets without a higher-level controller
- Linear and cyclic position sequences
- Adjustable delay times

# Motor controllers CMMS-AS, for servo motors

Key features

## Performance characteristics

### Integrated safety functions

- The motor controller CMMS-AS support "Safe Torque off (STO)" and, by providing a reliable time delay, also supports "Safe Stop 1 (SS1)" functions with protection against unexpected startup in accordance with EN 61800-5-2
- Protection against unexpected start-up

- Two-channel disconnection of the output stage
- Less external circuitry
- Shorter response times in the event of an error
- Faster restart, intermediate circuit remains charged

### Interpolating multi-axis movement

- With a suitable controller, the CMMS-AS can perform path movements with interpolation via CANopen. The controller specifies setpoint position values in a fixed

time pattern to this end. In between, the servo positioning controller independently interpolates the data values between two data points.

## Travel program

- Linking of any number of position sets into a travel program
- Further switching conditions for the travel program possible via digital inputs, for example  
MC – motion complete  
I/O – digital inputs

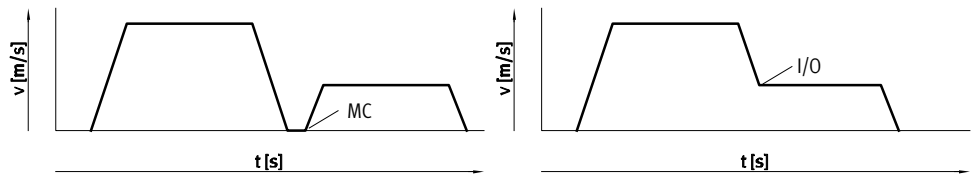

## Library for EPLAN



EPLAN macros for fast and reliable planning of electrical projects in combination with motor controllers,

motors and cables. This enables a high level of planning reliability, standardisation of documentation,

no need to create symbols, graphics and master data.

# Motor controllers CMMS-AS, for servo motors

Key features



## FCT software – Festo Configuration Tool

Software platform for electric drives from Festo

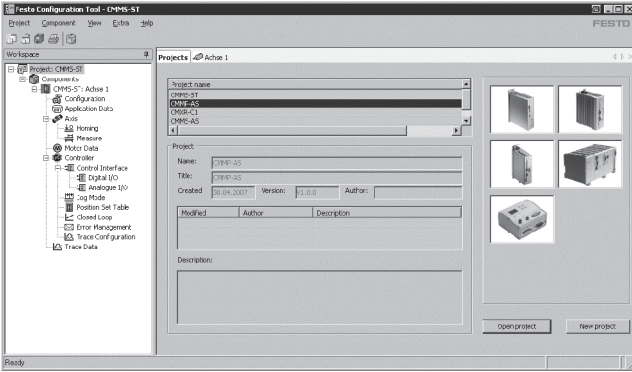

- All drives in a system can be managed and archived in a common project
- Project and data management for all supported device types
- Simple to use thanks to graphically-supported parameter entry
- Universal mode of operation for all drives
- Working offline at your desk or online at the machine

## FHPP – Festo Handling and Positioning Profile

Optimised data profile

Festo has developed an optimised data profile, the “Festo Handling and Positioning Profile (FHPP)”, that is tailored to handling and positioning applications.

The FHPP data profile permits the actuation of Festo motor controllers, using a fieldbus interface, via standardised control and status bytes.

The following are defined, among others:

- Operating modes
- I/O data structure
- Parameter objects
- Sequence control

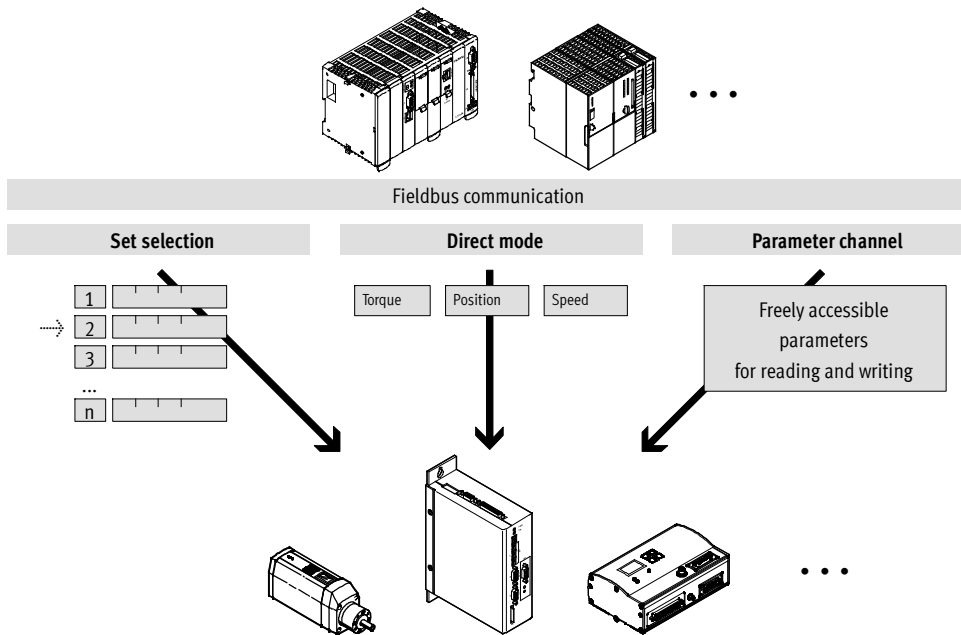

# Motor controllers CMMS-AS, for servo motors

Type codes

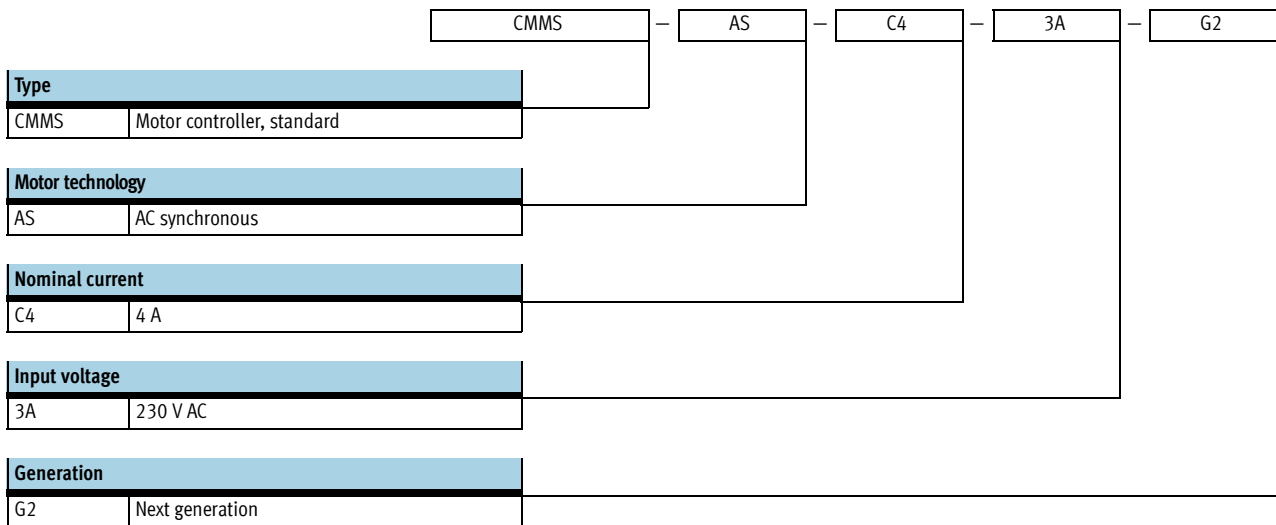

# Motor controllers CMMS-AS, for servo motors

FESTO

Technical data

Fieldbus interfaces



General technical data		
Type of mounting		Screwed to a mounting plate
Display		7-segment display
Parameterisation interface		RS232 (9,600 ... 115,000 bits/s)
Encoder interface input		Setpoint position value as encoder signal EnDat V2.1 serial / V2.2
Encoder interface output		Actual value feedback via encoder signals in speed control mode Setpoint specification for downstream slave drive Resolution 4,096 ppr
Braking resistor, integrated	[Ω]	230
Pulse power of braking resistor	[kVA]	0.7
Braking resistor, external	[Ω]	≥ 100
Impedance of setpoint input	[kΩ]	20
Number of analogue outputs		1
Operating range of analogue outputs	[V]	0 ... 10
Resolution of analogue outputs	[Bit]	8
Characteristics of analogue outputs		Short circuit-proof
Number of analogue inputs		1
Operating range of analogue inputs	[V]	±10
Characteristics of analogue inputs		Differential inputs Configurable for speed Configurable for torque
Mains filter		Integrated
Max. length of motor cable	[m]	15 (without external mains filter)
Product weight	[g]	1,400

Technical data – Fieldbus interface					
Interfaces	I/O	CANopen	Profibus DP	DeviceNet	
Number of digital logic outputs		5			
Characteristics of digital logic outputs		Freely configurable in some cases			
Number of digital logic inputs		14			
Operating range of logic inputs	[V]	12 ... 30			
Characteristics of logic inputs		Freely configurable			
Process coupling		For 63 position sets	For 63 position sets		
Communication profile		–	DS301, FHPP	DP-V0 / FHPP	FHPP
		–	DS301, DSP402	–	–
Max. fieldbus transmission rate	[Mbit/s]	–	1	12	0.5
Interface	Integrated	■	■	–	–
	Optional	–	–	■	■
				→ 10	→ 10

# Motor controllers CMMS-AS, for servo motors

Technical data

Function blocks for PLC programming				
Programming software	Controller manufacturer	Interfaces		
		CANopen	Profibus DP	DeviceNet
CoDeSys	Festo			
	Beckhoff	■	■	■
	Other manufacturers			
RSLogix5000	Rockwell Automation	-	-	■
Step 7	Siemens	-	■	-

Electrical data		
Output connection data		
Output voltage range	[V AC]	0 ... 210
Nominal output current	[A]	4
Peak current	[A]	10
Max. peak current duration	[s]	2
Max. intermediate circuit voltage	[V DC]	320
Output frequency	[Hz]	0 ... 1,000
Load supply		
Nominal voltage phases		1
Input voltage range	[V AC]	95 ... 255
Max. nominal input current	[A]	4
Rated output	[VA]	600
Peak output	[VA]	1,200
Mains frequency	[Hz]	50 ... 60
Logic supply		
Nominal voltage	[V DC]	24 ±20%
Nominal current	[A]	0.35
Max. current (incl. holding brake)	[A]	1.7
Max. current of digital logic outputs	[mA]	100

Operating and environmental conditions	
Digital logic outputs	Not electrically isolated
Logic inputs	Galvanically connected to logic potential
Protection class	IP20
Protective function	I <sup>2</sup> t monitoring
	Intermediate circuit over-/undervoltage
	Short circuit in output stage
	Standstill monitoring
	Temperature monitoring
Ambient temperature	[°C] 0 ... +50
Storage temperature	[°C] -25 ... +70
Relative air humidity	[%] 0 ... 90 (non-condensing)
CE mark (see declaration of conformity)	To EU Low Voltage Directive
	To EU EMC Directive <sup>1)</sup>
	To EU Machinery Directive
Certification	c UL - Recognized (OL)
	UL - Listed (OL)
	C-Tick
	BIA
Certificate issuing authority	BG MFS 09030
Safety function	Safe Torque off (STO)
Safety Integrity Level (SIL)	Safe Torque off (STO) / SIL 2
Performance Level (PL)	Safe Torque off (STO) / category 3, performance level d
Note on materials	RoHS-compliant

1) For information about the applicability of the component see the manufacturer's EC declaration of conformity at: [www.festo.com](http://www.festo.com) → Support → User documentation.  
If the component is subject to restrictions on usage in residential, office or commercial environments or small businesses, further measures to reduce the emitted interference may be necessary.

CoDeSys®, Rockwell Automation® is a registered trademark of its respective trademark holder in certain countries.

# Motor controllers CMMS-AS, for servo motors

Technical data

## View of motor controller

From the front

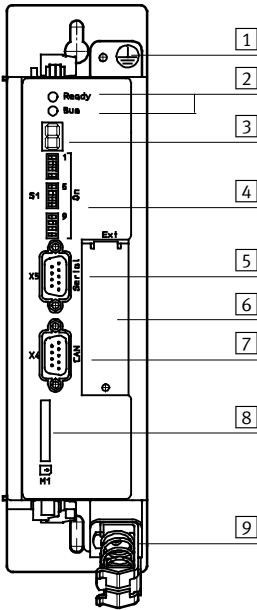

- 1 Earthing
- 2 Ready/bus LED
- 3 Status display
- 4 Fieldbus settings and boot loader
- 5 Interface: RS232/RS485
- 6 Technology module (optional)
- 7 Interface: CAN bus
- 8 SD memory card
- 9 Screened connection

From above

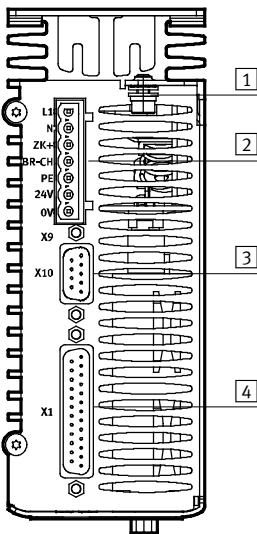

- 1 Earthing screw
- 2 Power supply
- 3 Incremental encoder interface (bidirectional)
- 4 I/O interface

From underneath

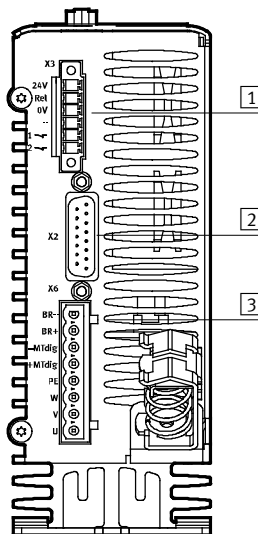

- 1 Safe stop
- 2 Encoder connection
- 3 Motor connection



# Motor controllers CMMS-AS, for servo motors

Technical data

## Installation clearance for motor controller

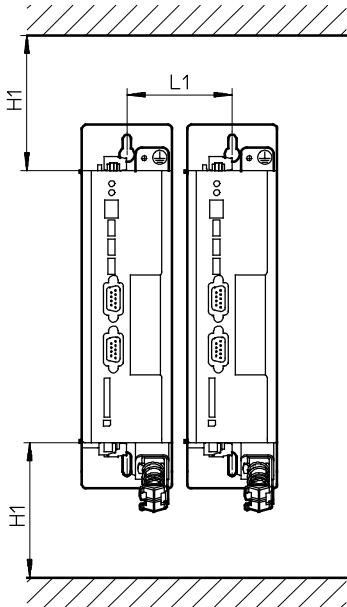

H1	L1
100	70

## Dimensions

Download CAD data → [www.festo.com](http://www.festo.com)

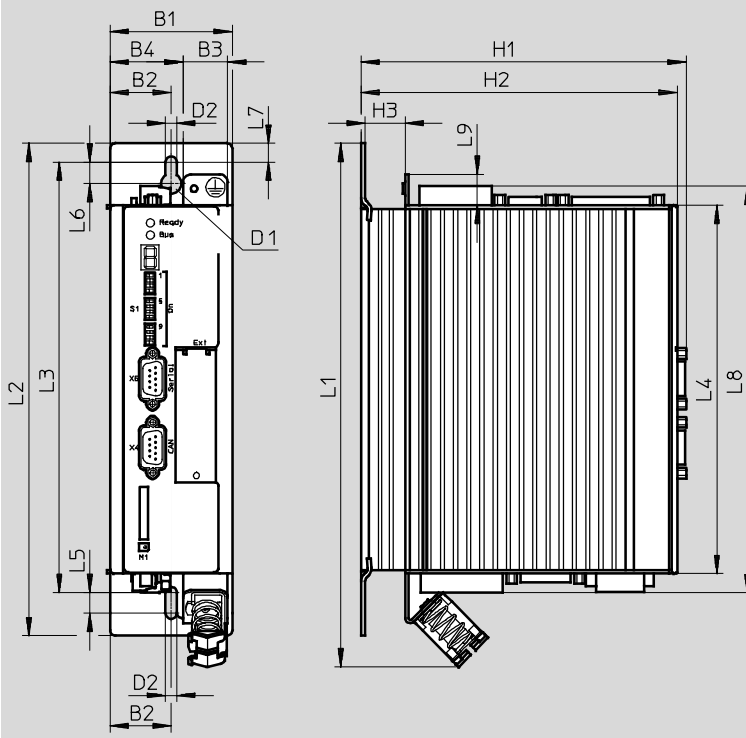

Type	B1	B2	B3	B4	D1	D2	H1	H2	H3
CMMS-AS	60	30	22	35.8	10	5.5	160	155.5	19.7

Type	L1	L2	L3	L4	L5	L6	L7	L8	L9
CMMS-AS	257.6	242.1	211.9	181	10	10.5	9.25	200	15.3

## Motor controllers CMMS-AS, for servo motors

FESTO

Technical data and accessories

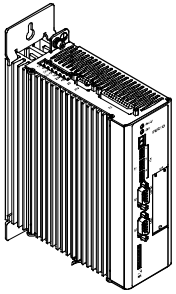
Ordering data			
	Brief description	Part No.	Type
	The plug assortment NEKM (→ 11) and the operator package (→ 11) are included in the scope of delivery.	<b>572986</b>	<b>CMMS-AS-C4-3A-G2</b>

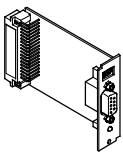
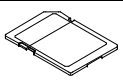

### Accessories

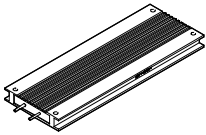
Ordering data – Plug-in cards			
	Brief description	Part No.	Type
	Interface, for Profibus interface	<b>547450</b>	<b>CAMC-PB</b>
	Interface, for DeviceNet interface	<b>547451</b>	<b>CAMC-DN</b>
	Memory card, for data backup and firmware downloads	<b>1436343</b>	<b>CAMC-M-S-F10-V1</b>

Ordering data – Braking resistances				
	Resistance value [Ω]	Nominal power [W]	Part No.	Type
	100	500	<b>1336615</b>	<b>CACR-LE2-100-W500</b>

# Motor controllers CMMS-AS, for servo motors

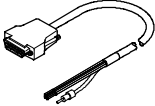
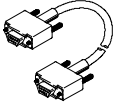
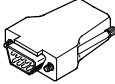
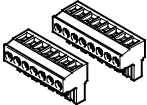
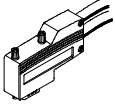
Accessories

Ordering data – Cables and plugs				
	Brief description	Cable length [m]	Part No.	Type
	Control cable, for I/O interface to any controller	2.5	552254	NEBC-S1G25-K-2.5N-LE26
	Programming cable	1.5	160786	PS1-ZK11-NULLMODEM-1,5M
	Encoder plug, for incremental encoder interface	–	564264	NECC-A-S-S1G9-C2M
	Plug assortment, comprising plug for power supply and plug for motor connection. The plug assortment is included in the scope of delivery	–	560504	NEKM-C-4
	Plug for Profibus interface	–	533780	FBS-SUB-9-WS-PB-K
	Plug for CANopen interface	–	533783	FBS-SUB-9-WS-CO-K
	Plug for DeviceNet interface	–	525635	FBSD-KL-2X5POL

Ordering data – Software and documentation				
	Brief description	Part No.	Type	
	Operator package contains: – CD-ROM – with manual for CMMS-AS, in de, en, es, fr, it, sv – with FCT (Festo Configuration Tool) configuration software, in de, en – Brief description This package is included in the scope of delivery	573740	GSIB-CMMS-AS-G2-ML	

# Motor controllers CMMS-AS, for servo motors

Accessories

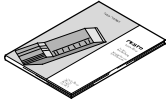
Ordering data – Documentation <sup>1)</sup>						
	Language	Part No.	Type			
		for motor controller		Part No.	Type	
				Festo Handling and Positioning Profile (FHPP) for the motor controller family CMM...		
	DE	564227	P.BE-CMMS-AS-3A-HW-DE	555695	P.BE-CMM-FHPP-SW-DE	
	EN	564228	P.BE-CMMS-AS-3A-HW-EN	555696	P.BE-CMM-FHPP-SW-EN	
	ES	564229	P.BE-CMMS-AS-3A-HW-ES	555697	P.BE-CMM-FHPP-SW-ES	
	FR	564230	P.BE-CMMS-AS-3A-HW-FR	555698	P.BE-CMM-FHPP-SW-FR	
	IT	564231	P.BE-CMMS-AS-3A-HW-IT	555699	P.BE-CMM-FHPP-SW-IT	
	SV	564232	P.BE-CMMS-AS-3A-HW-SV	555700	P.BE-CMM-FHPP-SW-SV	
			for CANopen interface		for Profibus interface	
	DE	554351	P.BE-CMMS-FHPP-CO-SW-DE	554345	P.BE-CMMS-FHPP-PB-SW-DE	
	EN	554352	P.BE-CMMS-FHPP-CO-SW-EN	554346	P.BE-CMMS-FHPP-PB-SW-EN	
	ES	554353	P.BE-CMMS-FHPP-CO-SW-ES	554347	P.BE-CMMS-FHPP-PB-SW-ES	
	FR	554354	P.BE-CMMS-FHPP-CO-SW-FR	554348	P.BE-CMMS-FHPP-PB-SW-FR	
	IT	554355	P.BE-CMMS-FHPP-CO-SW-IT	554349	P.BE-CMMS-FHPP-PB-SW-IT	
	SV	554356	P.BE-CMMS-FHPP-CO-SW-SV	554350	P.BE-CMMS-FHPP-PB-SW-SV	
			for DeviceNet interface			
	DE	554357	P.BE-CMMS-FHPP-DN-SW-DE			
	EN	554358	P.BE-CMMS-FHPP-DN-SW-EN			
	ES	554359	P.BE-CMMS-FHPP-DN-SW-ES			
	FR	554360	P.BE-CMMS-FHPP-DN-SW-FR			
IT	554361	P.BE-CMMS-FHPP-DN-SW-IT				
SV	554362	P.BE-CMMS-FHPP-DN-SW-SV				

1) Manual in paper form is not included in the scope of delivery