

AS-interface® components

**FESTO**



# AS-interface® components

Overview of AS-interface

FESTO

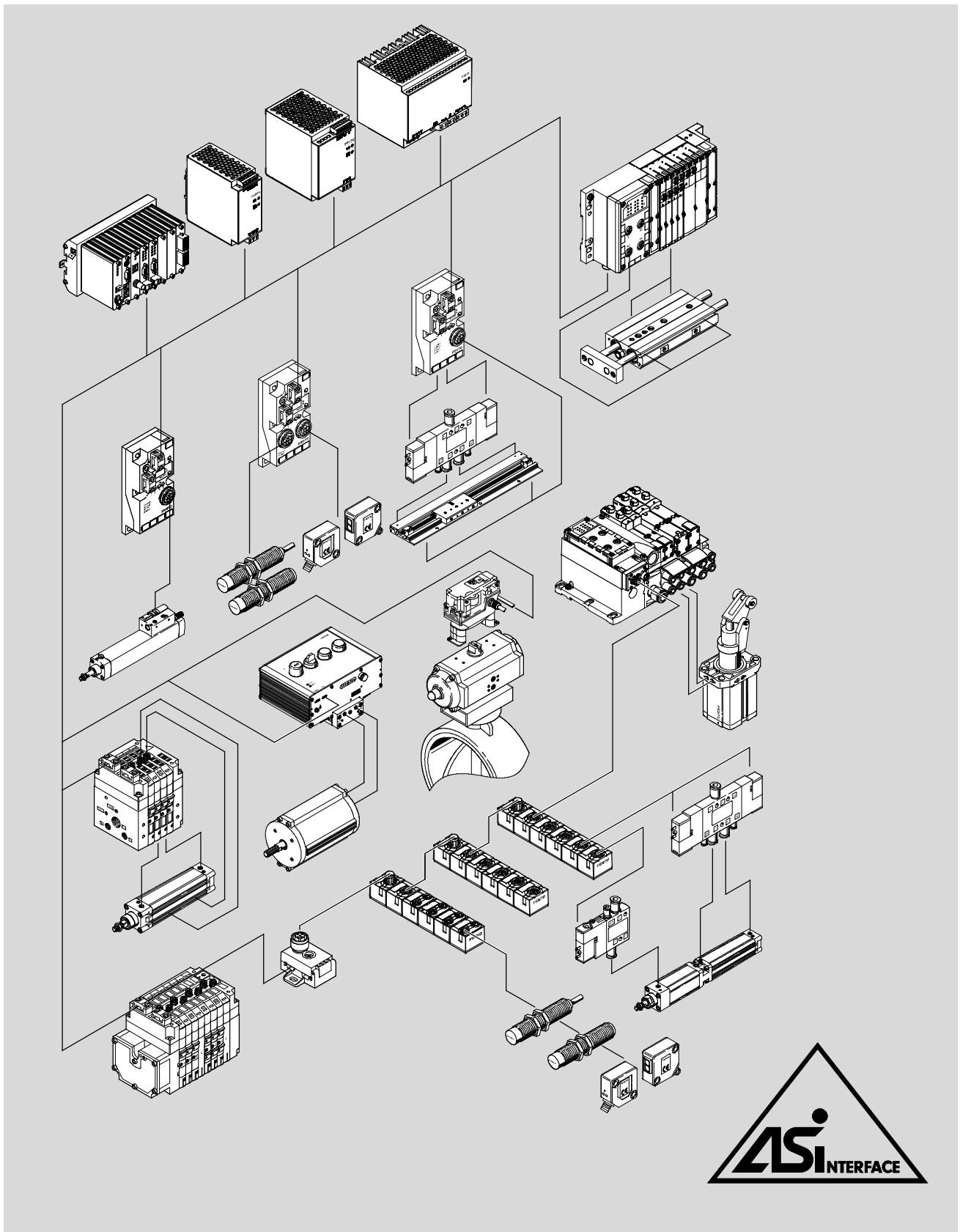

# AS-interface® components

Overview of AS-interface



## Basic principles and features of the bus system

### Introduction

AS-interface is a non-proprietary, open installation system with a large and growing share of the market at the lowest level of the decentralised production and process automation hierarchy.

The non-proprietary and open characteristics of the system are guaranteed by the European standard EN 50295 and the international

standard IEC 62026-2. Certified products bear the logo of the AS-International Association.

The AS-International Association and its affiliated organisations represent the interests of all manufacturers with an interest in the AS-interface.

### Design

The AS-interface system permits the transfer of power and data using a single cable. The advanced technology used to connect stations to the yellow cable and the low connection costs mean that even stations with a small number of inputs and outputs (max. 8 inputs and 8 outputs per valve terminal with two chips) can be networked. Reductions in installation costs of between 26% and 40% have been demonstrated depending on the system type. This solution is an ideal low-cost option for connecting individual or

small groups of actuators, valves and sensors to a master controller. New developments as per Specification V2.1 published at the start of 2000 such as the parameterisable profile 7.4 or the AS-interface Safety at Work concept opened the way for new areas of application and facilitated considerably more efficient installation and networking concepts in many instances. Specification V3.0 published in 2005 represents another giant leap forward, facilitating convenient activation of

analogue I/O, complex slaves or serial text and data transfer, for example.

- Slaves as per Specifications V2.0 and V2.1 will also run under V3.0 – the system is fully downwards compatible. Benefits of AS-interface Specification V3.0:
- All of the benefits of the simple installation system since Specification V2.0 are retained
- Up to 400% more I/Os per master
- Improved peripheral error diagnostics
- More functions within Specifications V2.1 and V3.0, e.g. easy integration of complex 16-bit slaves,

fast analogue modules, DTM integration, asynchronous serial protocol, safety slaves

- Slave profiles for specific functions as well as interchangeability. Mix of different vendors and products, e.g. for parameters or communication services

AS-interface with A/B mode gives you 100% more. In A/B mode, each slave address is used twice. An output bit is used for A/B address differentiation (see table for case distinctions). The cycle time for pneumatic chains is generally more than adequate.

Specification Version	Inputs	Outputs	Bus cycle (ms)	No. of slaves, digital	No. of slaves, analogue	Σ I/O
2.0	4/4	4	5	31	31	248
2.1	4	3	10	62	31	434
3.0	4/8	4/8	20	62	62	992

### Master-slave principle

- Non-proprietary
- No restrictions in terms of cable layout and/or topology
- Data and power via a single two-wire cable
- Immune to interference
- Medium: unshielded cable 2x 1.5 mm<sup>2</sup>
- With 31 slaves, max. 4 inputs and 4 outputs per slave
- Data and power supply for up to 8 outputs per AS-interface string

- With 62 slaves, max. 4 inputs and 3 outputs per slave (A/B mode as per Specification V2.1)
- Modules for control cabinets (IP20) and harsh industrial environments (IP65, IP67)
- With 31 slaves, 4 analogue inputs or outputs per slave
- Profile 7.3: analogue values (16 bits) per slave (as per Specification V2.1)

- Profile 7.4: parameterisable communication profile, e.g. 16x 16 bits per slave (as per Specification V2.1)
- Profile 7.A.7 allows 4 bits for digital inputs and 4 bits for digital outputs on just one A/B slave. The 4 outputs are transmitted in two A/B bus cycles of 2 bits each. This extends the cycle time (in the worst-case scenario) to 20 ms.

- Insulation displacement technology
- Cable length 100 m, can be extended to up to 200 m through the use of an extension plug and to up to 500 m through the use of repeaters, etc.
- Highly effective error control
- Simple commissioning
- Electronic address selection via the bus connection



Note

Slaves to Specification V3.0 require a master to Specification V3.0.

# AS-interface® components

Overview of AS-interface

FESTO

## Basic features

### Simple connection technology

- One cable for power and data
- Cable profile prevents polarity reversal
- Error control means there is no need for screening
- Insulation displacement connection technology guarantees Festo plug and work
- Alternative bus connection technology M12, 4-pin (standardised)

### Ideal for pneumatic applications

Local control of small groups of actuators or individual distributed actuators covering an extensive area with

- short tubing lengths,
- high cycle rates,
- low air consumption.

Installation and communication are carried out via AS-interface components.

### A powerful system component

AS-interface is clearly subordinate to the fieldbuses already in use and is therefore less a competing product and more a technically necessary and economically advisable add-on.

### Everything from a single source

Festo is your single source for the AS-interface. This means

- one contact person,
- competent solutions from the market leader,
- convenient ordering system,
- complete delivery service,
- co-ordinated solutions for motion and control,
- worldwide service round the clock.

## Optimised cycle rates

Decentralised solutions at the AS-interface permit optimised electro-pneumatic control loop systems: valve response times and optimum pairings of cylinder diameter and stroke save up to

- 20% cycle time with standard components
- 30% cycle time with fast switching valves
- 40% installation costs
- 50% air consumption/flow rate

## Product range overview

### Drives

Actuators for the process industry  
Quarter turn actuators DRD (Copar)

Local controllers for process actuators and outdoor use

### Gateways

AS-interface gateways CESA as master within the AS-interface network and slave within a fieldbus network.

- PROFIBUS
- CANopen

### Valves

• A universal solution from the individual valve interface up to the compact solution with 8 valves

• Integrated inputs on individual valve interfaces and valve terminals CPV, MPA-S and VTSA/VTSA-F

• More inputs thanks to 4-fold and 8-fold input modules

• On request:  
Application-specific valves and integration solutions

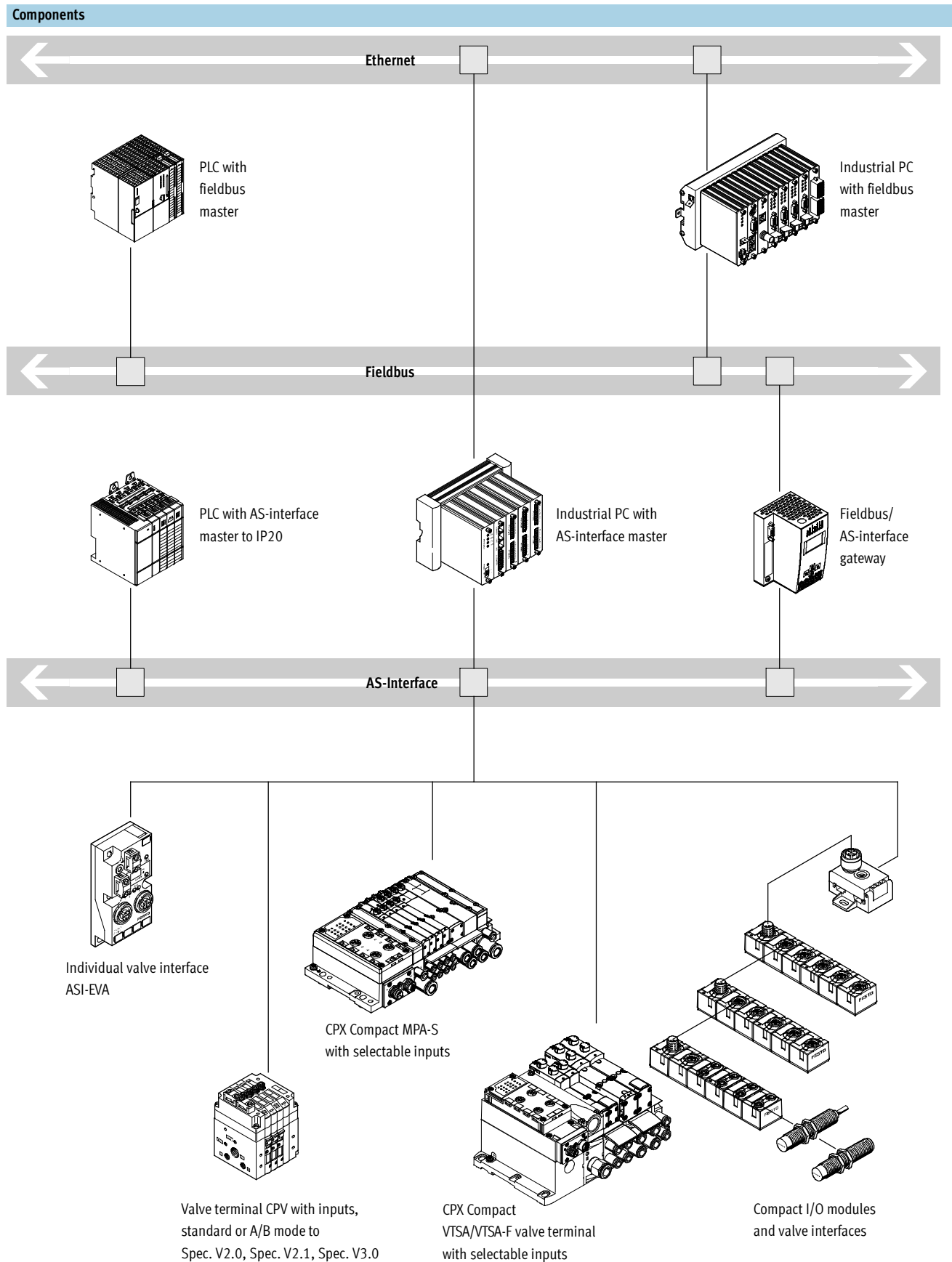

## Application examples

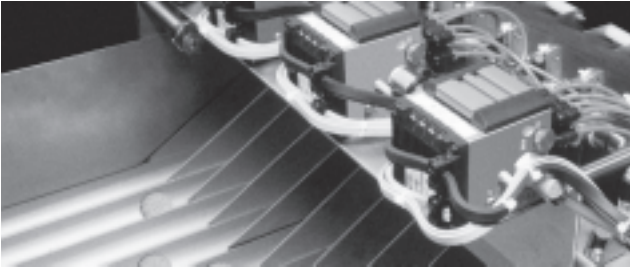

### Sorting

Valve terminals MPA-S, VTSA/VTSA-F and CPV:  
Compact Performance is synonymous with high performance and low

weight. Mounting close to the drives simplifies installation, saves compressed air and increases the cycle rates.



### Conveyor technology

Individually distributed drives and sensors covering an extensive area are common features of conveyor systems. The AS-interface is particularly suited to systems of this type.

Individual valve interfaces ASI-EVA or compact I/O modules support the direct connection of one or two valves of any size and up to 4 sensors to the AS-interface.

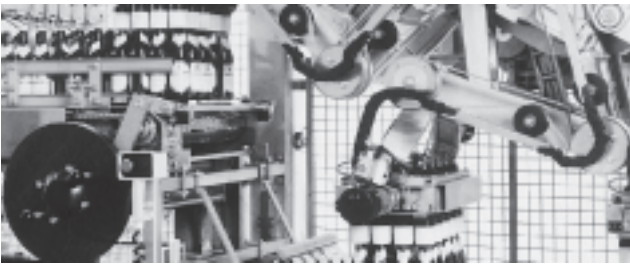

### Packaging

More complex machines frequently require decentralised installation concepts within the system in order to achieve an efficient electrical installation.

The AS-interface controls complex modules and upstream functions such as packaging in this picture.

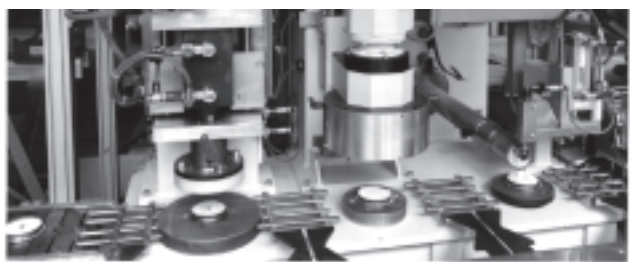

### Assembling

Assembly, moving, handling: this often means rapid-fire sequences, tight installation spaces and the need for reduced weight.

Compact I/O modules, valve terminals and matching drives provide the optimum solution here.



### Process engineering

Water treatment  
Automation and decentralised intelligence are innovative features of newer systems. Festo's valve actuators for the process industry are controlled via the AS-interface in the temperature range of -25 to +85 °C using the local controller, the sensor box DAPZ. The ASI-EVA or a compact I/O module

is suitable for all valves with Namur interface. The VTSA/VTSA-F valve terminal provides new scope for flow processes in 24-hour non-stop mode. Vertical pressure shut-off plates enable valve replacement under pressure (hot-swap) and thus avoid downtime.

# AS-interface® components

System overview

FESTO

## Master

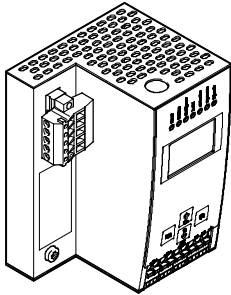

AS-interface gateways are used to connect the AS-interface network to a higher-level fieldbus. They behave like a master within the AS-interface network and a slave within the fieldbus network.

- AS-interface gateways from Festo conform to the AS-interface Specification 3.0 and support the extended addressing range with up to 62 AS-interface slaves.

Versions

- CANopen
- PROFIBUS

## Slaves

### Drives

Actuators for the process industry  
Quarter turn actuators DRD (Copar)

- Local controllers for actuators in outdoor applications in the range  $-5 \dots +50 \text{ }^\circ\text{C}$

- Individual valve interface ASI-EVA for Namur valves

- Sensor box with visual position detection DAPZ

### Valves

- A universal solution from the individual valve interface up to the compact solution with 8 valves

- Integrated inputs on individual valve interfaces and valve terminals CPV, MPA-S and VTSA/VTSA-F

- More inputs thanks to 4-fold and 8-fold input modules

- On request: Application-specific valves and integration solutions

## Accessories

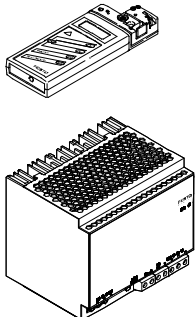

- Addressing device with user-friendly operating and diagnostic functions for the entire AS-interface, for example to perform the following tasks in a fully installed network:
  - change addresses
  - set outputs
  - read inputs
  - and many more

- Power supply unit for AS-interface
- Primary switched mode modular power supply
- Compact, modular and energy-saving power supply system for AS-interface – with integrated earth-fault monitoring system. AS-i load: 4.8 A. Optional auxiliary power supply 24 VDC, load: 5 or 10 A

- Installation accessories for installing the flat cable

## Valve interface variants

### Individual valve interface ASI-EVA

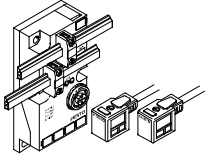

The perfect solution for 1 or 2 distributed valves and sensors

- Optimum pneumatic configuration within the range 10 ... 30,000 l/min

- Obtain the appropriate individual valve
- Then connect it to the AS-interface using Festo plug and work

- This solution offers the maximum in mechanical, pneumatic and electrical flexibility

### Compact valve terminal CPV

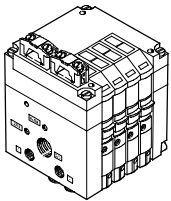

Maximum performance of 400 ... 1,600 l/min with minimal space requirement

- Valve combinations of 2, 4 or 8 valve slices
- Vacuum generation, relays and more in one unit

- Smart tubing system via pneumatic multiple connector plate:
  - Rapid replacement of valve terminals
  - With control cabinet installation: no internal tubing required

- M8 inputs included for each valve position
- Ex Zone 2, 22
- ASI Specification V2.0, V2.1 or V3.0

### Modular, multi-functional valve terminal MPA-S

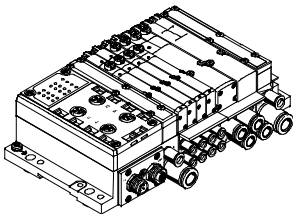

- Valves on a sub-base: individual valves can be easily replaced
- MPA-S: sturdy and modular from 360 ... 700 l/min
- Flexible valve combinations for 2 ... 8 solenoid coils
- Valve terminals can be expanded at a later date

- Mix of MPA1/2 on a valve terminal possible for optimised flow rates and control loop systems
- All valve functions, regulators and pressure gauges for variable pressure adjustment per valve position.
- 4 or 8 inputs with selectable connection technology

- Selectable connection technology on the bus. Flat cable in the case of the 4E4A version or M12 round cable in the case of the 4E4A and 8E8A versions (where 'E' stands for inputs and 'A' outputs)

### Modular, multi-functional valve terminal VTSA/VTSA-F

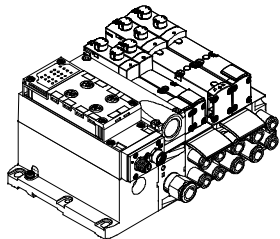

- Standard valves 18, 26, 42 and 52 mm to ISO 17504-2 and 5599-2 on a sub-base: individual valves can be easily switched
- VTSA/VTSA-F: compact and modular from 550 ... 1,500 l/min
- Flexible valve combinations for 1 ... 8 solenoid coils
- Valve terminals can be expanded at a later date

- Mix of 3 valve sizes on a valve terminal possible for optimised flow rates and control loop systems
- All valve functions, multiple pressure zones, regulators and pressure gauges for precision pressure adjustment per valve position, flow control, pressure shut-off plates for valve replacement under pressure (hot-swap) and additional components for vertical stacking

- 4 or 8 inputs with selectable connection technology
- Selectable connection technology on the bus. Flat cable in the case of the 4E4A version or M12 round cable in the case of the 4E4A and 8E8A versions (where 'E' stands for inputs and 'A' outputs)

### Compact I/O modules, valve interfaces

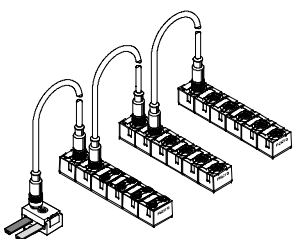

- Highly compact modules
- Sturdy, encapsulated electrics
- Bus and auxiliary power supply 2x M12 looped through

- Inputs 200 mA
- Outputs 1 A

- 8 inputs M8
- 4 inputs and 3 outputs M12



## AS-interface® components

CESA AS-interface modules – Overview

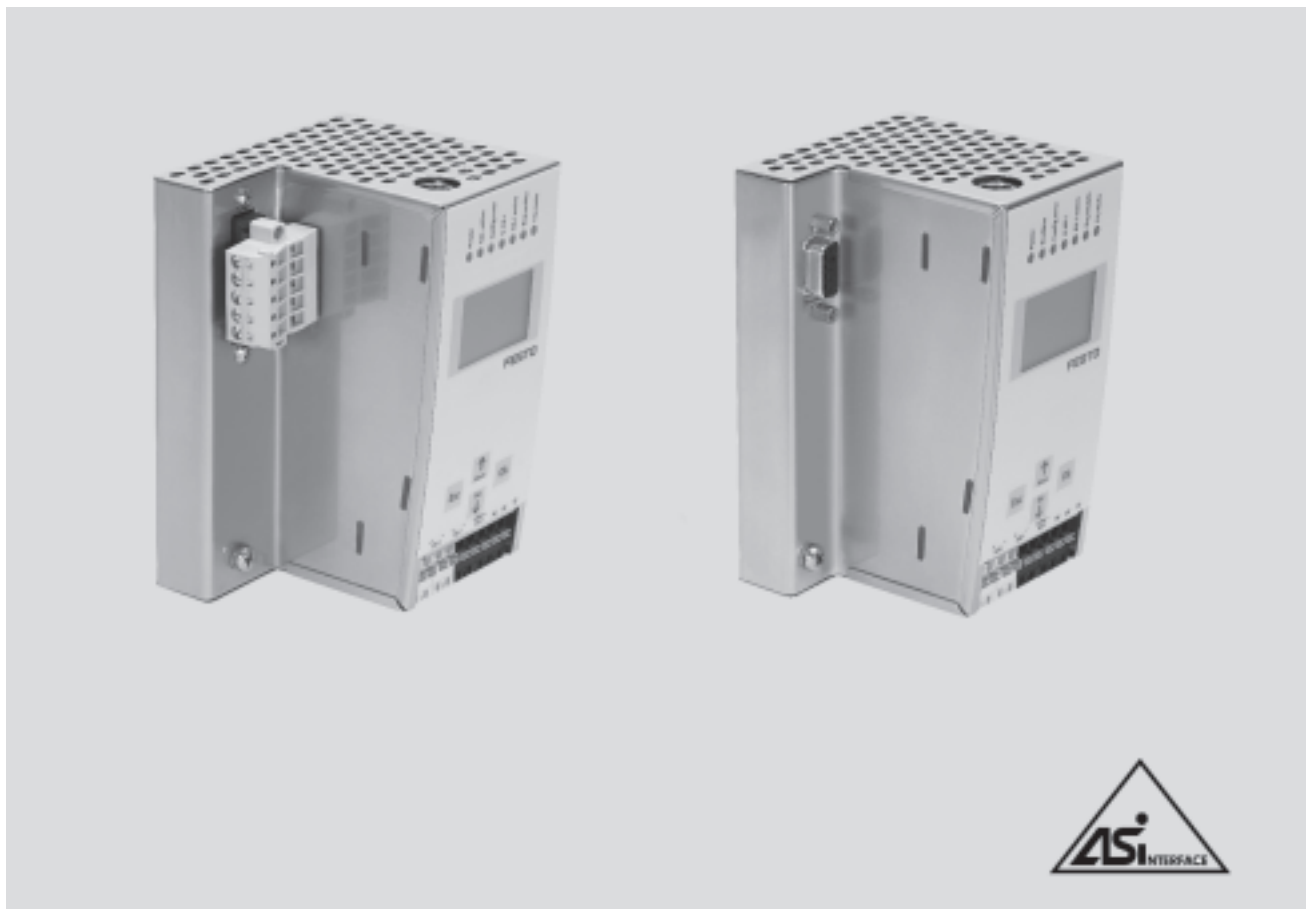

### CESA AS-interface modules

AS-interface gateways are an ideal way of connecting decentralised AS-interface networks to higher-level controllers via a fieldbus. They enable system parts to be set up decentrally and combined into logical units.

#### General

- Extended AS-interface diagnostic functions
- Simple configuration error history
- Error counters for monitoring the quality of data communication on the AS-interface cable

#### Versions

- PROFIBUS and CANopen
- Extended addressing range, up to 62 AS-interface slaves
- Terminal strip connection technology
- LCD display and LEDs
- Conforms to AS-interface Specification 3.0

#### Application

- Interface between centralised controller with fieldbus interface and valve terminals and input/outputs with AS-i interface

# AS-interface® components

CESA AS-interface modules – Connection technology and addressing

## Handling

### Operation

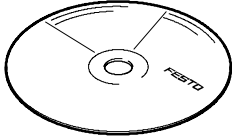

The AS-interface gateways can be configured and programmed using the GSPF software.  
An alternative option for programming, commissioning or troubleshooting is to use the operating buttons on the gateway and the LED and LCD displays on the gateway.

### AS-interface connections

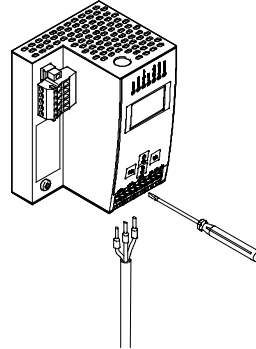

The AS-interface network as well as the power supply for the gateway and AS-interface are connected via a terminal strip.

## Mounting

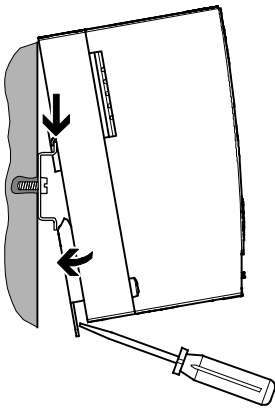

The gateway is mounted using an H-rail.  
There are appropriate lugs on the rear of the device.

## Extended addressing range

The extended addressing range enables a total of 62 slaves to be operated on an AS-interface master. The masters as well as the slaves must be designed for the extended addressing range in order to be able to exploit the full number of slaves.  
With the extended addressing range, two slaves share one address. Standard slaves do not have this capability. They can be connected to a master

with an extended addressing range, but also occupy a full address. In other words, up to 62 slaves with an extended addressing range but only 31 standard slaves can be connected to a master with an extended addressing range.  
Slaves with an extended addressing range can, like standard slaves, be connected to a standard master, but must be configured as an "A" slave.

# AS-interface® components

CESA AS-interface modules

General technical data		
	CESA-GW-AS-PB	CESA-GW-AS-CO
Operating elements	4 buttons	
Status displays	LCD display	
	Yellow LED: Projection mode	
	Green LED: AS-interface operating normally	
	Green LED: AS-interface voltage OK	
	Green LED: PROFIBUS master detected	
	Green LED: Slave programming	
	Green LED: Voltage ON	
	Red LED: Configuration error	
Operating voltage	[V DC]	30 (AS-interface voltage)
Current consumption	[mA]	200 (from the AS-interface circuit)
Protection class	IP20	
Resistance to shock	As per EN 61131-2	
Resistance to vibration	As per EN 61131-2	
Product weight	[g]	460
Dimensions W x L x H	[mm]	75 x 120 x 83
		520
		85 x 120 x 83
Materials		
Housing	High-alloy stainless steel	
Note on materials	Contains PWIS (paint-wetting impairment substances)	
	RoHS-compliant	

Technical data – Interfaces		
	CESA-GW-AS-PB	CESA-GW-AS-CO
Fieldbus interface		
Type	PROFIBUS to DIN 19245 Part 3	CANopen, Device Specification CiA DS-301
Connection technology	Sub-D socket, 9-pin	COMBICON plug, 5-pin
Transmission rate	9.6 kbps ... 12 Mbps	10 kbps ... 1 Mbps
Programming/diagnostic interface		
Type	RS 232 serial interface	

Operating and environmental conditions		
	CESA-GW-AS-PB	CESA-GW-AS-CO
Ambient temperature	[°C]	0 ... +55
Storage temperature	[°C]	-25 ... +85
Certification	cULus listed (OL)	
	C-Tick	
CE mark (see declaration of conformity) <sup>1)</sup>	To EU EMC Directive	

1) For information about the applicability of the component see the manufacturer's EC declaration of conformity at: [www.festo.com](http://www.festo.com) → Support → User documentation.  
If the component is subject to restrictions on usage in residential, office or commercial environments or small businesses, further measures to reduce the emitted interference may be necessary.

# AS-interface® components

CESA AS-interface modules – Connections

## Connection and display components

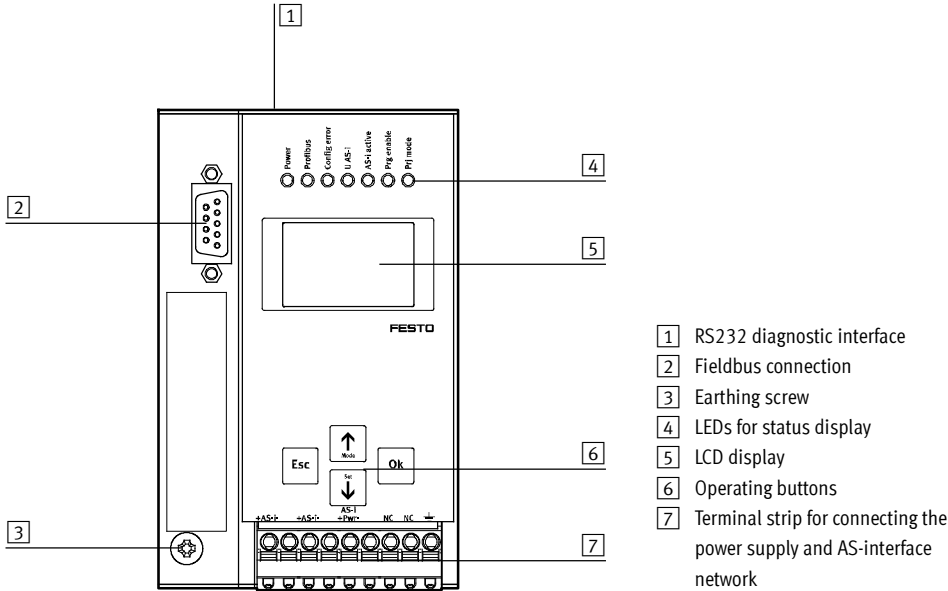

### Pin allocation – PROFIBUS

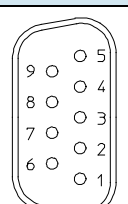
	Pin	Signal	Meaning
Sub-D socket to DIN 50170			
	1	n.c.	Not connected
	2	n.c.	Not connected
	3	RxD/TxD-P	Data transmission line B
	4	n.c.	Not connected
	5	DGND	Data reference potential (0 V)
	6	VP	Supply voltage (+5 V)
	7	n.c.	Not connected
	8	RxD/TxD-N	Data transmission line A
	9	n.c.	Not connected

### Pin allocation – CANopen

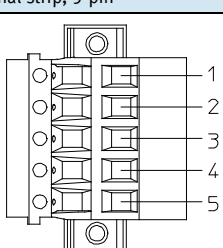
	Pin	Signal	Meaning
Terminal strip, 5-pin <sup>1)</sup>			
	1	V+	24 V DC supply CAN interface
	2	CAN_H	Received/transmitted data high
	3	Screened	Connection to FE (functional earth)
	4	CAN_L	Received/transmitted data low
	5	V-	0 V CAN interface

1) The interface is supplied with voltage via the plug.

### Pin allocation – AS-interface

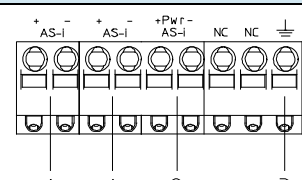
	Signal	Meaning	
Screw terminal			
	1	+AS-i-	Connection to AS-i circuit
	2	AS-i +PWR-	Supply voltage for AS-i circuit (max. 8 A)
	3	FE	Functional earth

# AS-interface® components

CESA AS-interface modules – Dimensions

Dimensions

Download CAD data → [www.festo.com](http://www.festo.com)

CESA-GW-AS-PB

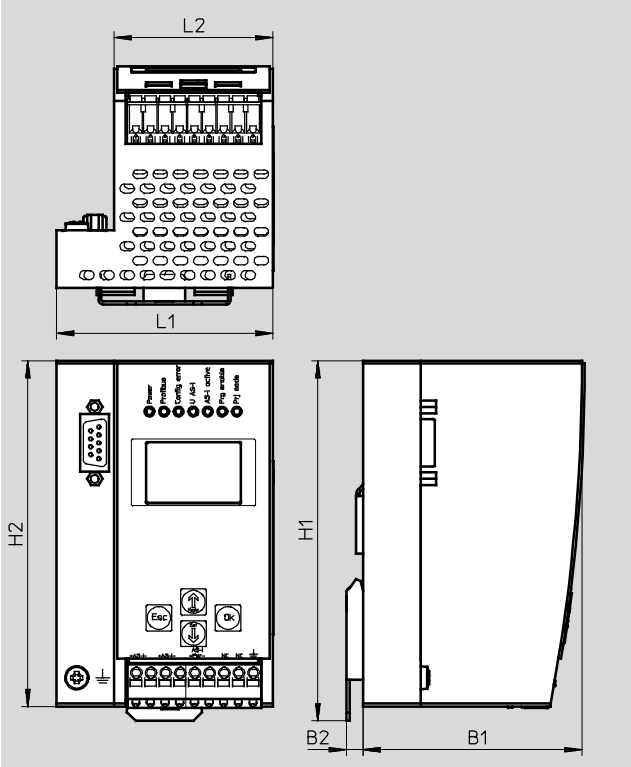

CESA-GW-AS-CO

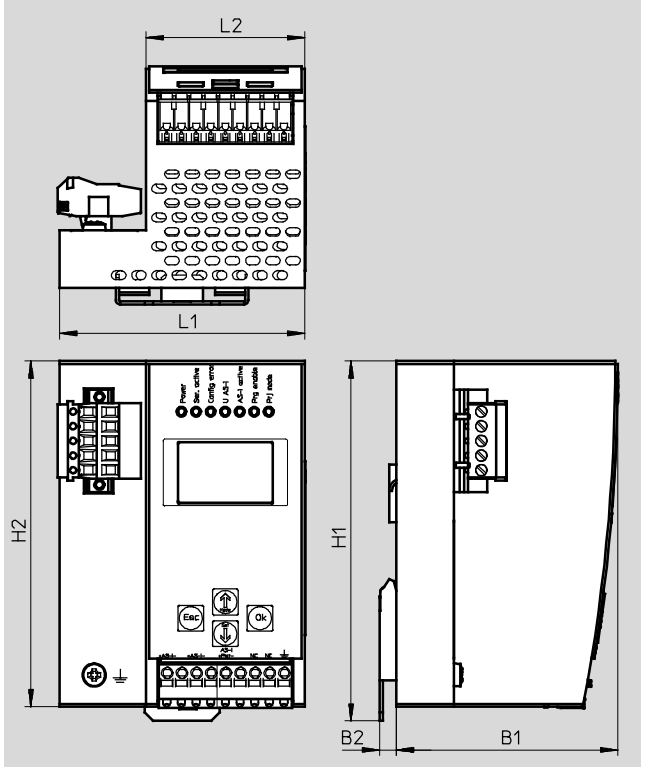





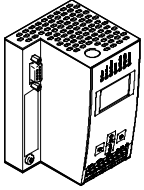
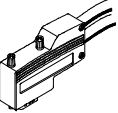
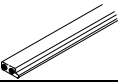

Type	B1	B2	H1	H2	L1	L2
CESA-GW-AS-PB	76	7	125	120	75	55
CESA-GW-AS-CO	76	7	125	120	85	55

## AS-interface® components

CESA AS-interface modules – Accessories

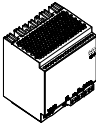
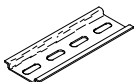
**FESTO**

Ordering data		Part No.	Type
<b>AS-interface gateway</b>			
	AS-interface master with PROFIBUS DP fieldbus connection	<b>567032</b>	<b>CESA-GW-AS-PB</b>
	AS-interface master with CANopen fieldbus connection	<b>567033</b>	<b>CESA-GW-AS-CO</b>
<b>PROFIBUS bus connection</b>			
	Sub-D plug, angled	<b>533780</b>	<b>FBS-SUB-9-WS-PB-K</b>
<b>AS-interface</b>			
	AS-interface flat cable, yellow	100 m	<b>18940</b> <b>KASI-1,5-Y-100</b>
	AS-interface flat cable, black	100 m	<b>18941</b> <b>KASI-1,5-Z-100</b>
	Cable cap for flat cable (pack of 50)	<b>18787</b>	<b>ASI-KK-FK</b>
	Cable sleeve (pack of 20)	<b>165593</b>	<b>ASI-KT-FK</b>
	AS-interface module as bus termination	<b>567035</b>	<b>CACF-BT-AS</b>
	Primary switched mode, modular power supply 24 V DC power supply	5 A	<b>547867</b> <b>SVG-1/230-24VDC-5A</b>
		10 A	<b>547868</b> <b>SVG-1/230-24VDC-10A</b>
	H-rail to EN 60715	<b>35430</b>	<b>NRH-35-2000</b>
	Software for configuring the system and diagnosing the AS-interface slaves during servicing	<b>567036</b>	<b>GSPF-BS-1-AF-ML</b>

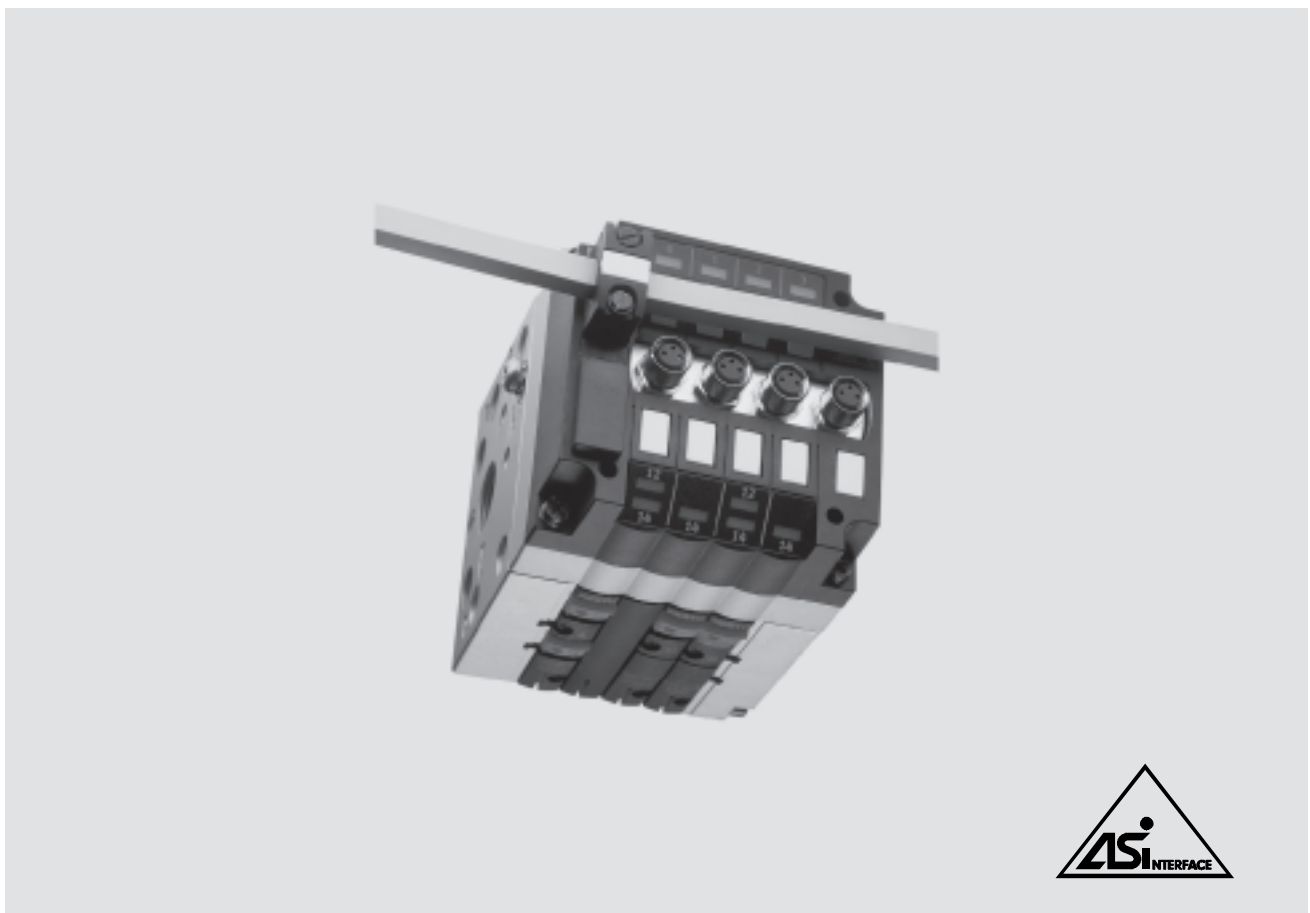

## CPV valve terminals with AS-interface – Valve configuration options

CPV valve terminals with AS-interface can be configured with a wide range of valve slices. The system supports a maximum of 8 outputs and 8 inputs per AS-interface slave.

This gives the following basic valve slice configuration options (see tables on following page). Vacant positions can be configured instead of valve slices at any position.

### General data

- With or without 24 V DC auxiliary power supply for solenoid coils (EMERGENCY-STOP circuitry) depending on bus interface
- Solutions with and without integrated inputs
- Width 10, 14 or 18 mm

### Versions

- 2, 4 or 8 valve slices
- With 4 or 8 inputs, either
  - standard mode (SPEC V2.0)
  - A/B mode (SPEC V2.1)
  - A/B mode (SPEC V3.0, profile 7.A.7)
- Optionally with floating relay outputs
- Valves with integrated separation of channels 1 and 11
- Separator plates for the creation of pressure zones
- Suitable for vacuum
- Vacant positions for subsequent extension
- Optionally with pneumatic multiple connector plate

### Application

- Cost-effective connection of 2, 4 or 8 valve slices to the AS-interface
- Comprehensive range of valve functions
- Decentralised machine and system structures, for example
  - in handling technology
  - in conveyor technology
  - in the packaging industry
  - in sorting systems
  - in upstream machine functions



Note

Please follow the links below for more details on the various pneumatic functions.

➔ Internet: [cpv](http://cpv)

Types of valve terminal with AS-interface									
Code	Type	Valve slices	Solenoid coils	Inputs (M8 connection)	Auxiliary power supply		Size		
					With	Without	CPV10	CPV14	CPV18
AZ	CPV1x-GE-ASI-2-Z	2	4	–	■	–	■	■	■
AZ	CPV18-GE-ASI-4-Z	4	4	–	■	–	–	–	■
AE/AO	CPV1x-GE-ASI-4E4A (-Z)	4	4	4	■	■	■	■	–
AE	CPV1x-GE-ASI-8E8A-Z	8	8	8	■	–	■	■	–
BE	CPV1x-GE-ASI-4E3A (-Z)	4	3	4	■	–	■	■	–
BE	CPV1x-GE-ASI-8E6A-Z	8	6	8	■	–	■	■	–
CE	CPV1x-GE-ASI-4E4A-Z-M8-CE	4	4	4	■	–	■	■	–
CE	CPV1x-GE-ASI-8E8A-Z-M8-CE	8	8	8	■	–	■	■	–

1) The load voltage (auxiliary power supply via the black cable) can be connected/disconnected separately.

Permissible combinations in valve position allocation								
Type	Slave n				Slave n+1			
	0	1	2	3	4	5	6	7
CPV1x-GE-ASI-2-Z	M	M						
	J	M						
	M	J						
	J	J						
CPV18-GE-ASI-4-Z	M	M	M	M				
CPV1x-GE-ASI-4E4A (-Z) CPV10-GE-ASI-4A (-Z) CPV14-GE-ASI-4A (-Z)	M	M	M	M				
	J	Vacant position	M	M				
	M	M	J	Vacant position				
	J	Vacant position	J	Vacant position				
CPV1x-GE-ASI-4E3A -Z <sup>1)</sup>	M	M	M	Vacant position				
	J	Vacant position	M	Vacant position				
CPV1x-GE-ASI-8E8A-Z <sup>1)</sup> CPV1x-GE-ASI-8E8A-Z-CE <sup>1)</sup>	M	M	M	M	M	M	M	M
	J	Vacant position	M	M	M	M	M	M
	M	M	J	Vacant position	M	M	M	M
	J	Vacant position	J	Vacant position	M	M	M	M
	...	...	...	...	...	...	...	...
	M	M	M	M	M	M	M	M
	M	M	M	M	J	Vacant position	M	M
	M	M	M	M	M	M	J	Vacant position
CPV1x-GE-ASI-8E6A-Z <sup>1)</sup>	M	M	M	Vacant position	M	M	M	Vacant position
	M	M	M	Vacant position	J	Vacant position	M	Vacant position
	J	Vacant position	M	Vacant position	M	M	M	Vacant position
	J	Vacant position	M	Vacant position	J	Vacant position	M	Vacant position

- 1) - Valve slices with 2 outputs must be configured at positions 0, 2, 4, 6 (or positions 0, 4 with A/B mode).  
 - Valve slices with 2 outputs always have a vacant position.  
 - Slaves n and n+1 can be configured independently of one another. This gives a total of 16 different configuration options.
- M Valve slice with single solenoid valve or a different valve slice with an output.  
 J Valve slice with double solenoid valve or a different valve slice with two outputs.



# AS-interface® components

CPV valve terminals with integrated inputs, to SPEC V2.0

FESTO

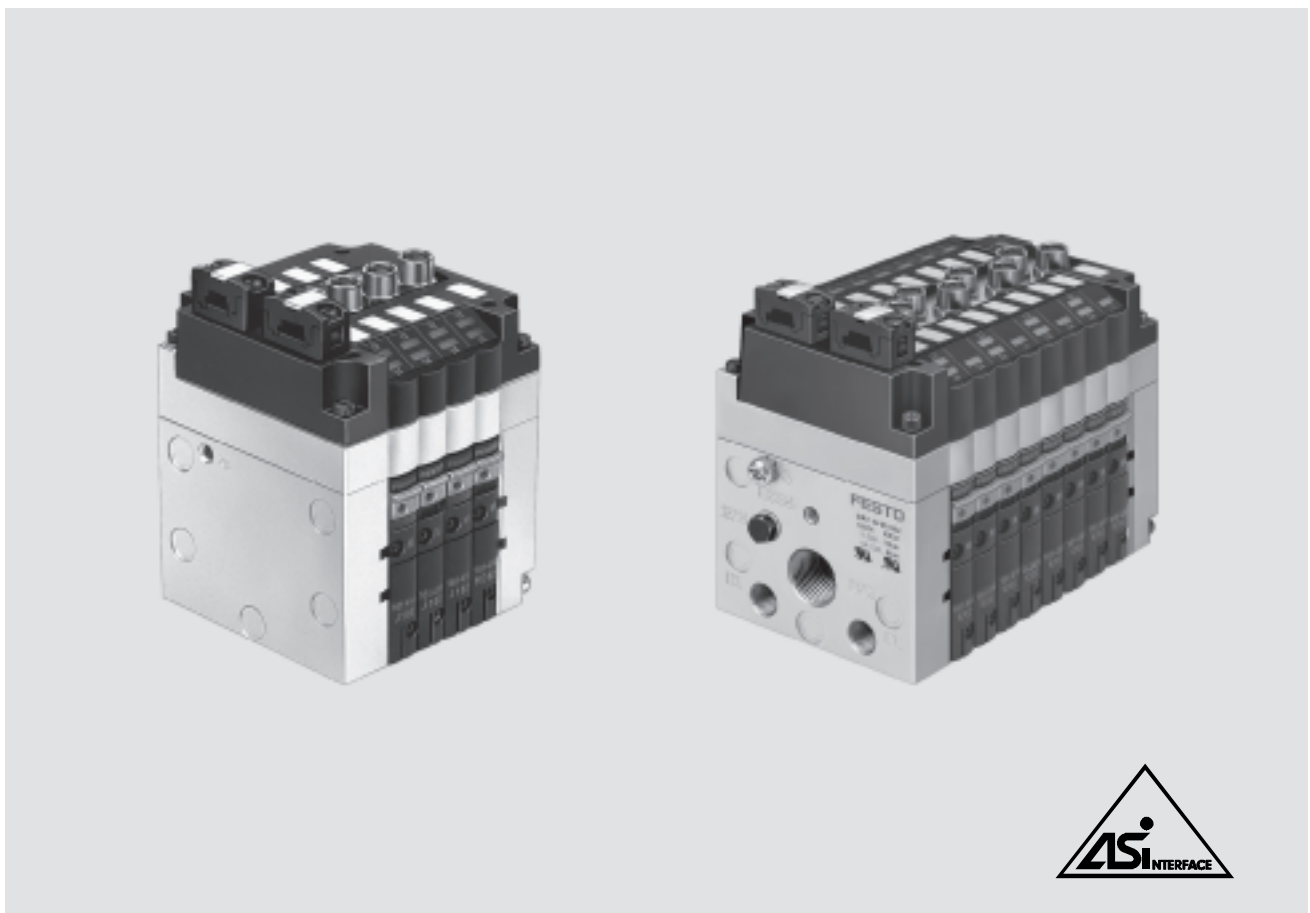

## CPV valve terminals with integrated inputs, to Specification V2.0

### General data

- Cubic design for exceptional performance and low weight
- Highly flexible thanks to various pneumatic functions (valve variants), different pressure ranges, vacuum switches and the option of integrated vacuum generation
- Floating relay outputs (optional)
- Connection for auxiliary power supply for EMERGENCY-STOP conditions
- Protection class IP65

### LED displays for:

- Status display for inputs
- Switching status of valves
- PWR-LED (power)
- FAULT-LED (fault)

### Versions

- Width 10 and 14 mm
- 4 or 8 inputs
- 4 or 8 valve positions
- Up to four pressure zones
- Suitable for vacuum
- Vacuum generation

- Various valve functions on one valve terminal, for example
  - 2x 3/2-way valve
  - 5/2-way valve, single solenoid
  - 5/2-way valve, double solenoid
  - 5/3-way valve
  - 2x 2/2-way valve
- Valves with integrated separation of channels 1 and 11
- Separator plate
- Vacant position
- Additional function (screwed onto valve slice)
  - One-way flow control valve
- Various mounting options

### Application

- Flexible and cost-effective connection of 4 or 8 valve slices and up to 8 sensors to the M8 inputs to Spec. V2.0, 31 slaves, bus cycle max. 5 ms. Executable on all masters from Spec. V2.0 or higher.

 Note

Please follow the links below for more details on the various pneumatic functions.

➔ Internet: [cpv](http://cpv)

# AS-interface® components

FESTO

CPV valve terminals with integrated inputs, to SPEC V2.0

Technical data				
Type		CPV-...-GE-ASI-4E4A-Z-M8	CPV-...-GE-ASI-4E4A-M8	CPV-...-GE-ASI-8E8A-Z-M8
Part No.	Order via order code/valve terminal configurator			
Code		AE	AO	AE
Valves	Number of valve slices/coils	4	4	8
	Valve width [mm]	10/14		
	Setting of the valve configuration	Integrated DIL switch		
	External power supply 24 V DC	Yes	No	Yes
	Digital inputs	4	4	8
	Connection technology	M8, 3-pin		
	Sensor supply via AS-interface	Short circuit and overload proof		
	Sensor connection	2-wire and 3-wire sensors		
	Type	IEC 1131-2, type 2		
	Input circuitry	PNP (positive switching)		
	AS-interface connection	Connection technology	AS-interface flat cable plug (included in scope of delivery)	
Voltage range [V DC]		26.5 ... 31.6, reverse polarity protected		
Residual ripple [mVss]		20		
Current consumption [mA] of inputs			CPV10/14	
• In 0 status		7	61/95	40
• In 1 status (no current consumption by sensors)		35	89/123	96
• In 1 status (max. current consumption by sensors)		240	191/225	278
• Max. per input	200	200	200	
• Max. per valve		25/38.75		
– when switching on		8.75/12.5		
– following a current reduction				
Load voltage connection	Connection technology	AS-interface flat cable plug (version turned through 180° must be ordered separately)		
	Nominal voltage [V DC]	24 ±10%		
	Residual ripple [Vss]	4		
	Current consumption of valves	CPV10/14	No load voltage connection	CPV10/14
	• when switching on [mA]	108/176		200/310
• following a current reduction [mA]	42/72		70/100	
LED displays	ASI-LED	Power/green		
	AUX-PWR-LED	Auxiliary power supply/green	None	Auxiliary power supply/green
	FAULT-LED	Fault LED/red		
	Inputs	Green		
	Valves	Yellow		
General data	Protection class (to EN 60529)	IP65 (fully assembled)		
	Electromagnetic compatibility	<ul style="list-style-type: none"> <li>• Interference emission</li> <li>• Interference immunity</li> </ul>		
	CE mark	Yes, in accordance with EU Directive 89/336/EEC		
	Temperature range [°C]	Operation: -5 ... +50; storage/transport: -20 ... +70		
	Materials	Housing: aluminium; cover: polyamide; seals: nitrile rubber; polychloroprene rubber		
	Dimensions	➔ 26		
	Weight	➔ 26		
	Pneumatic data	➔ Internet: cpv		
AS-interface data	ID code	F <sub>H</sub> (ID = F <sub>H</sub> ; ID1 = F <sub>H</sub> ; ID2 = F <sub>H</sub> )		
	IO code	7 <sub>H</sub>		
	Profile	S-7.F		

# AS-interface® components

CPV valve terminals with integrated inputs, for A/B mode to SPEC V2.1

FESTO

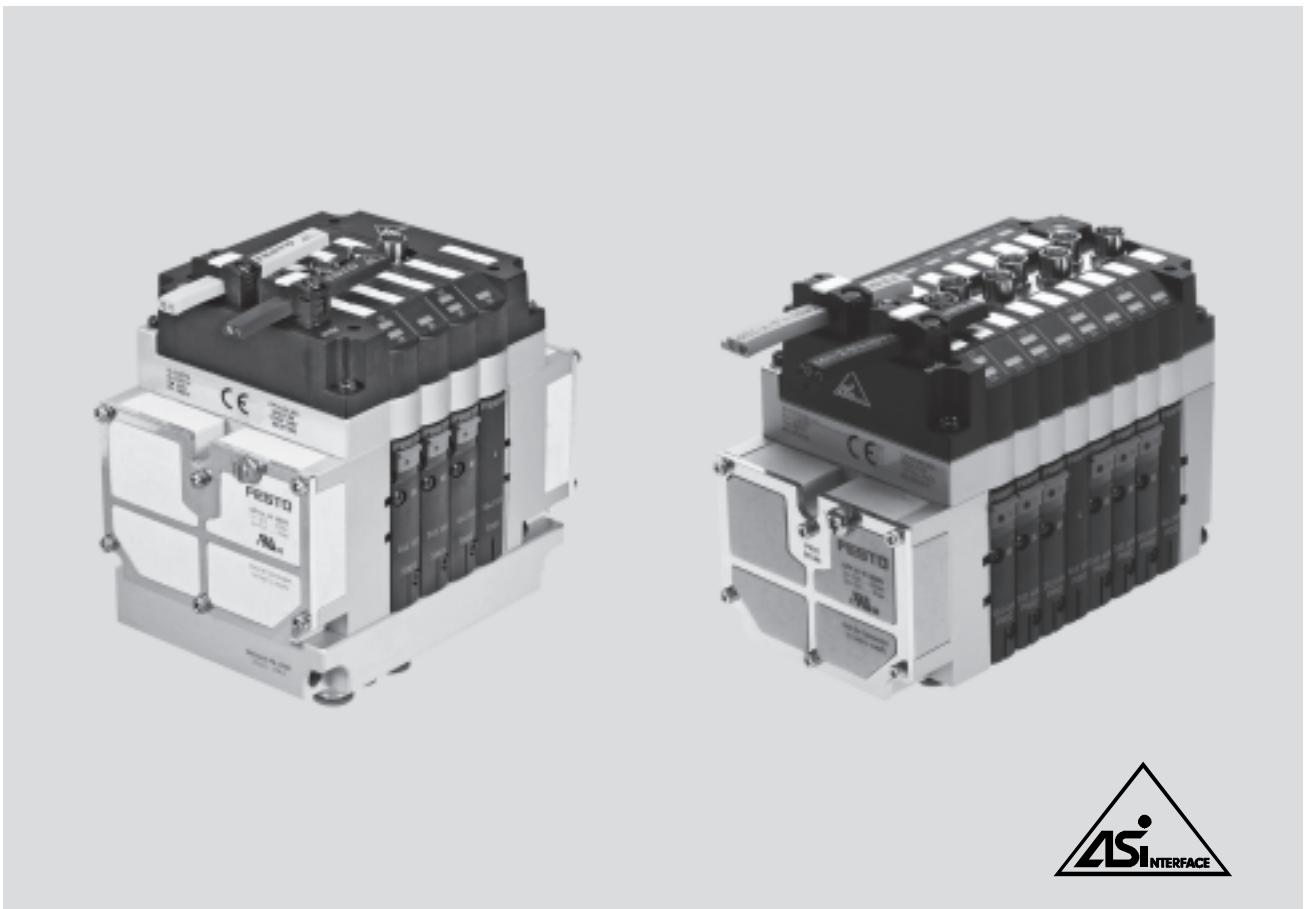

## CPV valve terminals with integrated inputs, for A/B mode to Specification V2.1<sup>1)</sup>

### General data

- A/B mode increases the performance of each master
  - 100% more inputs (248 instead of 124)
  - 50% more outputs (186 instead of 124)
- Cubic design for exceptional performance and low weight
- Highly flexible thanks to various pneumatic functions (valve variants), different pressure ranges, vacuum switches and the option of integrated vacuum generation
- Floating relay outputs, optional

- Connection for auxiliary power supply for EMERGENCY-STOP conditions
- Protection class IP65

### LED displays for:

- Status display for inputs
- Switching status displays for valves
- PWR-LED (power)
- FAULT-LED (fault)<sup>2)</sup>

### Versions

- Width 10 and 14 mm
- 4 or 8 inputs
- 3 or 6 valve positions

- Up to four pressure zones
- Suitable for vacuum
- Vacuum generation
- Various valve functions on one valve terminal, for example
  - 2x 3/2-way valve
  - 5/2-way valve, single solenoid
  - 5/2-way valve, double solenoid
  - 5/3-way valve
  - 2x 2/2-way valve
  - Valves with integrated separation of channels 1 and 11
  - Separator plate
  - Vacant position

- Additional function (screwed onto valve slice)
  - One-way flow control valve
- Various mounting options

### Application

- AS-i networks with A/B mode to SPEC V2.1 and SPEC V3.0, 62 slaves, bus cycle 10 ms
- Flexible and cost-effective connection of 3 or 6 valve slices and up to 8 sensors to the M8 inputs

1) Slave compatible with SPEC V3.0

2) Peripherals faults to SPEC V2.1 not yet implemented



Note

Please follow the links below for more details on the various pneumatic functions.

→ Internet: [cpv](http://cpv)

# AS-interface® components

FESTO

CPV valve terminals with integrated inputs, for A/B mode to SPEC V2.1

Technical data				
Type	CPV-...-GE-ASI-4E3A-Z-M8	CPV-...-GE-ASI-8E6A-Z-M8		
Part No.	Order via order code/valve terminal configurator			
Code	BE	BE		
Valves	Number of valve slices/coils	3	6	
	Valve width [mm]	10/14		
	Setting of the valve configuration	Integrated DIL switch		
	External power supply 24 V DC	Yes		
	Digital inputs	4	8	
	Connection technology	M8, 3-pin		
	Sensor supply via AS-interface	Short circuit and overload proof		
	Sensor connection	2-wire and 3-wire sensors		
	Type	IEC 1131-2, type 2		
	Input circuitry	PNP (positive switching)		
AS-interface connection	Connection technology	AS-interface flat cable plug (included in scope of delivery)		
	Voltage range [V DC]	26.5 ... 31.6, reverse polarity protected		
	Residual ripple [mVss]	20		
	Current consumption [mA] of inputs	• In 0 status	7	40
		• In 1 status (no current consumption by sensors)	35	96
• In 1 status (max. current consumption by sensors)		137	278	
• Max. per input		200	200	
Load voltage connection	Connection technology	AS-interface flat cable plug (version turned through 180° must be ordered separately)		
	Nominal voltage [V DC]	24 ±10%		
	Residual ripple [Vss]	4		
	Current consumption of valves	CPV10/14	CPV10/14	
		• when switching on [mA]	81/132	150/233
• following a current reduction [mA]	32/54	53/75		
LED displays	ASI-LED	Power/green		
	AUX-PWR-LED	Auxiliary power supply/green		
	FAULT-LED	Fault LED/red		
	Inputs	Green		
	Valves	Yellow		
General data	Protection class (to EN 60529)	IP65 (fully assembled)		
	Electromagnetic compatibility	• Interference emission		
		Tested to EN 55011, limit value class B		
	• Interference immunity		Tested to DIN EN 61000-4-2, DIN EN 61000-4-4 and EN V 50140	
	CE mark	Yes, in accordance with EU Directive 89/336/EEC		
	Temperature range [°C]	Operation: -5 ... +50; storage/transport: -20 ... +70		
	Materials	Housing: aluminium; cover: polyamide; seals: nitrile rubber, polychloroprene rubber		
	Dimensions	→ 26		
Weight	→ 26			
Pneumatic data	→ Internet: cpv			
AS-interface data	ID code	ID = A <sub>H</sub> ; ID1 = 7 <sub>H</sub> ; ID2 = E <sub>H</sub>		
	IO code	7 <sub>H</sub>		
	Profile	S-7.A.E		

# AS-interface® components

CPV valve terminals with integrated inputs, for A/B mode to SPEC V3.0

FESTO

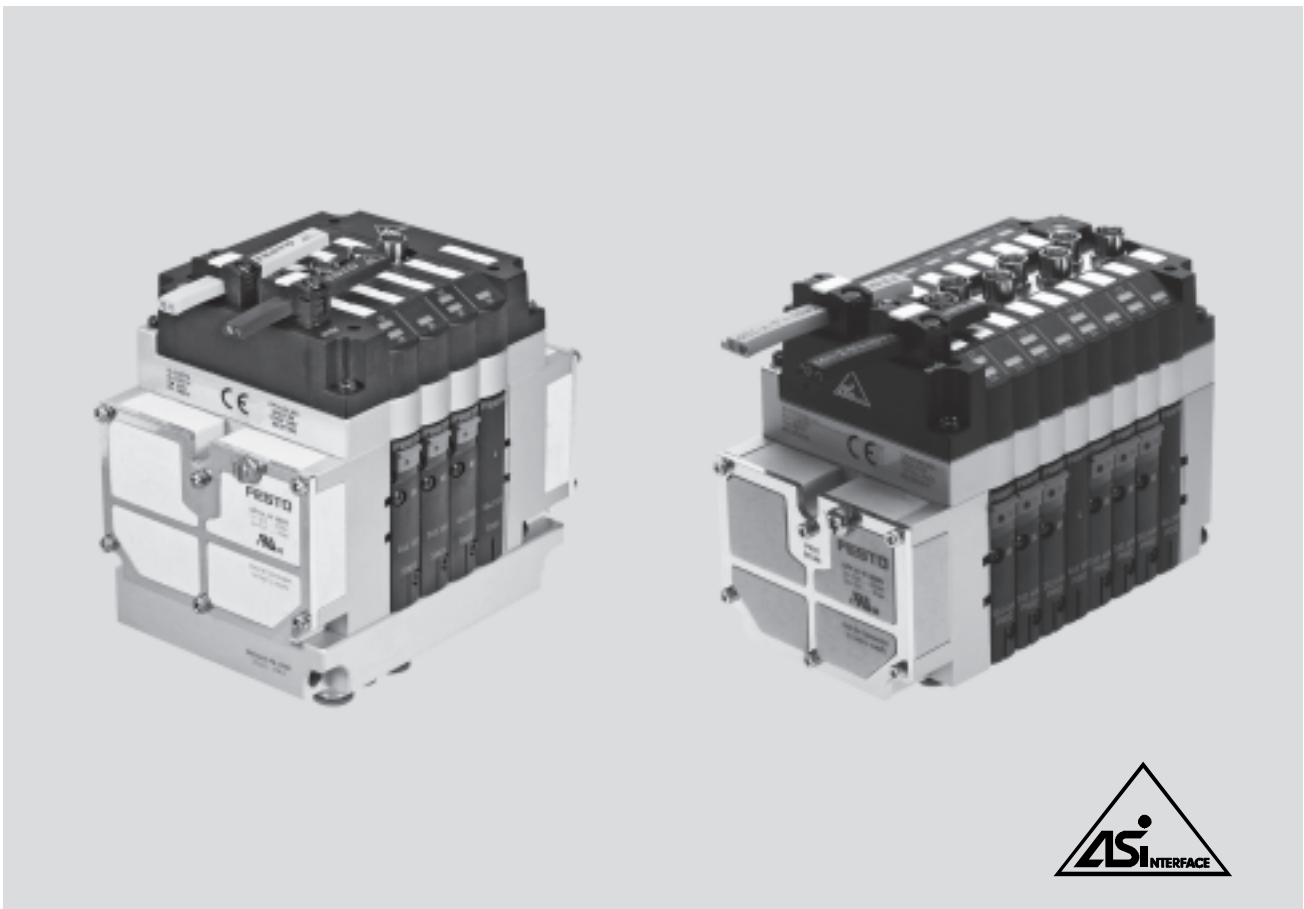

## CPV valve terminals with integrated inputs, for A/B mode to specification V3.0, profile 7.A.7

### General data

- A/B mode increases the performance of each master
  - 100% more inputs (248 instead of 124)
  - 100% more outputs (248 instead of 124)
- Cubic design for exceptional performance and low weight
- Highly flexible thanks to various pneumatic functions (valve variants), different pressure ranges, vacuum switches and the option of integrated vacuum generation
- Floating relay outputs, optional

- Connection for auxiliary power supply for EMERGENCY-STOP conditions
- Protection class IP65

### LED displays for:

- Status display for inputs
- Switching status displays for valves
- PWR-LED (power)
- FAULT-LED (fault)

### Versions

- Width 10 and 14 mm
- 4 or 8 inputs
- 4 or 8 valve positions

- Up to four pressure zones
- Suitable for vacuum
- Vacuum generation
- Various valve functions on one valve terminal, for example
  - 2x 3/2-way valve
  - 5/2-way valve, single solenoid
  - 5/2-way valve, double solenoid
  - 5/3-way valve
  - 2x 2/2-way valve
  - Valves with integrated separation of channels 1 and 11
  - Separator plate
  - Vacant position

- Additional function (screwed onto valve slice)
  - One-way flow control valve
- Various mounting options

### Application

- AS-i networks with A/B mode to SPEC V3.0, profile 7.A.7, 62 slaves, bus cycle 20 ms
- Flexible and cost-effective connection of 4 or 8 valve slices and up to 8 sensors to the M8 inputs



Note  
Slaves to Specification V3.0 require an ASi master to Specification V3.0; these detect the new slave profiles automatically.

Please follow the links below for more details on the various pneumatic functions.  
→ Internet: [cpv](http://cpv)

# AS-interface® components

FESTO

CPV valve terminals with integrated inputs, for A/B mode to SPEC V3.0

Technical data				
Type	CPV-...-GE-ASI-4E4A-Z M8-CE	CPV-...-GE-ASI-8E8A-Z M8-CE		
Part No.	Order via order code/valve terminal configurator			
Code	CE	CE		
Valves	Number of valve slices/coils	4	8	
	Valve width [mm]	10/14		
	Setting of the valve configuration	Integrated DIL switch		
	External power supply [V DC]	24		
	Digital inputs	4	8	
	Connection technology	M8, 3-pin		
	Device-specific diagnostics	Short circuit/overload of inputs		
	Sensor connection	2-wire and 3-wire sensors		
	Input characteristic	IEC 1131-2, type 2		
	Switching logic at inputs	PNP (positive switching)		
	AS-interface connection	Connection technology	AS-interface flat cable plug (included in scope of delivery)	
		Number of slaves per device	1	2
Voltage range [V DC]		26.5 ... 31.6, reverse polarity protected		
Residual ripple [mVss]		20		
Debounce time at inputs (at 24 V) [ms]		Typically 3		
Set using AS-interface addressing device		1A ... 31A (0) 1B ... 31B		
Switching level [V]				
Signal 0		≤ 5		
Signal 1		≥ 11		
Current consumption of inputs [mA]				
		• In 0 status	20	40
		• In 1 status (no current consumption by sensors)	Max. 48	Max. 96
• Max. per input	200	200		
Load voltage connection	Connection technology	AS-interface flat cable plug (version turned through 180° must be ordered separately)		
	Nominal voltage [V DC]	24 ±10%		
	Residual ripple [Vss]	4		
	Current consumption of valves (type-dependent)		CPV10/14	CPV10/14
		• when switching on [mA]	Max. 115/175	Max. 240/460
• following a current reduction [mA]	Max. 55/75	Max. 95/120		
LED displays	ASI-LED	Power/green		
	AUX-PWR-LED	Auxiliary power supply/green		
	FAULT-LED	Fault LED/red		
	Inputs	Green		
	Valves	Yellow		
General data	Protection class (to EN 60529)	IP65 (fully assembled)		
	Relative air humidity [%]	0 ... 95 (non-condensing)		
	CE mark	To EU EMC Directive		
	Temperature range [°C]	Operation: -5 ... +50; storage/transport: -20 ... +70		
	Materials	Housing: aluminium die-cast; cover: polyamide; seals: nitrile rubber, polychloroprene rubber		
	Dimensions	➔ 26		
	Weight	➔ 26		
	Pneumatic data	➔ Internet: cpv		
AS-interface data	ID code	ID = A <sub>H</sub> ; ID1 = 7 <sub>H</sub> ; ID2 = 7 <sub>H</sub>		
	IO code	7 <sub>H</sub>		
	Profile	S-7.A.7		

# AS-interface® components

CPV valve terminals without inputs, to SPEC V2.1

FESTO

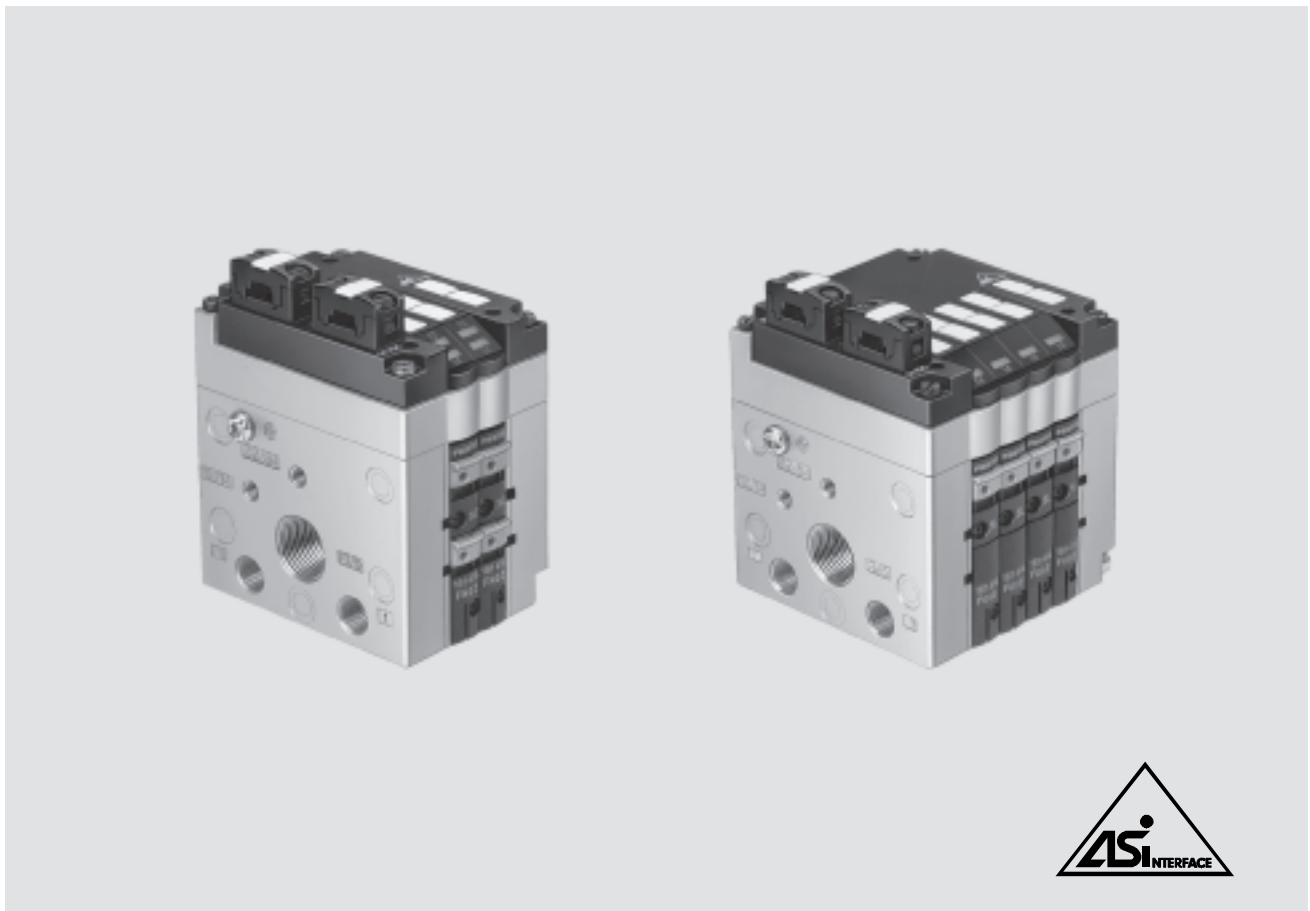

## CPV valve terminals without inputs, to Specification V2.1<sup>1)</sup>

### General data

- Cubic design for exceptional performance and low weight
- Highly flexible thanks to various pneumatic functions (valve variants), different pressure ranges, vacuum switches and the option of integrated vacuum generation
- Floating relay outputs, optional
- Connection for auxiliary power supply for EMERGENCY-STOP conditions
- Protection class IP65

### LED displays for:

- Switching status displays for valves
- PWR-LED (power)
- FAULT-LED (fault)<sup>2)</sup>
- Valve diagnostics: short circuit or wire break at valve solenoid coil, valve does not respond (no movement of the plunger)

### Versions

- Width 10, 14 and 18 mm
- 2 or 4 valve positions
- Up to two pressure zones
- Suitable for vacuum
- Vacuum generation

- Valve terminal with 4 valve positions:
  - With or without 24 V DC auxiliary power supply for solenoid coils (EMERGENCY-STOP circuitry)
  - The auxiliary power supply is always integrated and can be subsequently switched off using the DIL switch
- Various valve functions on one valve terminal, for example
  - 2x 3/2-way valve
  - 5/2-way valve, single solenoid
  - 5/2-way valve, double solenoid
  - 5/3-way valve
  - 2x 2/2-way valve
  - Valves with integrated separation of channels 1 and 11
  - Separator plate
  - Vacant position
- Additional function (screwed onto valve slice)
  - One-way flow control valve
- Extensive mounting options

### Application

- Flexible and cost-effective connection of 2 or 4 valve slices, 31 slaves, bus cycle max. 5 ms

1) Slave compatible with SPEC V3.0

2) Valve terminal with 4 valve positions: peripherals faults to SPEC V2.1 implemented  
Valve terminal with 2 valve positions: peripherals faults not implemented



Note

Please follow the links below for more details on the various pneumatic functions.

→ Internet: [cpv](http://cpv)

# AS-interface® components

CPV valve terminals without inputs, to SPEC V2.1

FESTO

Technical data				
Type	CPV-...-GE-ASI-2-Z		CPV-...-GE-ASI-4-Z <sup>1)</sup>	
Part No.	Order via order code/valve terminal configurator			
Code	AZ		AS/AZ	
Valves	Number of valve slices/coils	2/4	4/4	
	Valve width	10 mm	■	
		14 mm	■	
		18 mm	■	
	Setting of the valve configuration	None (permanently assigned)		CPV 10/14 Integrated DIL switch, CPV 18 <sup>3)</sup>
	External power supply 24 V DC	Yes		Yes <sup>2)</sup> Set using DIL switch
AS-interface connection	Connection technology	AS-interface flat cable plug (must be ordered separately)		
	Voltage range [V DC]	26.5 ... 31.6, reverse polarity protected		
	Residual ripple [mVss]	20		
	Current consumption of all valves	CPV10/14/18	CPV10/14/18	
	• without current reduction [mA]	25/25/25	25/25/25	
	• with current reduction [mA]	25/25/25	25/25/25	
Load voltage connection	Connection technology	AS-interface flat cable plug (must be ordered separately)		
			Blanking plug for sealing the unused connection enclosed	
	Nominal voltage [V DC]	24 ±10%		
	Residual ripple [Vss]	4		
	Max. starting current	CPV10/14/18	CPV10/14/18	
	• before current reduction [mA]	108/176/320	110/165/246	
• following a current reduction [mA]	48/72/120	35/40/100		
LED displays	PWR-LED	Power/green		
	FAULT-LED	Fault LED/red	Peripherals fault LED/red Valve diagnostics: short circuit or wire break at valve solenoid coil, valve does not respond (no movement of the plunger)	
	Valves	Yellow		
General data	Protection class (to EN 60 529)	IP65 (fully assembled)		
	Electromagnetic compatibility	<ul style="list-style-type: none"> <li>• Interference emission</li> <li>• Interference immunity</li> </ul> Tested to EN 55011, limit value class B Tested to DIN EN 61000-4-2, DIN EN 61000-4-4 and EN V 50140		
	CE mark	Yes, in accordance with EU Directive 89/336/EEC		
	Temperature range [°C]	Operation: -5 ... +50; storage/transport: -20 ... +70		
	Materials	Housing: aluminium die-cast; cover: polyamide; seals: nitrile rubber, polychloroprene rubber		
	Dimensions	➔ 26		
	Weight	➔ 26		
	Pneumatic data	➔ Internet: cpv		
	AS-interface data	ID code	F <sub>H</sub>	
IO code		8 <sub>H</sub>		
ID2 code		F <sub>H</sub>	E <sub>H</sub> (F <sub>H</sub> with CPV18)	
Profile		S-8.F		
Parameter P3 CPV valve diagnostic function			1 = enable 2 = disable	
Default		1 for CPV with valve diagnostics		

1) New as of hardware status 0105: single or double solenoid valves can be configured by means of a DIL switch.

2) With or without 24 V DC auxiliary power supply for solenoid coils (EMERGENCY-STOP circuitry). The auxiliary power supply is always integrated and can be switched on/off using the DIL switch.

3) None (permanently assigned)



# AS-interface® components

CPV valve terminals – Connections/displays

## Overview of connections/displays – CPV with AS-interface

CPV-...-GE-ASI-2-Z / ASI-4 (Z)

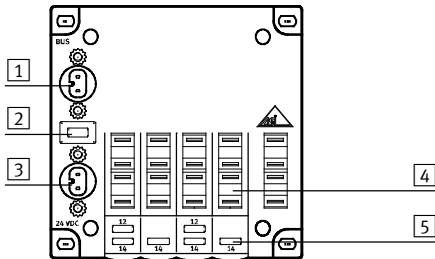

- 1 AS-interface bus connection
- 2 PWR LED (power, green)  
Fault LED (fault, red)
- 3 Auxiliary power supply for valves (optional)
- 4 Inscription areas
- 5 LED display for valves

CPV-...-GE-ASI-4E4A(Z) / 4E/3A-...- / 4E/4A-...-CE

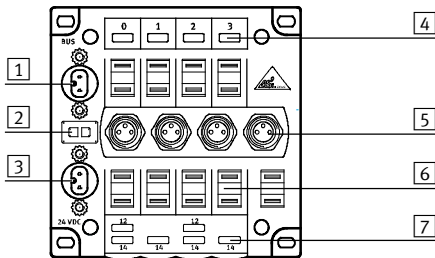

- 1 AS-interface bus connection
- 2 PWR LED (power, green)  
Fault LED (fault, red)
- 3 Auxiliary power supply for valves (optional)
- 4 LED display for inputs (green)
- 5 Sensor connections
- 6 Inscription areas
- 7 LED display for valves (yellow)

CPV-...-GE-ASI-8E8A-Z / 8E/6A / 8E/8A-...-CE

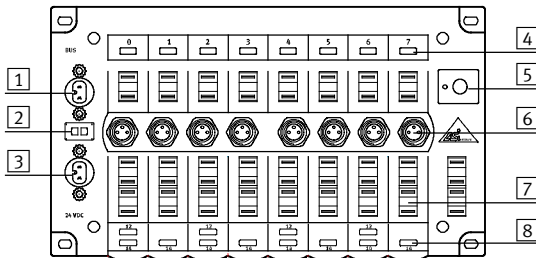

- 1 AS-interface bus connection
- 2 PWR LED (power, green)  
Fault LED (fault, red)
- 3 Auxiliary power supply for valves
- 4 LED display for inputs (green)
- 5 Address selector button with LED
- 6 Sensor connections
- 7 Inscription areas
- 8 LED display for valves (yellow)

### Pin allocation

Inputs CPV	Pin	Allocation
	1	+24 V
	3	0 V
	4	Input

# AS-interface® components

CPV valve terminals – Weights/dimensions

Weights [g] – Valve terminal CPV with AS-interface			
Type	CPV10	CPV14	CPV18
Electrical connection plate with AS-interface connection			
• with 2 valve positions	85	130	275
• with 4(3) valve positions	110	175	355
• with 8(6) valve positions	200	300	
End plate, 2 pieces	160	280	740
Pneumatic multiple connector plate			
• on CP valve terminal with 2 valve positions	120	270	520
• on CP valve terminal with 4 valve positions	165	390	750
• on CP valve terminal with 6 valve positions	225	510	870
• on CP valve terminal with 8 valve positions	270	630	1300
Flat plate silencer	147	234	–
Relay plate	35	55	–
Blanking plate	25	45	90
Separator plate	25	45	90
Valve plate/vacuum generator	65	110	260
Functional module: One-way flow control valves	25	54	125

## Dimensions – CPV with AS-interface Download CAD data → [www.festo.com](http://www.festo.com)

Without integrated inputs

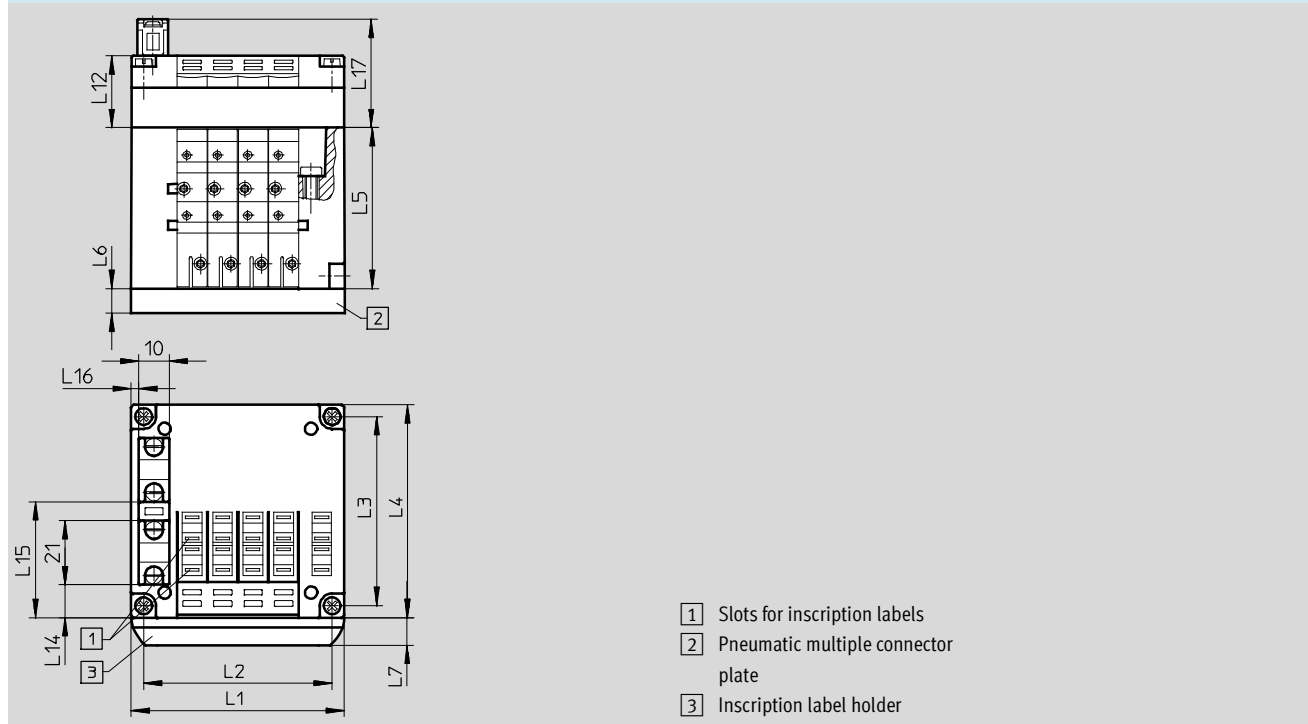

		L1	L2	L3	L4	L5	L6	L7	L12	L14	L15	L16	L17
CPV10	2-fold	50	41.8	62	71	52.8	15	9.5	–	10.9	38.1	2.5	35.5
	4-fold	70	61.8	62	71	52.8	15	9.5	23.5	10.9	38.1	2.5	35.5
CPV14	2-fold	68	58	78	89	58.8	20	9.5	–	14	52	5	35.5
	4-fold	96	86	78	89	58.8	20	9.5	23.5	14	52	5	35.5
CPV18	2-fold	96	85.5	106.5	118	73	20	9.5	–	27.4	68.2	10.4	40
	4-fold	132	121.5	106.5	118	73	20	9.5	28	27.4	68.2	10.4	40

Dimensions – CPV with AS-interface

Download CAD data → [www.festo.com](http://www.festo.com)

CPV10/14 with integrated inputs

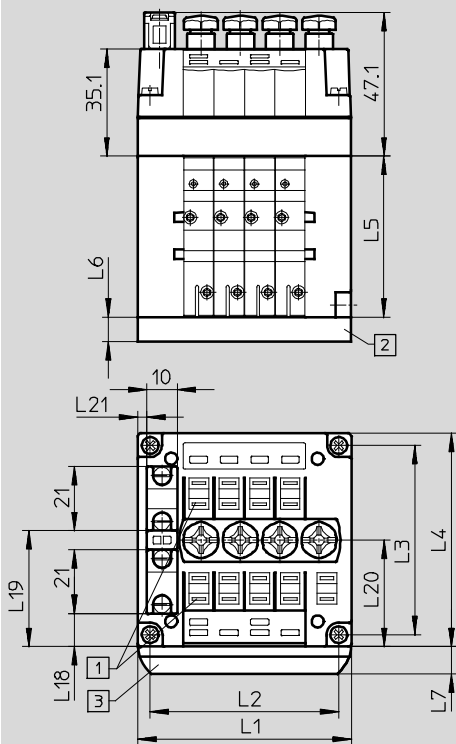

- 1 Slots for inscription labels
- 2 Pneumatic multiple connector plate
- 3 Inscription label holder (CPV10/14-VI-BZ-T... or CPV10/14-VI-ST-T...)

CPV10 with integrated inputs

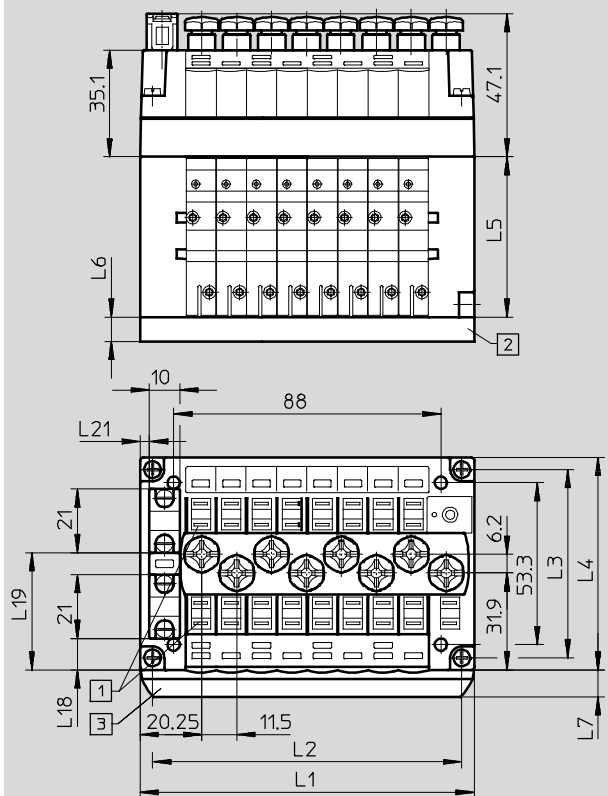

- 1 Slots for inscription labels
- 2 Pneumatic multiple connector plate
- 3 Inscription label holder (CPV10-VI-BZ-T... or CPV10-VI-ST-T...)

		L1	L2	L3	L4	L5	L6	L7	L18	L19	L20	L21
CPV10	4-fold	70	61.8	62	71	52.8	15	9.5	10.9	38.1	35	3
	8-fold	110	101.8						10.4	38.6	31.9	
CPV14	4-fold	96	86	78	89	58.8	20	9.5	18.8	46.8	43.3	5

Dimensions – CPV with AS-interface

Download CAD data → [www.festo.com](http://www.festo.com)

CPV14 with integrated inputs

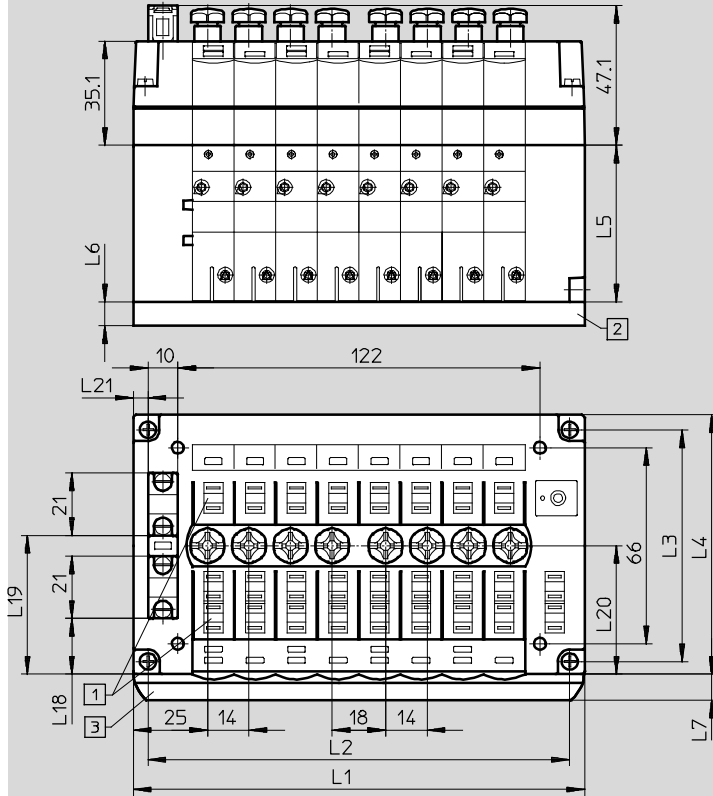







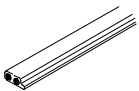
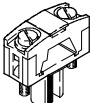
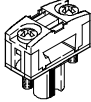

- 1 Slots for inscription labels
- 2 Pneumatic multiple connector plate
- 3 Inscription label holder  
(CPV14-VI-BZ-T-... or  
CPV14-VI-ST-T-...)

		L1	L2	L3	L4	L5	L6	L7	L18	L19	L20	L21
CPV14	8-fold	152	142	78	89	58.8	20	9.5	18.8	46.8	46.3	5

# AS-interface® components

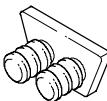
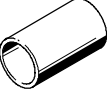
CPV valve terminals – Accessories

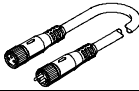
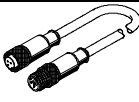

FESTO

Ordering data				
	Description		Part No.	Type
<b>Bus connection</b>				
	AS-interface flat cable, yellow	100 m	18940	KASI-1,5-Y-100
	AS-interface flat cable, black	100 m	18941	KASI-1,5-Z-100
	Flat cable socket		18785	ASI-SD-FK
	Flat cable socket	Turned through 180°	196089	ASI-SD-FK180
	Flat cable blanking plug		196090	ASI-SD-FK-BL
	AS-interface flat cable distributor	Parallel cable	18786	ASI-KVT-FK
	AS-interface flat cable distributor	Symmetrical cable	18797	ASI-KVT-FK-S
	Cable cap for flat cable (scope of delivery 50 pieces)		18787	ASI-KK-FK
	Cable sleeve (scope of delivery 20 pieces)		165593	ASI-KT-FK
<b>Sensor plugs</b>				
	Straight sensor plug	M8, screw-in, 3-pin	192009	SEA-3GS-M8-S
	Straight sensor plug	M8, solderable, 3-pin	18696	SEA-GS-M8
	Protective cap (scope of delivery 10 pieces)	M8	177672	ISK-M8
<b>Connecting cable</b>				
	Modular system for connecting cables → Internet: nebu		–	NEBU-...
	Connecting cable, straight plug, straight socket	M8, 0.5 m	175488	KM8-M8-GSGD-0,5
		M8, 1.0 m	175489	KM8-M8-GSGD-1
		M8, 2.5 m	165610	KM8-M8-GSGD-2,5
		M8, 5.0 m	165611	KM8-M8-GSGD-5

# AS-interface® components

CPV valve terminals – Accessories

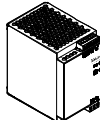
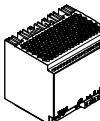
FESTO

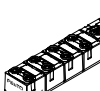
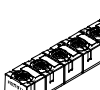
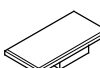
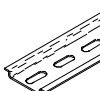
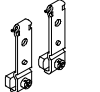
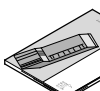
Ordering data		Part No.	Type
<b>Miscellaneous</b>			
	Primary switched mode modular power supply AS-interface power supply 4.8 A	547869	SVG-1/230VAC-ASI-5A
	Primary switched mode modular power supply 24 VDC power supply 5 A	547867	SVG-1/230-24VDC-5A
	Primary switched mode modular power supply 24 VDC power supply 10 A	547868	SVG-1/230-24VDC-10A
	Addressing device (power supply plug included in scope of delivery)	18959	ASI-PRG-ADR
	Addressing cable	18960	KASI-ADR
	AS-interface input module for 8 inputs M8	542124	ASI-8DI-M8-3POL
	AS-interface input/output module for 4 inputs/3 outputs M12	542125	ASI-4DI3DO-M12X2-5POL-Z
	Inscription labels 6x10mm in frames (64 pieces)	18576	IBS 6x10
	Inscription labels 9x20mm in frames (20 pieces)	18182	IBS 9x20
	H-rail to EN 60715	35430	NRH-35-2000
	Mounting for H-rail	162556	CPV10/14-VI-BG-NRH-35
		163291	CPV18-VI-BG-NRH-35
<b>User's manual</b>			
	CPV Pneumatics Description	German	165100 P.BE-CPV-DE
		English	165200 P.BE-CPV-EN
		French	165130 P.BE-CPV-FR
		Italian	165160 P.BE-CPV-IT
		Spanish	165230 P.BE-CPV-ES
		Swedish	165260 P.BE-CPV-SV

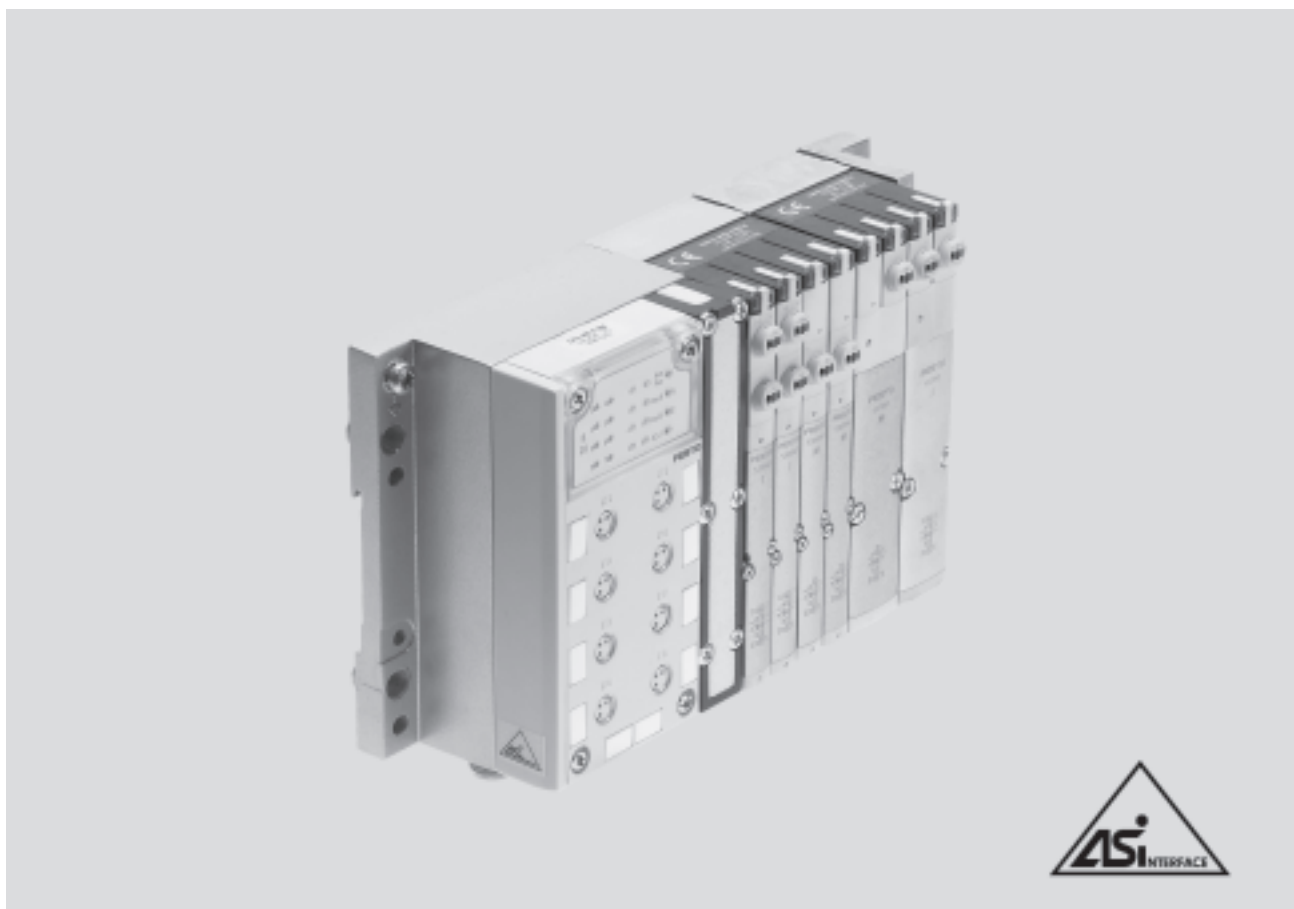

## MPA-S valve terminals with AS-interface – Valve configuration options

MPA valve terminals with AS-interface can be flexibly configured with a wide range of valves. The system supports a maximum of 8 outputs (solenoid coils) and 8 inputs per valve terminal. This gives the following basic valve configuration options (see tables on following page).

### Note

Please follow the link below for more details on the various pneumatic functions.

➔ Internet: mpa-s

### General data

- Solutions with integrated inputs
- Width 10 or 20 mm
- With or without 24 V DC auxiliary power supply for solenoid coils (EMERGENCY-STOP circuitry) in the case of the 4I/40 version. The auxiliary power supply is always integrated in the version with 8 inputs and cannot be subsequently switched off using the DIL switch
- Selectable bus connection technology
  - Flat cable for AS-interface with 4I/40 version
  - 4-pin M12 round plug<sup>1)</sup> with 4I/40 and 8I/80 version
- Selectable addressing
  - Via bus connection (M12 or flat cable)

### Versions

- 2 to 8 valves, freely configurable
- With 4 or 8 inputs
- M12, M8, quick connection, tension spring or Sub-D connection technology
- Separating seals for the creation of pressure zones
- Suitable for vacuum
- Subsequent extensions either
  - via unused valve positions
  - by converting the valve terminal

### Application

- Flexible and cost-effective connection of 2 or 8 valves (max. 8 solenoid coils) with input feedback
- Decentralised machine and system structures, for example
  - in handling technology
  - in conveyor technology
  - in the packaging industry
  - in sorting systems
  - suitable for energy chains thanks to connection via round cables

1) Suitable cable distributor from flat cable to M12 ➔ 40

# AS-interface® components

MPA-S valve terminal – Connection technology and addressing

Types of valve terminal with AS-interface									
Type	Valves	Solenoid coils	Inputs	Conforms to SPEC	Extended addressing range	Auxiliary power supply can be disconnected		Width	
						Yes	No	10 mm	20 mm
VMPPA-ASI-EPL-E-4E4A-Z	4	4	4	2.1	-	■	-	■	■
VMPPA-ASI-EPL-G-4E4A-Z	4	4	4	2.1	-	■	-	■	■
VMPPA-ASI-EPL-EU-4E4A-Z	4	4	4	2.1	-	■	-	■	■
VMPPA-ASI-EPL-GU-4E4A-Z	4	4	4	2.1	-	■	-	■	■
VMPPA-ASI-EPL-E-8E8A-Z	8	8	8	2.1	-	-	■	■	■
VMPPA-ASI-EPL-G-8E8A-Z	8	8	8	2.1	-	-	■	■	■
VMPPA-ASI-EPL-EU-8E8A-Z	8	8	8	2.1	-	-	■	■	■
VMPPA-ASI-EPL-GU-8E8A-Z	8	8	8	2.1	-	-	■	■	■
VMPPA-ASI-EPL-E-8E8A-CE	8	8	8	3.0	■	-	■	■	■
VMPPA-ASI-EPL-G-8E8A-CE	8	8	8	3.0	■	-	■	■	■
VMPPA-ASI-EPL-EU-8E8A-CE	8	8	8	3.0	■	-	■	■	■
VMPPA-ASI-EPL-GU-8E8A-CE	8	8	8	3.0	■	-	■	■	■

Permissible combinations in valve position allocation				
Type	Slave n			
	0	1	2	3
4I/4O MPA1 - only M (up to 4 valves per sub-base)	M	M	M	M
	M	M	M	L
	M	M	L	L
	M	L	L	L
4I/4O MPA2 (2 valves per sub-base)	M	M	M	M
	J	M	-	-
	M	J	-	-
	J	J	-	-

Permissible combinations in valve position allocation								
Type	Slave n plus slave n+1							
	0	1	2	3	4	5	6	7
8I/8O MPA1 (up to 4 valves per sub-base)	M	M	M	M	M	M	M	M
	M	M	M	L	M	M	M	L
	J	J	J	J	-	-	-	-
	...	...	...	...	...	...	...	...
	J	J	J	J	-	-	-	-
	J	J	J	M	-	-	-	-
	J	J	M	M	-	-	-	-
	...	...	...	...	...	...	...	...
	J	J	L	L	-	-	-	-
8I/8O MPA2 (2 valves per sub-base)	M	M	M	M	M	M	M	M
	M	M	M	L	M	M	M	L
	...	...	...	...	...	...	...	...
	J	J	J	J	-	-	-	-
	J	J	J	M	-	-	-	-
	J	J	M	M	-	-	-	-
	...	...	...	...	...	...	...	...
	J	J	M	M	M	M	-	-
	J	J	M	M	M	L	-	-
	...	...	...	...	...	...	...	...
	M	M	M	M	J	J	-	-



# AS-interface® components

MPA-S valve terminal – Connection technology and addressing

## Installation: Selectable connection technology for AS-interface

### Support for flat cables

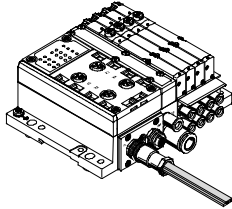

- Straightforward cabling with flat cables in protected areas
- Fast system of installation with standard AS-interface cables
- Standard installation at the AS-interface with yellow flat cables is possible with the 4I/4O MPA-S version

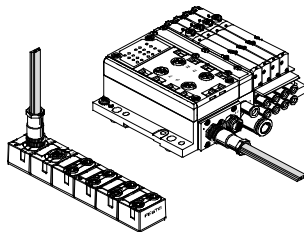

Standard installation at the AS-interface flat cable

### Support for round cables

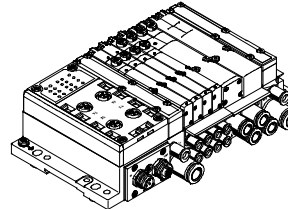

Local round cable wiring system for areas subjected to consistently high stress:

- Permanently high humidity
- Need for flexible cabling using one cable
- Use in energy chains with highly flexible cables

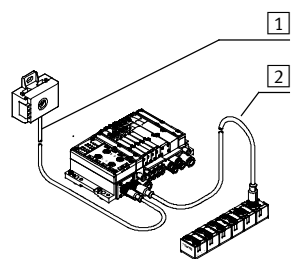

- 1 Pre-assembled M12 round cable, 1 m, polyurethane
- 2 Selectable cable for additional slave, for example highly flexible cable for energy chains or PVC cable for applications requiring resistance to detergents

## Addressing

### Addressing device

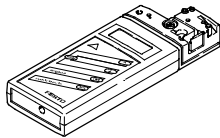

The addressing device to SPEC V2.1 can be used to scan the AS-interface from any point in the network. At all connected stations

- slave addresses can be read/changed
- ID and IO codes can be read out
- parameters can be read/changed
- input/output data can be read and written (setting outputs)
- error messages can be read out and quickly recognised

### AS-interface connections

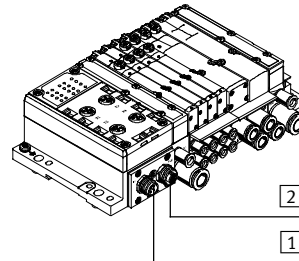

- 1 M12 plug for AS-interface and incoming auxiliary supply
- 2 M12 socket for AS-interface and outgoing auxiliary supply

# AS-interface® components

MPA-S valve terminal – Connection technology and addressing

FESTO

## AS-interface flat cable distributor to round cable

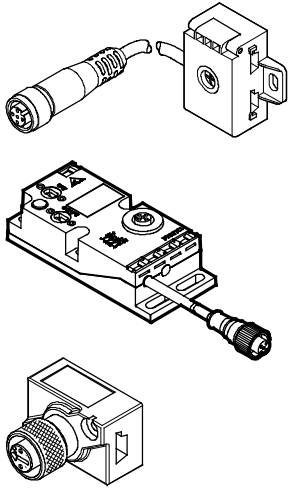

### Alternative connection concepts

- AS-interface connection technology for yellow and optionally for black flat cables
- Passive conversion of the signals to M12 socket and round cable via M12 socket
- Pre-assembled round cable, PUR, 1 m long
- Alternatively PVC extension cable, 2.5 and 5 m, via additional M12 socket

### Selecting the cable

Optimised connection technologies at the AS-interface can be easily realised by selecting the right cable.

- Flat cables for all standard applications with installation-saving insulation displacement technology
- Round cables for applications with differing requirements, for example:
  - Energy chains with small radii and further requirements for highly flexible cables
  - Applications with consistently high humidity

- Applications involving frequent cleaning and requiring cables resistant to detergents (PUR, PVC or other cables)
- Cabling systems using standard components (M12) preferred

### Easy to mount

- Direct mounting on a wall or machine frame
- Direct mounting on the 40 mm ITEM profile
- Mounting on H-rail using adapter CP-TS-HS35

## Supplementary compact I/O modules

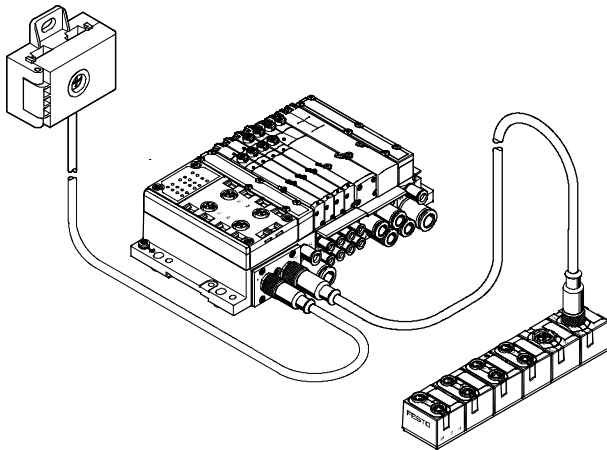

The valve terminals MPA-S can be supplemented with the compact I/O modules. The following are available:

- 8 inputs M8
- 4 inputs/3 outputs M12

# AS-interface® components

Key features – Display and operation

## Display and operation

Each valve solenoid coil is allocated an LED which indicates its signal status.

- Indicator 12 shows the switching status of the coil for output 2
- Indicator 14 shows the switching status of the coil for output 4

### Manual override

The manual override (MO) enables the valve to be actuated when not electrically activated or energised. The valve is activated by pushing the manual override. The set switching status can also be locked by turning

the manual override (code R or as accessory).

Alternatives:

- A cover (code N or as accessory) can be fitted over the manual override to prevent it from being locked. The

manual override can then only be activated by pushing it.

- A cover (code V) can be fitted over the manual override to prevent it from being accidentally activated.

## Pneumatic connection and control elements

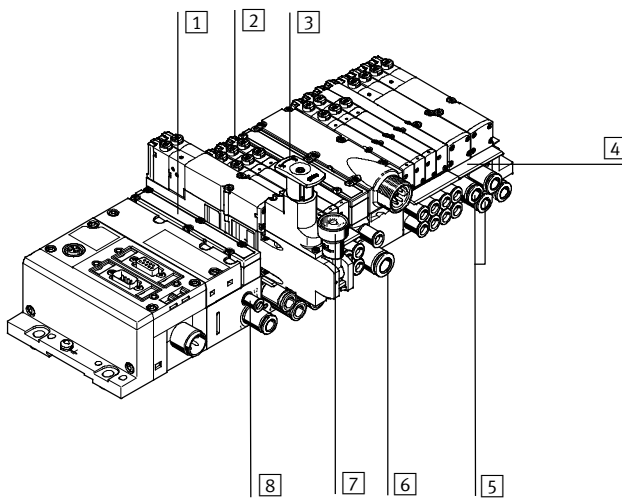

- 1 Flat plate silencer exhaust air 3/5
- 2 Manual override (for each pilot solenoid coil, non-detenting or detenting)
- 3 Adjusting knob for optional pressure regulator plate
- 4 Inscription label holder for sub-base
- 5 Working ports 2 and 4, for each valve position
- 6 Supply port 1
- 7 Pressure gauge (optional)
- 8 Ports 12 and 14 for supplying external pilot air

-  - Note

A manually actuated valve (manual override) cannot be reset electrically. Conversely, an electrically actuated valve cannot be reset using the mechanical manual override.

## Electrical connection and display components AS-interface

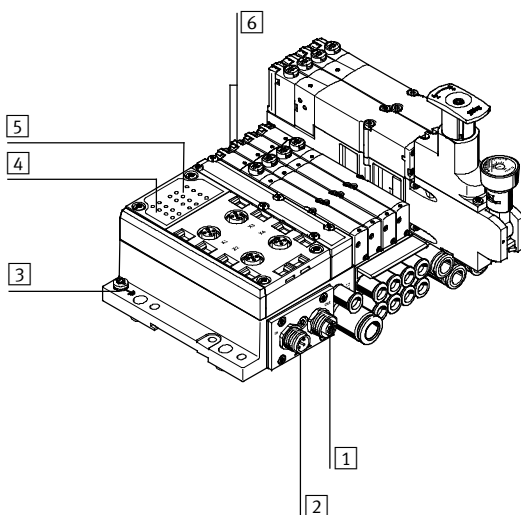

- 1 M12 socket AS-interface bus and additional supply (AS-i Out)
- 2 M12 plug AS-interface bus and additional supply (AS-i In)
- 3 Earth terminal
- 4 Status LEDs inputs
- 5 Status LEDs AS-interface
- 6 Diagnostic LEDs valves

General technical data				
Type	VMPA-...-4E4A-Z		VMPA-...-8E8A-Z	VMPA-...-8E8A-CE
Part No.	Order via order code/valve terminal configurator			
Valves	Number of solenoid coils	4		8
	Valve width [mm]	10/20		
	External power supply 24 V DC	Set using DIL switch		Yes
Inputs	No. of digital inputs	4		8
	Connection technology	5-pin M12, 3-pin M8, Harax, CageClamp, Sub-D		
	Sensor supply via AS-interface	Short circuit and overload proof		
	Sensor connection	2-wire and 3-wire sensors		
	Type	IEC 1131-2, type 02		
	Input circuitry	PNP (positive switching)		
AS-interface connection	Connection technology	M12 connection <sup>2)</sup>		
	Voltage range [V DC]	26.5 ... 31.6, reverse polarity protected		
	Residual ripple [mVss]	20		
	Current consumption of inputs	Without auxiliary power supply	With auxiliary power supply	With auxiliary power supply
	Basic electronic load	≤25	≤25	≤25
	Total input current	350	350	350
Total output current (valves incl. LED) [mA]	MPA1: 270	MPA1: 540	MPA1: 540	
	MPA2: 533	MPA2: 1065	MPA2: 1065	
Load voltage connection	Connection technology	M12 connection <sup>2)</sup>		
	Voltage range [V DC]	21.6 ... 26.4		
	Residual ripple [Vss]	4		
Current consumption of valves per solenoid coil	• Max. starting current (at 24 V) [mA]	MPA1: ≤80 MPA2: ≤100		
	• Following current reduction (approx. 25 ms) [mA]	MPA1: ≤25 MPA2: ≤20		
LED displays	ASI-LED	Green		
	AUX-PWR-LED	Green		
	FAULT-LED	Red		
	Inputs	Green		
	Valves	Yellow		
General data	Protection class (to EN 60529)	IP65 (fully assembled)		
	Temperature range [°C]	Operation: -5 ... +50; storage/transport: -20 ... +40		
	Materials	Die-cast aluminium, PA		
	Note on materials	RoHS-compliant		
	Dimensions	→ 39		
	Weight [g]	360		
AS-interface data	ID code	ID = F <sub>H</sub> ; ID1 = F <sub>H</sub> <sup>1)</sup> ; ID2 = E <sub>H</sub>	ID = F <sub>H</sub> ; ID1 = F <sub>H</sub> <sup>1)</sup> ; ID2 = E <sub>H</sub>	ID = A <sub>H</sub> ; ID1 = F <sub>H</sub> <sup>1)</sup> ; ID2 = E <sub>H</sub>
	IO code	7 <sub>H</sub>	7 <sub>H</sub>	7 <sub>H</sub>
	Profile	S-7.FE	S-7.FE	S-7.AE
	Addressing range	1 ... 31	1 ... 31	1A ... 31A, 1B ... 31B

1) Factory setting, set to 0<sub>H</sub> by some programming devices (Spec. V2.1) when addressing the slave

2) Suitable cable distributor from flat cable to M12 → 40

Certifications	
ATEX category gas	II 3G
Ex-ignition protection type gas	Ex nA II T4 X
ATEX category dust	II 3D
EX-ignition protection type dust	Ex tD A22 IP54 T95°C X
ATEX ambient temperature [°C]	-5 ≤ Ta ≤ +50

Combinations of connection blocks and electronics modules for inputs			
Connection blocks	Part No.	VMPA-...-8E8A	VMPA-...-4E4A
CPX-AB-4-M12X2-5POL	195704	■	■
CPX-AB-8-M8-3POL	195706	■	■
CPX-AB-8-KL-4POL	195708	■	■
CPX-AB-1-SUB-BU-25POL	525676	■	■
CPX-AB-4-HAR-4POL	525636	■	■

Pin allocation					
Connection block inputs		VMPA-...-8E8A		VMPA-...-4E4A	
<b>CPX-AB-4-M12X2-5P-M3</b>					
	 <b>X1</b>	 <b>X3</b>	X1.1: 24 V <sub>SEN</sub> X1.2: Input x+1 X1.3: 0 V <sub>SEN</sub> X1.4: Input x X1.5: FE (earth)	X3.1: 24 V <sub>SEN</sub> X3.2: Input x+5 X3.3: 0 V <sub>SEN</sub> X3.4: Input x+4 X3.5: FE (earth)	X1.1: 24 V <sub>SEN</sub> X1.2: Input x+1 X1.3: 0 V <sub>SEN</sub> X1.4: Input x X1.5: FE (earth)
	 <b>X2</b>	 <b>X4</b>	X2.1: 24 V <sub>SEN</sub> X2.2: Input x+3 X2.3: 0 V <sub>SEN</sub> X2.4: Input x+2 X2.5: FE (earth)	X4.1: 24 V <sub>SEN</sub> X4.2: Input x+7 X4.3: 0 V <sub>SEN</sub> X4.4: Input x+6 X4.5: FE (earth)	X3.1: 24 V <sub>SEN</sub> X3.2: Input x+3 X3.3: 0 V <sub>SEN</sub> X3.4: Input x+2 X3.5: FE (earth)
<b>CPX-AB-8-M8-3P-M3</b>					
	 <b>X1</b>	 <b>X5</b>	X1.1: 24 V <sub>SEN</sub> X1.3: 0 V <sub>SEN</sub> X1.4: Input x	X5.1: 24 V <sub>SEN</sub> X5.3: 0 V <sub>SEN</sub> X5.4: Input x+4	X1.1: 24 V <sub>SEN</sub> X1.3: 0 V <sub>SEN</sub> X1.4: Input x
	 <b>X2</b>	 <b>X6</b>	X2.1: 24 V <sub>SEN</sub> X2.3: 0 V <sub>SEN</sub> X2.4: Input x+1	X6.1: 24 V <sub>SEN</sub> X6.3: 0 V <sub>SEN</sub> X6.4: Input x+5	X5.1: 24 V <sub>SEN</sub> X5.3: 0 V <sub>SEN</sub> X5.4: Input x+2
 <b>X3</b>	 <b>X7</b>	X3.1: 24 V <sub>SEN</sub> X3.3: 0 V <sub>SEN</sub> X3.4: Input x+2	X7.1: 24 V <sub>SEN</sub> X7.3: 0 V <sub>SEN</sub> X7.4: Input x+6	X6.1: 24 V <sub>SEN</sub> X6.3: 0 V <sub>SEN</sub> X6.4: Input x+3	X3.1: 24 V <sub>SEN</sub> X3.3: 0 V <sub>SEN</sub> X3.4: Input x+1
 <b>X4</b>	 <b>X8</b>	X4.1: 24 V <sub>SEN</sub> X4.3: 0 V <sub>SEN</sub> X4.4: Input x+3	X8.1: 24 V <sub>SEN</sub> X8.3: 0 V <sub>SEN</sub> X8.4: Input x+7	X7.1: 24 V <sub>SEN</sub> X7.3: 0 V <sub>SEN</sub> X7.4: Input x+3	X4.1: 24 V <sub>SEN</sub> X4.3: 0 V <sub>SEN</sub> X4.4: n.c.

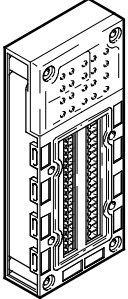
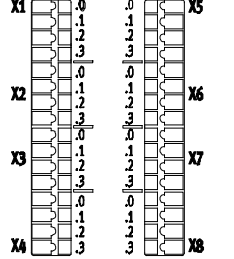
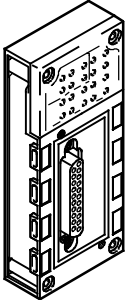
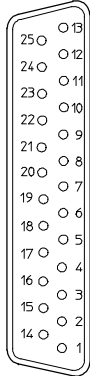
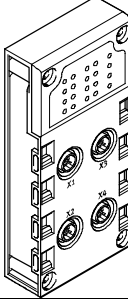
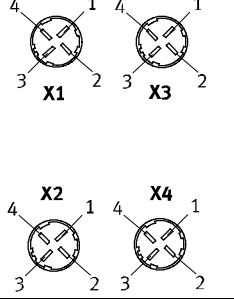
Pin allocation		VMPA-...-8E8A		VMPA-...-4E4A	
Connection block inputs		VMPA-...-8E8A		VMPA-...-4E4A	
<b>CPX-AB-8-KL-4P-M3</b>					
		X1.0: 24 V <sub>SEN</sub> X1.1: 0 V <sub>SEN</sub> X1.2: Input x X1.3: FE (earth)	X5.0: 24 V <sub>SEN</sub> X5.1: 0 V <sub>SEN</sub> X5.2: Input x+4 X5.3: FE (earth)	X1.0: 24 V <sub>SEN</sub> X1.1: 0 V <sub>SEN</sub> X1.2: Input x X1.3: FE (earth)	X5.0: 24 V <sub>SEN</sub> X5.1: 0 V <sub>SEN</sub> X5.2: Input x+2 X5.3: FE (earth)
		X2.0: 24 V <sub>SEN</sub> X2.1: 0 V <sub>SEN</sub> X2.2: Input x+1 X2.3: FE (earth)	X6.0: 24 V <sub>SEN</sub> X6.1: 0 V <sub>SEN</sub> X6.2: Input x+5 X6.3: FE (earth)	X2.0: 24 V <sub>SEN</sub> X2.1: 0 V <sub>SEN</sub> X2.2: Input x+1 X2.3: FE (earth)	X6.0: 24 V <sub>SEN</sub> X6.1: 0 V <sub>SEN</sub> X6.2: Input x+3 X6.3: FE (earth)
		X3.0: 24 V <sub>SEN</sub> X3.1: 0 V <sub>SEN</sub> X3.2: Input x+2 X3.3: FE (earth)	X7.0: 24 V <sub>SEN</sub> X7.1: 0 V <sub>SEN</sub> X7.2: Input x+6 X7.3: FE (earth)	X3.0: 24 V <sub>SEN</sub> X3.1: 0 V <sub>SEN</sub> X3.2: Input x+1 X3.3: FE (earth)	X7.0: 24 V <sub>SEN</sub> X7.1: 0 V <sub>SEN</sub> X7.2: Input x+3 X7.3: FE (earth)
		X4.0: 24 V <sub>SEN</sub> X4.1: 0 V <sub>SEN</sub> X4.2: Input x+3 X4.3: FE (earth)	X8.0: 24 V <sub>SEN</sub> X8.1: 0 V <sub>SEN</sub> X8.2: Input x+7 X8.3: FE (earth)	X4.0: 24 V <sub>SEN</sub> X4.1: 0 V <sub>SEN</sub> X4.2: n.c. X4.3: FE (earth)	X8.0: 24 V <sub>SEN</sub> X8.1: 0 V <sub>SEN</sub> X8.2: n.c. X8.3: FE (earth)
<b>CPX-AB-1-SUB-BU-25P-M3</b>					
		1: Input x 2: Input x+1 3: Input x+2 4: Input x+3 5: 24 V <sub>SEN</sub> 6: 0 V <sub>SEN</sub> 7: 24 V <sub>SEN</sub> 8: 0 V <sub>SEN</sub> 9: 24 V <sub>SEN</sub> 10: 24 V <sub>SEN</sub> 11: 0 V <sub>SEN</sub> 12: 0 V <sub>SEN</sub> 13: FE (earth)	14: Input x+4 15: Input x+5 16: Input x+6 17: Input x+7 18: 24 V <sub>SEN</sub> 19: 24 V <sub>SEN</sub> 20: 24 V <sub>SEN</sub> 21: 24 V <sub>SEN</sub> 22: 0 V <sub>SEN</sub> 23: 0 V <sub>SEN</sub> 24: 0 V <sub>SEN</sub> 25: FE (earth) Socket: FE	1: Input x 2: Input x+1 3: Input x+1 4: n.c. 5: 24 V <sub>SEN</sub> 6: 0 V <sub>SEN</sub> 7: 24 V <sub>SEN</sub> 8: 0 V <sub>SEN</sub> 9: 24 V <sub>SEN</sub> 10: 24 V <sub>SEN</sub> 11: 0 V <sub>SEN</sub> 12: 0 V <sub>SEN</sub> 13: FE (earth)	14: Input x+2 15: Input x+3 16: Input x+3 17: n.c. 18: 24 V <sub>SEN</sub> 19: 24 V <sub>SEN</sub> 20: 24 V <sub>SEN</sub> 21: 24 V <sub>SEN</sub> 22: 0 V <sub>SEN</sub> 23: 0 V <sub>SEN</sub> 24: 0 V <sub>SEN</sub> 25: FE (earth) Socket: FE
<b>CPX-AB-4-HAR-4P-M3</b>					
		X1.1: 24 V <sub>SEN</sub> X1.2: Input x+1 X1.3: 0 V <sub>SEN</sub> X1.4: Input x	X3.1: 24 V <sub>SEN</sub> X3.2: Input x+5 X3.3: 0 V <sub>SEN</sub> X3.4: Input x+4	X1.1: 24 V <sub>SEN</sub> X1.2: Input x+1 X1.3: 0 V <sub>SEN</sub> X1.4: Input x	X3.1: 24 V <sub>SEN</sub> X3.2: Input x+3 X3.3: 0 V <sub>SEN</sub> X3.4: Input x+2
		X2.1: 24 V <sub>SEN</sub> X2.2: Input x+3 X2.3: 0 V <sub>SEN</sub> X2.4: Input x+2	X4.1: 24 V <sub>SEN</sub> X4.2: Input x+7 X4.3: 0 V <sub>SEN</sub> X4.4: Input x+6	X2.1: 24 V <sub>SEN</sub> X2.2: n.c. X2.3: 0 V <sub>SEN</sub> X2.4: Input x+1	X4.1: 24 V <sub>SEN</sub> X4.2: n.c. X4.3: 0 V <sub>SEN</sub> X4.4: Input x+3

# AS-interface<sup>®</sup> components

MPA-S valve terminal – Dimensions

FESTO

## Dimensions

Download CAD data → [www.festo.com](http://www.festo.com)

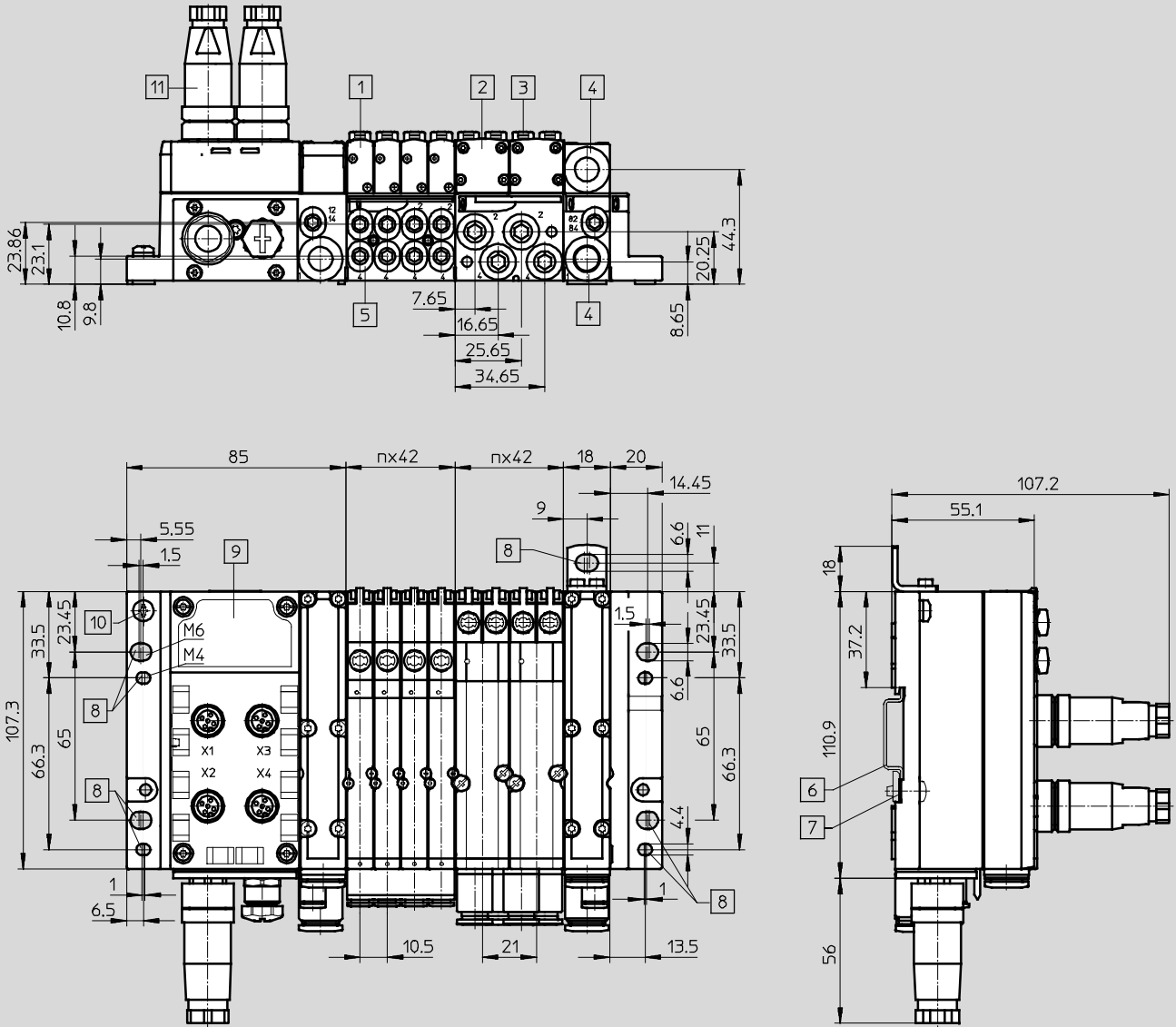

- 1 Solenoid valve MPA1
- 2 Solenoid valve MPA2
- 3 Manual override
- 4 Supply/exhaust ports

- 5 Working ports
- 6 H-rail
- 7 H-rail mounting
- 8 Mounting holes









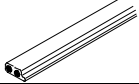

- 9 Connection block
- 10 Earthing screw
- 11 Plug M12

n Number of sub-bases in a grid of 4 MPA1 or 2 MPA2 valves

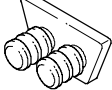
# AS-interface® components

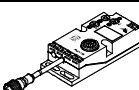
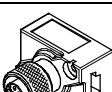
MPA-S valve terminal – Accessories

FESTO

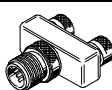







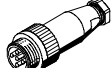

Ordering data				
Description		Part No.	Type	
<b>Bus connection</b>				
	AS-interface flat cable, yellow	100 m	18940	KASI-1,5-Y-100
	AS-interface flat cable, black	100 m	18941	KASI-1,5-Z-100
	Flat cable blanking plug		196090	ASI-SD-FK-BL
	AS-interface flat cable distributor	Parallel cable	18786	ASI-KVT-FK
	AS-interface flat cable distributor	Symmetrical cable	18797	ASI-KVT-FK-S
	Cable cap for flat cable (scope of delivery 50 pieces)		18787	ASI-KK-FK
	Cable sleeve (scope of delivery 20 pieces)		165593	ASI-KT-FK
	M12 socket for flat cable	With PG13.5 connector	18789	ASI-SD-PG-M12
	M12 socket for round cable	With PG9, 5-pin connector	18324	FBSD-GD-9-5POL
<b>Cable distributor</b>				
	AS-Interface data and load voltage supply to 2x socket M12, 4-pin		527474	ASI-KVT-FKx2-M12
	AS-Interface data and load voltage supply to socket M12, 4-pin		18788	ASI-SD-FK-M12
	AS-Interface data to socket M12, 4-pin		572225	NEFU-X22F-M12G4
	AS-Interface data and load voltage supply to socket M12, 4-pin		572226	NEFU-X24F-M12G4
	AS-Interface data and load voltage supply to socket M12, 4-pin, cable length 1 m		572227	NEFU-X24F-1-M12G4
<b>DUO plug</b>				
	Plug M12 for 2 sensor cables	4-pin, PG11	18779	SEA-GS-11-DUO
		5-pin, PG11	192010	SEA-5GS-11-DUO
<b>T-type plug connector</b>				
	Plug M12, 2x socket M12 5-pin		541596	NEDU-M12D5-M12T4
	Plug M8 3-pin, to M12 4-pin		541597	NEDU-M8D3-M12T4



# AS-interface® components

MPA-S valve terminal – Accessories



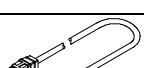
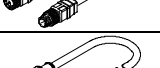



FESTO

Ordering data			
	Description	Part No.	Type
<b>Sensor plugs</b>			
	Straight sensor plug	M12, 4-pin, PG7	18666 SEA-GS-7
	Straight sensor plug	M12, 5-pin, PG7	175487 SEA-M12-5GS-PG7
	Straight sensor plug	M12, PG9 connector	18778 SEA-GS-9
	Straight sensor plug for cable Ø 2.5 mm	M12, 4-pin	192008 SEA-4GS-7-2,5
	Straight sensor plug	M8, screw-in, 3-pin	192009 SEA-3GS-M8-S
	Straight sensor plug	M8, solderable, 3-pin	18696 SEA-GS-M8
	Harax sensor plug	4-pin	525928 SEA-GS-HAR-4POL
	Sub-D plug	25-pin	527522 SD-SUB-D-ST25
	Protective cap (scope of delivery 10 pieces)	M12	165592 ISK-M12
		M8	177672 ISK-M8
<b>Connecting cables</b>			
	Modular system for connecting cables → Internet: nebu	–	NEBU-...
	Connecting cable, straight plug, straight socket	M8, 0.5 m	175488 KM8-M8-GSGD-0,5
		M8, 1.0 m	175489 KM8-M8-GSGD-1
		M8, 2.5 m	165610 KM8-M8-GSGD-2,5
		M8, 5.0 m	165611 KM8-M8-GSGD-5
	Connecting cable, straight plug, straight socket	M12, 4-pin/5-pin, 0.2 m	542129 NEBU-M12G5-F-0.2-M12G4
		M12, 4-pin, 2.5 m	18684 KM12-M12-GSGD-2,5
		M12, 4-pin, 5.0 m	18686 KM12-M12-GSGD-5
	Connecting cable, straight plug, angled socket	M12, 4-pin, 1.0 m	185499 KM12 M12-GSWD-1-4
	DUO cable M12 4-pin via 2xM8, 3-pin	2x straight socket	18685 KM12-DUO-M8-GDGD
		2x straight/angled socket	18688 KM12-DUO-M8-GDWD
		2x angled socket	18687 KM12-DUO-M8-WDWD

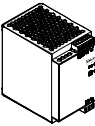
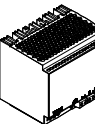
# AS-interface® components

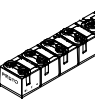
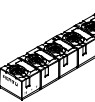
MPA-S valve terminal – Accessories

FESTO

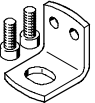
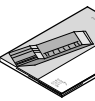
Ordering data		Description	Part No.	Type
<b>Miscellaneous</b>				
	Primary switched mode modular power supply AS-i power supply 4.8 A	547869	SVG-1/230VAC-ASI-5A	
	Primary switched mode modular power supply 24 VDC power supply 5 A	547867	SVG-1/230-24VDC-5A	
	Primary switched mode modular power supply 24 VDC power supply 10 A	547868	SVG-1/230-24VDC-10A	
	Addressing device (power supply plug included in scope of delivery)	18959	ASI-PRG-ADR	
	Addressing cable	18960	KASI-ADR	
	AS-interface input module for 8 inputs M8, compact	542124	ASI-8DI-M8-3POL	
	AS-interface input/output module for 4 inputs/3 outputs M12, compact	542125	ASI-4DI3DO-M12X2-5POL-Z	
	Inscription labels 6x10mm in frames (64pieces)	18576	IBS 6x10	
	Inscription label holder for connection block, transparent, for paper foil label	533362	VMPA1-ST-1-4	
	Inscription label holder for connection block, 4-fold, for IBS 6x10	544384	VMPA1 ST 2-4	
	H-rail to EN 60715	35430	NRH-35-2000	
	H-rail mounting	526032	CPX-CPA-BG-NRH	
	Mounting bracket	534416	VMPA-BG-RW	
<b>User's manual</b>				
	MPA-S Pneumatics Description	German	534240	P.BE-MPA-DE
		English	534241	P.BE-MPA-EN
		French	534243	P.BE-MPA-FR
		Italian	534244	P.BE-MPA-IT
		Spanish	534242	P.BE-MPA-ES
		Swedish	534245	P.BE-MPA-SV

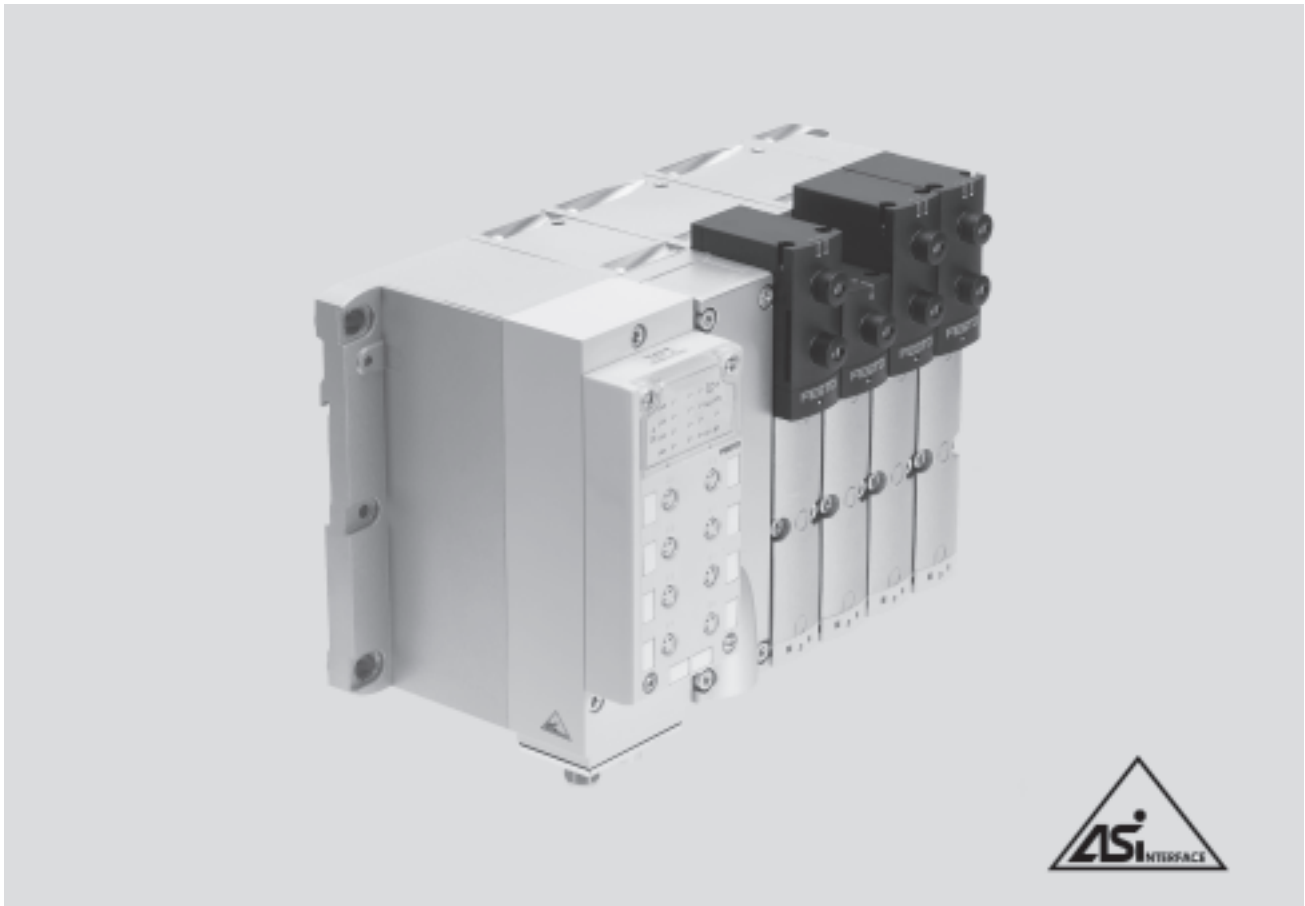

## VTSA/VTSA-F valve terminals with AS-interface – Valve configuration options

VTSA/VTSA-F valve terminals with AS-interface can be flexibly configured with a wide range of valves. The system supports a maximum of 8 outputs (solenoid coils) and 8 inputs per valve terminal. This gives the following basic valve configuration options (see tables on following page).

### Note

Please follow the link below for more details on the various pneumatic functions.

- ➔ Internet: [vtsa](#)
- ➔ Internet: [vtsa-f](#)

### General data

- Solutions with integrated inputs
- Width 18, 26 (VTSA and VTSA-F) and 42, 52 mm (VTSA only)
- With or without 24 V DC auxiliary power supply for solenoid coils (EMERGENCY-STOP circuitry) in the case of the 4I/4O version. The auxiliary power supply is always integrated in the version with 8 inputs and cannot be subsequently switched off using the DIL switch
- Selectable bus connection technology
  - Flat cable for AS-interface with 4I/4O version
  - 4-pin M12 round plug<sup>1)</sup> with 4I/4O and 8I/8O version
- Selectable addressing
  - Via bus connection (M12 or flat cable)

### Versions

- 1 to 8 valves, freely configurable
- With 4 or 8 inputs
- M12, M8, quick connection, tension spring or Sub-D connection technology
- Separating seals for the creation of pressure zones
- Suitable for vacuum
- Subsequent extensions either
  - via vacant positions
  - by converting the valve terminal

### Application

- Flexible and cost-effective connection of 1 or 8 valves (max. 8 solenoid coils) with input feedback
- Decentralised machine and system structures, for example
  - in handling technology
  - in conveyor technology
  - in the packaging industry
  - in sorting systems
  - suitable for energy chains thanks to connection via round cables

1) Suitable cable distributor from flat cable to M12 ➔ 53

# AS-interface® components

VTSA/VTSA-F valve terminal – Connection technology and addressing

Types of valve terminal with AS-interface									
Type	Valves	Solenoid coils	Inputs	Auxiliary power supply can be disconnected		Width (mm)			
				Yes	No	18	26	42 <sup>1)</sup>	52 <sup>1)</sup>
VTSA/VTSA-F-ASI-4E4A-Z	4	4	4	■	–	■	■	■	■
VTSA/VTSA-F-ASI-8E8A-Z	8	8	8	–	■	■	■	■	■

1) Width 42 and 52 mm not in the case of VTSA-F

Permissible combinations in valve position allocation (examples)				
Type	Slave n			
	0	1	2	3
4l/4O VTSA/VTSA-F – 18 and 26 mm (2 valves per sub-base)	M	M	M	M
	M	M	M	L
	M	M	–	–
	M	L	–	–
	...	...	...	...
	J	M	–	–
	M	J	–	–
	J	J	–	–
Special case	M	M	J	L
4l/4O VTSA – 42 mm (1 valve per sub-base)	M	M	M	M
	M	M	M	L
	M	M	–	–
	M	–	–	–
	...	...	...	...
	J	M	–	–
	J	M	M	–
	...	...	...	...
	M	J	M	–
	J	J	–	–

Permissible combinations in valve position allocation (examples)								
Type	Slave n plus slave n+1							
	0	1	2	3	4	5	6	7
8E8A VTSA/VTSA-F	M	M	M	M	M	M	M	M
	M	M	M	L	M	M	M	L
	...	...	...	...	...	...	...	...
	J	J	J	J	–	–	–	–
	J	J	J	M	–	–	–	–
	J	J	M	M	–	–	–	–
	...	...	...	...	...	...	...	...
	J	J	M	M	M	M	–	–
	...	...	...	...	...	...	...	...

- 1) - All valve slices can be freely configured (up to the maximum number of valve solenoids supported (4 or 8)).
- A blanking plate can be used instead of the valve slice as a vacant position for one or two solenoid coils.
- M Valve slice with single solenoid valve or a different valve slice with an output.
- J Valve slice with double solenoid valve or a different valve slice with two outputs.
- L Vacant position

# AS-interface® components

VTSA/VTSA-F valve terminal – Connection technology and addressing

## Installation: Selectable connection technology for AS-interface

### Support for flat cables

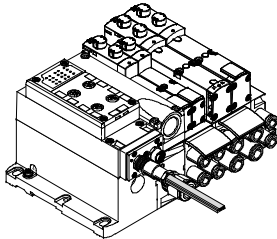

- Straightforward cabling with flat cables in protected areas
- Fast system of installation with standard AS-interface cables
- Standard installation at the AS-interface with yellow flat cables is possible with the 4I/4O VTSA/VTSA-F version

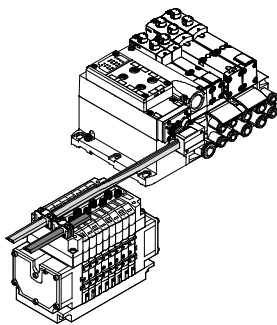

### Support for round cables

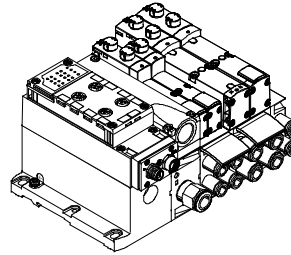

Local round cable wiring system for areas subjected to consistently high stress:

- Permanently high humidity
- Need for flexible cabling using one cable
- Use in energy chains with highly flexible cables

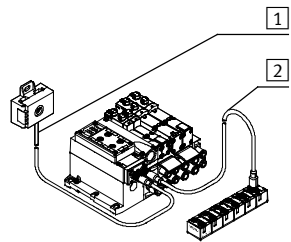

- 1 Pre-assembled M12 round cable, 1 m, polyurethane
- 2 Selectable cable for additional slave, for example highly flexible cable for energy chains or PVC cable for applications requiring resistance to detergents

## Addressing

### Addressing device

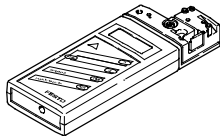

The addressing device to SPEC V2.1 can be used to scan the AS-interface from any point in the network. At all connected stations

- slave addresses can be read/changed
- ID and IO codes can be read out
- parameters can be read/changed
- input/output data can be read and written (setting outputs)
- error messages can be read out and quickly recognised

### AS-interface connections

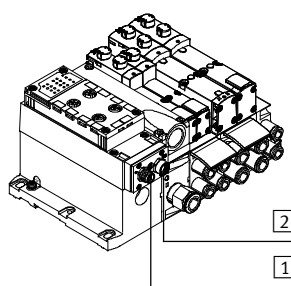

- 1 M12 plug for AS-interface and incoming auxiliary supply
- 2 M12 socket for AS-interface and outgoing auxiliary supply

# AS-interface® components

VTSA/VTSA-F valve terminal – Connection technology and addressing

FESTO

## AS-interface flat cable distributor to round cable 2x M12

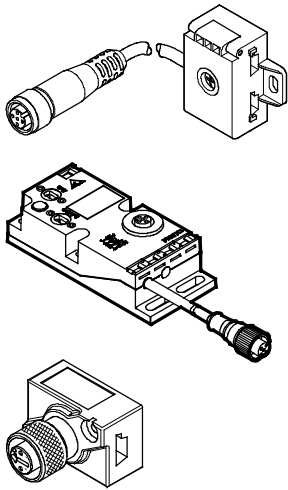

### Alternative connection concepts

- AS-interface connection technology for yellow and optionally for black flat cables
- Passive conversion of the signals to M12 socket and round cable via M12 socket
- Pre-assembled round cable, PUR, 1 m long
- Selectable PVC extension cable, 2.5 and 5 m, via additional M12 socket

### Selecting the cable

Optimised connection technologies at the AS-interface can be easily realised by selecting the right cable.

- Flat cables for all standard applications with installation-saving insulation displacement technology
- Round cables for applications with differing requirements, for example:
  - Energy chains with small radii and further requirements for highly flexible cables
  - Applications with consistently high humidity

- Applications involving frequent cleaning and requiring cables resistant to detergents (PUR, PVC or other cables)
- Cabling systems using standard components (M12) preferred

### Easy to mount

- Direct mounting on a wall or machine frame
- Direct mounting on the 40 mm ITEM profile
- Mounting on H-rail using adapter CP-TS-HS35

## Supplementary compact I/O modules

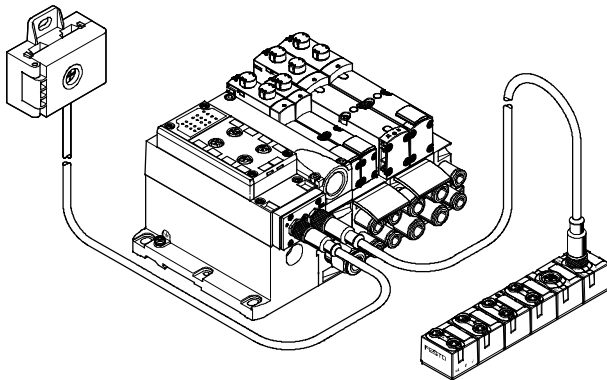

The valve terminals VTSA/VTSA-F can be supplemented with the compact I/O modules. The following are available:

- 8 inputs M8
- 4 inputs/3 outputs M12

# AS-interface® components

Key features – Display and operation

FESTO

## Display and operation

Each solenoid coil is allocated an LED which indicates its switching status.

- Indicator 12 shows the switching status of the pilot control for output 2
- Indicator 14 shows the switching status of the pilot control for output 4

### Manual override

The manual override enables the valve to be actuated when not electrically activated or energised.

The valve is activated by pushing the manual override. The set switching status can also be locked by turning the manual override.

### Alternatives:

- A cover (code N or as accessory) can be fitted over the manual override to prevent it from being locked. The valve can only be actuated by pressing it.

- A cover (code V) can be fitted over the manual override to prevent it from being accidentally activated.

## Pneumatic connection and control elements

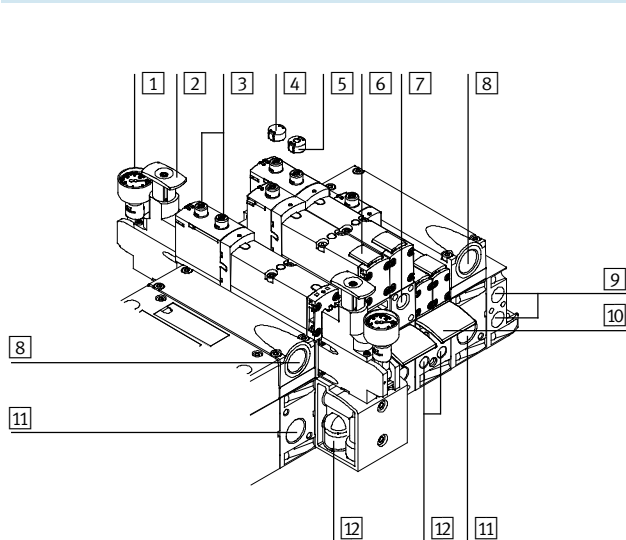

- |  |   |
|--|---|
| <ul style="list-style-type: none"> <li>1 Pressure gauge (optional)</li> <li>2 Adjusting knob for optional pressure regulator plate</li> <li>3 Manual override (for each pilot solenoid coil, non-detenting or detenting)</li> <li>4 Optional cover for manual override (prevents manual override)</li> <li>5 Optional cover for manual override with non-detenting/pushing function</li> <li>6 Inscription label holder for valve</li> <li>7 Adjusting screw of optional flow control plate</li> <li>8 Exhaust ports (valves) (3/5)</li> </ul> | <ul style="list-style-type: none"> <li>9 Pilot ports 12 and 14 for supplying the external pilot air supply</li> <li>10 Inscription label holder for sub-base</li> <li>11 Supply port 1 (operating pressure)</li> <li>12 Working ports 2 and 4, for each valve position</li> </ul> |
|--|---|



### Note

A manually actuated valve (manual override) cannot be reset electrically. Conversely, an electrically actuated valve cannot be reset using the mechanical manual override.

## Electrical connection and display components

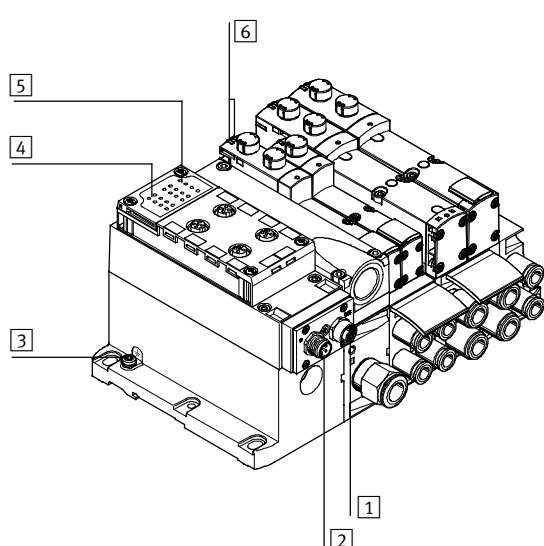

- 1 M12 socket AS-interface bus and additional supply (AS-i Out)
- 2 M12 plug AS-interface bus and additional supply (AS-i In)
- 3 Earth terminal
- 4 Status LEDs inputs
- 5 Status LEDs AS-interface
- 6 Diagnostic LEDs valves

Technical data				
Type	VTSA/VTSA-F-ASI-4E4A-Z		VTSA/VTSA-F-ASI-8E8A-Z	
Part No.	Order via order code/valve terminal configurator			
Assembly position	Any			
Digital inputs	No. of digital inputs	4	8	
	Connection technology	5-pin M12, 3-pin M8, quick connection, tension spring, Sub-D		
	Sensor supply via AS-interface	Short circuit and overload proof		
	Sensor connection	2-wire and 3-wire sensors		
	Type	IEC 1131-2, type 02		
	Input circuitry	PNP (positive switching)		
Valves	Number of solenoid coils	4	8	
	Valve width [mm]	18/26/42/52 (width 42 and 52 mm only in the case of VTSA)		
	External power supply 24 V DC (auxiliary power supply)	Set using DIL switch	Yes	
Max. current consumption of valves per solenoid coil [mA]	90			
AS-interface connection	Connection technology	Plug M12x1, 4-pin; socket M12x1, 4-pin <sup>2)</sup>		
	Voltage range [V DC]	26.5 ... 31.6, reverse polarity protected		
	Residual ripple [mVss]	20		
	Electrical isolation fieldbus interface	Optocoupler		
	Current consumption of inputs [mA]	Without auxiliary power supply	With auxiliary power supply	With auxiliary power supply
	Basic electronic load	≤25	≤25	≤25
	Total input current	350	350	350
	Total current consumption	Max. 500	Max. 700	Max. 700
Load voltage connection	Connection technology	M12 connection <sup>2)</sup>		
	Voltage range [V DC]	21.6 ... 26.4		
	Residual ripple [Vss]	4		
LED displays	ASI-LED	Green		
	AUX-PWR-LED	Green		
	FAULT-LED	Red		
	Inputs	Green		
	Valves	Yellow		
AS-interface data	AS-interface specification	AS-interface Complete Spec 3.0		
	Addressing range Slave	0, 1 ... 31		
	ID code	ID = F <sub>H</sub> ; ID1 = F <sub>H</sub> <sup>1)</sup> ; ID2 = E <sub>H</sub>		
	IO code	7 <sub>H</sub>		
	Profile	S-7.FE		

1) Factory setting, set to 0<sub>H</sub> by some programming devices (Spec. V2.1) when addressing the slave

2) Suitable cable distributor from flat cable to M12 → 53

Operating and environmental conditions	
Protection class (to EN 60529)	IP65, NEMA 4 (in assembled state)
Electromagnetic compatibility	Tested to 50295
CE mark (see declaration of conformity)	To EU EMC Directive
	To EU Low Voltage Directive
Certification	c UL us - Recognized (OL)
	C-Tick
Ambient temperature [°C]	-5 ... +50
Storage temperature [°C]	-20 ... +40
Materials	Housing
	Seals
Note on materials	Die-cast aluminium, PA NBR, PUR
Weight [g]	RoHS-compliant AS-interface connection: 300, multi-pin node: 850



# AS-interface® components

VTSA/VTSA-F valve terminal – Connection blocks



Note

The valve terminal VTSA with AS-interface connection is based on the same electrical manifold module as the valve terminal with multi-pin plug connection. This means it is possible to convert a valve terminal with

multi-pin plug connection using an AS-interface module. The technical specifications of the AS-interface system must be observed in this case.  
 → Internet: vtasa  
 → Internet: vtasa-f

Combinations of connection blocks and electronics modules for inputs			
Connection blocks	Part No.	VTSA/VTSA-F-ASI-8E8A-Z	VTSA/VTSA-F-ASI-4E4A-Z
CPX-AB-4-M12x2-5POL	195704	■	■
CPX-AB-4-M12x2-5POL-R	541254	■	■
CPX-AB-8-KL-4POL	195708	■	■
CPX-AB-1-Sub-BU-25POL	525676	■	■
CPX-AB-4-HAR-4POL	525636	■	■
CPX-AB-8-M8-3POL	195706	■	■

Pin allocation					
Connection block inputs		VTSA/VTSA-F-ASI-8E8A-Z		VTSA/VTSA-F-ASI-4E4A-Z	
CPX-AB-4-M12X2-5POL					
	<p><b>X1</b></p>	<p><b>X3</b></p>	X1.1: 24 V <sub>SEN</sub> X1.2: Input x+1 X1.3: 0 V <sub>SEN</sub> X1.4: Input x X1.5: FE (earth)	X3.1: 24 V <sub>SEN</sub> X3.2: Input x+5 X3.3: 0 V <sub>SEN</sub> X3.4: Input x+4 X3.5: FE (earth)	X1.1: 24 V <sub>SEN</sub> X1.2: Input x+1 X1.3: 0 V <sub>SEN</sub> X1.4: Input x X1.5: FE (earth)
	<p><b>X2</b></p>	<p><b>X4</b></p>	X2.1: 24 V <sub>SEN</sub> X2.2: Input x+3 X2.3: 0 V <sub>SEN</sub> X2.4: Input x+2 X2.5: FE (earth)	X4.1: 24 V <sub>SEN</sub> X4.2: Input x+7 X4.3: 0 V <sub>SEN</sub> X4.4: Input x+6 X4.5: FE (earth)	X3.1: 24 V <sub>SEN</sub> X3.2: Input x+3 X3.3: 0 V <sub>SEN</sub> X3.4: Input x+2 X3.5: FE (earth)
CPX-AB-8-M8-3POL					
	<p><b>X1</b></p>	<p><b>X5</b></p>	X1.1: 24 V <sub>SEN</sub> X1.3: 0 V <sub>SEN</sub> X1.4: Input x	X5.1: 24 V <sub>SEN</sub> X5.3: 0 V <sub>SEN</sub> X5.4: Input x+4	X1.1: 24 V <sub>SEN</sub> X1.3: 0 V <sub>SEN</sub> X1.4: Input x
	<p><b>X2</b></p>	<p><b>X6</b></p>	X2.1: 24 V <sub>SEN</sub> X2.3: 0 V <sub>SEN</sub> X2.4: Input x+1	X6.1: 24 V <sub>SEN</sub> X6.3: 0 V <sub>SEN</sub> X6.4: Input x+5	X2.1: 24 V <sub>SEN</sub> X2.3: 0 V <sub>SEN</sub> X2.4: Input x+1
<p><b>X3</b></p>	<p><b>X7</b></p>	X3.1: 24 V <sub>SEN</sub> X3.3: 0 V <sub>SEN</sub> X3.4: Input x+2	X7.1: 24 V <sub>SEN</sub> X7.3: 0 V <sub>SEN</sub> X7.4: Input x+6	X3.1: 24 V <sub>SEN</sub> X3.3: 0 V <sub>SEN</sub> X3.4: Input x+1	
<p><b>X4</b></p>	<p><b>X8</b></p>	X4.1: 24 V <sub>SEN</sub> X4.3: 0 V <sub>SEN</sub> X4.4: Input x+3	X8.1: 24 V <sub>SEN</sub> X8.3: 0 V <sub>SEN</sub> X8.4: Input x+7	X5.1: 24 V <sub>SEN</sub> X5.3: 0 V <sub>SEN</sub> X5.4: Input x+2 X6.1: 24 V <sub>SEN</sub> X6.3: 0 V <sub>SEN</sub> X6.4: Input x+3 X7.1: 24 V <sub>SEN</sub> X7.3: 0 V <sub>SEN</sub> X7.4: Input x+3 X8.1: 24 V <sub>SEN</sub> X8.3: 0 V <sub>SEN</sub> X8.4: n.c.	

Pin allocation					
Connection block inputs		VTSA/VTSA-F-ASI-8E8A-Z		VTSA/VTSA-F-ASI-4E4A-Z	
<b>CPX-AB-8-KL-4POL</b>					
		X1.0: 24 V <sub>SEN</sub> X1.1: 0 V <sub>SEN</sub> X1.2: Input x X1.3: FE (earth)	X5.0: 24 V <sub>SEN</sub> X5.1: 0 V <sub>SEN</sub> X5.2: Input x+4 X5.3: FE (earth)	X1.0: 24 V <sub>SEN</sub> X1.1: 0 V <sub>SEN</sub> X1.2: Input x X1.3: FE (earth)	X5.0: 24 V <sub>SEN</sub> X5.1: 0 V <sub>SEN</sub> X5.2: Input x+2 X5.3: FE (earth)
		X2.0: 24 V <sub>SEN</sub> X2.1: 0 V <sub>SEN</sub> X2.2: Input x+1 X2.3: FE (earth)	X6.0: 24 V <sub>SEN</sub> X6.1: 0 V <sub>SEN</sub> X6.2: Input x+5 X6.3: FE (earth)	X2.0: 24 V <sub>SEN</sub> X2.1: 0 V <sub>SEN</sub> X2.2: Input x+1 X2.3: FE (earth)	X6.0: 24 V <sub>SEN</sub> X6.1: 0 V <sub>SEN</sub> X6.2: Input x+3 X6.3: FE (earth)
		X3.0: 24 V <sub>SEN</sub> X3.1: 0 V <sub>SEN</sub> X3.2: Input x+2 X3.3: FE (earth)	X7.0: 24 V <sub>SEN</sub> X7.1: 0 V <sub>SEN</sub> X7.2: Input x+6 X7.3: FE (earth)	X3.0: 24 V <sub>SEN</sub> X3.1: 0 V <sub>SEN</sub> X3.2: Input x+1 X3.3: FE (earth)	X7.0: 24 V <sub>SEN</sub> X7.1: 0 V <sub>SEN</sub> X7.2: Input x+3 X7.3: FE (earth)
		X4.0: 24 V <sub>SEN</sub> X4.1: 0 V <sub>SEN</sub> X4.2: Input x+3 X4.3: FE (earth)	X8.0: 24 V <sub>SEN</sub> X8.1: 0 V <sub>SEN</sub> X8.2: Input x+7 X8.3: FE (earth)	X4.0: 24 V <sub>SEN</sub> X4.1: 0 V <sub>SEN</sub> X4.2: n.c. X4.3: FE (earth)	X8.0: 24 V <sub>SEN</sub> X8.1: 0 V <sub>SEN</sub> X8.2: n.c. X8.3: FE (earth)
<b>CPX-AB-1-SUB-BU-25POL</b>					
		1: Input x 2: Input x+1 3: Input x+2 4: Input x+3 5: 24 V <sub>SEN</sub> 6: 0 V <sub>SEN</sub> 7: 24 V <sub>SEN</sub> 8: 0 V <sub>SEN</sub> 9: 24 V <sub>SEN</sub> 10: 24 V <sub>SEN</sub> 11: 0 V <sub>SEN</sub> 12: 0 V <sub>SEN</sub> 13: FE (earth)	14: Input x+4 15: Input x+5 16: Input x+6 17: Input x+7 18: 24 V <sub>SEN</sub> 19: 24 V <sub>SEN</sub> 20: 24 V <sub>SEN</sub> 21: 24 V <sub>SEN</sub> 22: 0 V <sub>SEN</sub> 23: 0 V <sub>SEN</sub> 24: 0 V <sub>SEN</sub> 25: FE (earth) Socket: FE	1: Input x 2: Input x+1 3: Input x+1 4: n.c. 5: 24 V <sub>SEN</sub> 6: 0 V <sub>SEN</sub> 7: 24 V <sub>SEN</sub> 8: 0 V <sub>SEN</sub> 9: 24 V <sub>SEN</sub> 10: 24 V <sub>SEN</sub> 11: 0 V <sub>SEN</sub> 12: 0 V <sub>SEN</sub> 13: FE (earth)	14: Input x+2 15: Input x+3 16: Input x+3 17: n.c. 18: 24 V <sub>SEN</sub> 19: 24 V <sub>SEN</sub> 20: 24 V <sub>SEN</sub> 21: 24 V <sub>SEN</sub> 22: 0 V <sub>SEN</sub> 23: 0 V <sub>SEN</sub> 24: 0 V <sub>SEN</sub> 25: FE (earth) Socket: FE
<b>CPX-AB-4-HAR-4POL</b>					
		X1.1: 24 V <sub>SEN</sub> X1.2: Input x+1 X1.3: 0 V <sub>SEN</sub> X1.4: Input x	X3.1: 24 V <sub>SEN</sub> X3.2: Input x+5 X3.3: 0 V <sub>SEN</sub> X3.4: Input x+4	X1.1: 24 V <sub>SEN</sub> X1.2: Input x+1 X1.3: 0 V <sub>SEN</sub> X1.4: Input x	X3.1: 24 V <sub>SEN</sub> X3.2: Input x+3 X3.3: 0 V <sub>SEN</sub> X3.4: Input x+2
		X2.1: 24 V <sub>SEN</sub> X2.2: Input x+3 X2.3: 0 V <sub>SEN</sub> X2.4: Input x+2	X4.1: 24 V <sub>SEN</sub> X4.2: Input x+7 X4.3: 0 V <sub>SEN</sub> X4.4: Input x+6	X2.1: 24 V <sub>SEN</sub> X2.2: n.c. X2.3: 0 V <sub>SEN</sub> X2.4: Input x+1	X4.1: 24 V <sub>SEN</sub> X4.2: n.c. X4.3: 0 V <sub>SEN</sub> X4.4: Input x+3

# AS-interface® components

VTSA/VTSA-F valve terminal – Dimensions

FESTO

## Dimensions

Download CAD data → [www.festo.com](http://www.festo.com)

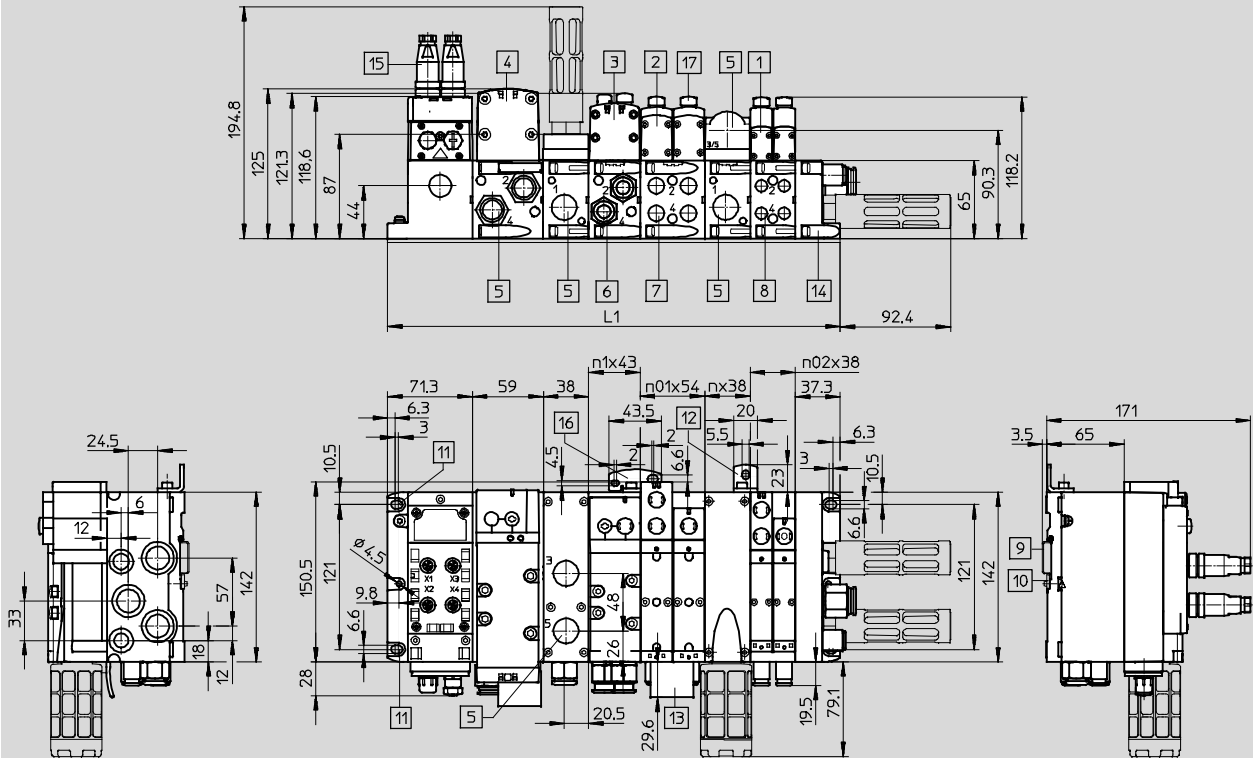

- |  |   |                                |                                     |
|--|---|--------------------------------|-------------------------------------|
| 1 Solenoid valve 18 mm                             | 7 Threaded connection G $\frac{3}{4}$ or 1/4NPT | 12 Additional mounting bracket | n02 Number of manifold blocks 38 mm |
| 2 Solenoid valve 26 mm                             | 8 Threaded connection G $\frac{3}{8}$ or 1/8NPT | 13 Inscription label           | n01 Number of manifold blocks 54 mm |
| 3 Solenoid valve 42 mm (not in the case of VTSA-F) | 9 H-rail  | 14 End plate                   | n1 Number of manifold blocks 43 mm  |
| 4 Solenoid valve 52 mm (not in the case of VTSA-F) | 10 H-rail mounting                              | 15 Plug M12                    | n2 Number of manifold blocks 59 mm  |
| 5 Threaded connection G $\frac{1}{2}$ or 1/2NPT    | 11 Mounting hole                                | 16 Additional mounting bracket | nzwp Number of supply plates        |
| 6 Threaded connection G $\frac{3}{8}$ or 3/8NPT    |   | 17 Cover cap/manual override   |                                     |

Width	L1
18 mm	$71.3 + n02 \times 38 + nzwp \times 38 + 37.3$
26 mm	$71.3 + n01 \times 54 + nzwp \times 38 + 37.3$
42 mm	$71.3 + n1 \times 43 + nzwp \times 38 + 37.3$
52 mm	$71.3 + n2 \times 59 + nzwp \times 38 + 37.3$
Mixture of 18 mm, 26 mm, 42 mm and 52 mm	$71.3 + n02 \times 38 + n01 \times 54 + n1 \times 43 + n2 \times 59 + nzwp \times 38 + 37.3$

# AS-interface® components

VTSA/VTSA-F valve terminal with soft-start valve

FESTO

## Dimensions

Download CAD data → [www.festo.com](http://www.festo.com)

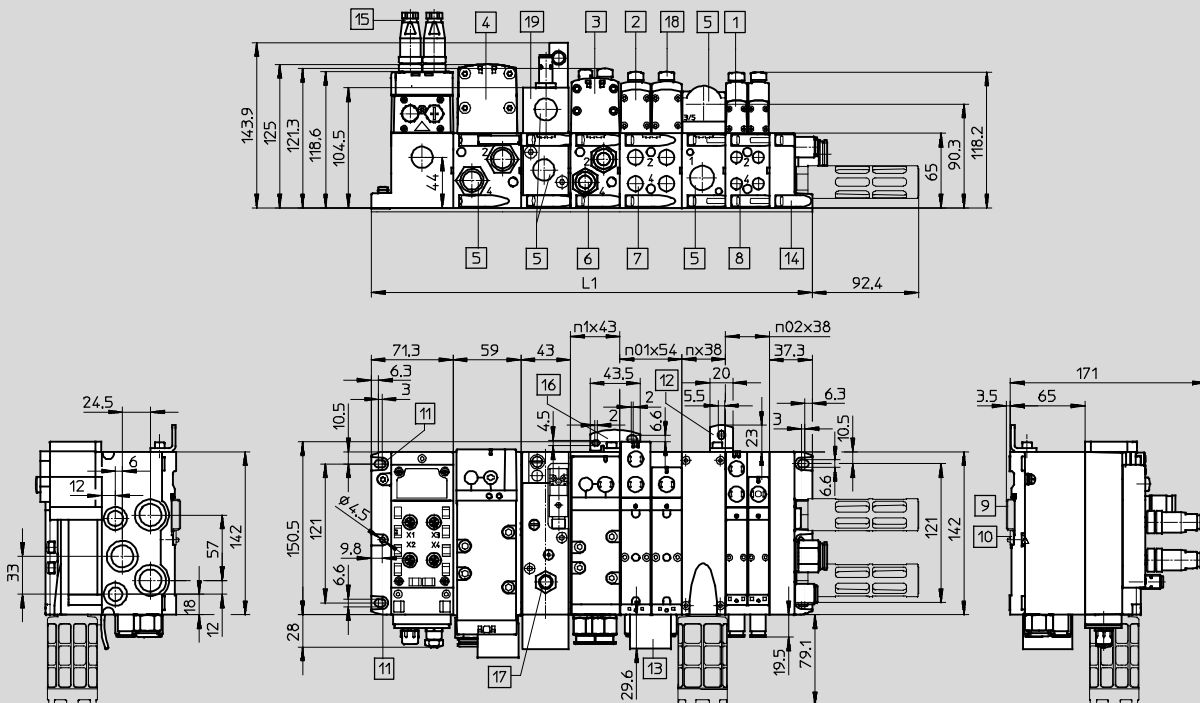











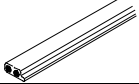

- |  |  |                                |                                     |
|--|--|--------------------------------|-------------------------------------|
| 1 Solenoid valve 18 mm                                     | 7 Threaded connection G $\frac{1}{4}$ or $\frac{1}{4}$ NPT | 14 End plate                   | n02 Number of manifold blocks 38 mm |
| 2 Solenoid valve 26 mm                                     | 8 Threaded connection G $\frac{3}{8}$ or $\frac{1}{8}$ NPT | 15 Plug M12                    | n01 Number of manifold blocks 54 mm |
| 3 Solenoid valve 42 mm (not in the case of VTSA-F)         | 9 H-rail   | 16 Additional mounting bracket | n1 Number of manifold blocks 43 mm  |
| 4 Solenoid valve 52 mm (not in the case of VTSA-F)         | 10 H-rail mounting   | 17 Proximity sensor M12x1      | n2 Number of manifold blocks 59 mm  |
| 5 Threaded connection G $\frac{1}{2}$ or $\frac{1}{2}$ NPT | 11 Mounting hole   | 18 Cover cap/manual override   | nzwp Number of supply plates        |
| 6 Threaded connection G $\frac{3}{8}$ or $\frac{3}{8}$ NPT | 12 Additional mounting bracket                             | 19 Soft-start valve 43 mm      |                                     |
|  | 13 Inscription label                                       |                                |                                     |

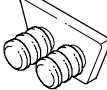
Width	L1
18 mm	$71.3 + n02 \times 38 + nzwp \times 38 + 37.3$
26 mm	$71.3 + n01 \times 54 + nzwp \times 38 + 37.3$
42 mm	$71.3 + n1 \times 43 + nzwp \times 38 + 37.3$
52 mm	$71.3 + n2 \times 59 + nzwp \times 38 + 37.3$
Mixture of 18 mm, 26 mm, 42 mm and 52 mm	$71.3 + n02 \times 38 + n01 \times 54 + n1 \times 43 + n2 \times 59 + nzwp \times 38 + 37.3$

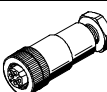
# AS-interface® components

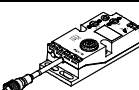
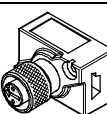
VTSA/VTSA-F valve terminal – Accessories

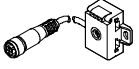

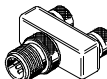







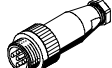

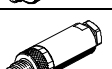
FESTO

Ordering data				
	Description		Part No.	Type
<b>Bus connection</b>				
	AS-interface flat cable, yellow	100 m	18940	KASI-1,5-Y-100
	AS-interface flat cable, black	100 m	18941	KASI-1,5-Z-100
	Flat cable blanking plug		196090	ASI-SD-FK-BL
	AS-interface flat cable distributor	Parallel cable	18786	ASI-KVT-FK
	AS-interface flat cable distributor	Symmetrical cable	18797	ASI-KVT-FK-S
	Cable cap for flat cable (scope of delivery 50 pieces)		18787	ASI-KK-FK
	Cable sleeve (scope of delivery 20 pieces)		165593	ASI-KT-FK
	M12 socket for flat cable	With PG13.5 connector	18789	ASI-SD-PG-M12
	M12 socket for round cable	With PG9, 5-pin connector	18324	FBSD-GD-9-5POL
<b>Cable distributor</b>				
	AS-Interface data and load voltage supply to 2x socket M12, 4-pin		527474	ASI-KVT-FKx2-M12
	AS-Interface data and load voltage supply to socket M12, 4-pin		18788	ASI-SD-FK-M12
	AS-Interface data to socket M12, 4-pin		572225	NEFU-X22F-M12G4
	AS-Interface data and load voltage supply to socket M12, 4-pin		572226	NEFU-X24F-M12G4
	AS-Interface data and load voltage supply to socket M12, 4-pin, cable length 1 m		572227	NEFU-X24F-1-M12G4
<b>DUO plug</b>				
	Plug M12 for 2 sensor cables	4-pin, PG11	18779	SEA-GS-11-DUO
		5-pin, PG11	192010	SEA-5GS-11-DUO
<b>T-type plug connector</b>				
	Plug M12, 2x socket M12 5-pin		541596	NEDU-M12D5-M12T4
	Plug M8, 3-pin, to M12 4-pin		541597	NEDU-M8D3-M12T4

# AS-interface® components

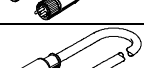
VTSA/VTSA-F valve terminal – Accessories

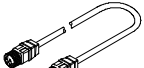





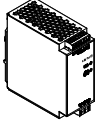
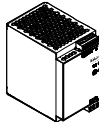
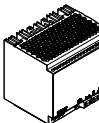

FESTO

Ordering data				
	Description		Part No.	Type
<b>Sensor plugs</b>				
	Straight sensor plug	M12, 4-pin, PG7	18666	SEA-GS-7
	Straight sensor plug	M12, 5-pin, PG7	175487	SEA-M12-5GS-PG7
	Straight sensor plug	M12, PG9 connector	18778	SEA-GS-9
	Straight sensor plug for cable Ø 2.5 mm	M12, 4-pin	192008	SEA-4GS-7-2,5
	Straight sensor plug	M8, screw-in, 3-pin	192009	SEA-3GS-M8-S
	Straight sensor plug	M8, solderable, 3-pin	18696	SEA-GS-M8
	Harax sensor plug	4-pin	525928	SEA-GS-HAR-4POL
	Sub-D plug	25-pin	527522	SD-SUB-D-ST25
	Protective cap (scope of delivery 10 pieces)	M12	165592	ISK-M12
		M8	177672	ISK-M8
<b>Connecting cable</b>				
	Modular system for connecting cables → Internet: nebu		–	NEBU-...
	Connecting cable, straight plug, straight socket	M8, 0.5 m	175488	KM8-M8-GSGD-0,5
		M8, 1.0 m	175489	KM8-M8-GSGD-1
		M8, 2.5 m	165610	KM8-M8-GSGD-2,5
		M8, 5.0 m	165611	KM8-M8-GSGD-5
	Connecting cable, straight plug, straight socket	M12, 4-pin/5-pin, 0.2 m	542129	NEBU-M12G5-F-0.2-M12G4
		M12, 4-pin, 2.5 m	18684	KM12-M12-GSGD-2,5
		M12, 4-pin, 5.0 m	18686	KM12-M12-GSGD-5
	Connecting cable, straight plug, angled socket	M12, 4-pin, 1.0 m	185499	KM12 M12-GSWD-1-4
	DUO cable M12 4-pin via 2xM8, 3-pin	2x straight socket	18685	KM12-DUO-M8-GDGD
		2x straight/angled socket	18688	KM12-DUO-M8-GDWD
		2x angled socket	18687	KM12-DUO-M8-WDWD

# AS-interface® components

VTSA/VTSA-F valve terminal – Accessories

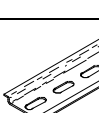
FESTO

Ordering data			
	Description	Part No.	Type
<b>Miscellaneous</b>			
	Primary switched mode modular power supply AS-i power supply 4.8 A	547869	SVG-1/230VAC-ASI-5A
	Primary switched mode modular power supply 24 VDC power supply 5 A	547867	SVG-1/230-24VDC-5A
	Primary switched mode modular power supply 24 VDC power supply 10 A	547868	SVG-1/230-24VDC-10A
	Addressing device (power supply plug included in scope of delivery)	18959	ASI-PRG-ADR
	Addressing cable	18960	KASI-ADR
	AS-interface input module for 8 inputs M8	542124	ASI-8DI-M8-3POL
	AS-interface input/output module for 4 inputs/3 outputs M12	542125	ASI-4DI3DO-M12X2-5POL-Z
	Clip-on inscription label holder for valve cap (pack of 5)	540888	ASCF-T-S6
	Inscription label holder for connection blocks (pack of 5)	540889	ASCF-M-S6
	H-rail to EN 60715	35430	NRH-35-2000
	H-rail mounting	526032	CPX-CPA-BG-NRH
<b>User's manual</b>			
	Description of the valve terminal VTSA/VTSA-F	German	538922 P.BE-VTSA-44-DE
		English	538923 P.BE-VTSA-44-EN
		French	538925 P.BE-VTSA-44-FR
		Italian	538926 P.BE-VTSA-44-IT
		Spanish	538924 P.BE-VTSA-44-ES
		Swedish	538927 P.BE-VTSA-44-SV

# AS-interface® components

Compact I/O modules and valve interfaces to Spec. V2.1

FESTO

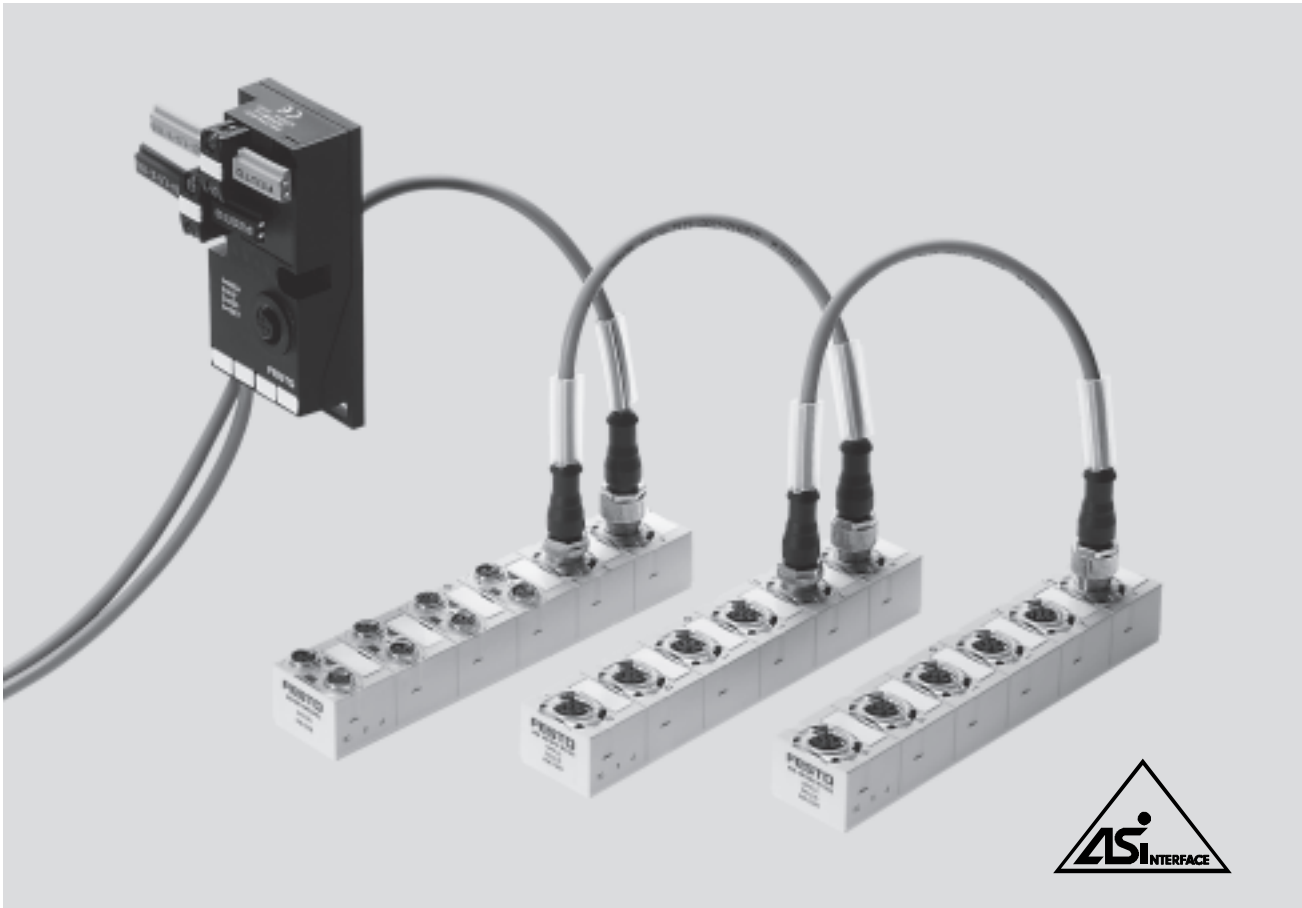

## Compact I/O modules to Spec. V2.1

### General description

- Highly compact modules
- Encapsulated, sturdy electronics
- Inputs/outputs to IEC1131, PNP
- Short circuit proof, overload proof
- Inputs suitable for proximity sensors, inductive, capacitive or optical sensors and light barriers
- Ideal for use in decentralised handling and assembly as well as universal applications with increased requirements
- AS-interface Specification V2.11
- A/B mode
- Bus and auxiliary power supply looped through via 2x M12
- Quick installation
- Individual module diagnostics

### Module with 8 inputs

- Two slaves in one housing
- 8 inputs M8, 3-pin, 200 mA per input
- Peripherals faults per slave, two fault LEDs
- Status display per input
- Supply exclusively from "yellow" AS-interface cable, the pins for the auxiliary power supply are simply looped through
- This permits cascading of the input/output modules

### Module with 4 inputs/3 outputs

- Individual slave
- 4 inputs M12, 5-pin, with double allocation, 200 mA per input
- 3 outputs M12, 5-pin, with double allocation, 1 A per output
- Peripherals fault, fault LED
- Status display for each input and output
- Inputs are supplied exclusively from the "yellow" AS-interface cable
- Outputs are supplied exclusively from the "black" AS-interface cable



# AS-interface® components

Compact I/O modules and valve interfaces

## Applications

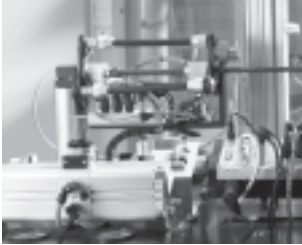

The M12 bus connection standardised in the AS-interface specification offers various advantages:

- Use of standardised, pre-assembled M12 connecting cables
- One cable instead of two
- Installation-saving, quick M12 screw-type lock
- Flexible selection and optimisation of the necessary cable qualities in areas with permanently high stress, for example for

- energy chains
- robot arms (torsion)
- environments with higher moisture content
- aggressive media

This connection technology makes compact modules ideal for use both in demanding and extremely tight conditions.

Decentralised machine and system structures, for example

- Handling technology
- Conveyor technology
- Packaging industry
- Sorting systems
- Upstream functions via energy chains and robot arms

## Tips on use

- In addition to valve terminals for optimising the number of inputs.

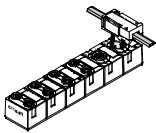

- Suitable for valve terminals with M12 bus connection for looping through the bus via M12

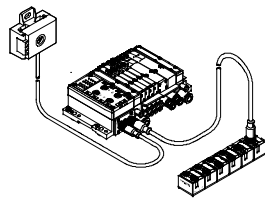

- Universal applications for all commonly used sensors and light barriers up to 200 mA per channel

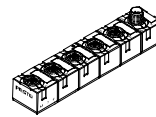

- Universal outputs 1 A, up to 2 A (approx. 50 W) can be connected by means of parallel connection in the DUO plug

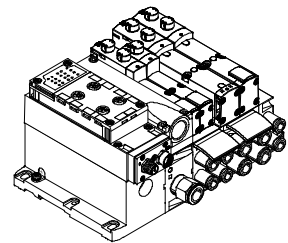

# AS-interface® components

Compact I/O modules and valve interfaces

## AS-interface flat cable distributor to round cable 2x M12

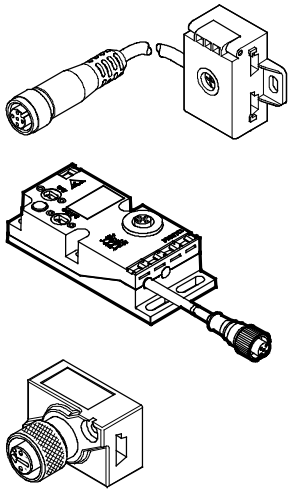

### Alternative connection concepts

- AS-interface connection technology for yellow and optionally for black flat cables
- Passive conversion of the signals to M12 socket and round cable via M12 socket
- Pre-assembled round cable, PUR, 1 m long
- Alternatively PVC extension cable, or another suitable cable of any length, via additional M12 socket

### Selecting the cable

Optimised connection technologies at the AS-interface can be easily achieved by selecting the right cable.

- Flat cables for all standard applications with installation-saving insulation displacement technology
- Round cables for applications with differing requirements, for example:
  - Energy chains with small radii and further requirements for highly flexible cables
  - Applications with consistently high humidity

- Applications involving frequent cleaning and requiring cables resistant to detergents (PUR, PVC or other cables)
- Cabling systems using standard components (M12) preferred

### Easy to fit

- Direct mounting on a wall or machine frame
- Direct mounting on the 40 mm ITEM profile
- Mounting on H-rail using adapter CP-TS-HS35

## Tips on use and installation (inputs/outputs)

### Input module 8DI-M8

Connection technologies based on M8 take account of the increasing trend towards miniaturisation. Sensors with

pre-assembled M8 connecting cables or with M8 plugs can be directly connected in a 1:1 relationship. This

simplifies allocation and troubleshooting. Individual sensors or cables

can be easily and quickly replaced in the event of faults.

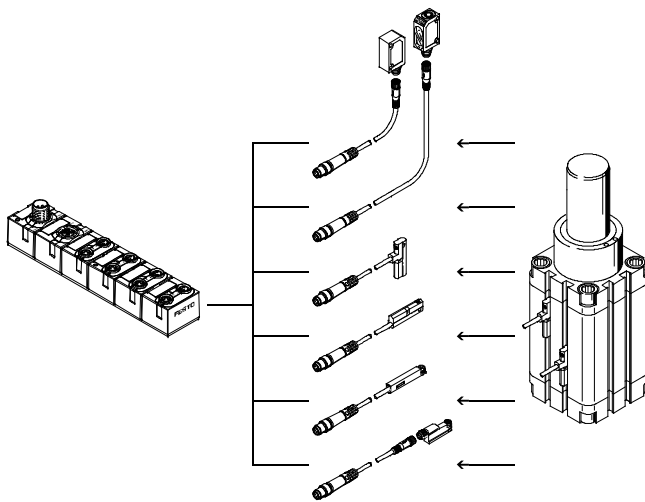

# AS-interface<sup>®</sup> components

Compact I/O modules and valve interfaces

## Tips on use and installation (inputs/outputs)

### Input/output module 4DI3DO-M12

Sturdy M12 connection technology is still an accepted standard for inputs and outputs. Direct connection for sensors with M12 connection. The M12 interfaces with double allocation can be split into 2xM12 or 2xM8 via DUO plugs, DUO cables or T-adapters.

The standard for valves with central plug (EN 60947-5-2 and ISO 20401) defines double allocation for M12 or M8. This means that a double solenoid valve and a single solenoid valve can be directly connected to a

compact AS-interface module using a 1:1 connection. This simplifies allocation and troubleshooting. Individual valves or cables can be easily and quickly replaced in the event of faults.

 Note  
M8 4-pin adapter cables can be configured to M12 5-pin in Festo's modular system for connecting cables (NEBU...) so that even compact valve plugs as in MPA-S can be directly connected via pre-assembled cables.

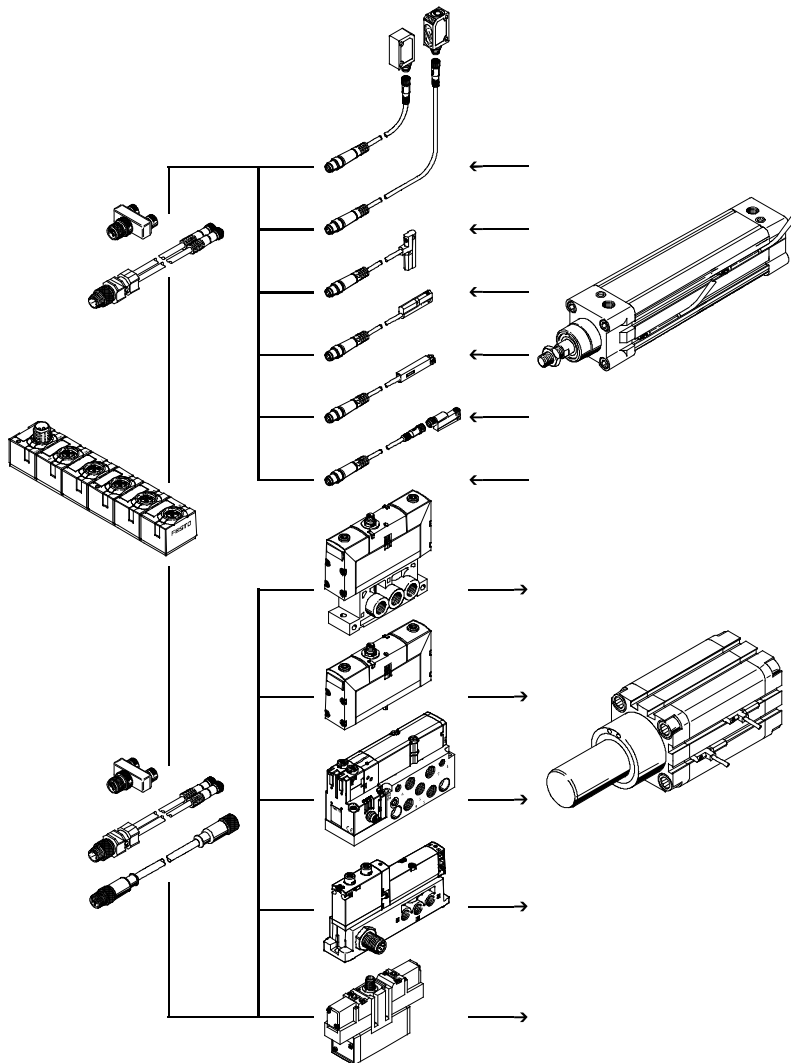

# AS-interface® components

Compact I/O modules and valve interfaces

## Tips on use and installation (AS-interface)

The compact I/O modules feature 4-pin M12 connections for bus IN and bus OUT. As per the AS-interface

specification, the two signal cables for the bus and the optional 24 V DC auxiliary power supply are accommodated

on this one connection. All 4 connections are looped through so that a number of modules and even

subsequent valve terminals can be cascaded.

## Input module 8DI-M8

Supply to the inputs is provided exclusively from the "yellow" AS-interface cable at this module, i.e. the pins for the auxiliary power supply are not used. This means that the following connection technologies can be realised in addition to the connections via M12 round plug connectors:

- Cable distributor NEFU-X2, directly assembled.
- This permits cost-effective and quick connection of a number of directly adjacent modules.
- A transition to valve terminals such as CPV is possible directly and without converters.

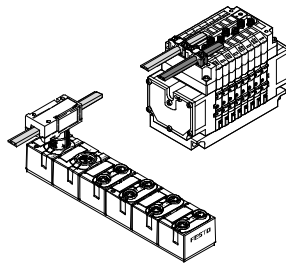

If there is an input module at the end of a string, the flat cable can also be routed through a specially sealed connector.

- Connection socket ASI-SD-PG-M12, directly assembled.
- Use at valve terminals with M12 is also possible, provided the auxiliary power supply is not required.

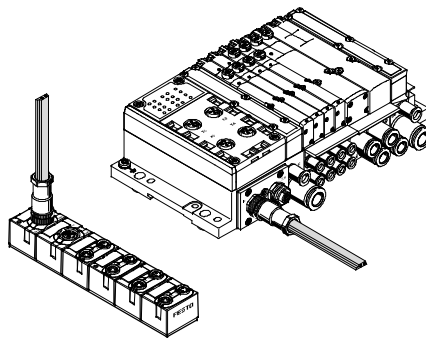

## Input/output module 4DI3DO-M12

Supply to the inputs is provided exclusively from the "yellow" AS-interface cable and supply to the outputs is provided exclusively from the "black" AS-interface cable at this module. Supply is provided either completely by an M12 installation or by means of a suitable converter such as the flat cable distributor NEFU-X24F-M12G4.

**Note**

The contact load capacity of an M12 pin is limited to 4 A. With cascaded modules, ensure that the maximum current load of the first M12 connection in a series will not be exceeded even in a worst case scenario.

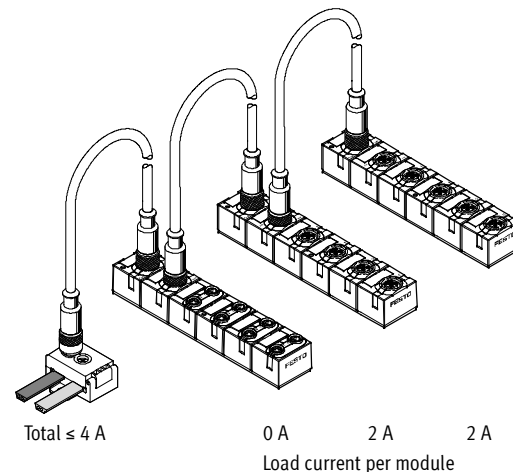

## Voltage drop on cables with M12 connection

Note that the voltage drop on an M12 cross sections. The cable lengths must be sized in accordance with the permissible voltage tolerances for the

AS-interface signal and the outputs for consuming devices with additional load voltage. The following graphs provide an initial orientation (non-linear scaling of the cable length):

Voltage drop U (V) for cable cross section 0.34 mm<sup>2</sup> with M12

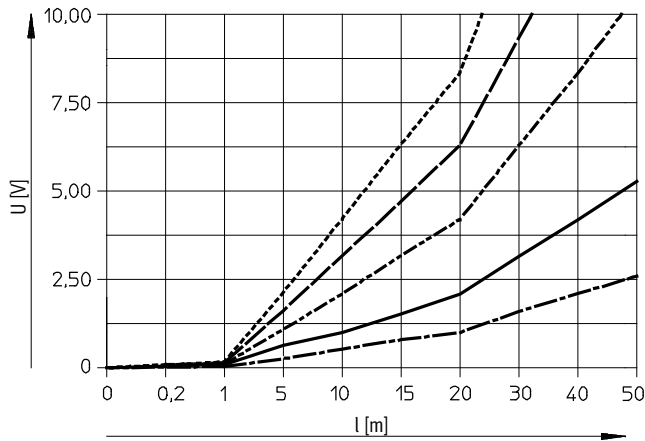

- 0.5 A
- 1 A
- - - - - 2 A
- 3 A
- ..... 4 A

Voltage drop U (V) for cable cross section 0.25 mm<sup>2</sup> with M12

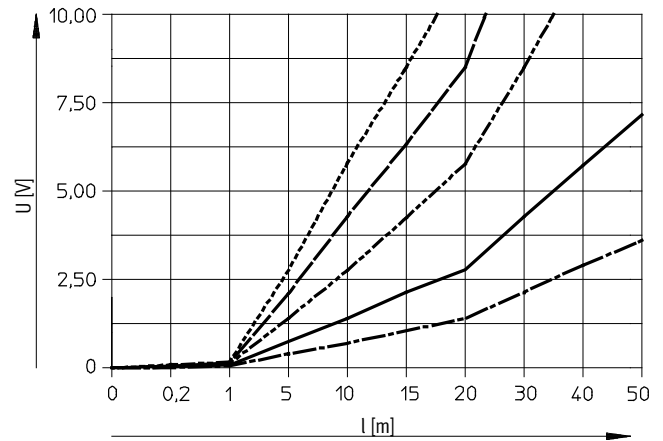

- 0.5 A
- 1 A
- - - - - 2 A
- 3 A
- ..... 4 A

# AS-interface® components

Compact I/O modules and valve interfaces

## Installation

### Installation for consuming devices with high current consumption

If several amperes are to be tapped per module, a suitable supply must be ensured via the corresponding

number of distributors (see the following example). This means that the

max. 3 A per module can be simultaneously switched. Note also that the

voltage drop increases with large currents in the flat cables ( $2 \times 1.5 \text{ mm}^2$ ).

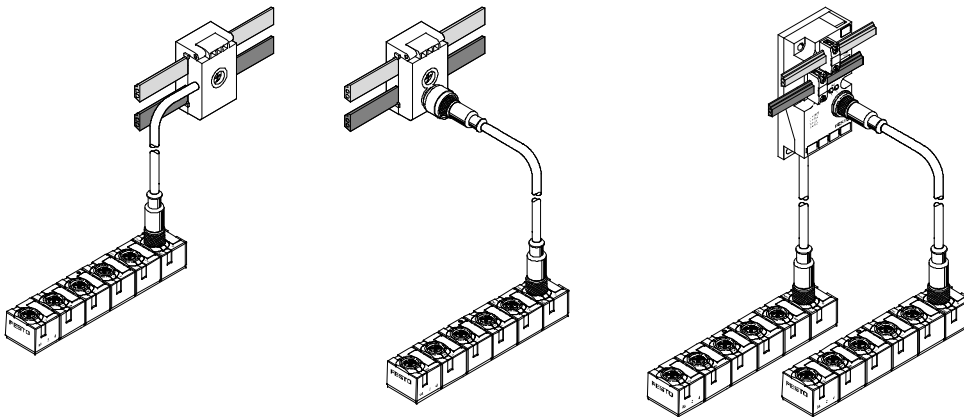

### Alternative M12 installation with branch lines

Installation via branch lines can also be selected for straight M12

installation as an alternative to the looped-through AS-i bus.

The T-adaptor FB-TA-M12-5POL is ideal for this (bus IN: socket, bus OUT:

plug).

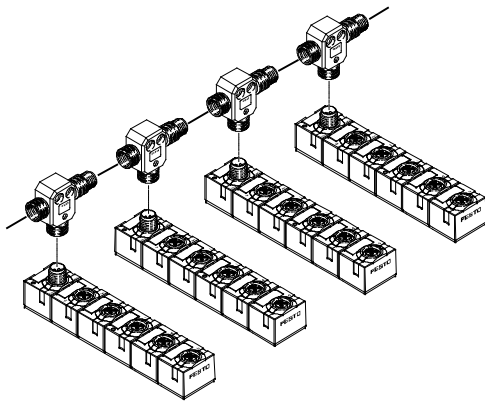

# AS-interface® components

Compact I/O modules and valve interfaces

## Assembly of the compact AS-interface modules

### Wall mounting

The AS-interface modules can be mounted on flat surfaces in almost

any position using the existing mounting holes and two M4 screws.



Note

The modules are protected against short circuit using a thermal fuse. This can result in the housing heating up to over 100 °C with short circuits of long duration.

You should therefore install the modules on a base and in an environment designed for this temperature and which is free of fire risk due to ignition (ATEX category T4 – up to 135°).

### Wall mounting – Compact I/O modules

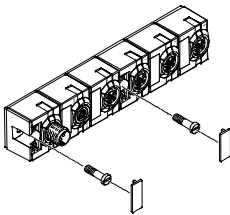

With the compact I/O modules, the mounting holes are covered by inscription labels.

### Mounting on profiles (ITEM, etc.)

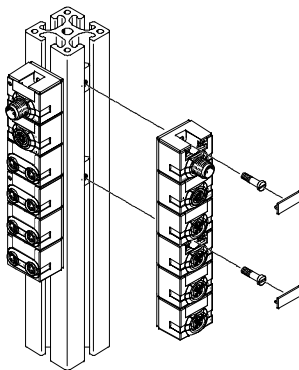

With slot nuts for M4, otherwise see wall mounting.

### H-rail mounting

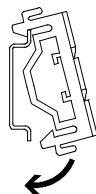
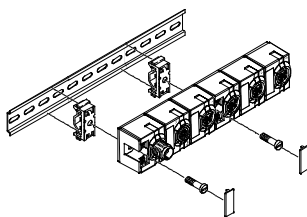

A mounting kit is available that can be used on an H-rail. On the compact CP modules, the mounting holes are covered by inscription labels.

The following mounting kit is required for H-rail mounting:

- CP-TS-HS35
- This enables mounting on H-rails to EN 60715.

# AS-interface® components

Compact I/O modules and valve interfaces

FESTO

## Function

Digital input modules facilitate the connection of proximity sensors or other digital 24 V DC sensors (inductive, capacitive, light barriers, etc.), PNP.

## Applications

- Input module for 24 V DC sensor signals
- Double slave, two slaves in one housing
- M8 plug connection technology, single allocation
- The input status of each input signal is indicated on an allocated green LED
- 24 V DC supply for all connected sensors provided via the ("yellow") AS-interface cable
- Peripherals fault LED for short circuit/undervoltage of sensor supply for each AS-interface slave
- Modules support A/B mode in accordance with Spec. V2.11
- Bus connection 2x M12 for bus in and bus out
- Bus and auxiliary power supply looped through for cascading with output modules



General technical data		
Type	ASI-8DI-M8-3POL	
Digital inputs	No. of inputs	8
	Power supply 24 V DC	From the AS-interface ("yellow" cable)
	Intrinsic current consumption of electronics [mA]	Typically 35 (inputs not connected)
	Input current at 24 V DC (from sensor) [mA]	Typically 6
	Fuse protection for sensors and electronic module	Internal thermal short circuit protection
	Max. current consumption per sensor [A]	0.24
	Max. current consumption of sensor supply, residual current per slave [A]	0.24
	Nominal operating voltage for sensors [V]	24
	Operating voltage range for sensors [V DC]	18 ... 30
	Protection against polarity reversal	For logic and sensor supply and AS-interface
	Electrical separation	
	• between the channels	None
	• to the AS-interface system	None
	Logic level	
	• Signal 0 [V]	≤5
• Signal 1 [V]	≥-11	
Input delay [ms]	Typically 3	
Switching logic	PNP	
Input characteristic curve	To IEC 11 31-2	



# AS-interface® components

Compact I/O modules and valve interfaces

FESTO

General technical data		
Type	ASI-8DI-M8-3POL	
General data	Protection class to EN 60529	IP65/IP67 (when fully plugged in or fitted with protective cap)
	Material	Polybuteneterephthalate
	Dimensions (LxWxD) [mm]	151 x 30 x 30
	Weight [g]	190
LED displays	Inputs	8 green
	AS-interface LED	Power/green
	FAULT-LED (fault 1, fault 2)	Fault LED/red per slave
AS-interface connection/load voltage connection	Connection with the AS-interface	Via M12 connecting cables, 4-wire
	Watchdog function	Active after 50 ms
	Peripherals fault/diagnostics	Short circuit/overload (thermal fuse on each channel) in accordance with specification c.S.2.1, two red fault LEDs Automatic voltage return
	AS-interface bus voltage [V]	26.5 ... 31.6
	Total current consumption of AS-interface [mA]	Max. 350
	Current-carrying capacity of M12 pins (AS-i, AUX) [A]	Max. 4
	AS-interface data	
	• IO code	0 <sub>h</sub>
	• ID code 1	A <sub>h</sub>
	• ID code 2	E <sub>h</sub>
• Profile	S-0.A.E	
AS-interface address (factory setting)	#1A, #2A	
AS-interface specification	2.11 (compatible with 3.0)	

Operating and environmental conditions		
Type	ASI-8DI-M8-3POL	
Protection class to DIN 60529	IP65/IP67 (when fully plugged-in or fitted with protective cover)	
Ambient temperature [°C]	-5 ... +50	
Storage temperature [°C]	-20 ... +70	
Corrosion resistance class CRC <sup>1)</sup>	1	
CE mark (see declaration of conformity)	To EU EMC Directive <sup>2)</sup>	
	To EU Explosion Protection Directive (ATEX)	
Certification	c UL us - Listed (OL)	

- 1) Corrosion resistance class 1 as per Festo standard 940 070  
Components requiring low corrosion resistance. Transport and storage protection. Parts that do not have primarily decorative surface requirements, e.g. in internal areas that are not visible or behind covers.
- 2) For information about the applicability of the component see the manufacturer's EC declaration of conformity at: [www.festo.com](http://www.festo.com) → Support → User documentation.  
If the component is subject to restrictions on usage in residential, office or commercial environments or small businesses, further measures to reduce the emitted interference may be necessary.

Certifications ATEX		
ATEX category gas	II 3G	
Ex-ignition protection type gas	Ex nA IIC T4 X Gc	
ATEX category dust	II 3D	
EX-ignition protection type dust	Ex tc IIIC T115°C X Dc IP67	
ATEX ambient temperature [°C]	-5 ≤ Ta ≤ +50	

 Note

For the operation of device combinations in hazardous areas, the lowest common zone, temperature class and ambient temperature of the individual devices determine the possible use of the entire module.

# AS-interface® components

Compact I/O modules and valve interfaces

## Connection and display components

ASI-8DI-M8-3POL

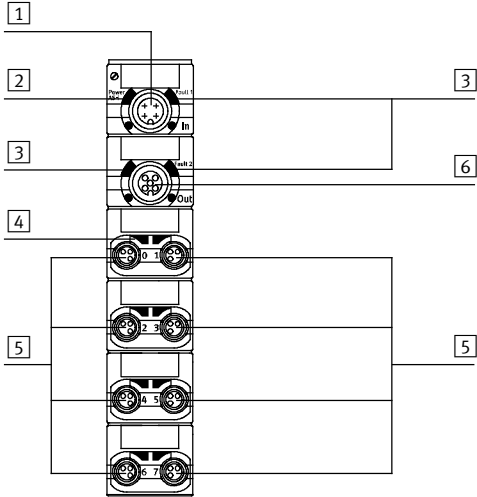

- 1 AS-interface connection, incoming
- 2 Status LED (green)
- 3 Red LED for short circuit/overload display
- 4 Green LED for status display (one LED per input)
- 5 Sensor connections
- 6 AS-interface connection, outgoing

### Pin allocation for sensor connections ASI-8DI-M8-3POL

Pin allocation	Pin	Signal	Description	Pin	Signal
	1	24 V DC	Operating voltage 24 V DC	1	24 V
	3	0 V	Operating voltage 0 V	3	0 V
	4	Ix*	Sensor signal	4	Ix+1*

\* Ix = Input x

# AS-interface® components

Compact I/O modules and valve interfaces

## Function

Combined digital input and output modules permit the connection of proximity sensors or other 24 V DC sensors (inductive, capacitive, etc.) as well as up to 3 consuming devices 24 V DC/1 A. The electrical outputs activate actuators such as individual valves, lamps, signal equipment and many more.

**Note**  
Optimum actuation for valves with M12 central plug.

Plugs with double allocation are separated using a T-adaptor, DUO plug or DUO cable.

## Applications

- Input/output module for 24 V DC sensor signals and actuators, PNP
- Single slave, contains an AS-interface chip
- M12 plug connection technology, 5-pin, double allocation
- Peripherals fault LED for short circuit/undervoltage of sensors or actuators

- Modules support A/B mode in accordance with Spec. V2.11
- Bus connection 2x M12 for bus in and bus out
- Bus and auxiliary power supply looped through for cascading with further output modules
- Inputs:
  - The input status of each input signal is indicated on an allocated green LED
  - 24 V DC supply for all connected sensors provided via the ("yellow") AS-interface cable
- Outputs:
  - The output status of each output signal is indicated on an allocated yellow LED
  - 24 V DC supply for all connected actuators is provided via the ("black") AS-interface cable



General technical data		
Type	ASI-4DI3DO-M12x2-5POL-Z	
Digital inputs	No. of inputs	4
	Power supply 24 V DC	From the AS-interface ("yellow" cable)
	Intrinsic current consumption of electronics [mA]	Typically 35 (inputs not connected)
	Input current at 24 V DC (from sensor) [mA]	Typically 6
	Fuse protection for sensors	Internal thermal short circuit protection
	Max. current consumption per sensor [A]	0.24
	Max. current consumption of sensor supply, residual current per slave [A]	0.25
	Nominal operating voltage for sensors [V]	24
	Operating voltage range for sensors [V DC]	18 ... 30
	Protection against polarity reversal	For logic and sensor supply and AS-interface
	Electrical separation	
	• between the channels	None
	• to the AS-interface system	Yes
	Logic level	
• Signal 0 [V]	≤5	
• Signal 1 [V]	≥-11	
Input delay [ms]	Typically 3	
Switching logic	PNP	
Input characteristic curve	To IEC 1131-2	

General technical data			
Type	ASI-4DI3DO-M12x2-5POL-Z		
Digital outputs	No. of outputs	3	
	Allocation of outputs	Socket 3 with double allocation, socket 4 with single allocation	
	Version of the actuator connection	4x M12, 5-pin	
	Power supply 24 V DC	From the auxiliary power supply, "black" AS-interface cable	
	Max. output current per channel [A]	1.0, 2 outputs can be switched together	
	Operating voltage [V DC]	24 ±25%	
	Fuse protection for power output	Internal thermal short circuit protection for each output	
	Protection against polarity reversal	For actuator supply 24 V/0 V	
	Switching logic	PNP	
	Output characteristic curve	To ICE 11 31-2	
	Electrical separation		
	• between the channels	None	
	• to the AS-interface system	Yes	
	Voltage drop across the output [V]	<1.5	
	Limitation of inductive switch-off voltage [V]	-10 ... -45	
	LED displays		
• Inputs		4 green	
• Outputs	3 yellow		
• AS-interface LED	Power/green		
• AUX-PWR-LED	Auxiliary power supply/green		
• FAULT-LED	Fault LED/red		
General data	Protection class to EN 60529	IP65/IP67 (when fully plugged in or fitted with protective cap)	
	Material	Polybuteneterephthalate	
	Dimensions (LxWxD) [mm]	151 x 30 x 30	
	Weight [g]	165	
AS-interface connection/load voltage connection	Connection with the AS-interface	Via M12 connecting cables, 4-wire	
	Watchdog function	Active after 50 ms	
	Peripherals fault/diagnostics	Short circuit/overload (thermal fuse on each channel) in accordance with specification C.S.2.1, two red fault LEDs Automatic voltage return	
	AS-interface bus voltage [V]	26.5 ... 31.6	
	Total current consumption of AS-interface [mA]	Max. 250	
	Current-carrying capacity of M12 pins (AS-interface, AUX) [A]	Max. 4	
	AS-interface data		
		• IO code	7 <sub>h</sub>
		• ID code 1	A <sub>h</sub>
		• ID code 2	2 <sub>h</sub>
	• Profile	S-7.A.2	
AS-interface address (factory setting)	#0A		
AS-interface specification	2.11 (compatible with 3.0)		

Operating and environmental conditions	
Type	ASI-4DI3DO-M12x2-5POL-Z
Protection class to DIN 60529	IP65/IP67 (when fully plugged-in or fitted with protective cover)
Ambient temperature [°C]	-5 ... +50
Storage temperature [°C]	-20 ... +70
Corrosion resistance class CRC <sup>1)</sup>	1
CE mark (see declaration of conformity)	To EU EMC Directive <sup>2)</sup> To EU Explosion Protection Directive (ATEX)
Certification	c UL us - Listed (OL)
Note on materials	Conforms to RoHS
Paint-wetting impairment substances criterion	PWIS-free

- 1) Corrosion resistance class 1 as per Festo standard 940 070  
Components requiring low corrosion resistance. Transport and storage protection. Parts that do not have primarily decorative surface requirements, e.g. in internal areas that are not visible or behind covers.
- 2) For information about the applicability of the component see the manufacturer's EC declaration of conformity at: [www.festo.com](http://www.festo.com) → Support → User documentation.  
If the component is subject to restrictions on usage in residential, office or commercial environments or small businesses, further measures to reduce the emitted interference may be necessary.

Certifications ATEX	
ATEX category gas	II 3G
Ex-ignition protection type gas	Ex nA IIC T4 X Gc
ATEX category dust	II 3D
EX-ignition protection type dust	Ex tc IIIC T115°C X Dc IP67
ATEX ambient temperature [°C]	-5 ≤ Ta ≤ +50

 Note

For the operation of device combinations in hazardous areas, the lowest ambient temperature of the common zone, temperature class and individual devices determine the possible use of the entire module.

## Connection and display components

ASI-4DI3DO-M12x2-5POL-Z

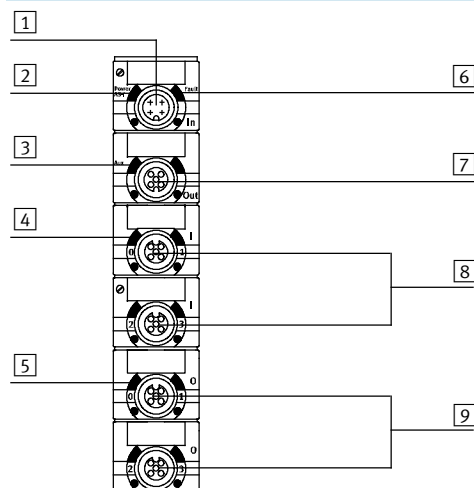

- 1 AS-interface connection, incoming
- 2 Status LED (green)
- 3 Green LED for load voltage display
- 4 Green LED for status display (one LED per input)
- 5 Yellow LED for status display (one LED per output)
- 6 Red LED for short circuit/overload display
- 7 AS-interface connection, outgoing
- 8 Sensor connections
- 9 Outputs

### Pin allocation for sensor connections ASI-4DI3DO-M12X2-5POL-Z

Pin allocation	Pin	Signal	Description
	1	24 V DC	Operating voltage 24 V DC
	2	Ix*+1	Sensor signal
	3	0 V	Operating voltage 0 V
	4	Ix*	Sensor signal
	5	Earth	Earth terminal

\* Ix = Input x

### Pin allocation for outputs ASI-4DI3DO-M12X2-5POL-Z

Pin allocation	Outputs 1 and 2			Output 3		
	Pin	Signal	Description	Pin	Signal	Description
	1	n.c.	Not connected	1	n.c.	Not connected
	2	Ox*+1	Output	2	n.c.	Not connected
	3	0 V	Operating voltage 0 V	3	0 V	Operating voltage 0 V
	4	Ox*	Output	4	Ox*+2	Output
	5	Earth	Earth terminal	5	Earth	Earth terminal

\* Ox = Output

### Dimensions

Download CAD data → [www.festo.com](http://www.festo.com)

#### ASI-8DI-M8-3POL

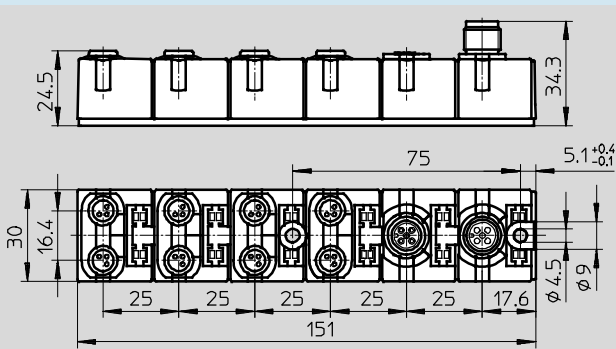

#### ASI-4DI3DO-M12x2-5POL-Z

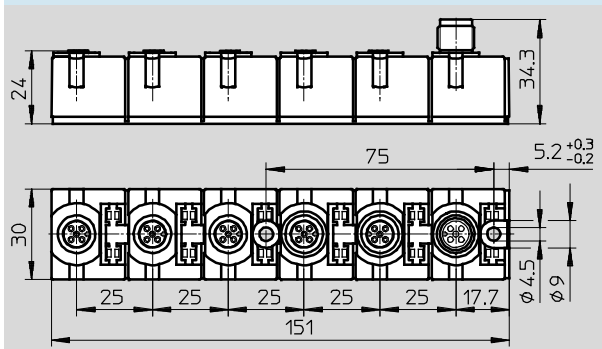

# AS-interface® components

Compact I/O modules and valve interfaces

## Dimensions

Download CAD data → [www.festo.com](http://www.festo.com)

### NEBV-B2W3P-F-...-M12G5

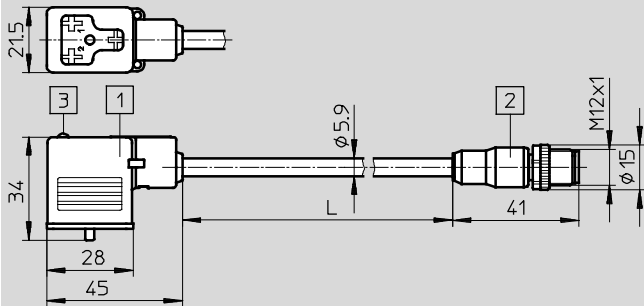

- 1 Socket type BI
- 2 Straight plug M12
- 3 LED illuminated area

	L [m]
NEBV-B2W3P-F-0,5-M12G5	0.5
NEBV-B2W3P-F-2,5-M12G5	2.5

### NEBV-C1W3P-F-...-M12G5

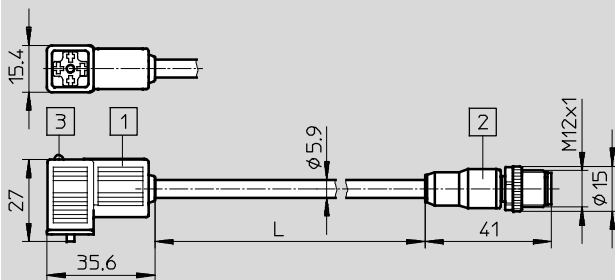

- 1 Socket type C
- 2 Straight plug M12
- 3 LED illuminated area

	L [m]
NEBV-C1W3P-F-0,5-M12G5	0.5
NEBV-C1W3P-F-2,5-M12G5	2.5

### NEBV-Z2W2P-...-M12G5

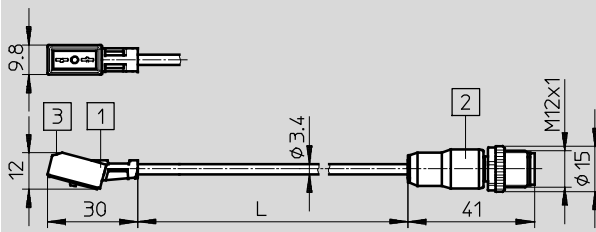

- 1 Socket KMYZ-9
- 2 Straight plug M12
- 3 LED illuminated area

	L [m]
NEBV-Z2W2P-F-0,5-M12G5	0.5
NEBV-Z2W2P-F-2,5-M12G5	2.5

# AS-interface® components

Compact I/O modules and valve interfaces

FESTO

## Dimensions

Download CAD data → [www.festo.com](http://www.festo.com)

### NEDU-M8D3-M12T4

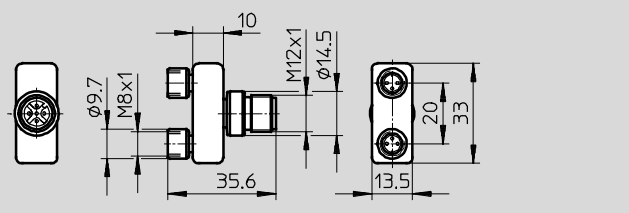

### NEDU-M12D5-M12T5

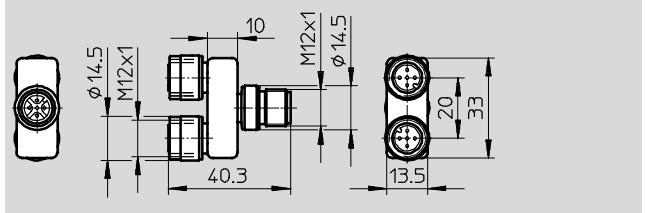

### NEBU-M12G5-F-0,2-M12G4

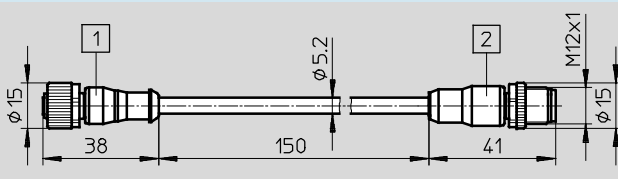







- 1 Straight socket M12
- 2 Straight plug M12

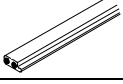

# AS-interface® components

Compact I/O modules and valve interfaces – Accessories

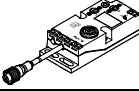
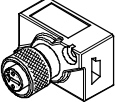

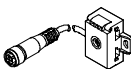
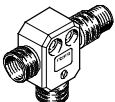
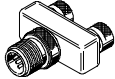



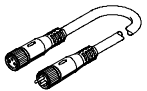
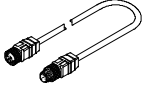
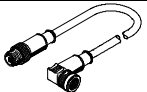
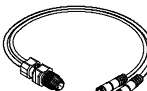
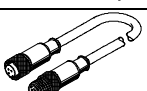
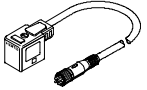
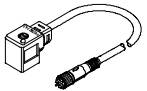
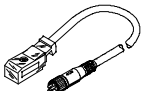

FESTO

Ordering data				
	Description		Part No.	Type
<b>Bus connection</b>				
	AS-interface flat cable, yellow	100 m	18940	KASI-1,5-Y-100
	AS-interface flat cable, black	100 m	18941	KASI-1,5-Z-100
	Cable cap for flat cable (scope of delivery 50 pieces)		18787	ASI-KK-FK
	Cable sleeve (scope of delivery 20 pieces)		165593	ASI-KT-FK
	M12 socket for flat cable	With PG13.5 connector	18789	ASI-SD-PG-M12
<b>Cable distributor</b>				
	AS-Interface data and load voltage supply to 2x socket M12, 4-pin		527474	ASI-KVT-FKx2-M12
	AS-Interface data and load voltage supply to socket M12, 4-pin		18788	ASI-SD-FK-M12
	AS-Interface data to socket M12, 4-pin		572225	NEFU-X22F-M12G4
	AS-Interface data and load voltage supply to socket M12, 4-pin		572226	NEFU-X24F-M12G4
	AS-Interface data and load voltage supply to socket M12, 4-pin, cable length 1 m		572227	NEFU-X24F-1-M12G4
<b>T-type plug connector</b>				
	T-adapter for DH-485, M12 5-pin		171175	FB-TA-M12-5POL
	Plug M12, 2x socket M12 5-pin		541596	NEDU-M12D5-M12T4
	Plug M8, 3-pin, to M12 4-pin		541597	NEDU-M8D3-M12T4

# AS-interface® components

Compact I/O modules and valve interfaces – Accessories



FESTO

Ordering data				
Description		Part No.	Type	
<b>Connecting cables</b>				
	Modular system for connecting cables → Internet: nebu	–	NEBU-...	
	Connecting cable, straight plug, straight socket	M12, 4-pin/5-pin, 0.2 m	542129	NEBU-M12G5-F-0.2-M12G4
		M12, 4-pin, 2.5 m	18684	KM12-M12-GSGD-2,5
		M12, 4-pin, 5.0 m	18686	KM12-M12-GSGD-5
	Connecting cable, straight plug, angled socket	M12, 4-pin, 1.0 m	185499	KM12 M12-GSWD-1-4
	DUO cable M12 4-pin via 2xM8, 3-pin	2x straight socket	18685	KM12-DUO-M8-GDGD
		2x straight/angled socket	18688	KM12-DUO-M8-GDWD
		2x angled socket	18687	KM12-DUO-M8-WDWD
	Connecting cable, straight plug, straight socket	M8, 0.5 m	175488	KM8-M8-GSGD-0,5
		M8, 1.0 m	175489	KM8-M8-GSGD-1
		M8, 2.5 m	165610	KM8-M8-GSGD-2,5
		M8, 5.0 m	165611	KM8-M8-GSGD-5
<b>Connecting cables for individual valve interfaces</b>				
	Connecting cable, straight plug, angled socket type B for F coil	M12, straight, 5-pin, 0.5 m	542130	NEBV-B2W3P-F-0,5-M12G5
		M12, straight, 5-pin, 2.5 m	542133	NEBV-B2W3P-F-2,5-M12G5
	Connecting cable, straight plug, angled socket type C for EB coil	M12, straight, 5-pin, 0.5 m	542131	NEBV-C1W3P-F-0,5-M12G5
		M12, straight, 5-pin, 2.5 m	542134	NEBV-C1W3P-F-2,5-M12G5
	Connecting cable, straight plug, angled socket type KMYZ-9 for ZC coil	M12, straight, 5-pin, 0.5 m	542132	NEBV-Z2W2P-0,5-M12G5
		M12, straight, 5-pin, 2.5 m	542135	NEBV-Z2W2P-2,5-M12G5
<b>DUO plugs</b>				
	Plug M12 for 2 sensor cables	4-pin, PG11	18779	SEA-GS-11-DUO
		5-pin, PG11	192010	SEA-5GS-11-DUO
<b>Sensor plugs</b>				
	Straight sensor plug	M12, 5-pin, PG7	175487	SEA-M12-5GS-PG7
	Straight sensor plug	M12, 4-pin, PG7	18666	SEA-GS-7
	Straight sensor plug	M12, PG9, 4-pin	18778	SEA-GS-9
	Straight sensor plug for cable Ø 2.5 mm	M12, 4-pin	192008	SEA-4GS-7-2,5
	Straight sensor plug	M8, screw-in, 3-pin	192009	SEA-3GS-M8-S
	Straight sensor plug	M8, solderable, 3-pin	18696	SEA-GS-M8
	Protective cap (scope of delivery 10 pieces)	M12	165592	ISK-M12
		M8	177672	ISK-M8

# AS-interface® components

Compact I/O modules and valve interfaces – Accessories

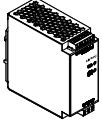
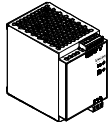
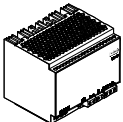
FESTO

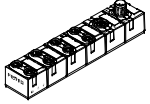
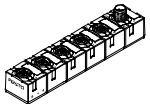
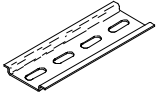
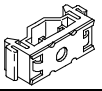
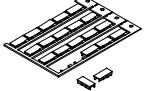
Ordering data			
	Description	Part No.	Type
<b>Miscellaneous</b>			
	Primary switched mode modular power supply AS-i power supply 4.8 A	547869	SVG-1/230VAC-ASI-5A
	Primary switched mode modular power supply 24 VDC power supply 5 A	547867	SVG-1/230-24VDC-5A
	Primary switched mode modular power supply 24 VDC power supply 10 A	547868	SVG-1/230-24VDC-10A
	Addressing device (power supply plug included in scope of delivery)	18959	ASI-PRG-ADR
	Addressing cable	18960	KASI-ADR
<b>I/O modules</b>			
	AS-interface input module for 8 inputs M8	542124	ASI-8DI-M8-3POL
	AS-interface input/output module for 4 inputs/3 outputs M12	542125	ASI-4DI3DO-M12X2-5POL-Z
<b>Mountings</b>			
	H-rail to EN 60715	35430	NRH-35-2000
	Mounting for H-rail	170169	CP-TS-HS35
<b>Inscription labels</b>			
	Inscription labels 8x20 mm in frames (20 pieces)	539388	IBS-8x20

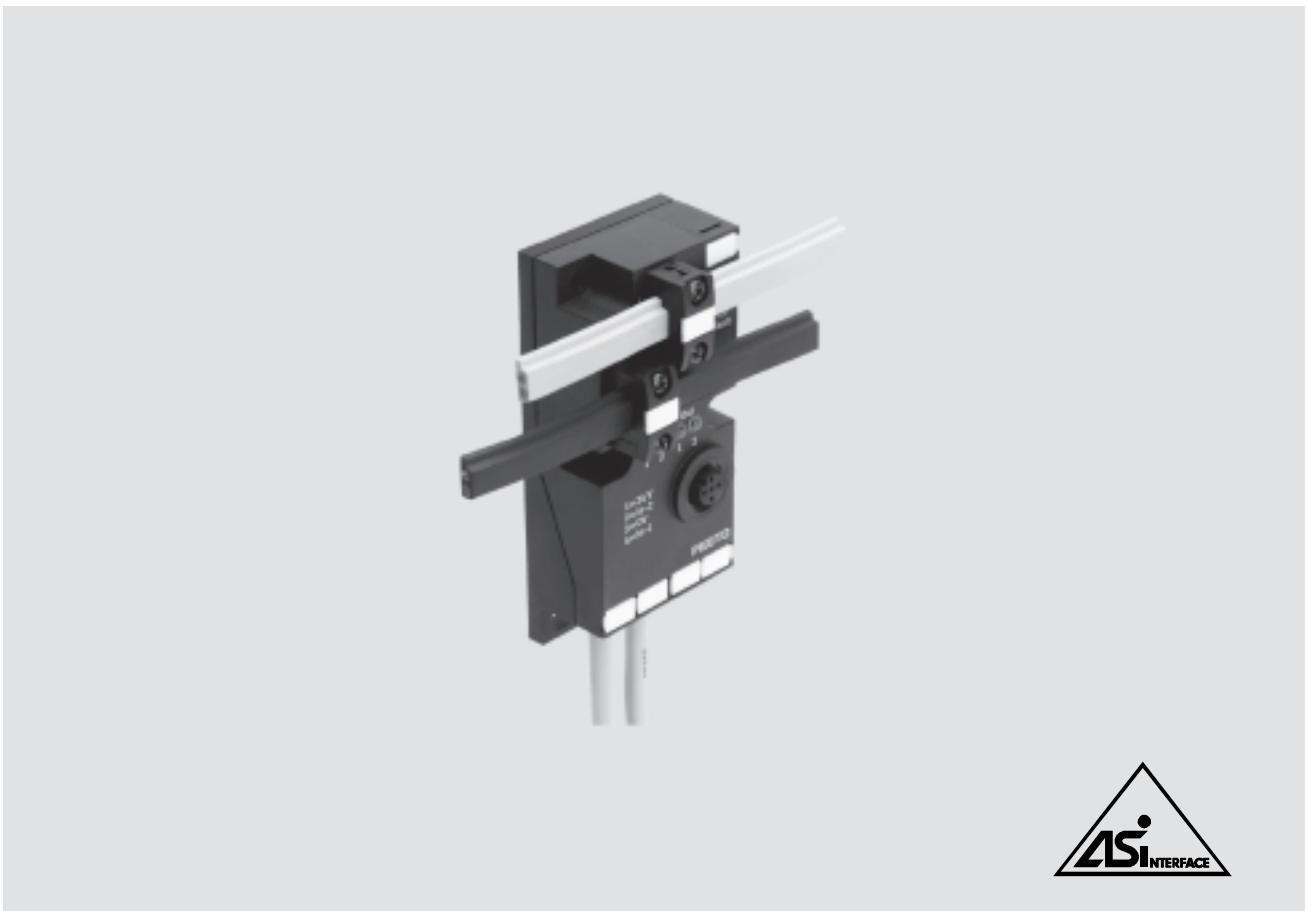

## Individual valve interface

### General description and overview of variants

- With pre-assembled valve plug socket
- With open cable end
- As an input module

Quick connection of valves to the AS-interface by means of Festo plug and work.

All individual valve interfaces have two inputs for recording input signals via cylinder proximity sensors, inductive, capacitive or optical sensors.

### Flexible installation

Install ASI-EVA at the front of the machine for easy servicing – the valves must be close to the actuator in the machine.

The load voltage (auxiliary power supply via the black cable) can be connected/disconnected separately.

### Optimal cost-effectiveness

The ASI-EVA is a cost-effective way of connecting two valves or solenoid coils to the AS-interface:

- One electronic unit for all
- Reduced logistics
- Quick installation
- Flexible assembly
- Wide range of accessories
- Optimal pneumatic sizing

# AS-interface® components

Individual valve interface ASI-EVA – Overview

FESTO

## Mounting options

### Installation

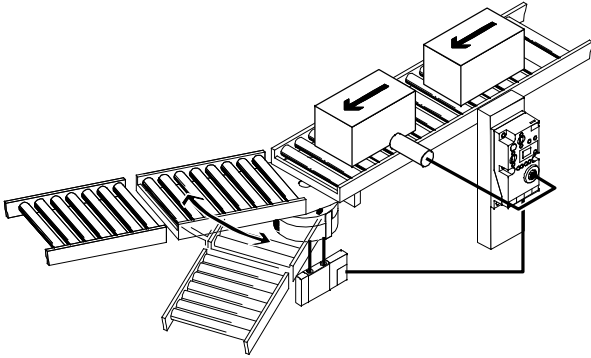

The AS-interface offers new and easy installation concepts thanks to the long cable outlets of the individual valve interface ASI-EVA.

The electronics are installed at the front of the machine. This ensures that the LEDs and control elements are easy to read and operate.

Installation and mounting is very straightforward.

The valve can be mounted close to the cylinder and is easily connected via the pre-fitted cable outlet (0.5 or 1 m). This makes for shorter tubing lengths, quick motion sequences and a reduction in the amount of compressed air used.

### Mounting

#### On an H-rail

You will need an adapter kit type CP-TS-HS35 in order to mount the individual valve interface on an H-rail (DIN mounting rail). This is available as an accessory.

#### On an ITEM profile

The individual valve interface can be mounted directly on an ITEM profile with a gap of 40 mm using the two mounting holes on the left-hand side of the ASI-EVA housing.

#### On a cylinder

Mounting on a cylinder or stopper cylinder is easily accomplished using slot nuts, for example. The different widths of the cylinders are either compensated using the two elongated

holes on the ASI-EVA or else the ASI-EVA can be mounted laterally via the two holes on the left-hand side of the housing.

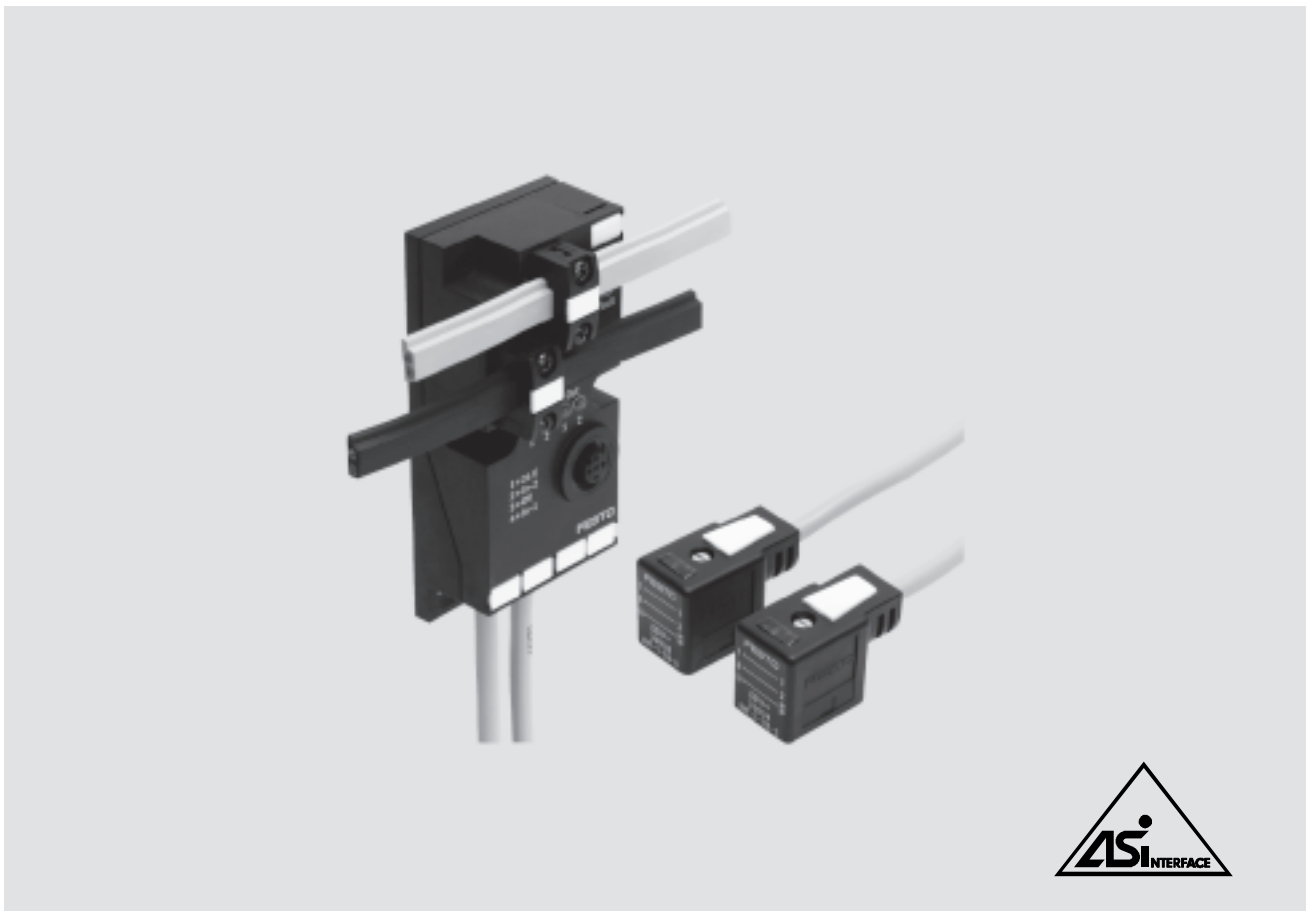

## Individual valve interface to Specification V2.1<sup>1)</sup> – With pre-assembled valve plug sockets

### General description

- Ideal for Festo plug and work. Supports the connection of almost all Festo valves
- The load voltage (auxiliary power supply via the black cable) can be connected/disconnected separately
- All individual valve interfaces have two inputs for recording input signals via cylinder proximity sensors, inductive, capacitive or optical sensors

### Versions

- Cable length 0.5 m
- Valve connection sockets for Festo MF, MEB and ZC coils
- Modules equipped with one or two outputs can be supplied for optimum configuration of valves with one or two solenoid coils
- Valves with a rating of up to 6 watts (12 watts if only one output is switched in parallel) can be connected
- Inputs based on IEC 1131-2, DC 24 V, PNP
- Up to 200 mA per input
- Two inputs on one M12 socket
- Suitable for Festo M12 DUO plugs, for the DUO cables M12/2x M8 and the T-type plug connectors M12-2x M12 or M12-2x M8
- Status LEDs for each input
- Fault LED and enhanced diagnostics as per C.S.2.1<sup>1)</sup>
- The auxiliary power supply is always integrated and can be subsequently switched off using the DIL switch
- Flat cable sockets are available (turned through 180° or standard) and must be ordered separately

### Application

- Cost-effective connection of two valves to the AS-interface. Fast installation thanks to the Festo plug and work design.
- Decentralised machine and system structures, for example
- in conveyor technology
  - in sorting systems
  - in upstream machine functions
  - for individual drives or stopper cylinders
  - for service units and soft-start valves
  - for quarter turn and linear valve actuators in process engineering or water treatment

1) Slave compatible with SPEC V3.0

# AS-interface® components

FESTO

Individual valve interface ASI-EVA – Pre-assembled connection sockets

General technical data		ASI-EVA-MF-2E1A-Z	ASI-EVA-MF-2E2A-Z	ASI-EVA-MEB-2E1A-Z	ASI-EVA-MEB-2E2A-Z	ASI-EVA-MZB9-2E1A-Z	ASI-EVA-MZB9-2E2A-Z
Solenoid coils	Connectable solenoid coils	1	2	1	2	1	2
	Cable length [m]	Pre-assembled cable, 0.5 m per connecting cable					
	Cable type	Round cable 3x 0.5 mm <sup>2</sup> ; cable Ø 5.8 mm; polyurethane; colour: grey				Round cable 2x 0.25 mm <sup>2</sup> ; polyvinyl chloride; colour: grey	
	Valve connection	F coils, EN 175301-803, type B		EB coils, EN 175301-803, type C		ZC coils, e.g. Festo CPE10/14-M1BH	
	Valve actuator design	Short circuit and overload proof					
	External power supply 24 V DC	Can be selected using the DIL switch					
	Current-carrying capacity [A]	0,5	2x 0.25	0,5	2x 0.25	0,5	2x 0.25
	Watchdog function	Active after 50 ms					
Digital inputs	Number	2					
	Connection technology	M12, 5-pin socket with double allocation					
	Sensor supply via AS-interface	Short circuit and overload proof					
	Sensor connection	2-wire and 3-wire sensors, light barriers, etc.					
	Type	IEC 1131-2, type 02					
	Input circuitry	PNP (positive switching)					
	Current-carrying capacity [mA]	Max. 200 per input, max. 200 all inputs					
	Logic level [V]	On: 11 ... 30; off: -30 ... 5					
	Reference potential	0 V					
	Delay time [ms]	Typically 3 (at 24 V DC)					
AS-interface connection	Connection technology	AS-interface flat cable plug (must be ordered separately)					
	Voltage range [V DC]	26.5 ... 31.6, reverse polarity protected					
	Residual ripple [mVss]	20					
	Current consumption [mA]	Max. 12 (basic load of the electronics) <ul style="list-style-type: none"> <li>• plus the current consumption of the digital inputs</li> <li>• plus the current consumption of the outputs if there is no auxiliary power supply</li> </ul> Total current consumption of the ASI-EVA: max. 240					
Load voltage connection	Connection technology	AS-interface flat cable plug (must be ordered separately)					
	Nominal voltage [V DC]	24 ±10%					
	Residual ripple [Vss]	4					
	Current consumption [A]	Max. 0.5 (at 24 V)					
	Output voltage [V]	Approx. 1.4 V less than the load or AS-interface voltage					
LED displays	Outputs/inputs	Two each yellow/green					
	ASI-LED	Power/green					
	AUX-PWR-LED	Auxiliary power supply/green					
	FAULT-LED	Fault LED/red					
Diagnostics	Peripherals fault	To specification C.S.2.1, red FAULT-LED					
General data	Protection class (to EN 60529)	IP65 (fully assembled)					
	Materials	Polyamide					
	Dimensions [mm]	Approx. 102 x 46 x 28.5					
	Weight [g]	200					
AS-interface data	ID code	ID = F <sub>H</sub> ; ID1 = F <sub>H</sub> <sup>1</sup> ; ID2 = E <sub>H</sub>					
	IO code	B <sub>H</sub>					
	Profile	S-B.FE					

1) Factory setting, set to 0<sub>H</sub> by some programming devices (Spec. V2.1) when addressing the slave

Operating and environmental conditions	
Ambient temperature [°C]	-5 ... +50
Storage temperature [°C]	-20 ... +70
CE mark (see declaration of conformity)	To EU EMC Directive <sup>1)</sup>
Certification	c UL us - Recognized (OL)

1) For information about the applicability of the component see the manufacturer's EC declaration of conformity at: [www.festo.com](http://www.festo.com) → Support → User documentation.  
If the component is subject to restrictions on usage in residential, office or commercial environments or small businesses, further measures to reduce the emitted interference may be necessary.

# AS-interface® components

Individual valve interface ASI-EVA – With open cable ends

FESTO

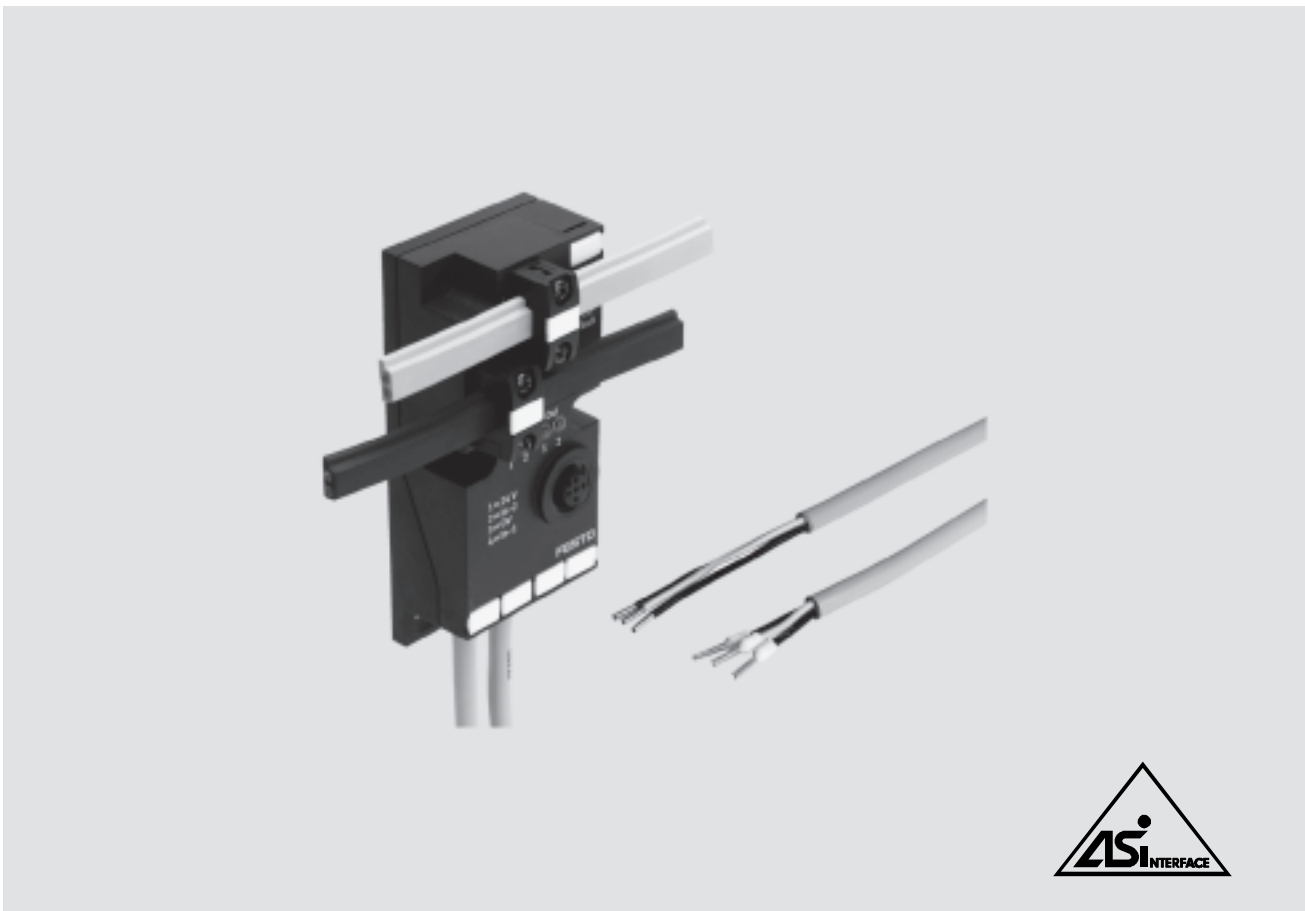

## Individual valve interface to Specification V2.1<sup>1)</sup> – With open cable ends

### General data

Ideal for the flexible connection of almost all valves and other consuming devices:

- Longer cable outlet of up to 1 m
- Pneumatic valves with special connector sockets
- Hydraulic valves
- Other consuming devices

All individual valve interfaces have two inputs for recording input signals via cylinder proximity sensors, inductive, capacitive or optical sensors.

The load voltage (auxiliary power supply via the black cable) can be connected/disconnected separately

### Versions

- Cable length 1 m
- Can be supplied with one or two outputs
- Ideal for the quick connection of valve connection sockets using insulation displacement technology or conventional connection technology
- Valves and consuming devices with a rating of up to 6 watts (12 watts if only one output is switched in parallel) can be connected
- Inputs based on IEC 1131-2, DC 24 V, PNP
- Up to 200 mA per input
- Two inputs on one M12 socket
- Suitable for Festo M12 DUO plugs, for the DUO cables M12/2x M8 and the T-type plug connectors M12-2x M12 or M12-2x M8
- Status LEDs for each input
- Fault LED and enhanced diagnostics as per C.S.2.1<sup>1)</sup>
- The auxiliary power supply is always integrated and can be subsequently switched off using the DIL switch
- Flat cable sockets are available (turned through 180° or standard) and must be ordered separately

### Application

Flexible and cost-effective connection of one or two valves or other consuming devices to the AS-interface.

Decentralised machine and system structures, for example

- in conveyor technology
- in sorting systems
- in upstream machine functions
- for individual drives or stopper cylinders
- for service units and soft-start valves
- for quarter turn and linear valve actuators in process engineering or water treatment
- for applications outside of conventional pneumatics

1) Slave compatible with SPEC V3.0



# AS-interface® components

Individual valve interface ASI-EVA – With open cable ends

FESTO

General technical data			
Type		ASI-EVA-K1-2E1A-Z	ASI-EVA-K1-2E2A-Z
Outputs/valves	No. of outputs/valves	1	2
	Cable length [m]	1	
	Cable type	Round cable 3x 0.5 mm <sup>2</sup> ; cable Ø 5.8 mm; polyurethane; colour: grey	
	Output/valve connection	Open cable end, 3-wire BL1 = 24 V, BL2 = 0 V, gr/ye = n.c.	Open cable end, 3-wire BL1 = 24 V, BL2 = 0 V, gr/ye = n.c.
	Valve actuator design	Short circuit and overload proof	
	External voltage supply 24 V DC	Can be selected using the DIL switch	
	Current-carrying capacity [A]	0.5	2x 0.25
	Watchdog function	Active after 50 ms	
Digital inputs	Number	2	
	Connection technology	M12, 5-pin socket with double allocation	
	Sensor supply via AS-interface	Short circuit and overload proof	
	Sensor connection	2-wire and 3-wire sensors, light barriers, etc.	
	Type	IEC 1131-2, type 02	
	Input circuitry	PNP (positive switching)	
	Current-carrying capacity [mA]	Max. 200 per input, max. 200 all inputs	
	Logic level [V]	On: 11 ... 30; off: -30 ... 5	
	Reference potential	0 V	
	Delay time [ms]	Typically 3 (at 24 V DC)	
AS-interface connection	Connection technology	AS-interface flat cable plug (must be ordered separately)	
	Voltage range [V DC]	26.5 ... 31.6, reverse polarity protected	
	Residual ripple [mVss]	20	
	Current consumption [mA]	Max. 12 (basic load of the electronics) <ul style="list-style-type: none"> <li>plus the current consumption of the digital inputs</li> <li>plus the current consumption of the outputs if there is no auxiliary power supply</li> </ul> Total current consumption of the ASI-EVA: max. 240	
Load voltage connection	Connection technology	AS-interface flat cable plug (must be ordered separately)	
	Nominal voltage [V DC]	24 ±10%	
	Residual ripple [Vss]	4	
	Current consumption [A]	Max. 0.5 (at 24 V)	
	Output voltage [V]	Approx. 1.4 V less than the load or AS-interface voltage	
LED displays	Outputs/inputs	Two each yellow/green	
	ASI-LED	Power/green	
	AUX-PWR-LED	Auxiliary power supply/green	
	FAULT-LED	Fault LED/red	
Diagnostics	Peripherals fault	To specification C.S.2.1, red FAULT-LED	
General data	Protection class (to EN 60529)	IP65 (fully assembled)	
	Materials	Polyamide	
	Dimensions [mm]	Approx. 102 x 46 x 28.5	
	Weight [g]	200	
AS-interface data	ID code	ID = F <sub>H</sub> ; ID1 = F <sub>H</sub> <sup>1</sup> ; ID2 = E <sub>H</sub>	
	IO code	B <sub>H</sub>	
	Profile	S-B.FE	
	AS-interface certificate	Yes, certificate no. 43301	

1) Factory setting, set to 0<sub>H</sub> by some programming devices (Spec. V2.1) when addressing the slave

Operating and environmental conditions		
Ambient temperature	[°C]	-5 ... +50
Storage temperature	[°C]	-20 ... +70
CE mark (see declaration of conformity)		To EU EMC Directive <sup>1)</sup>
Certification		c UL us - Recognized (OL)

1) For information about the applicability of the component see the manufacturer's EC declaration of conformity at: [www.festo.com](http://www.festo.com) → Support → User documentation.  
 If the component is subject to restrictions on usage in residential, office or commercial environments or small businesses, further measures to reduce the emitted interference may be necessary.

# AS-interface® components

FESTO

Individual valve interface ASI-EVA – Input module with 4 inputs

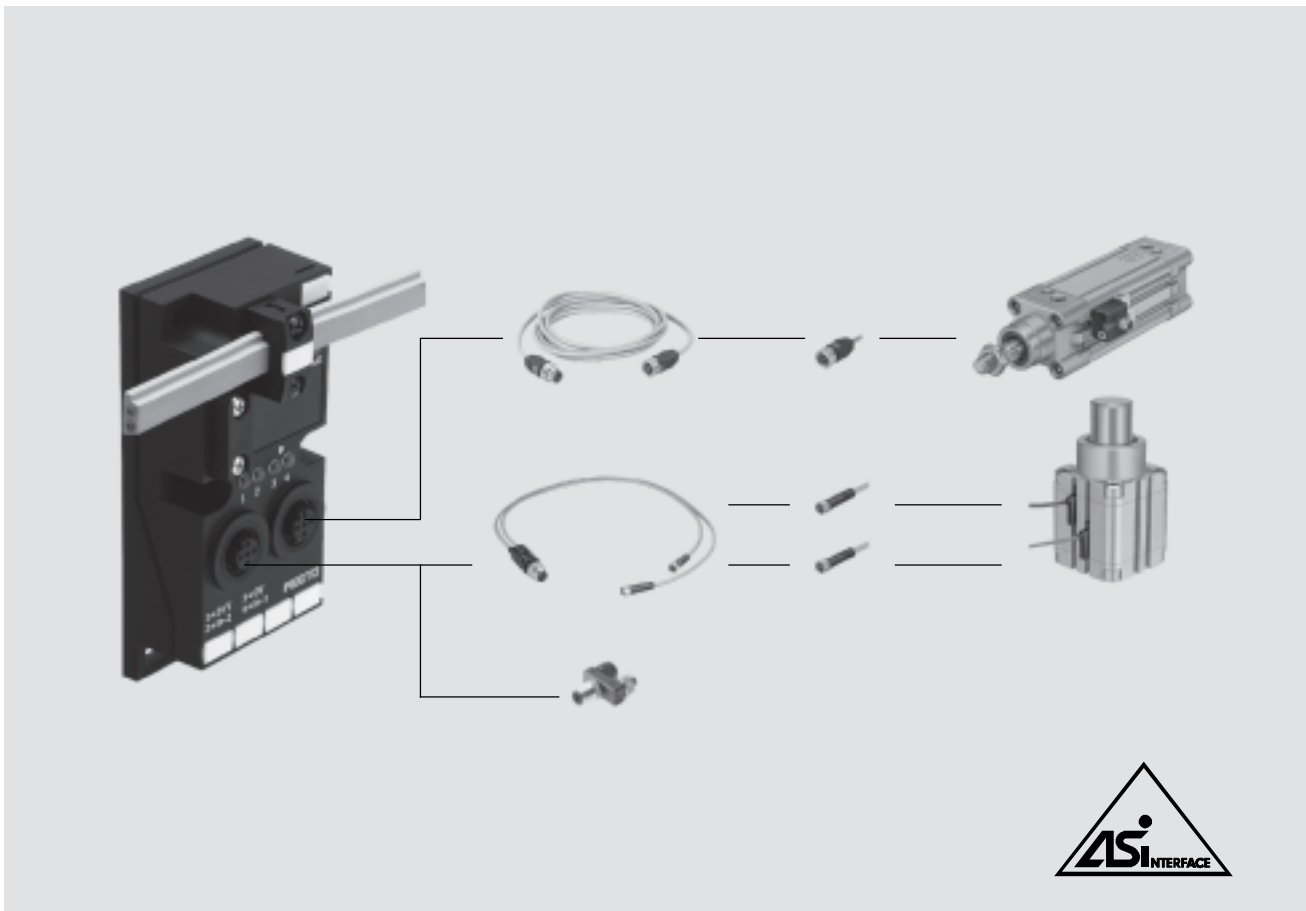

## Individual valve interface to Specification V2.1<sup>1)</sup> – Input module with 4 inputs

### General data

4-fold input module ideal for the connection of additional

- proximity sensors for cylinders
- sensors
- light barriers
- other digital input signals

Suitable for use with valve terminals

- CPV
- or as an input module for any desired inputs

The inputs are short circuit proof. Easy to install on the AS-interface. Simply connect to the yellow cable and it's ready to go.

### Type

- Inputs based on IEC 1131-2, DC 24 V, PNP
- Up to 200 mA per input
- Two M12 sockets
- Two inputs on each M12 socket
- Suitable for Festo M12 DUO plugs, for the DUO cables M12/2x M8 and the T-type plug connectors M12-2x M12 or M12-2x M8
- Status LEDs for each input
- Fault LED and enhanced diagnostics as per C.S.2.1<sup>1)</sup>
- Ready-to-connect cable for Festo plug and work installation
- Flat cable sockets are available (turned through 180° or standard) and must be ordered separately

### Application

Flexible and cost-effective connection of one to four sensors to the AS-interface. Decentralised machine and system structures, for example

- in conveyor technology
- in sorting systems
- in upstream machine functions
- for all types of inputs

1) Slave compatible with SPEC V3.0

# AS-interface® components

Individual valve interface ASI-EVA – Input module with 4 inputs

General technical data		
Type	ASI-EVA-4E-M12-5POL	
Digital inputs	No. of digital inputs	4
	Connection technology	M12, 5-pin socket with double allocation
	Sensor supply via AS-interface	Short circuit and overload proof
	Sensor connection	2-wire and 3-wire sensors, light barriers, etc.
	Type	IEC 1131-2, type 02
	Input circuitry [V DC]	24, PNP (positive switching)
	Current-carrying capacity [mA]	Max. 200 per input, max. 200 all inputs
	Logic level [V]	On: 11 ... 30; off: -30 ... 5
	Reference potential [V]	0
	Delay time [ms]	Typically 3 (at 24 V DC)
AS-interface connection	Connection technology	AS-interface flat cable plug (must be ordered separately)
	Voltage range [V DC]	26.5 ... 31.6, reverse polarity protected
	Residual ripple [mVss]	20
	Current consumption [mA]	Max. 12 (basic load of the electronics) <ul style="list-style-type: none"> <li>plus the current consumption of the digital inputs</li> </ul> Total current consumption of the ASI-EVA: max. 240
LED displays	Inputs	In/green
	ASI-LED	Power/green
	FAULT-LED	Fault LED/red
Diagnostics	Peripherals fault	As per specification C.S.2.1, additionally red LED
	Protection class (to EN 60529)	IP65 (fully assembled)
	Materials	Polyamide
	Dimensions [mm]	Approx. 102 x 46 x 28.5
	Weight [g]	200
AS-interface data	ID code	1 <sub>H</sub>
	IO code	0 <sub>H</sub>
	Profile	S-0.1
	AS-interface certificate	Yes, certificate no. 43302

Operating and environmental conditions		
Ambient temperature [°C]		-5 ... +50
Storage temperature [°C]		-20 ... +70
CE mark (see declaration of conformity)		To EU EMC Directive <sup>1)</sup>
Electromagnetic compatibility		Tested to EN 50295 (low voltage switchgear)
Certification		c UL us - Recognized (OL)

1) For information about the applicability of the component see the manufacturer's EC declaration of conformity at: [www.festo.com](http://www.festo.com) → Support → User documentation.  
 If the component is subject to restrictions on usage in residential, office or commercial environments or small businesses, further measures to reduce the emitted interference may be necessary.

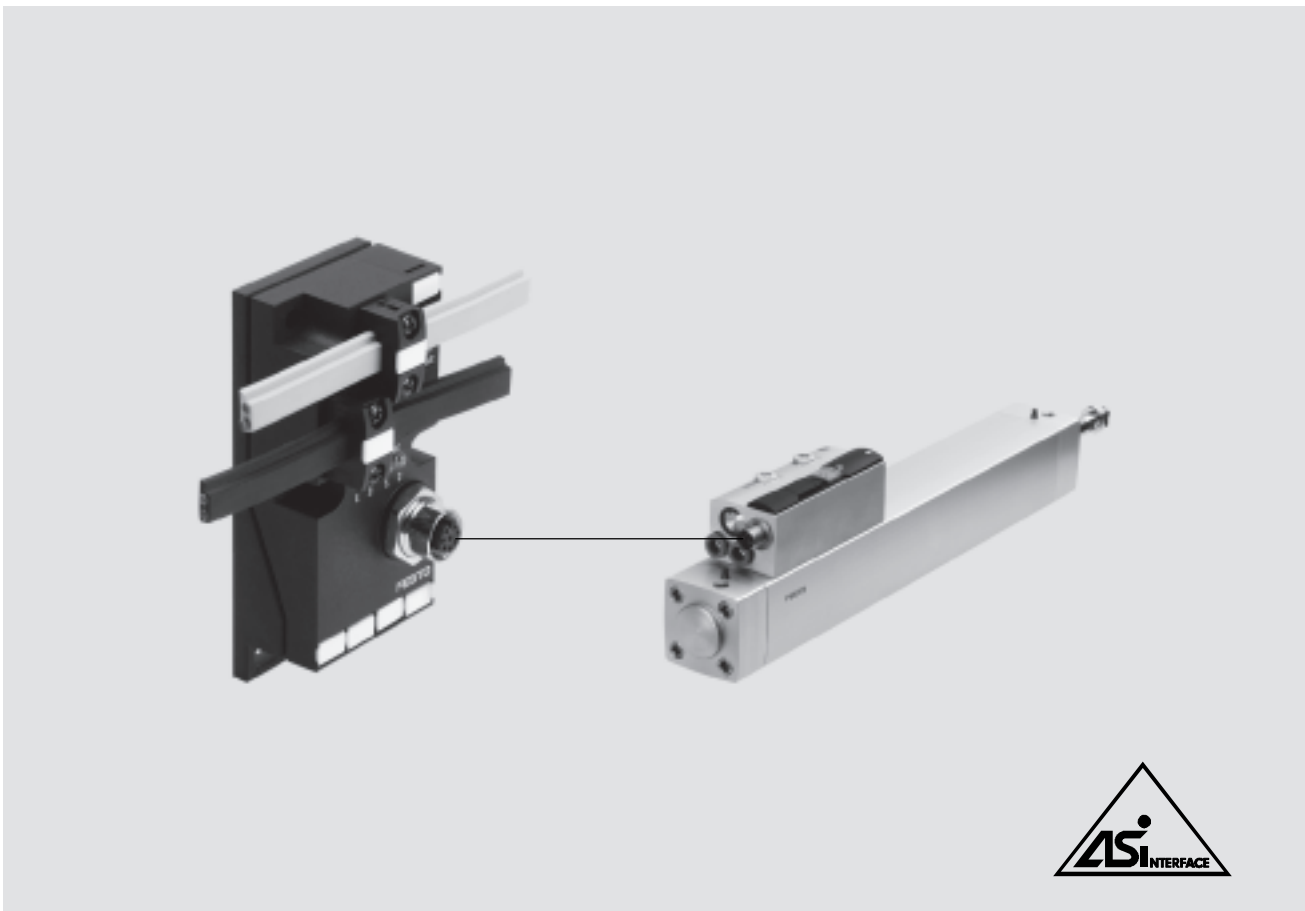

#### Individual valve interface to Specification V2.1<sup>1)</sup>

The pneumatic drive conforms as near as possible to the international standard DIN/ISO 6431 as well as the further standards VDMA 24 562, NFE 49 003 and UNI 10 290.

#### Type

- Two inputs and two outputs as well as a diagnostic input on one 8-pin M12 socket
- Inputs based on IEC 1131-2, DC 24 V, PNP
- Up to 200 mA per input
- Status LEDs for each input
- Fault LED and enhanced diagnostics as per C.S.2.1<sup>1)</sup>

- Ready-to-connect cable for Festo plug and work installation: KM12-8GD8GS-2-PU
- Flat cable sockets are available (turned through 180° or standard) and must be ordered separately

#### Application

- Easy and flexible connection of special cylinders in upstream applications to the AS-interface.
- Valve and cylinder integrated
  - Flow control valves integrated
  - Limit switch integrated and adjustable
  - Single supply of data and power via a flat cable
  - Easy diagnostics and servicing thanks to the separation of the drive and interface

1) Slave compatible with SPEC V3.0

General technical data		
Type	ASI-EVA-2E2A-M12-8POL-Z	
Outputs/valves	No. of outputs/valves	2
	Cable length [m]	2
	Cable type	Round cable 8x 0.25 mm <sup>2</sup> ; cable Ø 5.8 mm; polyurethane; colour: grey
	Valve connection	M12 plug, 8-pin, pins 5, 6 and 8
	Valve actuator design	Short circuit and overload proof
	External power supply 24 V DC	Can be selected using the DIL switch
	Current-carrying capacity <sup>1)</sup> [A]	2x 0.25
	Watchdog function	Active after 50 ms
Digital inputs	Number	2
	Connection technology	M12 plug, 8-pin; sensors: pins 2, 3 and 4; diagnostics: pins 1 and 7
	Sensor supply via AS-interface	Short circuit and overload proof
	Type	IEC 1131-2, type 02
	Input circuitry [V DC]	24, PNP (positive switching)
	Current-carrying capacity [mA]	Max. 200 per input, max. 200 all inputs
AS-interface connection	Connection technology	AS-interface flat cable plug (must be ordered separately)
	Voltage range [V DC]	26.5 ... 31.6, reverse polarity protected
	Residual ripple [mVss]	20
	Current consumption [mA]	Of the electronics (basic load): max. 12 Total current consumption of the ASI-EVA: max. 240
Load voltage connection	Connection technology	AS-interface flat cable plug (must be ordered separately)
	Nominal voltage [V DC]	24 ±10%
	Residual ripple [Vss]	4
	Current consumption [A]	Max. 0.5 (at 24 V)
LED displays	Output voltage [V]	Approx. 1.4 V less than the load or AS-interface voltage
	Outputs/inputs	Two each yellow/green
	ASI-LED	Power/green
	AUX-PWR-LED	Auxiliary power supply/green
FAULT-LED	Fault LED/red	
Diagnostics	Peripherals fault	To specification C.S.2.1, red FAULT-LED
General data	Protection class (to EN 60529)	IP65 (fully assembled)
	Materials	Polyamide
	Dimensions [mm]	Approx. 102 x 46 x 28.5
	Weight [g]	200
AS-interface data	ID code	ID = F <sub>H</sub> ; ID1 = F <sub>H</sub> <sup>2</sup> ; ID2 = E <sub>H</sub>
	IO code	B <sub>H</sub>
	Profile	S-B.F.E
	AS-interface certificate	Yes, certificate no. 43303

1) With an external voltage supply, otherwise the total current consumption is max. 240 mA

2) Factory setting, set to 0<sub>H</sub> by some programming devices (Spec. V2.1) when addressing the slave

Operating and environmental conditions		
Ambient temperature	[°C]	-5 ... +50
Storage temperature	[°C]	-20 ... +70
CE mark (see declaration of conformity)		To EU EMC Directive <sup>1)</sup>
Electromagnetic compatibility		Tested to EN 50295 (low voltage switchgear)
Certification		c UL us - Recognized (OL)

1) For information about the applicability of the component see the manufacturer's EC declaration of conformity at: [www.festo.com](http://www.festo.com) → Support → User documentation.

If the component is subject to restrictions on usage in residential, office or commercial environments or small businesses, further measures to reduce the emitted interference may be necessary.

# AS-interface® components

Individual valve interface ASI-EVA

FESTO

## Diagnostics and parameterisation

The AS-i individual valve interface type ASI-EVA-2E2A-M12-8POL-Z supports the evaluation of a diagnostic output from drive/valve combinations.

Any faults or malfunctions that occur within a drive/valve combination (0 signal at pin7) are indicated as peripherals faults of the slave at the AS-interface master.

Depending on the master, the four parameter bits can be addressed in different formats (binary, hexadecimal).  
Parameter bits can also be changed with an addressing device.

The addressing device ASI-PRG-ADR from Festo works with hexadecimal values.

Diagnostics of the individual valve interface can be deactivated via the AS-interface parameter port P3 (binary: P3 = 0, hexadecimal: 7).

Parameter bits (example)				
	P3	P2	P1	P0
Hexadecimal entry	Binary entry			
Fh	1	1	1	1
7	0	1	1	1

Parameter port settings		
Hexadecimal entry	Parameter port P3	Description
Fh	P3 = 1 (diagnostics active, factory setting)	Faults in the slave as well as a 0 signal <sup>1)</sup> at the diagnostic input (pin 7): • will be indicated as peripherals faults
7	P3 = 0 (diagnostics inactive)	Faults in the slave as well as a 0 signal <sup>1)</sup> at the diagnostic input (pin 7): • will not be indicated as peripherals faults

1) 0 signal = Error message from the drive/valve combination or wire break

# AS-interface® components

Individual valve interface ASI-EVA – Connections/displays

## Overview of connections/displays – ASI-EVA

Individual valve interface – 2I2O, 2I1O

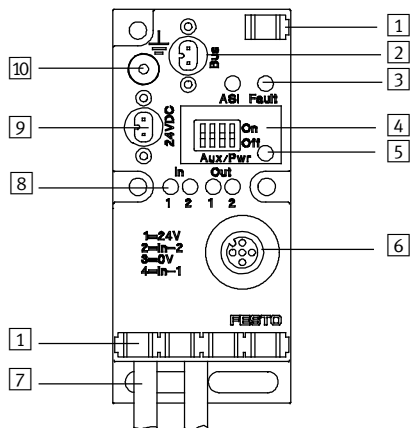

- 1 Inscription labels
- 2 AS-interface bus connection
- 3 ASI-LED (power/green), FAULT-LED (fault/red)
- 4 DIL switch for load voltage connection
- 5 AUX-PWR-LED
- 6 Sensor connection
- 7 1 or 2 connecting cables for outputs (valves)
- 8 LED display for
  - Outputs
  - Inputs
- 9 Auxiliary power supply for outputs/valves
- 10 Functional earth connection

## Input module with 4 inputs

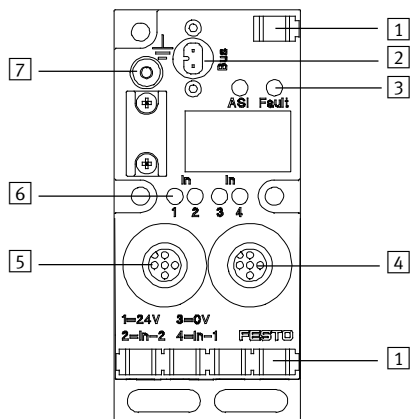

- 1 Inscription labels
- 2 AS-interface bus connection
- 3 ASI-LED (power/green), FAULT-LED (fault/red)
- 4 Sensor connection 2 (inputs 3 and 4)
- 5 Sensor connection 1 (inputs 1 and 2)
- 6 LED status display for inputs (In, green)
- 7 Functional earth connection

## Interface

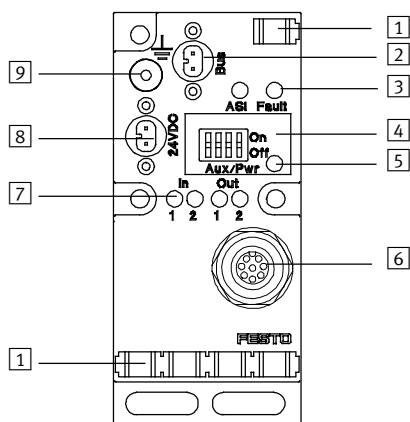

- 1 Inscription labels
- 2 AS-interface bus connection
- 3 ASI-LED (power/green), FAULT-LED (fault/red)
- 4 DIL switch for load voltage connection
- 5 AUX-PWR-LED
- 6 Sensor/valve connection
- 7 LED display for
  - Valve
  - Sensors
- 8 Auxiliary power supply for valve
- 9 Functional earth connection

# AS-interface® components

Individual valve interface ASI-EVA – Connections

FESTO

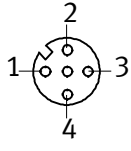
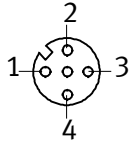
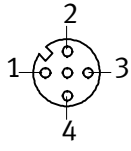
Pin allocation			
Inputs	X1	X2	LED
ASI-EVA-...-2E-...-A-Z			
	1: 24 V DC	-	IN-2
	2: Input IN-2		IN-1
	3: 0 V		
	4: Input IN-1		
	5: n.c.		
ASI-EVA-...-4E-M12-5POL			
	1: 24 V DC	-	IN-2
	2: Input IN-2		IN-1
	3: 0 V		
	4: Input IN-1		
	5: n.c.		
	-	1: 24 V DC	IN-4
		2: Input IN-4	IN-3
		3: 0 V	
		4: Input IN-3	
		5: n.c.	

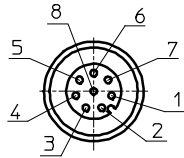
Pin allocation		
Inputs/outputs	X1	LED
ASI-EVA-2E2A-M12-8POL-Z		
	1: 24 V DC	
	2: Sensor IN-2	IN-2
	3: Sensor IN-1	IN-1
	4: 0 V sensors	
	5: Coil 14 OUT-2	OUT-2
	6: Coil 12 OUT-1	OUT-1
	7: Diagnostics	
	8: 0 V sensors	

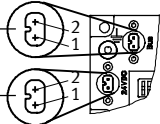
Pin allocation		
AS-i connection		
	<b>1</b> AS-interface bus 1: + (light blue) 2: - (brown)	<b>2</b> Auxiliary power supply for 1: 0 V 2: + 24 V DC

Open cable allocation	
For any inputs/outputs	
Black 1/2	24 V DC/0 V
Green/yellow	n.c.



## Dimensions – ASI-EVA

Download CAD data → [www.festo.com](http://www.festo.com)

### Input/output module with 2 inputs and 1 or 2 outputs

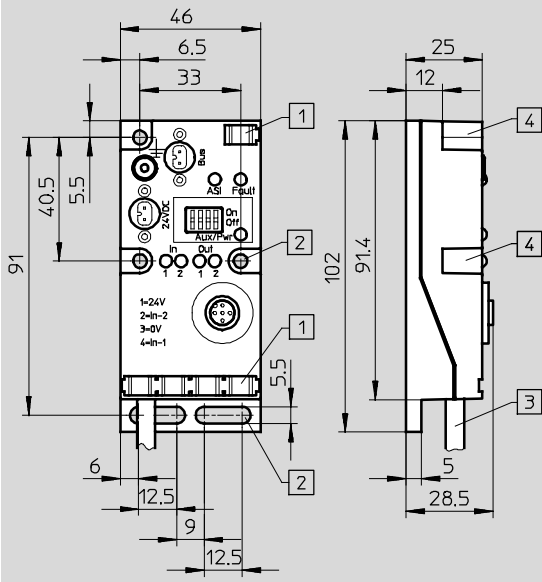

- 1 Mounting option for inscription label
- 2 Mounting hole for surface mounting
- 3 Cable module
- 4 Mounting hole for ITEM profile 40 mm or other mounting option

### Input module with 4 inputs

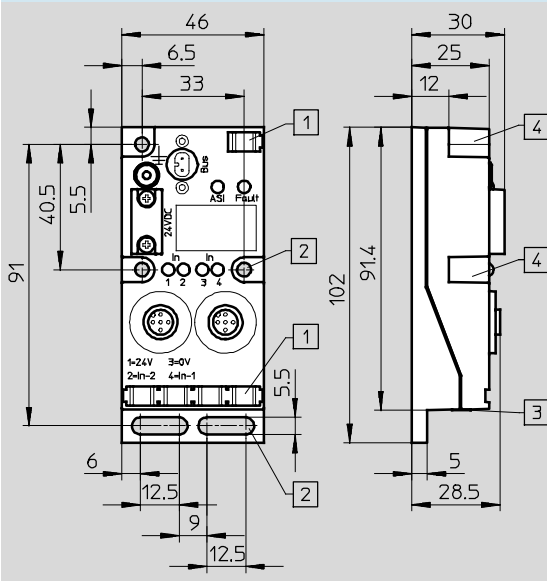

- 1 Mounting option for inscription label
- 2 Mounting hole for surface mounting
- 3 Ring seal
- 4 Mounting hole for ITEM profile 40 mm or other mounting option

# AS-interface<sup>®</sup> components

Individual valve interface ASI-EVA – Dimensions

FESTO

## Dimensions – ASI-EVA

Download CAD data → [www.festo.com](http://www.festo.com)

### Interface

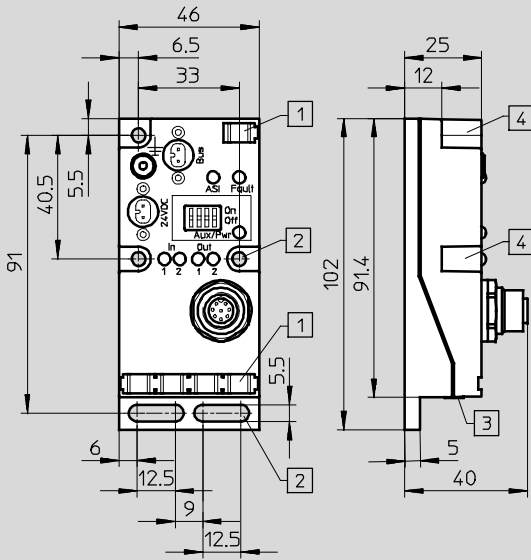

- 1 Mounting option for inscription label
- 2 Mounting hole for surface mounting
- 3 Ring seal
- 4 Mounting hole for ITEM profile 40 mm or other mounting option

### Example: H-rail mounting

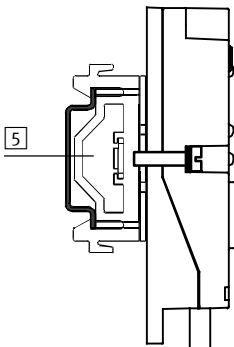

- 5 H-rail mounting on mounting rail EN 60715 35 x 15 using adapter kit CP-TS-HS32

## Dimensions – Connecting cable

Download CAD data → [www.festo.com](http://www.festo.com)

KM12-8GD8GS-2-PU

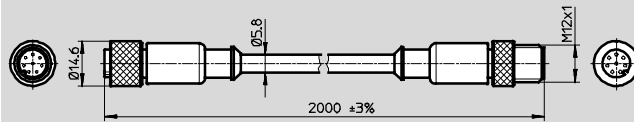

## Dimensions – Pin allocation for solenoid coils

Download CAD data → [www.festo.com](http://www.festo.com)

ASI-EVA-MF-2E...-A-Z

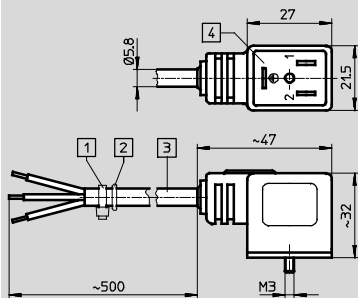

- 1 Cable binder
- 2 O-ring 5x 1.5
- 3 3-wire cable 0.5 m (3x 0.25 mm<sup>2</sup>)
- 4 Connections for plug to EN 175 301-803 type C

ASI-EVA-MEB-2A...-A-Z

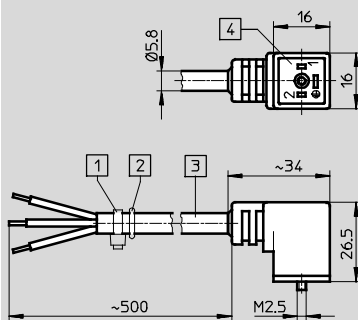

- 1 Cable binder
- 2 O-ring 5x 1.5
- 3 3-wire cable 0.5 m (3x 0.5 mm<sup>2</sup>)
- 4 Connections for plug to EN 175 301-803 type B

ASI-EVA-MZB9-2E...-A-Z

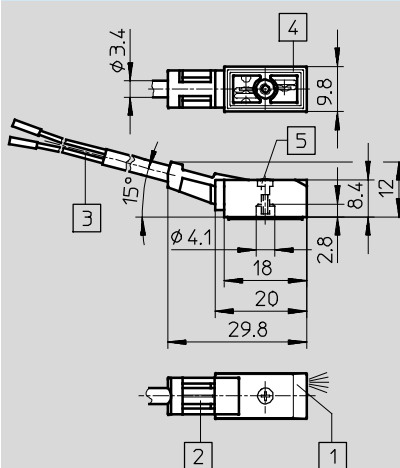









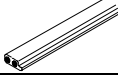





- 1 LED display
- 2 Holder for inscription labels
- 3 2-wire cable 0.5 m (2x 0.25 mm<sup>2</sup>)
- 4 Connection pattern for MZC
- 5 Mounting screw M2 x 8, max. tightening torque 0.35 Nm

# AS-interface® components

Individual valve interface ASI-EVA – Accessories

FESTO

Ordering data				
	Description		Part No.	Type
<b>Bus connection</b>				
	AS-interface flat cable, yellow	100 m	<b>18940</b>	<b>KASI-1,5-Y-100</b>
	AS-interface flat cable, black	100 m	<b>18941</b>	<b>KASI-1,5-Z-100</b>
	Flat cable socket <sup>1)</sup>		<b>18785</b>	<b>ASI-SD-FK</b>
	Flat cable socket <sup>1)</sup>	Turned through 180°	<b>196089</b>	<b>ASI-SD-FK180</b>
	Flat cable blanking plug		<b>196090</b>	<b>ASI-SD-FK-BL</b>
	AS-interface flat cable distributor	Parallel cable	<b>18786</b>	<b>ASI-KVT-FK</b>
	AS-interface flat cable distributor	Symmetrical cable	<b>18797</b>	<b>ASI-KVT-FK-S</b>
	Cable cap for flat cable	Scope of delivery 50 pieces	<b>18787</b>	<b>ASI-KK-FK</b>
	Cable sleeve	Scope of delivery 20 pieces	<b>165593</b>	<b>ASI-KT-FK</b>
<b>Sensor plugs</b>				
	Straight sensor plug	M12, 5-pin, PG7	<b>175487</b>	<b>SEA-M12-5GS-PG7</b>
	Straight sensor plug	M12, 4-pin, PG7	<b>18666</b>	<b>SEA-GS-7</b>
	Straight sensor plug	M12, PG9 connector	<b>18778</b>	<b>SEA-GS-9</b>
	Straight sensor plug for cable Ø 2.5 mm	M12, 4-pin	<b>192008</b>	<b>SEA-4GS-7-2,5</b>
	Angled sensor plug	M12, 4-pin	<b>185498</b>	<b>SEA-M12-4WD-PG7</b>
	Protective cap (10 pieces)	M12	<b>165592</b>	<b>ISK-M12</b>



1) Two flat cable connections per ASI-EVA must be connected or covered

Ordering data			
	Description	Part No.	Type
<b>Connecting cables</b>			
	Connecting cable, straight plug, straight socket	M12, 4-pin/5-pin, 0.2 m	<b>542129</b> <b>NEBU-M12G5-F-0.2-M12G4</b>
		M12, 4-pin, 2.5 m	<b>18684</b> <b>KM12-M12-GSGD-2,5</b>
		M12, 4-pin, 5.0 m	<b>18686</b> <b>KM12-M12-GSGD-5</b>
	Connecting cable, straight plug, angled socket	M12, 4-pin, 1.0 m	<b>185499</b> <b>KM12 M12-GSWD-1-4</b>
	Modular system for connecting cables → Internet: nebu	-	<b>NEBU-...</b>
<b>DUO plug</b>			
	Plug M12 for 2 sensor cables	4-pin, PG11	<b>18779</b> <b>SEA-GS-11-DUO</b>
		5-pin, PG11	<b>19010</b> <b>SEA-5GS-11-DUO</b>
<b>DUO cable M12 on 2x M8</b>			
	DUO cable M12 4-pin via 2xM8, 3-pin	2x straight socket	<b>18685</b> <b>KM12-DUO-M8-GDGD</b>
		2x straight/angled socket	<b>18688</b> <b>KM12-DUO-M8-GDWD</b>
		2x angled socket	<b>18687</b> <b>KM12-DUO-M8-WDWD</b>
<b>T-type plug connector</b>			
	T-type plug connector		<b>541597</b> <b>NEDU-M8D3-M12T4</b>
			<b>541596</b> <b>NEDU-M12D5-M12T4</b>
<b>Connecting cable for DNCV</b>			
	Connecting cable, straight plug, straight socket	M12, 8-pin, 2.0 m	<b>525617</b> <b>KM12-8GD8GS-2-PU</b>
<b>Miscellaneous</b>			
	Primary switched mode modular power supply AS-i power supply 4.8 A		<b>547869</b> <b>SVG-1/230VAC-ASI-5A</b>
	Primary switched mode modular power supply 24 VDC power supply 5 A		<b>547867</b> <b>SVG-1/230-24VDC-5A</b>
	Primary switched mode modular power supply 24 VDC power supply 10 A		<b>547868</b> <b>SVG-1/230-24VDC-10A</b>
	Addressing device		<b>18959</b> <b>ASI-PRG-ADR</b>
	Addressing cable		<b>18960</b> <b>KASI-ADR</b>

# AS-interface® components

Individual valve interface ASI-EVA – Accessories

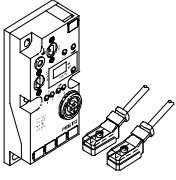
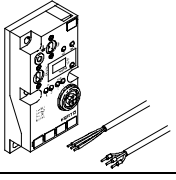
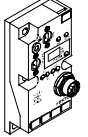
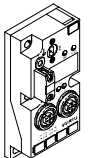
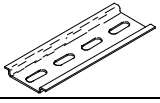
FESTO

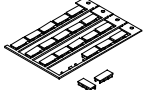
Ordering data			
	Description	Part No.	Type
<b>ASI-EVA I/O modules</b>			
	Valve interface, pre-assembled cable, 2 inputs, 1 output	196081	ASI-EVA-MF-2E1A-Z
	Valve interface, pre-assembled cable, 2 inputs, 2 outputs	196082	ASI-EVA-MF-2E2A-Z
	Valve interface, pre-assembled cable, 2 inputs, 1 output	196085	ASI-EVA-MEB-2E1A-Z
	Valve interface, pre-assembled cable, 2 inputs, 2 outputs	196086	ASI-EVA-MEB-2E2A-Z
	Valve interface, pre-assembled cable, 2 inputs, 1 output	196083	ASI-EVA-MZB9F-2E1A-Z
	Valve interface, pre-assembled cable, 2 inputs, 2 outputs	196084	ASI-EVA-MZB9F-2E2A-Z
	Valve interface with open cable ends, 2 inputs, 1 output	196087	ASI-EVA-K1-2E1A-Z
	Valve interface with open cable ends, 2 inputs, 2 outputs	196088	ASI-EVA-K1-2E2A-Z
	AS-i module, 2 inputs, 2 outputs	197070	ASI-EVA-2E2A-M12-8Pol-Z
	AS-i module, 4 inputs	197069	ASI-EVA-4E-M12-5POL
<b>Mounting</b>			
	H-rail to EN 60715	35430	NRH-35-2000
	Mounting for H-rail	170169	CP-TS-HS35
<b>Inscription labels</b>			
	Inscription labels 6x10 mm in frames (64 pieces)	18576	IBS-6x10

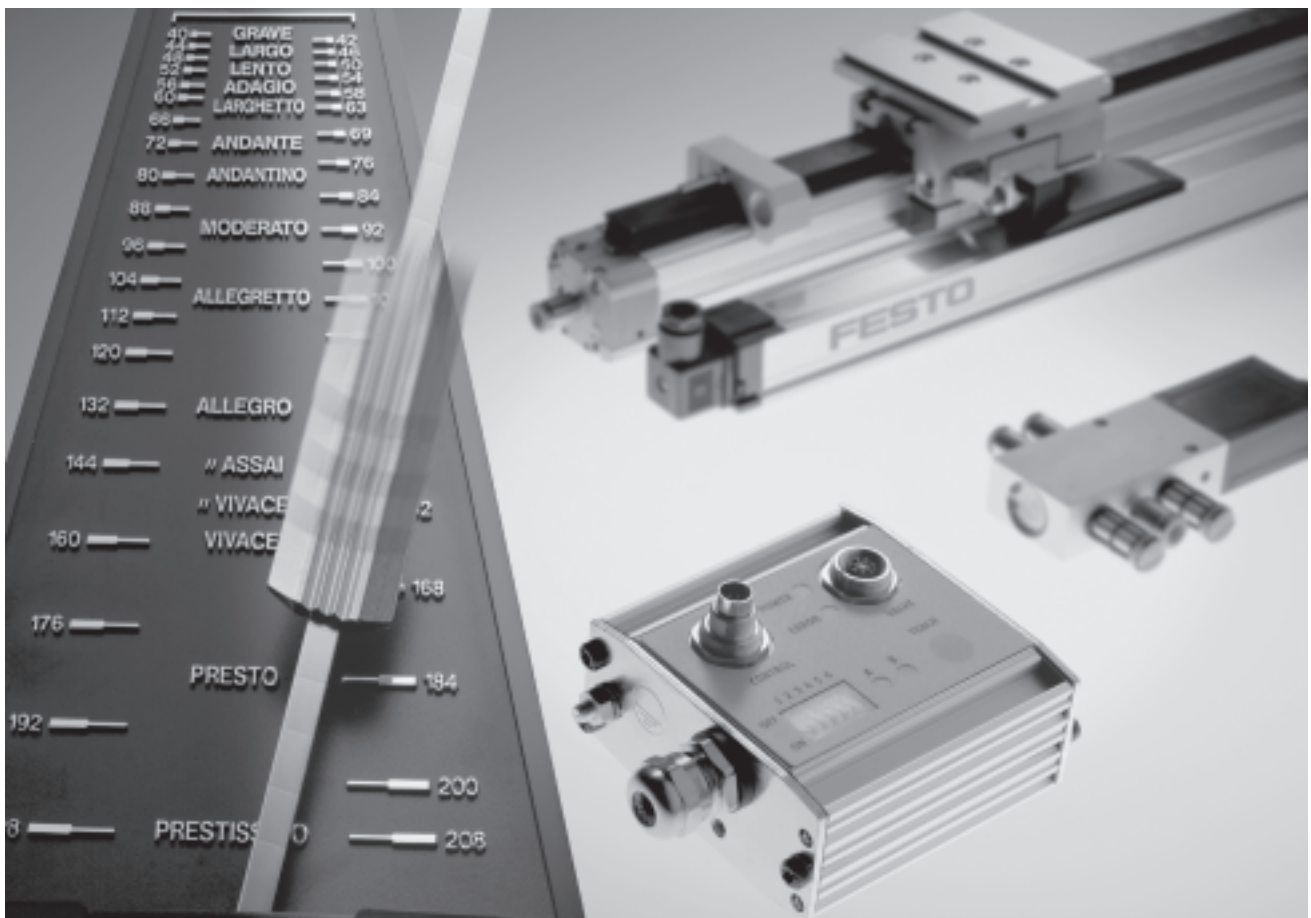

## Applications – Innovative, high-performance and precision-pulsed drive packages

- Drives on the AS-interface
- Intelligent valve/cylinder combinations
- Process actuators such as linear valve actuators and quarter turn actuators with robust local controller or sensor box on the AS-interface

### DAPZ for Copar

Simple, fast installation is preferred in decentralised applications in the process industry and in water treatment systems.

The local controller connects quarter turn actuators to the AS-interface. The sensor box DAPZ converts mechanical end positions from pneumatic actuators into electrical signals and also provides connections for the solenoid valve.

### Advantages:

- Namur interface (DIN 19 234)
- Quick and easy assembly and connection
- Integrated solenoid valve actuation
- Fully assembled and tested unit for the AS-interface

# AS-interface® components

Applications

FESTO

## Control by sensor box – DAPZ

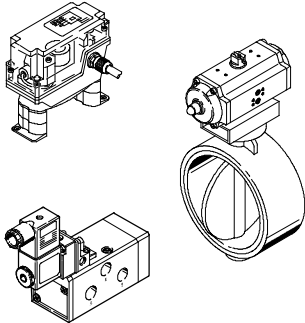

- Standard valve with Namur interface
- Sensor box with integrated valve actuator (solenoid coil plug) and limit switches for converting mechanical end-position signals into electrical signals
- Connect to the AS-interface using the yellow cable
- Pre-assembled and tested unit
- Quick and easy installation
- Festo plug and work on the AS-interface
- Suitable for exterior use.  
Temperature range:  $-25 \dots +85 \text{ }^{\circ}\text{C}$

## Alternative ways of connecting process actuators to the AS-interface

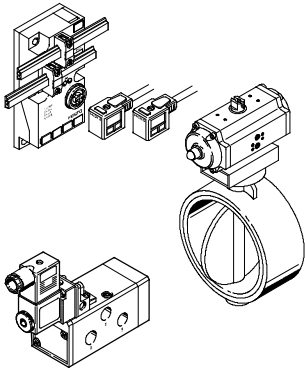

- Standard valve with Namur interface
- Individual valve interface ASI-EVA
- Copac/Copar process actuator
- Discrete sensor configuration



## AS-interface® components

Sensor box as intelligent signal generator – Overview

FESTO



### Innovative

- Integrated AS-interface
- Integrated solenoid valve actuator
- Integrated sensor for mechanical end positions
- Quick and easy connection technology
- “Open” and “Closed” display can be individually set via trip cam
- Trip cam gearing prevents position drift

### Reliable

- Pre-assembled and tested unit
- High temperature range –25 ... +85 °C
- Robust materials made from impact resistant Vestamid
- Standardised interfaces to the quarter turn actuators
- LED displays for on-the-spot diagnostics
- AS-interface as secure transmission protocol

### Easy to mount

- Can be mounted directly on the quarter turn actuators (Copar DRD, Sypar DAPS)
- Fully assembled and tested unit
- Lower cost of selection, ordering, installation and commissioning
- Can be integrated into existing AS-interface networks at any time
- Geometrically coded flat cable ensures polarity-safe connection to the AS-interface
- Easy adjustment of switching points
- Particularly economical thanks to simplified assembly and commissioning

# AS-interface® components

Sensor box as intelligent signal generator – Overview

## General function

- **Integrated inputs:**  
The sensor box converts the mechanical end-position signals from pneumatic actuators into electrical signals and provides them as input signals for the AS-interface.
- **Solenoid valve actuation:**  
A solenoid valve can be actuated using one output (24 V DC, 2.6 watts). The output is fitted with a pre-assembled cable for the plug pattern MF (industrial standard to DIN 43 650) – another example of Festo plug and work.
- **Networking concepts:**  
Modern systems and processes communicate using networks. Data from the actuator/sensor level is recorded, compressed and transmitted via the AS-interface flexibly and cost-effectively, and can even be forwarded to higher-order fieldbus systems.
- **Proven components:**  
Inside the sensor box are components from leading manufacturers. The advantages lie in the tailored combination and the holistic solution.

## Connection to the AS-interface

The yellow flat cable of the AS-interface carries the supply for the electronics, the sensors and the output. The flat cable connection is coded to protect against incorrect polarity.

The sensor box is uniquely described by the ID code  $F_H$  and the IO code  $D_H$ .  
Structure of the IO code  $D_H$

D3	D2	D1	D0
E	E	E	A

Sensor 1 “Open” is fed back to data bit D2, sensor 2 “Closed” to data bit D3 (example for drives with clockwise rotation). D1 is not used.  
Data bit D0 sets the output and switches the connected solenoid valve.

# AS-interface® components

Sensor box as intelligent signal generator – Overview

FESTO

General technical data			
Type	DAPZ-SB-I-30DC-DSAM-RO		
Signal generator	Type	Double initiator with normally-closed function to NAMUR (DIN 19234)	
	Manufacturer	Pepperl & Fuchs	
	Type	NCN3-25F-N4	
	Switching accuracy	Less than 0.5°	
	Service life	Minimum service life of switch: 2x 10 <sup>5</sup> cycles	
	Short circuit proof	Yes	
Interface to the drive	NAMUR standard VDI/VDE 3845		
Output	Connection technology	Solenoid plug	
	Nominal voltage [V DC]	24	
	Tolerance	+10/-15 %	
	Residual ripple	As per AS-interface specification, dependent on power supply unit	
	Current consumption [mA]	Max. 120	
	Short circuit proof	Protected by current limitation	
	Connecting cable	PVC cable, solenoid plug already connected	
	Cable length [cm]	30	
	Cable type	3x 0.5 mm <sup>2</sup>	
	Valve connection	F coil to DIN 43650, type: industrial standard	
	Watchdog function	None	
Supply voltage	Electronics, sensors and output are supplied via the yellow flat cable at the AS-interface connection		
AS-interface connection	Connection technology	AS-interface flat cable plug (included in scope of delivery)	
	Voltage range [V DC]	26.5 ... 31.6, reverse polarity protected	
	Residual ripple [mVss]	20	
	Current consumption [mA]	Max. 12, electronics <ul style="list-style-type: none"> <li>• plus 2-wire sensor 4</li> <li>• plus connected output (dependent on solenoid valve, max. 120)</li> </ul>	
LED displays	Output	None, illuminating seal possible on solenoid coil (on request)	
	Inputs	2x yellow	
	ASI-LED	Green	
General data	Protection class (to EN 60529)	Sensor IP67, housing IP65	
	Electromagnetic compatibility	AS-interface electronics and initiator: EN 60947-5-2; NE21	
	CE mark	Yes	
	Temperature range [°C]	Operation: -25 ... +85	
	Materials	• Seal	Ethylene propylene rubber
		• Housing socket	Polyamide, black
		• Housing cover	Transparent polycarbonate (black polyamide or nickel-plated aluminium on request)
		• Control shaft	Polyacetal
		• Universal console	Polyamide
	Corrosion resistance class CRC <sup>1)</sup>	3	
Dimensions [mm]	Approx. 146 x 64 x 74 (without console)		
Weight [g]	450		
AS-interface data	ID code	F <sub>H</sub>	
	IO code	D <sub>H</sub>	
	Profile	S-D.F	

1) Corrosion resistance class 3 as per Festo standard 940 070  
 Components requiring higher corrosion resistance. External visible parts in direct contact with industrial atmospheres or media such as solvents and cleaning agents, with a predominantly functional requirement for the surface.

# AS-interface® components

Sensor box as intelligent signal generator – Overview

Dimensions

Download CAD data → [www.festo.com](http://www.festo.com)

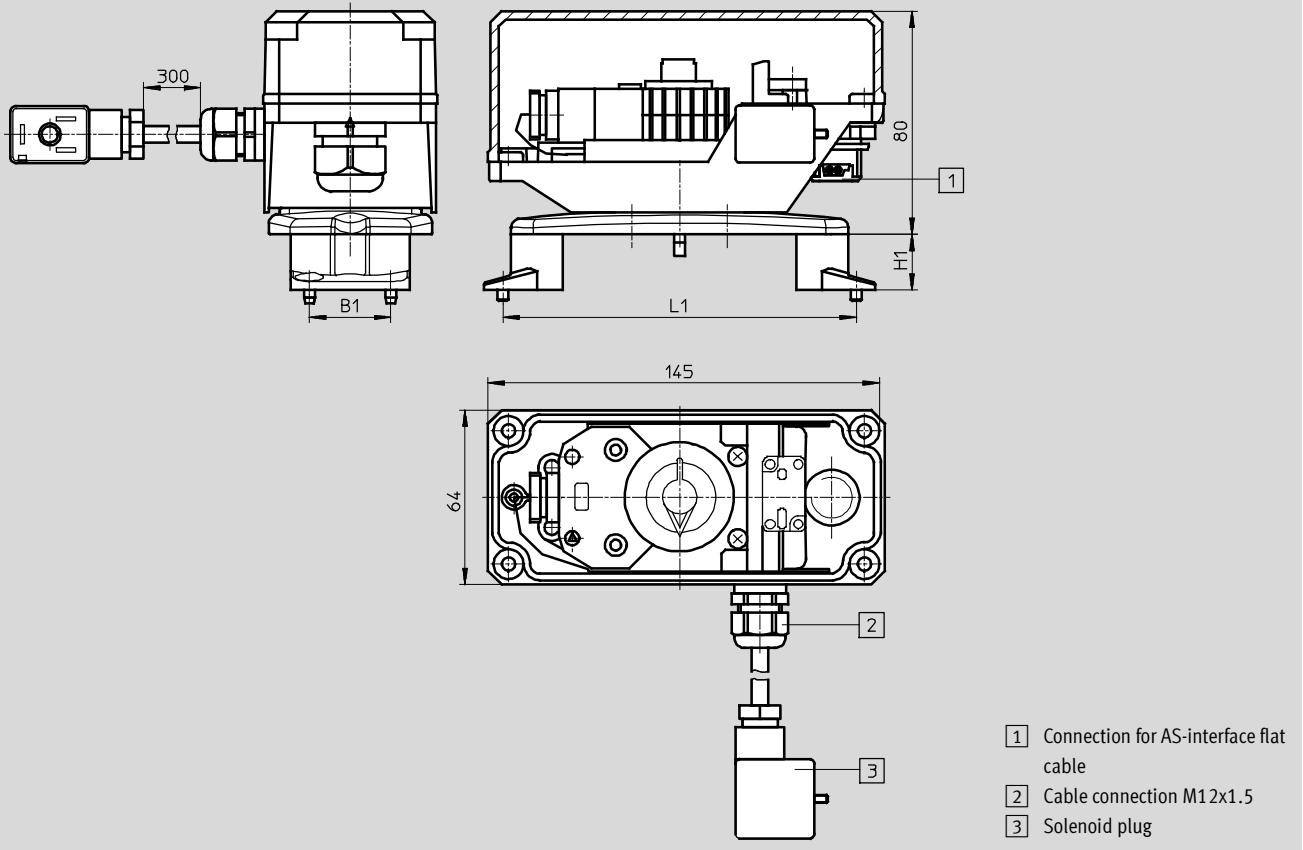







Feet mounted inwards			
	B1	L1	H1
Foot 20	30	80	20
Foot 30	30	80	30

Feet mounted outwards			
	B1	L1	H1
Foot 20	30	130	20
Foot 30	30	130	30

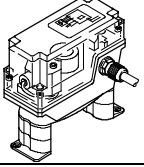
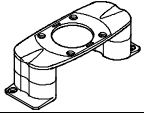
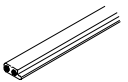
# AS-interface® components

Sensor box as intelligent signal generator – Overview

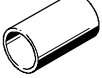
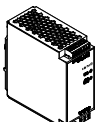
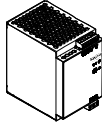
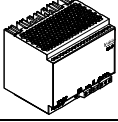
FESTO

Ordering data				
	Description		Part No.	Type
<b>DAPZ-... Sensor box</b>				
	Limit switch attachment with integrated valve actuation		534473	DAPZ-SB-I-30DC-DSAM-RO
<b>DAPZ-... mounting</b>				
	Mounting console	50x25 / WH 20 mm	534477	DAPZ-SBZ-F50-RO
		130x30 / WH 30 mm	534478	DAPZ-SBZ-K0-RO
		130x30 / WH 30 mm	534479	DAPZ-SBZ-K3-RO
<b>Bus connection</b>				
	AS-interface flat cable, yellow	100 m	18940	KASI-1,5-Y-100
	AS-interface flat cable distributor	Parallel cable	18786	ASI-KVT-FK
	Symmetrical cable	Symmetrical cable	18797	ASI-KVT-FK-S
	Cable cap for flat cable (scope of delivery 50 pieces)		18787	ASI-KK-FK
	Cable sleeve (scope of delivery 20 pieces)		165593	ASI-KT-FK
<b>Miscellaneous</b>				
	Primary switched mode modular power supply AS-i power supply 4.8 A		547869	SVG-1/230VAC-ASI-5A
	Primary switched mode modular power supply 24 VDC power supply 5 A		547867	SVG-1/230-24VDC-5A
	Primary switched mode modular power supply 24 VDC power supply 10 A		547868	SVG-1/230-24VDC-10A
	Addressing device		18959	ASI-PRG-ADR
	Addressing cable		18960	KASI-ADR



#### Power supply unit – SVG-1/230VAC\_...

Primary switched mode modular power supply with integrated data disconnection. The pack supplies the operating voltage to AS-i systems. The first device generates an AS-i direct voltage of 30.1 V DC and an output current of 4.8A. Additional optional, power supplies, 24 V DC, available with 5A or 10A load current, complete the offering. All devices offer high stability and low residual ripple.

The supply outputs are resistant to sustained short circuits. The power pack is suitable both for installation in encapsulated control systems and cabinets as well as for wall mounting. Connection is made via tension springs. The connections are protected against direct contact in conformance with DIN VDE Part 100.

#### Nominal input voltage:

- 100 ... 240 V AC
  - AS-i load: 4.8 A
- Optional auxiliary power supply 24 V DC:
- Load 5 A or 10 A

General technical data				
Type		SVG-1/230VAC-ASI-5A	SVG-1/230VAC-24VDC-5A	SVG-1/230VAC-24VDC-10A
Mechanical				
Type of mounting		Via H-rail		
Mounting position		Free convection		
Product weight	[g]	900	830	1300
Electrical				
Electrical connections		Spring-loaded terminal		
Input voltage range	[V AC]	100 ... 240		
Input current	[A]	2.1 ... 1.0	1.9 ... 0.8	2.8 ... 1.2
Mains voltage frequency	[Hz]	45 ... 65		
Nominal output voltage	[V DC]	30.1 ± 1.5%	24 ± 1%	
Nominal output current	[A]	4.8	5	10
Power failure bridging	[ms]	20	20	50

Operating and environmental conditions	
Ambient temperature	[°C] -25 ... +70
Storage temperature	[°C] -40 ... +85
Protection class	IP20
Relative air humidity	[%] 95
CE mark (see declaration of conformity)	In accordance with EU EMC Directive
	In accordance with EU Low Voltage Directive
Certification	cULus listed (OL)

-  - Note

Contains PWIS (paint wetting impairment substances).

Dimensions

Download CAD data → [www.festo.com](http://www.festo.com)

SVG-1/230VAC-ASI-5A

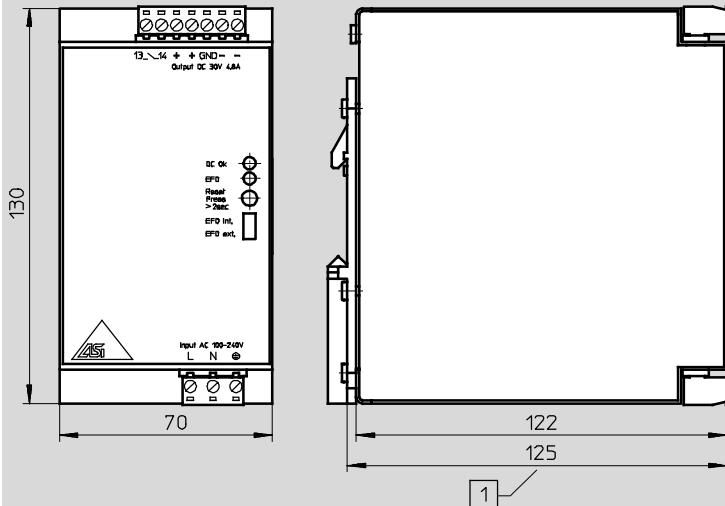

1 H-rail bearing surface

Dimensions

Download CAD data → [www.festo.com](http://www.festo.com)

SVG-1/230VAC-24VDC-5A

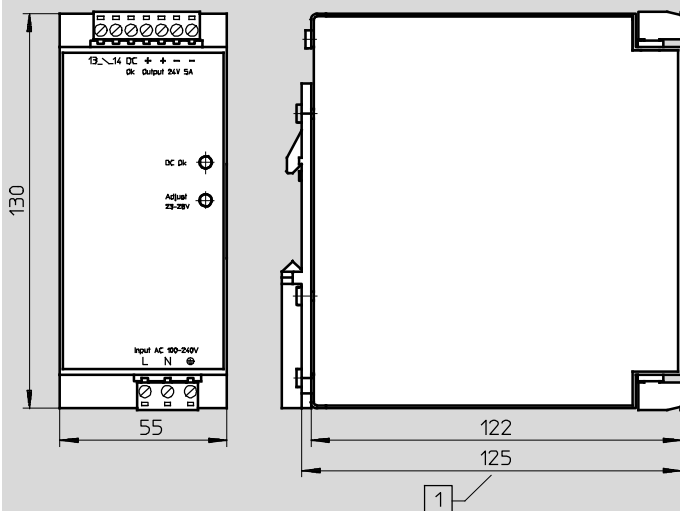

1 H-rail bearing surface



Dimensions

Download CAD data → [www.festo.com](http://www.festo.com)

SVG-1/230VAC-24VDC-10A

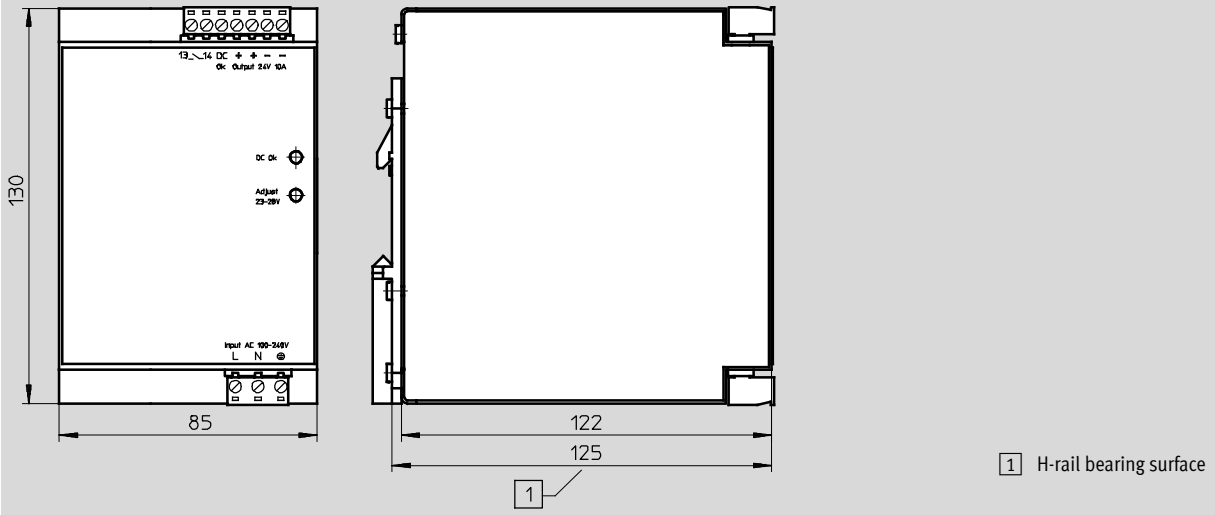



#### Addressing device – ASI-PRG-ADR

Before an AS-interface network is commissioned, addresses must be assigned to the connected slaves. These addresses are stored in an EEPROM chip on each slave. Each slave is connected to the addressing device for the allocation of an address.

Addressing is simple and is carried out using 5 keys.

The main advantages are:

- Compact design
- Can be addressed on-site

- Supports AS-interface specification C.S.2.1

The addressing device to SPEC V2.1 can be used to scan the AS-interface from any point in the network. At all connected stations

- slave addresses can be read/changed
- ID and IO codes can be read out
- parameters can be read/changed

- input/output data can be read and written (setting outputs)
- error messages can be read out and quickly recognised

Independent of voltage supplies

- Battery operation

Simple reading of error codes

- LCD display

Reliable

- Short circuit-proof
- Overload-proof

Universal adapter connection suitable for a large number of AS-interface slaves. Additional addressing cable for slaves with M12 round plug or flat cable socket optionally available.

General technical data		
Type	ASI-PRG-ADR	
Display	LCD display	
Keyboard	Touch-sensitive keypad with 5 keys	
Power supply	Via battery (charge time approx. 14 hours)	
Charging device	[V AC]	230
Service life	> 250 read/write processes or 8 hours	
Operating temperature	[°C]	0 ... +50
Storage temperature	[°C]	-20 ... +55
Protection class	IP20	
Dimensions	[mm]	80 x 210 x 30
Weight	[g]	275

## Dimensions

Download CAD data → [www.festo.com](http://www.festo.com)

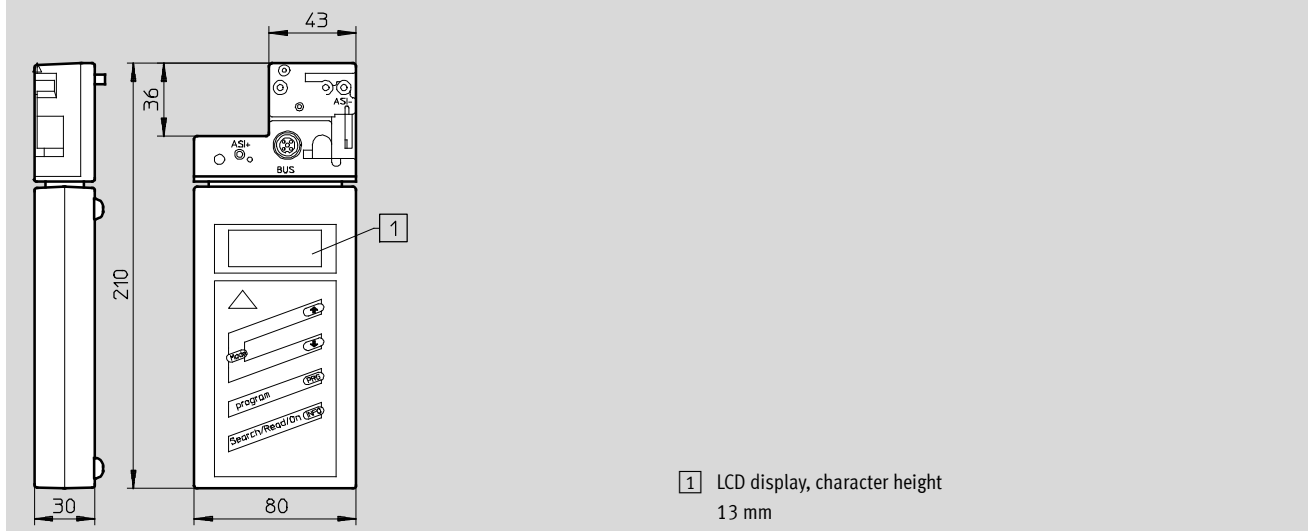

-  - Note  
Information on the addressing cable  
→ 108

## Overview of cables

### Addressing cable – KASI-ADR

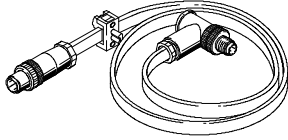

The addressing cable ASI-ADR, available as an accessory, can be used to address any desired slaves either directly via the flat cable connection (FK)

or via the M12 connection (M12):

- Individual valve interface (FK)
- Compact I/O modules (M12)

- CPV valve terminals (FK)
- SPC11 Soft Stop (FK)
- DAPZ sensor box (cable)

### Flat cable – KASI-1,5-...-100

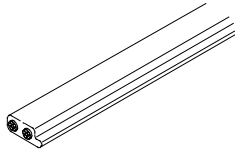

KASI-1,5-Y-100 (yellow)  
KASI-1,5-Z-100 (black)

The flat cable is of a 2-wire design. The coding profile prevents polarity reversal of the cable.

AS-interface network stations are connected to the flat cable via insulation displacement technology which utilises contact pins, thus eliminating the need to strip cable and wire insulation.

The yellow cable is normally used for the AS-interface network and the black cable for the auxiliary power supply.

### Connecting cable NEBU-M12...-M12...

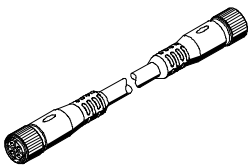

The round cables are of a 4-wire design and are protected against polarity reversal. Standardised connection technology replaces the yellow/black AS-interface cable with a common cable.

- Fixed lengths: 0.2 m, 1 m, 2.5 m and 5 m ex-stock
- NEBU modular system for connecting cables



#### Note

Define your connecting cable yourself. Select M8 (3-pin or 4-pin) or M12 (4-pin or 5-pin) on each side as required and specify the required cable length and quality – Festo will then supply the exact cable you require.

→ [www.festo.com](http://www.festo.com)

### Flat cable sleeve – ASI-KT-FK



For insulating and sealing the AS-interface cable at the end of the string

- Protection class IP65
- Shrinks on application of heat (hot air blower etc.)

### Cable cap – ASI-KK-FK

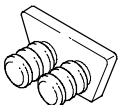

For insulating and sealing the AS-interface cable at the end of the string

- Protection class IP65

## Dimensions

Download CAD data → [www.festo.com](http://www.festo.com)

### Addressing cable – KASI-ADR

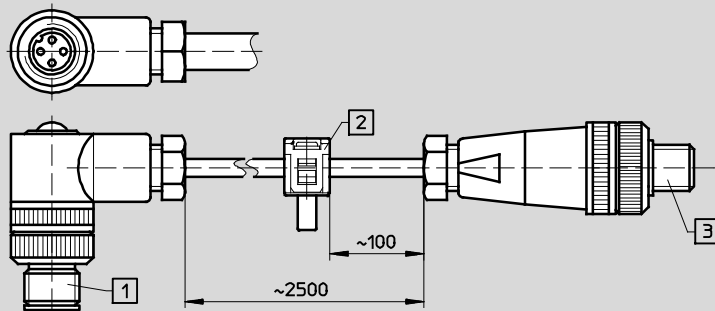

- 1 Round plug connector for connection to addressing device
- 2 Flat cable socket for connecting stations in the AS-interface network with plug-in connection
- 3 Flat cable socket with M12 connection plug for stations in the AS-interface network with M12 interface

### Flat cable – KASI-1,5-...-100

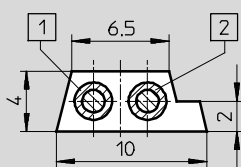

- 1 blue (-)
- 2 brown (+)

### Flat cable sleeve – ASI-KT-FK

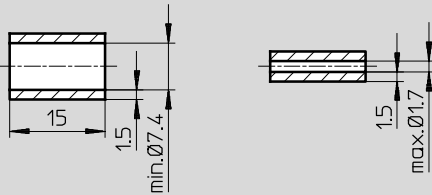

### Cable cap – ASI-KK-FK

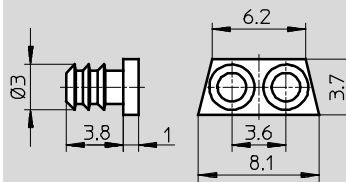

### Connecting cable – NEBU-M12G5-F-0.2-M12G4

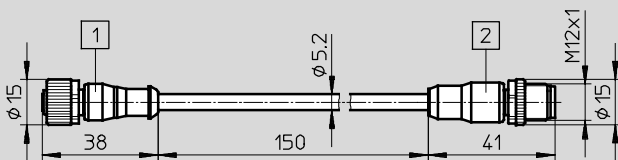

- 1 Straight socket M12
- 2 Straight plug M12

### Wiring allocation (socket/plug view)

#### NEBU-M12G5-F-0.2-M12G4

Plug	Pin	Wire colour/wiring allocation	Pin	Socket
	1	Brown/ASI +	1	
	2	White/0 V load	2	
	3	Blue/ASI -	3	
	4	Black/24 V load	4	

## Overview of connection components

### Flat cable socket

Flat cable socket for connecting AS-interface network stations to the flat cable. The connection is detachable.

The cable socket is protected against reverse polarity.

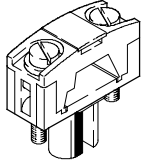

#### ASI-SD-FK

Flat cable socket for CPV valve terminals, ASI-EVA.

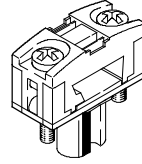

#### ASI-SD-FK180

Version FK180 for looping through of flat cable on top.

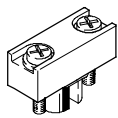

#### ASI-SD-FK-M12

Blanking plug for sealing unused connections for flat cable sockets.

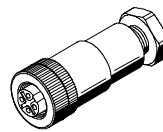

#### ASI-SD-PG-M12

Flat cable socket with M12 connection and special seal for the flat cable in a PG connector. For compact input module (ASI-8DI-M8-3POL).

### Flat cable distributors

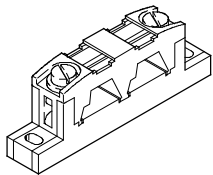

#### ASI-KVT-FK

Parallel flat cable distributor enables the flat cable to be branched at any desired point to the AS-interface network stations.

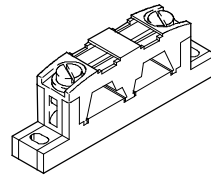

#### ASI-KVT-FK-S

Symmetrical flat cable distributor that enables the coding profile of the flat cable to be turned through 180° when changing cables. This avoids the need to install a loop. Three cable caps are provided in the scope of delivery to seal the cable ends.

### Cable distributor

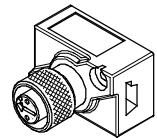

#### ASI-SD-FK-M12

Flat cable socket with M12 connection for looping through the flat cable. Outlet direction can be turned through 90°. Can be plugged into 4-pin and 5-pin interfaces. Pins 1 and 3 are connected (yellow AS-interface cable). For compact input module (ASI-8DI-M8-3POL).

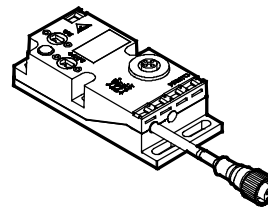

#### ASI-KVT-FKx2-M12

The flat cable distributor is a passive component which recouples flat cables from the AS-interface (yellow and optionally black) to M12 4-pin plug connectors.

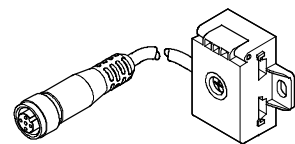

#### NEFU-X2

Flat cable socket with M12 connection for looping through the flat cable. Can be plugged into 4-pin and 5-pin interfaces.

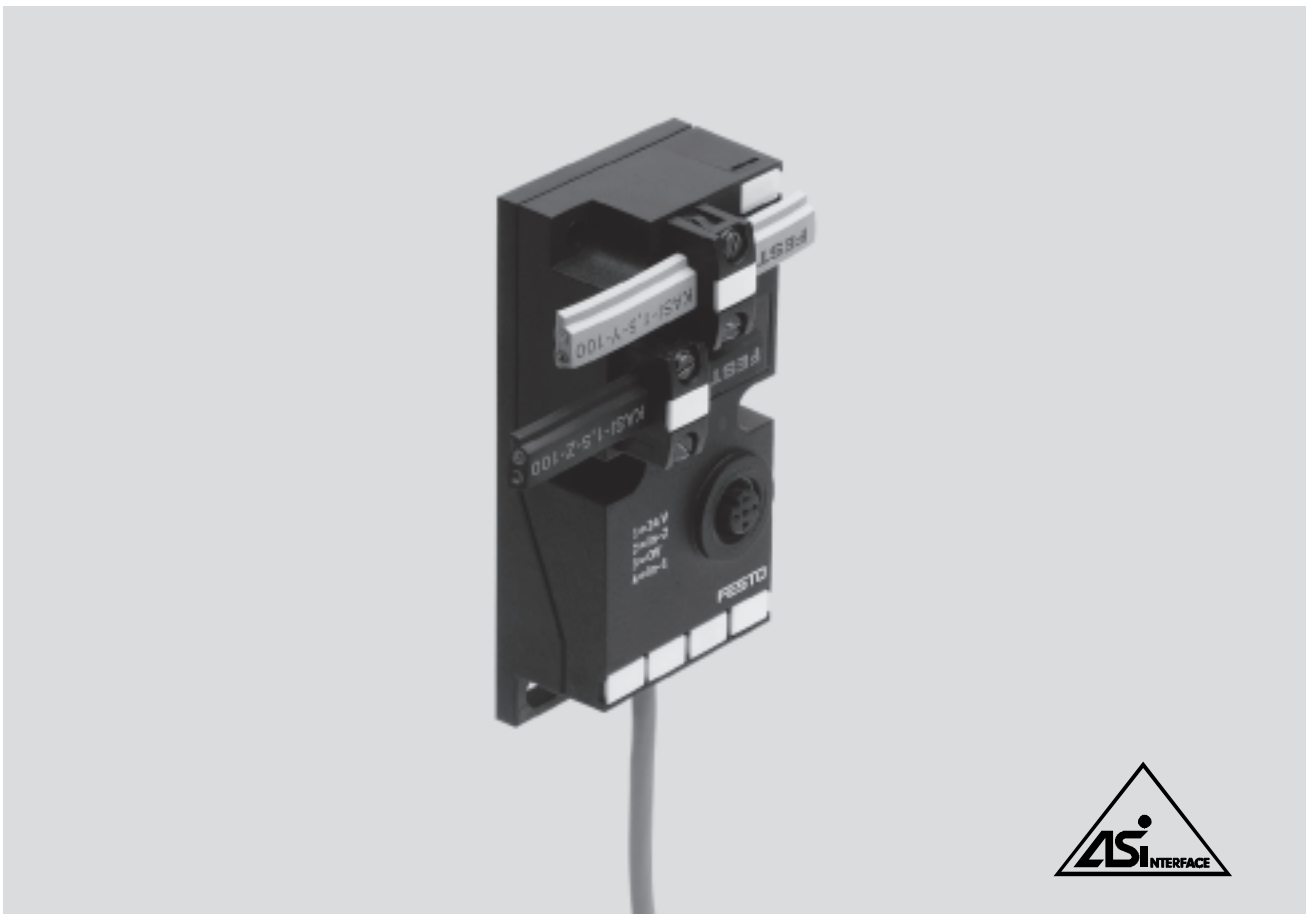

**Flat cable distributor yellow/black to 2xM12**

ASI-KVT-FKx2-M12

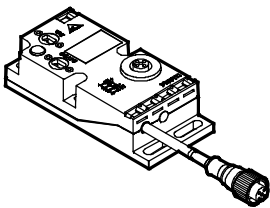

The flat cable distributor is a passive component which recouples flat cables from the AS-interface (yellow and optionally black) to M12 4-pin plug connectors. The flat cable distributor was introduced as an accessory for the compact I/O modules, but

is also compatible with other slaves available on the market with standardised M12 interface. An approx. 1 m polyurethane cable with M12 socket is permanently attached to the housing. Alternatively an extension cable

can be connected via an M12 socket integrated in the housing. The flat cable distributor thus permits new connection technologies on the AS-interface, mainly via round cables in energy chains or environments with higher requirements for easy cleaning.

**Pin allocation**

AS-interface and auxiliary power supply

5-pin M12-socket and socket at the cable

	<p>1 AS-interface bus 1: + (light blue) 2: - (brown)</p> <p>2 Auxiliary power supply for 1: 0 V 2: + 24 V DC</p>		<p>Pin 1: AS-interface + Pin 2: 0 V (auxiliary power supply) Pin 3: AS-interface - Pin 4: +24 V (auxiliary power supply) Pin 5: Unused</p>
--	--	--	--

## Dimensions

Download CAD data → [www.festo.com](http://www.festo.com)

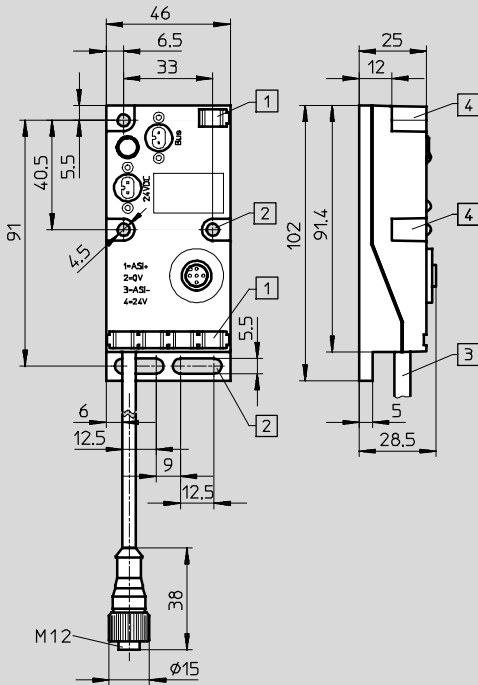

- 1 Inscription label mounting option
- 2 Mounting holes for surface mounting
- 3 Cable PUR-OB, length 1,000 mm
- 4 Mounting holes for ITEM profile 40 mm or other mounting option

## General technical data

Type		ASI-KVT-FKx2-M12	
AS-interface connection	Connection technology	AS-interface flat cable plug (must be ordered separately) Socket, M12x1, 4-pin, A-coded	
	Nominal voltage [V DC]	26.5 ... 31.6, reverse polarity protected	
	Residual ripple [mVss]	20	
24 V DC connection	Connection technology	AS-interface flat cable plug (must be ordered separately)	
	Nominal voltage [V DC]	24 (tolerance depends on the connected consuming devices)	
	Residual ripple [mVss]	4	
General data	Protection class (to EN 60529)	IP65 (fully assembled)	
	Cable length [mm]	1000	
	Cable cross-sectional area	4x 0.34 mm <sup>2</sup>	
	CE mark (see declaration of conformity)	To EU EMC Directive	
	Temperature range [°C]	Operation:	-5 ... +50
		Storage:	-20 ... +70
	Relative air humidity [%]	5 ... 90 (non-condensing)	
	Materials	Housing	PA, reinforced
		Cover	PA, reinforced
		Seal	PUR
		Cable	PUR
	Note on materials	RoHS-compliant	
	Shock test	To DIN IEC 68; +/-30 g at 11 ms, 15 cycles	
Continuous shock test	To DIN IEC 68; +/-15 g at 6 ms, 1000 cycles		
Vibration test	To DIN IEC 68; 0.35 mm at 10 ... 60 Hz, 5 g at 60 ... 150 Hz		
Protection against direct and indirect contact	PELV (Protected Extra-Low Voltage)		
Dimensions [mm]	102 x 46 x 28.5		
Weight [g]	190		
Mounting type	Via through-holes		
	On H-rail		



## Overview of DUO components

### DUO cable – KM12-DUO-M8-...

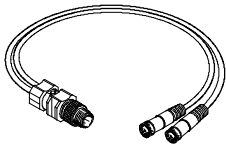

The DUO cables each combine two sensor signals (2x 3-pin cable) on one 4-pin plug.

This is routed to the 4-pin or 5-pin input socket of a valve terminal, the ASI-EVA or the compact I/O module.

3 variants

- 1 straight plug, 2 straight sockets (GDGD)
- 1 straight plug, 1 straight socket, 1 angled socket (GDWD)
- 1 straight plug, 2 angled sockets (WDWD)

### T-type plug connector NEDU-...-M12T4

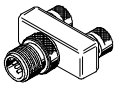

The plug connectors each combine two sensor/actuator signals on one 5-pin plug.

Variants:

- M12 plug, 2x socket M12, 5-pin
- M12 plug, 2x socket M8, 3-pin

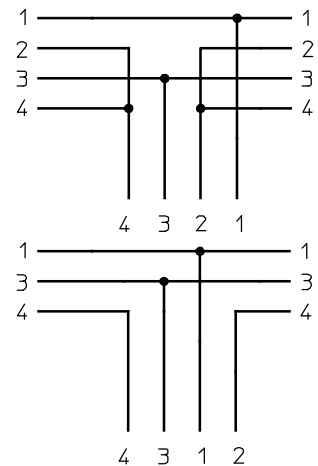

### DUO plug – SEA-5GS11-DUO

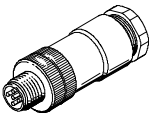

The DUO plug combines two sensor or actuator signals/cables in one housing.

General technical data – DUO cable				
Type		KM12-DUO-M8-GDGD	KM12-DUO-M8-GDWD	KM12-DUO-M8-WDWD
Cable length	[m]	0.5		
Cable composition	[mm <sup>2</sup> ]	3x 0.25		
Operating voltage range	[V AC]	0 ... 60		
	[V DC]	0 ... 75		
Current-carrying capacity	[A]	Max. 2.8		
Protection class (plugged and screwed in)		IP67		
Ambient temperature	Fixed cable installation	[°C]	-30 ... +70	
	Flexible cable installation	[°C]	-5 ... +70	
Connection		M12 → 2x M8		

## Overview – Other connecting cables

Extension cable – KM-12-M12-GSGD-... etc.

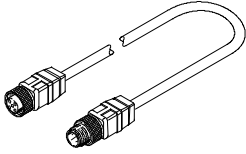

The connecting cables can be used to extend the cable length between a DUO cable and the inputs of a valve terminal, ASI-EVA or a compact

I/O module. They can also be used as AS-interface bus cables for M12 connection technology.

4 variants

- Length 0.15 m, diameter 0.34 mm<sup>2</sup>
- Length 1 m, diameter 0.34 mm<sup>2</sup>
- Length 2.5 m, diameter 0.25 mm<sup>2</sup>
- Length 5 m, diameter 0.25 mm<sup>2</sup>

## General technical data – Extension cable

Type		KM12-M12-GSGD-2,5	KM12-M12-GSGD-5	KM12-M12-GSWD-1-4	NEBU-M12G5-F-0,2-M12G4
Cable length	[m]	2.5	5	1	0.15
Cable composition	[mm <sup>2</sup> ]	4x 0.25		4x 0.34	4x 0.34
Operating voltage range	[V AC]	0 ... 60		0 ... 60	–
	[V DC]	0 ... 75		0 ... 75	24
Current-carrying capacity	[A]	Max. 3.8			
Protection class (plugged and screwed in)		IP67			
Ambient temperature	[°C]				
• Fixed cable installation		–30 ... +70			–5 ... +70
• Flexible cable installation		–5 ... +70			–5 ... +70
Connection		M12 → M12			

## Overview – Other accessories

Inscription labels IBS-...

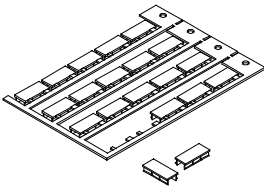

Convenient labelling system for

- flat cable sockets
- flat cable distributors
- individual valve interfaces
- compact I/O modules
- CPV valve terminals

H-rail NRH-35-2000

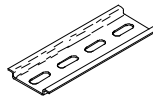







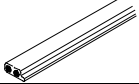
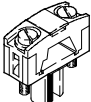

- For compact I/O modules
- CPV valve terminals
- For individual valve interfaces
- AS-interface power supply units



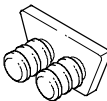

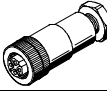
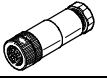
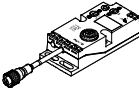
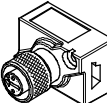

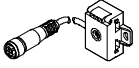
# AS-interface® components

Accessories

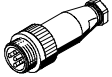

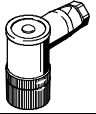

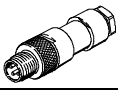
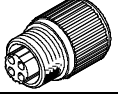
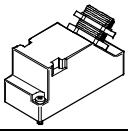
FESTO

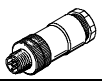
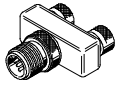
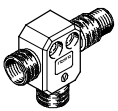
Ordering data				
	Description		Part No.	Type
<b>Bus connection</b>				
	AS-interface flat cable, yellow	100 m	18940	KASI-1,5-Y-100
	AS-interface flat cable, black	100 m	18941	KASI-1,5-Z-100
	Flat cable socket <sup>1)</sup>		18785	ASI-SD-FK
	Flat cable socket <sup>1)</sup>		Turned through 180°	196089
	Flat cable blanking plug		196090	ASI-SD-FK-BL
	AS-interface flat cable distributor	Parallel cable	18786	ASI-KVT-FK
	AS-interface flat cable distributor	Symmetrical cable	18797	ASI-KVT-FK-S
	Cable cap for flat cable (scope of delivery 50 pieces)		18787	ASI-KK-FK
	Cable sleeve (scope of delivery 20 pieces)		165593	ASI-KT-FK
	M12 socket for flat cable	With PG13.5 connector	18789	ASI-SD-PG-M12
	M12 socket for round cable	With PG9, 5-pin connector	18324	FBSD-GD-9-5POL
<b>Cable distributor</b>				
	AS-Interface data and load voltage supply to 2x socket M12, 4-pin		527474	ASI-KVT-FKx2-M12
	AS-Interface data and load voltage supply to socket M12, 4-pin		18788	ASI-SD-FK-M12
	AS-Interface data to socket M12, 4-pin		572225	NEFU-X22F-M12G4
	AS-Interface data and load voltage supply to socket M12, 4-pin		572226	NEFU-X24F-M12G4
	AS-Interface data and load voltage supply to socket M12, 4-pin, cable length 1 m		572227	NEFU-X24F-1-M12G4

1) Two flat cable connections per ASI-EVA must be connected or covered

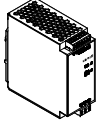
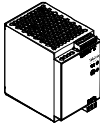
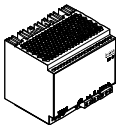
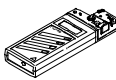
Ordering data				
	Description		Part No.	Type
<b>Sensor plugs</b>				
	Straight sensor plug	M12, 5-pin, PG7	175487	SEA-M12-5GS-PG7
	Straight sensor plug	M12, 4-pin, PG7	18666	SEA-GS-7
	Straight sensor plug	M12, PG9, 4-pin	18778	SEA-GS-9
	Angled sensor plug	M12, 4-pin	185498	SEA-M12-4WD-PG7
	Straight sensor plug for cable Ø 2.5 mm	M12, 4-pin	192008	SEA-4GS-7-2,5
	Straight sensor plug	M8, screw-in, 3-pin	192009	SEA-3GS-M8-S
	Straight sensor plug	M8, solderable, 3-pin	18696	SEA-GS-M8
	Harax sensor plug	4-pin	525928	SEA-GS-HAR-4POL
	Sub-D plug	25-pin	527522	SD-SUB-D-ST25
	Protective cap (scope of delivery 10 pieces)	M12	165592	ISK-M12
		M8	177672	ISK-M8
<b>DUO plugs</b>				
	Plug M12 for 2 sensor cables	4-pin, PG11	18779	SEA-GS-11-DUO
		5-pin, PG11	192010	SEA-5GS-11-DUO
<b>T-type plug connector</b>				
	Plug M12, 2x socket M12 5-pin		541596	NEDU-M12D5-M12T4
	Plug M8 3-pin, to M12 4-pin		541597	NEDU-M8D3-M12T4
	T-adapter for DH-485, M12 5-pin		171175	FB-TA-M12-5POL

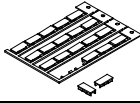
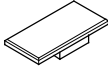
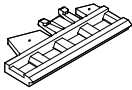
Ordering data			
	Description	Part No.	Type
<b>Connecting cables</b>			
	Modular system for connecting cables → Internet: nebu	-	NEBU-...
	Connecting cable, straight plug, angled socket type B for F coil	M12, straight, 5-pin, 0.5 m	542130 NEBV-B2W3P-F-0,5-M12G5
		M12, straight, 5-pin, 2.5 m	542133 NEBV-B2W3P-F-2,5-M12G5
	Connecting cable, straight plug, angled socket type C for EB coil	M12, straight, 5-pin, 0.5 m	542131 NEBV-C1W3P-F-0,5-M12G5
		M12, straight, 5-pin, 2.5 m	542134 NEBV-C1W3P-F-2,5-M12G5
	Connecting cable, straight plug, angled socket type KMYZ-9 for ZC coil	M12, straight, 5-pin, 0.5 m	542132 NEBV-Z2W2P-0,5-M12G5
		M12, straight, 5-pin, 2.5 m	542135 NEBV-Z2W2P-2,5-M12G5
	Connecting cable, straight plug, straight socket	M12, 4-pin/5-pin, 0.2 m	542129 NEBU-M12G5-F-0.2-M12G4
		M12, 4-pin, 2.5 m	18684 KM12-M12-GSGD-2,5
		M12, 4-pin, 5.0 m	18686 KM12-M12-GSGD-5
	Connecting cable, straight plug, angled socket	M12, 4-pin, 1.0 m	185499 KM12 M12-GSWD-1-4
	Connecting cable, straight plug, straight socket	M8, 0.5 m	175488 KM8-M8-GSGD-0,5
		M8, 1.0 m	175489 KM8-M8-GSGD-1
		M8, 2.5 m	165610 KM8-M8-GSGD-2,5
		M8, 5.0 m	165611 KM8-M8-GSGD-5
	Connecting cable, straight plug, straight socket	M12, 8-pin, 2.0 m	525617 KM12-8GD8GS-2-PU
	DUO cable M12 4-pin to 2xM8, 3-pin	2x straight socket	18685 KM12-DUO-M8-GDGD
		2x straight/angled socket	18688 KM12-DUO-M8-GDWD
		2x angled socket	18687 KM12-DUO-M8-WDWD

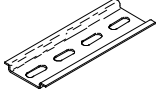
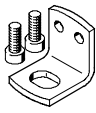
Ordering data			
	Description	Part No.	Type
<b>Miscellaneous</b>			
	Primary switched mode modular power supply AS-i power supply 4.8 A	547869	SVG-1/230VAC-ASI-5A
	Primary switched mode modular power supply 24 VDC power supply 5 A	547867	SVG-1/230-24VDC-5A
	Primary switched mode modular power supply 24 VDC power supply 10 A	547868	SVG-1/230-24VDC-10A
	Addressing device	18959	ASI-PRG-ADR
	Addressing cable	18960	KASI-ADR
<b>Inscription labels</b>			
	Inscription labels 8x20 mm in frames (20 pieces)	539388	IBS-8x20
	Inscription labels 6x10 in frames (64 pieces)	18576	IBS 6x10
	Inscription labels 9x20 in frames (20 pieces)	18182	IBS 9x20
	Inscription label holder for connection block, transparent, for paper foil label	533362	VMPA1-ST-1-4
	Inscription label holder for connection block, 4-fold, for IBS 6x10	544384	VMPA1 ST 2-4
<b>Mounting accessories</b>			
	Mounting for H-rail	170169	CP-TS-HS35
	Mounting for H-rail	526032	CPX-CPA-BG-NRH
	H-rail to EN 60715	35430	NRH-35-2000
	Mounting bracket	534416	VMPA-BG-RW