

Compact cylinders ADN/AEN, to ISO 21287



Compact cylinders ADN/AEN, to ISO 21287

Key features

At a glance

Sensor slots on three sides for flush mounting of proximity sensors

Piston rod with choice of male or female thread

Mounting option:
Female thread and through-hole

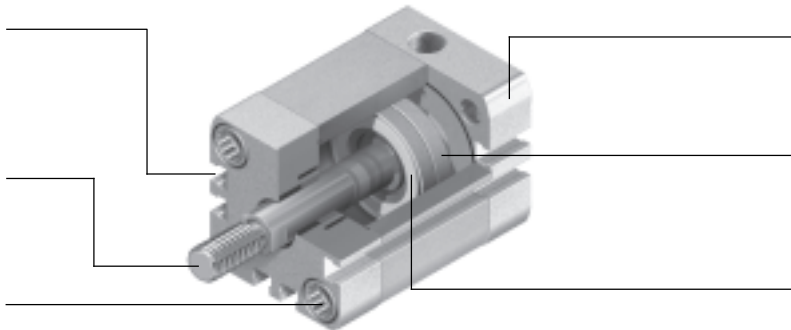

Centring hole in the end cap matches centring pins ZBS

Magnet for contactless position sensing

Integrated cushioning rings for absorbing residual energy at high speeds and machine cycles

More than the standard

- The compact cylinder series ADN/AEN complies with the standard ISO 21287
- The ADN/AEN is distinguished by its compact design and broad area of application thanks to the large number of variants
- The variants can be configured according to individual needs thanks to the modular product system

Powerful

- Flexible cushioning rings as standard for absorbing the residual energy facilitate high speeds and machine cycles
- Long service life thanks to exceptional cushioning characteristics and minimal friction factors
- The ADNP with bearing and end caps made of polymer is distinguished by its low weight

Convenient

- Easy to mount with a comprehensive range of mounting accessories for just about every type of installation
- Highly flexible thanks to the wide range of variants
- Contactless position sensing using proximity sensors

Reliable

- Optimised manufacturing methods, patented technology and more than 40 years of experience in the field of cylinders make Festo and ADN/AEN a great team

Mounting options

With through screw

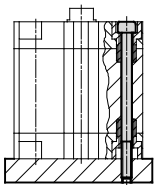

Direct mounting

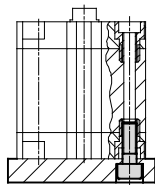

Size comparison between ISO 21287 and ISO 15552

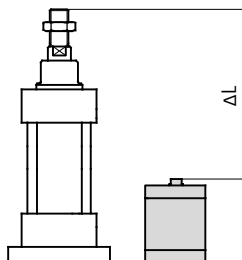

- Space savings of up to 50% compared with the standard ISO 15552

Cushioning types

Cushioning P

Mode of operation

- The drive is equipped with polymer flexible end-position cushioning

Application

- Small loads
- Low speeds
- Small cushioning capacity

Advantages

- No adjustment required
- Time-saving

Cushioning PPS

Mode of operation

- The drive is equipped with self-adjusting, pneumatic end-position cushioning

Application

- Larger loads
- Higher speeds
- Larger cushioning capacity

Advantages

- No adjustment required
- Up to four times greater cushioning capacity than ADN-...-P
- Time-saving
- Noise reduction





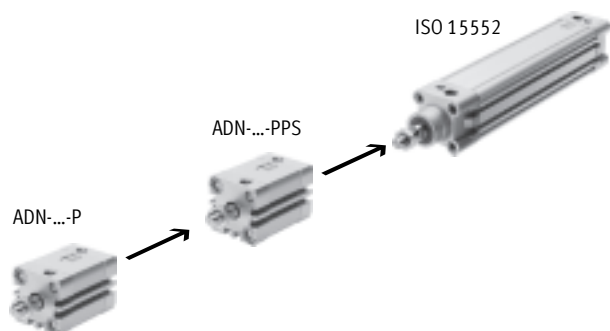











Cushioning capacity of ISO 21287 and ISO 15552

In terms of cushioning capacity, the compact cylinder ADN-...-PPS fills the gap between ADN-...-P and standard cylinders with ISO 15552.



Compact cylinders ADN, to ISO 21287

Key features







Variants from the modular product system		
Symbol	Key features	Description
	S1 Reinforced piston rod	Increased lateral forces. Absorbs many times more lateral force than a basic cylinder
	S2 Through piston rod	For working at both ends with the same force in the forward and return stroke, for attaching external stops
	S6 Heat-resistant seals	Temperature resistance up to max. 120 °C
	S10 Constant motion (slow speed) at low piston speeds	Suitable for slow stroke movements at a constant, judder-free speed over the full stroke of the cylinder. Seal contains silicone grease (not free of paint-wetting impairment substances)
	S11 Low friction	The special seals considerably reduce system wear. This corresponds to a considerably lower response pressure. Seal contains silicone grease (not free of paint-wetting impairment substances)
	S20 Through, hollow piston rod	For supplying vacuum, small parts, media, etc.
	K2 Extended male piston rod thread	–
	K5 Special piston rod thread	Metric standard thread to ISO
	K8 Extended piston rod	–
	K10 Smooth anodised aluminium piston rod	Ideal for use in welding environments: – Protection against welding spatter – Small working loads – Harder surface compared to steel – Long service life
	KP With clamping unit	Integrated clamping unit on the piston rod
	EL With end-position locking	Positive locking in the end position as a drop guard. If there is a drop in pressure, the piston rod is secured in its end position to prevent it from dropping
	Q Square piston rod	Protection against rotation. For correctly oriented feeding
	R3 High corrosion protection	All external cylinder surfaces comply with corrosion resistance class 3 to Festo standard 940 070. The piston rod is made from corrosion and acid resistant steel
	R8 Dust protection (wiper seal)	The cylinder is equipped with a hard-chrome plated piston rod and a rigid wiper seal, which protects against dry, dusty media
	TL Captive rating plate	Laser etched rating plate. For easy identification of components when it comes to replacement, even after years in a harsh environment
	TT Low temperature	Temperature resistance down to max. –40 °C

Software tools and configuration of Festo modular products
[→www.festo.com](http://www.festo.com)

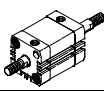
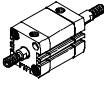
Compact cylinders ADN, to ISO 21287

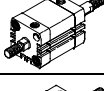
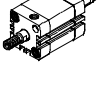
Product range overview

FESTO

Function	Version	Type	Piston Ø	Stroke	Position sensing	Cushioning		
						Fixed	Self-adjusting	
			[mm]	[mm]	A	P	PPS	
Double-acting	Basic version							
		ADN	12	5, 10, 15, 20, 25, 30, 40	1 ... 300	■	■	■ Ø 32 ... 80
			16	5, 10, 15, 20, 25, 30, 40, 50	1 ... 300			
			20, 25	5, 10, 15, 20, 25, 30, 40, 50, 60	1 ... 300			
			32, 40, 50	5, 10, 15, 20, 25, 30, 40, 50, 60, 80	1 ... 400			
			63	10, 15, 20, 25, 30, 40, 50, 60, 80	1 ... 400			
			80, 100	10, 15, 20, 25, 30, 40, 50, 60, 80	1 ... 500			
			125	-	1 ... 500			
		ADN-...-S2 Through piston rod	12, 16, 20, 25	-	1 ... 300	■	■	■ Ø 32 ... 80
			32, 40, 50, 63	-	1 ... 400			
			80, 100, 125	-	1 ... 500			
		ADN-...-S20 Through, hollow piston rod	16, 20, 25	-	1 ... 300	■	■	■ Ø 32 ... 80
			32, 40, 50, 63	-	1 ... 400			
			80, 100, 125	-	1 ... 500			
	Reinforced piston rod							
		ADN-...-S1	25	-	5 ... 300	■	■	-
			40, 63	-	10 ... 400			
			100	-	10 ... 500			
	Non-rotating with square piston rod							
		ADN-...-Q	12, 16, 20, 25	-	1 ... 300	■	■	-
			32, 40, 50, 63	-	1 ... 400			
			80, 100, 125	-	1 ... 500			
		ADN-...-Q-S2 Through piston rod	12, 16, 20, 25	-	1 ... 300	■	■	-
			32, 40, 50, 63	-	1 ... 400			
			80, 100, 125	-	1 ... 500			
		ADN-...-Q-S20 Through, hollow piston rod	16, 20, 25	-	1 ... 200	■	■	-
			32, 40, 50, 63, 80	-	1 ... 300			
			100, 125	-	1 ... 400			
Standard hole pattern, with clamping unit								
	ADN-...-KP	20, 25	-	10 ... 300	■	■	-	
		32, 40, 50, 63	-	10 ... 400				
		80, 100	-	10 ... 500				
Standard hole pattern, with end-position locking								
	ADN-...-EL	20, 25	-	10 ... 300	■	■	-	
		32, 40, 50, 63	-	10 ... 400				
		80, 100	-	10 ... 500				
With polymer end caps								
	ADNP	20, 25	5, 10, 15, 20, 25, 30, 40, 50, 60	-	■	■	-	
		32, 40, 50	10, 15, 20, 25, 30, 40, 50, 60, 80					

Compact cylinders ADN, to ISO 21287





Product range overview

FESTO

Type	Male piston rod thread	Female piston rod thread	Extended male piston rod thread	Special piston rod thread	Extended piston rod	Smooth anodised piston rod	Heat-resistant seals max. 120 °C	Slow speed (constant motion)	Low friction	High corrosion protection	Dust protection	Low temperature	→ Page/Internet
	A	I	K2	K5	K8	K10	S6	S10	S11	R3	R8	TT	
Basic version													
ADN	■	■	■	■	■	■ ∅ 20 and above	■	■	■	■	■ ∅ 20 and above	■ ∅ 20 ... 100	13
ADN-...-S2 Through piston rod	■	■	■	■	■	-	■	-	-	-	-	■ ∅ 20 ... 100	13
ADN-...-S20 Through, hollow piston rod	■	-	■	■	■	-	■	-	-	-	-	-	13
Reinforced piston rod													
ADN-...-S1	■	■	■	■	■	-	■	-	-	■	-	-	13
Non-rotating with square piston rod													
ADN-...-Q	■	■	■	■	■	-	■	-	-	-	-	-	13
ADN-...-Q-S2 Through piston rod	■	■	■	■	■	-	■	-	-	-	-	-	13
ADN-...-Q-S20 Through, hollow piston rod	■	-	■	■	■	-	■	-	-	-	-	-	13
Standard hole pattern, with clamping unit													
ADN-...-KP	■	■	■	■	■	-	-	-	-	-	-	-	40
Standard hole pattern, with end-position locking													
ADN-...-EL	■	■	■	■	■	-	-	-	-	-	-	-	49
With polymer end caps													
ADNP	■	■	-	-	-	-	-	-	-	-	-	-	75

Compact cylinders ADN, to ISO 21287

Product range overview

Function	Version	Type	Piston Ø	Stroke	Position sensing	Cushioning		
			[mm]			[mm]	Fixed	Self-adjusting
					A	P	PPS	
Double-acting	Standard hole pattern, non-rotating with yoke							
		ADNGF	12	5, 10, 15, 20, 25, 30, 40	1 ... 200	■	■	■ Ø 32 ... 80
			16	5, 10, 15, 20, 25, 30, 40, 50	1 ... 200			
			20, 25	5, 10, 15, 20, 25, 30, 40, 50, 60	3 ... 200			
			32, 40, 50	5, 10, 15, 20, 25, 30, 40, 50, 60, 80	5 ... 300			
			63, 80	10, 15, 20, 25, 30, 40, 50, 60, 80	5 ... 300			
		ADNGF-...-S2 Through piston rod	12, 16	–	1 ... 200	■	■	■ Ø 32 ... 80
			20, 25		3 ... 200			
			32, 40, 50, 63, 80, 100		5 ... 250			
	Standard hole pattern, high-force cylinder							
		ADNH	25	–	1 ... 150	■	■	–
			40					
63								
100								
Standard hole pattern, multi-position cylinder								
	ADNM	25	–	1 ... 2,000	■	■	–	
		40						
		63						
		100						

Compact cylinders ADN, to ISO 21287



Product range overview

FESTO

Type	Male piston rod thread	Female piston rod thread	Extended male piston rod thread	Special piston rod thread	Extended piston rod	Heat-resistant seals max. 120 °C	→ Page/Internet
	A	I	K2	K5	K8	S6	
Standard hole pattern, non-rotating with yoke							
ADNGF	-	-	-	-	-	■	adngf
ADNGF-...-S2 Through piston rod	-	-	-	-	-	■	adngf
Standard hole pattern, high-force cylinder							
ADNH	■	■	■	■	■	■	adnh
Standard hole pattern, multi-position cylinder							
ADNM	■	■	■	■	■	■	adnh

Compact cylinders AEN, to ISO 21287

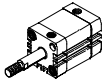
Product overview

Function	Version	Type	Piston \varnothing	Stroke	Position sensing	Cushioning
			[mm]	[mm]	A	P
Single-acting	Basic version					
		AEN	12	1 ... 10	■	■
			16, 20, 25, 32, 40, 50, 63, 80, 100	1 ... 25		
		AEN-...-Z pulling	12	1 ... 10	■	■
			16, 20, 25, 32, 40, 50, 63, 80, 100	1 ... 25		
	Non-rotating with square piston rod					
	AEN-...-Q	16	1 ... 25	■	■	
		20, 25, 32, 40, 50, 63, 80, 100	1 ... 25			

Compact cylinders AEN, to ISO 21287

Product overview



Type	Male piston rod thread	Female piston rod thread	Extended male piston rod thread	Special piston rod thread	Extended piston rod	Smooth anodised piston rod	Heat-resistant seals up to max. 120 °C	→ Page/Internet
	A	I	K2	K5	K8	K10	S6	
Basic version								
AEN	■	■	■	■	■	■ ∅ 20 and above	■	59
AEN-...-Z pulling	■	■	■	■	■	■ ∅ 20 and above	■	59
Non-rotating with square piston rod								
AEN-...-Q	■	■	■	■	■	-	■	59

Compact cylinders ADN/AEN, to ISO 21287

Peripherals overview

FESTO

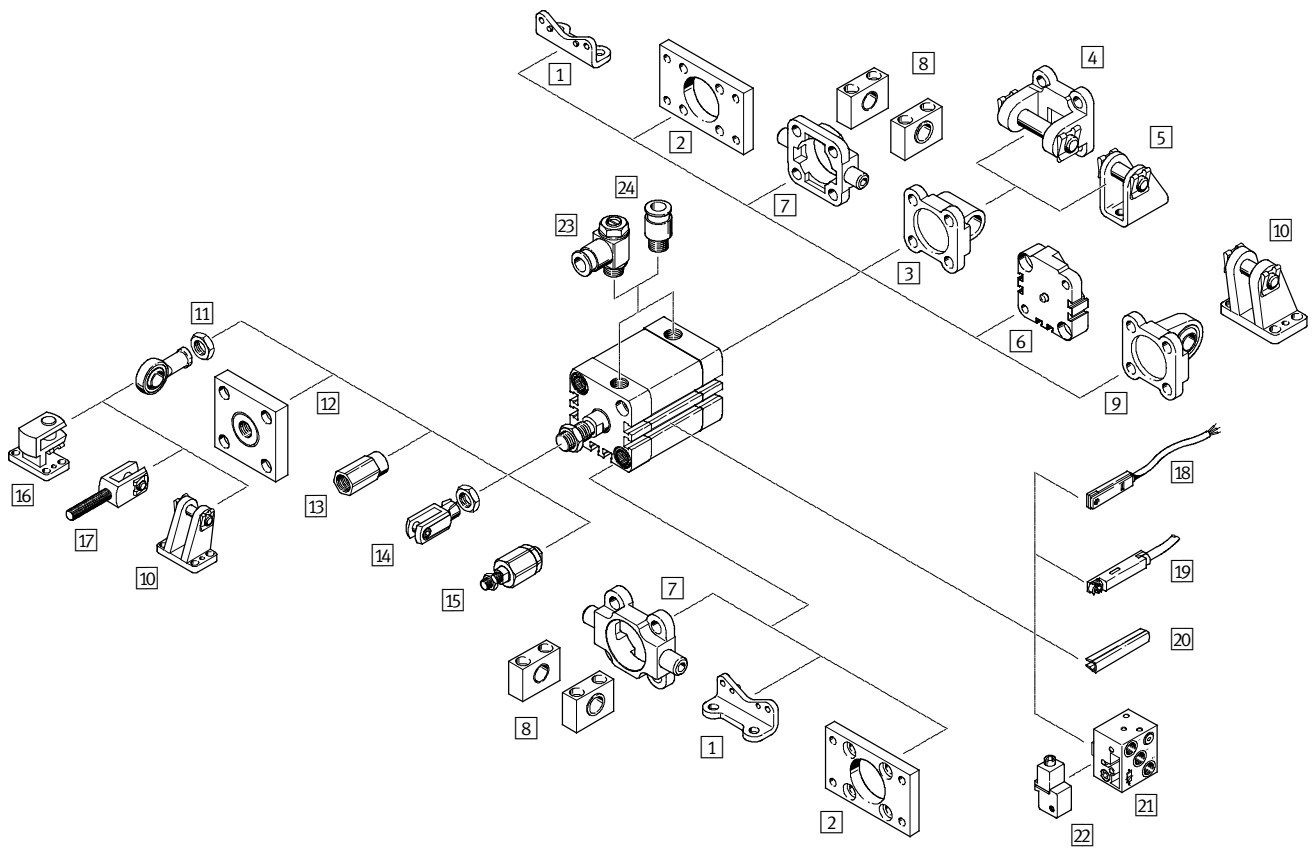

Compact cylinders ADN/AEN, to ISO 21287

Peripherals overview

Mounting attachments and accessories		
	Brief description	→ Page/Internet
1	Foot mounting HNA	For bearing or end caps 79
2	Flange mounting FNC	For bearing or end caps 80
3	Swivel flange SNCL	For end caps 81
4	Swivel flange SNCB	For swivel flange SNCL 85
5	Clevis foot LBN/CRLBN	For swivel flange SNCL 84
6	Multi-position kit DPNA	For connecting two cylinders with identical piston \varnothing to form a multi-position cylinder 83
7	Trunnion flange ZNCF/CRZNG	For bearing caps 86
8	Trunnion support LNZG	For trunnion flange ZNCF/CRZNG 87
9	Swivel flange SNCS	For end caps 82
10	Clevis foot LBG	For swivel flange SNCS 82
11	Rod eye SGS/CRSGS	With spherical bearing 88
12	Coupling piece KSG/KSZ	For compensating radial deviations 88
13	Adapter AD	For mounting a vacuum suction cup on a hollow cylinder piston rod 88
14	Rod clevis SG/CRSG	Permits a swivelling movement of the cylinder in one plane 88
15	Self-aligning rod coupler FK	For compensating radial and angular deviations 88
16	Right-angle clevis foot LQG	For rod eye SGS 89
17	Rod clevis SGA	With male thread 88
18	Proximity sensor SME/SMT-8	Can be integrated in the sensor slot of the cylinder profile barrel 91
19	Proximity sensor SME/SMT-8M	Can be integrated in the sensor slot of the cylinder profile barrel 91
20	Slot cover ABP-5-S	For protecting the sensor cable and keeping dirt out of the sensor slots 91
21	Proximity sensor SMPO-8E	Pneumatic output signal 91
22	Mounting kit SMB-8E	For proximity sensor SMPO-8E 91
23	One-way flow control valve GRLA/GRLZ	For speed regulation 89
24	Push-in fitting QS	For connecting compressed air tubing with standard external diameters quick star

Compact cylinders ADN, to ISO 21287

Type codes

		ADN	50	50	A	P	A	S2
Type								
Double-acting								
ADN	Compact cylinder							
Piston Ø [mm]								
Stroke [mm]								
Piston rod thread								
A	Male thread							
I	Female thread							
Cushioning								
P	Flexible cushioning rings/pads at both ends							
PPS	Pneumatic cushioning, self-adjusting at both ends							
Position sensing								
A	Via proximity sensor							
Variant								
Q	Square piston rod							
S1	Reinforced piston rod							
S2	Through piston rod							
S20	Through, hollow piston rod							
K2	Piston rod with extended male thread							
K5	Piston rod with special thread							
K8	Extended piston rod							
K10	Smooth anodised piston rod							
S6	Heat-resistant seals up to max. 120 °C							
S10	Slow speed (constant motion)							
S11	Low friction							
R3	High corrosion protection							
R8	Dust protection							
TL	Captive rating plate							
TT	Low temperature							

Compact cylinders ADN, to ISO 21287

Technical data

Function

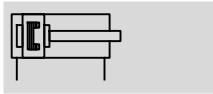

Variants → 3



Ø - Diameter
12 ... 125 mm

Stroke length
1 ... 500 mm

www.festo.com

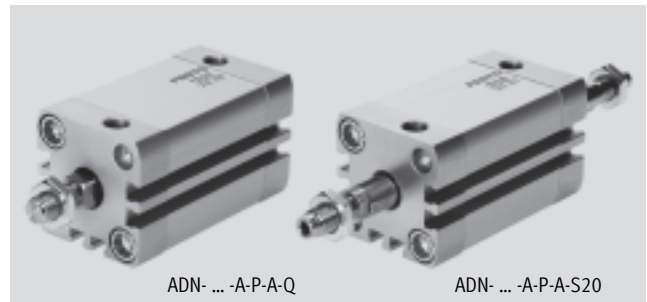
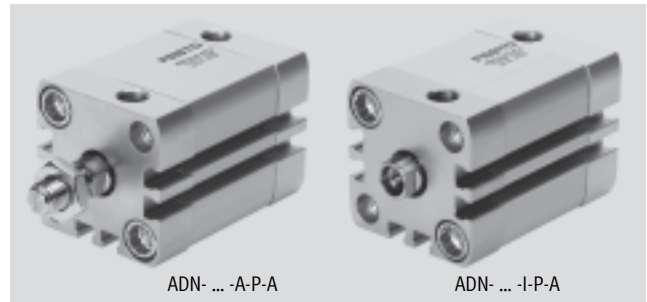

General technical data												
Piston Ø	12	16	20	25	32	40	50	63	80	100	125	
Design	Piston											
	Piston rod											
	Cylinder barrel											
Mode of operation	Double-acting											
Cushioning												
P	Flexible cushioning rings/pads at both ends											
PPS	-					Pneumatic cushioning, self-adjusting at both ends					-	
Cushioning length												
PPS	[mm]	-			4	5	6	7	7.5	-		
Position sensing	Via proximity sensor											
Type of mounting	Via through-hole											
	Via female thread											
	Via accessories											
Mounting position	Any											

Technical data – Basic version and variants							
Piston Ø	12	16	20	25	32	40	
Pneumatic connection	M5	M5	M5	M5	G1/8	G1/8	
Female piston rod thread							
-	M3	M4	M6	M6	M8	M8	
K5	-	-	M5	M5	M6	M6	
S1	-	-	-	M6	-	M10	
K5-S1	-	-	-	M5	-	M8	
Male piston rod thread							
-	M5	M6	M8	M8	M10x1.25	M10x1.25	
K5	M6	M8	M10, M10x1.25	M10, M10x1.25	M10, M12	M10, M12	
S1	-	-	-	M8	-	M12x1.25	
K5-S1	-	-	-	M10, M10x1.25	-	M10x1.25, M12	
Max. torsional backlash of piston rod [°]							
Q	2	1.8	1.6	1.6	1.2	1.2	

Compact cylinders ADN, to ISO 21287

FESTO

Technical data

Technical data – Basic version and variants					
Piston Ø	50	63	80	100	125
Pneumatic connection	G $\frac{1}{8}$	G $\frac{1}{8}$	G $\frac{1}{8}$	G $\frac{1}{8}$	G $\frac{1}{4}$
Female piston rod thread					
–	M10	M10	M12	M12	M16
K5	M8	M8	M10	M10	–
S1	–	M12	–	M16	–
K5-S1	–	M10	–	–	–
Male piston rod thread					
–	M12x1.25	M12x1.25	M16x1.5	M16x1.5	M20x1.5
K5	M12, M16	M12, M16	M16, M20	M16, M20, M20x1.5	M20
S1	–	M16x1.5	–	M20x1.5	–
K5-S1	–	M12x1.25, M16	–	M16x1.5, M20	–
Max. torsional backlash of piston rod [°]					
Q	1	1	0.8	0.8	0.8

Operating and environmental conditions												
Piston Ø	12	16	20	25	32	40	50	63	80	100	125	
Operating medium	Compressed air in accordance with ISO 8573-1:2010 [7:4:4]											
Note on operating/pilot medium	Operation with lubricated medium possible (in which case lubricated operation will always be required)											
Operating pressure [bar]												
–	1 ... 10		0.6 ... 10									
PPS	–				1.5 ... 10		1 ... 10			–		
Q	1.3 ... 10		1 ... 10		0.8 ... 10			0.6 ... 10				
S1	–			1 ... 10	–	1 ... 10	–	1 ... 10	–	1 ... 10	–	
S2, S20	1.5 ... 10	1.3 ... 10	1.2 ... 10		1 ... 10			0.8 ... 10				
S6	1 ... 10		0.6 ... 10									
S11	0.45 ... 10				0.25 ... 10							
R8, TT	–		1.5 ... 10			1 ... 10			–			
Ambient temperature ¹⁾ [°C]												
–	–20 ... +80											
S6	0 ... +120											
R3	–20 ... +80											
TT	–		–40 ... +80							–		
Corrosion resistance class CRC ²⁾												
–	2											
R3	3											
ATEX	Specified types → www.festo.com											

1) Note operating range of proximity sensors

2) Corrosion resistance class 2 according to Festo standard 940 070

Components subject to moderate corrosion stress. Externally visible parts with primarily decorative surface requirements which are in direct contact with a normal industrial environment or media such as coolants or lubricating agents.

Corrosion resistance class 3 according to Festo standard 940 070

Components subject to high corrosion stress. External visible parts in direct contact with industrial atmospheres or media such as solvents and cleaning agents, with a predominantly functional requirement for the surface.

Compact cylinders ADN, to ISO 21287

Technical data

FESTO

Forces [N] and impact energy [J]											
Piston Ø	12	16	20	25	32	40	50	63	80	100	125
Theoretical force at 6 bar, advancing											
–	68	121	188	295	483	754	1,178	1,870	3,016	4,712	7,363
S1	–	–	–	295	–	754	–	1,870	–	4,712	–
S2	51	90	141	247	415	686	1,057	1,750	2,827	4,524	7,069
Theoretical force at 6 bar, retracting											
–	51	90	141	247	415	686	1,057	1,750	2,827	4,524	7,069
S1	–	–	–	247	–	633	–	1,681	–	4,417	–
S2	51	90	141	247	415	686	1,057	1,750	2,827	4,524	7,069
Max. impact energy in the end positions											
–	0.07	0.15	0.2	0.3	0.4	0.7	1	1.3	1.8	2.5	3.3
S1	–	–	–	0.3	–	0.7	–	1.3	–	2.5	–
S6	0.035	0.075	0.1	0.15	0.2	0.35	0.5	0.65	0.9	1.25	1.75
K10	–	–	0.16	0.24	0.32	0.56	0.8	1	1.4	2	2.6
S20	–	0.016	0.024	0.083	0.15	0.39	0.48	0.62	0.8	0.9	0.95

 Note
This data represents the maximum values that can be achieved. The maximum permissible impact energy must be observed.

Permissible impact velocity:
$$v_{perm.} = \sqrt{\frac{2 \times E_{perm.}}{m_{dead} + m_{load}}}$$

Maximum permissible load:
$$m_{load} = \frac{2 \times E_{perm.}}{v^2} - m_{dead}$$

$v_{perm.}$ Permissible impact velocity
 $E_{perm.}$ Max. impact energy
 m_{dead} Moving load (drive)
 m_{load} Moving effective load

 Note
In combination with PPS cushioning, the maximum impact energy is still obtained.

Max. energy conversion capacity [J]					
Piston Ø	32	40	50	63	80
For PPS cushioning	1	1.7	2.8	4.8	8

Max. lateral force F_q as a function of the projection x

Ø 12 ... 63

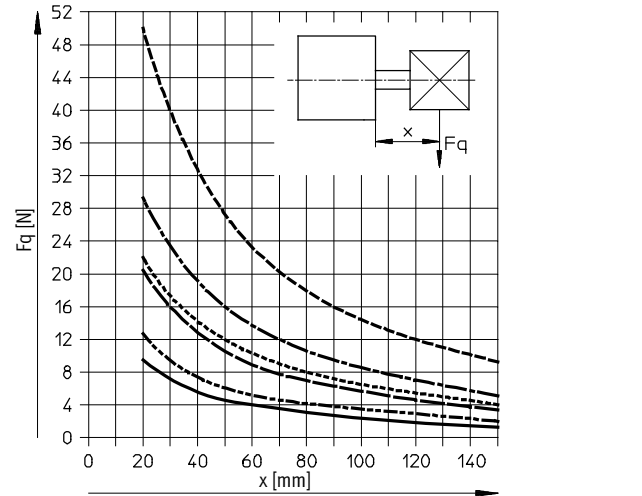

- Ø 12
- - - - - Ø 16
- · — · — Ø 20
- · - · - · - Ø 25
- · — · — · - Ø 32/40
- · - · - · - Ø 50/63

Ø 80 ... 125

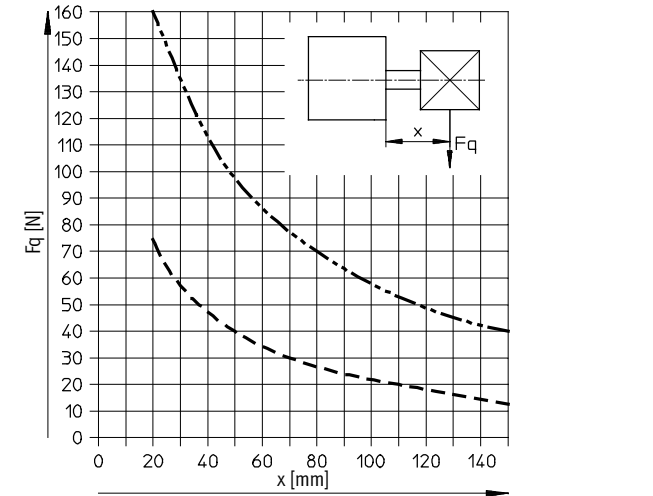

- - - - - Ø 80/100
- · - · - · - Ø 125

Compact cylinders ADN, to ISO 21287

Technical data

FESTO

Max. lateral force F_q as a function of the projection x and the lever arm a

Q – Square piston rod

Ø 12

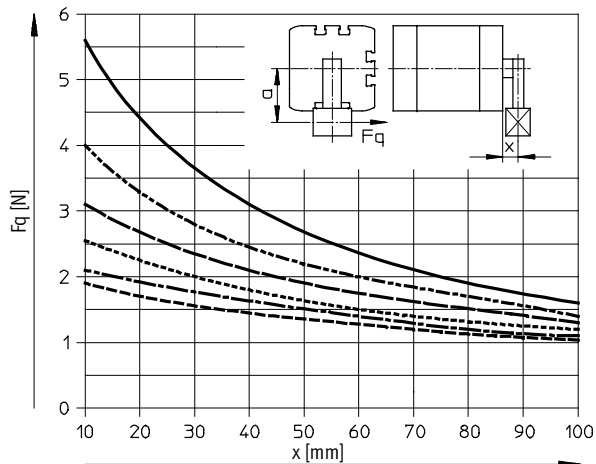

- a = 5 mm
- - - a = 10 mm
- · - a = 15 mm
- · · - a = 20 mm
- · · · - a = 25 mm
- · · · · - a = 30 mm

Ø 16

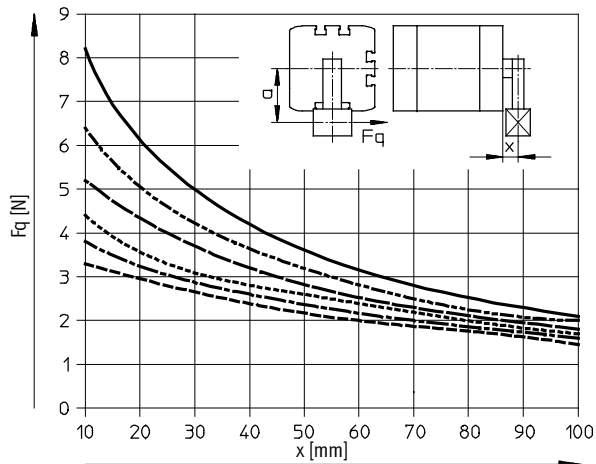

- a = 5 mm
- - - a = 10 mm
- · - a = 15 mm
- · · - a = 20 mm
- · · · - a = 25 mm
- · · · · - a = 30 mm

Ø 20/25

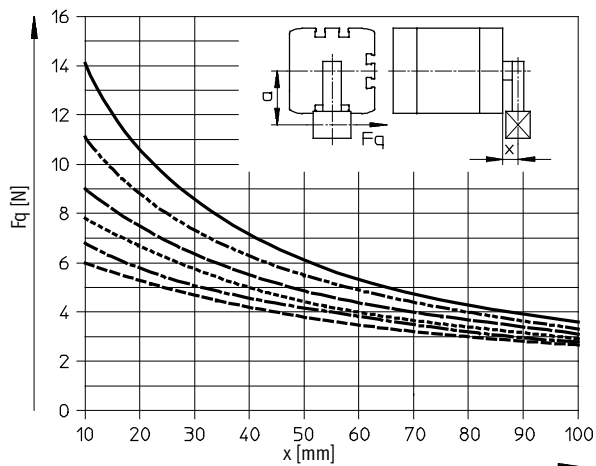

- a = 5 mm
- - - a = 10 mm
- · - a = 15 mm
- · · - a = 20 mm
- · · · - a = 25 mm
- · · · · - a = 30 mm

Ø 32/40

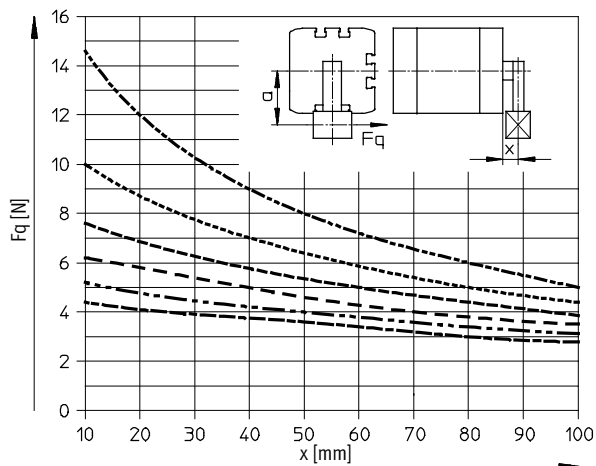

- · · · · - a = 10 mm
- · · · · · - a = 20 mm
- · · · · · · - a = 30 mm
- · · · · · · · - a = 40 mm
- · · · · · · · · - a = 50 mm
- · · · · · · · · · - a = 60 mm

- - Note

• Torques on the piston rod are to be excluded with projections greater than those shown in the graphs.

• If $a = 0$, the corresponding lateral load line of the basic ADN version can be used (→ 15).

Compact cylinders ADN, to ISO 21287

Technical data

FESTO

Max. lateral force F_q as a function of the projection x and the lever arm a

Q – Square piston rod

Ø 50/63

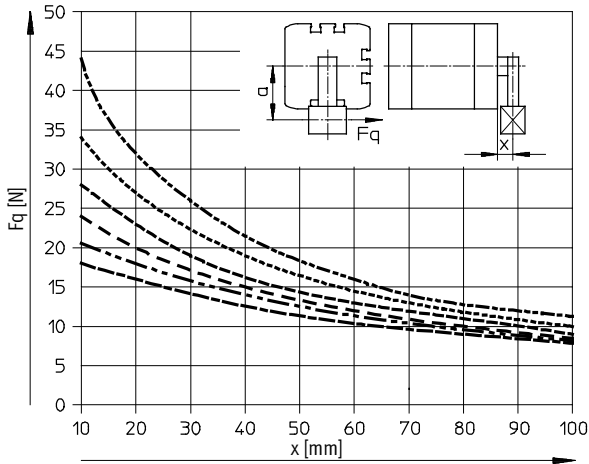

- a = 10 mm
- a = 20 mm
- a = 30 mm
- a = 40 mm
- a = 50 mm
- a = 60 mm

Ø 80/100

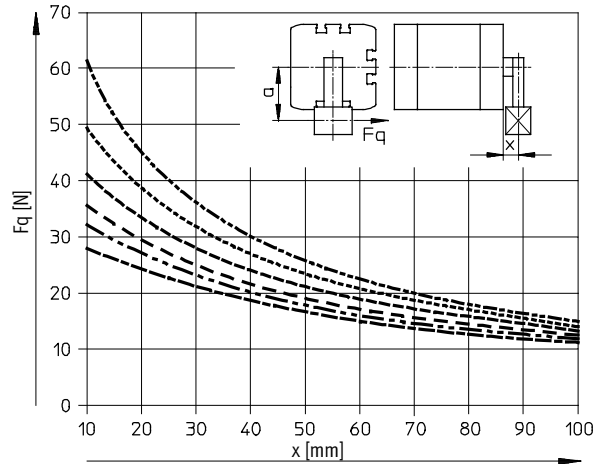

- a = 10 mm
- a = 20 mm
- a = 30 mm
- a = 40 mm
- a = 50 mm
- a = 60 mm

Ø 125

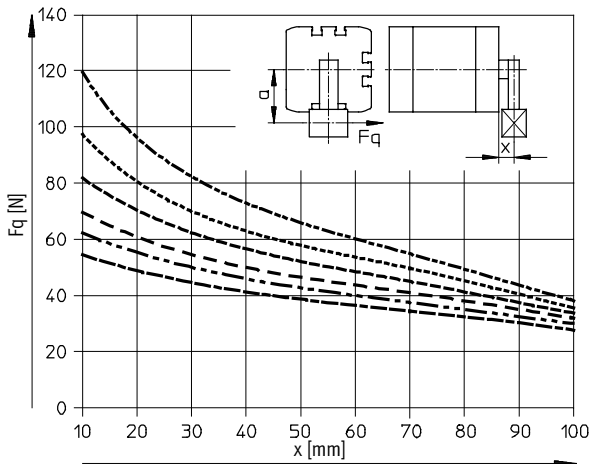

- a = 10 mm
- a = 20 mm
- a = 30 mm
- a = 40 mm
- a = 50 mm
- a = 60 mm

- Note

• Torques on the piston rod are to be excluded with projections greater than those shown in the graphs.

• If $a = 0$, the corresponding lateral load line of the basic ADN version can be used (→ 15).

Compact cylinders ADN, to ISO 21287

Technical data

FESTO

Max. lateral force F_q as a function of the projection x

S1 – Reinforced piston rod

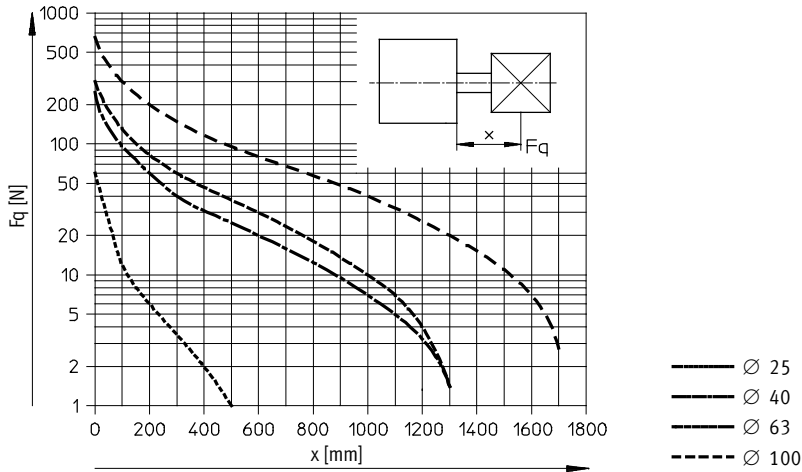

Weight [g]											
Piston \varnothing	12	16	20	25	32	40	50	63	80	100	125
Product weight with 0 mm stroke	77	79	131	156	265	346	540	722	1,300	2,154	2,880
Additional weight per 10 mm stroke	12	14	21	23	30	37	51	59	79	98	117
Moving load with 0 mm stroke	9	15	30	50	60	80	140	180	400	570	1,080
Additional load per 10 mm stroke	2	4	6	6	9	9	16	16	25	25	39

Materials

Sectional view

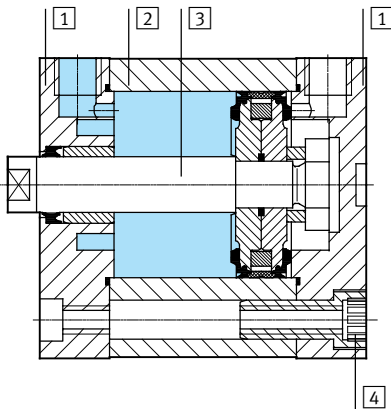

Compact cylinder	Basic version, Q	R8	S6, S10, S11	R3	K10
1 Bearing and end cap	Anodised aluminium				
2 Cylinder barrel	Anodised aluminium				
3 Piston rod	High-alloy steel	Hard-chromium plated tempered steel	High-alloy steel		Anodised aluminium
4 Flange screws					
\varnothing 12 ... 16	High-alloy steel			High-alloy steel	–
\varnothing 20 ... 25	Galvanised steel			High-alloy steel	Galvanised steel
\varnothing 32 ... 63	Galvanised steel			Steel, zinc flake coating	Galvanised steel
\varnothing 80 ... 125	Standard screws, galvanised steel			Standard screws, high-alloy steel	Standard screws, galvanised steel
– Seals	Polyurethane		Fluoro elastomer	Polyurethane	
Note on materials	RoHS-compliant				

Compact cylinders ADN, to ISO 21287

Technical data

FESTO

Dimensions – Basic version

Download CAD data → www.festo.com

∅ 12 ... 63

∅ 80 ... 125

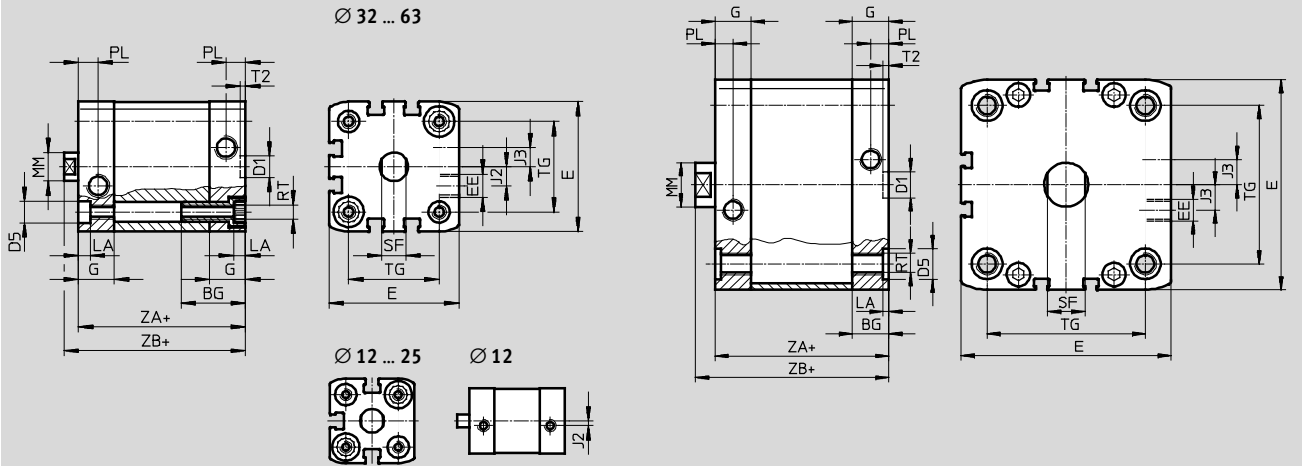

+ = plus stroke length

∅ [mm]	BG min.	D1 ∅ H9	D5 ∅ F9	E	EE	G	J2	J3	LA +0.2
12	17	9	6	27.5 ^{+0.3}	M5	10.5	2	-	3.5
16				29 ^{+0.3}		12	2.6		
20				35.5 ^{+0.3}					
25				39.5 ^{+0.3}					
32	26	9	9	47 ^{+0.3}	G1/8	15	6	5	
40				54.5 ^{+0.3}			8		
50				65.5 ^{+0.3}			11.5		
63	75.5 ^{+0.3}								
80	17	12	15	95.5 ^{+0.6}	G1/4	16.5	20	2.6	
100	21.5			113.5 ^{+0.6}		21.5			
125	20	-	-	134.6 ^{+0.3}	G1/4	20	21.15	-	

∅ [mm]	MM ∅ h8	PL +0.2	RT	SF h13	T2 +0.1	TG ±0.2	ZA ±0.3	ZB	
								+1.2	PPS +1.3
12	6	6	M4	5	2.1	16	35	39.2	-
16	8			7		18	37	39.7	
20	10			9		22	39	44.5	
25									
32	12	8.2	M6	10	2.6	32.5	44	50	50.6
40				38		45	51.1	51.7	
50				16		M8	13	46.5	49
63	56.5	54	56.5		57				
80	20	10.5	M10	17	72	67	62.9	63.4	
100					89	76	-		
125	25	-	M12	21	110	81	92	-	

Compact cylinders ADN, to ISO 21287

Technical data

FESTO

Dimensions – Variants

Download CAD data → www.festo.com

Basic version

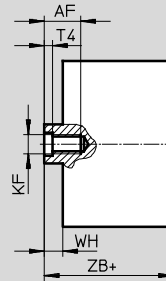
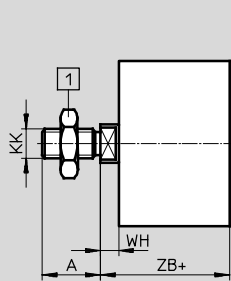

1 Hex nut DIN 439-B
only with $\varnothing 32 \dots 125$

+ = plus stroke length

S2 – Through piston rod

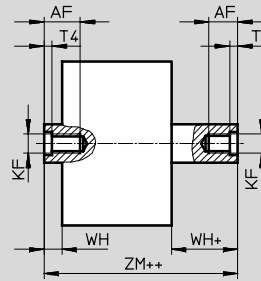
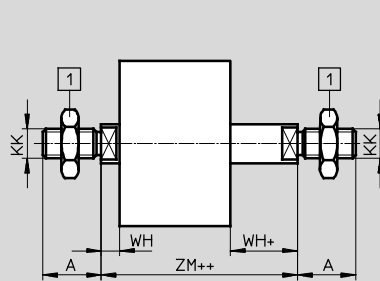

1 Hex nut DIN 439-B
only with $\varnothing 32 \dots 125$

+ = plus stroke length

++ = plus 2x stroke length

S20 – Through, hollow piston rod

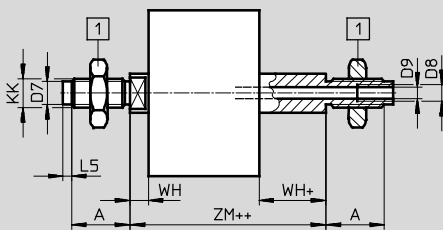

-  - Note

In combination with variants
S2/S20, the piston rod is extended
at one end.

1 Hex nut DIN 439-B
only with $\varnothing 32 \dots 125$

+ = plus stroke length

++ = plus 2x stroke length

K2 – Extended male piston rod thread

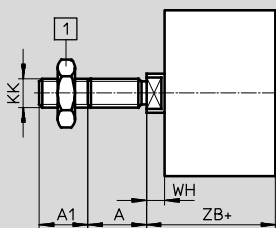

1 Hex nut DIN 439-B
only with $\varnothing 32 \dots 125$

+ = plus stroke length

K5 – Special piston rod thread

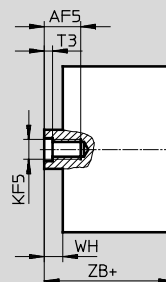
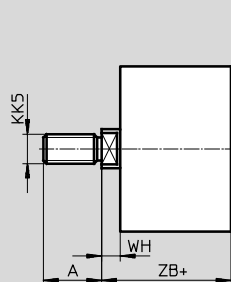

+ = plus stroke length

Compact cylinders ADN, to ISO 21287

Technical data

FESTO

Dimensions – Variants

Download CAD data → www.festo.com

K8 – Extended piston rod

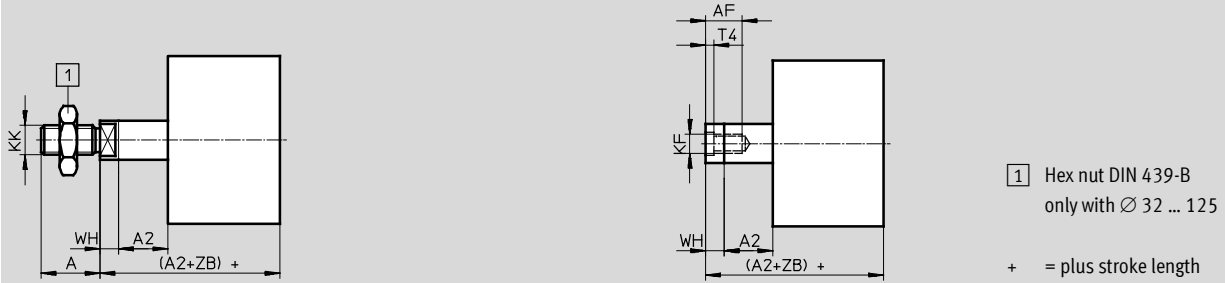

R8 – Dust protection / TT – Low temperature

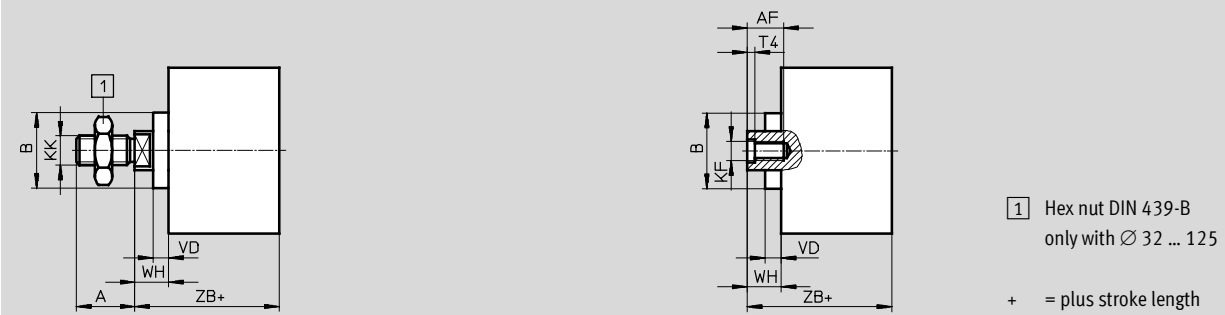

\varnothing	A	A1	A2	AF	AF5	B	D7	D8	D9	L5	KF	KF5	KK										
[mm]	-0.5			min.	min.	\varnothing	\varnothing		\varnothing														
12	10	1 ... 10	1 ... 300	8	-	-	-	-	-	-	M3	-	M5										
16	12			10			4.5		3.2	3	M4		M6										
20	16			14	12	18	6		3.8	2	M6	M5	M8										
25	19	1 ... 20	1 ... 400	16	14	27	8	-	4.5	3	M8	M6	M10x1.25										
32														22	20	16	31	10	6	3.5	M10	M8	M12x1.25
40																							
50	28	1 ... 30	1 ... 500	20	20	35	-	G $\frac{1}{8}$	8	-	M12	M10	M16x1.5										
63																							
80	40	1 ... 40												25	-	-		G $\frac{1}{4}$	11.7		M16	-	M20x1.5

\varnothing	KK5	T3	T4	VD	WH			ZB			ZM	
					+1.3	PPS +1.4	R8/TT +1.3	+1.2	PPS +1.3	R8/TT +1.2		PPS
[mm]												
12	M6	-	1.5	-	4.2	-	-	39.2	-	-	44.5 ^{+0.5}	-
16	M8				4.7			39.7			45.7 ^{+0.5}	
20	M10x1.25	2	2.6	5.2	5.5	-	10.5	42.5	-	47.5	49.5 ^{+0.5}	-
25	M10							44.5			51.5 ^{+0.5}	
32	M10	2.6	3.3	6.4	6	6.5	12.5	50	50.6	56.5	57.5 ^{+0.5}	58.6 ^{+0.6}
40	M12				6.1	6.6		51.1	51.7	57.5	58.6 ^{+0.6}	59.7 ^{+0.7}
50	M12				7.7	8.2		14.7	52.7	53.2	59.7	62.0 ^{+0.6}
63	M16	3.3	4.7	6.4	7.5	8	14.6	56.5	57	63.6	65.4 ^{+0.6}	66.5 ^{+0.7}
80	M16				8.9	9.4	15.4	62.9	63.4	69.4	73.2 ^{+0.6}	74.3 ^{+0.7}
100	M20x1.5	4.7	6.1	6.4	9	-	15.5	76	-	82.5	86.4 ^{+0.6}	-
	M20											
125	M20	-	7	-	11	-	-	92	-	-	104.4 ^{+0.6}	-

Compact cylinders ADN, to ISO 21287

Technical data

FESTO

Dimensions – Variants

Download CAD data → www.festo.com

Q – Square piston rod

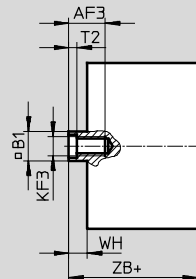
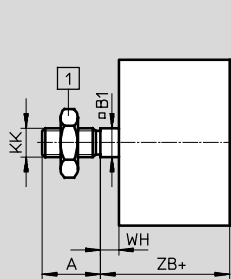

1 Hex nut DIN 439-B
only with $\varnothing 32 \dots 125$

+ = plus stroke length

Q-S2 – Square, through piston rod

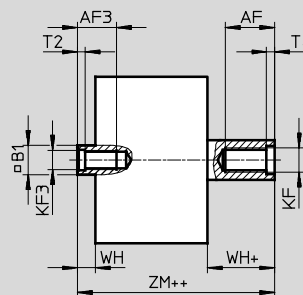
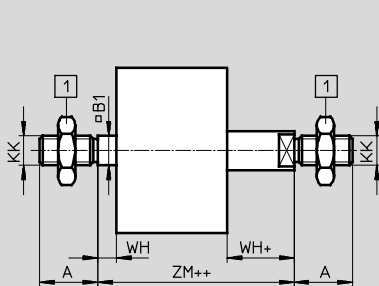

1 Hex nut DIN 439-B
only with $\varnothing 32 \dots 125$

+ = plus stroke length

++ = plus 2x stroke length

Q-S20 – Square, through, hollow piston rod

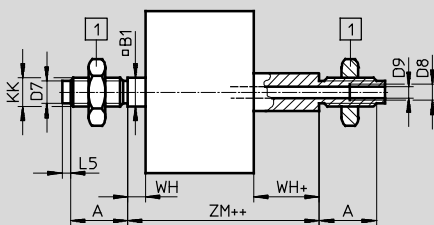

Note
In combination with variants
S2/S20, the piston rod is extended
at one end on the square piston rod.

1 Hex nut DIN 439-B
only with $\varnothing 32 \dots 125$

+ = plus stroke length

++ = plus 2x stroke length

Q-K2 – Square piston rod with extended male thread

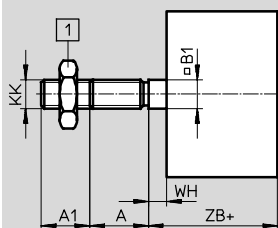

1 Hex nut DIN 439-B
only with $\varnothing 32 \dots 125$

+ = plus stroke length

Q-K5 – Square, special piston rod thread

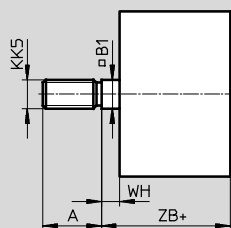

+ = plus stroke length

Compact cylinders ADN, to ISO 21287

Technical data

FESTO

Dimensions – Variants

Download CAD data → www.festo.com

Q-K8 – Square, extended piston rod

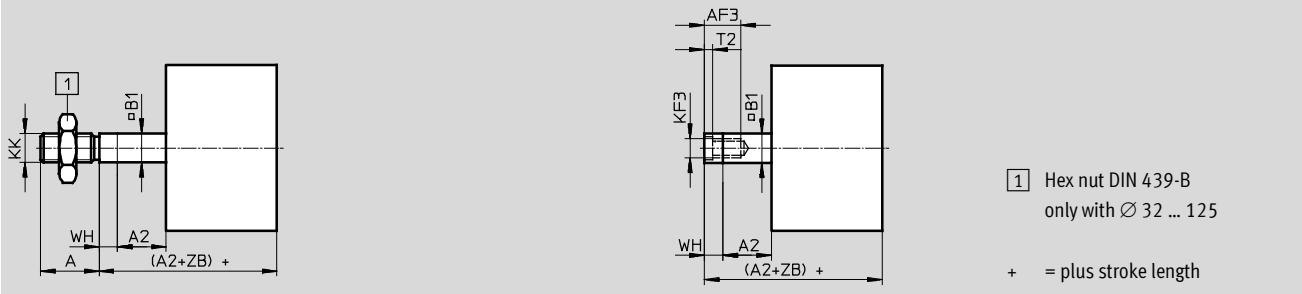

\varnothing [mm]	A	A1	A2	AF	AF3	B1	D7	D8	D9
	-0.5			min.	min.	□	\varnothing		\varnothing
12	10	1 ... 10	1 ... 300	8	8	5.5	-	-	-
16	12			10	10	7	4.5		3.2
20	16	1 ... 20		14	12	9	6		3.8
25			16	14	10	8	4.5		
32	19	1 ... 400	1 ... 500	16	14	10	8	-	6
40	22			20	16	12	10		8
50	28			20	20	16	16		10
63	22	1 ... 30	1 ... 500	20	20	16	-	G $\frac{1}{8}$	8
80	28			20	20	16	-	G $\frac{1}{8}$	8
100	40	1 ... 40		25	24	20		G $\frac{1}{4}$	11.7
125	40	1 ... 40		25	24	20		G $\frac{1}{4}$	11.7

\varnothing [mm]	L5	KF	KF3	KK	KK5	T2	WH	ZB	ZM
							+1.3	+1.2	
12	-	M3	M3	M5	M6	1.5	4.2	39.2	44.5 ^{+0.5}
16	3	M4	M4	M6	M8		4.7	39.7	45.7 ^{+0.5}
20	2	M6	M5	M8	M10x1.25 M10	2	5.5	42.5	49.5 ^{+0.5}
25							5.5	44.5	51.5 ^{+0.5}
32	3	M8	M6	M10x1.25	M10	2.6	6	50	57.5 ^{+0.5}
40							6.1	51.1	58.6 ^{+0.6}
50	3.5	M10	M8	M12x1.25	M16	3.3	8.2	53.2	62.8 ^{+0.6}
63							8.1	57.1	66.6 ^{+0.6}
80							8.9	62.9	73.2 ^{+0.6}
100	-	M12	M10	M16x1.5	M16	4.7	9	76	86.4 ^{+0.6}
125							M16	M12	M20x1.5

Compact cylinders ADN, to ISO 21287

Technical data

Dimensions – Variants Download CAD data → www.festo.com

S1 – Reinforced piston rod
 Ø 25

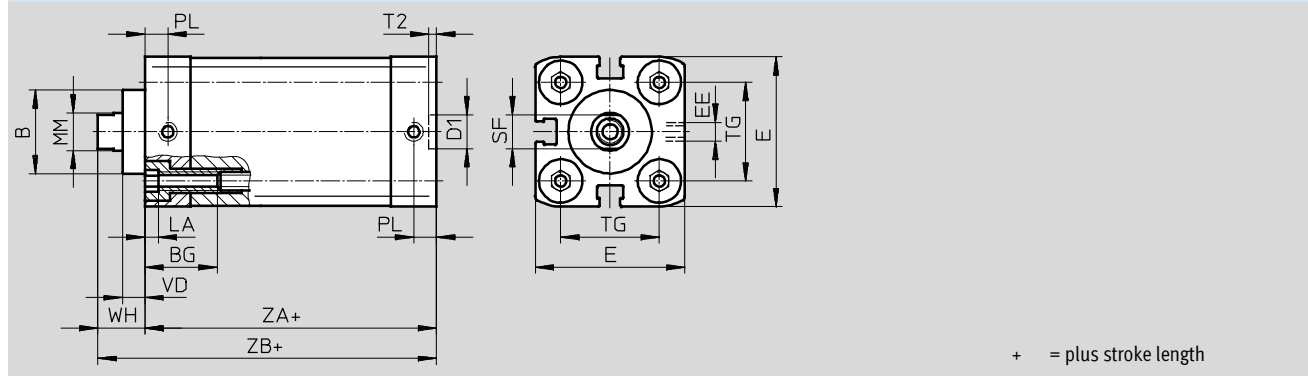

Ø 40 ... 100

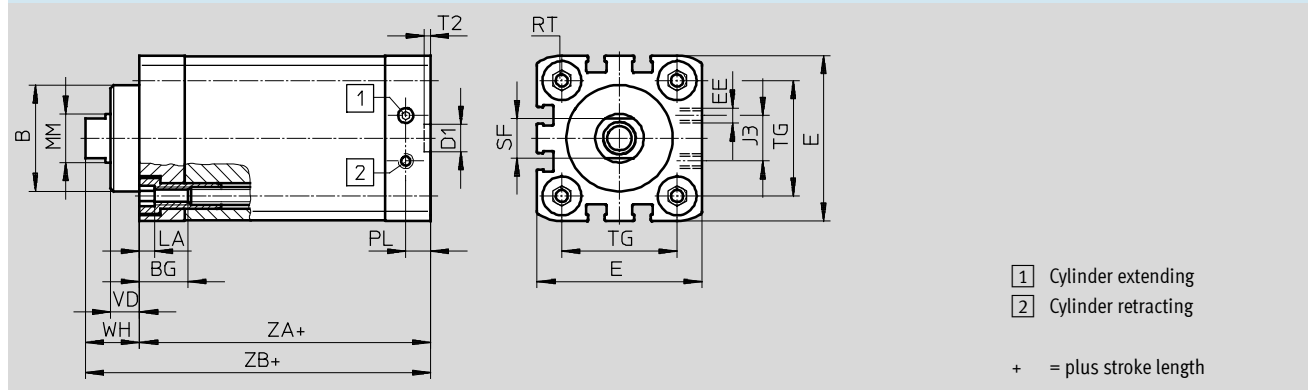

Ø	B	BG	D1	E	EE	J3	LA	MM	PL
[mm]	Ø f8	min.	Ø H9					Ø h9	
25	22	15	9	39.5 ^{+0.3}	M5	-	5	10	6
40	35	16		54.5 ^{+0.3}		15		16	8.2
63	42	17	12	75.5 ^{+0.3}	G1/8	23	20	10.5	
100	55			113.5 ^{+0.6}		40	25		

Ø	RT	SF	T2	TG	VD	WH	ZA	ZB
[mm]		h13	+0.1	±0.2		+1.3	±0.3	+1.2
25	M5	9	2.1	26	6	11.8	39	50.9
40	M6	13		38	9.5	18	45	62.9
63	M8	17	2.6	56.5	12	21	49	70.2
100	M10	21		89	15.5	26.5	67	93.5

Compact cylinders ADN, to ISO 21287

Technical data

FESTO

Dimensions – Variants

Download CAD data → www.festo.com

S1 – Reinforced piston rod

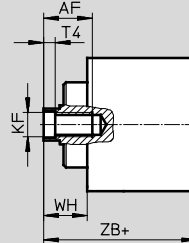
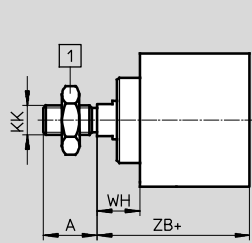

1 Hex nut DIN 439-B
only with \varnothing 40 ... 100

+ = plus stroke length

S1-K2 – Reinforced piston rod with extended male thread

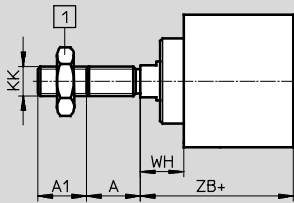

1 Hex nut DIN 439-B
only with \varnothing 40 ... 100

+ = plus stroke length

S1-K5 – Extended piston rod with special piston rod thread

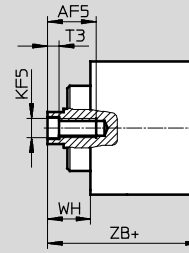
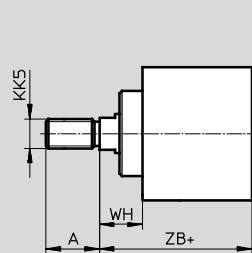

1 Hex nut DIN 439-B
only with \varnothing 40 ... 100

+ = plus stroke length

S1-K8 – Reinforced piston rod with extended piston rod

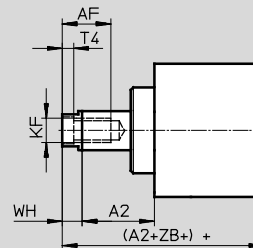
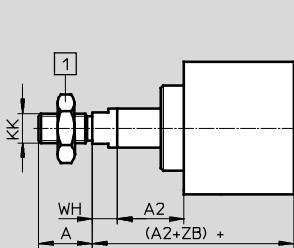

1 Hex nut DIN 439-B
only with \varnothing 40 ... 100

+ = plus stroke length

\varnothing	A	A1	A2	AF	AF5	KF	KF5	KK	KK5	T3	T4	WH	ZB
[mm]	-0.5			min.	min.							+1.3	+1.2
25	16	1 ... 20	1 ... 300	14	12	M6	M5	M8	M10x1.25 M10	2	2.6	11.8	50.9
40	22		1 ... 400	20	16	M10	M8	M12x1.25	M10x1.25 M12	3.3	4.7	18	62.9
63	28				20	M12	M10	M16x1.5	M12x1.25 M16	4.7	6.1	21	70.2
100	40	1 ... 30	1 ... 500	25	-	M16	-	M20x1.5	M16x1.5 M20	-	7	26.5	93.5

Compact cylinders ADN, to ISO 21287

FESTO

Technical data

Ordering data						
Type	Piston Ø [mm]	Stroke [mm]	I – Piston rod with female thread P – Flexible cushioning rings/pads at both ends		A – Male piston rod thread P – Flexible cushioning rings/pads at both ends	
			Part No.	Type	Part No.	Type
	12	5	536211	ADN-12-5-I-P-A	536204	ADN-12-5-A-P-A
		10	536212	ADN-12-10-I-P-A	536205	ADN-12-10-A-P-A
		15	536213	ADN-12-15-I-P-A	536206	ADN-12-15-A-P-A
		20	536214	ADN-12-20-I-P-A	536207	ADN-12-20-A-P-A
		25	536215	ADN-12-25-I-P-A	536208	ADN-12-25-A-P-A
		30	536216	ADN-12-30-I-P-A	536209	ADN-12-30-A-P-A
		40	536217	ADN-12-40-I-P-A	536210	ADN-12-40-A-P-A
		16	5	536226	ADN-16-5-I-P-A	536219
	10		536227	ADN-16-10-I-P-A	536220	ADN-16-10-A-P-A
	15		536228	ADN-16-15-I-P-A	536221	ADN-16-15-A-P-A
	20		536229	ADN-16-20-I-P-A	536222	ADN-16-20-A-P-A
	25		536230	ADN-16-25-I-P-A	536223	ADN-16-25-A-P-A
	30		536231	ADN-16-30-I-P-A	536224	ADN-16-30-A-P-A
	40		536232	ADN-16-40-I-P-A	536225	ADN-16-40-A-P-A
	50		536341	ADN-16-50-I-P-A	536331	ADN-16-50-A-P-A
	20	5	536242	ADN-20-5-I-P-A	536234	ADN-20-5-A-P-A
		10	536243	ADN-20-10-I-P-A	536235	ADN-20-10-A-P-A
		15	536244	ADN-20-15-I-P-A	536236	ADN-20-15-A-P-A
		20	536245	ADN-20-20-I-P-A	536237	ADN-20-20-A-P-A
		25	536246	ADN-20-25-I-P-A	536238	ADN-20-25-A-P-A
		30	536247	ADN-20-30-I-P-A	536239	ADN-20-30-A-P-A
		40	536248	ADN-20-40-I-P-A	536240	ADN-20-40-A-P-A
		50	536249	ADN-20-50-I-P-A	536241	ADN-20-50-A-P-A
	25	5	536259	ADN-25-5-I-P-A	536251	ADN-25-5-A-P-A
		10	536260	ADN-25-10-I-P-A	536252	ADN-25-10-A-P-A
		15	536261	ADN-25-15-I-P-A	536253	ADN-25-15-A-P-A
		20	536262	ADN-25-20-I-P-A	536254	ADN-25-20-A-P-A
		25	536263	ADN-25-25-I-P-A	536255	ADN-25-25-A-P-A
30		536264	ADN-25-30-I-P-A	536256	ADN-25-30-A-P-A	
40		536265	ADN-25-40-I-P-A	536257	ADN-25-40-A-P-A	
50		536266	ADN-25-50-I-P-A	536258	ADN-25-50-A-P-A	
32	5	536278	ADN-32-5-I-P-A	536268	ADN-32-5-A-P-A	
	10	536279	ADN-32-10-I-P-A	536269	ADN-32-10-A-P-A	
	15	536280	ADN-32-15-I-P-A	536270	ADN-32-15-A-P-A	
	20	536281	ADN-32-20-I-P-A	536271	ADN-32-20-A-P-A	
	25	536282	ADN-32-25-I-P-A	536272	ADN-32-25-A-P-A	
	30	536283	ADN-32-30-I-P-A	536273	ADN-32-30-A-P-A	
	40	536284	ADN-32-40-I-P-A	536274	ADN-32-40-A-P-A	
	50	536285	ADN-32-50-I-P-A	536275	ADN-32-50-A-P-A	
	60	536286	ADN-32-60-I-P-A	536276	ADN-32-60-A-P-A	
	80	536287	ADN-32-80-I-P-A	536277	ADN-32-80-A-P-A	

Compact cylinders ADN, to ISO 21287

Technical data

Ordering data						
Type	Piston Ø [mm]	Stroke [mm]	I – Piston rod with female thread P – Flexible cushioning rings/pads at both ends		A – Male piston rod thread P – Flexible cushioning rings/pads at both ends	
			Part No.	Type	Part No.	Type
	40	5	536299	ADN-40-5-I-P-A	536289	ADN-40-5-A-P-A
		10	536300	ADN-40-10-I-P-A	536290	ADN-40-10-A-P-A
		15	536301	ADN-40-15-I-P-A	536291	ADN-40-15-A-P-A
		20	536302	ADN-40-20-I-P-A	536292	ADN-40-20-A-P-A
		25	536303	ADN-40-25-I-P-A	536293	ADN-40-25-A-P-A
		30	536304	ADN-40-30-I-P-A	536294	ADN-40-30-A-P-A
		40	536305	ADN-40-40-I-P-A	536295	ADN-40-40-A-P-A
		50	536306	ADN-40-50-I-P-A	536296	ADN-40-50-A-P-A
	60	536307	ADN-40-60-I-P-A	536297	ADN-40-60-A-P-A	
	80	536308	ADN-40-80-I-P-A	536298	ADN-40-80-A-P-A	
	50	5	536320	ADN-50-5-I-P-A	536310	ADN-50-5-A-P-A
		10	536321	ADN-50-10-I-P-A	536311	ADN-50-10-A-P-A
		15	536322	ADN-50-15-I-P-A	536312	ADN-50-15-A-P-A
		20	536323	ADN-50-20-I-P-A	536313	ADN-50-20-A-P-A
		25	536324	ADN-50-25-I-P-A	536314	ADN-50-25-A-P-A
		30	536325	ADN-50-30-I-P-A	536315	ADN-50-30-A-P-A
		40	536326	ADN-50-40-I-P-A	536316	ADN-50-40-A-P-A
		50	536327	ADN-50-50-I-P-A	536317	ADN-50-50-A-P-A
	60	536328	ADN-50-60-I-P-A	536318	ADN-50-60-A-P-A	
	80	536329	ADN-50-80-I-P-A	536319	ADN-50-80-A-P-A	
	63	10	536342	ADN-63-10-I-P-A	536332	ADN-63-10-A-P-A
		15	536343	ADN-63-15-I-P-A	536333	ADN-63-15-A-P-A
		20	536344	ADN-63-20-I-P-A	536334	ADN-63-20-A-P-A
		25	536345	ADN-63-25-I-P-A	536335	ADN-63-25-A-P-A
		30	536346	ADN-63-30-I-P-A	536336	ADN-63-30-A-P-A
		40	536347	ADN-63-40-I-P-A	536337	ADN-63-40-A-P-A
		50	536348	ADN-63-50-I-P-A	536338	ADN-63-50-A-P-A
		60	536349	ADN-63-60-I-P-A	536339	ADN-63-60-A-P-A
80	536350	ADN-63-80-I-P-A	536340	ADN-63-80-A-P-A		
80	10	536363	ADN-80-10-I-P-A	536353	ADN-80-10-A-P-A	
	15	536364	ADN-80-15-I-P-A	536354	ADN-80-15-A-P-A	
	20	536365	ADN-80-20-I-P-A	536355	ADN-80-20-A-P-A	
	25	536366	ADN-80-25-I-P-A	536356	ADN-80-25-A-P-A	
	30	536367	ADN-80-30-I-P-A	536357	ADN-80-30-A-P-A	
	40	536368	ADN-80-40-I-P-A	536358	ADN-80-40-A-P-A	
	50	536369	ADN-80-50-I-P-A	536359	ADN-80-50-A-P-A	
	60	536370	ADN-80-60-I-P-A	536360	ADN-80-60-A-P-A	
80	536371	ADN-80-80-I-P-A	536361	ADN-80-80-A-P-A		
100	10	536384	ADN-100-10-I-P-A	536374	ADN-100-10-A-P-A	
	15	536385	ADN-100-15-I-P-A	536375	ADN-100-15-A-P-A	
	20	536386	ADN-100-20-I-P-A	536376	ADN-100-20-A-P-A	
	25	536387	ADN-100-25-I-P-A	536377	ADN-100-25-A-P-A	
	30	536388	ADN-100-30-I-P-A	536378	ADN-100-30-A-P-A	
	40	536389	ADN-100-40-I-P-A	536379	ADN-100-40-A-P-A	
	50	536390	ADN-100-50-I-P-A	536380	ADN-100-50-A-P-A	
	60	536391	ADN-100-60-I-P-A	536381	ADN-100-60-A-P-A	
80	536392	ADN-100-80-I-P-A	536382	ADN-100-80-A-P-A		

Compact cylinders ADN, to ISO 21287

Technical data

FESTO

Ordering data						
Type	Piston Ø [mm]	Stroke [mm]	I – Piston rod with female thread PPS – Pneumatic cushioning, self-adjusting at both ends		A – Male piston rod thread PPS – Pneumatic cushioning, self-adjusting at both ends	
			Part No.	Type	Part No.	Type
	32	10	572646	ADN-32-10-I-PPS-A	572655	ADN-32-10-A-PPS-A
		15	572647	ADN-32-15-I-PPS-A	572656	ADN-32-15-A-PPS-A
		20	572648	ADN-32-20-I-PPS-A	572657	ADN-32-20-A-PPS-A
		25	572649	ADN-32-25-I-PPS-A	572658	ADN-32-25-A-PPS-A
		30	572650	ADN-32-30-I-PPS-A	572659	ADN-32-30-A-PPS-A
		40	572651	ADN-32-40-I-PPS-A	572660	ADN-32-40-A-PPS-A
		50	572652	ADN-32-50-I-PPS-A	572661	ADN-32-50-A-PPS-A
		60	572653	ADN-32-60-I-PPS-A	572662	ADN-32-60-A-PPS-A
	80	572654	ADN-32-80-I-PPS-A	572663	ADN-32-80-A-PPS-A	
	40	10	572664	ADN-40-10-I-PPS-A	572673	ADN-40-10-A-PPS-A
		15	572665	ADN-40-15-I-PPS-A	572674	ADN-40-15-A-PPS-A
		20	572666	ADN-40-20-I-PPS-A	572675	ADN-40-20-A-PPS-A
		25	572667	ADN-40-25-I-PPS-A	572676	ADN-40-25-A-PPS-A
		30	572668	ADN-40-30-I-PPS-A	572677	ADN-40-30-A-PPS-A
		40	572669	ADN-40-40-I-PPS-A	572678	ADN-40-40-A-PPS-A
		50	572670	ADN-40-50-I-PPS-A	572679	ADN-40-50-A-PPS-A
		60	572671	ADN-40-60-I-PPS-A	572680	ADN-40-60-A-PPS-A
	80	572672	ADN-40-80-I-PPS-A	572681	ADN-40-80-A-PPS-A	
	50	10	572682	ADN-50-10-I-PPS-A	572691	ADN-50-10-A-PPS-A
		15	572683	ADN-50-15-I-PPS-A	572692	ADN-50-15-A-PPS-A
		20	572684	ADN-50-20-I-PPS-A	572693	ADN-50-20-A-PPS-A
		25	572685	ADN-50-25-I-PPS-A	572694	ADN-50-25-A-PPS-A
		30	572686	ADN-50-30-I-PPS-A	572695	ADN-50-30-A-PPS-A
		40	572687	ADN-50-40-I-PPS-A	572696	ADN-50-40-A-PPS-A
		50	572688	ADN-50-50-I-PPS-A	572697	ADN-50-50-A-PPS-A
		60	572689	ADN-50-60-I-PPS-A	572698	ADN-50-60-A-PPS-A
	80	572690	ADN-50-80-I-PPS-A	572699	ADN-50-80-A-PPS-A	

Compact cylinders ADN, to ISO 21287

Technical data

FESTO

Ordering data						
Type	Piston Ø [mm]	Stroke [mm]	I – Piston rod with female thread PPS – Pneumatic cushioning, self-adjusting at both ends		A – Male piston rod thread PPS – Pneumatic cushioning, self-adjusting at both ends	
			Part No.	Type	Part No.	Type
	63	10	572700	ADN-63-10-I-PPS-A	572709	ADN-63-10-A-PPS-A
		15	572701	ADN-63-15-I-PPS-A	572710	ADN-63-15-A-PPS-A
		20	572702	ADN-63-20-I-PPS-A	572711	ADN-63-20-A-PPS-A
		25	572703	ADN-63-25-I-PPS-A	572712	ADN-63-25-A-PPS-A
		30	572704	ADN-63-30-I-PPS-A	572713	ADN-63-30-A-PPS-A
		40	572705	ADN-63-40-I-PPS-A	572714	ADN-63-40-A-PPS-A
		50	572706	ADN-63-50-I-PPS-A	572715	ADN-63-50-A-PPS-A
		60	572707	ADN-63-60-I-PPS-A	572716	ADN-63-60-A-PPS-A
	80	572708	ADN-63-80-I-PPS-A	572717	ADN-63-80-A-PPS-A	
	80	10	572718	ADN-80-10-I-PPS-A	572727	ADN-80-10-A-PPS-A
		15	572719	ADN-80-15-I-PPS-A	572728	ADN-80-15-A-PPS-A
		20	572720	ADN-80-20-I-PPS-A	572729	ADN-80-20-A-PPS-A
		25	572721	ADN-80-25-I-PPS-A	572730	ADN-80-25-A-PPS-A
		30	572722	ADN-80-30-I-PPS-A	572731	ADN-80-30-A-PPS-A
		40	572723	ADN-80-40-I-PPS-A	572732	ADN-80-40-A-PPS-A
50		572724	ADN-80-50-I-PPS-A	572733	ADN-80-50-A-PPS-A	
60		572725	ADN-80-60-I-PPS-A	572734	ADN-80-60-A-PPS-A	
80	572726	ADN-80-80-I-PPS-A	572735	ADN-80-80-A-PPS-A		

Compact cylinders ADN, to ISO 21287

Ordering data – Modular products, basic version and variants

Ordering table									
Size	12	16	20	25	32	40	Condi- tions	Code	Enter code
M Module No.	536 203	536 218	536 233	536 250	536 267	536 288			
Function	Compact cylinder, double-acting, based on ISO 21287							ADN	ADN
Piston Ø [mm]	12	16	20	25	32	40		-...	
Stroke [mm]	1 ... 300				1 ... 400			-...	
Piston rod thread	Male thread							-A	
	Female thread						1	-I	
Cushioning	Flexible cushioning rings/pads at both ends							-P	
	-				Pneumatic cushioning, self-adjusting at both ends		8	-PPS	
↓ Position sensing	Via proximity sensor							-A	-A

- 1** **I** Not with piston rod type S20.
Not with extended male thread K2
- 8** **PPS** Not with improved running performance K10, temperature resistance S6,
low temperature TT, wiper seal R8

Transfer order code

ADN - - - - - **A**

Compact cylinders ADN, to ISO 21287

Ordering data – Modular products, basic version and variants

Ordering table									
Size	12	16	20	25	32	40	Condi- tions	Code	Enter code
0 Piston rod type	Through piston rod						2	-S2	
	[mm]	Through, hollow piston rod 1 ... 300			1 ... 400		2	-S20	
Extended male thread	Piston rod with extended male thread							-...K2	
[mm]	1 ... 10		1 ... 20						
Piston rod with special thread	Male thread	M6	M8	M10x1.25 M10	M10x1.25 M10	M10 M12	M10 M12	-“...”K5	
	Female thread	-	-	M5	M5	M6	M6		
Extended piston rod	Extended piston rod							-...K8	
[mm]	1 ... 300			1 ... 400			3		
Improved running performance	-	-	Smooth anodised aluminium coated piston rod				4	-K10	
Temperature resistance	Heat-resistant seals up to max. 120 °C							-S6	
Corrosion protection	High corrosion protection						5	-R3	
Captive rating plate	Laser etched rating plate							-TL	
Low temperature	[°C]	-	-	-40 ... +80			6 7	-TT	
Wiper seal	-	-	Dust protection				6	-R8	

2 **S2, S20** Not with improved running performance K10.
Not with corrosion protection R3.
Not with wiper seal R8

3 **K8** The sum of the stroke length and piston rod extension must not exceed the maximum permissible stroke length

4 **K10** Not with extended male thread K2.
Not with special piston rod thread K5.
Not with corrosion protection R3

5 **R3** Not with captive rating plate TL.
Not with wiper seal R8

6 **TT, R8** Not with improved running performance K10.
Not with temperature resistance S6
Not with wiper seal R8

7 **TT** Not with wiper seal R8

-  - Note

NSF-H1 lubricants are used in combination with R3 and in combination with R3 and K2, K5 or K8.

Transfer order code

- [] - [] - [] - [] - [] - [] - [] - [] - [] - []

Compact cylinders ADN, to ISO 21287

Ordering data – Modular products, basic version and variants

Ordering table								
Size	50	63	80	100	125	Condi- tions	Code	Enter code
M Module No.	536 309	536 330	536 351	536 372	536 393			
Function	Compact cylinder, double-acting, based on ISO 21287						ADN	ADN
Piston Ø [mm]	50	63	80	100	125		-...	
Stroke [mm]	1 ... 400		1 ... 500				-...	
Piston rod thread	Male thread						-A	
	Female thread					1	-I	
Cushioning	Flexible cushioning rings/pads at both ends						-P	
	Pneumatic cushioning, self-adjusting at both ends				-	8	-PPS	
↓ Position sensing	Via proximity sensor						-A	-A

- 1** **I** Not with piston rod type S20.
Not with extended male thread K2
- 8** **PPS** Not with improved running performance K10, temperature resistance S6,
low temperature TT, wiper seal R8

Transfer order code

ADN - - - - - **A**

Compact cylinders ADN, to ISO 21287

Ordering data – Modular products, basic version and variants

Ordering table										
Size	50	63	80	100	125	Condi- tions	Code	Enter code		
0 Piston rod type	Through piston rod					2	-S2			
	Through, hollow piston rod					2	-S20			
[mm]	1 ... 400		1 ... 500							
Extended male thread	Piston rod with extended male thread									
[mm]	1 ... 20		1 ... 30		1 ... 40		-...K2			
Piston rod with special thread	Male thread	M12	M12	M16	M16	M20	-"...K5			
		M16	M16	M20	M20	M20x1.5		M20x1.5		
Female thread	M8	M8	M10	M10	-					
Extended piston rod	Extended piston rod									
[mm]	1 ... 400		1 ... 500			3	-...K8			
Improved running performance	Smooth anodised aluminium coated piston rod									
[mm]	2 ... 400		5 ... 400	5 ... 500		4	-K10			
Temperature resistance	Heat-resistant seals up to max. 120 °C									
Corrosion protection	High corrosion protection									
						5	-R3			
Captive rating plate	Laser etched rating plate									
							-TL			
Low temperature	[°C]	-40 ... +80				-	6 7	-TT		
Wiper seal	Dust protection									
						6	-R8			

2 **S2, S20** Not with improved running performance K10.
Not with corrosion protection R3.
Not with wiper seal R8

3 **K8** The sum of the stroke length and piston rod extension must not exceed the maximum permissible stroke length

4 **K10** Not with extended male thread K2.
Not with special piston rod thread K5.
Not with corrosion protection R3

5 **R3** Not with captive rating plate TL.
Not with wiper seal R8

6 **TT, R8** Not with improved running performance K10.
Not with temperature resistance S6
Not with wiper seal R8

7 **TT** Not with wiper seal R8



Note

NSF-H1 lubricants are used in combination with R3 and in combination with R3 and K2, K5 or K8.

Transfer order code

- [] - [] - [] - [] - [] - [] - [] - [] - [] - []

Compact cylinders ADN, to ISO 21287

Ordering data – Modular products, S10 – Version with constant motion, S11 – Version with low friction

Ordering table													
Size	12	16	20	25	32	40	Condi- tions	Code	Enter code				
M Module No.	536 203	536 218	536 233	536 250	536 267	536 288							
Function	Compact cylinder, double-acting, based on ISO 21287								ADN	ADN			
Piston Ø [mm]	12	16	20	25	32	40		-...					
Stroke [mm]	1 ... 300				1 ... 400			-...					
Piston rod thread	Male thread							-A					
	Female thread						[1]	-I					
Cushioning	Flexible cushioning rings/pads at both ends							-P	-P				
Position sensing	Via proximity sensor							-A	-A				
O Male thread extended	Extended male piston rod thread												
[mm]	1 ... 10			1 ... 20				-...K2					
Special piston rod thread	Male thread		M6	M8	M10x1.25	M10x1.25	M10	M10	M10	M12	M12		-“...”K5
	Female thread		-	-	M5	M5	M6	M6					
Piston rod extended	Extended piston rod												
[mm]	1 ... 300				1 ... 400		[2]	-...K8					
Improved running performance	-	-	Smooth anodised aluminium coated piston rod				[3]	-K10					
Constant motion	Slow speed (constant motion at low piston speeds)						[4]	-S10					
	Restricted stroke												
[mm]	20 ... 300				20 ... 400								
Low friction	Low friction						[5]	-S11					
Corrosion protection	High corrosion protection						[6]	-R3					
Captive rating plate	Laser etched rating plate							-TL					

- [1] **I** Not with extended male thread K2
- [2] **K8** The sum of the stroke length and piston rod extension must not exceed the maximum permissible stroke length
- [3] **K10** Not with extended male thread K2
Not with special piston rod thread K5
Not with corrosion protection R3
- [4] **S10** Not with low friction S11
- [5] **S11** Not with constant motion S10
- [6] **R3** Not with captive rating plate TL

 Note
NSF-H1 lubricants are used in combination with R3 and in combination with R3 and K2, K5 or K8.

Transfer order code

ADN - - - - **P** - **A** - - - - - - - - - - -

Compact cylinders ADN, to ISO 21287

Ordering data – Modular products, S10 – Version with constant motion, S11 – Version with low friction

Ordering table										
Size	50	63	80	100	125	Condi- tions	Code		Enter code	
M Module No.	536 309	536 330	536 351	536 372	536 393					
Function	Compact cylinder, double-acting, based on ISO 21287							ADN		ADN
Piston Ø [mm]	50	63	80	100	125		-...			
Stroke [mm]	1 ... 400		1 ... 500				-...			
Piston rod thread	Male thread							-A		
	Female thread						1	-I		
Cushioning	Flexible cushioning rings/pads at both ends							-P		-P
Position sensing	Via proximity sensor							-A		-A
O Male thread extended	Extended male piston rod thread									
[mm]	1 ... 20		1 ... 30		1 ... 40			-...K2		
Special piston rod thread	Male thread	M12	M12	M16	M16	M20		-“...”K5		
		M16	M16	M20	M20	M20x1.5	M20x1.5			
	Female thread	M8	M8	M10	M10	-				
Piston rod extended	Extended piston rod									
[mm]	1 ... 400			1 ... 500			2	-...K8		
Improved running performance	Smooth anodised aluminium coated piston rod						3	-K10		
[mm]	2 ... 400		5 ... 400		5 ... 500					
Constant motion	Slow speed (constant motion at low piston speeds)						4	-S10		
	Restricted stroke									
[mm]	20 ... 400			20 ... 500						
Low friction	Low friction						5	-S11		
Corrosion protection	High corrosion protection						6	-R3		
Captive rating plate	Laser etched rating plate							-TL		

- 1 I** Not with extended male thread K2
- 2 K8** The sum of the stroke length and piston rod extension must not exceed the maximum permissible stroke length
- 3 K10** Not with extended male thread K2
Not with special piston rod thread K5
Not with corrosion protection R3
- 4 S10** Not with low friction S11
- 5 S11** Not with constant motion S10
- 6 R3** Not with captive rating plate TL

 Note
NSF-H1 lubricants are used in combination with R3 and in combination with R3 and K2, K5 or K8.

Transfer order code

ADN - - - - **P** - **A** - - - - - - - - - -

Compact cylinders ADN, to ISO 21287

Ordering data – Modular products, Q – Version with square piston rod, non-rotating

Ordering table									
Size	12	16	20	25	32	40	Condi- tions	Code	Enter code
M Module No.	536 203	536 218	536 233	536 250	536 267	536 288			
Function	Compact cylinder, double-acting, based on ISO 21287							ADN	ADN
Piston Ø [mm]	12	16	20	25	32	40		-...	
Stroke [mm]	1 ... 300				1 ... 400			-...	
Piston rod thread	Male thread							-A	
	Female thread						¹	-I	
Cushioning	Flexible cushioning rings/pads at both ends							-P	-P
Position sensing	Via proximity sensor							-A	-A
O Protection against torsion	Square piston rod							-Q	-Q
Type of piston rod	Through piston rod							-S2	
	-	Through, hollow piston rod Restricted stroke 1 ... 200				1 ... 300			-S20
Male thread extended [mm]	Extended male piston rod thread 1 ... 10			1 ... 20				-...K2	
Special piston rod thread	Male thread	M6	M8	M10x1.25 M10	M10x1.25 M10	M10	M10	-“...”K5	
Piston rod extended [mm]	Extended piston rod 1 ... 300				1 ... 400		²	-...K8	
Temperature resistance	Heat-resistant seals up to max. 120 °C							-S6	
Corrosion protection	High corrosion protection						³	-R3	
Captive rating plate	Laser etched rating plate							-TL	

¹ **I** Not with piston rod type S20
Not with extended male thread K2

² **K8** The sum of the stroke length and piston rod extension must not exceed the maximum permissible stroke length

³ **R3** Not with captive rating plate TL.



Note

NSF-H1 lubricants are used in combination with R3 and in combination with R3 and Q, K2, K5 or K8.

Transfer order code

ADN - - - - **P** - **A** - **Q** - - - - - - - -

Compact cylinders ADN, to ISO 21287

Ordering data – Modular products, Q – Version with square piston rod, non-rotating

Ordering table										
Size	50	63	80	100	125	Condi- tions	Code		Enter code	
M Module No.	536 309	536 330	536 351	536 372	536 393					
Function	Compact cylinder, double-acting, based on ISO 21287							ADN		ADN
Piston Ø [mm]	50	63	80	100	125		-...			
Stroke [mm]	1 ... 400		1 ... 500				-...			
Piston rod thread	Male thread						-A			
	Female thread					¹	-I			
Cushioning	Flexible cushioning rings/pads at both ends						-P		-P	
Position sensing	Via proximity sensor						-A		-A	
O Protection against torsion	Square piston rod						-Q		-Q	
Type of piston rod [mm]	Through piston rod						-S2			
	Through, hollow piston rod Restricted stroke		1 ... 300			1 ... 400		-S20		
Male thread extended [mm]	Extended male piston rod thread		1 ... 20		1 ... 30	1 ... 40		-...K2		
Special piston rod thread Male thread	M12	M12	M16	M16	M20		-“...”K5			
Piston rod extended [mm]	Extended piston rod		1 ... 400			1 ... 500	²	-...K8		
Temperature resistance	Heat-resistant seals up to max. 120 °C						-S6			
Corrosion protection	High corrosion protection					³	-R3			
Captive rating plate	Laser etched rating plate						-TL			

¹ I Not with piston rod type S20
Not with extended male thread K2

² K8 The sum of the stroke length and piston rod extension must not exceed the maximum permissible stroke length

³ R3 Not with captive rating plate TL.

 Note
NSF-H1 lubricants are used in combination with R3 and in combination with R3 and Q, K2, K5 or K8.

Transfer order code

Compact cylinders ADN, to ISO 21287

Ordering data – Modular products, S1 – Version with reinforced piston rod

Ordering table							
Size	25	40	63	100	Condi- tions	Code	Enter code
M Module No.	536 250	536 288	536 330	536 372			
Function	Compact cylinder, double-acting, based on ISO 21287					ADN	ADN
Piston Ø [mm]	25	40	63	100		-...	
Stroke [mm]	5 ... 300	10 ... 400		10 ... 500		-...	
Piston rod thread	Male thread					-A	
	Female thread				1	-I	
Cushioning	Flexible cushioning rings/pads at both ends					-P	-P
Position sensing	Via proximity sensor					-A	-A
O Male thread extended [mm]	Extended male piston rod thread 1 ... 20			1 ... 30		-...K2	
Special piston rod thread	Male thread	M10x1.25	M10x1.25	M12x1.25	M16x1.5	-“...”K5	
	Female thread	M10	M12	M16	M20		
Piston rod extended [mm]	Extended piston rod 1 ... 300		1 ... 400	1 ... 500	2	-...K8	
Temperature resistance	Heat-resistant seals up to max. 120 °C					-S6	
Reinforced piston rod	Reinforced piston rod or extended piston rod bearing					-S1	-S1
Captive rating plate	Laser etched rating plate					-TL	

1 I Not with extended male thread K2

2 K8 The sum of the stroke length and piston rod extension must not exceed the maximum permissible stroke length

Transfer order code

Compact cylinders ADN-KP, standard port pattern, with clamping unit

Type codes

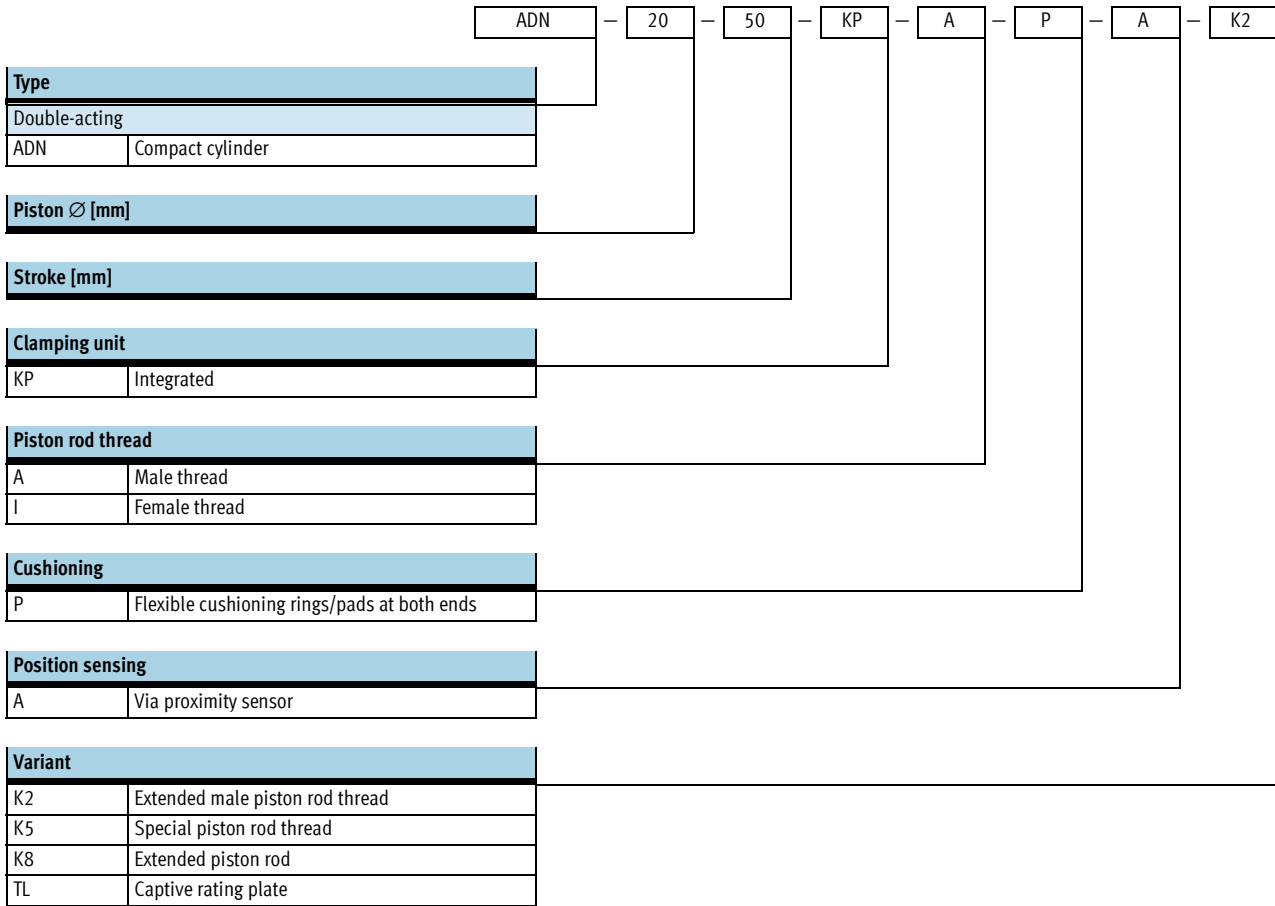

Compact cylinders ADN-KP, standard port pattern, with clamping unit

FESTO

Technical data

Function

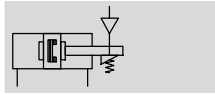

- \varnothing - Diameter
20 ... 100 mm

- | - Stroke length
10 ... 500 mm

Variants



K2



K5



K8



-  - Note

Additional measures are required for use in safety-related control systems; in Europe, for example, the standards listed under the EC Machinery Directive must be observed. Without

additional measures in accordance with statutory minimum requirements, the product is not suitable for use in safety-related sections of control systems.

General technical data		20	25	32	40	50	63	80	100
Piston \varnothing		20	25	32	40	50	63	80	100
Pneumatic connection	Cylinder	M5	M5	G $\frac{1}{8}$	G $\frac{1}{8}$	G $\frac{1}{8}$	G $\frac{1}{8}$	G $\frac{1}{8}$	G $\frac{1}{8}$
	KP	M5	M5	M5	G $\frac{1}{8}$	G $\frac{1}{8}$	G $\frac{1}{8}$	G $\frac{1}{8}$	G $\frac{1}{8}$
Female piston rod thread		M6		M8		M10		M12	
	K5	M5		M6		M8		M10	
Male piston rod thread		M8		M10x1.25		M12x1.25		M16x1.5	
	K5	M10, M10x1.25		M10, M12		M12, M16		M16, M20, M20x1.5	
Axial play under load	[mm]	0.5				0.8			
Constructional design		Piston							
		Piston rod							
		Cylinder barrel							
Cushioning		Flexible cushioning rings/pads at both ends							
Position sensing		Via proximity sensor							
Type of mounting		Via through-holes							
		Via female threads							
		Via accessories							
Mounting position		Any							
Clamping type with effective direction of action		From both sides							

Operating and environmental conditions	
Operating medium	Compressed air in accordance with ISO 8573-1:2010 [7:4:4]
Note on operating/pilot medium	Operation with lubricated medium possible (in which case lubricated operation will always be required)
Operating pressure [bar]	1.5 ... 10
Min. release pressure [bar]	3
Ambient temperature ¹⁾ [°C]	-10 ... +80
Corrosion resistance class CRC ²⁾	2

1) Note operating range of proximity sensors

2) Corrosion resistance class 2 to Festo standard 940 070

Components subject to moderate corrosion stress. Externally visible parts with primarily decorative surface requirements which are in direct contact with a normal industrial environment or media such as coolants or lubricating agents

Compact cylinders ADN-KP, standard port pattern, with clamping unit

Technical data

Impact energy [J]								
Piston Ø	20	25	32	40	50	63	80	100
Max. impact energy at the end positions	0.2	0.3	0.4	0.7	1	1.3	1.8	2.5

Permissible impact velocity:
$$v_{perm.} = \sqrt{\frac{2 \times E_{perm.}}{m_{dead} + m_{load}}}$$

$v_{perm.}$ Permissible impact velocity
 $E_{perm.}$ Max. impact energy
 m_{dead} Moving load (drive)
 m_{load} Moving work load

 Note
 These specifications represent the maximum values which can be reached. Note the maximum permitted impact energy.

Maximum permissible load:
$$m_{load} = \frac{2 \times E_{perm.}}{v^2} - m_{dead}$$

Forces [N]								
Piston Ø	20	25	32	40	50	63	80	100
Theoretical force at 6 bar, advancing	188	295	483	754	1178	1870	3016	4712
Theoretical force at 6 bar, retracting	141	247	415	633	990	1682	2721	4418
Static holding force	350	350	600	1000	1400	2000	5000	5000

 Note
 The specified holding force refers to a static load. If this value is exceeded, slippage may occur. Dynamic forces occurring during operation must not exceed the static holding force. The clamping unit is not backlash-free in the clamped condition if varying loads are applied to the piston rod.

Activation:
 The clamping unit may only be released if the forces at the piston have reached equilibrium. Otherwise, there is a risk of accidents due to sudden movement of the piston rod. Blocking off the air supply at both ends (e.g. with a 5/3-way valve) does not provide any safety.

Max. lateral force Fq as a function of the projection x

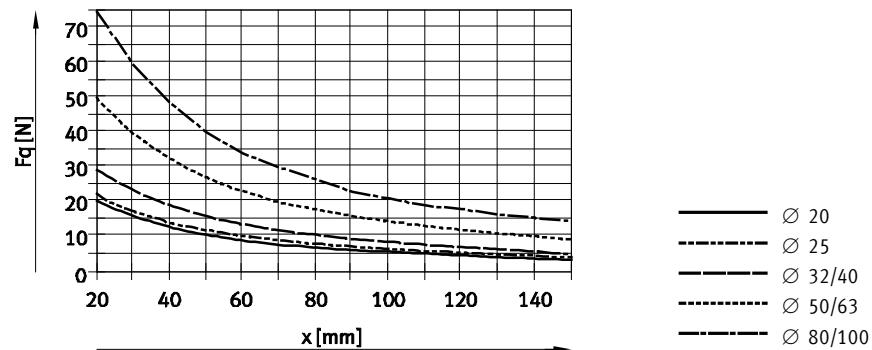

Weight [g]								
Piston Ø	20	25	32	40	50	63	80	100
Product weight with 0 mm stroke	282	344	503	789	1268	1894	3973	5497
Additional weight per 10 mm stroke	22	26	29	45	60	68	93	112
Moving load with 0 mm stroke	53	63	100	173	296	368	755	932
Additional load per 10 mm stroke	6	6	9	16	25	25	39	39

Compact cylinders ADN-KP, standard port pattern, with clamping unit

Technical data

Materials

Sectional view

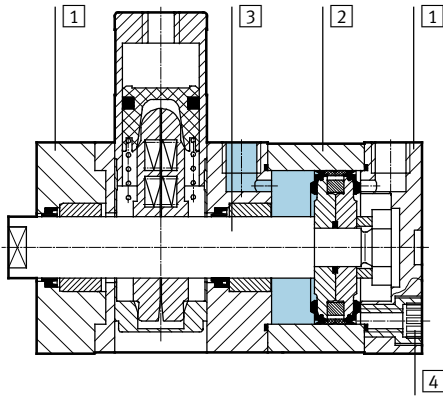

Compact cylinder		
1	Cover	Anodised aluminium
2	Cylinder barrel	Anodised aluminium
3	Piston rod	High-alloy steel
4	Flange screws	∅ 20 ... 63 Galvanised steel
		∅ 80 ... 100 Standard screws, galvanised steel
-	Seals	Polyurethane, nitrile rubber
	Note on materials	RoHS compliant

Compact cylinders ADN-KP, standard port pattern, with clamping unit

Technical data

Dimensions – Basic version Download CAD data → www.festo.com

∅ 20 ... 63

This variant only supports direct mounting.

+ = plus stroke length

∅ 80, 100

This variant only supports direct mounting.

+ = plus stroke length

∅	BG	D1	D2	D5	E	E1	EE	G	G1	H1	J2
[mm]	min.	∅ H9	∅	∅ F9							
20	19.5	9	20	9	35.5 ^{+0.3}	M5	M5	49.8	12	63	2.6
25					39.5 ^{+0.3}			50.6		65	
32					47 ^{+0.3}			56.4		68	
40	26	12	24	12	54.5 ^{+0.3}	G1/8	G1/8	60.4	15	89	8
50			65.5 ^{+0.3}		67.4			108			
63			75.5 ^{+0.3}		76.8			120			
80	17	12	48	15	95.5 ^{+0.6}	G1/8	G1/8	99	16.5	167	11.5
100	21.5				113.5 ^{+0.6}			99.6	21.5	176	

∅	LA	MM	PL	PL1	RT	SF	T2	TG	ZA	ZB
[mm]	+0.2	∅ h8	+0.2	+0.2		h13	+0.2	±0.2	±0.3	+1.2
20	5	10	42.8	6	M5	9	2.1	22	74.8	80.8
25			44.6					26	77.6	83.1
32			49.6					32.5	85.4	91.4
40		53.6	38	90.4	96.5					
50		60.6	20	8.2	M8	17	2.6	46.5	97.4	105.6
63		70						56.5	110.8	118.9
80	90.7	72						136.5	145.4	
100	2.6	25	88.6	10.5	M10	21	89	145.1	154.1	

Compact cylinders ADN-KP, standard port pattern, with clamping unit

Technical data

Dimensions – Variants Download CAD data → www.festo.com

Basic version

1 Hex nut to DIN 439-B only with \varnothing 32 ... 100

+ = plus stroke length

K2 – Extended male piston rod thread

1 Hex nut to DIN 439-B only with \varnothing 32 ... 100

+ = plus stroke length

K5 – Special piston rod thread

+ = plus stroke length

K8 – Extended piston rod

1 Hex nut to DIN 439-B only with \varnothing 32 ... 100

+ = plus stroke length

Compact cylinders ADN-KP, standard port pattern, with clamping unit

Technical data

∅ [mm]	A	A1	A2	AF	AF5	KF	KF5	
	-0.5			min.	min.			
20	16	1 ... 20	1 ... 300	14	12	M6	M5	
25				16	14	M8	M6	
32	19		1 ... 400	20	16	14	M10	M8
40					20	16	M12	M10
50	22							
63	28	1 ... 30	1 ... 500	20	20	M12	M10	
80								
100								

∅ [mm]	KK	KK5	T3	T4	WH	ZB
					+1.3	+1.2
20	M8	M10x1.25	2	2.6	5.5	80.8
25		M10				83.1
32	M10x1.25	M10	2.6	3.3	6	91.4
40		M12				96.5
50	M12x1.25	M12	3.3	4.7	8.2	105.6
63		M16				118.9
80	M16x1.5	M16	4.7	6.1	8.9	145.4
100		M20x1.5 M20				9

Compact cylinders ADN-KP, standard port pattern, with clamping unit

FESTO

Ordering data – Modular products

Ordering table								
Size	20	25	32	40	Condi- tions	Code	Enter code	
M	Module No.	548 206	548 207	548 208	548 209			
	Function	Compact cylinder, double-acting, standard port pattern, with clamping unit					ADN	ADN
	Piston Ø [mm]	20	25	32	40		-...	
	Stroke [mm]	10 ... 300		10 ... 400			-...	
	Clamping unit	Integrated					-KP	-KP
	Piston rod thread	Male thread					-A	
		Female thread				1	-I	
	Cushioning	Flexible cushioning rings/pads at both ends					-P	-P
	Position sensing	Via proximity sensor					-A	-A
O	Male thread extended [mm]	Extended male piston rod thread 1 ... 20					-...K2	
	Special piston rod thread	Male thread	M10x1.25 M10	M10x1.25 M10	M10 M12	M10 M12	-“...”K5	
		Female thread	M5	M5	M6	M6		
	Piston rod extended [mm]	Extended piston rod 1 ... 300		1 ... 400		2	-...K8	
	Captive rating plate	Laser etched rating plate					-TL	

- 1** I Not with extended male thread K2
- 2** K8 The sum of the stroke length and piston rod extension must not exceed the maximum permissible stroke length

Transfer order code

Compact cylinders ADN-KP, standard port pattern, with clamping unit



Ordering data – Modular products

Ordering table							
Size	50	63	80	100	Condi- tions	Code	Enter code
M Module No.	548 210	548 211	548 212	548 213			
Function	Compact cylinder, double-acting, standard port pattern, with clamping unit					ADN	ADN
Piston Ø [mm]	50	63	80	100		-...	
Stroke [mm]	10 ... 400		10 ... 500			-...	
Clamping unit	Integrated					-KP	-KP
Piston rod thread	Male thread					-A	
	Female thread					-I	
Cushioning	Flexible cushioning rings/pads at both ends					-P	-P
Position sensing	Via proximity sensor					-A	-A
O Male thread extended [mm]	Extended male piston rod thread 1 ... 20		1 ... 30			-...K2	
Special piston rod thread	Male thread		M12	M12	M16	M16	-“...”K5
			M16	M16	M20	M20	
	Female thread		M8	M8	M10	M10	
Piston rod extended [mm]	Extended piston rod 1 ... 400		1 ... 500			-...K8	
Captive rating plate	Laser etched rating plate					-TL	

- 1 I** Not with extended male thread K2
- 2 K8** The sum of the stroke length and piston rod extension must not exceed the maximum permissible stroke length

Transfer order code

- - - -

Compact cylinders ADN-EL, standard port pattern, with end position lock

Type codes

ADN – 20 – 100 – ELV – A – P – A – K2

Type	
Double-acting	
ADN	Compact cylinder
Piston Ø [mm]	
Stroke [mm]	
End position lock	
ELB	At both ends
ELV	At front
ELH	At rear
Piston rod thread	
A	Male thread
I	Female thread
Cushioning	
P	Flexible cushioning rings/pads at both ends
Position sensing	
A	Via proximity sensor
Variant	
K2	Extended male piston rod thread
K5	Special piston rod thread
K8	Extended piston rod
TL	Captive rating plate

Compact cylinders ADN-EL, standard port pattern, with end position lock

Technical data

Function

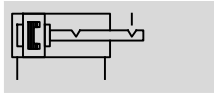

- Diameter
20 ... 100 mm
- Stroke length
10 ... 500 mm

Variants



K2

K5

K8



Note

Additional measures are required for use in safety-related control systems; in Europe, for example, the standards listed under the EC Machinery Directive must be observed. Without additional measures in accordance with statutory minimum requirements, the product is not suitable for use in safety-related sections of control systems.

General technical data								
Piston Ø	20	25	32	40	50	63	80	100
Pneumatic connection	M5	M5	G1/8	G1/8	G1/8	G1/8	G1/8	G1/8
Female piston rod thread	M6	M6	M8	M8	M10	M10	M12	M12
Male piston rod thread	M5	M5	M6	M6	M8	M8	M10	M10
Max. axial backlash with end position locked [mm]	M8	M8	M10x1.25	M10x1.25	M12x1.25	M12x1.25	M16x1.5	M16x1.5
Constructional design	M10	M10	M10	M10	M12	M12	M16	M16
End position lock	1.3							
Cushioning	Flexible cushioning rings/pads at both ends							
Position sensing	Via proximity sensor							
Type of mounting	Via female threads Via accessories							
Mounting position	Any							

Note

- No screws with a head or similar may be used in place of the end position lock, as there is a risk that the function will be impaired if they are screwed in too deeply.
- The exhaust hole must not be closed.
- Locking can be performed from any stroke position, once the drive is brought mechanically into its end position.
- The end position lock has been designed to guard against the load dropping in case of pressure failure.
- Operation of the cylinder in conjunction with a 3-way valve (especially with the function “mid-position closed” and those with “metallic sealing”) should be avoided. The residual pressure that is enclosed on the locking side of the cylinder can release the locking function.
- The cylinder must not be operated with external stops (e.g. shock absorber, buffer, oil brake, etc.):
- It may not be possible to reliably reach the internal end position.
- The locking mechanism can wear out prematurely. (In the event of pressure drop in the opposite chamber to less than the locking pressure, the locking piston will prematurely fall to its end position.)

Compact cylinders ADN-EL, standard port pattern, with end position lock

Technical data

FESTO

Operating and environmental conditions								
Piston Ø	20	25	32	40	50	63	80	100
Operating medium	Compressed air in accordance with ISO 8573-1:2010 [7:4:4]							
Note on operating/pilot medium	Operation with lubricated medium possible (in which case lubricated operation will always be required)							
Operating pressure [bar]	2.5 ... 10				1.5 ... 10			
Ambient temperature ¹⁾ [°C]	-20 ... +80							
Corrosion resistance class CRC ²⁾	2							

1) Note operating range of proximity sensors

2) Corrosion resistance class 2 to Festo standard 940 070

Components subject to moderate corrosion stress. Externally visible parts with primarily decorative surface requirements which are in direct contact with a normal industrial environment or media such as coolants or lubricating agents

Forces [N]								
Piston Ø	20	25	32	40	50	63	80	100
Theoretical force at 6 bar, advancing	188	295	483	754	1178	1870	3016	4712
Theoretical force at 6 bar, retracting	141	247	415	686	1057	1750	2827	4524
Static holding force	250	500			2000		5000	

Sizing example



Note

When sizing pneumatic cylinders it is recommended as a basic principle that only 50% of the indicated theoretical forces (see above) be used.

Given:

Installation position = Vertical

Workpiece load = 44 kg

$$F = m \times g = 44 \text{ kg} \times 9.81 \text{ m/s}^2 = 431.6 \text{ N}$$

To be calculated:

Suitable piston Ø

Analysis with 32 mm piston Ø:

Theoretical force at 6 bar, advancing = 483 N

50% of the theoretical force = 241.5 N

Static holding force with 32 mm piston Ø = 500 N

The static force on the end position lock is within the permissible range (max. 500 N) with a workpiece load of 44 kg (431.6 N), however the cylinder would be at 89% capacity.

Result:

A cylinder with a piston Ø of 40 mm is therefore recommended for this application.

Impact energy [J]								
Piston Ø	20	25	32	40	50	63	80	100
Max. impact energy at the end positions	0.2	0.3	0.4	0.7	1	1.3	1.8	2.5

Permissible impact velocity:

$$v_{\text{perm.}} = \sqrt{\frac{2 \times E_{\text{perm.}}}{m_{\text{dead}} + m_{\text{load}}}}$$

$v_{\text{perm.}}$ Permissible impact velocity

$E_{\text{perm.}}$ Max. impact energy

m_{dead} Moving load (drive)

m_{load} Moving work load



Note

These specifications represent the maximum values which can be reached. Note the maximum permitted impact energy.

Maximum permissible load:

$$m_{\text{load}} = \frac{2 \times E_{\text{perm.}}}{v^2} - m_{\text{dead}}$$

Max. lateral force F_q as a function of the projection x

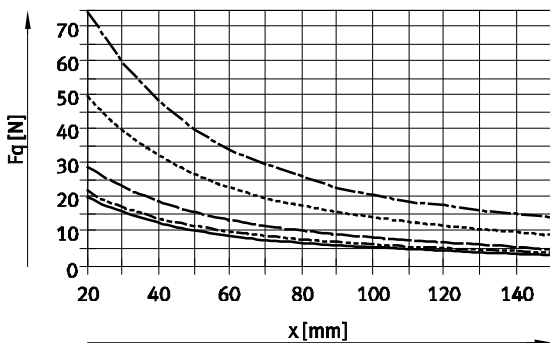

- Ø 20
- - - - - Ø 25
- · - · - · Ø 32/40
- · · · · Ø 50/63
- - - - - Ø 80/100

Compact cylinders ADN-EL, standard port pattern, with end position lock

FESTO

Technical data

Weight [g]								
Piston \varnothing	20	25	32	40	50	63	80	100
End position lock at both ends								
Product weight with 0 mm stroke	234	339	518	665	1334	1734	3300	4735
Additional weight per 10 mm stroke	22	26	29	38	51	59	79	98
Moving load with 0 mm stroke	43	53	85	101	199	248	475	637
Additional load per 10 mm stroke	6	6	9	9	16	16	25	25
End position lock at front								
Product weight with 0 mm stroke	177	248	387	498	922	1228	2296	3448
Additional weight per 10 mm stroke	22	26	29	38	51	59	79	98
Moving load with 0 mm stroke	35	46	75	98	175	225	464	626
Additional load per 10 mm stroke	6	6	9	9	16	16	25	25
End position lock at rear								
Product weight with 0 mm stroke	181	252	380	505	920	1217	2233	3409
Additional weight per 10 mm stroke	22	26	29	38	51	59	79	98
Moving load with 0 mm stroke	37	45	73	89	168	217	413	582
Additional load per 10 mm stroke	6	6	9	9	16	16	25	25

Materials

Sectional view

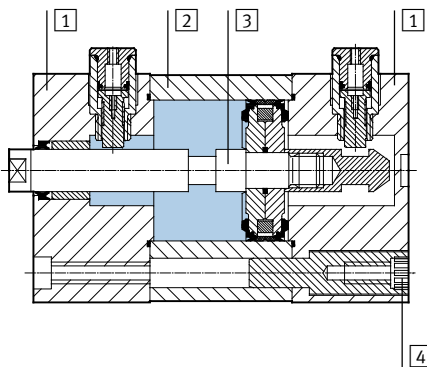

Compact cylinder		
1	Cover	Anodised aluminium
2	Cylinder barrel	Anodised aluminium
3	Piston rod	High-alloy steel
4	Flange screws	\varnothing 20 ... 63
		\varnothing 80 ... 100
-	Seals	Polyurethane, nitrile rubber
	Note on materials	RoHS compliant

Compact cylinders ADN-EL, standard port pattern, with end position lock

Technical data

Dimensions – Basic version

Download CAD data → www.festo.com

ELB – End position lock at both ends

Ø 20 ... 63

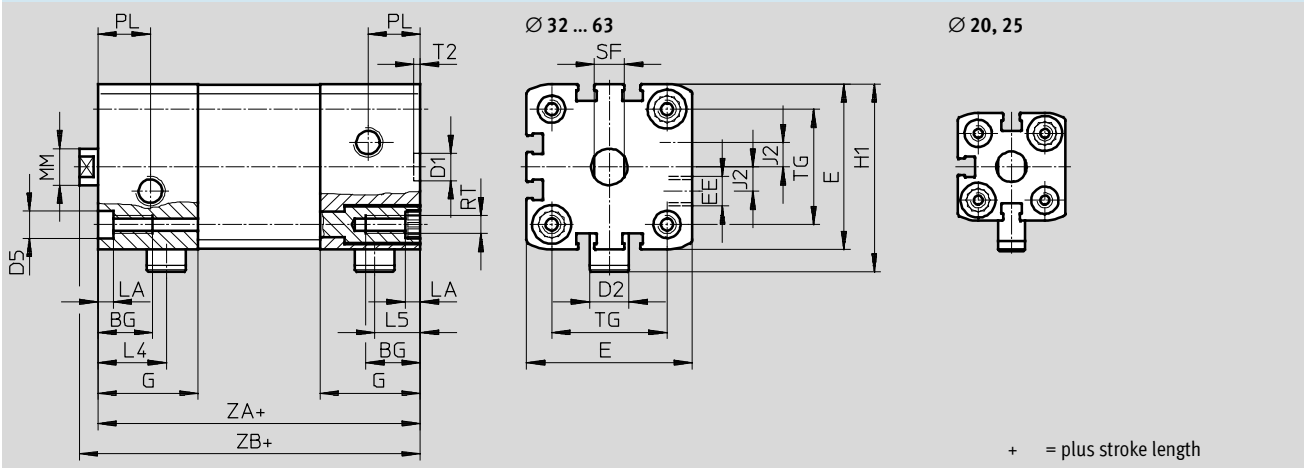

Ø 80 ... 100

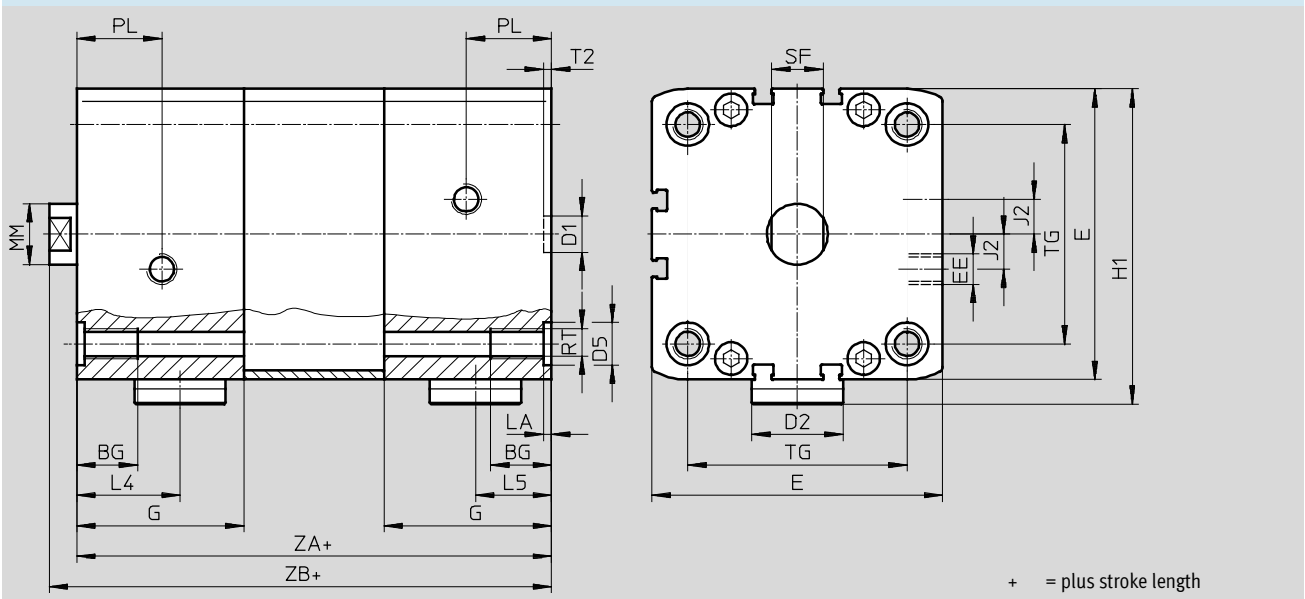

ELV – End position lock at front

ELH – End position lock at rear

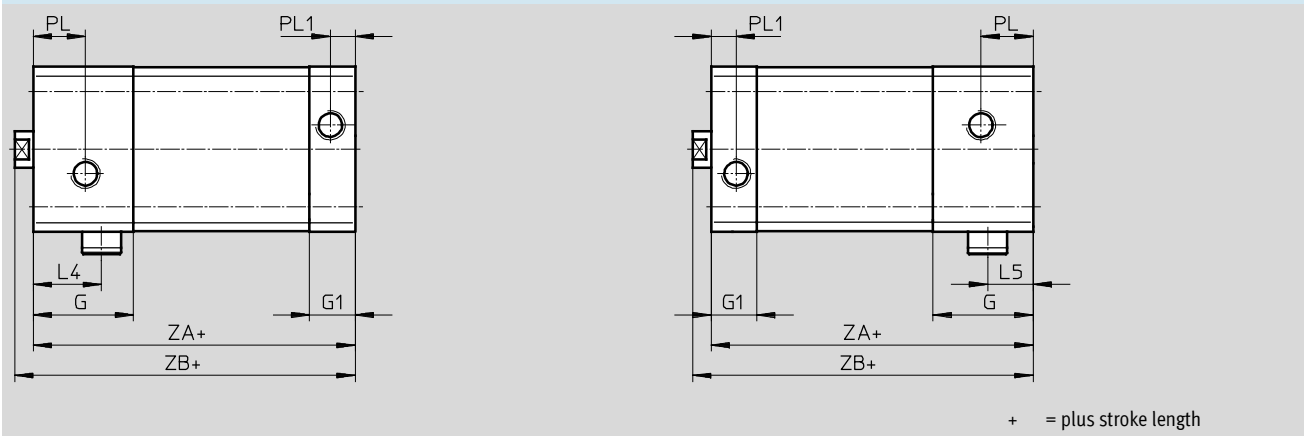

Compact cylinders ADN-EL, standard port pattern, with end position lock

Technical data

∅ [mm]	BG min.	D1 ∅ H9	D2 ∅	D5 ∅ F9	E	EE	G	G1	H1	J2	L4	L5
20	18	9	9	9	35.5 ^{+0.3}	M5	25	12	45.5	2.6	18.5	12.5
25			13		39.5 ^{+0.3}		29.5		53.3		20.8	14
32					47 ^{+0.3}	33	15	58	8	22.5	15	
40			54.5 ^{+0.3}		43			77		27.5	20.5	
50	20	12	20	12	65.5 ^{+0.3}	G ¹ / ₈	55	16.5	82	11.5	34	21.7
63			30	15	75.5 ^{+0.3}				57		21.5	113.5
80					95.5 ^{+0.6}							
100			113.5 ^{+0.6}									

∅ [mm]	LA +0.2	MM ∅ h8	PL	PL1	RT	SF h13	T2 +0.1	TG ±0.2	ZA ±0.3		ZB +1.2	
									ELB	ELV. ELH	ELB	ELV. ELH
20	5	10	6	6	M5	9	2.1	22	63	50	68.8	55.5
25								26	74	56.5	79.5	62
32								32.5	80	62	86	68
40		12	16	8.2	M6	10	2.6	38	81	63	87.1	69
50								46.5	101	73	109.2	81.2
63								56.5	105	77	113.1	85.1
80	2.6	20	28	10.5	M8	13	72	131	92.5	139.9	101.4	
100							89	138	102.5	147	111.5	

Compact cylinders ADN-EL, standard port pattern, with end position lock

Technical data

Dimensions – Variants Download CAD data → www.festo.com

Basic version

1 Hex nut to DIN 439-B only with \varnothing 32 ... 100

+ = plus stroke length

K2 – Extended male piston rod thread

1 Hex nut to DIN 439-B only with \varnothing 32 ... 100

+ = plus stroke length

K5 – Special piston rod thread

+ = plus stroke length

K8 – Extended piston rod

1 Hex nut to DIN 439-B only with \varnothing 32 ... 100

+ = plus stroke length

Compact cylinders ADN-EL, standard port pattern, with end position lock

FESTO

Technical data

∅ [mm]	A	A1	A2	AF	AF5	KF	KF5	
	-0.5			min.	min.			
20	16	1 ... 20	1 ... 300	14	12	M6	M5	
25				16	14	M8	M6	
32	19		1 ... 400	20	16	14	M10	M8
40					16	14	M12	M10
50	22							
63	28	1 ... 30	1 ... 500	20	20	M12	M10	
80								
100								

∅ [mm]	KK	KK5	T3	T4	WH +1.3	ZB +1.2	
						ELB	ELV. ELH
20	M8	M10x1.25	2	2.6	5.5	68.8	55.5
25		M10				79.5	62
32	M10x1.25	M10	2.6	3.3	6	86	68
40		M12				6.1	87.1
50	M12x1.25	M12	3.3	4.7	8.2	109.2	81.2
63		M16				8.1	113.1
80	M16x1.5	M16	4.7	6.1	8.9	139.9	101.4
100		M20x1.5 M20				9	147

Compact cylinders ADN-EL, standard port pattern, with end position lock

FESTO

Ordering data – Modular products

Ordering table								
Size	20	25	32	40	Condi- tions	Code	Enter code	
M	Module No.	548 214	548 215	548 216	548 217			
	Function	Compact cylinder, double-acting, standard port pattern, with end position lock					ADN	ADN
	Piston Ø [mm]	20	25	32	40		-...	
	Stroke [mm]	10 ... 300		10 ... 400			-...	
	End position lock	At both ends					-ELB	
		At front					-ELV	
		At rear					-ELH	
	Piston rod thread	Male thread					-A	
		Female thread				1	-I	
	Cushioning	Flexible cushioning rings/pads at both ends					-P	-P
	Position sensing	Via proximity sensor					-A	-A
O	Male thread extended [mm]	Extended male piston rod thread 1 ... 20					-...K2	
	Special piston rod thread	Male thread	M10x1.25	M10x1.25	M10	M10	-“...”K5	
			M10	M10	M12	M12		
		Female thread	M5	M5	M6	M6		
	Piston rod extended [mm]	1 ... 300		1 ... 400		2	-...K8	
	Captive rating plate	Laser etched rating plate					-TL	

- 1 I Not with extended male thread K2
 2 K8 The sum of the stroke length and piston rod extension must not exceed the maximum permissible stroke length

Transfer order code

Compact cylinders ADN-EL, standard port pattern, with end position lock



Ordering data – Modular products

Ordering table							
Size	50	63	80	100	Condi- tions	Code	Enter code
M Module No.	548 218	548 219	548 220	548 221			
Function	Compact cylinder, double-acting, standard port pattern, with end position lock					ADN	ADN
Piston Ø [mm]	50	63	80	100		-...	
Stroke [mm]	10 ... 400		10 ... 500			-...	
End position lock	At both ends					-ELB	
	At front					-ELV	
	At rear					-ELH	
Piston rod thread	Male thread					-A	
	Female thread				1	-I	
Cushioning	Flexible cushioning rings/pads at both ends					-P	-P
Position sensing	Via proximity sensor					-A	-A
O Male thread extended [mm]	Extended male piston rod thread 1 ... 20		1 ... 30			-...K2	
Special piston rod thread	Male thread	M12	M12	M16	M16	-“...”K5	
		M16	M16	M20	M20		
	Female thread	M8	M8	M10	M10		
Piston rod extended [mm]	Extended piston rod 1 ... 400		1 ... 500		2	-...K8	
Captive rating plate	Laser etched rating plate					-TL	

- 1** I Not with extended male thread K2
- 2** K8 The sum of the stroke length and piston rod extension must not exceed the maximum permissible stroke length

Transfer order code

- - - -

Compact cylinders AEN, to ISO 21287

Type codes

FESTO

		AEN	-	50	-	25	-	A	-	P	-	A	-	Q
Type														
Single-acting														
AEN	Compact cylinder													
Piston Ø [mm]														
Stroke [mm]														
Piston rod thread														
A	Male thread													
I	Female thread													
Cushioning														
P	Flexible cushioning rings/pads at both ends													
Position sensing														
A	Via proximity sensor													
Variant														
Z	Single-acting, pulling													
Q	Square piston rod													
K2	Extended male piston rod thread													
K5	Special piston rod thread													
K8	Extended piston rod													
K10	Smooth anodised piston rod													
S6	Heat-resistant seals up to max. 120 °C													
TL	Captive rating plate													

Compact cylinders AEN, to ISO 21287

Technical data

Function

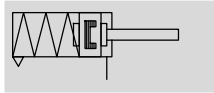
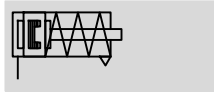

pulling

⊘ Diameter
12 ... 100 mm

— Stroke length
1 ... 25 mm

www.festo.com

Variants



S6



K2



K5



K8



K10



Q

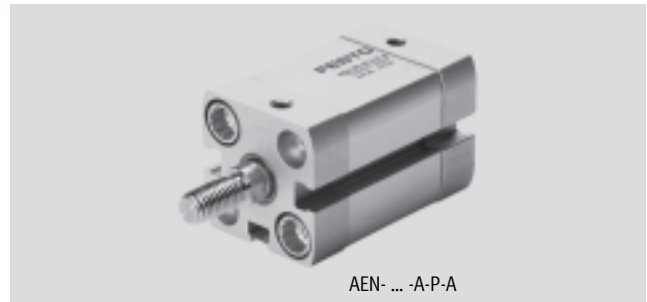

AEN- ... -A-P-A

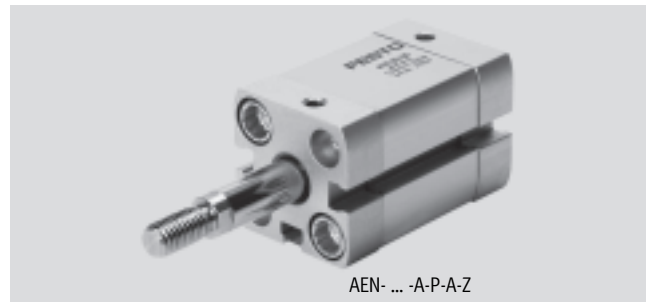

AEN- ... -A-P-A-Z

General technical data										
Piston Ø	12	16	20	25	32	40	50	63	80	100
Pneumatic connection	M5	M5	M5	M5	G $\frac{1}{8}$	G $\frac{1}{8}$	G $\frac{1}{8}$	G $\frac{1}{8}$	G $\frac{1}{8}$	G $\frac{1}{8}$
Piston rod thread										
Female	M3	M4	M6	M6	M8	M8	M10	M10	M12	M12
Male	M5	M6	M8	M8	M10x1.25	M10x1.25	M12x1.25	M12x1.25	M16x1.5	M16x1.5
Design	Piston									
	Piston rod									
	Cylinder barrel									
Cushioning	Flexible cushioning rings/pads at both ends									
Position sensing	Via proximity sensor									
Type of mounting	Via through-hole									
	Via female thread									
	Via accessories									
Mounting position	Any									

Operating and environmental conditions										
Piston Ø	12	16	20	25	32	40	50	63	80	100
Operating medium	Compressed air in accordance with ISO 8573-1:2010 [7:4:4]									
Note on operating/pilot medium	Operation with lubricated medium possible (in which case lubricated operation will always be required)									
Operating pressure [bar]										
—	1.5 ... 10		1 ... 10							
Z	1.7 ... 10	2.2 ... 10	1.3 ... 10			0.7 ... 10	0.6 ... 10			
Q	1.5 ... 10		1 ... 10							
Ambient temperature ¹⁾ [°C]										
—	-20 ... +80									
S6	0 ... +120									
Corrosion resistance class CRC ²⁾	2									

1) Note operating range of proximity sensors

2) Corrosion resistance class 2 according to Festo standard 940 070

Components subject to moderate corrosion stress. Externally visible parts with primarily decorative surface requirements which are in direct contact with a normal industrial environment or media such as coolants or lubricating agents.

Compact cylinders AEN, to ISO 21287

Technical data

Forces [N] and impact energy [J]										
Piston Ø	12	16	20	25	32	40	50	63	80	100
AEN										
Theoretical force at 6 bar, advancing	56	95	162	259	441	702	1,098	1,783	2,899	4,511
AEN-...Z, pulling										
Theoretical force at 6 bar, retracting	39	65	115	211	373	634	977	1,663	2,610	4,323
Max. impact energy in the end positions	0.04	0.04	0.04	0.08	0.1	0.15	0.18	0.28	0.35	0.7

Permissible impact velocity:

$$v_{perm.} = \sqrt{\frac{2 \times E_{perm.}}{m_{dead} + m_{load}}}$$

$v_{perm.}$ Permissible impact velocity
 $E_{perm.}$ Max. impact energy
 m_{dead} Moving load (drive)
 m_{load} Moving effective load

 Note
 This data represents the maximum values that can be achieved. The maximum permissible impact energy must be observed.

Maximum permissible load:

$$m_{load} = \frac{2 \times E_{perm.}}{v^2} - m_{dead}$$

Spring return force F as a function of the stroke l

Ø 12 ... 20

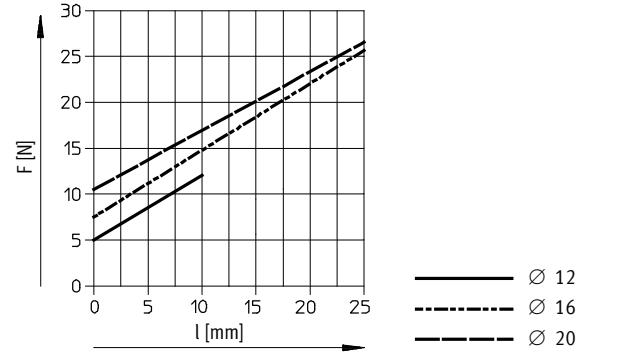

Ø 25 ... 100

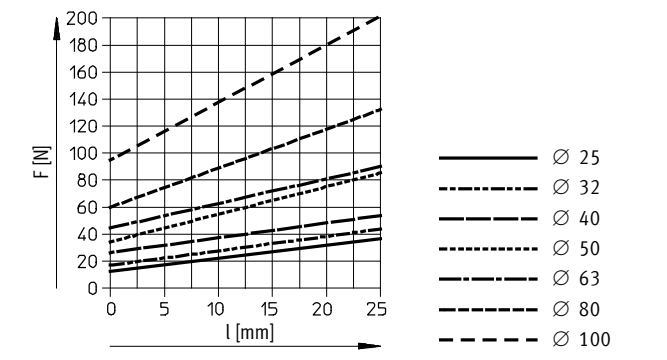

 Note
 The degree of friction depends upon the mounting position and the type of load involved. Single-acting cylinders should as far as possible be operated without lateral forces.

Compact cylinders AEN, to ISO 21287

Technical data

Weight [g]										
Piston \varnothing	12	16	20	25	32	40	50	63	80	100
Product weight with 0 mm stroke	77	79	131	156	265	346	540	722	1,300	2,154
Additional weight per 10 mm stroke	12	14	21	23	30	37	51	59	79	98
Moving load with 0 mm stroke	9	15	30	50	60	80	140	180	400	570
Additional load per 10 mm stroke	2	4	6	6	9	9	16	16	25	25

Materials

Sectional view

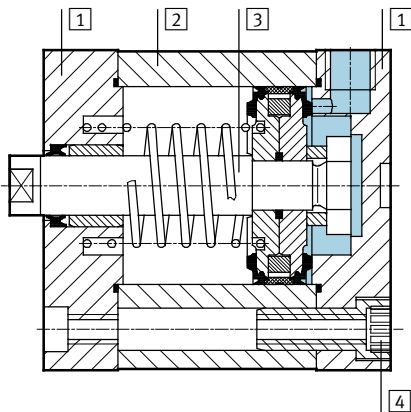

Compact cylinder	Basic version	S6
1 Bearing and end cap	Anodised aluminium	
2 Cylinder barrel	Anodised aluminium	
3 Piston rod	High-alloy steel	
4 Flange screws	\varnothing 12 ... 16	High-alloy steel
	\varnothing 20 ... 63	Galvanised steel
	\varnothing 80 ... 100	Standard screws, galvanised steel
- Seals	Polyurethane	Fluoro elastomer
Note on materials	RoHS-compliant	

Compact cylinders AEN, to ISO 21287

Technical data

Dimensions – Basic version

Download CAD data → www.festo.com

Ø 12 ... 63

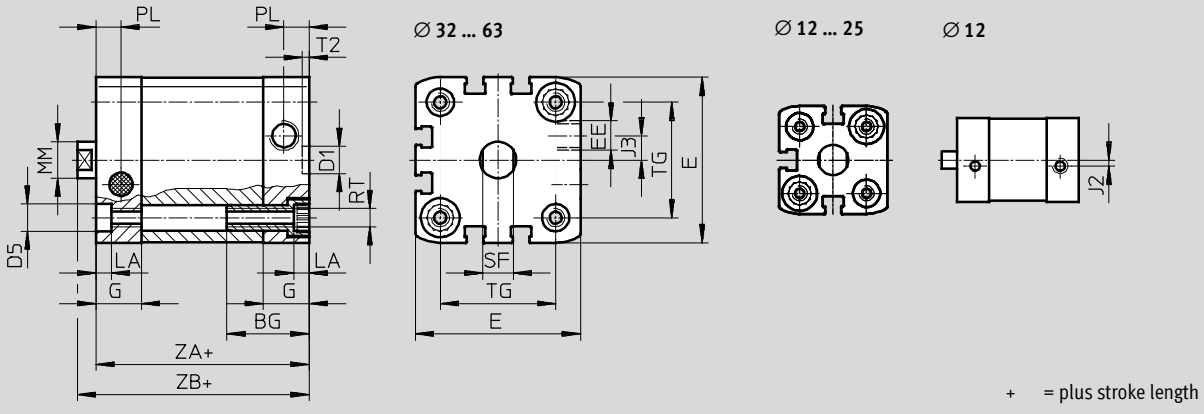

Ø 80 ... 100

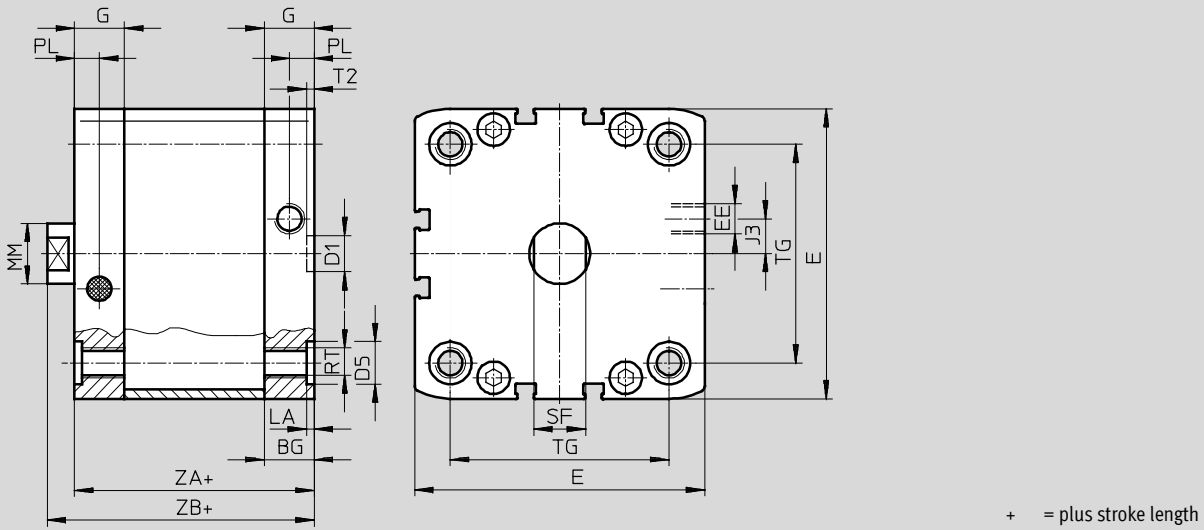

Compact cylinders AEN, to ISO 21287

Technical data

∅ [mm]	BG min.	D1 ∅ H9	D5 ∅ F9	E	EE	G	J2	J3	LA +0.2
12	17	9	6	27.5 ^{+0.3}	M5	10.5	2	-	3.5
16				29 ^{+0.3}		11			
20	19.5		9	35.5 ^{+0.3}		12	2.6		
25				39.5 ^{+0.3}					
32	26	12	9	47 ^{+0.3}	G1/8	15	6	5	
40				54.5 ^{+0.3}					8
50	27		12	65.5 ^{+0.3}		16.5	11.5		
63			75.5 ^{+0.3}						
80	17	15	95.5 ^{+0.6}	21.5	20	2.6			
100	21.5		113.5 ^{+0.6}						

∅ [mm]	MM ∅ h8	PL +0.2	RT	SF h13	T2 +0.1	TG ±0.2	ZA ±0.3	ZB +1.2
12	6	6	M4	5	2.1	16	35	39.2
16	8			7		18		39.7
20	10		M5	9		22	37	42.5
25				26		39	44.5	
32	12	8.2	M6	10	2.6	32.5	44	50
40				38		45	51.1	
50	16		M8	13	46.5	49	53.2	
63				56.5	57.1			
80	20	M10	17	72	54	62.9		
100			10.5	89	67	76		

Compact cylinders AEN, to ISO 21287

Technical data

FESTO

Dimensions – Variants

Download CAD data → www.festo.com

Basic version

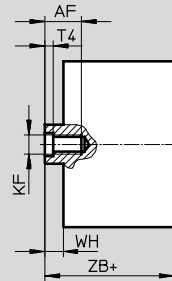
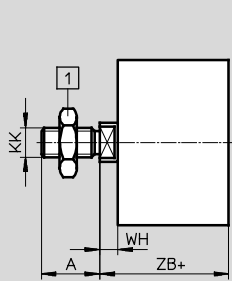

1 Hex nut DIN 439-B
only with \varnothing 32 ... 100

+ = plus stroke length

Z – pulling

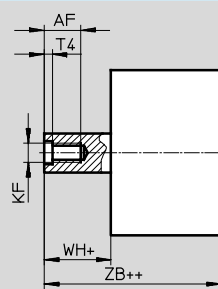
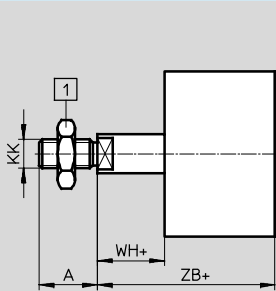

1 Hex nut DIN 439-B
only with \varnothing 32 ... 100

+ = plus stroke length

++ = plus 2x stroke length

K2 – Extended male piston rod thread

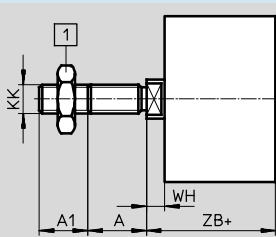

1 Hex nut DIN 439-B
only with \varnothing 32 ... 100

+ = plus stroke length

K5 – Special piston rod thread

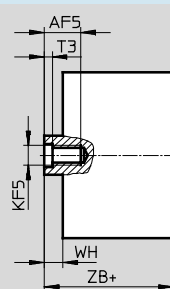
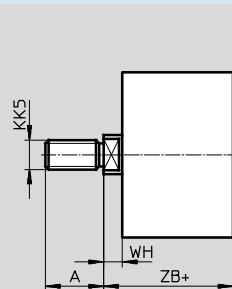

+ = plus stroke length

K8 – Extended piston rod

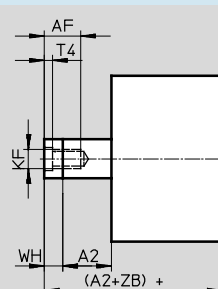
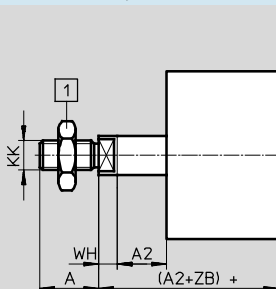

1 Hex nut DIN 439-B
only with \varnothing 32 ... 100

+ = plus stroke length

Compact cylinders AEN, to ISO 21287

Technical data

∅ [mm]	A -0.5	A1	A2	AF min.	AF5 min.	KF	KF5
12	10	1 ... 10	1 ... 300	8	-	M3	-
16	12			10		M4	
20	16	1 ... 20		14	12	M6	M5
25			16	14	M8	M6	
32	19		16	14	M10	M8	
40			19	16	M12	M10	
50	22		20	16	M10	M8	
63		22	20	16	M12	M10	
80	28	1 ... 30	1 ... 500	20	20	M12	M10
100							

∅ [mm]	KK	KK5	T3	T4	WH +1.3	ZB +1.2
12	M5	M6	-	1.5	4.2	39.2
16	M6	M8			4.7	39.7
20	M8	M10x1.25	2	2.6	5.5	42.5
25		M10				44.5
32	M10x1.25	M10	2.6	3.3	6	50
40		M12			6.1	51.1
50	M12x1.25	M12	3.3	4.7	8.2	53.2
63		M16			8.1	57.1
80	M16x1.5	M16	4.7	6.1	8.9	62.9
100		M20x1.5 M20			9	76

Compact cylinders AEN, to ISO 21287

Technical data

FESTO

Dimensions – Variants

Download CAD data → www.festo.com

Q – Square piston rod

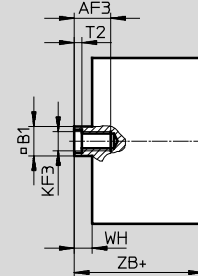
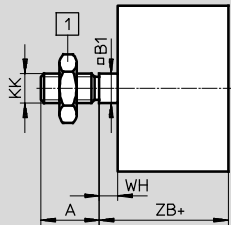

1 Hex nut DIN 439-B
only with $\varnothing 32 \dots 100$

+ = plus stroke length

Q – Z – pulling

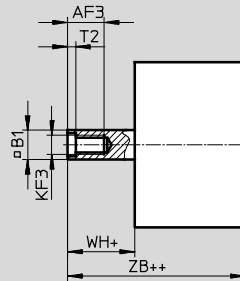
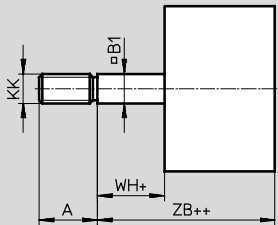

1 Hex nut DIN 439-B
only with $\varnothing 32 \dots 100$

+ = plus stroke length

++ = plus 2x stroke length

Q-K2 – Square piston rod with extended male thread

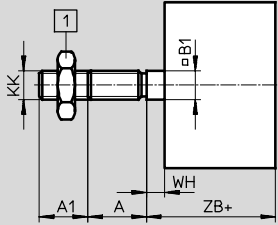

1 Hex nut DIN 439-B
only with $\varnothing 32 \dots 100$

+ = plus stroke length

Q-K5 – Square, special piston rod thread

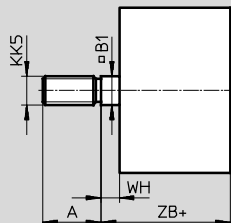

+ = plus stroke length

Q-K8 – Square, extended piston rod

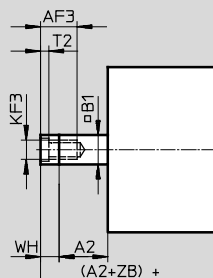
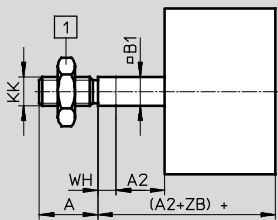

1 Hex nut DIN 439-B
only with $\varnothing 32 \dots 100$

+ = plus stroke length

Compact cylinders AEN, to ISO 21287

Technical data

∅ [mm]	A -0.5	A1	A2	AF3 min.	B1 □	KF3
12	10	1 ... 10	1 ... 300	8	5.5	M3
16	12			10	7	M4
20	16	1 ... 20		12	9	M5
25			19	14	10	M6
32	22			16	12	M8
40				20	16	M10
50	28	1 ... 30	1 ... 500	20	16	M10
63						
80						
100						

∅ [mm]	KK	KK5	T2	WH +1.3	ZB +1.2
12	M5	M6	1.5	4.2	39.2
16	M6	M8		4.7	39.7
20	M8	M10x1.25	2	5.5	42.5
25		M10			44.5
32	M10x1.25	M10	2.6	6	50
40				6.1	51.1
50	M12x1.25	M16	3.3	8.2	53.2
63				8.1	57.1
80	M16x1.5	M16	4.7	8.9	62.9
100				9	76

Compact cylinders AEN, to ISO 21287

Ordering data – Modular products, basic version and variants

Ordering table								
Size	12	16	20	25	32	Condi- tions	Code	Enter code
M Module No.	536 414	536 415	536 416	536 417	536 418			
Function	Compact cylinder, single-acting, based on ISO 21287						AEN	AEN
Piston Ø [mm]	12	16	20	25	32		-...	
Stroke [mm]	1 ... 10		1 ... 25				-...	
Type of thread	Male thread						-A	
	Female thread					¹	-I	
Cushioning	Flexible cushioning rings/pads at both ends						-P	-P
Position sensing	Via proximity sensor						-A	-A
O Effective direction of action	Single-acting, pulling						-Z	
Male thread extended [mm]	Extended male piston rod thread 1 ... 10		1 ... 20			²	-...K2	
Special piston rod thread	Male thread	M6	M8	M10x1.25 M10	M10x1.25 M10	M10 M12	²	-“...”K5
	Female thread	-	-	M5	M5	M6		
Piston rod extended [mm]	Extended piston rod 1 ... 10		1 ... 25			³	-...K8	
Improved running performance	-		Smooth anodised aluminium coated piston rod				-K10	
Temperature resistance	Heat-resistant seals up to max. 120 °C						-S6	
Captive rating plate	Laser etched rating plate						-TL	

- ¹ **I** Not with extended male thread K2
- ² **K2, K5** Not with improved running performance K10

- ³ **K8** The sum of the stroke length and piston rod extension must not exceed the maximum permissible stroke length

Transfer order code

	AEN	-		-		-	P	-	A
--	------------	---	--	---	--	---	----------	---	----------

Compact cylinders AEN, to ISO 21287

Ordering data – Modular products, basic version and variants

Ordering table									
Size	40	50	63	80	100	Condi- tions	Code	Enter code	
M Module No.	536 419	536 420	536 421	536 422	536 423				
Function	Compact cylinder, single-acting, based on ISO 21287							AEN	AEN
Piston Ø [mm]	40	50	63	80	100		-...		
Stroke [mm]	1 ... 25							-...	
Type of thread	Male thread							-A	
	Female thread						1	-I	
Cushioning	Flexible cushioning rings/pads at both ends							-P	-P
Position sensing	Via proximity sensor							-A	-A
O Effective direction of action	Single-acting, pulling							-Z	
Male thread extended [mm]	Extended male piston rod thread 1 ... 20			1 ... 30		2	-...K2		
Special piston rod thread	Male thread	M10	M12	M12	M16	M16	2	-“...”K5	
		M12	M16	M16	M20	M20			
	Female thread	M6	M8	M8	M10	M10			
Piston rod extended [mm]	Extended piston rod 1 ... 25						3	-...K8	
Improved running performance	Smooth anodised aluminium coated piston rod							-K10	
Temperature resistance	Heat-resistant seals up to max. 120 °C							-S6	
Captive rating plate	Laser etched rating plate							-TL	

- 1 I** Not with extended male thread K2
- 2 K2, K5** Not with improved running performance K10

- 3 K8** The sum of the stroke length and piston rod extension must not exceed the maximum permissible stroke length

Transfer order code

- - - - - - -

Compact cylinders AEN, to ISO 21287

Ordering data – Modular products, Q – Version with square piston rod, non-rotating

Ordering table							
Size	16	20	25	32	Condi- tions	Code	Enter code
M Module No.	536 415	536 416	536 417	536 418			
Function	Compact cylinder, single-acting, based on ISO 21287					AEN	AEN
Piston Ø [mm]	16	20	25	32		-...	
Stroke [mm]	1 ... 25					-...	
Type of thread	Male thread					-A	
	Female thread				[1]	-I	
Cushioning	Flexible cushioning rings/pads at both ends					-P	-P
Position sensing	Via proximity sensor					-A	-A
O Effective direction of action	Single-acting, pulling					-Z	
Protection against torsion	Square piston rod					-Q	-Q
Male thread extended [mm]	Extended male piston rod thread					-...K2	
Special piston rod thread	Male thread	M8	M10x1.25 M10	M10x1.25 M10	M10	-“...”K5	
Piston rod extended [mm]	Extended piston rod					-...K8	
Temperature resistance	Heat-resistant seals up to max. 120 °C					-S6	
Captive rating plate	Laser etched rating plate					-TL	

[1] I Not with extended male thread K2

[2] K8 The sum of the stroke length and piston rod extension must not exceed the maximum permissible stroke length

Transfer order code

Compact cylinders AEN, to ISO 21287

Ordering data – Modular products, Q – Version with square piston rod, non-rotating

Ordering table									
Size	40	50	63	80	100	Condi- tions	Code	Enter code	
M Module No.	536 419	536 420	536 421	536 422	536 423				
Function	Compact cylinder, single-acting, based on ISO 21287						AEN	AEN	
Piston Ø [mm]	40	50	63	80	100		-...		
Stroke [mm]	1 ... 25							-...	
Type of thread	Male thread							-A	
	Female thread						¹	-I	
Cushioning	Flexible cushioning rings/pads at both ends							-P	-P
Position sensing	Via proximity sensor							-A	-A
O Effective direction of action	Single-acting, pulling							-Z	
Protection against torsion	Square piston rod							-Q	-Q
Male thread extended [mm]	Extended male piston rod thread 1 ... 20			1 ... 30			-...K2		
Special piston rod thread	M10	M12	M12	M16	M16		-“...”K5		
Piston rod extended [mm]	Extended piston rod 1 ... 25						²	-...K8	
Temperature resistance	Heat-resistant seals up to max. 120 °C							-S6	
Captive rating plate	Laser etched rating plate							-TL	

¹ I Not with extended male thread K2

² K8 The sum of the stroke length and piston rod extension must not exceed the maximum permissible stroke length

Transfer order code

- - Q - - - - -

Compact cylinders ADNP, to ISO 21287, with polymer end caps

Peripherals overview

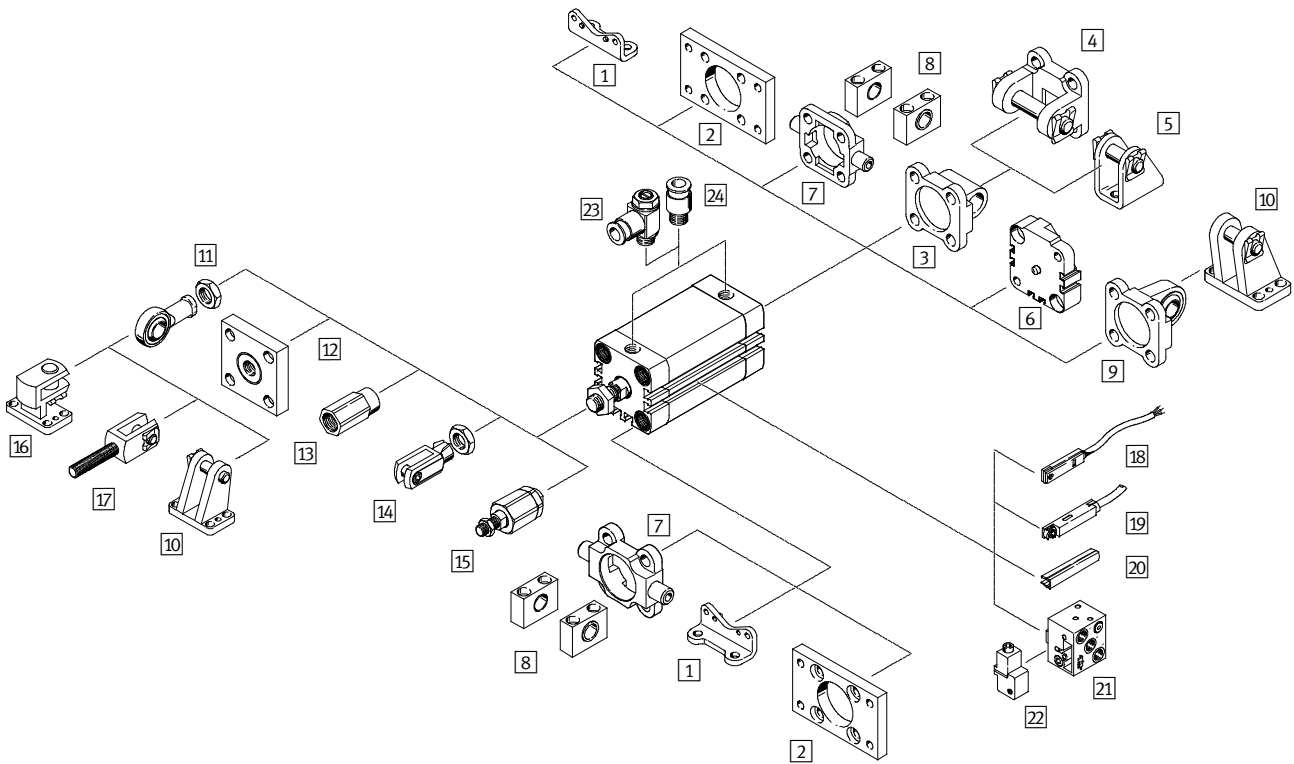

Compact cylinders ADNP, to ISO 21287, with polymer end caps

Peripherals overview

Mounting attachments and accessories		
	Brief description	→ Page/Internet
1	Foot mounting HNA	For bearing or end caps 79
2	Flange mounting FNC	For bearing or end caps 80
3	Swivel flange SNCL	For end caps 81
4	Swivel flange SNCB	For swivel flange SNCL 85
5	Clevis foot LBN/CRLBN	For swivel flange SNCL 84
6	Multi-position kit DPNA	For connecting two cylinders with identical piston \varnothing to form a multi-position cylinder 83
7	Trunnion flange ZNCF/CRZNG	For bearing caps 86
8	Trunnion support LNZG	For trunnion flange ZNCF/CRZNG 87
9	Swivel flange SNCS	For end caps 82
10	Clevis foot LBG	For swivel flange SNCS 82
11	Rod eye SGS/CRSGS	With spherical bearing 88
12	Coupling piece KSG/KSZ	For compensating radial deviations 88
13	Adapter AD	For mounting a vacuum suction cup on a hollow cylinder piston rod 88
14	Rod clevis SG/CRSG	Permits a swivelling movement of the cylinder in one plane 88
15	Self-aligning rod coupler FK	For compensating radial and angular deviations 88
16	Right-angle clevis foot LQG	For rod eye SGS 89
17	Rod clevis SGA	With male thread 88
18	Proximity sensor SME/SMT-8	Can be integrated in the sensor slot of the cylinder profile barrel 91
19	Proximity sensor SME/SMT-8M	Can be integrated in the sensor slot of the cylinder profile barrel 91
20	Slot cover ABP-5-S	For protecting the sensor cable and keeping dirt out of the sensor slots 91
21	Proximity sensor SMPO-8E	Pneumatic output signal 91
22	Mounting kit SMB-8E	For proximity sensor SMPO-8E 91
23	One-way flow control valve GRLA/GRLZ	For speed regulation 89
24	Push-in fitting QS	For connecting compressed air tubing with standard O.D. quick star

 - Note

For the compressed air ports only push-in fittings or one-way flow control valves with cylindrical

connecting thread (M or G thread) may be used.

Compact cylinders ADNP, to ISO 21287, with polymer end caps

Type codes

		ADNP	-	20	-	50	-	A	-	P	-	A
Type												
Double-acting												
ADNP	Compact cylinder											
Piston Ø [mm]												
Stroke [mm]												
Piston rod thread												
A	Male thread											
I	Female thread											
Cushioning												
P	Flexible cushioning rings/pads at both ends											
Position sensing												
A	Via proximity sensor											

Compact cylinders ADNP, to ISO 21287, with polymer end caps

FESTO

Technical data

Function

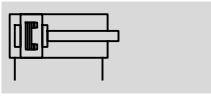

 Diameter
20 ... 50 mm

 Stroke length
5 ... 80 mm

 www.festo.com



General technical data						
Piston Ø		20	25	32	40	50
Pneumatic connection		M5	M5	G $\frac{1}{8}$	G $\frac{1}{8}$	G $\frac{1}{8}$
Piston rod thread	Female	M6	M6	M8	M8	M10
	Male	M8	M8	M10x1.25	M10x1.25	M10x1.25
Constructional design		Piston				
		Piston rod				
		Cylinder barrel				
Cushioning		Flexible cushioning rings/pads at both ends				
Position sensing		Via proximity sensor				
Type of mounting		Via through-holes				
		Via female threads				
		Via accessories				
Mounting position		Any				

Operating and environmental conditions	
Operating medium	Compressed air in accordance with ISO 8573-1:2010 [7:4:4]
Note on operating/pilot medium	Operation with lubricated medium possible (in which case lubricated operation will always be required)
Operating pressure [bar]	0.6 ... 10
Ambient temperature ¹⁾ [°C]	-10 ... +60
Corrosion resistance class CRC ²⁾	2

1) Note operating range of proximity sensors

2) Corrosion resistance class 2 to Festo standard 940 070

Components subject to moderate corrosion stress. Externally visible parts with primarily decorative surface requirements which are in direct contact with a normal industrial environment or media such as coolants or lubricating agents

Compact cylinders ADNP, to ISO 21287, with polymer end caps

Technical data

Forces [N] and impact energy [J]					
Piston \varnothing	20	25	32	40	50
Theoretical force at 6 bar, advancing	188	295	483	754	1178
Theoretical force at 6 bar, retracting	141	247	415	686	1057
Max. impact energy at the end positions	0.16	0.24	0.32	0.56	0.80

Max. lateral force F_Q as a function of the projection x

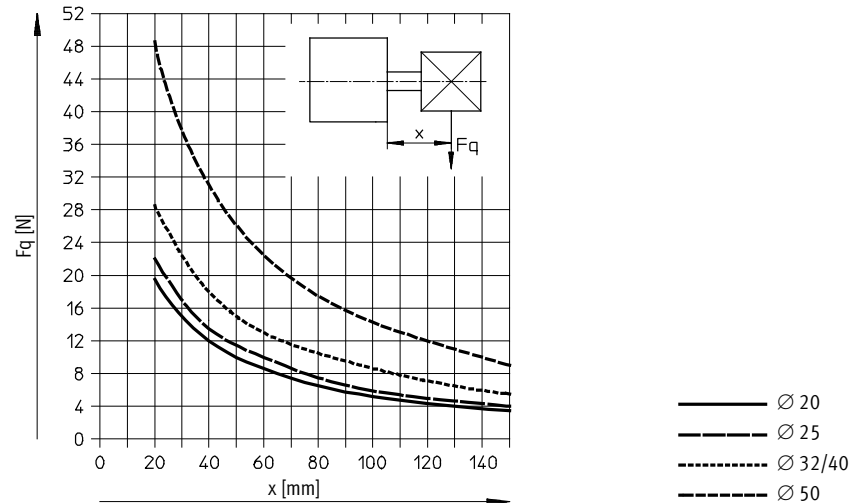

Weight [g]					
Piston \varnothing	20	25	32	40	50
Product weight with 0 mm stroke	115	116	204	240	380
Additional weight per 10 mm stroke	17	19	24	32	41
Moving load with 0 mm stroke	20	20	45	55	94
Additional load per 10 mm stroke	2	2	3	3	6

Materials

Sectional view

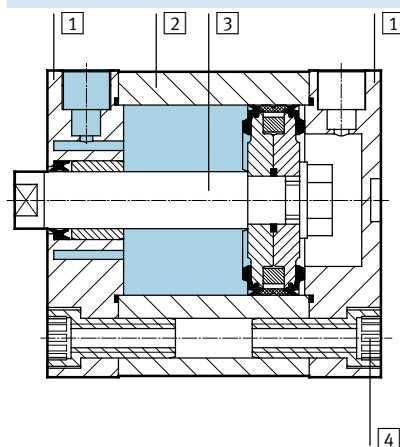

Compact cylinder		
1	Cover	Polyarylamide
2	Cylinder barrel	Smooth anodised aluminium
3	Piston rod	Smooth anodised aluminium, steel insert with male thread
4	Flange screws	Galvanised steel
-	Seals	Polyurethane, nitrile rubber
Note on materials		RoHS compliant

Compact cylinders ADNP, to ISO 21287, with polymer end caps

Technical data

FESTO

Dimensions – Basic version

Download CAD data → www.festo.com

∅ 20 ... 50

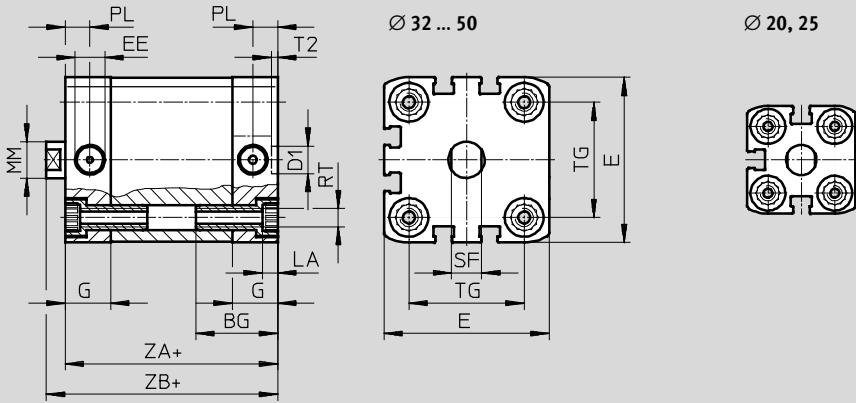

 Note
For the compressed air ports only push-in fittings or one-way flow control valves with cylindrical connecting thread (M or G thread) may be used.

+ = plus stroke length

∅	BG	D1	EE	E	G	LA	MM	PL	RT	SF	T2	TG	ZA	ZB
[mm]	min.	∅ H9		+0.3		+0.2	∅ h8			h13	+0.1	±0.2	±0.3	+1.2
20	19.5	9	M5	35.5	12	5	10	6	M5	8	2.1	22	37	42.5
25			M5	39.5			12	26	39	44.5				
32	26		G $\frac{1}{8}$	47	15		12	8.2	M6	10		32.5	44	50
40			G $\frac{1}{8}$	54.5			15		38	45		51.1		
50	27	12	G $\frac{1}{8}$	65.5		16	M8	13	46.5	53.2				

Dimensions – Variants

Download CAD data → www.festo.com

Basic version



1 Hex nut to DIN 439-B only with ∅ 32 ... 50

+ = plus stroke length

∅	A	AF	KF	KK	T4	WH	ZB
[mm]	-0.5	min.				+1.3	+1.2
20	16	14	M6	M8	2.6	5.5	42.5
25						44.5	
32	19	16	M8	M10x1.25	3.3	6	50
40						6.1	51.1
50	22	20	M10	M12x1.25	4.7	8.2	53.2

Compact cylinders ADNP, to ISO 21287, with polymer end caps

Technical data

Ordering data						
Type	Piston Ø [mm]	Stroke [mm]	Female piston rod thread		Male piston rod thread	
			Part No.	Type	Part No.	Type
	20	5	571971	ADNP-20-5-I-P-A	571926	ADNP-20-5-A-P-A
		10	571972	ADNP-20-10-I-P-A	571927	ADNP-20-10-A-P-A
		15	571973	ADNP-20-15-I-P-A	571928	ADNP-20-15-A-P-A
		20	571974	ADNP-20-20-I-P-A	571929	ADNP-20-20-A-P-A
		25	571975	ADNP-20-25-I-P-A	571930	ADNP-20-25-A-P-A
		30	571976	ADNP-20-30-I-P-A	571931	ADNP-20-30-A-P-A
		40	571977	ADNP-20-40-I-P-A	571932	ADNP-20-40-A-P-A
		50	571978	ADNP-20-50-I-P-A	571933	ADNP-20-50-A-P-A
	60	571979	ADNP-20-60-I-P-A	571934	ADNP-20-60-A-P-A	
	25	5	571980	ADNP-25-5-I-P-A	571935	ADNP-25-5-A-P-A
		10	571981	ADNP-25-10-I-P-A	571936	ADNP-25-10-A-P-A
		15	571982	ADNP-25-15-I-P-A	571937	ADNP-25-15-A-P-A
		20	571983	ADNP-25-20-I-P-A	571938	ADNP-25-20-A-P-A
		25	571984	ADNP-25-25-I-P-A	571939	ADNP-25-25-A-P-A
		30	571985	ADNP-25-30-I-P-A	571940	ADNP-25-30-A-P-A
		40	571986	ADNP-25-40-I-P-A	571941	ADNP-25-40-A-P-A
		50	571987	ADNP-25-50-I-P-A	571942	ADNP-25-50-A-P-A
	60	571988	ADNP-25-60-I-P-A	571943	ADNP-25-60-A-P-A	
	32	10	571989	ADNP-32-10-I-P-A	571944	ADNP-32-10-A-P-A
		15	571990	ADNP-32-15-I-P-A	571945	ADNP-32-15-A-P-A
		20	571991	ADNP-32-20-I-P-A	571946	ADNP-32-20-A-P-A
		25	571992	ADNP-32-25-I-P-A	571947	ADNP-32-25-A-P-A
		30	571993	ADNP-32-30-I-P-A	571948	ADNP-32-30-A-P-A
		40	571994	ADNP-32-40-I-P-A	571949	ADNP-32-40-A-P-A
		50	571995	ADNP-32-50-I-P-A	571950	ADNP-32-50-A-P-A
		60	571996	ADNP-32-60-I-P-A	571951	ADNP-32-60-A-P-A
	80	571997	ADNP-32-80-I-P-A	571952	ADNP-32-80-A-P-A	
	40	10	571998	ADNP-40-10-I-P-A	571953	ADNP-40-10-A-P-A
		15	571999	ADNP-40-15-I-P-A	571954	ADNP-40-15-A-P-A
		20	572000	ADNP-40-20-I-P-A	571955	ADNP-40-20-A-P-A
		25	572001	ADNP-40-25-I-P-A	571956	ADNP-40-25-A-P-A
		30	572002	ADNP-40-30-I-P-A	571957	ADNP-40-30-A-P-A
		40	572003	ADNP-40-40-I-P-A	571958	ADNP-40-40-A-P-A
		50	572004	ADNP-40-50-I-P-A	571959	ADNP-40-50-A-P-A
		60	572005	ADNP-40-60-I-P-A	571960	ADNP-40-60-A-P-A
	80	572006	ADNP-40-80-I-P-A	571961	ADNP-40-80-A-P-A	
	50	10	572007	ADNP-50-10-I-P-A	571962	ADNP-50-10-A-P-A
		15	572008	ADNP-50-15-I-P-A	571963	ADNP-50-15-A-P-A
		20	572009	ADNP-50-20-I-P-A	571964	ADNP-50-20-A-P-A
		25	572010	ADNP-50-25-I-P-A	571965	ADNP-50-25-A-P-A
		30	572011	ADNP-50-30-I-P-A	571966	ADNP-50-30-A-P-A
		40	572012	ADNP-50-40-I-P-A	571967	ADNP-50-40-A-P-A
		50	572013	ADNP-50-50-I-P-A	571968	ADNP-50-50-A-P-A
		60	572014	ADNP-50-60-I-P-A	571969	ADNP-50-60-A-P-A
	80	572015	ADNP-50-80-I-P-A	571970	ADNP-50-80-A-P-A	

Compact cylinders ADN/AEN, to ISO 21287

Accessories

Foot mounting HNA

Material:

- HNA: Galvanised steel
- HNA-...-R3: Steel with protective coating
- Free of copper and PTFE
- RoHS-compliant

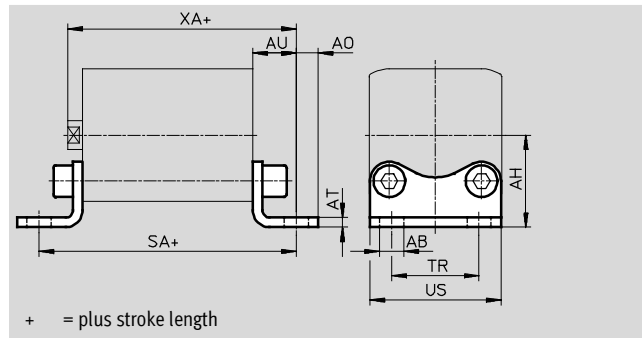

Dimensions and ordering data									
For \varnothing	AB \varnothing	AH	AO	AT	AU	SA	TR	US	XA
[mm]	H14	JS14		± 0.5	± 0.2		± 0.2	-0.5	
12	5.8	21	5	3	13	61	16	26	52.2
16		22	4.75				18	27.5	52.9
20	7	27	6.25	4	16	69	22	34.5	58.7
25		29					38.5	60.7	
32		33.5					46	66.2	
40	10	38	9	5	18	81	36	54	69.2
50		45	8		87	45	64	74.2	
63		50	91		50	75	78.2		
80	12	63	10.5	6	26	106	63	63	89
100	14.5	74	12.5		27	121	75	110	103

For \varnothing	Basic version				R3 – High corrosion protection			
	CRC ¹⁾	Weight [g]	Part No.	Type	CRC ¹⁾	Weight [g]	Part No.	Type
[mm]								
12	1	39	537 237	HNA-12	3	39	537 252	HNA-12-R3
16	1	42	537 238	HNA-16	3	42	537 253	HNA-16-R3
20	1	84	537 239	HNA-20	3	84	537 254	HNA-20-R3
25	1	90	537 240	HNA-25	3	90	537 255	HNA-25-R3
32	1	123	537 241	HNA-32	3	123	537 256	HNA-32-R3
40	1	157	537 242	HNA-40	3	157	537 257	HNA-40-R3
50	1	278	537 243	HNA-50	3	278	537 258	HNA-50-R3
63	1	328	537 244	HNA-63	3	328	537 259	HNA-63-R3
80	1	634	537 249	HNA-80	3	634	537 260	HNA-80-R3
100	1	814	537 250	HNA-100	3	814	537 261	HNA-100-R3

1) Corrosion resistance class 1 to Festo standard 940 070
 Components with light corrosion exposure. Protection for transport and storage. Components without significant decorative function or surface, e.g. installed out of sight internally or behind covers.
 Corrosion resistance class 3 to Festo standard 940 070
 Components requiring higher corrosion resistance. External visible parts in direct contact with industrial atmospheres or media such as solvents and cleaning agents, with a predominantly functional requirement for the surface

Compact cylinders ADN/AEN, to ISO 21287

Accessories

FESTO

Flange mounting FNC

Material:
Galvanised steel
Free of copper and PTFE
RoHS-compliant

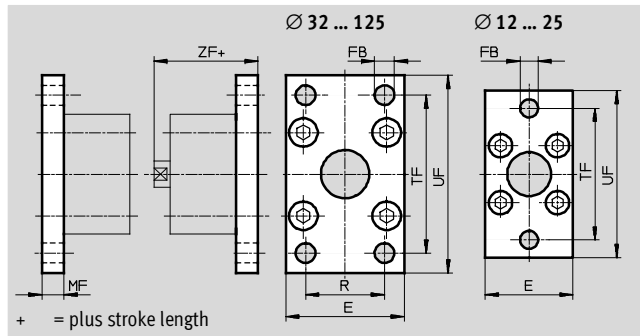

Dimensions and ordering data											
For Ø	E	FB Ø	MF	R	TF	UF ±1	ZF	CRC ¹⁾	Weight [g]	Part No.	Type
[mm]											
12	28	5.5	8	-	40	50	47.2	1	79	537 245	FNC-12
16	29				43	55	47.9	1	88	537 246	FNC-16
20	36	6.6			55	70	50.7	1	141	537 247	FNC-20
25	40				60	76	52.7	1	165	537 248	FNC-25
32	45	7	10	32	64	80	60.2	1	221	174 376	FNC-32
40	54	9		36	72	90	61.2	1	291	174 377	FNC-40
50	65		12	45	90	110	65.2	1	536	174 378	FNC-50
63	75			50	100	120	69.2	1	679	174 379	FNC-63
80	93	12	16	63	126	150	79	1	1495	174 380	FNC-80
100	110	14		75	150	175	92	1	2041	174 381	FNC-100
125	132	16		20	90	180	210	112	1	3775	174 382

1) Corrosion resistance class 1 to Festo standard 940 070
Components with light corrosion exposure. Protection for transport and storage. Components without significant decorative function or surface, e.g. installed out of sight internally or behind covers.

Compact cylinders ADN/AEN, to ISO 21287

Accessories



Swivel flange SNCL

Material:

SNCL: Die-cast aluminium

SNCL-...-R3: Die-cast aluminium with protective coating

Free of copper and PTFE

RoHS-compliant

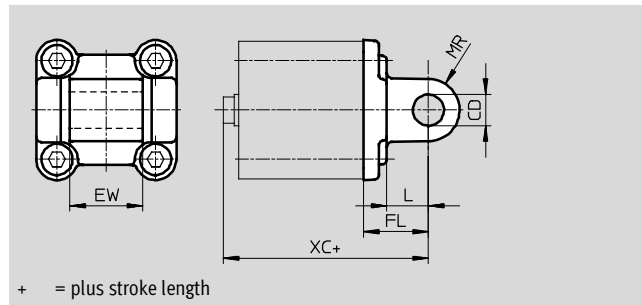
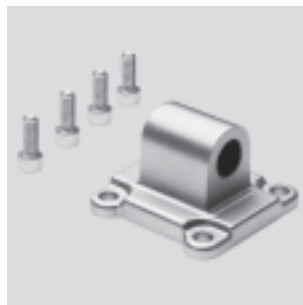

Dimensions and ordering data						
For \varnothing [mm]	CD \varnothing H9	EW	FL ± 0.2	L	MR	XC
12	6	12 _{h12}	16	10	6	55.2
16						55.9
20	8	16 _{h12}	20	14	8	62.7
25						64.7
32	10	26 _{-0.2/-0.6}	22	13	10	72.2
40	12	28 _{-0.2/-0.6}	25	16	12	75.2
50		32 _{-0.2/-0.6}	27			80.2
63	16	40 _{-0.2/-0.6}	32	21	16	89.2
80		50 _{-0.2/-0.6}	36			99
100	20	60 _{-0.2/-0.6}	41	27	20	117
125	25	70 _{-0.2/-0.6}	50	30	25	142

For \varnothing [mm]	Basic version				R3 – High corrosion protection			
	CRC ¹⁾	Weight [g]	Part No.	Type	CRC ¹⁾	Weight [g]	Part No.	Type
12	2	20	537 790	SNCL-12	3	20	537 794	SNCL-12-R3
16	2	25	537 791	SNCL-16	3	25	537 795	SNCL-16-R3
20	2	40	537 792	SNCL-20	3	40	537 796	SNCL-20-R3
25	2	45	537 793	SNCL-25	3	45	537 797	SNCL-25-R3
32	2	85	174 404	SNCL-32	–	–	–	–
40	2	115	174 405	SNCL-40	–	–	–	–
50	2	180	174 406	SNCL-50	–	–	–	–
63	2	270	174 407	SNCL-63	–	–	–	–
80	2	480	174 408	SNCL-80	–	–	–	–
100	2	700	174 409	SNCL-100	–	–	–	–
125	2	1300	174 410	SNCL-125	–	–	–	–

1) Corrosion resistance class 2 to Festo standard 940 070

Components subject to moderate corrosion stress. Externally visible parts with primarily decorative surface requirements which are in direct contact with a normal industrial environment or media such as coolants or lubricating agents.

Corrosion resistance class 3 to Festo standard 940 070

Components requiring higher corrosion resistance. External visible parts in direct contact with industrial atmospheres or media such as solvents and cleaning agents, with a predominantly functional requirement for the surface

Compact cylinders ADN/AEN, to ISO 21287

Accessories

FESTO

Swivel flange SNCS

Material:
Die-cast aluminium
Free of copper and PTFE
RoHS-compliant

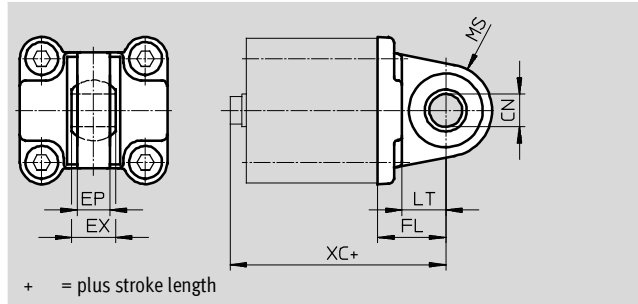
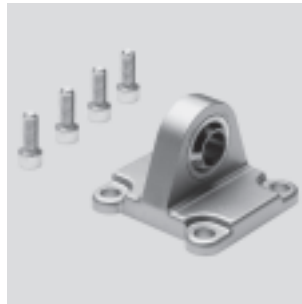

Dimensions and ordering data											
For \varnothing	CN	EP	EX	FL	LT	MS	XC	CRC ¹⁾	Weight	Part No.	Type
[mm]	\varnothing H7	± 0.2		± 0.2					[g]		
32	10	10.5	14	22	13	15	72.2	2	85	174 397	SNCS-32
40	12	12	16	25	16	17	75.2	2	125	174 398	SNCS-40
50	16	15	21	27	16	20	80.2	2	210	174 399	SNCS-50
63	16	15	21	32	21	22	89.2	2	280	174 400	SNCS-63
80	20	18	25	36	22	27	99	2	540	174 401	SNCS-80
100	20	18	25	41	27	29	117	2	700	174 402	SNCS-100
125	30	25	37	50	30	39	142	2	1410	174 403	SNCS-125

1) Corrosion resistance class 2 to Festo standard 940 070
Components subject to moderate corrosion stress. Externally visible parts with primarily decorative surface requirements which are in direct contact with a normal industrial environment or media such as coolants or lubricating agents

Clevis foot LBG

The clevis foot is secured against rotation with a dowel pin.

Material:
Nodular graphite cast iron
Free of copper and PTFE
RoHS-compliant

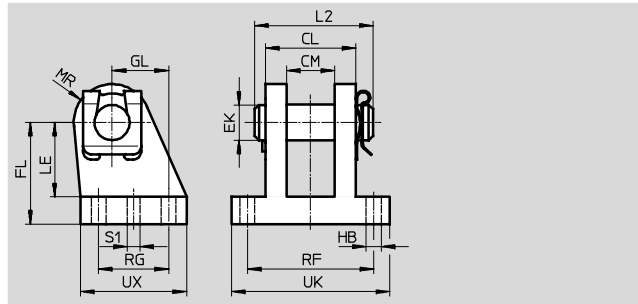

Dimensions and ordering data																		
For \varnothing	CL	CM	EK	FL	GL	HB	L2	LE	MR	RF	RG	S1	UK	UX	CRC ¹⁾	Weight	Part No.	Type
[mm]	± 0.2		\varnothing			\varnothing						\varnothing				[g]		
32	28	14.1	10	32	16 ± 0.25	6.8	35	24	12	42	20 ± 0.3	4.8	56	36	2	220	31 761	LBG-32
40	30	16.1	12	36	20 ± 0.3	6.8	39	26	14	44	26 ± 0.3	5.8	58	41.5	2	300	31 762	LBG-40
50	40	21.1	16	45	25 ± 0.3	9.2	50	33	15	56	31 ± 0.4	5.8	70	47	2	540	31 763	LBG-50
63	40	21.1	16	50	25 ± 0.3	9	50	38	17	56	31 ± 0.4	7.8	70	45	2	580	31 764	LBG-63
80	50	25.1	20	63	30	11	60	49	18	70	36	7.8	89	55	2	1050	31 765	LBG-80
100	50	25.1	20	71	41	11	60	56	22	70	46	9.8	89	65	2	1375	31 766	LBG-100
125	80	37.2	30	90	60	14	89	70	26	106	70	11.8	128	96	2	4140	31 767	LBG-125

1) Corrosion resistance class 2 to Festo standard 940 070
Components subject to moderate corrosion stress. Externally visible parts with primarily decorative surface requirements which are in direct contact with a normal industrial environment or media such as coolants or lubricating agents

Compact cylinders ADN/AEN, to ISO 21287

Accessories

FESTO

Multi-position kit DPNA

Material:

Flange: Aluminium

Screws: Galvanised steel

Free of copper and PTFE

RoHS-compliant

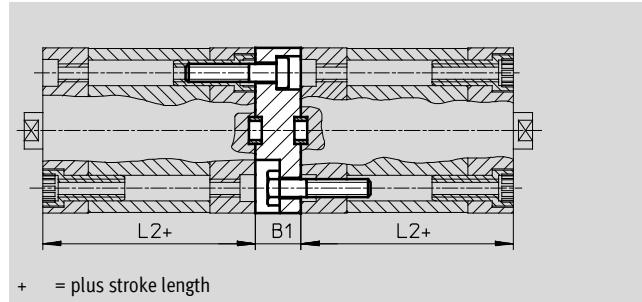

Dimensions and ordering data						
For Ø	L2	B1	Max. overall stroke length	CRC ¹⁾	Part No.	Type
[mm]			[mm]			
12	35	13	600	2	537 263	DPNA-12
16			600	2	537 264	DPNA-16
20	37		600	2	537 265	DPNA-20
25	39		600	2	537 266	DPNA-25
32	44	15	800	2	537 267	DPNA-32
40	45		800	2	537 268	DPNA-40
50			800	2	537 269	DPNA-50
63	49		800	2	537 270	DPNA-63
80	54	17	1000	2	537 271	DPNA-80
100	67	19.5	1000	2	537 272	DPNA-100

-  - Note

The maximum overall stroke length may not be exceeded when combining cylinders and multi-position kits.

1) Corrosion resistance class 2 to Festo standard 940 070

Components subject to moderate corrosion stress. Externally visible parts with primarily decorative surface requirements which are in direct contact with a normal industrial environment or media such as coolants or lubricating agents

Compact cylinders ADN/AEN, to ISO 21287

Accessories

Clevis foot LBN

Material:
Galvanised steel
Free of copper and PTFE
RoHS-compliant

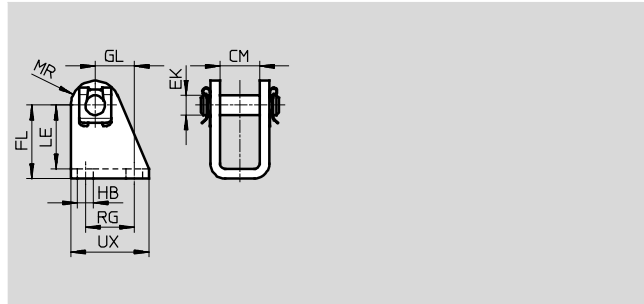
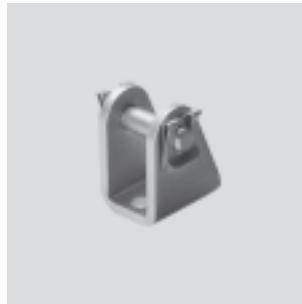

Dimensions and ordering data													Part No.	Type
For \varnothing	CM	EK \varnothing	FL	GL	HB \varnothing	LE	MR	RG	UX	CRC ¹⁾	Weight [g]			
[mm]														
12/16	12.1	6	27 +0.3/-0.2	13	5.5	24	7	15	25	2	40	6 058	LBN-12/16	
20/25	16.1	8	30 +0.4/-0.2	16	6.6	26	10	20	32	2	81	6 059	LBN-20/25	

1) Corrosion resistance class 2 to Festo standard 940 070
Components subject to moderate corrosion stress. Externally visible parts with primarily decorative surface requirements which are in direct contact with a normal industrial environment or media such as coolants or lubricating agents

Clevis foot CRLBN, stainless steel

Material:
High-alloy steel
Free of copper and PTFE
RoHS-compliant

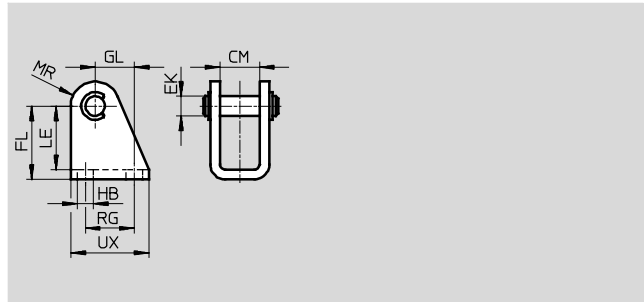

Dimensions and ordering data													Part No.	Type
For \varnothing	CM	EK \varnothing	FL	GL	HB \varnothing	LE	MR	RG	UX	CRC ¹⁾	Weight [g]			
[mm]														
12/16	12.1	6	27 +0.3/-0.2	13	5.5	24	7	15	25	4	55	161 862	CRLBN-12/16	
20/25	16.1	8	30 +0.4/-0.2	16	6.6	26	10	20	32	4	62	161 863	CRLBN-20/25	

1) Corrosion resistance class 4 to Festo standard 940 070
Components requiring higher corrosion resistance. Parts used with aggressive media, e.g. food or chemical industry. These applications should be supported with special tests with the media if required

Compact cylinders ADN/AEN, to ISO 21287

Accessories

FESTO

Swivel flange SNCB/SNCB-...-R3

Material:
SNCB: Die-cast aluminium
SNCB-...-R3: Die-cast aluminium with protective coating, high corrosion protection
Free of copper and PTFE
RoHS-compliant

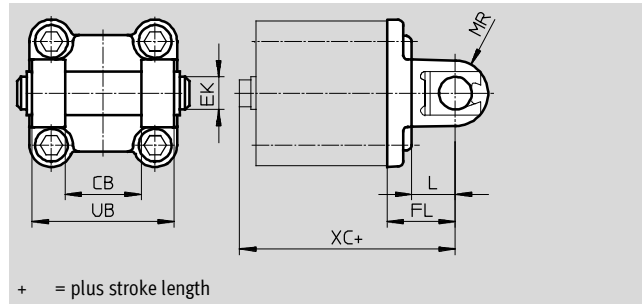

Dimensions and ordering data							
For \varnothing	CB	EK	FL	L	MR	UB	XC
[mm]	H14	\varnothing e8	± 0.2			h14	
32	26	10	22	13	8.5	45	72
40	28	12	25	16	12	52	76
50	32	12	27	16	12	60	80
63	40	16	32	21	16	70	89
80	50	16	36	22	16	90	99
100	60	20	41	27	20	110	117
125	70	25	50	30	25	130	142

For \varnothing	Basic version				R3 – High corrosion protection			
	CRC ¹⁾	Weight [g]	Part No.	Type	CRC ¹⁾	Weight [g]	Part No.	Type
[mm]								
32	2	103	174 390	SNCB-32	3	100	176 944	SNCB-32-R3
40	2	155	174 391	SNCB-40	3	151	176 945	SNCB-40-R3
50	2	232	174 392	SNCB-50	3	228	176 946	SNCB-50-R3
63	2	375	174 393	SNCB-63	3	371	176 947	SNCB-63-R3
80	2	636	174 394	SNCB-80	3	632	176 948	SNCB-80-R3
100	2	1035	174 395	SNCB-100	3	986	176 949	SNCB-100-R3
125	2	1860	174 396	SNCB-125	3	1776	176 950	SNCB-125-R3

1) Corrosion resistance class 2 to Festo standard 940 070
Components subject to moderate corrosion stress. Externally visible parts with primarily decorative surface requirements which are in direct contact with a normal industrial environment or media such as coolants or lubricating agents.
Corrosion resistance class 3 to Festo standard 940 070
Components requiring higher corrosion resistance. External visible parts in direct contact with industrial atmospheres or media such as solvents and cleaning agents, with a predominantly functional requirement for the surface

Compact cylinders ADN/AEN, to ISO 21287

Accessories

Trunnion flange ZNCF/CRZNG

Material:

- ZNCF: Special steel casting
- CRZNG: Electrolytically polished special steel casting
- Free of copper and PTFE
- RoHS-compliant

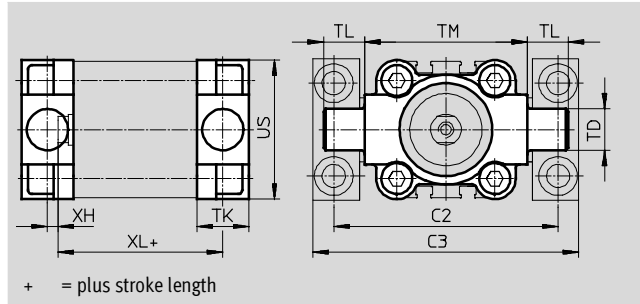

Dimensions and ordering data									
For Ø	C2	C3	TD	TK	TL	TM	US	XH	XL
[mm]			Ø						
			e9						
32	71	86	12	16	12	50	45	2	52
40	87	105	16	20	16	63	54	4	55
50	99	117	16	24	16	75	64	4	57
63	116	136	20	24	20	90	75	4	61
80	136	156	20	28	20	110	93	5	81
100	164	189	25	38	25	132	110	10	86
125	192	217	25	50	25	160	131	14	106

For Ø	Basic version				R3 – High corrosion protection			
	CRC ¹⁾	Weight [g]	Part No.	Type	CRC ¹⁾	Weight [g]	Part No.	Type
[mm]								
32	2	130	174 411	ZNCF-32	4	150	161 852	CRZNG-32
40	2	240	174 412	ZNCF-40	4	260	161 853	CRZNG-40
50	2	390	174 413	ZNCF-50	4	430	161 854	CRZNG-50
63	2	600	174 414	ZNCF-63	4	640	161 855	CRZNG-63
80	2	1150	174 415	ZNCF-80	4	1300	161 856	CRZNG-80
100	2	2030	174 416	ZNCF-100	4	2400	161 857	CRZNG-100
125	2	3490	174 417	ZNCF-125	4	3600	185 362	CRZNG-125

1) Corrosion resistance class 2 to Festo standard 940 070
 Components subject to moderate corrosion stress. Externally visible parts with primarily decorative surface requirements which are in direct contact with a normal industrial environment or media such as coolants or lubricating agents.
 Corrosion resistance class 4 to Festo standard 940 070
 Components requiring higher corrosion resistance. Parts used with aggressive media, e.g. food or chemical industry. These applications should be supported with special tests with the media if required

Compact cylinders ADN/AEN, to ISO 21287

Accessories



Trunnion support LNZG

Material:

Trunnion support: Anodised aluminium

Plain bearing: Plastic

Free of copper and PTFE

RoHS-compliant

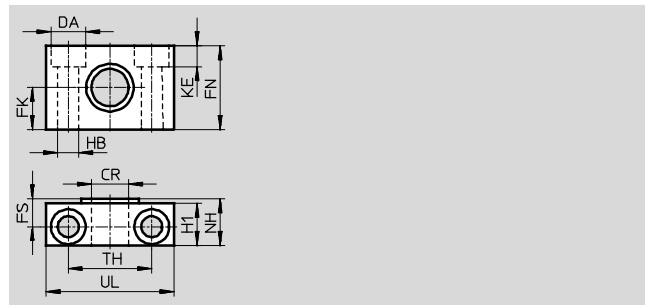
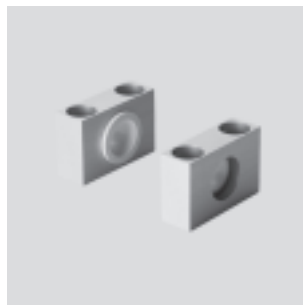

Dimensions and ordering data															
For \varnothing	CR	DA	FK	FN	FS	H1	HB	KE	NH	TH	UL	CRC ¹⁾	Weight	Part No.	Type
[mm]	\varnothing D11	\varnothing H13	\varnothing ± 0.1				\varnothing H13			± 0.2			[g]		
32	12	11	15	30	10.5	15	6.6	6.8	18	32	46	2	83	32 959	LNZG-32
40, 50	16	15	18	36	12	18	9	9	21	36	55	2	129	32 960	LNZG-40/50
63, 80	20	18	20	40	13	20	11	11	23	42	65	2	178	32 961	LNZG-63/80
100, 125	25	20	25	50	16	24.5	14	13	28.5	50	75	2	306	32 962	LNZG-100/125







1) Corrosion resistance class 2 to Festo standard 940 070

Components subject to moderate corrosion stress. Externally visible parts with primarily decorative surface requirements which are in direct contact with a normal industrial environment or media such as coolants or lubricating agents

Compact cylinders ADN/AEN, to ISO 21287

Accessories

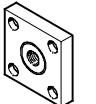
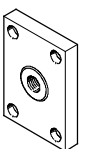

FESTO

Ordering data – Piston rod attachments				Technical data → Internet: piston-rod attachment			
Designation	For Ø	Part No.	Type	Designation	For Ø	Part No.	Type
Rod eye SGS				Rod clevis SGA used in combination with rod eye SGS			
	12	–			12, 16, 20, 25	–	
	16	9 254	SGS-M6		32, 40	32 954	SGA-M10x1,25
	20, 25	9 255	SGS-M8		50, 63	10 767	SGA-M12x1,25
	32, 40	9 261	SGS-M10x1,25		80, 100	10 768	SGA-M16x1,25
	50, 63	9 262	SGS-M12x1,25		125	10 769	SGA-M20x1,25
	80, 100	9 263	SGS-M16x1,5				
	125	9 264	SGS-M20x1,5				
Rod clevis SG				Self-aligning rod coupler FK			
	12	–			12	30 984	FK-M5
	16	3 110	SG-M6		16	2 061	FK-M6
	20, 25	3 111	SG-M8		20, 25	2 062	FK-M8
	32, 40	6 144	SG-M10x1,25		32, 40	6 140	FK-M10x1,25
	50, 63	6 145	SG-M12x1,25		50, 63	6 141	FK-M12x1,25
	80, 100	6 146	SG-M16x1,5		80, 100	6 142	FK-M16x1,5
	125	6 147	SG-M20x1,5		125	6 143	FK-M20x1,5
Coupling piece KSG				Coupling piece KSZ			
	12, 16, 20, 25	–			12	–	
	32, 40	32 963	KSG-M10x1,25		16	36 123	KSZ-M6
	50, 63	32 964	KSG-M12x1,25		20, 25	36 124	KSZ-M8
	80, 100	32 965	KSG-M16x1,5		32, 40	36 125	KSZ-M10x1,25
	125	32 966	KSG-M20x1,5		50, 63	36 126	KSZ-M12x1,25
			80, 100		36 127	KSZ-M16x1,5	
			125	36 128	KSZ-M20x1,5		
Adapter AD							
	12	–					
	16	157 328	AD-M6-M5				
		157 329	AD-M6-1/8				
		157 330	AD-M6-1/4				
	20	157 331	AD-M8-1/8				
	25	157 332	AD-M8-1/4				
	32	157 333	AD-M10x1,25-1/8				
	40	157 334	AD-M10x1,25-1/4				
	50	160 256	AD-M12x1,25-1/4				
63	160 257	AD-M12x1,25-3/8					

Compact cylinders ADN/AEN, to ISO 21287

Accessories

FESTO

Ordering data – Corrosion and acid resistant piston rod attachments				Technical data → Internet: crsg			
Designation	For Ø	Part No.	Type	Designation	For Ø	Part No.	Type
Rod eye CRSGS				Rod clevis CRSG			
	12	–			12	–	
	16	195 580	CRSGS-M6		16, 20	13 567	CRSG-M6
	20, 25	195 581	CRSGS-M8		20, 25	13 568	CRSG-M8
	32, 40	195 582	CRSGS-M10x1,25		32, 40	13 569	CRSG-M10x1,25
	50, 63	195 583	CRSGS-M12x1,25		50, 63	13 570	CRSG-M12x1,25
	80, 100	195 584	CRSGS-M16x1,5		80, 100	13 571	CRSG-M16x1,5
	125	195 585	CRSGS-M20x1,5		125	13 572	CRSG-M20x1,5

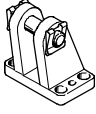
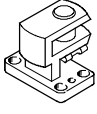
Ordering data – Mounting attachments				Technical data → Internet: clevis foot			
Designation	For Ø	Part No.	Type	Designation	For Ø	Part No.	Type
Clevis foot LBG for rod eye SGS				Right-angle clevis foot LQG for rod eye SGS			
	32, 40	31 761	LBG-32		32, 40	31 768	LQG-32
	50, 63	31 762	LBG-40		50, 63	31 769	LQG-40
	80, 100	31 763	LBG-50		80, 100	31 770	LQG-50
		31 764	LBG-63			31 771	LQG-63
	125	31 765	LBG-80		125	31 772	LQG-80
31 766		LBG-100	31 773	LQG-100			

Ordering data – One-way flow control valves				Technical data → Internet: grla		
Connection	Material		Part No.	Type		
	For Ø	For tubing O.D.				
For exhaust air						
	12, 16, 20, 25	3	Metal design	193 137	GRLA-M5-QS-3-D	
		4		193 138	GRLA-M5-QS-4-D	
		6		193 139	GRLA-M5-QS-6-D	
	32, 40, 50, 63, 80, 100	3		193 142	GRLA-1/8-QS-3-D	
		4		193 143	GRLA-1/8-QS-4-D	
		6		193 144	GRLA-1/8-QS-6-D	
		8		193 145	GRLA-1/8-QS-8-D	
		125		6	193 146	GRLA-1/4-QS-6-D
				8	193 147	GRLA-1/4-QS-8-D
		10		193 148	GRLA-1/4-QS-10-D	

Compact cylinders ADN/AEN, to ISO 21287

Accessories



FESTO

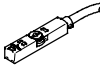
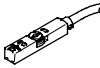

Ordering data – One-way flow control valves				Technical data → Internet: grlz	
Connection	Material		Part No.	Type	
	For Ø	For tubing O.D.			
For supply air					
	12, 16, 20, 25	3	Metal design	193 153	GRLZ-M5-QS-3-D
		4		193 154	GRLZ-M5-QS-4-D
		6		193 155	GRLZ-M5-QS-6-D
	32, 40, 50, 63, 80, 100	3		193 156	GRLZ-1/8-QS-3-D
		4		193 157	GRLZ-1/8-QS-4-D
		6		193 158	GRLZ-1/8-QS-6-D
		8		193 159	GRLZ-1/8-QS-8-D
	125	–		151 195	GRLZ-1/4-B

Ordering data – Proximity sensors for T-slot, magneto-resistive					Technical data → Internet: smt	
Type of mounting	Switch output	Electrical connection	Cable length [m]	Part No.	Type	
N/O contact						
	Insertable in the slot from above, flush with cylinder profile, short design	PNP	Cable, 3-wire	2.5	574335	SMT-8M-A-PS-24V-E-2,5-OE
			Plug M8x1, 3-pin	0.3	574334	SMT-8M-A-PS-24V-E-0,3-M8D
			Plug M12x1, 3-pin	0.3	574337	SMT-8M-A-PS-24V-E-0,3-M12
		NPN	Cable, 3-wire	2.5	574338	SMT-8M-A-NS-24V-E-2,5-OE
			Plug M8x1, 3-pin	0.3	574339	SMT-8M-A-NS-24V-E-0,3-M8D
N/C contact						
	Insertable in the slot from above, flush with cylinder profile, short design	PNP	Cable, 3-wire	7.5	574340	SMT-8M-A-PO-24V-E-7,5-OE

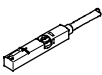
Compact cylinders ADN/AEN, to ISO 21287

Accessories

Ordering data – Proximity sensors for T-slot, magnetic reed					Technical data → Internet: sme	
	Type of mounting	Switch output	Electrical connection	Cable length [m]	Part No.	Type
N/O contact						
	Insertable in the slot from above, flush with cylinder profile	Contacting	Cable, 3-wire	2.5	543 862	SME-8M-DS-24V-K-2,5-OE
				5.0	543 863	SME-8M-DS-24V-K-5,0-OE
			Cable, 2-wire	2.5	543 872	SME-8M-ZS-24V-K-2,5-OE
				Plug M8x1, 3-pin	0.3	543 861
	Insertable in the slot lengthwise, flush with the cylinder profile	Contacting	Cable, 3-wire	2.5	150 855	SME-8-K-LED-24
			Plug M8x1, 3-pin	0.3	150 857	SME-8-S-LED-24
N/C contact						
	Insertable in the slot lengthwise, flush with the cylinder profile	Contacting	Cable, 3-wire	7.5	160 251	SME-8-O-K-LED-24

Ordering data – Connecting cables				Technical data → Internet: nebu	
	Electrical connection, left	Electrical connection, right	Cable length [m]	Part No.	Type
	Straight socket, M8x1, 3-pin	Cable, open end, 3-wire	2.5	541 333	NEBU-M8G3-K-2.5-LE3
			5	541 334	NEBU-M8G3-K-5-LE3
	Straight socket, M12x1, 5-pin	Cable, open end, 3-wire	2.5	541 363	NEBU-M12G5-K-2.5-LE3
			5	541 364	NEBU-M12G5-K-5-LE3
	Angled socket, M8x1, 3-pin	Cable, open end, 3-wire	2.5	541 338	NEBU-M8W3-K-2.5-LE3
			5	541 341	NEBU-M8W3-K-5-LE3
	Angled socket, M12x1, 5-pin	Cable, open end, 3-wire	2.5	541 367	NEBU-M12W5-K-2.5-LE3
			5	541 370	NEBU-M12W5-K-5-LE3

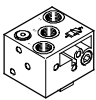
Ordering data – Rectangular proximity sensors, pneumatic			Technical data → Internet: smpo	
	Pneumatic connection		Part No.	Type
3/2-way valve, normally closed				
	Female thread M5		178 563	SMPO-8E

Ordering data – Mounting kits for proximity sensors SMPO-8E			Technical data → Internet: smb	
	Assembly		Part No.	Type
	Clamped in T-slot		178 230	SMB-8E

Ordering data – Slot cover for T-slot				
	Assembly	Length	Part No.	Type
	Insertable from above	2x 0.5 m	151 680	ABP-5-S