

# 膜片式空气干燥器 MS-LDM1, MS 系列







**FESTO**

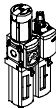
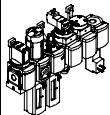

# 膜片式空气干燥器 MS-LDM1, MS 系列

产品范围一览 - MS 系列气源处理装置

FESTO

型号	规格	壳体上气接口	连接板	压力调节范围 [bar]						过滤等级 [ $\mu\text{m}$ ]				
				0.05	0.05	0.1	0.3	0.1	0.5					
				...	...	...	...	...	...	0.01	1	5	40	
代码		AG...	D2	D4	D5	D6	D7	D8	A	B	C	E		
<b>气源处理装置</b>														
MSB-FRC		4	G $\frac{1}{8}$ , G $\frac{1}{4}$	G $\frac{1}{8}$ , G $\frac{1}{4}$ , G $\frac{3}{8}$	-	-	-	■	■	-	-	-	■	■
		6	G $\frac{1}{4}$ , G $\frac{3}{8}$ , G $\frac{1}{2}$	G $\frac{1}{4}$ , G $\frac{3}{8}$ , G $\frac{1}{2}$ , G $\frac{3}{4}$	-	-	-	■	■	-	-	-	■	■
		9	-	-	-	-	-	-	-	-	-	-	-	-
		12	-	-	-	-	-	-	-	-	-	-	-	-
<b>气源处理装置组合 (用配置软件可订购更多派生型 → Internet: msb4, msb6 or msb9)</b>														
MSB		4	G $\frac{1}{4}$	G $\frac{1}{8}$ , G $\frac{1}{4}$ , G $\frac{3}{8}$	-	-	-	■	■	-	-	-	■	■
		6	G $\frac{1}{2}$	G $\frac{1}{4}$ , G $\frac{3}{8}$ , G $\frac{1}{2}$ , G $\frac{3}{4}$	-	-	-	■	■	-	-	-	■	■
		9	-	-	-	-	-	-	-	-	-	-	-	-
		12	-	-	-	-	-	-	-	-	-	-	-	-
<b>单个设备</b>														
过滤减压阀 MS-LFR		4	G $\frac{1}{8}$ , G $\frac{1}{4}$	G $\frac{1}{8}$ , G $\frac{1}{4}$ , G $\frac{3}{8}$	-	-	■	■	■	-	-	-	■	■
		6	G $\frac{1}{4}$ , G $\frac{3}{8}$ , G $\frac{1}{2}$	G $\frac{1}{4}$ , G $\frac{3}{8}$ , G $\frac{1}{2}$ , G $\frac{3}{4}$	-	-	■	■	■	■	-	-	■	■
		9	-	-	-	-	-	-	-	-	-	-	-	-
		12	-	G1, G1 $\frac{1}{4}$ , G1 $\frac{1}{2}$ , G2	-	-	-	■	■	■	-	-	■	■
过滤器 MS-LF		4	G $\frac{1}{8}$ , G $\frac{1}{4}$	G $\frac{1}{8}$ , G $\frac{1}{4}$ , G $\frac{3}{8}$	-	-	-	-	-	-	-	-	■	■
		6	G $\frac{1}{4}$ , G $\frac{3}{8}$ , G $\frac{1}{2}$	G $\frac{1}{4}$ , G $\frac{3}{8}$ , G $\frac{1}{2}$ , G $\frac{3}{4}$	-	-	-	-	-	-	-	-	■	■
		9	-	-	-	-	-	-	-	-	-	-	-	-
		12	-	G1, G1 $\frac{1}{4}$ , G1 $\frac{1}{2}$ , G2	-	-	-	-	-	-	-	-	■	■
精细和超精细 过滤器 MS-LFM		4	G $\frac{1}{8}$ , G $\frac{1}{4}$	G $\frac{1}{8}$ , G $\frac{1}{4}$ , G $\frac{3}{8}$	-	-	-	-	-	-	■	■	-	-
		6	G $\frac{1}{4}$ , G $\frac{3}{8}$ , G $\frac{1}{2}$	G $\frac{1}{4}$ , G $\frac{3}{8}$ , G $\frac{1}{2}$ , G $\frac{3}{4}$	-	-	-	-	-	-	■	■	-	-
		9	G $\frac{3}{4}$ , G1	G $\frac{1}{2}$ , G $\frac{3}{4}$ , G1, G1 $\frac{1}{4}$ , G1 $\frac{1}{2}$	-	-	-	-	-	-	■	■	-	-
		12	-	G1, G1 $\frac{1}{4}$ , G1 $\frac{1}{2}$ , G2	-	-	-	-	-	-	■	■	-	-
活性炭过滤器 MS-LFX		4	G $\frac{1}{8}$ , G $\frac{1}{4}$	G $\frac{1}{8}$ , G $\frac{1}{4}$ , G $\frac{3}{8}$	-	-	-	-	-	-	-	-	-	-
		6	G $\frac{1}{4}$ , G $\frac{3}{8}$ , G $\frac{1}{2}$	G $\frac{1}{4}$ , G $\frac{3}{8}$ , G $\frac{1}{2}$ , G $\frac{3}{4}$	-	-	-	-	-	-	-	-	-	-
		9	G $\frac{3}{4}$ , G1	G $\frac{1}{2}$ , G $\frac{3}{4}$ , G1, G1 $\frac{1}{4}$ , G1 $\frac{1}{2}$	-	-	-	-	-	-	-	-	-	-
		12	-	G1, G1 $\frac{1}{4}$ , G1 $\frac{1}{2}$ , G2	-	-	-	-	-	-	-	-	-	-
水分分离器 MS-LWS		4	-	-	-	-	-	-	-	-	-	-	-	-
		6	G $\frac{1}{4}$ , G $\frac{3}{8}$ , G $\frac{1}{2}$	G $\frac{1}{4}$ , G $\frac{3}{8}$ , G $\frac{1}{2}$ , G $\frac{3}{4}$	-	-	-	-	-	-	-	-	-	-
		9	-	-	-	-	-	-	-	-	-	-	-	-
		12	-	-	-	-	-	-	-	-	-	-	-	-

# 膜片式空气干燥器 MS-LDM1, MS 系列

产品范围一览 - MS 系列气源处理装置













型号  代码	规格	滤杯保护罩		冷凝水排放				压力指示器					驱动器锁		选项		→ 页码/ Internet
		塑料滤杯, 带塑料滤杯保护罩	金属滤杯	手动排放	半自动排放	全自动排放	外部, 全自动排放, 电驱动	连接板 (不带压力表)	集成MS压力表	连接板, 用于EN压力表 G <sup>1</sup> / <sub>2</sub>	连接板, 用于EN压力表 G <sup>1</sup> / <sub>4</sub>	压力传感器	旋转手柄, 可锁定	加长旋转手柄	消声器	气流方向从右向左	
		R	U	M	H	V	E...	VS	AG	A8	A4	AD...	AS	LD	S	Z	
<b>气源处理装置</b>																	
MSB-FRC	4	■	-	■	-	■	-	-	■	-	-	-	■	-	-	■	msb4
	6	■	■	■	-	■	-	-	■	-	-	-	■	-	-	■	msb6
	9	-	-	-	-	-	-	-	-	-	-	-	-	-	-	-	-
	12	-	-	-	-	-	-	-	-	-	-	-	-	-	-	-	-
<b>气源处理装置组合</b>																	
MSB	4	■	■	■	-	■	-	-	■	-	-	-	■	-	-	■	msb4
	6	■	■	■	-	■	-	-	■	-	-	-	■	-	-	■	msb6
	9	-	-	-	-	-	-	-	-	-	-	-	-	-	-	-	-
	12	-	-	-	-	-	-	-	-	-	-	-	-	-	-	-	-
<b>单个设备</b>																	
过滤减压阀 MS-LFR	4	■	■	■	■	■	-	■	■	■	■	■	■	■	-	■	ms4-lfr
	6	■	■	■	■	■	■	■	■	-	■	■	■	■	-	■	ms6-lfr
	9	-	-	-	-	-	-	-	-	-	-	-	-	-	-	-	-
	12	-	■	■	-	■	■	■	■	-	■	-	■	■	-	■	ms12-lfr
过滤器 MS-LF	4	■	■	■	■	■	-	-	-	-	-	-	-	-	-	■	ms4-lf
	6	■	■	■	■	■	■	-	-	-	-	-	-	-	-	■	ms6-lf
	9	-	-	-	-	-	-	-	-	-	-	-	-	-	-	-	-
	12	-	■	■	-	■	■	-	-	-	-	-	-	-	-	■	ms12-lf
精细和超精细过滤器 MS-LFM	4	■	■	■	■	■	-	-	-	-	-	-	-	-	-	■	ms4-lfm
	6	■	■	■	■	■	■	-	-	-	-	-	-	-	-	■	ms6-lfm
	9	-	■	■	-	■	■	-	-	-	-	-	-	-	-	■	ms9-lfm
	12	-	■	■	-	■	■	-	-	-	-	-	-	-	-	■	ms12-lfm
活性炭过滤器 MS-LFX	4	■	■	-	-	-	-	-	-	-	-	-	-	-	-	■	ms4-lfx
	6	■	■	-	-	-	-	-	-	-	-	-	-	-	-	■	ms6-lfx
	9	-	■	-	-	-	-	-	-	-	-	-	-	-	-	■	ms9-lfx
	12	-	■	-	-	-	-	-	-	-	-	-	-	-	-	■	ms12-lfx
水分分离器 MS-LWS	4	-	-	-	-	-	-	-	-	-	-	-	-	-	-	-	-
	6	-	■	-	-	■	■	-	-	-	-	-	-	-	-	■	ms6-lws
	9	-	-	-	-	-	-	-	-	-	-	-	-	-	-	-	-
	12	-	-	-	-	-	-	-	-	-	-	-	-	-	-	-	-

# 膜片式空气干燥器 MS-LDM1, MS 系列

产品范围一览 - MS 系列气源处理装置

FESTO

型号	规格	壳体上气接口	连接板	压力调节范围 [bar]								电源电压			
				0.05 ... 0.7	0.05 ... 2.5	0.1 ... 4	0.3 ... 7	0.1 ... 12	0.5 ... 16	24 V DC, 连接型式符合 EN 175301	24 V DC, 连接型式 M12 to DESINA	110 V AC, 连接型式符合 EN 175301	230 V AC, 连接型式符合 EN 175301		
代码			AG...	D2	D4	D5	D6	D7	D8	V24	V24P	V110	V230		
<b>单个设备</b>															
减压阀 MS-LR		4	G1/8, G1/4	G1/8, G1/4, G3/8	-	-	■	■	■	-	-	-	-		
		6	G1/4, G3/8, G1/2	G1/4, G3/8, G1/2, G3/4	-	-	■	■	■	■	-	-	-		
		9	-	-	-	-	-	-	-	-	-	-	-		
		12	-	G1, G1 1/4, G1 1/2, G2	-	-	-	■	■	■	-	-	-		
减压阀 MS-LRB		4	G1/4	G1/8, G1/4, G3/8	-	-	■	■	■	-	-	-	-		
		6	G1/2	G1/4, G3/8, G1/2, G3/4	-	-	■	■	■	■	-	-	-		
		9	-	-	-	-	-	-	-	-	-	-	-		
		12	-	-	-	-	-	-	-	-	-	-	-		
精密减压阀 MS-LRP		4	-	-	-	-	-	-	-	-	-	-	-		
		6	G1/4, G3/8, G1/2	G1/4, G3/8, G1/2, G3/4	■	■	■	-	■	-	-	-	-		
		9	-	-	-	-	-	-	-	-	-	-	-		
		12	-	-	-	-	-	-	-	-	-	-	-		
精密减压阀 MS-LRPB		4	-	-	-	-	-	-	-	-	-	-	-		
		6	G1/2	G1/4, G3/8, G1/2, G3/4	■	■	■	-	■	-	-	-	-		
		9	-	-	-	-	-	-	-	-	-	-	-		
		12	-	-	-	-	-	-	-	-	-	-	-		
电控减压阀 MS-LRE		4	-	-	-	-	-	-	-	-	-	-	-		
		6	G1/4, G3/8, G1/2	G1/4, G3/8, G1/2, G3/4	-	-	■	■	■	■	-	-	-		
		9	-	-	-	-	-	-	-	-	-	-	-		
		12	-	-	-	-	-	-	-	-	-	-	-		
油雾器 MS-LOE		4	G1/8, G1/4	G1/8, G1/4, G3/8	-	-	-	-	-	-	-	-	-		
		6	G1/4, G3/8, G1/2	G1/4, G3/8, G1/2, G3/4	-	-	-	-	-	-	-	-	-		
		9	-	-	-	-	-	-	-	-	-	-	-		
		12	-	G1, G1 1/4, G1 1/2, G2	-	-	-	-	-	-	-	-	-		
电控开关阀 MS-EM(1)		4	G1/8, G1/4	G1/8, G1/4, G3/8	-	-	-	-	-	-	-	-	-		
		6	G1/4, G3/8, G1/2	G1/4, G3/8, G1/2, G3/4	-	-	-	-	-	-	-	-	-		
		9	-	-	-	-	-	-	-	-	-	-	-		
		12	-	G1, G1 1/4, G1 1/2, G2	-	-	-	-	-	-	-	-	-		
电控开关阀 MS-EE		4	G1/8, G1/4	G1/8, G1/4, G3/8	-	-	-	-	-	-	■	-	■		
		6	G1/4, G3/8, G1/2	G1/4, G3/8, G1/2, G3/4	-	-	-	-	-	-	■	-	■		
		9	-	-	-	-	-	-	-	-	-	-	-		
		12	-	G1, G1 1/4, G1 1/2, G2	-	-	-	-	-	-	■	■	■	■	
电控 软启动阀 MS-DL		4	G1/8, G1/4	G1/8, G1/4, G3/8	-	-	-	-	-	-	-	-	-		
		6	G1/4, G3/8, G1/2	G1/4, G3/8, G1/2, G3/4	-	-	-	-	-	-	-	-	-		
		9	-	-	-	-	-	-	-	-	-	-	-		
		12	-	G1, G1 1/4, G1 1/2, G2	-	-	-	-	-	-	-	-	-		
电控 软启动阀 MS-DE		4	G1/8, G1/4	G1/8, G1/4, G3/8	-	-	-	-	-	-	■	-	■		
		6	G1/4, G3/8, G1/2	G1/4, G3/8, G1/2, G3/4	-	-	-	-	-	-	■	-	■		
		9	-	-	-	-	-	-	-	-	-	-	-		
		12	-	G1, G1 1/4, G1 1/2, G2	-	-	-	-	-	-	■	■	■	■	
软启动和排气 阀 MS-SV		4	-	-	-	-	-	-	-	-	-	-	-		
		6	G1/2	G1/4, G3/8, G1/2, G3/4	-	-	-	-	-	-	■	-	-		
		9	-	-	-	-	-	-	-	-	-	-	-		
		12	-	-	-	-	-	-	-	-	-	-	-		

# 膜片式空气干燥器 MS-LDM1, MS 系列

产品范围一览 - MS 系列气源处理装置







型号  代码	规格	滤杯保护罩		压力指示器				驱动器/阀			选项		→ 页码/ Internet
		塑料滤杯, 带塑料滤杯保护罩	金属滤杯	连接板 (不带压力表)	集成MS压力表	连接板, 用于EN压力表 G1/8	连接板, 用于EN压力表 G1/4	压力传感器	旋转手柄, 可锁定	加长旋转手柄	消声器	气流方向从右向左	
		R	U	VS	AG	A8	A4	AD...	AS	LD	S	Z	
<b>单个设备</b>													
减压阀 MS-LR	4	-	-	■	■	■	■	■	■	■	-	■	ms4-lr
	6	-	-	■	■	-	■	■	■	■	-	■	ms6-lr
	9	-	-	-	-	-	-	-	-	-	-	-	-
	12	-	-	■	■	-	■	-	■	■	-	■	ms12-lr
减压阀 MS-LRB	4	-	-	■	■	■	■	■	■	■	-	■	ms4-lrb
	6	-	-	■	■	-	■	■	■	■	-	■	ms6-lrb
	9	-	-	-	-	-	-	-	-	-	-	-	-
	12	-	-	-	-	-	-	-	-	-	-	-	-
精密减压阀 MS-LRP	4	-	-	-	-	-	-	-	-	-	-	-	-
	6	-	-	■	-	■	■	■	■	■	-	■	ms6-lrp
	9	-	-	-	-	-	-	-	-	-	-	-	-
	12	-	-	-	-	-	-	-	-	-	-	-	-
精密减压阀 MS-LRPB	4	-	-	-	-	-	-	-	-	-	-	-	-
	6	-	-	■	-	■	■	■	■	■	-	■	ms6-lrpb
	9	-	-	-	-	-	-	-	-	-	-	-	-
	12	-	-	-	-	-	-	-	-	-	-	-	-
电控减压阀 MS-LRE	4	-	-	-	-	-	-	-	-	-	-	-	-
	6	-	-	■	■	-	■	-	-	-	-	■	ms6-lre
	9	-	-	-	-	-	-	-	-	-	-	-	-
	12	-	-	-	-	-	-	-	-	-	-	-	-
油雾器 MS-LOE	4	■	■	-	-	-	-	-	-	-	-	■	ms4-loe
	6	■	■	-	-	-	-	-	-	-	-	■	ms6-loe
	9	-	-	-	-	-	-	-	-	-	-	-	-
	12	-	■	-	-	-	-	-	-	-	-	■	ms12-loe
电控开关阀 MS-EM(1)	4	-	-	■	■	■	■	■	-	-	■	■	ms4-em1
	6	-	-	■	■	-	■	■	-	-	■	■	ms6-em1
	9	-	-	-	-	-	-	-	-	-	-	-	-
	12	-	-	■	■	-	■	-	-	-	■	■	ms12-em
电控开关阀 MS-EE	4	-	-	■	■	■	■	■	-	-	■	■	ms4-ee
	6	-	-	■	■	-	■	■	-	-	■	■	ms6-ee
	9	-	-	-	-	-	-	-	-	-	-	-	-
	12	-	-	■	■	-	■	-	-	-	■	■	ms12-ee
电控 软启动阀 MS-DL	4	-	-	■	■	■	■	■	-	-	-	■	ms4-dl
	6	-	-	■	■	-	■	■	-	-	-	■	ms6-dl
	9	-	-	-	-	-	-	-	-	-	-	-	-
	12	-	-	■	■	-	■	-	-	-	-	■	ms12-dl
电控 软启动阀 MS-DE	4	-	-	■	■	■	■	■	-	-	-	■	ms4-de
	6	-	-	■	■	-	■	■	-	-	-	■	ms6-de
	9	-	-	-	-	-	-	-	-	-	-	-	-
	12	-	-	■	■	-	■	-	-	-	-	■	ms12-de
软启动和排气 阀 MS-SV	4	-	-	-	-	-	-	-	-	-	-	-	-
	6	-	-	■	■	-	■	■	-	-	■	■	ms6-sv
	9	-	-	-	-	-	-	-	-	-	-	-	-
	12	-	-	-	-	-	-	-	-	-	-	-	-

# 膜片式空气干燥器 MS-LDM1, MS 系列

产品范围一览 - MS 系列气源处理装置

FESTO

型号	规格	壳体上气接口	连接板	压力调节范围 [bar]				电源电压			
				0.1 ... 4	0.3 ... 7	0.1 ... 12	0.5 ... 16	24 V DC, 连接型式符合 EN 175301	24 V DC, 连接型式 M12 to DESINA	110 V AC, 连接型式符合 EN 175301	230 V AC, 连接型式符合 EN 175301
代码			AG...	D5	D6	D7	D8	V24	V24P	V110	V230
<b>单个设备</b>											
膜片式空气干燥器 MS-LDM1		4	G1/8, G1/4	G1/8, G1/4, G3/8	-	-	-	-	-	-	-
		6	G1/4, G3/8, G1/2	G1/4, G3/8, G1/2, G3/4	-	-	-	-	-	-	-
		9	-	-	-	-	-	-	-	-	-
		12	-	-	-	-	-	-	-	-	-
分支模块 MS-FRM		4	G1/8, G1/4	G1/8, G1/4, G3/8	-	-	-	-	-	-	-
		6	G1/4, G3/8, G1/2	G1/4, G3/8, G1/2, G3/4	-	-	-	-	-	-	-
		12	-	G1, G1 1/4, G1 1/2, G2	-	-	-	-	-	-	-
分气模块 MS-FRM-FRZ		4	G1/4	-	-	-	-	-	-	-	-
		6	G1/2	-	-	-	-	-	-	-	-
		9	-	-	-	-	-	-	-	-	-
		12	-	-	-	-	-	-	-	-	
流量传感器 MS-SFE		4	-	-	-	-	-	-	-	-	-
		6	G1/2	G1/2	-	-	-	-	-	-	-
		9	-	-	-	-	-	-	-	-	-
		12	-	-	-	-	-	-	-	-	-
流量传感器 SFAM		4	-	-	-	-	-	-	-	-	-
		6	G1/2	G1/2	-	-	-	-	-	-	-
		9	-	-	-	-	-	-	-	-	-
		12	-	-	-	-	-	-	-	-	-

# 膜片式空气干燥器 MS-LDM1, MS 系列

产品范围一览 - MS 系列气源处理装置



型号	规格	滤杯保护罩		压力指示器					开关输出		选项		→ 页码/ Internet
		塑料滤杯, 带塑料滤杯保护罩	金属滤杯	连接板 (不带压力表)	集成MS压力表	连接板, 用于EN压力表 G1/8	连接板, 用于EN压力表 G1/4	压力传感器	2x PNP	2x NPN	消声器	气流方向从右向左	
代码		R	U	VS	AG	A8	A4	AD...	P2/2S	N2/2S	S	Z/R	
<b>单个设备</b>													
膜片式空气干燥器 MS-LDM1	4	-	■	-	-	-	-	-	-	-	-	■	8
	6	-	■	-	-	-	-	-	-	-	-	■	8
	9	-	-	-	-	-	-	-	-	-	-	-	-
	12	-	-	-	-	-	-	-	-	-	-	-	-
分支模块 MS-FRM	4	-	-	■	■	■	■	■	-	-	-	■	ms4-frm
	6	-	-	■	■	-	■	■	-	-	-	■	ms6-frm
	9	-	-	-	-	-	-	-	-	-	-	-	-
	12	-	-	■	-	-	-	-	-	-	-	-	ms12-frm
分气模块 MS-FRM-FRZ	4	-	-	-	-	-	-	-	-	-	-	■	ms4-frm
	6	-	-	-	-	-	-	-	-	-	-	■	ms6-frm
	9	-	-	-	-	-	-	-	-	-	-	-	-
	12	-	-	-	-	-	-	-	-	-	-	-	-
流量传感器 MS-SFE	4	-	-	-	-	-	-	-	-	-	-	-	-
	6	-	-	-	-	-	-	-	■	■	-	■ <sup>1)</sup>	ms6-sfe
	9	-	-	-	-	-	-	-	-	-	-	-	-
	12	-	-	-	-	-	-	-	-	-	-	-	-
流量传感器 SFAM	4	-	-	-	-	-	-	-	-	-	-	-	-
	6	-	-	-	-	-	-	-	■	■	-	■	sfam
	9	-	-	-	-	-	-	-	-	-	-	-	-
	12	-	-	-	-	-	-	-	-	-	-	-	-

1) 只能用配置软件订购 → Internet: ms6-sfe

# 膜片式空气干燥器 MS4/MS6-LDM1, MS 系列

外围元件一览

## 膜片式空气干燥器 MS4/MS6-LDM1

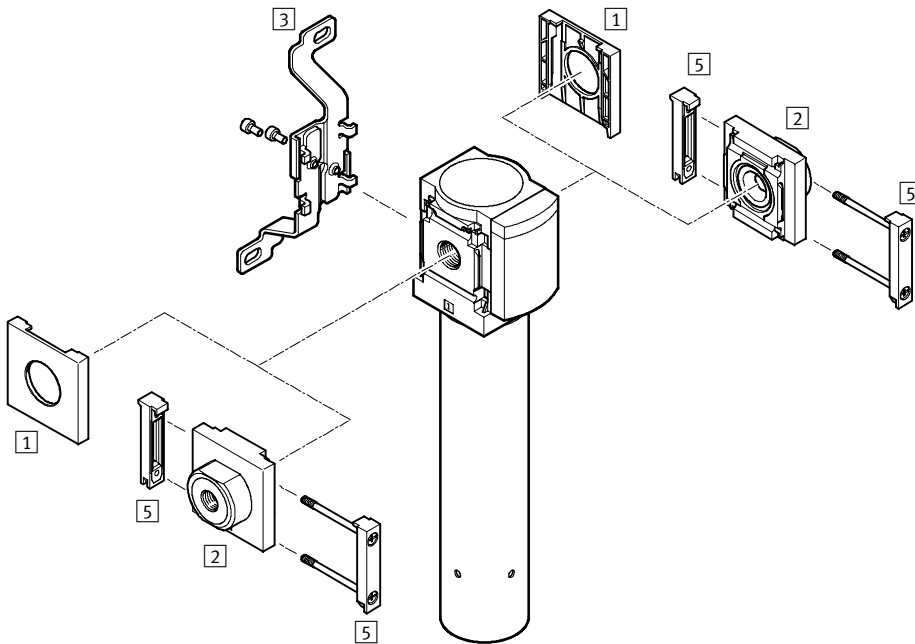

- 注意

额外附件:

- 用于MS4/MS6或MS9规格组合的模块连接件 → Internet: amv, rmv, armv
- 用于型材安装的连接板 → Internet: ipm-80, ipm-40-80, ipm-80-80

安装附件	单个设备		组合		→ 页码/Internet
	不带连接板	带连接板	不带连接板	带连接板	
1 盖子 MS4/6-END	■	-	■	-	ms4-end, ms6-end
2 连接板 MS4/6-AG...	-	■	-	■	ms4-ag, ms6-ag
3 安装支架 MS4/6-WB	■	■	-	-	ms4-wb, ms6-wb
5 模块连接件 MS4/6-MV	-	■	■	■	ms4-mv, ms6-mv
- 安装支架 MS4-WBM	■	■	-	-	ms4-wbm
- 安装支架 MS4/6-WP/WPB/WPE/WPM	-	■	■	■	ms4-wp, ms6-wp



# 膜片式空气干燥器 MS4/MS6-LDM1, MS 系列

型号代码

FESTO

		MS	6	-	LDM1	-	1/2	-	P20
<b>系列</b>									
MS	标准气源处理装置								
<b>规格</b>									
4	壳体宽度 40 mm								
6	壳体宽度 62 mm								
<b>功能</b>									
LDM1	膜片式空气干燥器								
<b>接口规格</b>									
MS4									
1/8	螺纹 G1/8								
1/4	螺纹 G1/4								
MS6									
1/4	螺纹 G1/4								
3/8	螺纹 G3/8								
1/2	螺纹 G1/2								
<b>气流滤芯</b>									
P10	滤芯P10								
P20	滤芯P20								
P40	滤芯P40								

## 用模块化系统可以订购更多派生型 → 15

- 连接板
- 气流滤芯
- 管式清洁空气
- 安装方式
- 可选气流方向

# 膜片式空气干燥器 MS4/MS6-LDM1, MS 系列

FESTO

技术参数

功能

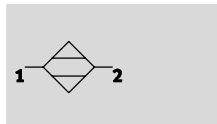

- - 流量  
50 ... 400 l/min

- - 温度范围  
+2 ... +50 °C

- - 输入压力  
3 ... 12.5 bar

压力露点降低:  
20 K

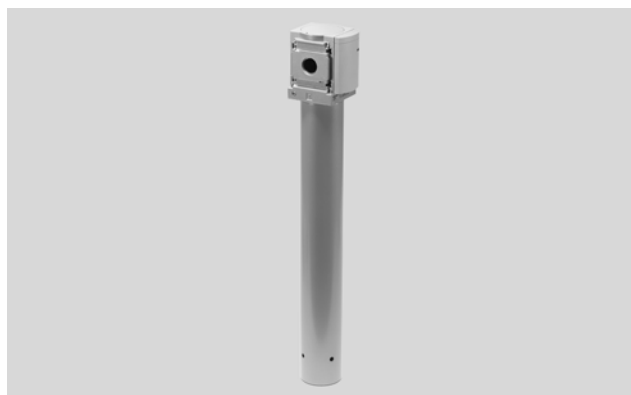

- 最好用的空气干燥器，工作可靠性优异
- 适合作为单个设备或用于集成到现有的气源处理装置组合中
- 流量相关的露点降低

- 功能无磨损，无需外部能源
- 压缩空气的成分经过干燥过程后几乎不会发生变化
- 15% 净化流量
- 可选净化环，用于导流净化空气

- 典型应用领域:
- 精密零件干燥清洁
  - 测量技术
  - 精密玻璃刻度尺清洗
  - 喷涂系统
  - 纸张和包装机械

- - 注意  
使用过滤等级为 0.01 μm (残留颗粒物 < 0.1 μm, 残留油份 < 0.1 mg/m<sup>3</sup>) 的超精细过滤器 MS-LFM-A 预先对气源进行过滤对于本产品的正常工作至关重要。

主要技术参数					
规格	MS4		MS6		
气接口 1, 2	G1/8	G1/4	G1/4	G3/8	G1/2
结构特点	膜片式干燥器，带内部空气消耗				
安装方式	通过附件 管式安装				
安装位置	垂直 ±5°				

注意: 该产品符合 ISO 1179-1 和 ISO 228-1 标准。

标准流量 q <sub>n</sub> <sup>1)</sup> [l/min]					
规格	MS4		MS6		
	滤芯 P05	滤芯 P10	滤芯 P20	滤芯 P30	滤芯 P40
输入 q <sub>n In</sub>	59	118	235	353	471
输出 q <sub>n Out</sub>	50	100	200	300	400
净化空气 q <sub>n Purge</sub>	8.8	17.6	35.3	52.9	70.6

1) 于 p<sub>1</sub> = 6.9 bar, θ<sub>pd In</sub> = 25 °C, θ<sub>pd Out</sub> = 5 °C ± 1.5 °C (θ<sub>PA Out</sub> = -21.5 °C ± 1.2 °C), θ<sub>amb</sub> = 25 °C 时测得

工作和环境条件		
输入压力	[bar]	3 ... 12.5
工作介质		压缩空气，空气质量等级 1.7.2，符合 DIN ISO 8573-1 标准
压力露点降低	[K]	20
环境温度	[°C]	+2 ... +50
介质温度	[°C]	+2 ... +50
仓储温度	[°C]	-20 ... +60
耐腐蚀等级	CRC <sup>1)</sup>	2

1) CRC2: 耐腐蚀等级 2，符合 Festo 940 070 标准  
元件必须具备一定的耐腐蚀能力。外部可视元件具备基本的涂层表面，可直接与工业环境或与冷却液、润滑剂等介质接触。

# 膜片式空气干燥器 MS4/MS6-LDM1, MS 系列

FESTO

技术参数

重量 [g]					
规格	MS4		MS6		
	滤芯 P05	滤芯 P10	滤芯 P20	滤芯 P30	滤芯 P40
膜片式空气干燥器	420	530	1,050	1,200	1,300

## 材料

剖面图

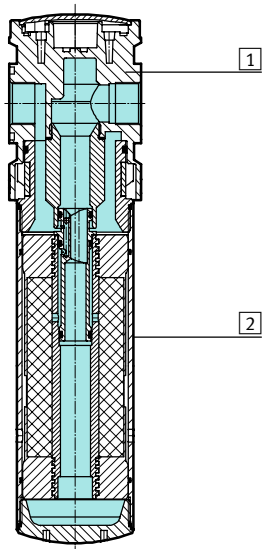

膜片式空气干燥器	
1	壳体 压铸铝
2	滤杯 精制铝合金
-	密封件 丁腈橡胶

# 膜片式空气干燥器 MS4/MS6-LDM1, MS 系列

技术参数

## 压力露点 $t_{pd}$ (输出)与输出处标准流量 $q_n$ 的关系

MS4-LDM1-...-P05

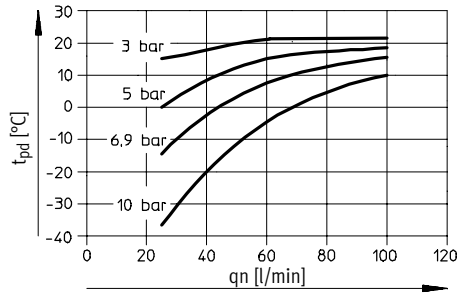

MS4-LDM1-...-P10

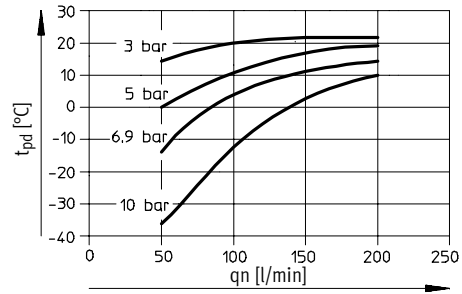

MS6-LDM1-...-P20

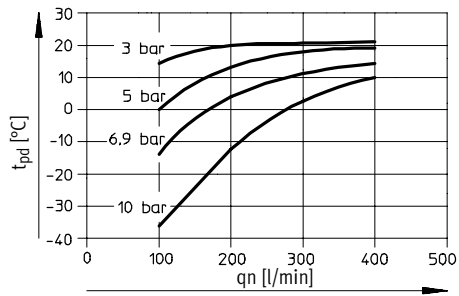

MS6-LDM1-...-P30

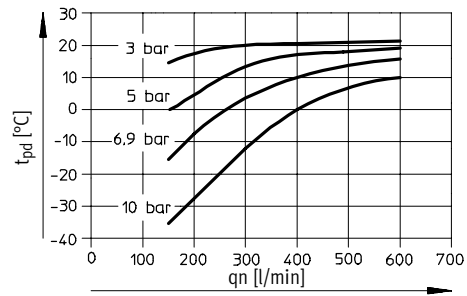

MS6-LDM1-...-P40

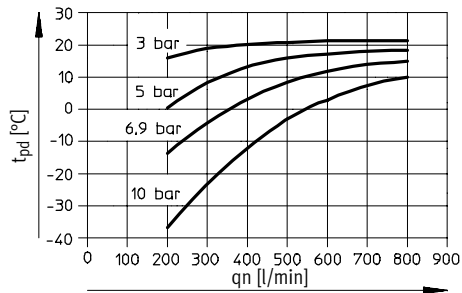

# 膜片式空气干燥器 MS4/MS6-LDM1, MS 系列

技术参数

## 压差 $\Delta p$ 与输出处标准流量 $q_n$ 的关系

MS4-LDM1-...-P05

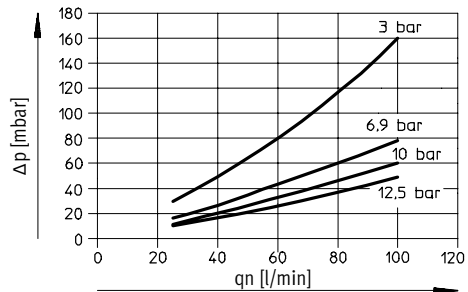

MS4-LDM1-...-P10

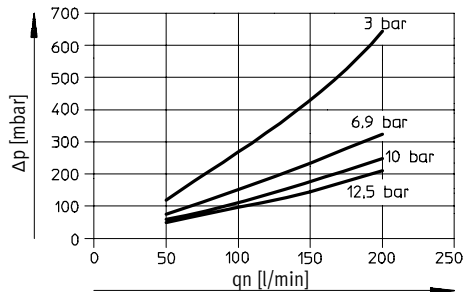

MS6-LDM1-...-P20

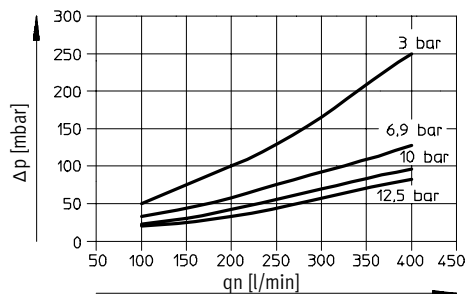

MS6-LDM1-...-P30

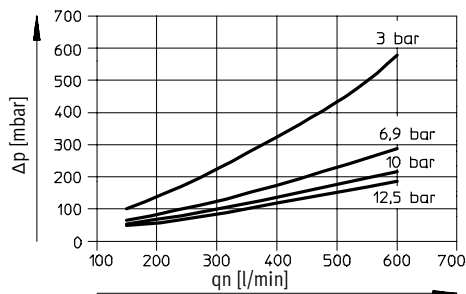

MS6-LDM1-...-P40

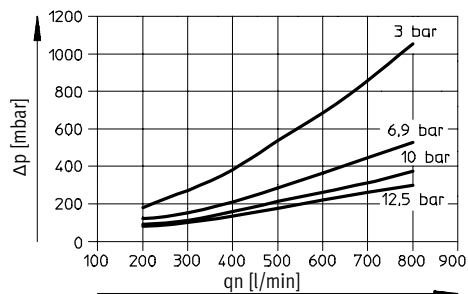

# 膜片式空气干燥器 MS4/MS6-LDM1, MS 系列

技术参数

FESTO

## 尺寸

CAD 相关数据 → [www.festo.com](http://www.festo.com)

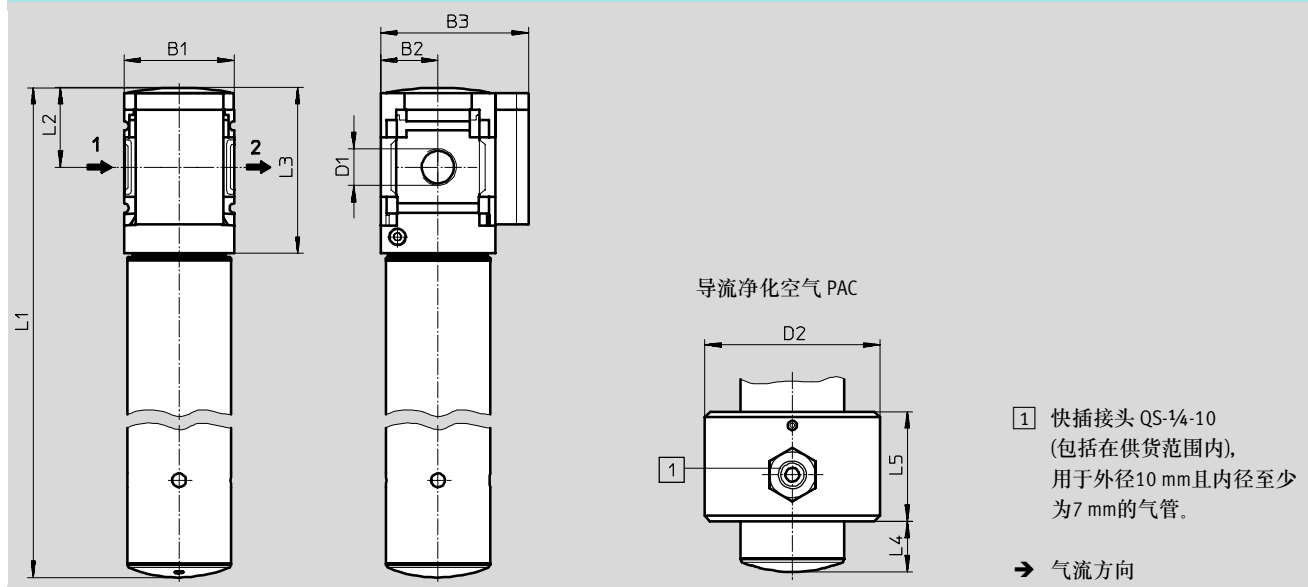

型号	B1	B2	B3	D1	D2	L1	L2	L3	L4	L5
MS4-LDM1-1/8-P05	40	21	54	G1/8	64	245	29	60	18	40
MS4-LDM1-1/8-P10						345				
MS4-LDM1-1/4-P05	40	21	54	G1/4	64	245	29	60	18	40
MS4-LDM1-1/4-P10						345				
MS6-LDM1-1/4-P20	62	31	76	G1/4	80	345	42	87	34	40
MS6-LDM1-1/4-P30						415				
MS6-LDM1-1/4-P40						475				
MS6-LDM1-3/8-P20	62	31	76	G3/8	80	345	42	87	34	40
MS6-LDM1-3/8-P30						415				
MS6-LDM1-3/8-P40						475				
MS6-LDM1-1/2-P20	62	31	76	G1/2	80	345	42	87	34	40
MS6-LDM1-1/2-P30						415				
MS6-LDM1-1/2-P40						475				

注意: 该产品符合ISO 1179-1和ISO 228-1标准。

订货号					
规格	气流滤芯	接口	订货号	型号	
MS4	P10	G1/8	543630	MS4-LDM1-1/8-P10	
		G1/4	543632	MS4-LDM1-1/4-P10	
MS6	P20	G1/4	543640	MS6-LDM1-1/4-P20	
		G3/8	543642	MS6-LDM1-3/8-P20	
		G1/2	543644	MS6-LDM1-1/2-P20	
	P40	G1/4	543646	MS6-LDM1-1/4-P40	
		G3/8	543648	MS6-LDM1-3/8-P40	
		G1/2	543650	MS6-LDM1-1/2-P40	

# 膜片式干燥器MS4/MS6-LDM1, MS 系列

订货数据 - 模块化产品



M 必填数据						O 可选项			
模块订货号	系列	规格	功能	接口规格	气流滤芯	净化空气	安装方式	可选气流方向	
543628 543638	MS	4 6	LDM1	1/8, 1/4, 3/8, 1/2 AGA, AGB, AGC, AGD, AGE	P05 P10 P20 P30 P40	PAC	WP WPM WB WBM	Z	
<b>订货示例</b> 543628	MS	4	- LDM1	- AGC	- P10	-	- WP	-	

订货表							
壳体宽度	[mm]	40	62	条件	代码	输入代码	
M 模块订货号		543628	543638				
系列		标准			MS		MS
规格		4	6		I		
功能		膜片式干燥器			-LDM1		-LDM1
接口规格	螺纹 G1/8		-		-1/8		
	螺纹 G1/4		螺纹 G1/4		-1/4		
	-		螺纹 G3/8		-3/8		
	-		螺纹 G1/2		-1/2		
	连接板 G1/8		-		-AGA		
	连接板 G1/4		连接板 G1/4		-AGB		
	连接板 G3/8		连接板 G3/8		-AGC		
	-		连接板 G1/2		-AGD		
	-		连接板 G3/4		-AGE		
气流滤芯	50 l/min		-		-P05		
	100 l/min		-		-P10		
	-		200 l/min		-P20		
	-		300 l/min		-P30		
	-		400 l/min		-P40		
O 净化空气		导流净化空气			-PAC		
安装方式	墙面安装板				1	-WP	
	墙面安装板				1	-WPM	
	墙面安装直接					-WB	
	墙面安装直接		-			-WBM	
可选气流方向		气流方向从右向左			-Z		

1 WP, WPM 仅适用于连接板 AGA, AGB, AGC, AGD 或 AGE.

## 输出订货代码

	MS		- LDM1	-		-		-		-	
--	----	--	--------	---	--	---	--	---	--	---	--