

Valve terminals CPA-SC, Smart Cubic

FESTO



Valve terminals CPA-SC, Smart Cubic

Key features

FESTO

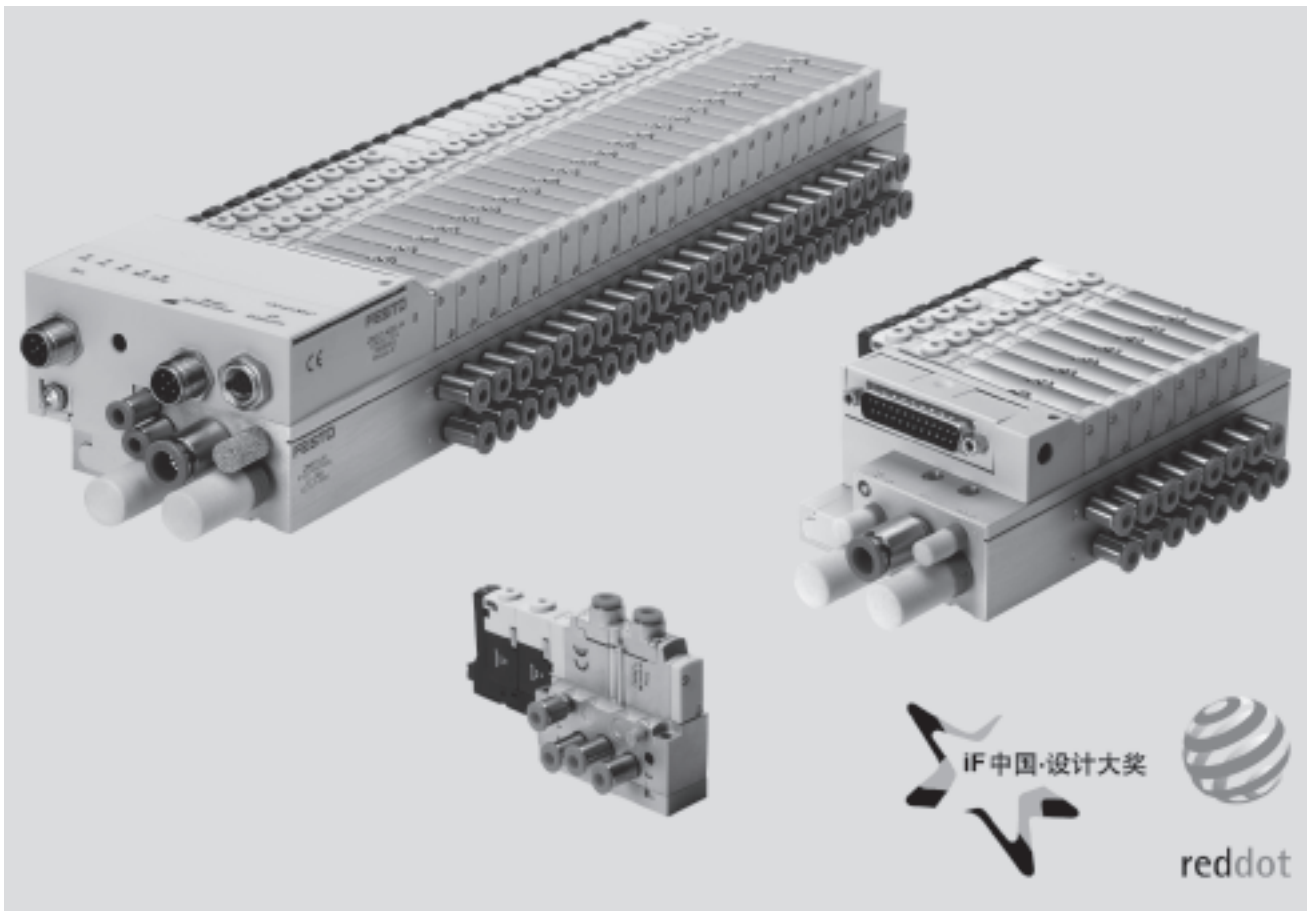

Innovative

- Compact valve terminal for a wide range of pneumatic applications
- Standardised from the individual valve up to multi-pin plug and fieldbus connections
- Highly versatile during the planning and assembly stages as well as in operational use
- Wide range of selectable valve functions, including valve functions for customised pressure supplies or vacuum application solutions
- Comprehensive, optimally harmonised range of accessories for flow rates of up to 180 l/min

Versatile

- Room for expansion with 2 ... 24 valve positions on one terminal
- Use of individual valves in combination with an individual block
- The flexibility of the pneumatic working connections facilitates a practical solution to different requirements
- Tubing lines can be connected horizontally to the valve or vertically on the sub-base
- High pressure range -0.9 ... 10 bar
- Wide range of electrical connections for 24 V DC operating voltage

Reliable

- Manual override facility
- Durable thanks to the use of tried-and-tested piston spool valves
- Sturdy thanks to metal housing and connecting thread
- Fast troubleshooting thanks to LEDs on the valves and diagnosis via fieldbus

Easy-to-mount

- Ready-to-install unit, already assembled and tested
- Minimised expenditure with regard to ordering, installation and commissioning
- Secure wall mounting or via H-rail

Valve terminals CPA-SC, Smart Cubic

Key features

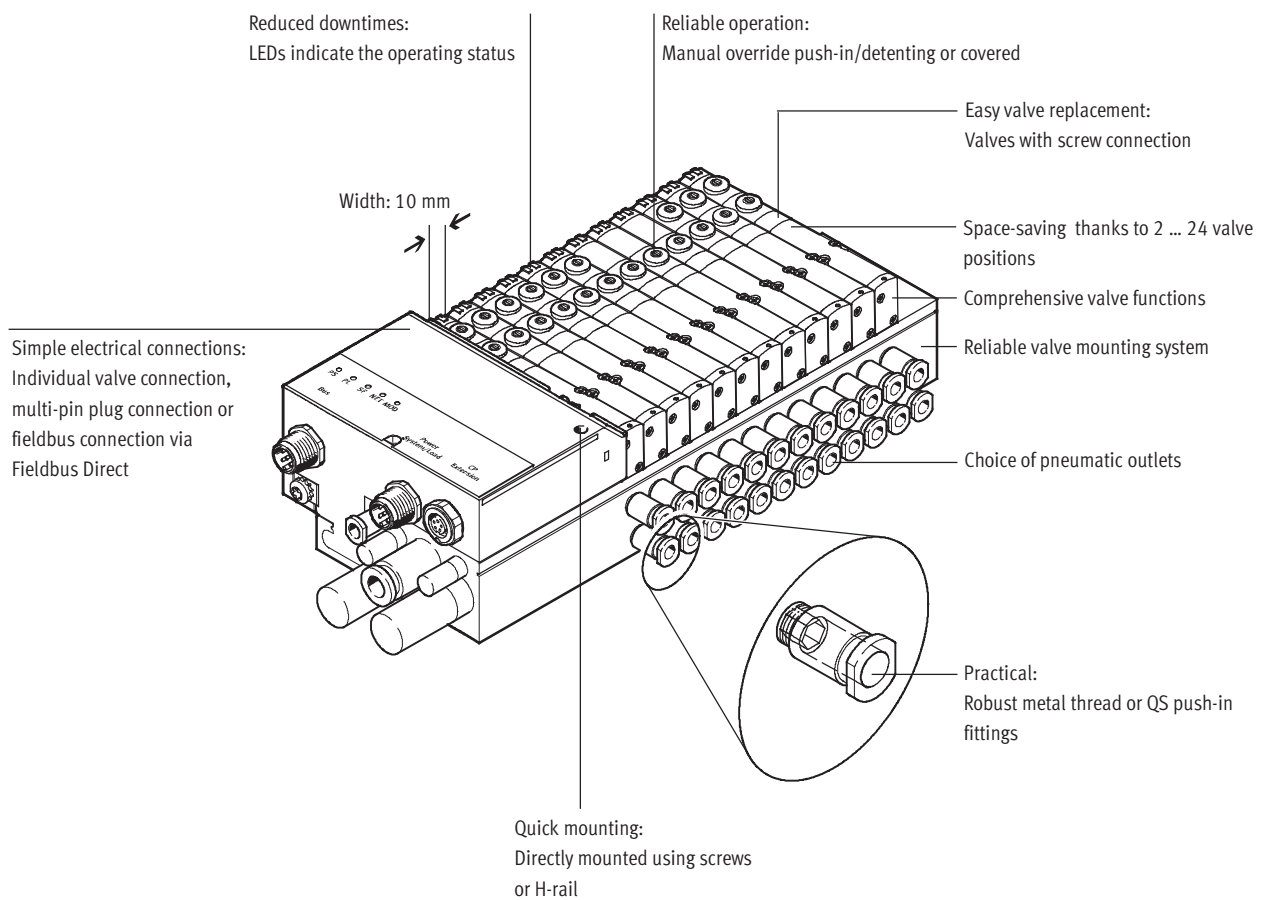

Equipment options

Valve functions			
<ul style="list-style-type: none"> • 5/2-way valve, single solenoid • 5/2-way valve, double solenoid • 2x 3/2-way valve, normally open • 2x 3/2-way valve, normally closed 	<ul style="list-style-type: none"> • 5/3-way valve, mid-position pressurised • 5/3-way valve, mid-position closed • 5/3-way valve, mid-position exhausted 	<ul style="list-style-type: none"> • 1x 3/2-way valve, normally closed, external compressed air supply • 2x 2/2-way valve, normally closed, dual compressed air supply 	<p>All valves have the same compact dimensions with an overall length of 91 mm and a width of 10 mm. Valves with a height of 40 mm are available for applications requiring particularly flat variants.</p>

Electrical connection options

Individual connection/individual sub-base valve	Multi-pin	Fieldbus	CP string extension
<ul style="list-style-type: none"> • Plug-in (PI) • Horizontal connection (HC) 	<ul style="list-style-type: none"> • Max. 20 valve positions/ max. 20 solenoid coils • Sub-D • Flat cable 	<ul style="list-style-type: none"> • Max. 24 valve positions/ max. 32 solenoid coils 	<ul style="list-style-type: none"> • Further valve terminals from the CPV/CPA range • Electrical I/O modules

Valve terminals CPA-SC, Smart Cubic

Key features



Valve terminal configurator

Online via: → www.festo.com/us/engineering

A valve terminal configurator is available to help you select a suitable CPA-SC valve terminal. This makes it much easier for you to find the right product.

The valve terminals are fully assembled according to your order specifications and individually tested. This reduces the amount of assembly and installation required to a minimum.

A CPA-SC valve terminal is ordered via a modular order code.

Ordering system for CPA-SC

→ Internet: cpa-sc

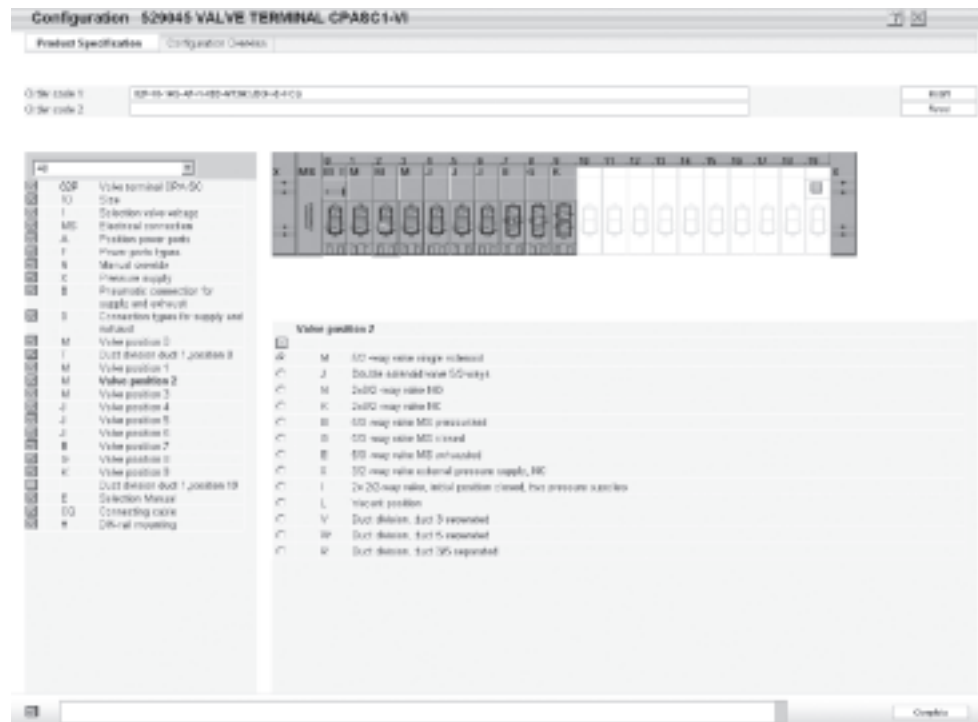

Valve terminals CPA-SC, Smart Cubic

Key features

Individual connection

Valve on individual sub-base

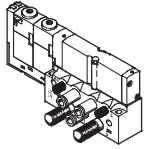

Valves can also be used on an individual block for actuators further away from the valve terminal.

With an individual electrical connection, the plug is connected directly to the valve. Two electrical connection types are available for the valve terminal and for the individual block:

- Horizontal connection (HC)

Version SH:

The electrical connection can be plugged in directly on the valve.

- Plug-in (PI)
Version SP, SQ:
The connector plug is mounted on an adapter. This adapter is then attached to the manifold block.

Valves pneumatically linked on manifold sub-base

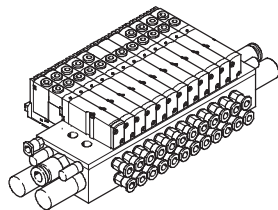

Connection is independent of the control technology used. This ensures correct polarity during installation.

The valve is equipped with an LED which indicates switching status, and an overvoltage protective circuit. It also features a built-in current reduction circuit.

Individual connection permits the selection of 2 to 32 solenoid coils (divided between 2 to 16 valve positions, including in uneven gradations).

Multi-pin plug connection

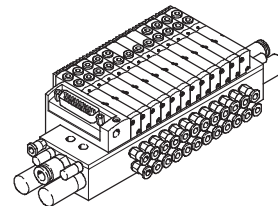

Control signals from the controller to the valve terminal are transmitted via a pre-assembled multi-core cable, which substantially reduces installation time.

These valve terminals can be fitted with 2 to 20 solenoid coils (divided between 2 to 20 valve positions).

- Variants
- Sub-D connection
 - Flat cable connection

Fieldbus Direct

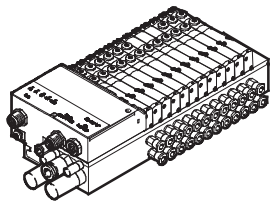

An integrated fieldbus node manages the communication connection to a higher-order PLC. This enables a space-saving pneumatic and electronic solution. The fieldbus node is directly integrated in the electrical interface of the valve terminal and therefore takes up only a minimal amount of space.

The CP string extension option allows the functions and components of the CP installation system to be used. Valve terminals with fieldbus interfaces can be equipped with 4 to 24 valve positions and 4 to 32 solenoid coils.

- Variants
- DeviceNet connection
 - Profibus connection
 - 4 to 32 solenoid coils

CP string extension

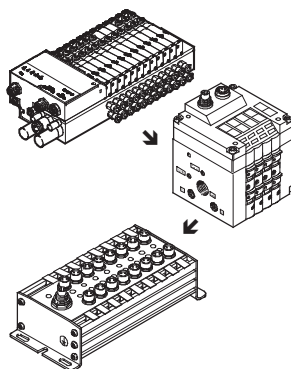

The optional string extension allows additional valve terminals and I/O modules to be connected to the fieldbus node of the CPA-SC. A CP string of the CPI installation system is integrated in the fieldbus node as an extension. Different input and output modules as well as CPV- and CPA valve terminals can be connected.

The maximum length of the CP string extension is 10 metres, which means that the extension modules can be mounted directly on site. All of the required electrical signals are transmitted via the CP cable, which in turn means that no further installation is needed on the extension module. The CP string interface offers:

- 32 input signals
- 32 output signals for output modules 24 V DC or solenoid coils
- Logic and sensor supply for the input modules
- Load voltage supply for the valve terminals
- Logic supply for the output modules

Valve terminals CPA-SC, Smart Cubic

Peripherals overview

FESTO

Overview – CPA-SC valve terminal with sub-base valves

Valve terminal with individual plug-in (PI) electrical connections

Code: IP, IQ

Valve terminals with individual plug-in (PI) electrical connections are available in sizes for 2 to max. 16 valve positions. Each valve position

can either be equipped with a valve or a blanking plate.

With an individual PI connection, the connector plug remains on the

manifold block. This avoids the valve being connected incorrectly in the event of a recommissioning.

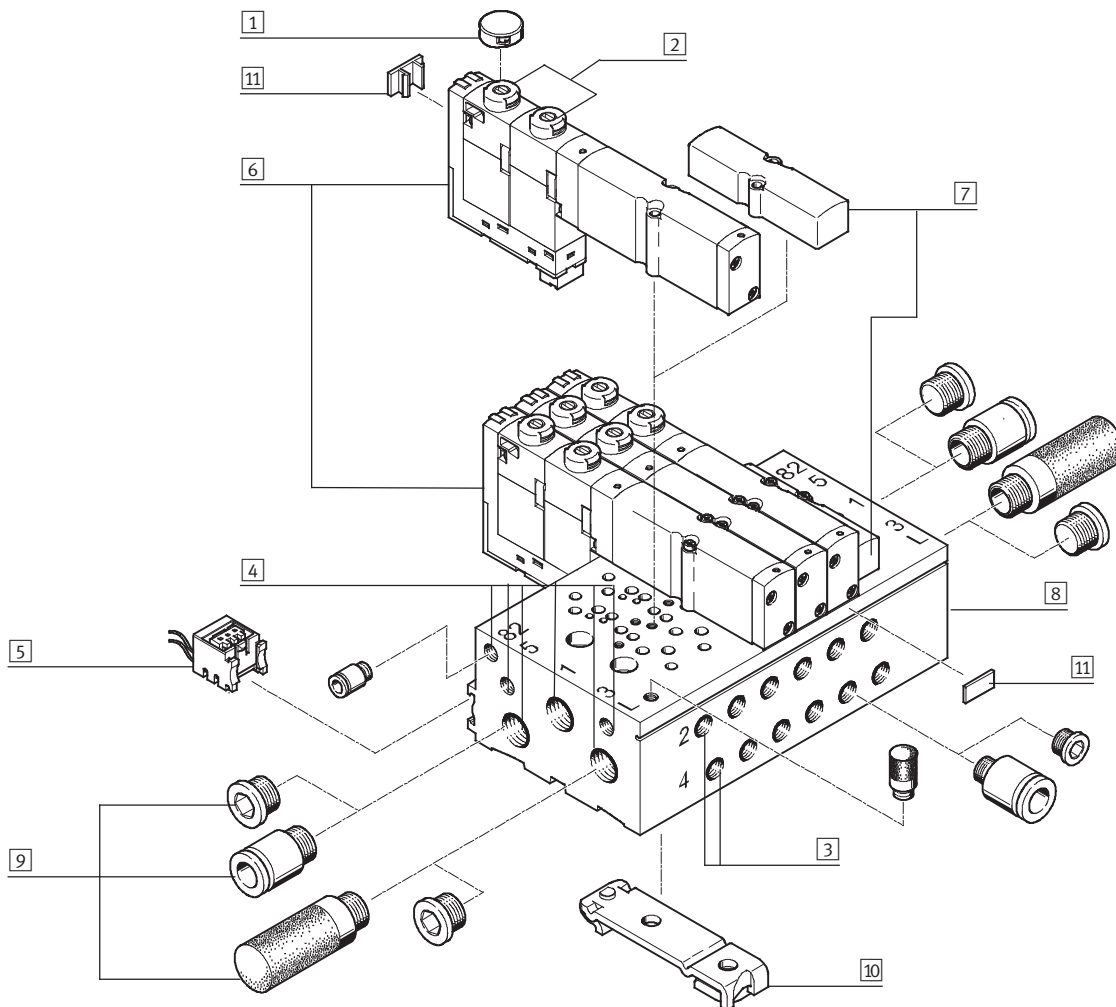

- | | | | |
|---|---|--|--|
| <p>1 Cover for manual override (optional)</p> <p>2 Manual override (per solenoid coil, push-in/rotary-detenting)</p> <p>3 Working lines (2, 4) on the manifold block (per valve position)</p> | <p>4 Supply ports (1, 12/14), exhaust ports (3, 5, 82/84) and pressure compensating port (L) on the left-hand and right-hand side of the manifold block</p> | <p>5 Individual plug-in (PI) connection</p> <p>6 Valve</p> <p>7 Cover for vacant position (blanking plate)</p> <p>8 Manifold block for sub-base valves</p> | <p>9 Connectors, silencers and blanking plugs</p> <p>10 H-rail mounting</p> <p>11 Inscription labels</p> |
|---|---|--|--|

Valve terminals CPA-SC, Smart Cubic

Peripherals overview

FESTO

Overview – CPA-SC valve terminal with sub-base valves

Valve terminal with individual horizontal (HC) electrical connections

Code: IH

Valve terminals with individual horizontal electrical connections (HC) are available in sizes for 2 to max. 16 valve positions. Each valve position can either be equipped with a valve or a blanking plate.

With an individual horizontal connection, the electrical connection for a valve must be removed when the valve is being replaced.

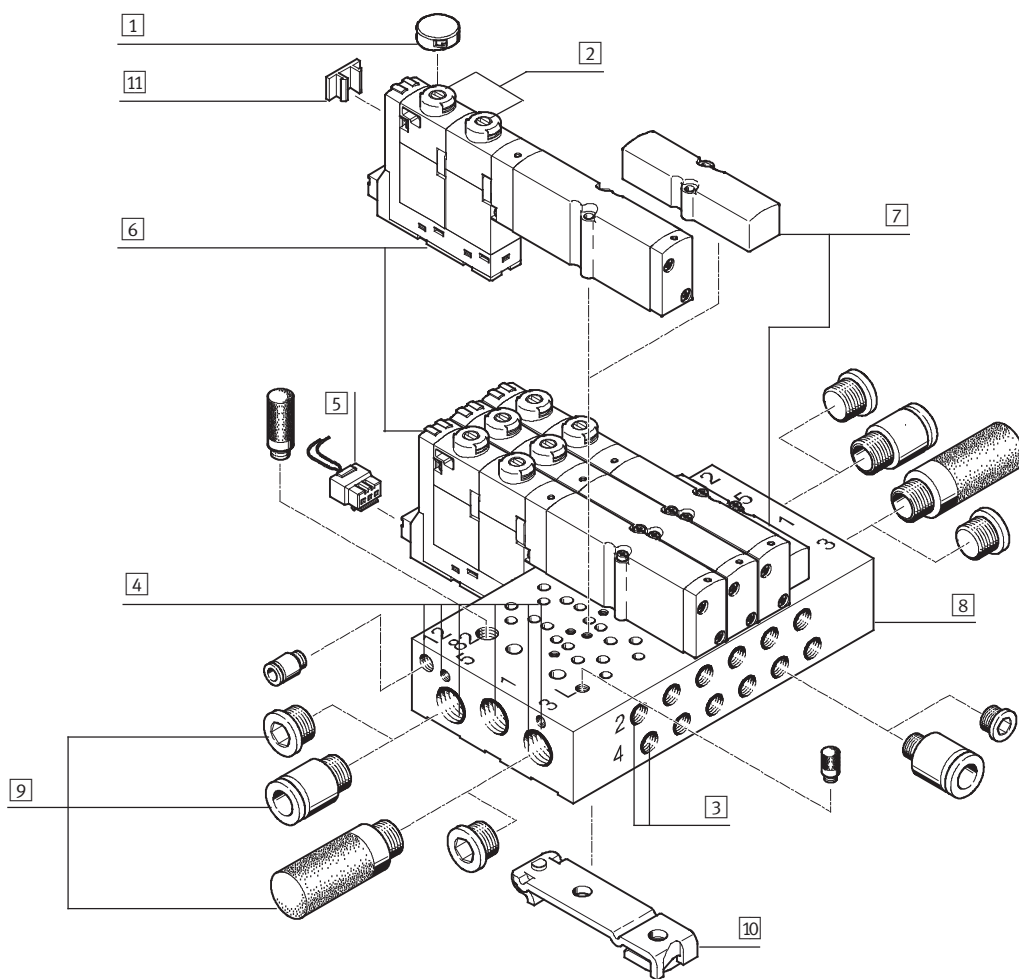

- | | | | |
|---|---|---|--|
| <p>1 Cover for manual override (optional)</p> <p>2 Manual override (per solenoid coil, push-in/rotary-detenting)</p> <p>3 Working lines (2, 4) on the manifold block (per valve position)</p> | <p>4 Supply ports (1, 12/14), exhaust ports (3, 5, 82/84) and pressure compensating port (L) on the left-hand and right-hand side of the manifold block</p> | <p>5 Individual horizontal connection (HC)</p> <p>6 Valve</p> <p>7 Cover for vacant position (blanking plate)</p> | <p>8 Manifold block for sub-base valves</p> <p>9 Connectors, silencers and blanking plugs</p> <p>10 H-rail mounting</p> <p>11 Inscription labels</p> |
|---|---|---|--|

Valve terminals CPA-SC, Smart Cubic

Peripherals overview

FESTO

Overview – CPA-SC individual block with sub-base valve or semi in-line valve

Individual block with individual plug-in (PI) electrical connection

Code: SP, SQ

With an individual PI connection, the connector plug remains on the manifold block.

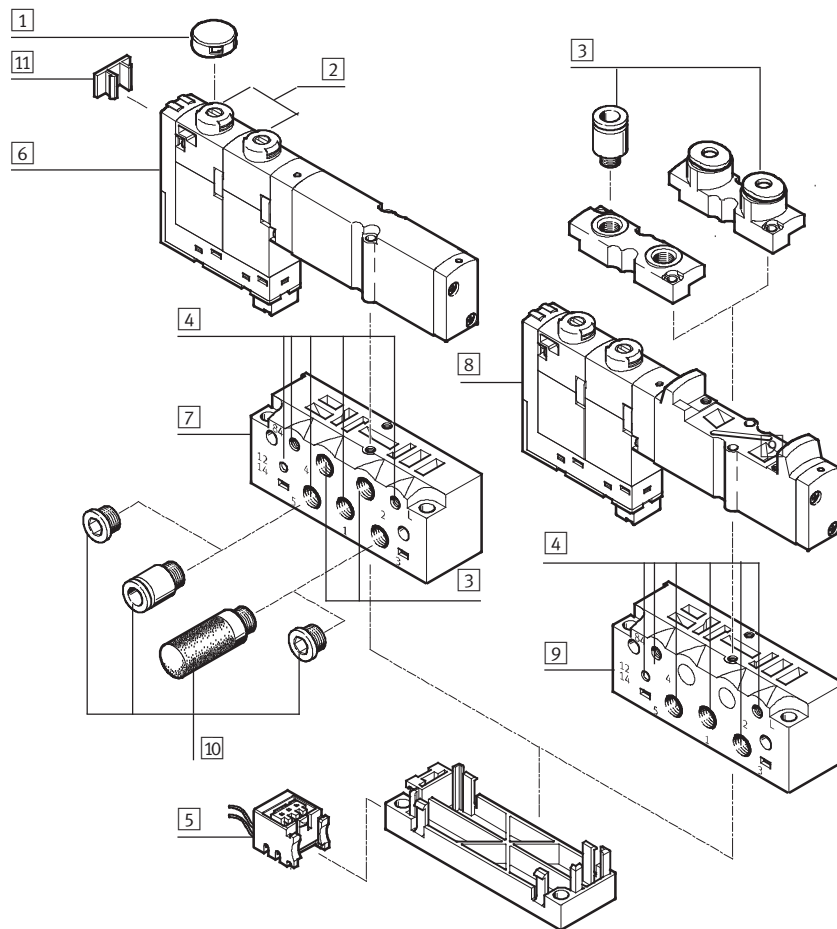

- | | | | |
|---|---|---|--|
| <p>1 Cover for manual override (optional)</p> <p>2 Manual override (per solenoid coil, push-in/rotary-detenting)</p> <p>3 Working lines (2, 4) on the individual block or on the valve (semi in-line version)</p> | <p>4 Supply ports (1, 12/14), exhaust ports (3, 5, 82/84) and pressure compensating port (L) on the individual block</p> <p>5 Individual horizontal connection (HC)</p> | <p>6 Sub-base valve</p> <p>7 Individual block for sub-base valve</p> <p>8 Semi in-line valve</p> <p>9 Individual block for semi in-line valve</p> | <p>10 Connectors, silencers and blanking plugs</p> <p>11 Inscription label</p> |
|---|---|---|--|

Valve terminals CPA-SC, Smart Cubic

Peripherals overview

FESTO

Overview – CPA-SC individual block with sub-base valve or semi in-line valve

Individual block with individual horizontal electrical connection (HC)

Code: SH

With an individual horizontal connection, the electrical connection for a valve must be removed when the valve is being replaced.

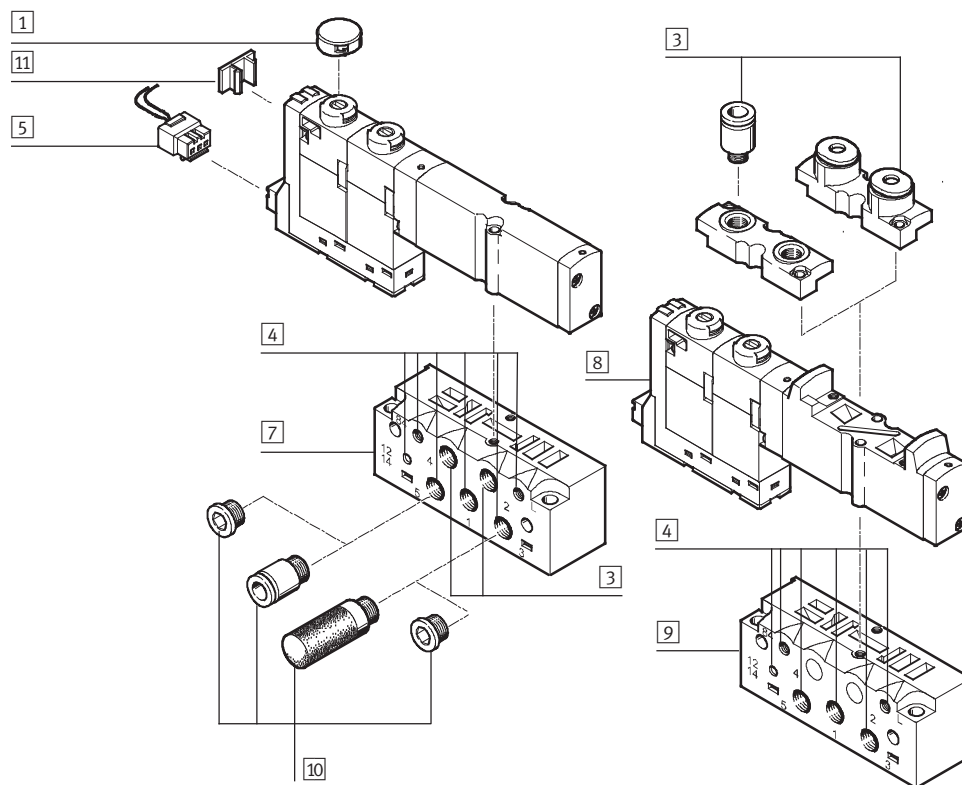

- | | | | |
|---|---|---|--|
| <p>1 Cover for manual override (optional)</p> <p>2 Manual override (per solenoid coil, push-in/rotary-detenting)</p> <p>3 Working lines (2, 4) on the individual block or on the valve (semi in-line version)</p> | <p>4 Supply ports (1, 12/14), exhaust ports (3, 5, 82/84) and pressure compensating port (L) on the individual block</p> <p>5 Individual horizontal connection (HC)</p> | <p>6 Sub-base valve</p> <p>7 Individual block for sub-base valve</p> <p>8 Semi in-line valve</p> <p>9 Individual block for semi in-line valve</p> | <p>10 Connectors, silencers and blanking plugs</p> <p>11 Inscription label</p> |
|---|---|---|--|

Valve terminals CPA-SC, Smart Cubic

Peripherals overview

Overview – CPA-SC valve terminal with electrical multi-pin plug connection

Valve terminal with sub-base valves

- 25-pin Sub-D multi-pin plug connection
Code: MS
- or
- 26-pin multi-pin plug connection with connector for flat cable
Code: MF

Valve terminals with electrical multi-pin plug connection are available in sizes for 2 to max. 20 valve positions (code: MS) or for 4 to max. 20 valve positions (code: MF). Each valve position can either be equipped with a valve or a blanking plate.

A maximum of 20 solenoid coils can be actuated via the electrical multi-pin plug connection.

The electrical connection is located on the left-hand side. It can be rotated by 90°, thereby allowing flush mounting of the system.

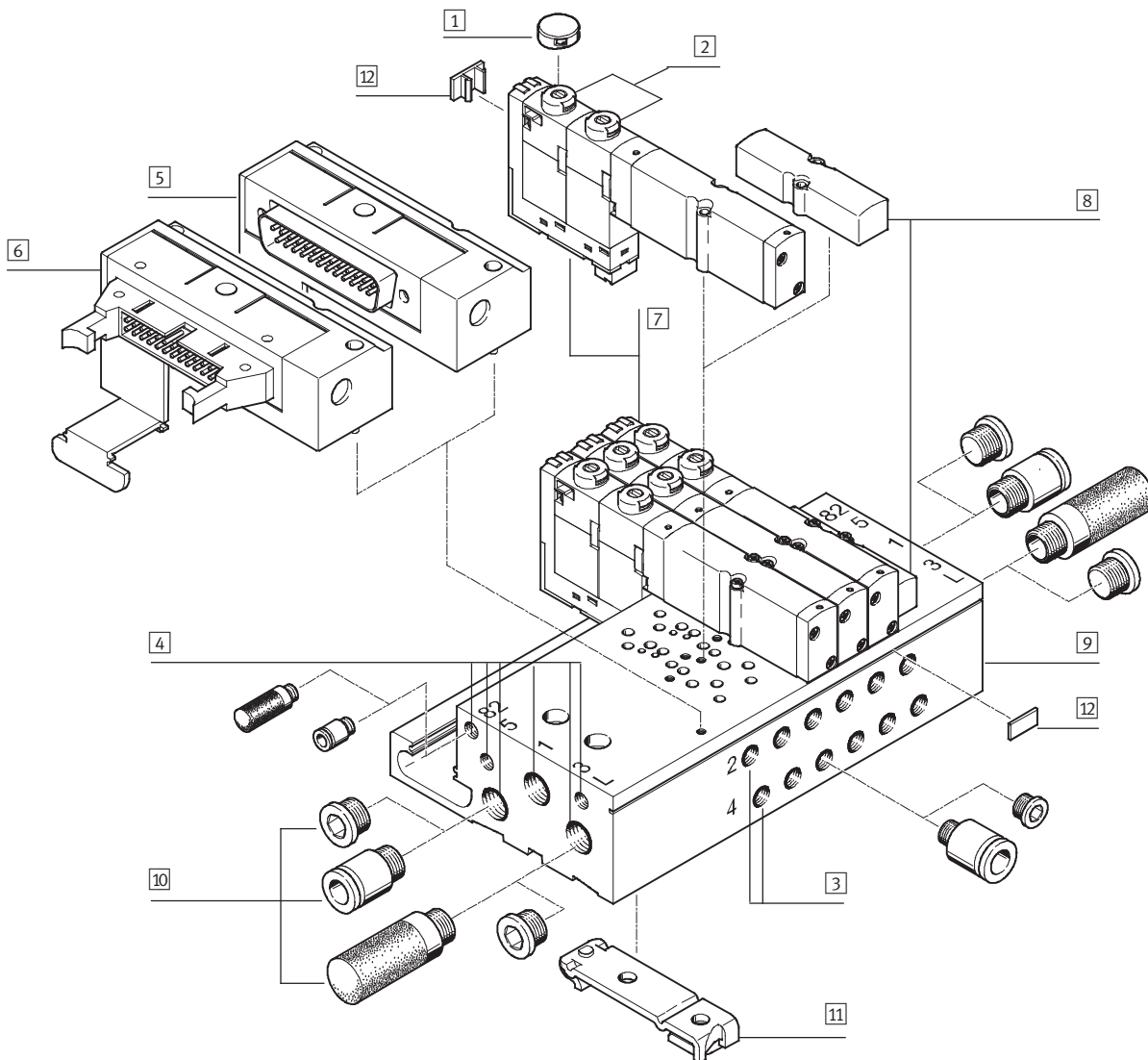

- | | | | |
|--|---|--|--|
| <ul style="list-style-type: none"> 1 Cover for manual override (optional) 2 Manual override (per solenoid coil, push-in/rotary-detenting) 3 Working lines (2, 4) on the manifold block (per valve position) | <ul style="list-style-type: none"> 4 Supply ports (1, 12/14), exhaust ports (3, 5, 82/84) and pressure compensating port (L) on the left-hand and right-hand side of the manifold block 5 Multi-pin plug connection Sub-D | <ul style="list-style-type: none"> 6 Multi-pin plug connection with connector for flat cable 7 Valve 8 Cover for vacant position (blanking plate) | <ul style="list-style-type: none"> 9 Manifold block for sub-base valves 10 Connectors, silencers and blanking plugs 11 H-rail mounting 12 Inscription labels |
|--|---|--|--|

Valve terminals CPA-SC, Smart Cubic

Peripherals overview

FESTO

Overview – CPA-SC valve terminal with electrical multi-pin plug connection

Valve terminal with semi in-line valves

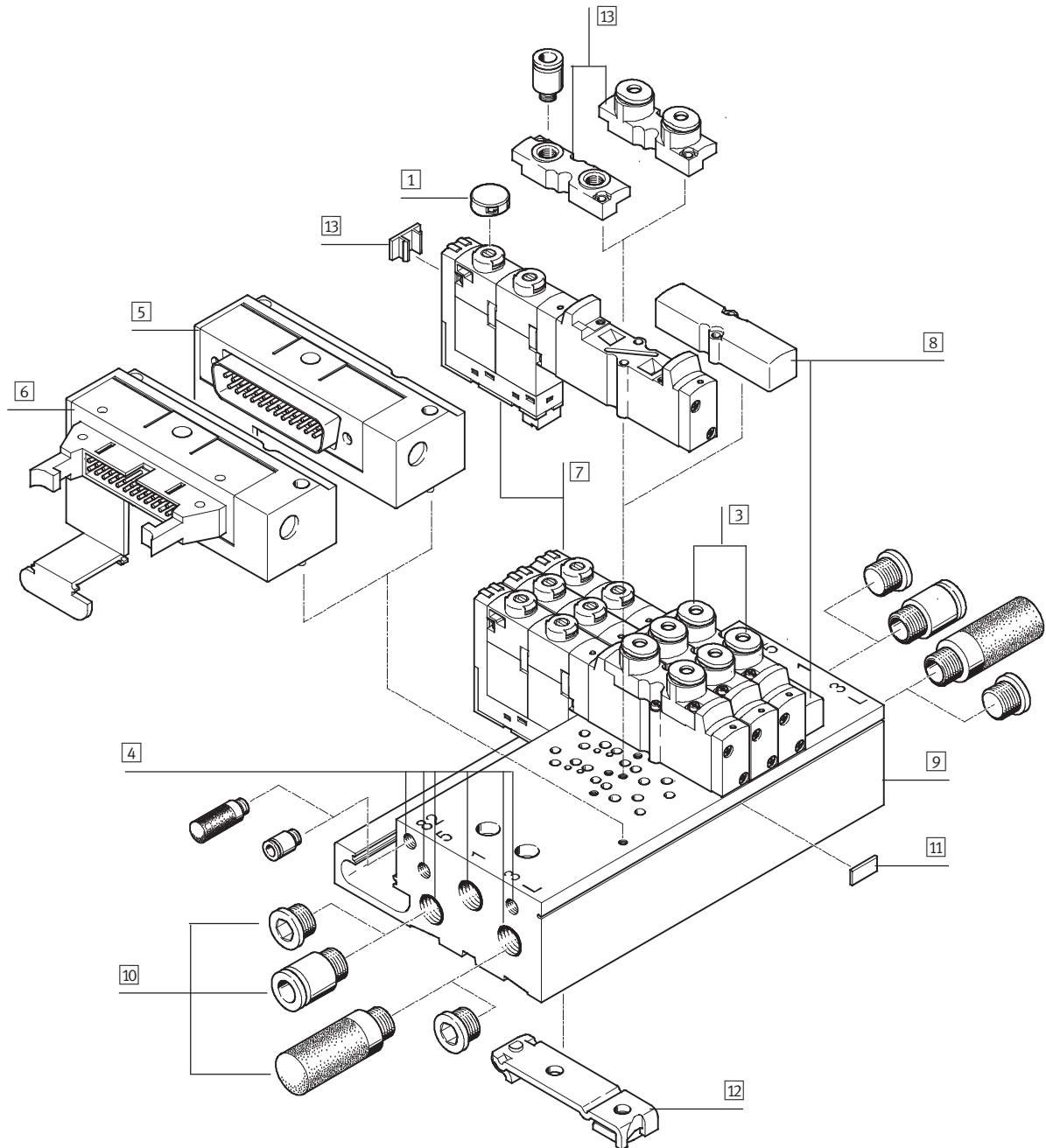

- | | | | |
|--|---|--|--|
| <ul style="list-style-type: none"> 1 Cover for manual override (optional) 2 Manual override (per solenoid coil, push-in/rotary-detenting) 3 Working lines (2, 4) on the valve | <ul style="list-style-type: none"> 4 Supply ports (1, 12/14), exhaust ports (3, 5, 82/84) and pressure compensating port (L) on the left-hand and right-hand side of the manifold block 5 Multi-pin plug connection Sub-D | <ul style="list-style-type: none"> 6 Multi-pin plug connection with connector for flat cable 7 Valve 8 Cover for vacant position (blanking plate) 9 Manifold block for semi in-line valves | <ul style="list-style-type: none"> 10 Connectors, silencers and blanking plugs 11 Inscription labels 12 H-rail mounting 13 Pneumatic connection plates for semi in-line valves |
|--|---|--|--|

Valve terminals CPA-SC, Smart Cubic

Peripherals overview

FESTO

Overview – CPA-SC valve terminal with Fieldbus Direct

Valve terminal with sub-base valves

Valve terminals with fieldbus connection are available in sizes for 4 to max. 24 valve positions.

Each valve position can either be equipped with a valve or a blanking plate.

A maximum of 32 solenoid coils can be actuated via the fieldbus connection.

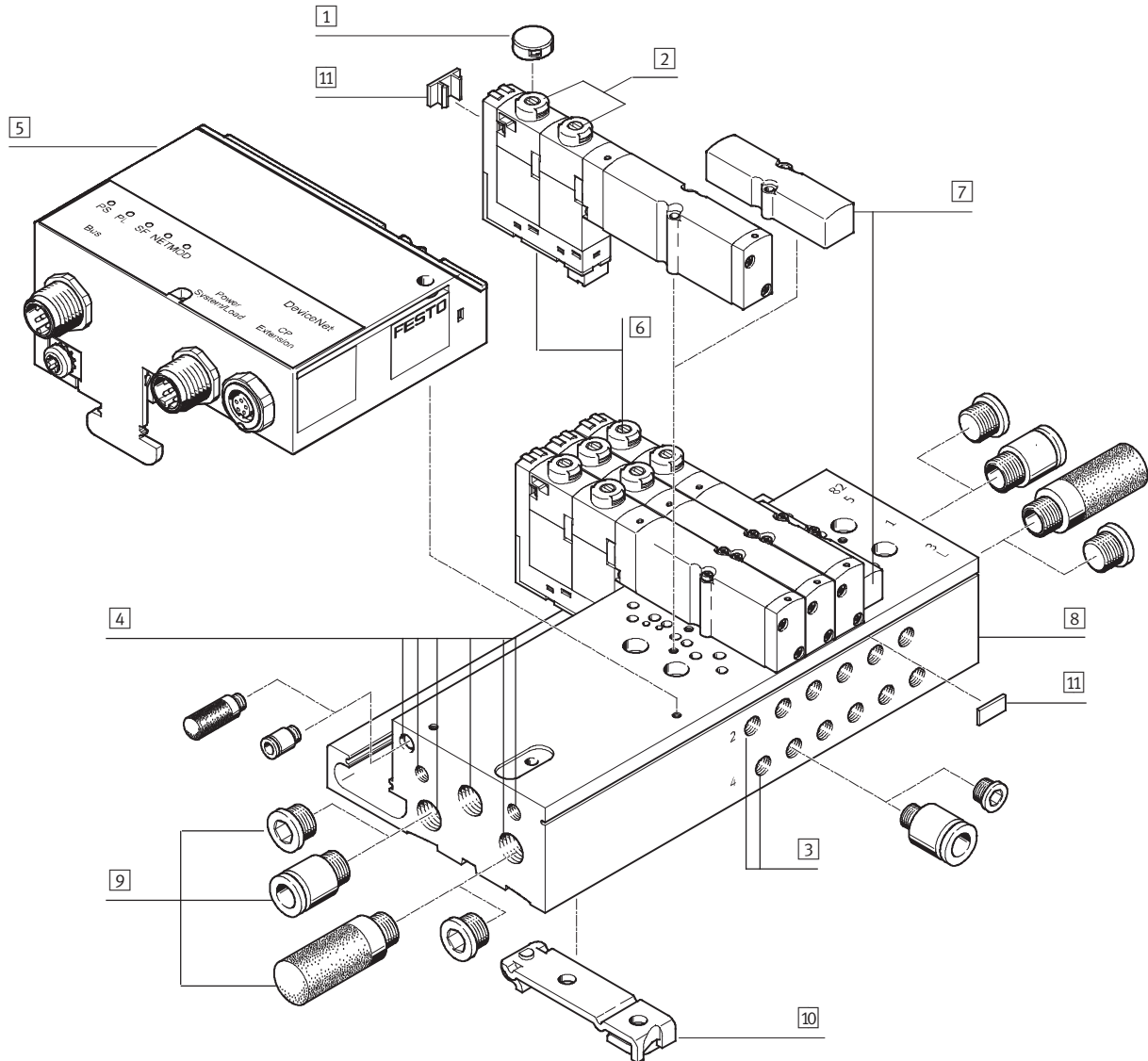

- | | | | |
|---|--|--|--|
| <p>1 Cover for manual override (optional)</p> <p>2 Manual override (per solenoid coil, push-in/rotary-detenting)</p> <p>3 Working lines (2, 4) on the manifold block (per valve position)</p> | <p>4 Supply ports (1, 12/14), exhaust ports (3, 5, 82/84) and pressure compensating port (L) on the left-hand and right-hand side of the manifold block</p> <p>5 Fieldbus Direct</p> | <p>6 Valve</p> <p>7 Cover for vacant position (blanking plate)</p> <p>8 Manifold block for sub-base valves</p> | <p>9 Connectors, silencers and blanking plugs</p> <p>10 H-rail mounting</p> <p>11 Inscription labels</p> |
|---|--|--|--|

Valve terminals CPA-SC, Smart Cubic

Peripherals overview

FESTO

Overview – CPA-SC valve terminal with Fieldbus Direct

Valve terminal with semi in-line valves

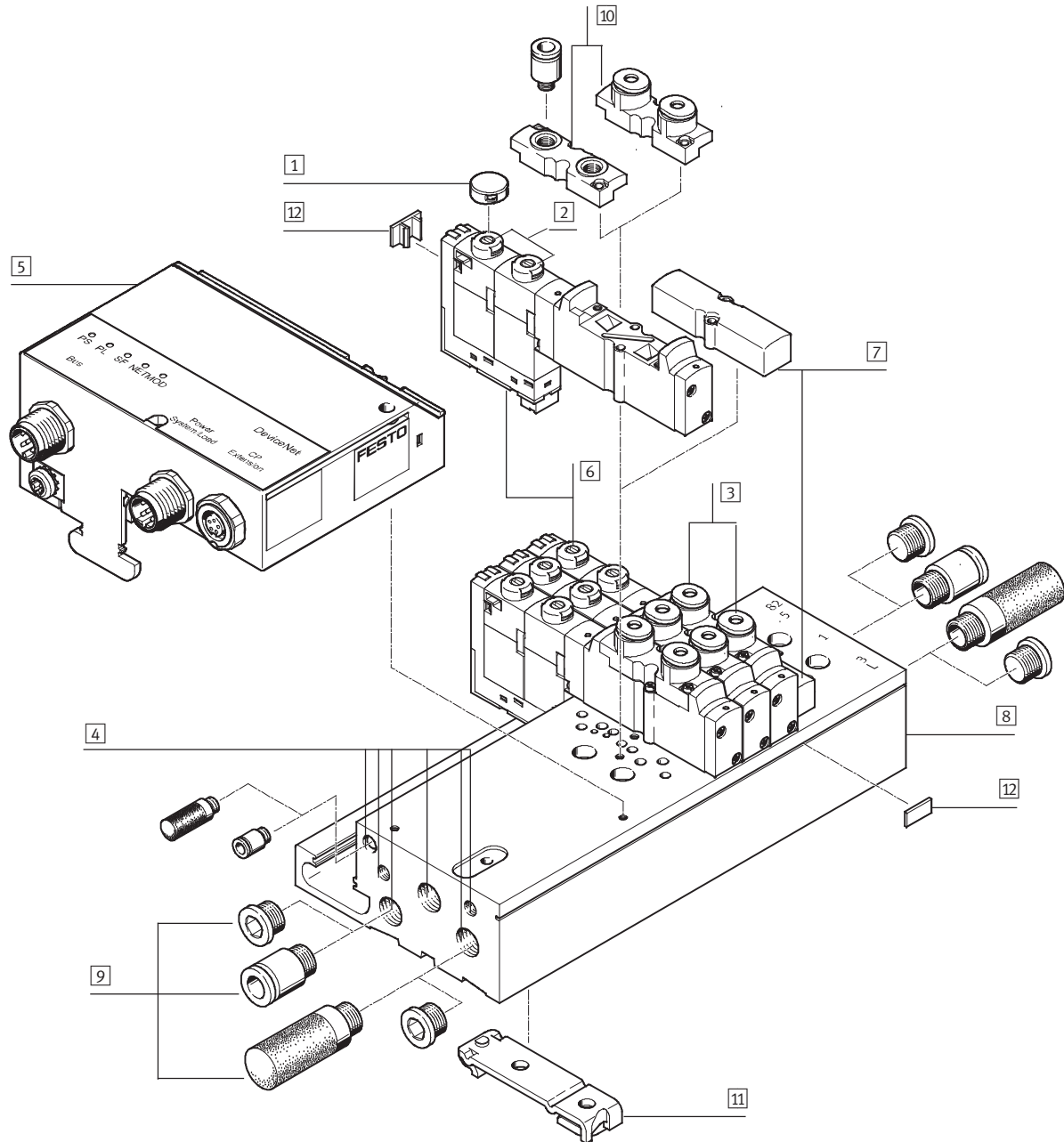

- | | | | | | | | | | | | |
|---|--|--|--|---|---|---|---|---|----|----|----|
| 1 | 2 | 3 | 4 | 5 | 6 | 7 | 8 | 9 | 10 | 11 | 12 |
| 1 | 2 | 3 | 4 | 5 | 6 | 7 | 8 | 9 | 10 | 11 | 12 |
| <p>1 Cover for manual override (optional)</p> <p>2 Manual override (per solenoid coil, push-in/rotary-detenting)</p> <p>3 Working lines (2, 4) on the valve</p> | <p>4 Supply ports (1, 12/14), exhaust ports (3, 5, 82/84) and pressure compensating port (L) on the left-hand and right-hand side of the manifold block</p> <p>5 Fieldbus Direct</p> | <p>6 Valve</p> <p>7 Cover for vacant position (blanking plate)</p> <p>8 Manifold block for semi in-line valves</p> | <p>9 Connectors, silencers and blanking plugs</p> <p>10 Pneumatic connection plates for semi in-line valves</p> <p>11 H-rail mounting</p> <p>12 Inscription labels</p> | | | | | | | | |

Valve terminals CPA-SC, Smart Cubic

Key features – Pneumatic components

Valves

Sub-base valve

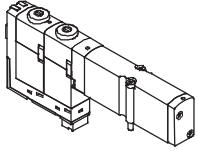

Sub-base valves can be quickly replaced since the tubing connections remain on the manifold block.

This design is also particularly slim.

Semi in-line valve (with working ports on the valve)

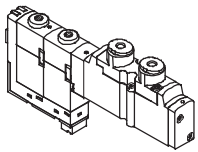

With semi in-line valves the pneumatic connections are on the top. This means that elbow connectors are not needed.

There are sub-base valves and semi in-line valves with one solenoid coil (single solenoid) or with two solenoid coils (double solenoid) irrespective of the valve function.

Blanking plate

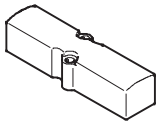
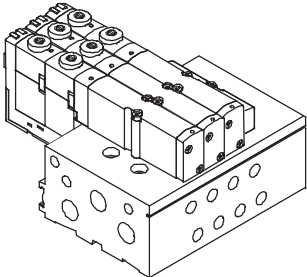
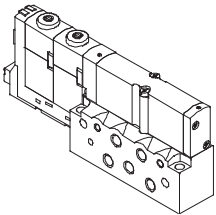
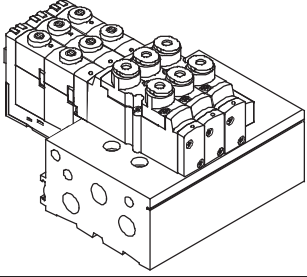
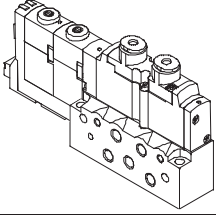

Plate without valve function for reserving valve positions on a valve terminal.

Valve sub-bases and blanking plates are attached to the manifold block using two screws.

Valve terminals CPA-SC, Smart Cubic

Key features – Pneumatic components

Manifold blocks			
Manifold block		Number of valve positions	Manifold block connections
Code A – Working ports (2, 4) on the manifold block			
Manifold block for sub-base valves and blanking plates		2 ... 20	<ul style="list-style-type: none"> • With working ports (2, 4), M5 threaded hole • With ports for supply air (1, 12/14) and exhaust air (3, 5, 82/84) • With pressure compensating port (L)
Individual sub-base for sub-base valve		1	
Code P – Working ports (2, 4) on the valve			
Manifold block for semi in-line valves and blanking plates		2 ... 20	<ul style="list-style-type: none"> • Without working ports • With ports for supply air (1, 12/14) and exhaust air (3, 5, 82/84) • With pressure compensating port (L)
Individual sub-base for semi in-line valve		1	

Note

Semi in-line valves can also be mounted on manifold blocks for sub-base valves. In this case the corresponding working ports on the manifold block must be sealed using blanking plugs.

The working air supply and exhaust air outlet for the valve terminal can either be on the left-hand side or the right-hand side of the valve terminal. Supply at both sides is also possible. Ports that are not required must be sealed with a blanking plug.

An individual sub-base is the ideal solution in cramped space conditions. All available valve types can be used.

Valve terminals CPA-SC, Smart Cubic

Key features – Pneumatic components

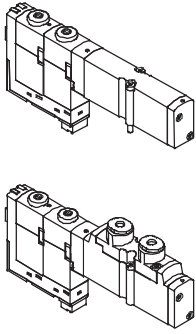
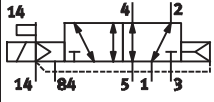
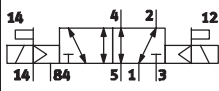
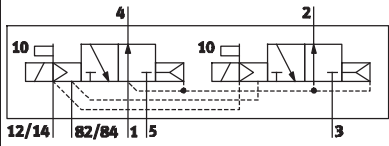
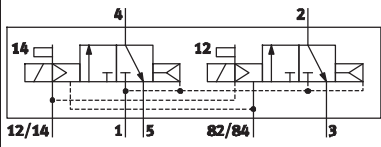
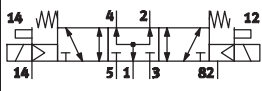
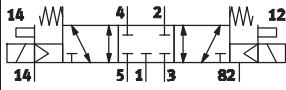
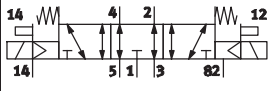
Valves		Code	Circuit symbol	Description
	M			5/2-way valve, single solenoid <ul style="list-style-type: none"> • Pneumatic spring return
	J			5/2-way valve, double solenoid
	N			2x 3/2-way valve, single solenoid <ul style="list-style-type: none"> • Normally open • Pneumatic spring return
	K			2x 3/2-way valve, single solenoid <ul style="list-style-type: none"> • Normally closed • Pneumatic spring return
	B			5/3-way valve <ul style="list-style-type: none"> • Mid-position pressurised¹⁾ • Mechanical spring return The piston rod of a connected cylinder advances when the valve is in the normal position due to the differential piston areas.
	G			5/3-way valve <ul style="list-style-type: none"> • Mid-position closed¹⁾ • Mechanical spring return The piston rod side of a connected cylinder remains held under pressure when the valve is in the normal position.
	E			5/3-way valve <ul style="list-style-type: none"> • Mid-position exhausted¹⁾ • Mechanical spring return The piston rod of a connected cylinder remains freely movable when the valve is in the normal position.

1) If neither solenoid coil is being supplied with power, the valve assumes its mid-position by means of spring force.
 If both coils are being supplied with power simultaneously, the valve remains in the switching position previously assumed.

Valve terminals CPA-SC, Smart Cubic

Key features – Pneumatic components



Valves			
	Code	Circuit symbol	Description
	X		<p>1x 3/2-way valve</p> <ul style="list-style-type: none"> • Normally closed • External compressed air supply • Pneumatic spring return <p>Compressed air (–0.9 ... +10 bar) supplied at working port 4 can be switched.</p>
	I		<p>2x 2/2-way valve</p> <ul style="list-style-type: none"> • Normally closed • Normally closed, reversible • Pneumatic spring return <ul style="list-style-type: none"> – The vacuum is connected at port 5 – Port 14 switches the vacuum – Port 12 switches the ejector pulse – An external T-connection must be established between port 2, 4 and the vacuum generator
	L		<p>Blanking plate for vacant position</p> <p>For valve terminal only</p>

Note

For vacuum operation valves require a filter. This is to avoid that foreign matter is drawn into the valve (e.g. when using a suction cup).

Valve terminals CPA-SC, Smart Cubic

Key features – Pneumatic components

Constructional design

Valve replacement

The valves are attached to the metal manifold block using two screws. This means that they can be easily replaced. The mechanical robustness of the manifold block guarantees good long-term sealing tightness.

Expansion

Vacant positions can be replaced by valves at a later date. The dimensions, mounting points and existing pneumatic installations remain unchanged by this.

The valve code (M, J, N, K, B, G, E, X, I) is located on the front of the valve beneath the manual override.

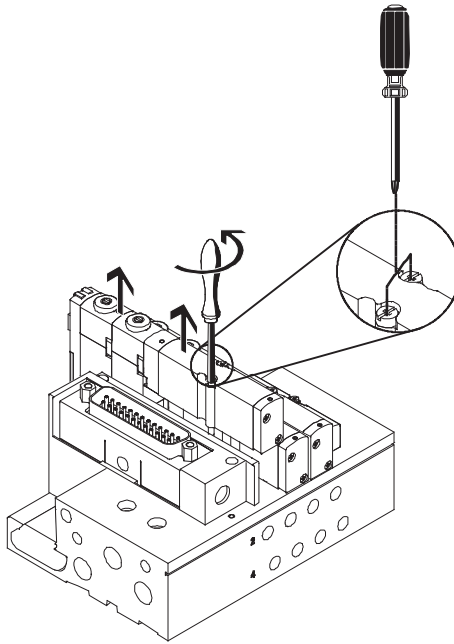

Note

Plug-in versions

If a vacant position is replaced by a valve, a plug-in socket must also be ordered and inserted into the slot.

When ordering a HC terminal, you must determine the number and length of connecting cable you need and specify them in the order code.

Working port

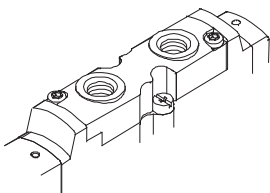
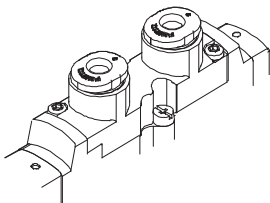
	Code	Description
	B	M5 threaded connection
	E	QS-3 push-in connector
	F	QS-4 push-in connector

Valve terminals CPA-SC, Smart Cubic

Key features – Pneumatic components



Pneumatic connection

Supply and exhaust

The valves are supplied with compressed air via various valve terminal manifold blocks or individual blocks.

These contain common lines for compressed air supply, exhaust and pilot exhaust for all valves.

The common lines on a CPA-SC valve terminal can be connected

- at the left (code L)
- at the right (code R) or
- at both ends (code B)

Pilot air supply

The CPA-SC valve terminal is suitable for internal or external pilot air. Graphs → 31

Internal pilot air supply

If supply pressure for the CPA-SC valve is within a range of 3 to 8 bar, it can be operated with internally distributed pilot air. The pilot air supply in the left-hand end plate (electrical

multi-pin plug connection and Fieldbus Direct) or in the right-hand end plate (individual electrical connection) is branched off from port 1 in this case.

External pilot air supply

If supply pressure for the CPA-SC valve terminal is within a range of –0.9 to +10 bar, it must be operated with external pilot air supply. The pilot air is supplied via port 12/14 in this case.

Pneumatic supply

With CPA-SC valve terminal	Code	Port	Connections for supply and exhaust		
			Designation	Code H QS connection metric, 8 mm Type	Code D Threaded connection G1/8 Type
Compressed air supplied by means of internal pilot air supply, exhausting via silencer					
	S	1 Working air/vacuum supply	Push-in fitting	QS-G1/8-8-l	–
		3/5 Exhaust air	Silencer	UC-1/8	–
		12/14 Pilot air supply	–	–	–
		82/84 Pilot exhaust air	Silencer	UC-M5	–
		L Pressure relieving port	Silencer	UC-M5	–
Compressed air supplied via external pilot air supply, exhausting via silencer					
	T	1 Working air/vacuum supply	Push-in fitting	QS-G1/8-8-l	–
		3/5 Exhaust air	Silencer	UC-1/8	–
		12/14 Pilot air supply	Push-in fitting	QSM-M5-4-l	–
		82/84 Pilot exhaust air	Silencer	UC-M5	–
		L Pressure relieving port	Silencer	UC-M5	–
Compressed air supplied by means of internal pilot air supply, ducted exhaust					
	V	1 Working air/vacuum supply	Push-in fitting	QS-G1/8-8-l	–
		3/5 Exhaust air	Push-in fitting	QS-G1/8-8-l	–
		12/14 Pilot air supply	–	–	–
		82/84 Pilot exhaust air	Push-in fitting	QSM-M5-4-l	–
		L Pressure relieving port	Silencer	UC-M5	–
Compressed air supplied via external pilot air supply, ducted exhaust					
	X	1 Working air/vacuum supply	Push-in fitting	QS-G1/8-8-l	–
		3/5 Exhaust air	Push-in fitting	QS-G1/8-8-l	–
		12/14 Pilot air supply	Push-in fitting	QSM-M5-4-l	–
		82/84 Pilot exhaust air	Push-in fitting	QSM-M5-4-l	–
		L Pressure relieving port	Silencer	UC-M5	–

Valve terminals CPA-SC, Smart Cubic

Key features – Pneumatic components

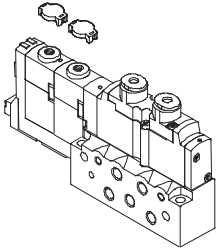
Pneumatic supply						
With CPA-SC individual block	Code	Port	Connections for supply and exhaust			
			Designation	Code B Threaded connection M5 Type	Code F Push-in connector QS4 Type	
	Compressed air supplied by means of internal pilot air supply, exhausting via silencer					
	S	1	Working air/vacuum supply	Push-in fitting	–	QSM-M5-4-I
		3/5	Exhaust air	Silencer	–	UC-M5
		12/14	Pilot air supply	–	–	–
		82/84	Pilot exhaust air	Silencer	–	U-M3
		L	Pressure relieving port	Silencer	–	U-M3
	Compressed air supplied via external pilot air supply, exhausting via silencer					
	T	1	Working air/vacuum supply	Push-in fitting	–	QSM-M5-4-I
		3/5	Exhaust air	Silencer	–	UC-M5
		12/14	Pilot air supply	Push-in fitting	–	QSM-M3-3-I
		82/84	Pilot exhaust air	Silencer	–	U-M3
		L	Pressure relieving port	Silencer	–	U-M3
	Compressed air supplied by means of internal pilot air supply, ducted exhaust					
	V	1	Working air/vacuum supply	Push-in fitting	–	QSM-M5-4-I
		3/5	Exhaust air	Push-in fitting	–	QSM-M5-4-I
		12/14	Pilot air supply	–	–	–
		82/84	Pilot exhaust air	Push-in fitting	–	QSM-M3-3-I
		L	Pressure relieving port	Silencer	–	U-M3
	Compressed air supplied via external pilot air supply, ducted exhaust					
	X	1	Working air/vacuum supply	Push-in fitting	–	QSM-M5-4-I
3/5		Exhaust air	Push-in fitting	–	QSM-M5-4-I	
12/14		Pilot air supply	Push-in fitting	–	QSM-M3-3-I	
82/84		Pilot exhaust air	Push-in fitting	–	QSM-M3-3-I	
L		Pressure relieving port	Silencer	–	U-M3	

Note

The port L compensates the pressure between moving parts inside the valve and the surrounding environment.

A silencer protects against contamination.
The port L must not be sealed by blanking plugs at both ends.

Valve terminals CPA-SC, Smart Cubic

Key features – Pneumatic components

Instructions for using pressure zones

The CPA-SC valve terminal can be operated with a maximum of 2 pressure zones, supplied either from the left or from the right.

Pressure zones are created by means of separators that can be used in the following ducts:

- Supply duct 1 (code T) and
- exhaust duct 3 (code V) or

- exhaust duct 5 (code W) or
- exhaust duct 3 and 5 (code R)

Pilot air supply

The Pilot air supply is branched off from port 1 in the left-hand end plate (electrical multi-pin plug connection and Fieldbus Direct) or in the right-hand end plate (individual electrical connection).

Internal pilot air supply is only possible at an operating pressure within a range of 3 to 8 bar. It must therefore be noted in connection with pressure zone

separation that the valve terminal is supplied with internal pilot air supply via the left-hand side when using a multi-pin plug connection and Fieldbus Direct and via the right-hand

side when using an individual electrical connection. This means that the operating pressure at this port must be within a range of 3 to 8 bar.

Note

The addition of a separator element results in the following valve sub-bases being supplied with less working air:

- Valve sub-base at the valve position in which the locating pin is inserted
- Valve sub-bases at the two adjacent valve positions

Creation of pressure zones and duct separation

	Code	Description
	T	Duct 1 closed
	V	Duct 3 closed
	W R	Duct 5 closed Duct 3/5 closed

Note

The separator element can also be mounted subsequently using an Allen key. An assembly tool for long terminals is available as an accessory.

Separator CPASC-KT

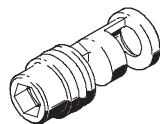

Valve terminals CPA-SC, Smart Cubic

Key features – Electrical components

Electrical power as a result of current reduction

Each valve solenoid coil is protected with a spark arresting protective circuit as well as against polarity reversal.

All valve types are additionally equipped with integrated current reduction.

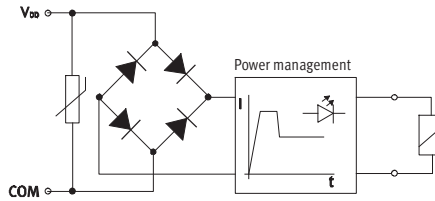

Individual electrical connection

With an individual electrical connection, the plug is connected directly to the valve.

Two types of individual electrical connection are available for the valve terminal and for the individual sub-base:

- Horizontal connection (HC) or
- Plug-in (PI)

Note

Connecting cables with 2- or 3-wires are available for single solenoid valves with one solenoid coil or double solenoid valves with two solenoid coils.

Individual electrical connection – Horizontal connection (HC)

Valve on manifold block

Code IH

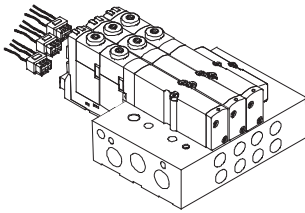

The valve terminal can be configured with 2 to max. 16 valve positions. This means that max. 32 solenoid coils can be actuated with this type of electrical connection. The horizontal connection (HC) must be removed when replacing the valve.

Valve on individual block

Code SH

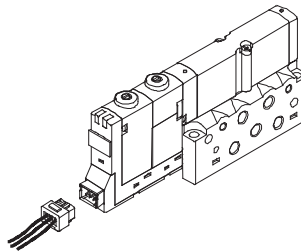

With the individual sub-base, the electrical connection is also plugged in directly on the valve.

Dimensions – Horizontal connection (HC)

Download CAD Data → www.festo.com/us/cad

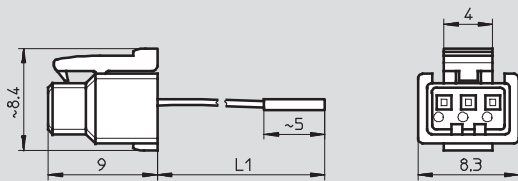

Type	Code	L1 Cable length [m]	Number of solenoid coils	Cable colour		
				Pin 1 Common	Pin 2 Solenoid coil 12	Pin 3 Solenoid coil 14
KMH-0,5	CH	0.5	1 coil	Black	–	Red
KMH-1	CI	1	1 coil	Black	–	Red
KMH-2,5	CJ	2.5	1 coil	Black	–	Red
KMH-5	CK	5	1 coil	Black	–	Red
KMH-D-0,5	CD	0.5	2 coils	Black	Blue	Red
KMH-D-1	CE	1	2 coils	Black	Blue	Red
KMH-D-2,5	CF	2.5	2 coils	Black	Blue	Red
KMH-D-5	CG	5	2 coils	Black	Blue	Red

Valve terminals CPA-SC, Smart Cubic

Key features – Electrical components



Individual electrical connection – Plug-in (PI)

Valve on manifold block

Code IP, IQ

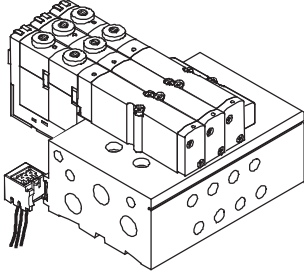

The valve terminal can be configured with 2 to max. 16 valve positions. This means that max. 32 solenoid coils can be actuated with this type of electrical connection. The connector plug is inserted into the slot on the manifold block. To replace a valve or extend the terminal (vacant position), all you need do is loosen two screws; the connector plug remains in the slot.

Valve on individual block

Code SP, SQ

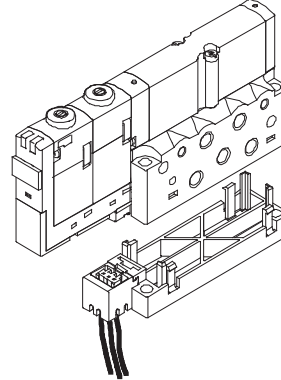

With this electrical connection variant, the connector plug is mounted on an adapter. This adapter is then attached to the manifold block.

Dimensions – Plug-in (PI) connection

Download CAD Data → www.festo.com/us/cad

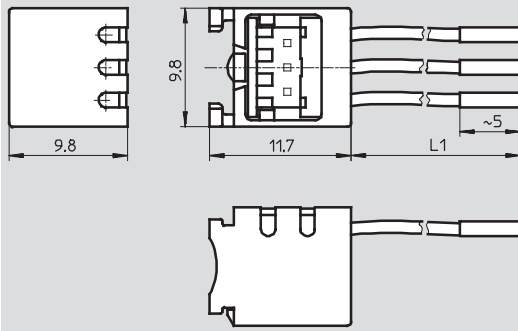

Type	Code	L1 Cable length [m]	Number of solenoid coils	Cable colour		
				Pin 1 Common	Pin 2 Solenoid coil 12	Pin 3 Solenoid coil 14
MHAP-PI	–	0.5	1 coil	Black	–	Red
MHAP-PI-1	–	1	1 coil	Black	–	Red
MHAP-PI-D-0,5	–	0.5	2 coils	Black	Blue	Red
MHAP-PI-D-1	–	1	2 coils	Black	Blue	Red

Valve terminals CPA-SC, Smart Cubic

Key features – Electrical components

Electrical multi-pin plug connection

The following multi-pin plug connection types are offered for the valve terminal CPA-SC:

- Sub-D multi-pin plug connection (25-pin) or
- Multi-pin plug connection with connector for flat cable (26-pin)

Pins 1 ... 20 are used for coils 1 ... 20 in order. If there are fewer than 20 coils on the valve terminal, the remaining pins up to 20 are left free. Pins 21 and above are reserved for neutral conductors. Four solenoid coils are always combined on one neutral conductor. This means that individual valve groups can be switched off separately or a mixture of negative- and positive-switching valves achieved.

Each pin on the multi-pin plug can activate only one valve solenoid coil. If the maximum configurable number of valve positions is 20, this means that 20 valves each with a single solenoid can be addressed. With 10 or less valve positions, 2 solenoid coils per valve can be addressed. With 12 or more valve positions, the number of available valve positions for valves with two solenoid coils decreases (➔ table below).

Example:

With 16 valve positions, valves with one or two solenoid coils can be actuated on the first four (0 ... 3) positions. Valves with just one solenoid coil are permissible at positions 4 ... 15.

Address/solenoid coil	Number of the valve position																			
	0	1	2	3	4	5	6	7	8	9	10	11	12	13	14	15	16	17	18	19
20	1	1	1	1	1	1	1	1	1	1	1	1	1	1	1	1	1	1	1	1
20	2	2	2	2	1	1	1	1	1	1	1	1	1	1	1	1				
20	2	2	2	2	2	2	2	2	1	1	1	1								
20	2	2	2	2	2	2	2	2	2	2										
16	2	2	2	2	2	2	2	2												
12	2	2	2	2	2	2														
8	2	2	2	2																

Electrical multi-pin plug connection – Sub-D

Code MS

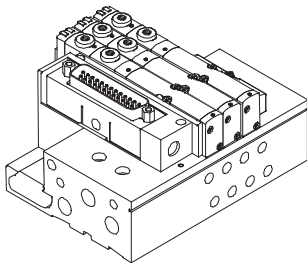

With this electrical connection variant, all valves are centrally actuated via the 25-pin connector plug. The electrical connection is located on the left-hand side and can be re-positioned by 90°.

Valve terminals CPA-SC, Smart Cubic

Key features – Electrical components

Pin allocation – Connector for Sub-D, 25-pin cable												
Pin	Address/solenoid coil	Core colour ²⁾		Valve positions ¹⁾								
		KMP6-25P-1 2-...	KMP6-25P-2 0-...	2	4	6	8	10	12	16	20	
				Valve position no./coil designation								
1	0	WH	WH	0/14	0/14	0/14	0/14	0/14	0/14	0/14	0/14	0/14
2	1	BN	BN	0/12	0/12	0/12	0/12	0/12	0/12	0/12	0/12	1/14
3	2	GN	GN	1/14	1/14	1/14	1/14	1/14	1/14	1/14	1/14	2/14
4	3	YE	YE	1/12	1/12	1/12	1/12	1/12	1/12	1/12	1/12	3/14
5	4	GY	GY		2/14	2/14	2/14	2/14	2/14	2/14	2/14	4/14
6	5	PK	PK		2/12	2/12	2/12	2/12	2/12	2/12	2/12	5/14
7	6	BU	BU		3/14	3/14	3/14	3/14	3/14	3/14	3/14	6/14
8	7	RD	RD		3/12	3/12	3/12	3/12	3/12	3/12	3/12	7/14
9	8	BK	BK			4/14	4/14	4/14	4/14	4/14	4/14	8/14
10	9	VT	VT			4/12	4/12	4/12	4/12	4/12	5/14	9/14
11	10	GY PK	GY PK			5/14	5/14	5/14	5/14	5/14	6/14	10/14
12	11	RD BU	RD BU			5/12	5/12	5/12	5/12	5/12	7/14	11/14
13	12	-	WH GN				6/14	6/14	6/14	6/14	8/14	12/14
14	13	-	BN GN				6/12	6/12	6/12	6/12	9/14	13/14
15	14	-	WH YE				7/14	7/14	7/14	7/14	10/14	14/14
16	15	-	YE BN				7/12	7/12	7/12	7/12	11/14	15/14
17	16	-	WH GY					8/14	8/14	8/14	12/14	16/14
18	17	-	GY BN					8/12	9/14	9/14	13/14	17/14
19	18	-	WH PK					9/14	10/14	10/14	14/14	18/14
20	19	-	PK BN					9/12	11/14	11/14	15/14	19/14
21	com	-	WH BU	Coil 16 ... 19								
22	com	-	BN BU	Coil 12 ... 15								
23	com	WH GN	WH RD	Coil 8 ... 11								
24	com	BN GN	BN RD	Coil 4 ... 7								
25	com	WH YE	WH BK	Coil 0 ... 3								
Number of solenoid coils				4	8	12	16	20	20	20	20	20

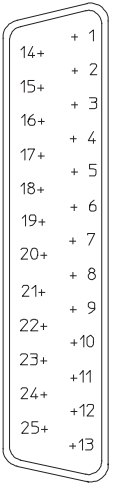

1) Valve positions for actuation of 2 coils are shown against a grey background
 2) To IEC 757

Dimensions – Sub-D plug with cable Download CAD Data → www.festo.com/us/cad

1) 25-pin plug

Type	Code	B1 [mm]	D1 [mm]	H1 [mm]	L1 [mm]	L2 [m]
KMP6-25P-20-2,5	CP	16	10.3	53.4	37.7	2.5
KMP6-25P-20-5	CQ	16	10.3	53.4	37.7	5
KMP6-25P-20-10	CR	16	10.3	53.4	37.7	10
KMP6-25P-12-2,5	CV	16	8.5	53.4	37.7	2.5
KMP6-25P-12-5	CW	16	8.5	53.4	37.7	5
KMP6-25P-12-10	CX	16	8.5	53.4	37.7	10

Valve terminals CPA-SC, Smart Cubic

Key features – Electrical components



Electrical multi-pin plug connection – Connector for flat cable

Code MF

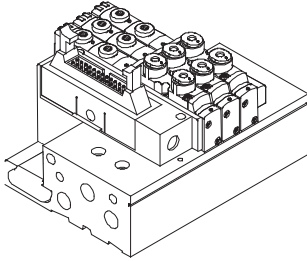

With this electrical connection variant, all valves are centrally actuated via the 26-pin connector plug.

The electrical connection is located on the left-hand side and can be re-positioned by 90°.

This connection is intended for flat cables to DIN EN 60603-13, cable cross section AWG26.

Pin allocation – Connector for flat cable

	Pin	Address/ solenoid coil	Valve positions ¹⁾						
			4	6	8	10	12	16	20
Valve position no./coil designation									
	1	0	0/14	0/14	0/14	0/14	0/14	0/14	0/14
	2	1	0/12	0/12	0/12	0/12	0/12	0/12	1/14
	3	2	1/14	1/14	1/14	1/14	1/14	1/14	2/14
	4	3	1/12	1/12	1/12	1/12	1/12	1/12	3/14
	5	4	2/14	2/14	2/14	2/14	2/14	2/14	4/14
	6	5	2/12	2/12	2/12	2/12	2/12	2/12	5/14
	7	6	3/14	3/14	3/14	3/14	3/14	3/14	6/14
	8	7	3/12	3/12	3/12	3/12	3/12	3/12	7/14
	9	8		4/14	4/14	4/14	4/14	4/14	8/14
	10	9		4/12	4/12	4/12	4/12	5/14	9/14
	11	10		5/14	5/14	5/14	5/14	6/14	10/14
	12	11		5/12	5/12	5/12	5/12	7/14	11/14
	13	12			6/14	6/14	6/14	8/14	12/14
	14	13			6/12	6/12	6/12	9/14	13/14
	15	14			7/14	7/14	7/14	10/14	14/14
	16	15			7/12	7/12	7/12	11/14	15/14
	17	16				8/14	8/14	12/14	16/14
	18	17				8/12	9/14	13/14	17/14
	19	18				9/14	10/14	14/14	18/14
	20	19				9/12	11/14	15/14	19/14
21 (free)	–	–	–						
22	com	Coil 16 ... 19							
23	com	Coil 12 ... 15							
24	com	Coil 8 ... 11							
25	com	Coil 4 ... 7							
26	com	Coil 0 ... 3							
Number of solenoid coils			8	12	16	20	20	20	20

1) Valve positions for actuation of 2 coils are shown against a grey background

Valve terminals CPA-SC, Smart Cubic

Key features – Electrical components



Fieldbus Direct

DeviceNet

Profibus DP

Properties

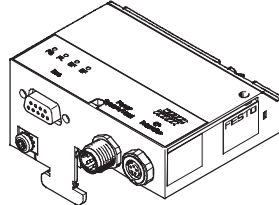
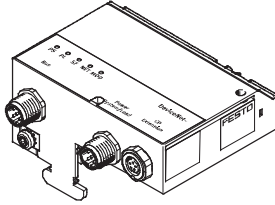

Fieldbus Direct is a system for the compact connection of a valve terminal of various sizes to different fieldbus standards. The CP string extension option allows the functions and components of the CPI installation system to be used.

The I/O modules and cables for the CP string extension are ordered using the order code for the CPI installation system.

➔ Internet: ctec

Address allocation – Solenoid coils

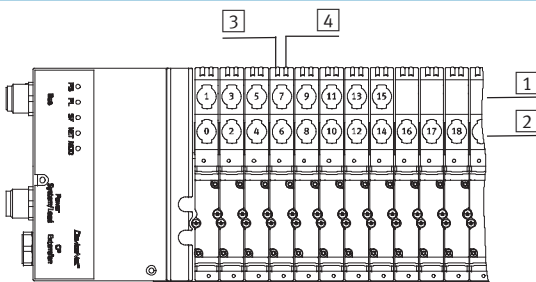

- 1 Solenoid coils 12
- 2 Solenoid coils 14
- 3 LED solenoid coil 12
- 4 LED solenoid coil 14

The addresses of the valve solenoids on the CPASC-DN/CPASC-DP are allocated from left to right, while the addresses of the individual valve positions are allocated from front to back.

Example:

Valve terminal where the first 8 valve positions are prepared for 2 solenoids each.

Each valve position can actuate one or two solenoid coils depending on the configuration (number of valve positions and internal wiring). It then occupies one or two addresses. The internal wiring cannot be changed subsequently.

The number of addresses each valve position occupies has nothing to do with what is actually mounted on the valve position (valve, blanking plate).

If a valve position for 2 addresses is actually equipped with two solenoid coils, the following allocation applies:

- Solenoid coil 14 occupies the less significant address
- Solenoid coil 12 occupies the more significant address

If a valve position for 2 addresses is equipped with only one solenoid coil, the more significant address remains unused. The valve position occupies two addresses nonetheless.

Address/solenoid coil	Number of the valve position																							
	0	1	2	3	4	5	6	7	8	9	10	11	12	13	14	15	16	17	18	19	20	21	22	23
32	2	2	2	2	2	2	2	2	1	1	1	1	1	1	1	1	1	1	1	1	1	1	1	1
32	2	2	2	2	2	2	2	2	2	2	2	2	2	1	1	1	1	1	1	1	1	1	1	1
32	2	2	2	2	2	2	2	2	2	2	2	2	2	2	2	2	2	2	2	2	2	2	2	2
24	2	2	2	2	2	2	2	2	2	2	2	2	2	2	2	2	2	2	2	2	2	2	2	2
20	2	2	2	2	2	2	2	2	2	2	2	2	2	2	2	2	2	2	2	2	2	2	2	2
16	2	2	2	2	2	2	2	2	2	2	2	2	2	2	2	2	2	2	2	2	2	2	2	2
12	2	2	2	2	2	2	2	2	2	2	2	2	2	2	2	2	2	2	2	2	2	2	2	2
8	2	2	2	2	2	2	2	2	2	2	2	2	2	2	2	2	2	2	2	2	2	2	2	2

Valve terminals CPA-SC, Smart Cubic

Key features – Display and operation

Display and operation – Multi-pin plug and individual valve connection

Each valve solenoid coil is allocated an LED which indicates its operating status. Inscription labels (type IBS-6x10) can be applied to each valve for labelling purposes. Alternatively inscription labels (type MH-BZ-80x) can also be affixed to the slot in the manifold block.

The manual override (MO) allows the valve to be activated without electronic control or power supply. The valve is activated by pushing the manual override. The set switching status can also be secured by turning the manual override.

A cover can be fitted over the manual override to prevent it from being actuated accidentally (code V).

Note

A manually activated valve (manual override) cannot be reset electrically. Conversely, an electrically activated valve cannot be reset using the manual override facility.

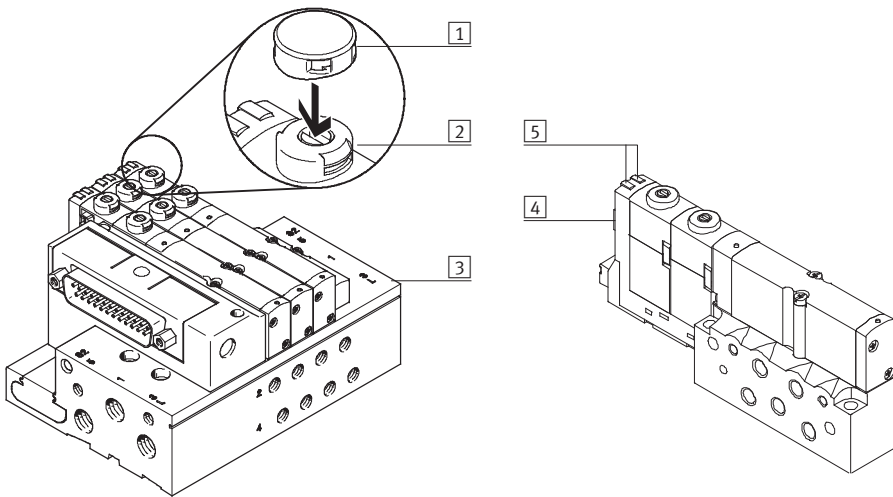

- 1 Cover for manual override (code V or accessory VMPA-HBV-B)
- 2 Optional manual override (pushing and detenting via turning using a screwdriver)
- 3 Slot for inscription labels type MH-BZ-80x
- 4 Location for valve inscription label type IBS-6x10
- 5 LED signal status display per solenoid coil

Manual override (MO)

Manual override with automatic return (non-detenting)

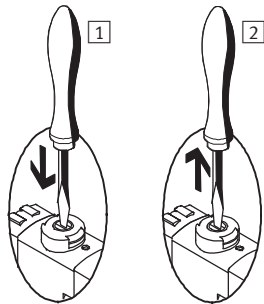

- 1 Press in the stem of the MO with a screwdriver.
→ Valve is in switching position
- 2 Remove the screwdriver.
Spring force pushes the stem of the MO back.
→ Valve returns to initial position (not with double solenoid valve code J).

MO with detent (turning with detent)

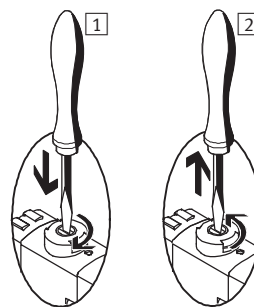

- 1 Press in the stem of the MO with a screwdriver until the valve switches and then turn the stem clockwise by 90° until the stop is reached.
→ Valve remains in switching position
- 2 Turn the stem anti-clockwise by 90° until the stop is reached and then remove the screwdriver. Spring force pushes the stem of the MO back.
→ Valve returns to initial position (not with double solenoid valve code J).

Valve terminals CPA-SC, Smart Cubic

Key features – Mounting types

Mounting – Valve terminal

Wall mounting

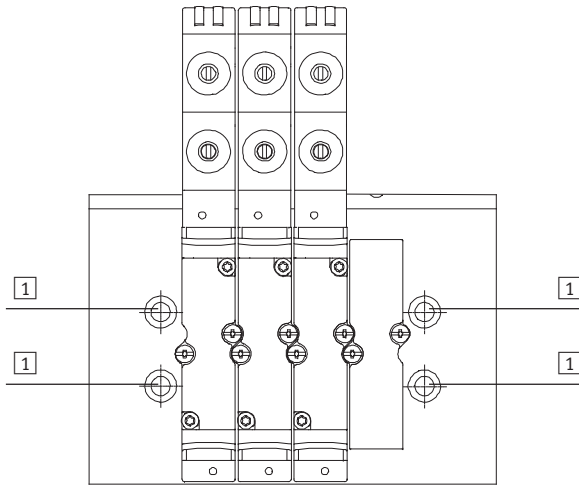

The CPA-SC valve terminal is screwed onto the mounting surface using four M4 screws.

- 1 Holes for wall mounting

H-rail mounting

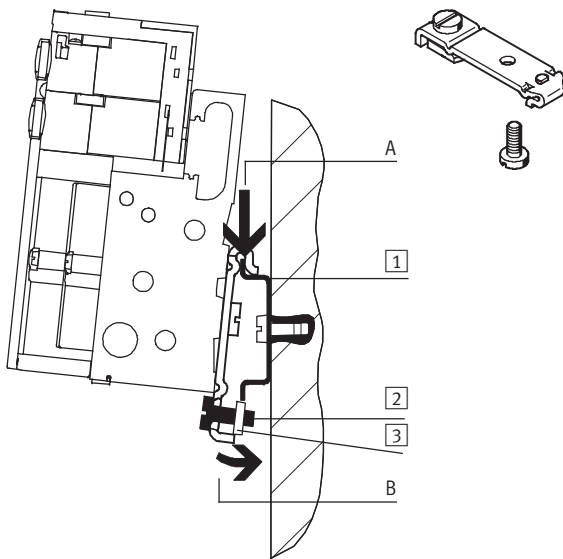

The CPA-SC valve terminal is attached to the H-rail (see arrow A). The CPA-SC valve terminal is then swivelled on the H-rail and secured in place with the clamping component (see arrow B).

For H-rail mounting of the CPA valve terminal, you will need the mounting kit CPASC1-BG-NRH. This enables the valve terminal to be mounted on a H-rail to EN 60715.

- 1 H-rail
- 2 Self-tapping M4x10 screw of the H-rail clamping unit
- 3 Clamping component of the H-rail clamping unit

Mounting – Individual sub-base

Wall mounting

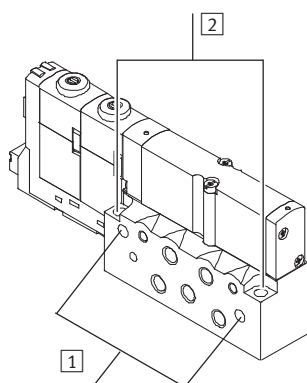

The individual sub-base for wall mounting is designed for integration into a system or machine.

Mounting holes

- 1 Horizontal mounting
- 2 Vertical mounting

Valve terminals CPA-SC, Smart Cubic



Technical data

Flow rate
150 l/min

Width
10 mm

Voltage
24 V DC

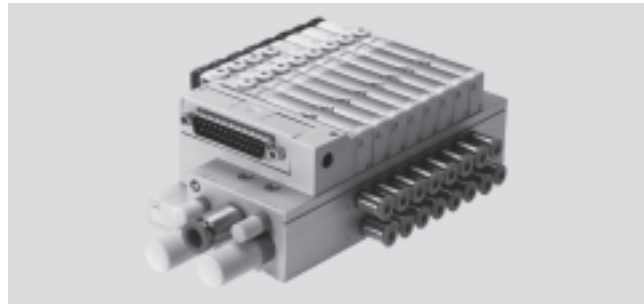

General technical data										
Valve	5/2-way valve		2x 3/2-way valve		5/3-way valve			1x 3/2-way valve	2x 2/2-way valve	
			Normally		Mid-position			Normally	Normally	
	Single solenoid	Double solenoid	open	closed	pressurised	closed	exhausted	closed	closed	
Valve function ordering code	M	J	N	K	B	G	E	X	I	
Design	Electromagnetically actuated piston spool valve									
Width [mm]	10									
Nominal diameter [mm]	2.5									
Lubrication	Lubricated for life, PWIS-free (free of paint-wetting impairment substances)									
Type of mounting	Wall mounting									
	On H-rail to EN 60715									
Assembly position	Any									
Manual override	Pushing/detented by turning									
Pneumatic connections										
Pneumatic connection	Via manifold block, PRS manifold or individual connection									
Supply port 1	G $\frac{3}{8}$ (M5 with individual block)									
Exhaust port 3/5	G $\frac{3}{8}$ (M5 with individual block)									
Working lines 2/4	Depending on the connection type selected									
	<ul style="list-style-type: none"> • M5 • QS-3 • QS-4 									
Pilot air port 12/14	M5 (M3 with individual block)									
Pilot exhaust air port 82/84	M5 (M3 with individual block)									
Pressure compensating port L	M5, M3									

Valve response times [ms]										
Valve function ordering code	M	J	N	K	B	G	E	X	I	
Response times	on	10	–	10	10	10	10	10	10	10
	off	20	–	20	20	25	25	25	20	20
	changeover	–	10	–	–	–	–	–	–	–

Valve terminals CPA-SC, Smart Cubic

Technical data

Operating and environmental conditions									
Valve function ordering code	M	J	N	K	B	G	E	X	I
Operating medium	Compressed air in accordance with ISO 8573-1:2010 [7:4:4] → 35								
Note on operating/pilot medium	Operation with lubricated medium possible (in which case lubricated operation will always be required)								
Operating pressure [bar]	-0.9 ... +10		3 ... 10			-0.9 ... +10		3 ... 10	
Operating pressure for valve terminal with internal pilot air supply [bar]	3 ... 8								
Pilot pressure [bar]	3 ... 8								
Ambient temperature [°C]	-5 ... +60		-5 ... +40 ¹⁾			-5 ... +60		-5 ... +40 ¹⁾	
Ambient temperature in case of fieldbus connection [°C]	-5 ... +50		-5 ... +40 ¹⁾			-5 ... +50		-5 ... +40 ¹⁾	
Storage temperature [°C]	-20 ... +40								
Corrosion resistance class CRC ²⁾	1								
CE mark (see declaration of conformity)	To EU EMC Directive ³⁾								
Certification	c UL us - Recognized (OL)								

- 1) Restricted ambient temperature in case of two permanently activated solenoid coils per valve location, otherwise same temperature range as ordering code M.
- 2) Corrosion resistance class 1 according to Festo standard 940 070
Components requiring low corrosion resistance. Transport and storage protection. Parts that do not have primarily decorative surface requirements, e.g. in internal areas that are not visible or behind covers.
- 3) For information about the applicability of the component see the manufacturer's EC declaration of conformity at: www.festo.com → Support → User documentation.
If the component is subject to restrictions on usage in residential, office or commercial environments or small businesses, further measures to reduce the emitted interference may be necessary.

Pilot pressure p2 as a function of working pressure p1 with external pilot air supply

for valve sub-bases with code M, J, B, G, E, X

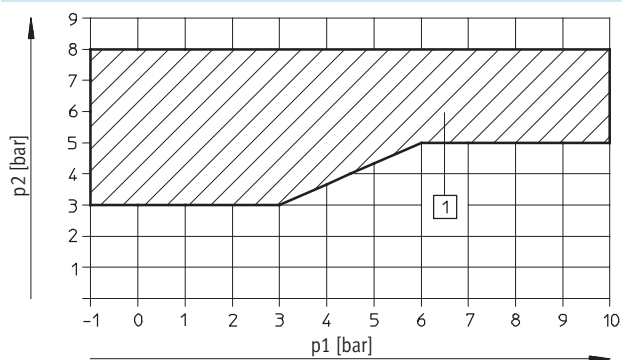

1) Operating range for valves with external pilot air supply

for valve sub-bases with code N, K, I

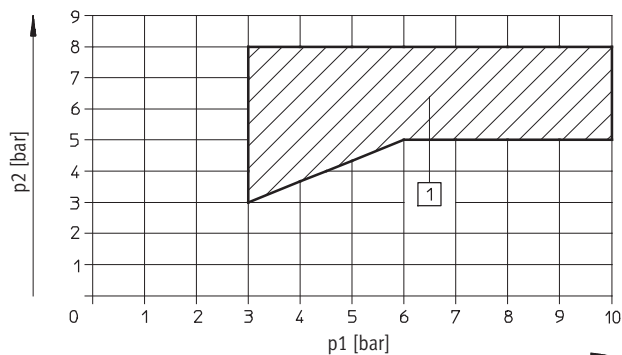

1) Operating range for valves with external pilot air supply

Valve terminals CPA-SC, Smart Cubic

Technical data

Electrical data	
Valve function ordering code	M J N K B G E X I
Electromagnetic compatibility of the CPA-SC valve terminal (Sub-D or flat cable connection)	Interference emission tested to EN 61000-6-4, industry
	Interference immunity ¹⁾ tested to EN 61000-6-2, industry
Protection against electric shock (protection against direct and indirect contact to EN 60204-1/IEC 204)	By means of PELV power supply unit
Operating voltage of valves and electronic components	
Nominal operating voltage [V]	24 DC
Operating voltage range [V]	20.4 ... 26.4 DC
Electrical power consumption	
Electronic components [mA]	200 and current consumption of sensors
Valves [W]	Pull: 1, hold: 0.3
Residual ripple [V _{ss}]	4
Cut-off pause [ms]	Min. 1
Switching frequency [Hz]	Max. 10
Duty cycle	100%
Protection class to EN 60529	IP40 (in assembled state and with detenting plug)
Relative air humidity	90% at 40°C, non-condensing
Vibration resistance	To DIN/IEC 68/EN 60068, Parts 2-6, severity level 2
Continuous shock resistance	To DIN/IEC 68/EN 60068, Parts 2-27, severity level 2

1) The maximum signal line length is 10 m

Materials	
Valve function ordering code	M J N K B G E X I
Manifold block	Wrought aluminium alloy
Valve sub-base	Die-cast aluminium
Seal	Nitrile rubber

Product weight [g]	Approx. weights
Valve function ordering code	M J N K B G E X I
Basic manifold block weight	125
Additional manifold block weight per valve position	40
Individual block	45
per valve sub-base	40
Fieldbus connection	150

Valve terminals CPA-SC, Smart Cubic

Technical data

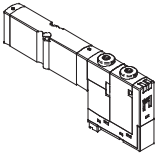
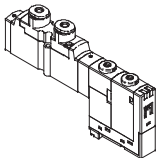
Standard nominal flow rate [l/min]						
	Code	Valve function	Valve	Individual block	CPA-SC valve terminal with multi-pin plug connection/individual PI connections	CPA-SC valve terminal with individual horizontal connections
	Sub-base valve					
	M	5/2-way valve, single solenoid	220	170	150	120
	J	5/2-way valve, double solenoid	220	170	150	120
	N	2x 3/2-way valve, normally open	220	170	150	120
	K	2x 3/2-way valve, normally closed	180	150	120	120
	B	5/3-way valve, mid-position pressurised	220	150	120	120
	G	5/3-way valve, mid-position closed	180	150	120	120
	E	5/3-way valve, mid-position exhausted	180	150	120	120
	X	1x 3/2-way valve	120	–	100	85
I	2x 2/2-way valve	150	140	140	120	
	Semi in-line valve with working port M5					
	M	5/2-way valve, single solenoid	200	180	180	180
	J	5/2-way valve, double solenoid	200	180	180	180
	N	2x 3/2-way valve, normally open	200	180	180	180
	K	2x 3/2-way valve, normally closed	150	150	150	150
	B	5/3-way valve, mid-position pressurised	180	180	180	180
	G	5/3-way valve, mid-position closed	150	150	150	150
	E	5/3-way valve, mid-position exhausted	180	170	180	170
	X	1x 3/2-way valve	120	–	120	120
I	2x 2/2-way valve	150	150	150	150	

Valve terminals CPA-SC, Smart Cubic

Technical data

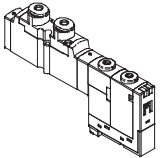
Standard nominal flow rate [l/min]						
	Code	Valve function	Valve	Individual block	CPA-SC valve terminal with multi-pin plug connection/individual PI connections	CPA-SC valve terminal with individual horizontal connections
	Semi in-line valve, working port with QS-3 fitting					
	M	5/2-way valve, single solenoid	140	140	140	140
	J	5/2-way valve, double solenoid	140	140	140	140
	N	2x 3/2-way valve, normally open	140	140	140	140
	K	2x 3/2-way valve, normally closed	130	130	130	130
	B	5/3-way valve, mid-position pressurised	140	140	140	140
	G	5/3-way valve, mid-position closed	130	130	130	130
	E	5/3-way valve, mid-position exhausted	140	140	140	140
	X	1x 3/2-way valve	100	–	100	100
	I	2x 2/2-way valve	130	130	130	130
	Semi in-line valve, working port with QS-4 fitting					
	M	5/2-way valve, single solenoid	180	170	180	180
	J	5/2-way valve, double solenoid	180	170	180	180
	N	2x 3/2-way valve, normally open	180	170	180	180
	K	2x 3/2-way valve, normally closed	150	150	150	150
	B	5/3-way valve, mid-position pressurised	180	170	180	170
	G	5/3-way valve, mid-position closed	150	150	150	150
	E	5/3-way valve, mid-position exhausted	170	170	170	170
	X	1x 3/2-way valve	120	–	120	120
I	2x 2/2-way valve	150	140	150	150	

Valve terminals CPA-SC, Smart Cubic

Technical data

FESTO

Pneumatic equipment

Operate your equipment with unlubricated compressed air if possible. Festo valves and cylinders are designed for operation under normal use without any additional lubrication, yet still have a long service life. The quality of compressed air downstream from the compressor must correspond to that of unlubricated compressed air. If possible, do not operate all of your equipment with lubricated compressed air. The lubricators should, where possible, always be installed directly upstream of the cylinders used.

Incorrect additional oil and too high an oil content in the compressed air reduces the service life of a valve terminal.

Use Festo special oil OFSW-32 or the alternatives listed in the Festo catalogue (as specified in DIN 51524 HLP32; basic oil viscosity 32 CST at 40 °C).

Bio-oils

When using bio-oils (oils which are based upon synthetic or native ester, e.g. rapeseed oil methyl ester), the maximum residual oil content of 0.1 mg/m³ must not be exceeded (see ISO 8573-1 Class 2).

Mineral oils

When using mineral oils (e.g. HLP oils to DIN 51524, parts 1 through 3) or similar oils based on poly-alpha-olefins (PAO), the maximum residual oil content of 5 mg/m³ must not be exceeded (see ISO 8573-1 Class 4).

A higher residual oil content irrespective of the compressor oil cannot be permitted, as the basic lubricant would be flushed out over time.

Valve terminals CPA-SC, Smart Cubic

Technical data

FESTO

Dimensions – Sub-base valve

Download CAD Data → www.festo.com/us/cad

Plug-In (PI)

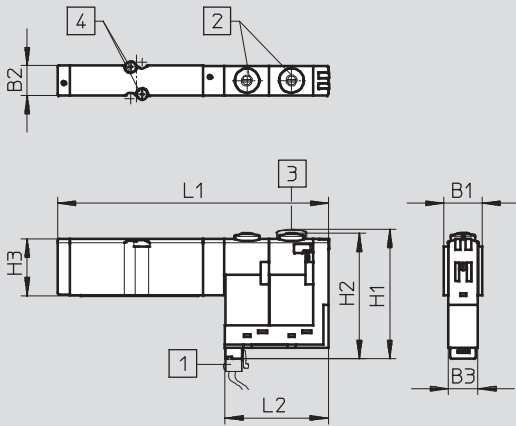

- 1 Individual PI connection
- 2 Manual override (MO)
- 3 Manual override cover
- 4 Screws M2x20

Horizontal connection (HC)

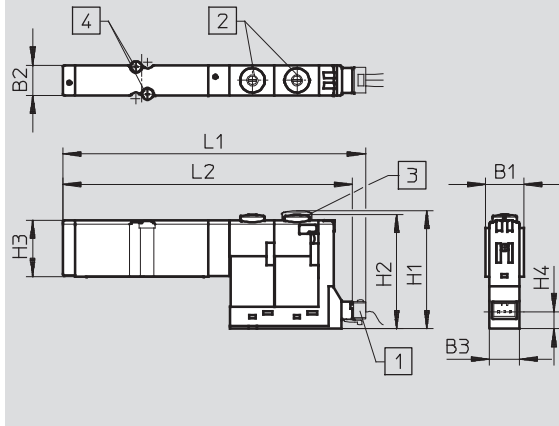

- 1 Individual horizontal connection
- 2 Manual override (MO)
- 3 Manual override cover
- 4 Screws M2x20

Plug-In (PI)

B1	B2	B3	H1	H2	H3	L1	L2
12.6	10	9.8	43.8	42.5	18.7	89.4	33.7

Horizontal connection (HC)

B1	B2	B3	H1	H2	H3	H4	L1	L2
12.6	10	9.8	39.1	37.7	18.5	5.7	100	95.6

Dimensions – Semi in-line valve

Download CAD Data → www.festo.com/us/cad

Plug-In (PI), working port M5

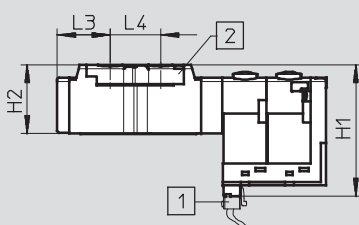

- 1 Individual PI connection
- 2 Working port M5

Horizontal connection (HC), working port M5

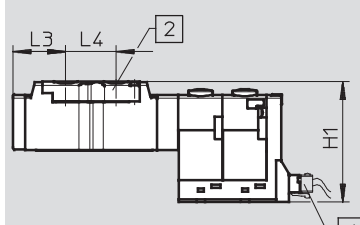

- 1 Individual horizontal connection
- 2 Working port M5

Plug-In (PI), working port QS-3/QS-4

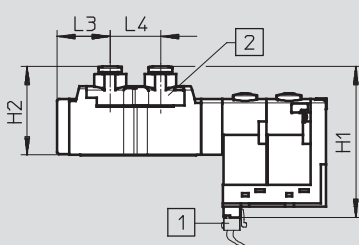

- 1 Individual PI connection
- 2 Working port QS-3/QS-4

Horizontal connection (HC), working port QS-3/QS-4

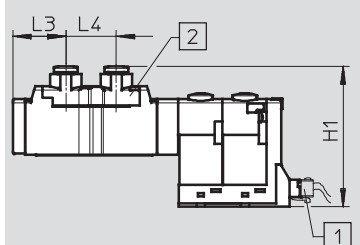

- 1 Individual horizontal connection
- 2 Working port QS-3/QS-4

Plug-In (PI)

	H1	H2	L3	L4
Working port M5	43.8	22.9	17.6	16.8
Working port QS-3/QS-4	50.2	29.4	17.6	16.8

Horizontal connection (HC)

	H1	L3	L4
Working port M5	40.2	17.6	16.8
Working port QS-3/QS-4	46.6	17.6	16.8

Valve terminals CPA-SC, Smart Cubic

Technical data

Dimensions – Individual sub-base

Download CAD Data → www.festo.com/us/cad

With individual plug-in (PI) connection

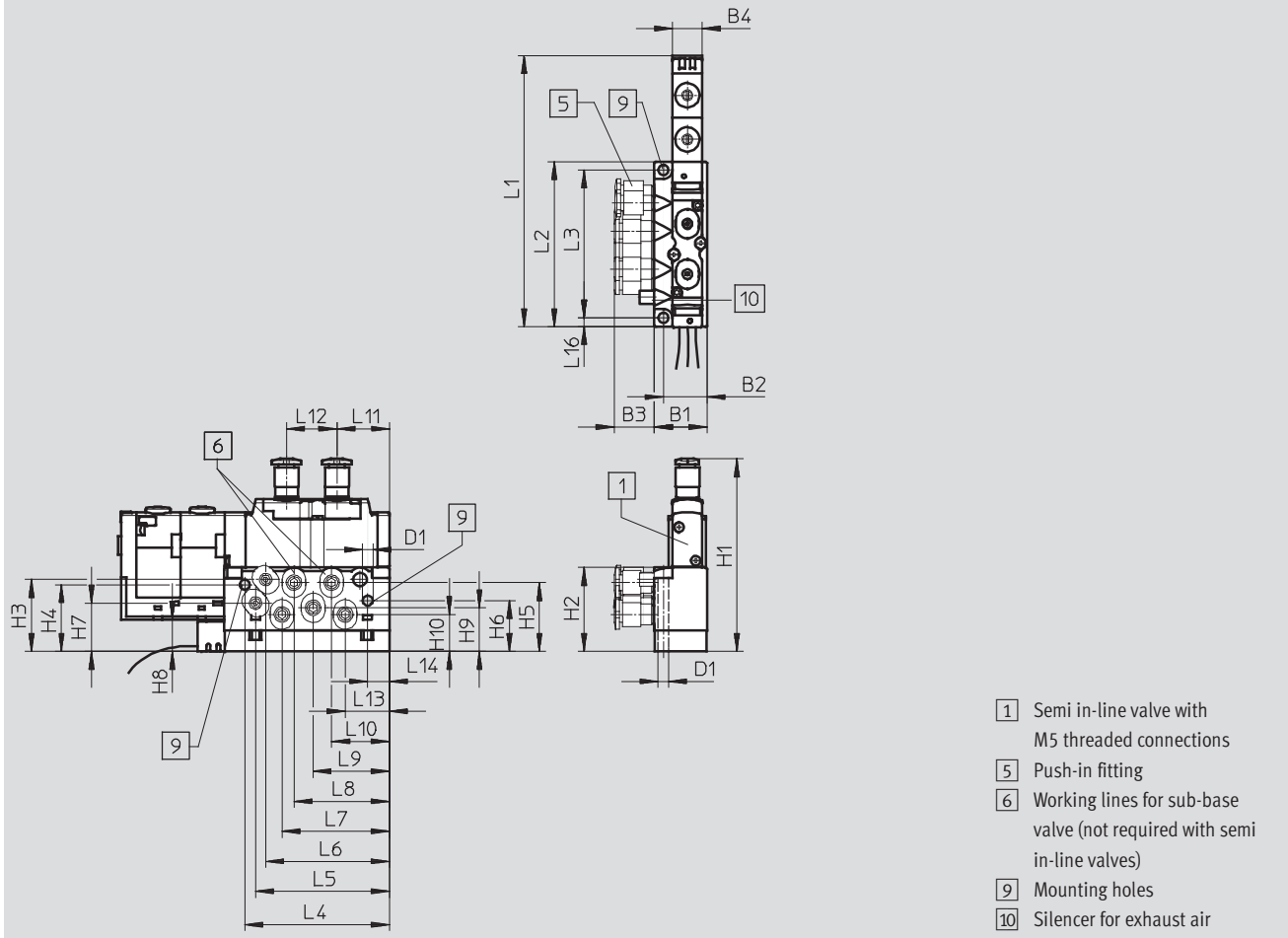

H2	H3	H4	H5	H6	H7	H8	H9	H10	B1	B2	B3	B4	D1	-
27.9	23.9	22.2	22.9	16.9	16.1	10.6	14.5	12.3	17.5	14.5	13.4	9.8	3.4	-

L1	L2	L3	L4	L5	L6	L7	L8	L9	L10	L11	L12	L13	L14	L16
90.3	55	49.3	48.2	44.6	41.2	35.8	31.8	25.4	19.2	17.5	16.8	14.7	7.2	2.9

Valve type	H1
Semi in-line valve	
with working port M5	50.8
with working port QS-3/QS-4	57.2
Sub-base valve	48.3
Blanking plate	37.1

Valve terminals CPA-SC, Smart Cubic

Technical data

FESTO

Dimensions – Individual sub-base

Download CAD Data → www.festo.com/us/cad

With individual horizontal connection (HC)

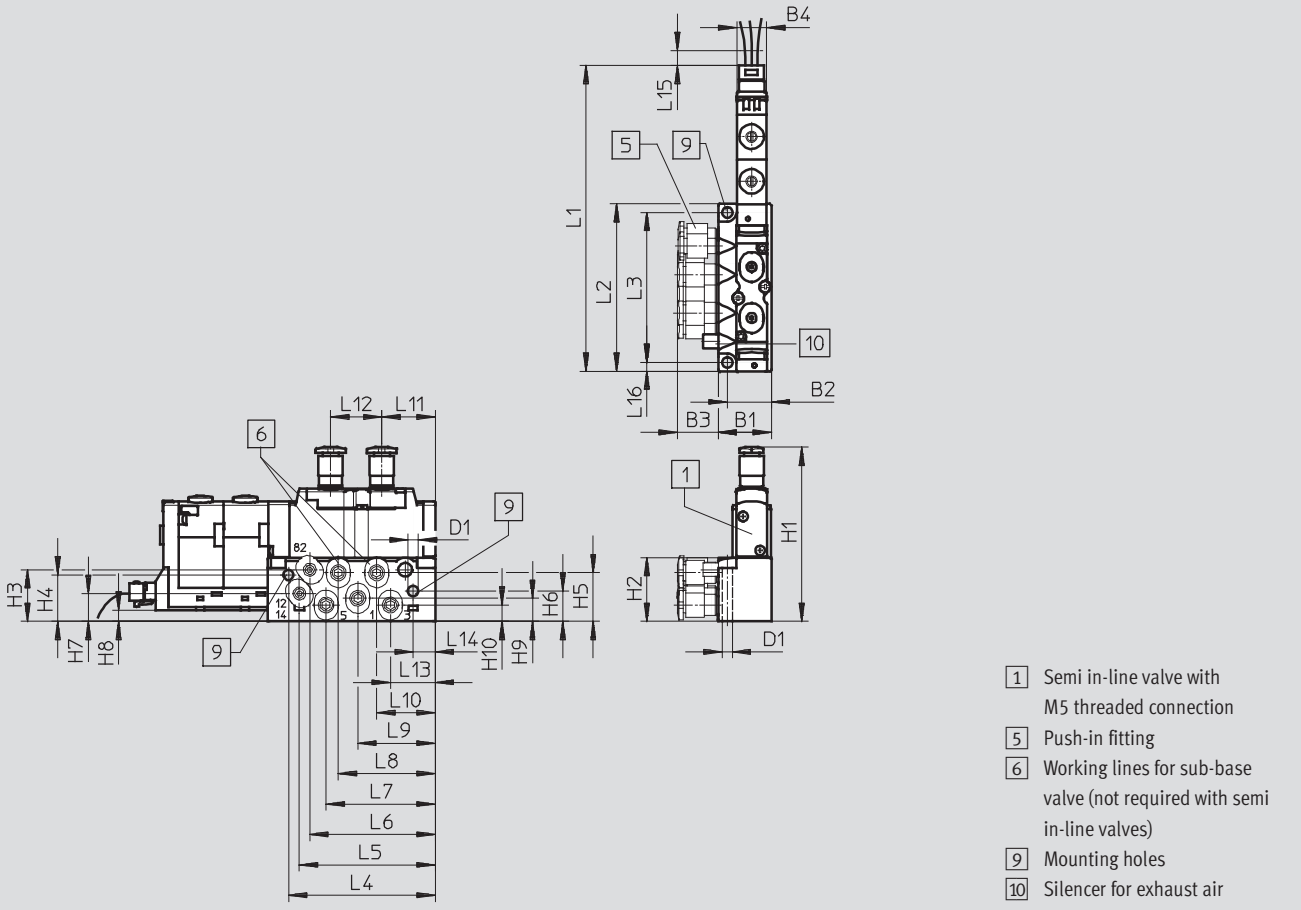

H2	H3	H4	H5	H6	H7	H8	H9	H10	B1	B2	B3	B4	D1	-
21	17	15.3	16	10	9.2	3.7	7.6	5.4	17.5	14.5	13.4	9.8	3.4	-

L1	L2	L3	L4	L5	L6	L7	L8	L9	L10	L11	L12	L13	L14	L15	L16
100.4	55	49.3	48.2	44.6	41.2	35.8	31.8	25.4	19.2	17.5	16.8	14.7	7.2	5	2.9

Valve type	H1
Semi in-line valve	
with working port M5	43.9
with working port QS-3/QS-4	50.3
Sub-base valve	41.4
Blanking plate	30.2

Valve terminals CPA-SC, Smart Cubic

Technical data

Dimensions – Valve terminal

Download CAD Data → www.festo.com/us/cad

With individual plug-in (PI) connection

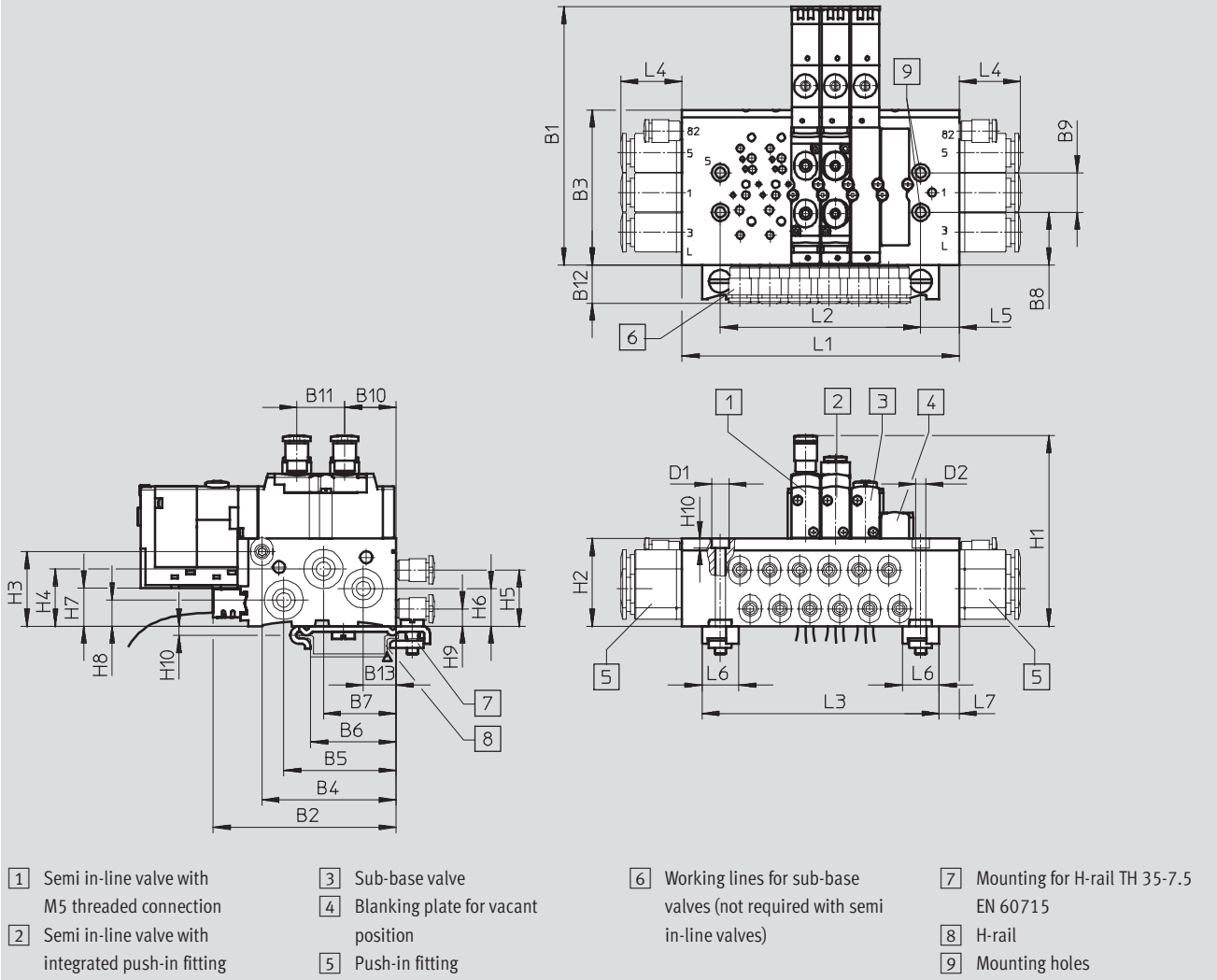

B1	B2	B3	B4	B5	B6	B7	B8	B9	B10	B11	B12	B13	D1	D2
91	64.3	54.6	47.2	39.5	30.1	25.5	18.6	14	18.1	16.8	13.4	11.5	6	3.6

H2	H3	H4	H5	H6	H7	H8	H9	H10	L3	L4	L5	L6	L7	-
30.8	26.3	20.2	19.8	13.3	13.5	9.3	6.2	3.2	L2+13	21.6	13.5	13	7	-

Valve positions	L1	L2
2	55	28.5
4	76.5	49.5
6	97.5	70.5
8	118.5	91.5
10	139.5	112.5
12	160.5	133.5
16	202.5	175.5

Valve type	H1
Semi in-line valve with working port M5	53.7
Semi in-line valve with working port QS-3/QS-4	60.1
Sub-base valve	51.2
Blanking plate	40

Valve terminals CPA-SC, Smart Cubic

Technical data

FESTO

Dimensions – Valve terminal

Download CAD Data → www.festo.com/us/cad

With individual horizontal connection (HC)

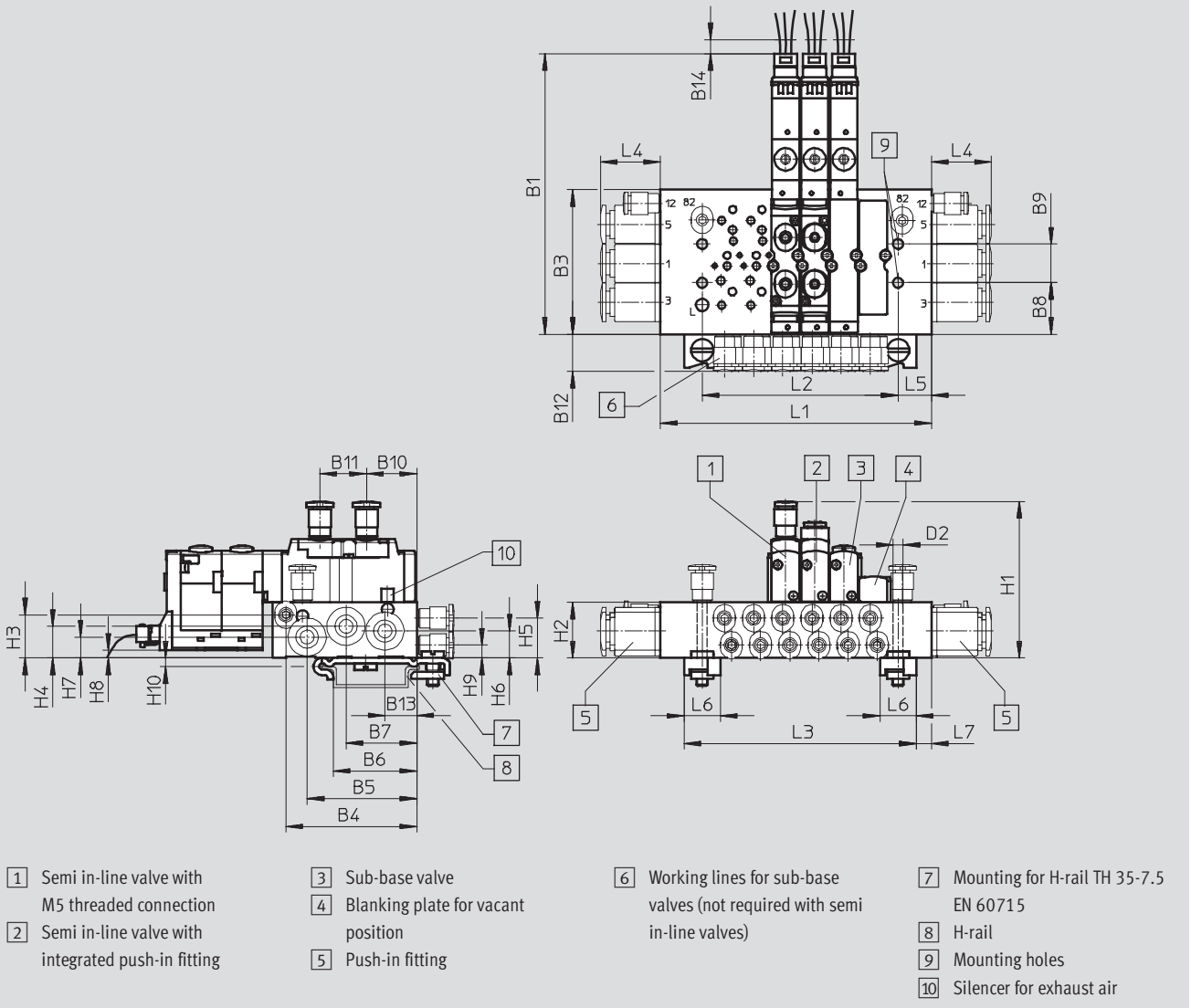

B1	B3	B4	B5	B6	B7	B8	B9	B10	B11	B12	B13	D1	D2
102	52	47.2	39.5	30.1	25.5	18.6	14	18.1	16.8	13.4	11.5	6	3.6

H2	H3	H4	H5	H6	H7	H8	H9	H10	L3	L4	L5	L6	L7
20	15.5	11.4	14.3	9.7	7.5	2.7	4.6	3.2	L2+13	21.6	12	13	5.5

Valve positions	L1	L2
2	54.5	29
4	75.5	50
6	96.5	71
8	117.5	92
10	138.5	113
12	159.5	134
16	201.5	176

Valve type	H1
Semi in-line valve with working port M5	42.9
Semi in-line valve with working port QS-3/QS-4	49.3
Sub-base valve	40.4
Blanking plate	29.2

Valve terminals CPA-SC, Smart Cubic

Technical data

Dimensions – Valve terminal

Download CAD Data → www.festo.com/us/cad

With Sub-D multi-pin plug connection

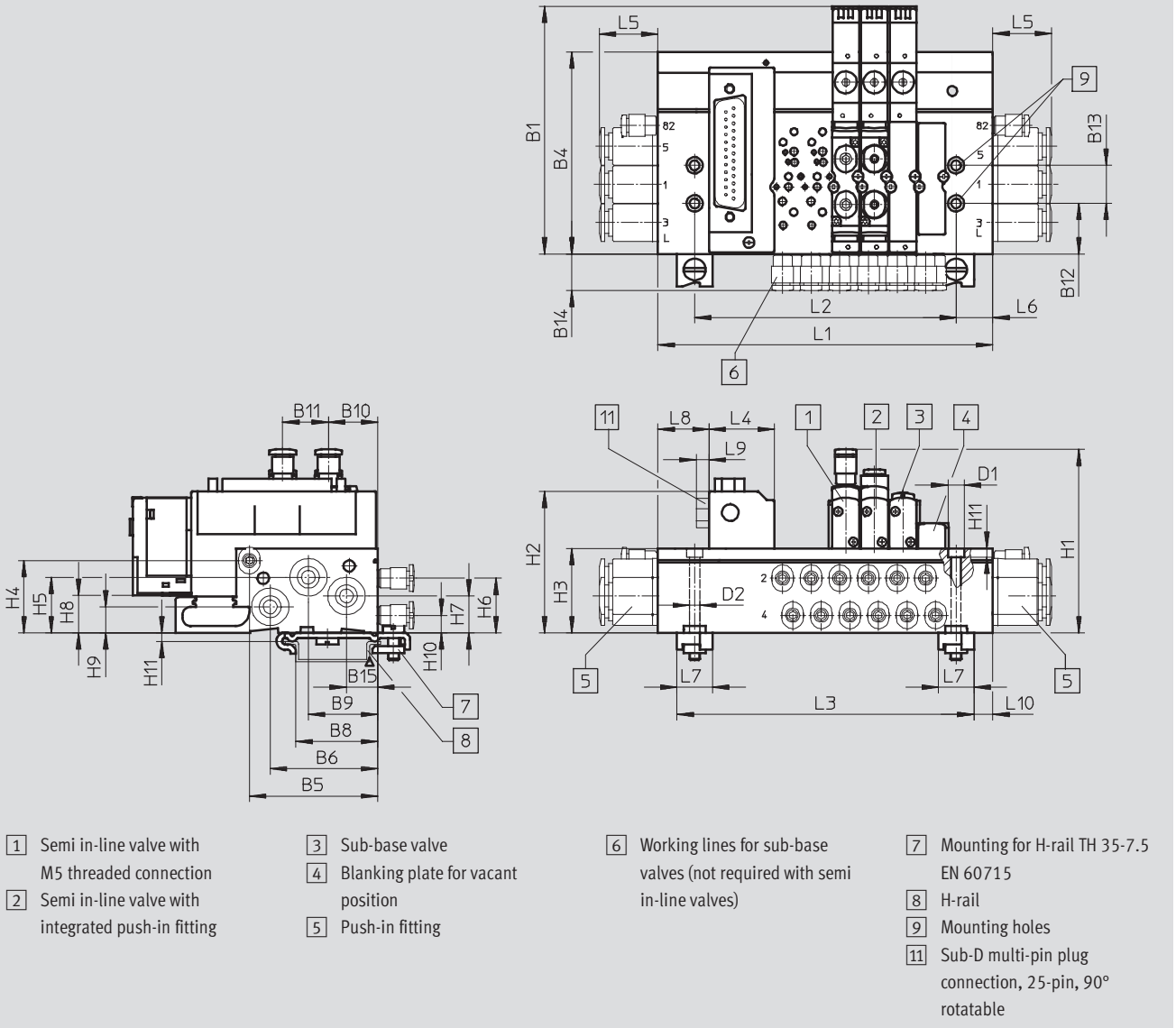

B1	B4	B5	B6	B8	B9	B10	B11	B12	B13	B14	B15	D1	D2	-
91	74.2	47.2	39.5	30.1	25.5	18.1	16.8	18.6	14	13.4	11.5	6	3.6	-

H2	H3	H4	H5	H6	H7	H8	H9	H10	H11	L3	L4	L5	L6	L7	L8	L9	L10
52	31	26.5	20.4	20	13.5	13.7	9.5	6.4	3.2	L2+13	24	21.6	13.5	13	18.8	4.7	7

Valve positions	L1	L2
2	81	54
4	102	75
6	123	96
8	144	117
10	165	138
12	186	159
16	228	201
20	270	243

Valve type	H1
Semi in-line valve with working port M5	53.9
Semi in-line valve with working port QS-3/QS-4	60.3
Sub-base valve	51.4
Blanking plate	40.2

Valve terminals CPA-SC, Smart Cubic

Technical data

FESTO

Dimensions – Valve terminal

Download CAD Data → www.festo.com/us/cad

With multi-pin connector for flat cable

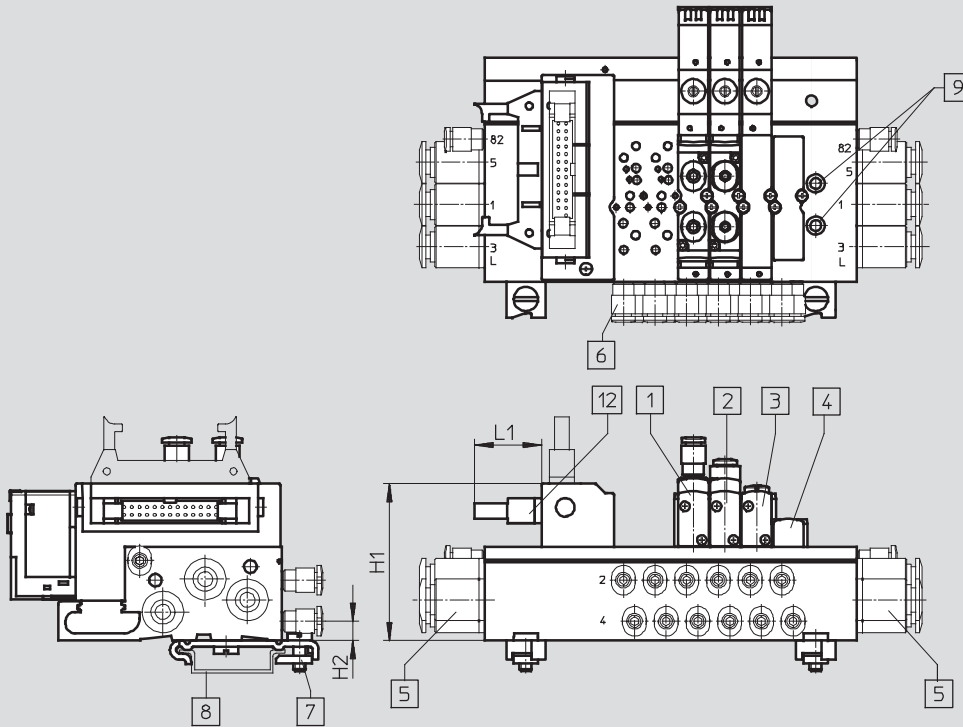

- 1 Semi in-line valve with M5 threaded connection
- 2 Semi in-line valve with integrated push-in fitting

- 3 Sub-base valve
- 4 Blanking plate for vacant position
- 5 Push-in fitting

- 6 Working lines for sub-base valves (not required with semi in-line valves)

- 7 Mounting for H-rail TH 35-7.5 EN 60715
- 8 H-rail
- 9 Mounting holes
- 12 Connector for flat cable, 26-pin, 90° rotatable

	H1	H2	L1
Valve terminal	52	6.4	22.3

Valve terminals CPA-SC, Smart Cubic

Technical data

Dimensions – Valve terminal

Download CAD Data → www.festo.com/us/cad

With fieldbus connection

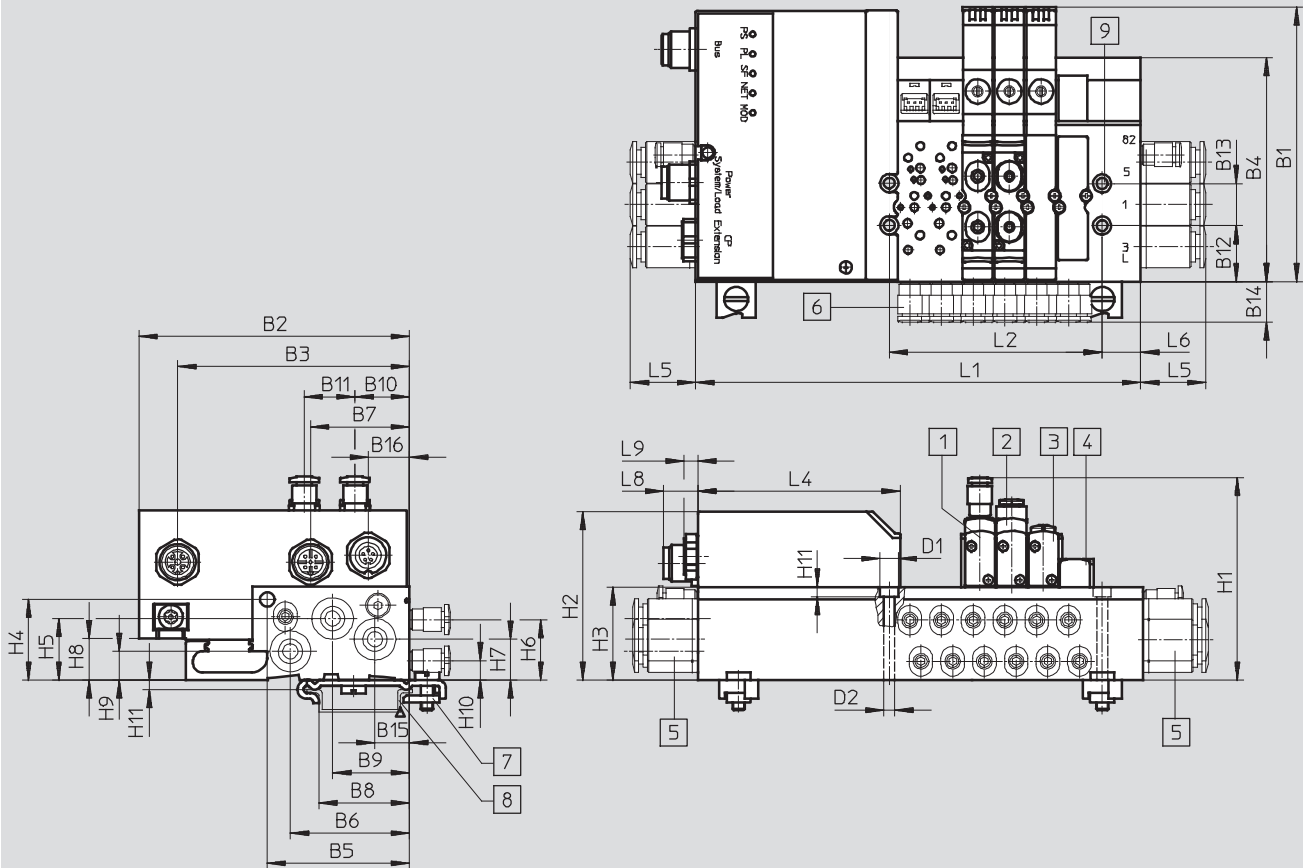

- 1 Semi in-line valve with M5 threaded connection
- 2 Semi in-line valve with integrated push-in fitting
- 3 Sub-base valve
- 4 Blanking plate for vacant position
- 5 Push-in fitting
- 6 Working lines for sub-base valves (not required with semi in-line valves)
- 7 Mounting for H-rail TH 35-7.5 EN 60715
- 8 H-rail
- 9 Mounting holes

B1	B2	B3	B4	B5	B6	B7	B8	B9	B10	B11	B12	B13	B14	B15	B16	D1	D2
91	89.7	76.8	74.2	47.2	39.5	32.8	30.1	25.5	18.1	16.8	18.6	14	13.4	11.5	13.7	6	3.6

H2	H3	H4	H5	H6	H7	H8	H9	H10	H11	L4	L5	L6	L8	L9	-	-
56	31	26.5	20.2	19.8	13.5	13.5	9.3	6.4	3.2	67.1	21.6	13.5	11.3	4.5	-	-



Valve positions	L1	L2
4	127.2	49.5
6	148.2	70.5
8	169.2	91.5
10	190.2	112.5
12	211.2	133.5
16	253.2	175.5
20	295.2	217.5
24	337.2	259.5

Valve type	H1
Semi in-line valve with working port M5	53.9
Semi in-line valve with working port QS-3/QS-4	60.3
Sub-base valve	51.4
Blanking plate	40.2

Valve terminals CPA-SC, Smart Cubic

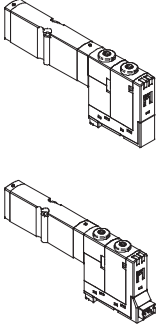
Ordering data – Individual valve

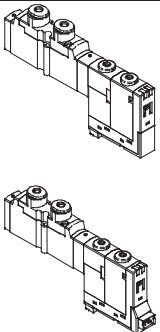
Ordering data – Sub-base valves						
	Code	Valve function	Electrical plug-in connection		Electrical horizontal connection	
			Part No.	Type	Part No.	Type
	M	5/2-way valve, single solenoid	526990	CPASC1-M1H-M-P-2,5	527008	CPASC1-M1H-M-H-2,5
	J	5/2-way valve, double solenoid	526992	CPASC1-M1H-J-P-2,5	527010	CPASC1-M1H-J-H-2,5
	N	2x 3/2-way valve, normally open	526994	CPASC1-M1H-N-P-2,5	527012	CPASC1-M1H-N-H-2,5
	K	2x 3/2-way valve, normally closed	526996	CPASC1-M1H-K-P-2,5	527014	CPASC1-M1H-K-H-2,5
	B	5/3-way valve, mid-position pressurised	526998	CPASC1-M1H-B-P-2,5	527016	CPASC1-M1H-B-H-2,5
	G	5/3-way valve, mid-position closed	527000	CPASC1-M1H-G-P-2,5	527018	CPASC1-M1H-G-H-2,5
	E	5/3-way valve, mid-position exhausted	527002	CPASC1-M1H-E-P-2,5	527020	CPASC1-M1H-E-H-2,5
	X	1x 3/2-way valve	527004	CPASC1-M1H-X-P-2,5	527022	CPASC1-M1H-X-H-2,5
	I	2x 2/2-way valve	527006	CPASC1-M1H-I-P-2,5	527024	CPASC1-M1H-I-H-2,5

Ordering data – Semi in-line valves							
	Code	Valve function	Electrical plug-in connection		Electrical horizontal connection		
			Part No.	Type	Part No.	Type	
	Semi in-line valve with M5 working ports						
	M	5/2-way valve, single solenoid	527294	CPPSC1-M1H-M-P-M5	527303	CPPSC1-M1H-M-H-M5	
	J	5/2-way valve, double solenoid	527295	CPPSC1-M1H-J-P-M5	527304	CPPSC1-M1H-J-H-M5	
	N	2x 3/2-way valve, normally open	527296	CPPSC1-M1H-N-P-M5	527305	CPPSC1-M1H-N-H-M5	
	K	2x 3/2-way valve, normally closed	527297	CPPSC1-M1H-K-P-M5	527306	CPPSC1-M1H-K-H-M5	
	B	5/3-way valve, mid-position pressurised	527298	CPPSC1-M1H-B-P-M5	527307	CPPSC1-M1H-B-H-M5	
	G	5/3-way valve, mid-position closed	527299	CPPSC1-M1H-G-P-M5	527308	CPPSC1-M1H-G-H-M5	
	E	5/3-way valve, mid-position exhausted	527300	CPPSC1-M1H-E-P-M5	527309	CPPSC1-M1H-E-H-M5	
	X	1x 3/2-way valve	527301	CPPSC1-M1H-X-P-M5	527310	CPPSC1-M1H-X-H-M5	
	I	2x 2/2-way valve	527302	CPPSC1-M1H-I-P-M5	527311	CPPSC1-M1H-I-H-M5	
	Semi in-line valve with QS-3 working ports						
	M	5/2-way valve, single solenoid	527330	CPPSC1-M1H-M-P-Q3	527339	CPPSC1-M1H-M-H-Q3	
	J	5/2-way valve, double solenoid	527331	CPPSC1-M1H-J-P-Q3	527340	CPPSC1-M1H-J-H-Q3	
	N	2x 3/2-way valve, normally open	527332	CPPSC1-M1H-N-P-Q3	527341	CPPSC1-M1H-N-H-Q3	
	K	2x 3/2-way valve, normally closed	527333	CPPSC1-M1H-K-P-Q3	527342	CPPSC1-M1H-K-H-Q3	
	B	5/3-way valve, mid-position pressurised	527334	CPPSC1-M1H-B-P-Q3	527343	CPPSC1-M1H-B-H-Q3	
	G	5/3-way valve, mid-position closed	527335	CPPSC1-M1H-G-P-Q3	527344	CPPSC1-M1H-G-H-Q3	
	E	5/3-way valve, mid-position exhausted	527336	CPPSC1-M1H-E-P-Q3	527345	CPPSC1-M1H-E-H-Q3	
	X	1x 3/2-way valve	527337	CPPSC1-M1H-X-P-Q3	527346	CPPSC1-M1H-X-H-Q3	
	I	2x 2/2-way valve	527338	CPPSC1-M1H-I-P-Q3	527347	CPPSC1-M1H-I-H-Q3	

Valve terminals CPA-SC, Smart Cubic

Ordering data – Individual valve, manifold block

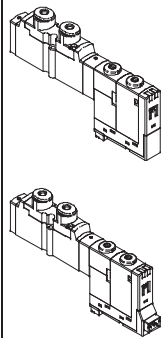
Ordering data – Semi in-line valves						
	Code	Valve function	Electrical plug-in connection		Electrical horizontal connection	
			Part No.	Type	Part No.	Type
	Semi in-line valve with QS-4 working ports					
	M	5/2-way valve, single solenoid	527312	CPPSC1-M1H-M-P-Q4	527321	CPPSC1-M1H-M-H-Q4
	J	5/2-way valve, double solenoid	527313	CPPSC1-M1H-J-P-Q4	527322	CPPSC1-M1H-J-H-Q4
	N	2x 3/2-way valve, normally open	527314	CPPSC1-M1H-N-P-Q4	527323	CPPSC1-M1H-N-H-Q4
	K	2x 3/2-way valve, normally closed	527315	CPPSC1-M1H-K-P-Q4	527324	CPPSC1-M1H-K-H-Q4
	B	5/3-way valve, mid-position pressurised	527316	CPPSC1-M1H-B-P-Q4	527325	CPPSC1-M1H-B-H-Q4
	G	5/3-way valve, mid-position closed	527317	CPPSC1-M1H-G-P-Q4	527326	CPPSC1-M1H-G-H-Q4
	E	5/3-way valve, mid-position exhausted	527318	CPPSC1-M1H-E-P-Q4	527327	CPPSC1-M1H-E-H-Q4
	X	1x 3/2-way valve	527319	CPPSC1-M1H-X-P-Q4	527328	CPPSC1-M1H-X-H-Q4
	I	2x 2/2-way valve	527320	CPPSC1-M1H-I-P-Q4	527329	CPPSC1-M1H-I-H-Q4

Note

Manifold blocks with multi-pin plug or fieldbus connection can only be equipped with valves with electrical plug-in connection.

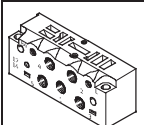
Ordering data – Individual sub-base			
	With internal pilot air supply		527384 CPPSC1-PRS-1-5-HC
	With external pilot air supply		527388 CPPSC1-PRS-1-5S-HC

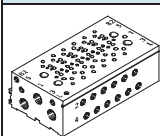
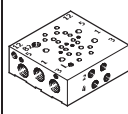
Ordering data – Manifold block for sub-base valves					
	Valve positions	Internal pilot air supply		External pilot air supply	
		Part No.	Type	Part No.	Type
Individual plug-in connection					
	2	527106	CPASC1-PRS-2-5-M5-PI	527218	CPASC1-PRS-2-5S-M5-PI
	4	527108	CPASC1-PRS-4-5-M5-PI	527220	CPASC1-PRS-4-5S-M5-PI
	6	527110	CPASC1-PRS-6-5-M5-PI	527222	CPASC1-PRS-6-5S-M5-PI
	8	527112	CPASC1-PRS-8-5-M5-PI	527224	CPASC1-PRS-8-5S-M5-PI
	10	527114	CPASC1-PRS-10-5-M5-PI	527226	CPASC1-PRS-10-5S-M5-PI
	12	527116	CPASC1-PRS-12-5-M5-PI	527228	CPASC1-PRS-12-5S-M5-PI
	16	527118	CPASC1-PRS-16-5-M5-PI	527230	CPASC1-PRS-16-5S-M5-PI
Individual horizontal connection					
	2	527078	CPASC1PRS-2-5-M5-HC	527190	CPASC1PRS-2-5S-M5-HC
	4	527080	CPASC1PRS-4-5-M5-HC	527192	CPASC1PRS-4-5S-M5-HC
	6	527082	CPASC1PRS-6-5-M5-HC	527194	CPASC1PRS-6-5S-M5-HC
	8	527084	CPASC1PRS-8-5-M5-HC	527196	CPASC1PRS-8-5S-M5-HC
	10	527086	CPASC1PRS-10-5-M5-HC	527198	CPASC1PRS-10-5S-M5-HC
	12	527088	CPASC1PRS-12-5-M5-HC	527200	CPASC1PRS-12-5S-M5-HC
	16	527090	CPASC1PRS-16-5-M5-HC	527202	CPASC1PRS-16-5S-M5-HC

Valve terminals CPA-SC, Smart Cubic

Ordering data – Individual valve, manifold block

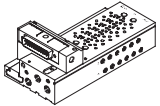
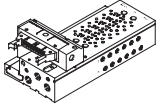
Ordering data – Manifold block for sub-base valves					
	Valve positions	Internal pilot air supply		External pilot air supply	
		Part No.	Type	Part No.	Type
Multi-pin plug connection, Sub-D					
	2	539898	CPASC1-PRS-2-5-M5-MP	539896	CPASC1-PRS-2-5S-M5-MP
	4	527134	CPASC1-PRS-4-5-M5-MP	527246	CPASC1-PRS-4-5S-M5-MP
	6	527136	CPASC1-PRS-6-5-M5-MP	527248	CPASC1-PRS-6-5S-M5-MP
	8	527138	CPASC1-PRS-8-5-M5-MP	527250	CPASC1-PRS-8-5S-M5-MP
	10	527140	CPASC1-PRS-10-5-M5-MP	527252	CPASC1-PRS-10-5S-M5-MP
	12	527142	CPASC1-PRS-12-5-M5-MP	527254	CPASC1-PRS-12-5S-M5-MP
	16	527144	CPASC1-PRS-16-5-M5-MP	527256	CPASC1-PRS-16-5S-M5-MP
	20	527146	CPASC1-PRS-20-5-M5-MP	527258	CPASC1-PRS-20-5S-M5-MP
Multi-pin plug connection, flat cable					
	4	527162	CPASC1-PRS-4-5-M5-FL	527274	CPASC1-PRS-4-5S-M5-FL
	6	527164	CPASC1-PRS-6-5-M5-FL	527276	CPASC1-PRS-6-5S-M5-FL
	8	527166	CPASC1-PRS-8-5-M5-FL	527278	CPASC1-PRS-8-5S-M5-FL
	10	527168	CPASC1-PRS-10-5-M5-FL	527280	CPASC1-PRS-10-5S-M5-FL
	12	527170	CPASC1-PRS-12-5-M5-FL	527282	CPASC1-PRS-12-5S-M5-FL
	16	527172	CPASC1-PRS-16-5-M5-FL	527284	CPASC1-PRS-16-5S-M5-FL
	20	527174	CPASC1-PRS-20-5-M5-FL	527286	CPASC1-PRS-20-5S-M5-FL

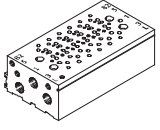
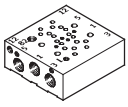
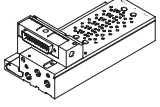



Ordering data – Manifold block for semi in-line valves					
	Valve positions	Internal pilot air supply		External pilot air supply	
		Part No.	Type	Part No.	Type
Individual plug-in connection					
	2	527092	CPPSC1-PRS-2-5-PI	527204	CPPSC1-PRS-2-5S-PI
	4	527094	CPPSC1-PRS-4-5-PI	527206	CPPSC1-PRS-4-5S-PI
	6	527096	CPPSC1-PRS-6-5-PI	527208	CPPSC1-PRS-6-5S-PI
	8	527098	CPPSC1-PRS-8-5-PI	527210	CPPSC1-PRS-8-5S-PI
	10	527100	CPPSC1-PRS-10-5-PI	527212	CPPSC1-PRS-10-5S-PI
	12	527102	CPPSC1-PRS-12-5-PI	527214	CPPSC1-PRS-12-5S-PI
	16	527104	CPPSC1-PRS-16-5-PI	527216	CPPSC1-PRS-16-5S-PI
Individual horizontal connection					
	2	527064	CPPSC1PRS-2-5-HC	527176	CPPSC1PRS-2-5S-HC
	4	527066	CPPSC1PRS-4-5-HC	527178	CPPSC1PRS-4-5S-HC
	6	527068	CPPSC1PRS-6-5-HC	527180	CPPSC1PRS-6-5S-HC
	8	527070	CPPSC1PRS-8-5-HC	527182	CPPSC1PRS-8-5S-HC
	10	527072	CPPSC1PRS-10-5-HC	527184	CPPSC1PRS-10-5S-HC
	12	527074	CPPSC1PRS-12-5-HC	527186	CPPSC1PRS-12-5S-HC
	16	527076	CPPSC1PRS-16-5-HC	527188	CPPSC1PRS-16-5S-HC
Multi-pin plug connection, Sub-D					
	2	539902	CPPSC1-PRS-2-5-MP	539900	CPPSC1-PRS-2-5S-MP
	4	527120	CPPSC1-PRS-4-5-MP	527232	CPPSC1-PRS-4-5S-MP
	6	527122	CPPSC1-PRS-6-5-MP	527234	CPPSC1-PRS-6-5S-MP
	8	527124	CPPSC1-PRS-8-5-MP	527236	CPPSC1-PRS-8-5S-MP
	10	527126	CPPSC1-PRS-10-5-MP	527238	CPPSC1-PRS-10-5S-MP
	12	527128	CPPSC1-PRS-12-5-MP	527240	CPPSC1-PRS-12-5S-MP
	16	527130	CPPSC1-PRS-16-5-MP	527242	CPPSC1-PRS-16-5S-MP
	20	527132	CPPSC1-PRS-20-5-MP	527244	CPPSC1-PRS-20-5S-MP

Valve terminals CPA-SC, Smart Cubic

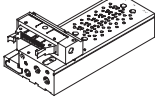
Ordering data – Accessories

FESTO

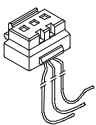
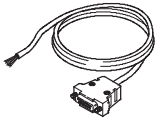
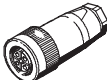



Ordering data – Manifold block for semi in-line valves				
	Valve positions	Internal pilot air supply		External pilot air supply
		Part No.	Type	Part No. Type
Multi-pin plug connection, flat cable				
	4	527148	CPPSC1-PRS-4-5-FL	527260 CPPSC1-PRS-4-5S-FL
	6	527150	CPPSC1-PRS-6-5-FL	527262 CPPSC1-PRS-6-5S-FL
	8	527152	CPPSC1-PRS-8-5-FL	527264 CPPSC1-PRS-8-5S-FL
	10	527154	CPPSC1-PRS-10-5-FL	527266 CPPSC1-PRS-10-5S-FL
	12	527156	CPPSC1-PRS-12-5-FL	527268 CPPSC1-PRS-12-5S-FL
	16	527158	CPPSC1-PRS-16-5-FL	527270 CPPSC1-PRS-16-5S-FL
	20	527160	CPPSC1-PRS-20-5-FL	527272 CPPSC1-PRS-20-5S-FL

Ordering data – Accessories				
Designation			Part No.	Type
Soldering base for plug-in connection				
	3-pin	Scope of delivery 10 pieces	539904	PCBC-B-10
	3-pin	Scope of delivery 100 pieces	539905	PCBC-B-100
Plug socket with cable for plug-in connection				
	For 1 coil	0.5 m	197260	MHAP-PI
		1 m	532182	MHAP-PI-1
	For 2 coils	0.5 m	529116	MHAP-PI-D-0,5
		1 m	527395	MHAP-PI-D-1
Plug socket with cable for horizontal connection				
	For 1 coil, 2-wire	0.5 m	197263	KMH-0,5
		1 m	197264	KMH-1
		2.5 m	527400	KMH-2,5
		5 m	527401	KMH-5
	For 2 coils, 3-wire	0.5 m	527396	KMH-D-0,5
		1 m	527397	KMH-D-1
		2.5 m	527398	KMH-D-2,5
		5 m	527399	KMH-D-5
Connecting cable to IP40				
	Sub-D, 25-pin, up to 20 coils	2.5 m	530046	KMP6-25P-20-2,5
		5 m	530047	KMP6-25P-20-5
		10 m	530048	KMP6-25P-20-10
	Sub-D, 25-pin, up to 12 coils	2.5 m	530049	KMP6-25P-12-2,5
		5 m	530050	KMP6-25P-12-5
		10 m	530051	KMP6-25P-12-10
Powering supply				
	MicroStyle M12, 5-pin socket (B-coded) for DeviceNet	for 0.75 mm ²	538999	NTSD-GD-9-M12-5POL-RK
	M12, 5-pin socket (A-coded) for Profibus DP	for 0.75 mm ²	18324	FBSD-GD-9-5POL

Valve terminals CPA-SC, Smart Cubic

FESTO



Ordering data – Accessories

Ordering data – Accessories			
Designation		Part No.	Type
Fieldbus connection			
	Plug to IP65, M12, 5-pin, PG9 for DeviceNet	for 0.75 mm ²	175380 FBS-M12-5GS-PG9
	Fieldbus socket for MicroStyle connection, M12, 5-pin socket (A-coded) for DeviceNet	for 0.75 mm ²	18324 FBSD-GD-9-5POL
Adapter			
	T-adapter, 5-pin, for DH-485/DeviceNet	–	171175 FB-TA-M12-5POL
Valve terminal connection			
	Connecting cable WS-WD, angled plug-angled socket	0.25 m	540327 KVI-CP-3-WS-WD-0,25
		0.5 m	540328 KVI-CP-3-WS-WD-0,5
		2 m	540329 KVI-CP-3-WS-WD-2
		5 m	540330 KVI-CP-3-WS-WD-5
		8 m	540331 KVI-CP-3-WS-WD-8
	Connecting cable GS-GD, straight plug-straight socket	2 m	540332 KVI-CP-3-GS-GD-2
		5 m	540333 KVI-CP-3-GS-GD-5
		8 m	540334 KVI-CP-3-GS-GD-8

Valve terminals CPA-SC, Smart Cubic

Accessories

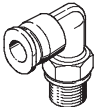

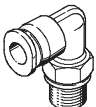







FESTO

Ordering data – Accessories				
Designation			Part No.	Type
Push-in fitting for working ports				
	Connecting thread M5 for tubing O.D.	3 mm	153302	QSM-M5-3
		4 mm	153304	QSM-M5-4
		3 mm	153313	QSM-M5-3-I
		4 mm	153315	QSM-M5-4-I
Push-in L-fitting for working ports				
	Connecting thread M5 for tubing O.D.	3 mm	153331	QSML-M5-3
		4 mm	153333	QSML-M5-4
		6 mm	153335	QSML-M5-6
		4 mm	153339	QSMLL-M5-4
		6 mm	153341	QSMLL-M5-6
Push-in fitting for manifold block				
	Connecting thread M3 for tubing O.D.	3 mm	153301	QSM-M3-3
		4 mm	153303	QSM-M3-4
		3 mm	153312	QSM-M3-3-I
		4 mm	153314	QSM-M3-4-I
	Connecting thread M5 for tubing O.D.	3 mm	153302	QSM-M5-3
		4 mm	153304	QSM-M5-4
		6 mm	153306	QSM-M5-6
		3 mm	153313	QSM-M5-3-I
		4 mm	153315	QSM-M5-4-I
		6 mm	153317	QSM-M5-6-I
	Connecting thread G $\frac{1}{8}$ for tubing O.D.	4 mm	186266	QSM-G $\frac{1}{8}$ -4-I
		6 mm	186267	QSM-G $\frac{1}{8}$ -6-I
		8 mm	186109	QS-G $\frac{1}{8}$ -8-I
	Connecting thread R $\frac{1}{8}$ for tubing O.D.	4 mm	153305	QSM- $\frac{1}{8}$ -4
		6 mm	153307	QSM- $\frac{1}{8}$ -6
		4 mm	153316	QSM- $\frac{1}{8}$ -4-I
6 mm		153318	QSM- $\frac{1}{8}$ -6-I	
Push-in L-fitting for manifold block				
	Connecting thread M3 for tubing O.D.	3 mm	153330	QSML-M3-3
		4 mm	153332	QSML-M3-4
		3 mm	153337	QSMLL-M3-3
		4 mm	153338	QSMLL-M3-4
	Connecting thread M5 for tubing O.D.	3 mm	153331	QSML-M5-3
		4 mm	153333	QSML-M5-4
		6 mm	153335	QSML-M5-6
		4 mm	153339	QSMLL-M5-4
		6 mm	153341	QSMLL-M5-6
		Connecting thread R $\frac{1}{8}$ for tubing O.D.	4 mm	153334
	6 mm		153336	QSML- $\frac{1}{8}$ -6
	4 mm		153340	QSMLL- $\frac{1}{8}$ -4
6 mm	153342		QSMLL- $\frac{1}{8}$ -6	

Valve terminals CPA-SC, Smart Cubic

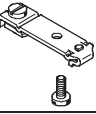
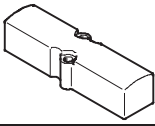
FESTO

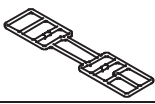
Accessories

Ordering data – Accessories				
Designation			Part No.	Type
Silencer				
	Connecting thread	M3	163978	U-M3
		M5	4645	U-M5
		M5	165003	UC-M5
		G $\frac{1}{8}$	161419	UC- $\frac{1}{8}$
	Push-in sleeve connection	3 mm	165005	UC-QS-3H
		4 mm	165006	UC-QS-4H
		6 mm	165007	UC-QS-6H
		8 mm	175611	UC-QS-8H
Blanking plug				
	Thread M5		3843	B-M5
	Thread M5		174308	B-M5-B
	Thread G $\frac{1}{8}$		3568	B- $\frac{1}{8}$
	Blanking plug for tubing O.D.	4 mm	153267	QSC-4H
		6 mm	153268	QSC-6H
		8 mm	153269	QSC-8H
		3 mm	153382	QSMC-3H
Inscription labels				
	6x10 in frames, 64 pieces for valve identification		18576	IBS-6x10
	4.5x9 mm, 80 pieces for manifold block identification		197259	MH-BZ-80x
Mounting				
	For H-rail		527392	CPASC1-BG-NRH
Blanking plate				
	Cover for vacant position ¹⁾		527062	CPASC1-RP
	Cover for manual override, covered (10 pieces)		540898	VMPA-HBV-B
Valve seal				
	For manifold block		527394	CPASC1-SEAL-A
Separator and assembly tool				
	Separator		536942	CPASC1-KT
	Assembly tool for separator		536943	CPASC1-MWKT

1) A self-adhesive label is supplied.

Valve terminals CPA-SC, Smart Cubic

Accessories

FESTO

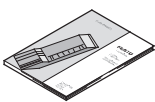
Ordering data – Accessories				
Designation			Part No.	Type
User documentation				
	User documentation – CPA-SC	German	530932	P.BE-CPASC-DE
		English	530933	P.BE-CPASC-EN
		French	530934	P.BE-CPASC-FR
		Spanish	530935	P.BE-CPASC-ES
		Italian	530936	P.BE-CPASC-IT
		Swedish	530937	P.BE-CPASC-SV
	User documentation – DeviceNet fieldbus	German	539008	P.BE-CPASC-CPVSC-DN-DE
		English	539009	P.BE-CPASC-CPVSC-DN-EN
		French	539010	P.BE-CPASC-CPVSC-DN-FR
		Spanish	539011	P.BE-CPASC-CPVSC-DN-ES
		Italian	539012	P.BE-CPASC-CPVSC-DN-IT
		Swedish	539013	P.BE-CPASC-CPVSC-DN-SV
	User documentation – Profibus DP fieldbus	German	548725	P.BE-CPASC-CPVSC-DP-DE
		English	548726	P.BE-CPASC-CPVSC-DP-EN
		French	548728	P.BE-CPASC-CPVSC-DP-FR
		Spanish	548727	P.BE-CPASC-CPVSC-DP-ES
		Italian	548729	P.BE-CPASC-CPVSC-DP-IT
		Swedish	548730	P.BE-CPASC-CPVSC-DP-SV

Product Range and Company Overview

A Complete Suite of Automation Services

Our experienced engineers provide complete support at every stage of your development process, including: conceptualization, analysis, engineering, design, assembly, documentation, validation, and production.



Custom Automation Components
Complete custom engineered solutions



Custom Control Cabinets
Comprehensive engineering support and on-site services

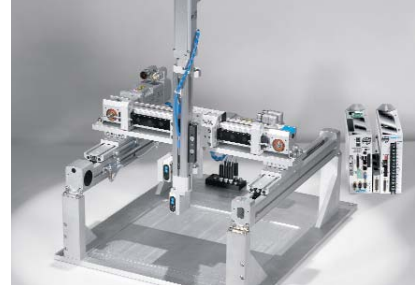

Complete Systems
Shipment, stocking and storage services

The Broadest Range of Automation Components

With a comprehensive line of more than 30,000 automation components, Festo is capable of solving the most complex automation requirements.



Electromechanical
Electromechanical actuators, motors, controllers & drives



Pneumatics
Pneumatic linear and rotary actuators, valves, and air supply



PLCs and I/O Devices
PLC's, operator interfaces, sensors and I/O devices

Supporting Advanced Automation... As No One Else Can!

Festo is a leading global manufacturer of pneumatic and electromechanical systems, components and controls for industrial automation, with more than 12,000 employees in 56 national headquarters serving more than 180 countries. For more than 80 years, Festo has continuously elevated the state of manufacturing with innovations and optimized motion control solutions that deliver higher performing, more profitable automated manufacturing and processing equipment. Our dedication to the advancement of automation extends beyond technology to the education and development of current and future automation and robotics designers with simulation tools, teaching programs, and on-site services.

Quality Assurance, ISO 9001 and ISO 14001 Certifications

Festo Corporation is committed to supply all Festo products and services that will meet or exceed our customers' requirements in product quality, delivery, customer service and satisfaction.

To meet this commitment, we strive to ensure a consistent, integrated, and systematic approach to management that will meet or exceed the requirements of the ISO 9001 standard for Quality Management and the ISO 14001 standard for Environmental Management.



© Copyright 2008, Festo Corporation. While every effort is made to ensure that all dimensions and specifications are correct, Festo cannot guarantee that publications are completely free of any error, in particular typing or printing errors. Accordingly, Festo cannot be held responsible for the same. For Liability and Warranty conditions, refer to our "Terms and Conditions of Sale", available from your local Festo office. All rights reserved. No part of this publication may be reproduced, distributed, or transmitted in any form or by any means, electronic, mechanical, photocopying or otherwise, without the prior written permission of Festo. All technical data subject to change according to technical update.



Printed on recycled paper at New Horizon Graphic, Inc., FSC certified as an environmentally friendly printing plant.

Festo North America

Festo Regional Contact Center

5300 Explorer Drive
Mississauga, Ontario L4W 5G4
Canada

USA Customers:

For ordering assistance,

Call: 1.800.99.FESTO (1.800.993.3786)

Fax: 1.800.96.FESTO (1.800.963.3786)

Email: customer.service@us.festo.com

For technical support,

Call: 1.866.GO.FESTO (1.866.463.3786)

Fax: 1.800.96.FESTO (1.800.963.3786)

Email: product.support@us.festo.com

Canadian Customers:

Call: 1.877.GO.FESTO (1.877.463.3786)

Fax: 1.877.FX.FESTO (1.877.393.3786)

Email: festo.canada@ca.festo.com

USA Headquarters

Festo Corporation
395 Moreland Road
P.O. Box 18023
Hauppauge, NY 11788, USA
www.festo.com/us

USA Sales Offices

Appleton

North 922 Tower View Drive, Suite N
Greenville, WI 54942, USA

Boston

120 Presidential Way, Suite 330
Woburn, MA 01801, USA

Chicago

1441 East Business Center Drive
Mt. Prospect, IL 60056, USA

Dallas

1825 Lakeway Drive, Suite 600
Lewisville, TX 75057, USA

Detroit – Automotive Engineering Center

2601 Cambridge Court, Suite 320
Auburn Hills, MI 48326, USA

New York

395 Moreland Road
Hauppauge, NY 11788, USA

Silicon Valley

4935 Southfront Road, Suite F
Livermore, CA 94550, USA

United States



USA Headquarters, East: Festo Corp., 395 Moreland Road, Hauppauge, NY 11788

Phone: 1.631.435.0800; Fax: 1.631.435.8026;

Email: info@festo-usa.com

www.festo.com/us

Canada



Headquarters: Festo Inc., 5300 Explorer Drive, Mississauga, Ontario L4W 5G4

Phone: 1.905.624.9000; Fax: 1.905.624.9001;

Email: festo.canada@ca.festo.com

www.festo.ca

Mexico



Headquarters: Festo Pneumatic, S.A., Av. Ceylán 3, Col. Tequesquahuac,
54020 Tlalneantla, Edo. de México

Phone: 011 52 [55] 53 21 66 00; Fax: 011 52 [55] 53 21 66 65;

Email: festo.mexico@mx.festo.com

www.festo.com/mx

Central USA

Festo Corporation
1441 East Business
Center Drive
Mt. Prospect, IL 60056, USA
Phone: 1.847.759.2600
Fax: 1.847.768.9480



Western USA

Festo Corporation
4935 Southfront Road,
Suite F
Livermore, CA 94550, USA
Phone: 1.925.371.1099
Fax: 1.925.245.1286



Festo Worldwide

Argentina Australia Austria Belarus Belgium Brazil Bulgaria Canada Chile China Colombia Croatia Czech Republic Denmark
Estonia Finland France Germany Great Britain Greece Hong Kong Hungary India Indonesia Iran Ireland Israel Italy Japan Latvia
Lithuania Malaysia Mexico Netherlands New Zealand Norway Peru Philippines Poland Romania Russia Serbia Singapore
Slovakia Slovenia South Africa South Korea Spain Sweden Switzerland Taiwan Thailand Turkey Ukraine United States Venezuela

www.festo.com