

Valve terminals MPA-L

FESTO



Valve terminals MPA-L

Key features

FESTO

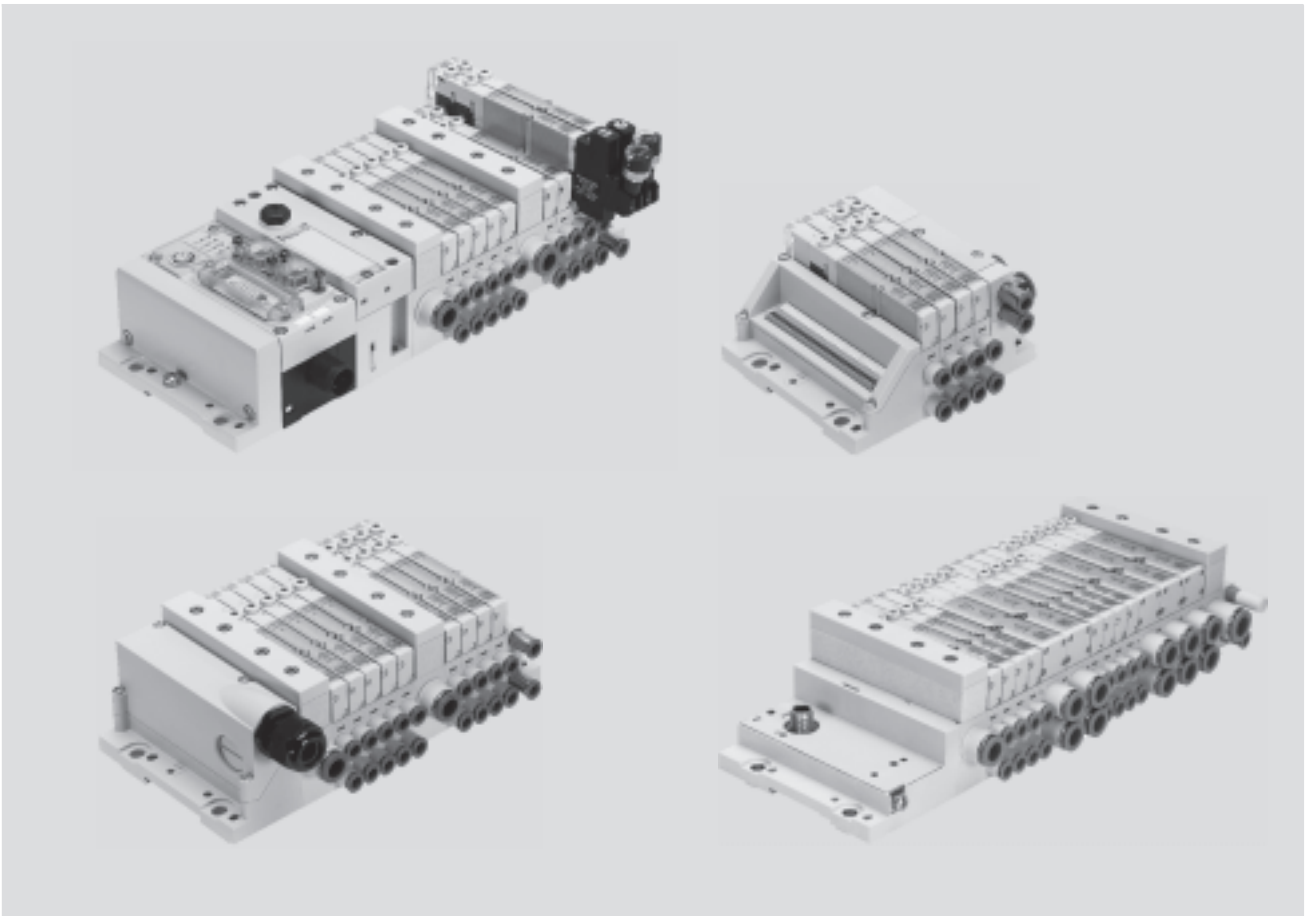

Innovative

- Compact, high-performance valves in a sturdy metal housing
- Flow rates up to 870 l/min
- Wide range of electrical connection options for multi-pin plug: Sub-D, flat cable or terminal strip
- Connection to the electrical peripherals CPX with a wide range of communication options
- I-Port/IO-Link interface
- Freely configurable push-in connectors

Versatile

- Modular system offering a range of configuration options
- Freely extendable system with individual sub-bases and modular tie rods
- Up to 32 solenoid coils
- Conversions and extensions possible at a later date
- Air supply can be extended by additional pressure zones via supply modules
- Wide range of pressures –0.9 ... 10 bar
- Wide range of valve functions

Reliable

- High output reserves thanks to large pneumatic cross sections and venting with high flow rates
- Resilient thanks to high mechanical rigidity
- Lightweight and low-cost polymer components
- Fast troubleshooting thanks to LEDs on the valves
- Easy to service thanks to replaceable valves and electronic modules
- Manual override either non-detenting, detenting or secured against unauthorised activation (covered)
- Durable thanks to tried-and-tested piston spool valves

Easy to assemble

- Fast and reliable in-house assembly using individual components or delivered as a ready-to-install and tested unit
- Lower selection, ordering, installation and commissioning costs
- Secure mounting on wall or H-rail

Valve terminals MPA-L

Key features

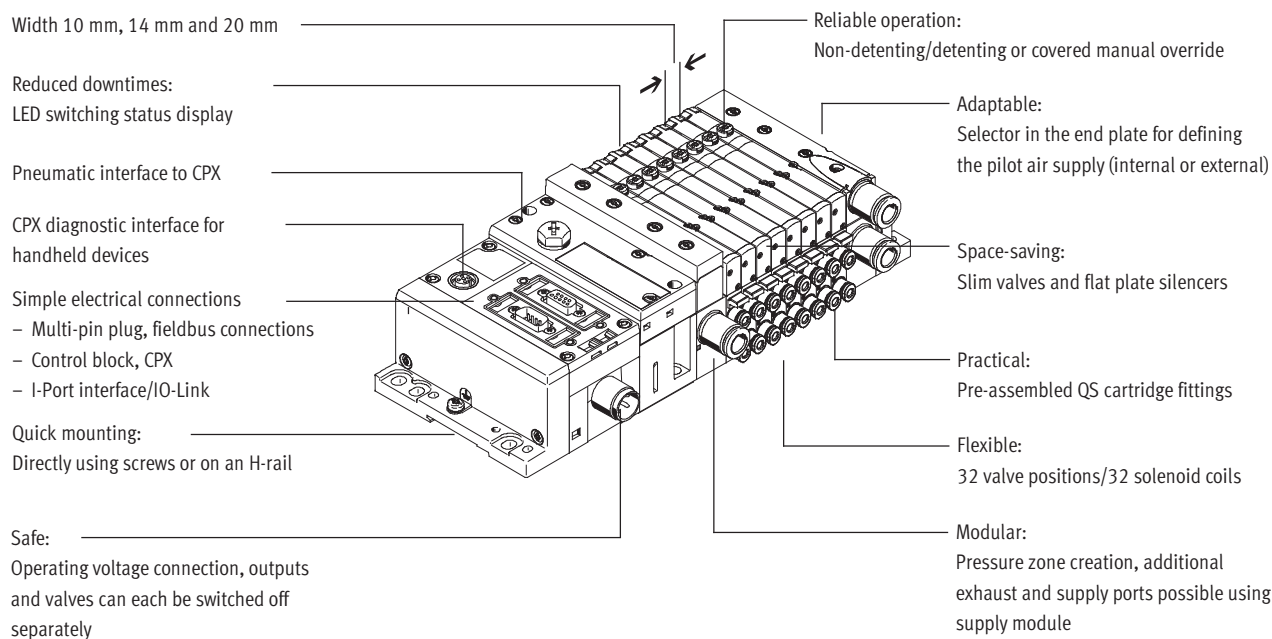

Equipment options

Valve functions

- | | | | |
|--|--|---|--|
| <ul style="list-style-type: none"> • 5/2-way valve, single solenoid • 5/2-way valve, double solenoid • 2x 3/2-way valve, normally open • 2x 3/2-way valve, normally closed • 2x 3/2-way valve, 1x normally open, 1x normally closed | <ul style="list-style-type: none"> • 5/3-way valve, mid-position pressurised • 5/3-way valve, mid-position closed • 5/3-way valve, mid-position exhausted • 2x 2/2-way valve, 1x normally closed, 1x normally closed, reversible | <ul style="list-style-type: none"> • 2x 2/2-way valve, normally closed • 1x 3/2-way valve, normally closed, external compressed air supply • 1x 3/2-way valve, normally open, external compressed air supply • Manual pressure regulators | <p>All valves have the same compact dimensions with an overall length of 107 mm and a height of 55 mm.</p> |
|--|--|---|--|

Special features

- | | | | |
|---|---|---|--|
| <ul style="list-style-type: none"> • Max. 32 valve positions/max. 32 solenoid coils • Parallel, modular valve linking • Electrical interlinking with | <ul style="list-style-type: none"> • integrated holding current reduction • Any compressed air supply (max. 8 supply modules) | <ul style="list-style-type: none"> • Creation of pressure zones • Modular, individually extendable tie rods • Single valves or combinations of four valves | <ul style="list-style-type: none"> • Tubing size at each connection freely selectable |
|---|---|---|--|

Valve terminal selection

Online via: → www.festo.com/us/engineering

Valve terminal configurator

2D/3D CAD data

The appropriate MPA-L valve terminal can be chosen quickly and easily using the online catalogue. This includes a convenient valve terminal configurator, which makes it much simpler to order the right product.

The valve terminals are fully assembled according to your order specification and are individually tested. This reduces assembly and installation time to a minimum.

You order a valve terminal MPA-L using the order code.

Ordering system for MPA-L

→ Internet: mpal

Ordering system for CPX

→ Internet: cpx

Ordering system for CTEU

→ Internet: cteu

You can request the CAD data for a valve terminal you have configured. To do so, start the product search as described above. Go to the shopping basket and click on the CAD icon (compass). On the next page you can generate a 3D preview or request another data format of your choice by e-mail.

Valve terminals MPA-L

Key features

FESTO

Multi-pin plug connection

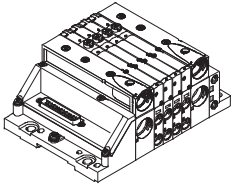

The signal flow from the controller to the valve terminal takes place via a pre-assembled or self-assembled multi-wire cable to the multi-pin plug connection, which substantially reduces installation time.

The valve terminal can be equipped with max. 32 solenoid coils. This corresponds to 2 to 32 valves.

Versions

- Sub-D connection
 - Pre-assembled multi-pin cable
 - Multi-pin cable for self-assembly
- Flat cable connection
- Terminal strip connection

Fieldbus connection via the CPX system

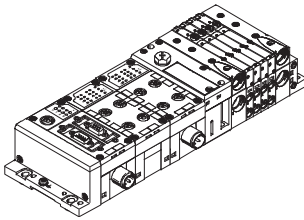

An integrated fieldbus node manages communication with a higher-order PLC. This enables a space-saving pneumatic and electronic solution. Valve terminals with fieldbus interfaces can be configured with up to 32 sub-bases.

The CPX terminal also enables the integration of digital and analogue electrical inputs and outputs, pressure sensors and controllers for pneumatic or electric positioning axes.

A detailed description of the extensive functionality can be found in the documentation for the CPX terminal
➔ Internet: [cpx](http://www.festo.com/cpx)

Fieldbus protocols/CPX variants:

- PROFIBUS DP
- PROFINET
- INTERBUS
- DeviceNet
- CANopen
- CC-Link
- EtherNet/IP
- Front End Controller Remote I/O
- Modbus/TCP
- EtherCAT

Control block connection via the CPX system

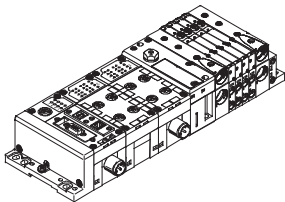

Controllers integrated in the Festo valve terminals enable the construction of stand-alone control units to IP65, without control cabinets.

In the slave operating mode, these valve terminals can be used for intelligent preprocessing and are therefore ideal modules for designing decentralised intelligence.

In the master operating mode, terminal groups can be designed with many options and functions that can autonomously control a medium-sized machine/system.

Fieldbus connection via the CTEU system

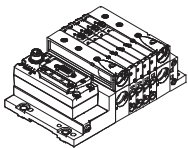

Communication with a higher-level PLC is managed by a fieldbus node mounted directly on the I-Port interface.

Valve terminals with an I-Port interface can be configured with up to 32 sub-bases.

A detailed description of the extensive functionality can be found in the documentation for the fieldbus modules CTEU/installation system CTEL

➔ Internet: [cteu](http://www.festo.com/cteu)

Fieldbus protocols:

- PROFIBUS DP
- DeviceNet
- CANopen
- CC-Link
- EtherCAT

I-Port interface/IO-Link

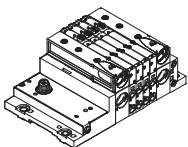

I-Port/IO-Link consists of a central master and the devices with I-Port interface/IO-Link connected via special connecting cables. This permits a decentralised layout of the devices.

The connection type corresponds to a star topology.

In other words, only one module or valve terminal can be connected to each I-Port.

The I-Port interface from Festo is based on IO-Link and is compatible with IO-Link in certain areas.

As well as communication, the I-Port interfaces also handle the power supply for the connected devices. The maximum length of a string is 20 m.

Valve terminals MPA-L

Peripherals overview

Modular pneumatic components

The modular design of the MPA-L facilitates maximum flexibility right from the planning stage and offers maximum ease of servicing during operation.

The system consists of sub-bases and valves.

The sub-bases form the support system for the valves. They contain the connection ducts for supplying compressed air to and venting from the valve terminal as well as the working lines for the pneumatic drives for each valve.

The sub-bases are joined together via a tie rod system. This consists of a threaded rod, threaded sleeve and screw. The threaded rod/sleeve combination is selected as appropriate to the chosen number of individual sub-bases.

A valve terminal can be easily extended by adding individual sub-bases or supply modules. This is done by inserting suitable tie rod extenders between the threaded rod and sleeve. This ensures that the valve terminal can be rapidly and reliably extended.

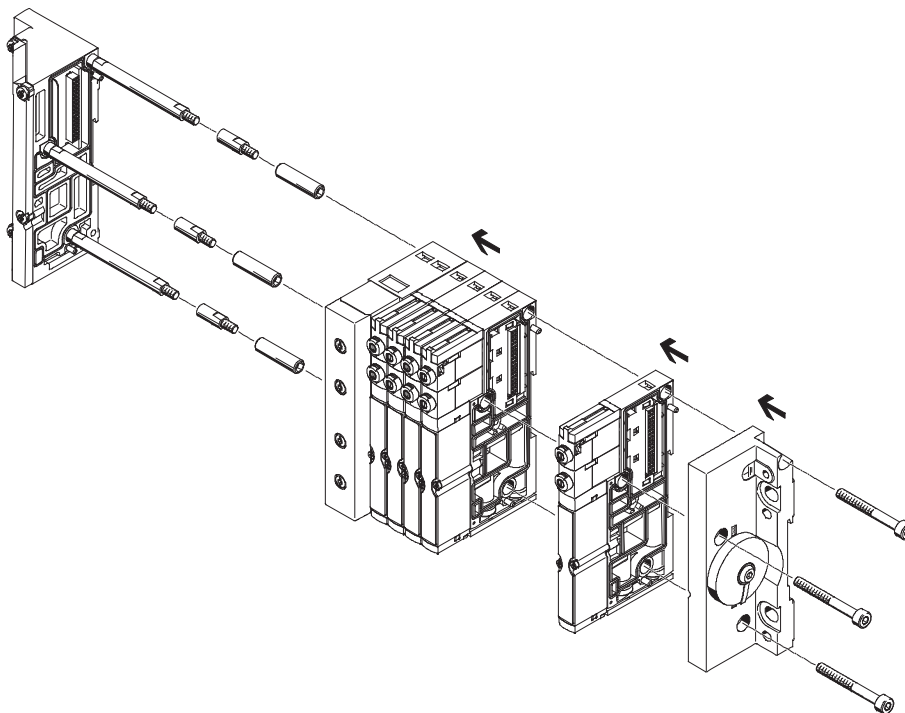

Note

The tie rod system for the valve terminal MPA-L consists of at least four sub-bases or two sub-bases and one supply module. Shorter valve terminals with two or more valve positions can be constructed without a sleeve.

Modular electrical peripherals

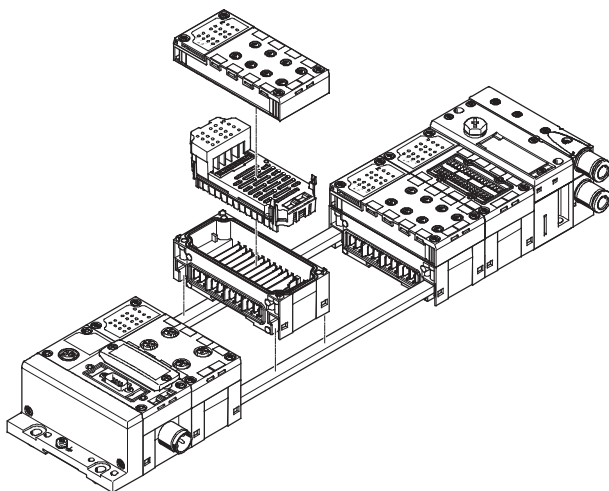

The mechanical connection between the CPX modules is established using tie rods. Two screws in the end plates are all that are needed to assemble the entire unit.

The tie rod ensures that the unit resists high mechanical loads and is therefore the "mechanical backbone" of the CPX terminal.

The open design allows interlinking blocks to be replaced in assembled state.

The tie rod extension kit allows an extra module to be added to the CPX terminal.

The input/output modules, connection blocks, fieldbus nodes or control block of the CPX system are mounted on the interlinking blocks using four screws and can be almost infinitely replaced or modified.

Valve terminals MPA-L

Peripherals overview

Valve terminal – pneumatic components

The sub-bases are available individually with one valve position or with four valve positions.

The electrical interlinking modules are available for:

- 1 or 4 single solenoid valves
- 1 or 4 double solenoid valves

• Double solenoid valve positions can be fitted with any valve or a blanking plate.

• Single solenoid valve positions can only be fitted with single solenoid valves or a blanking plate.

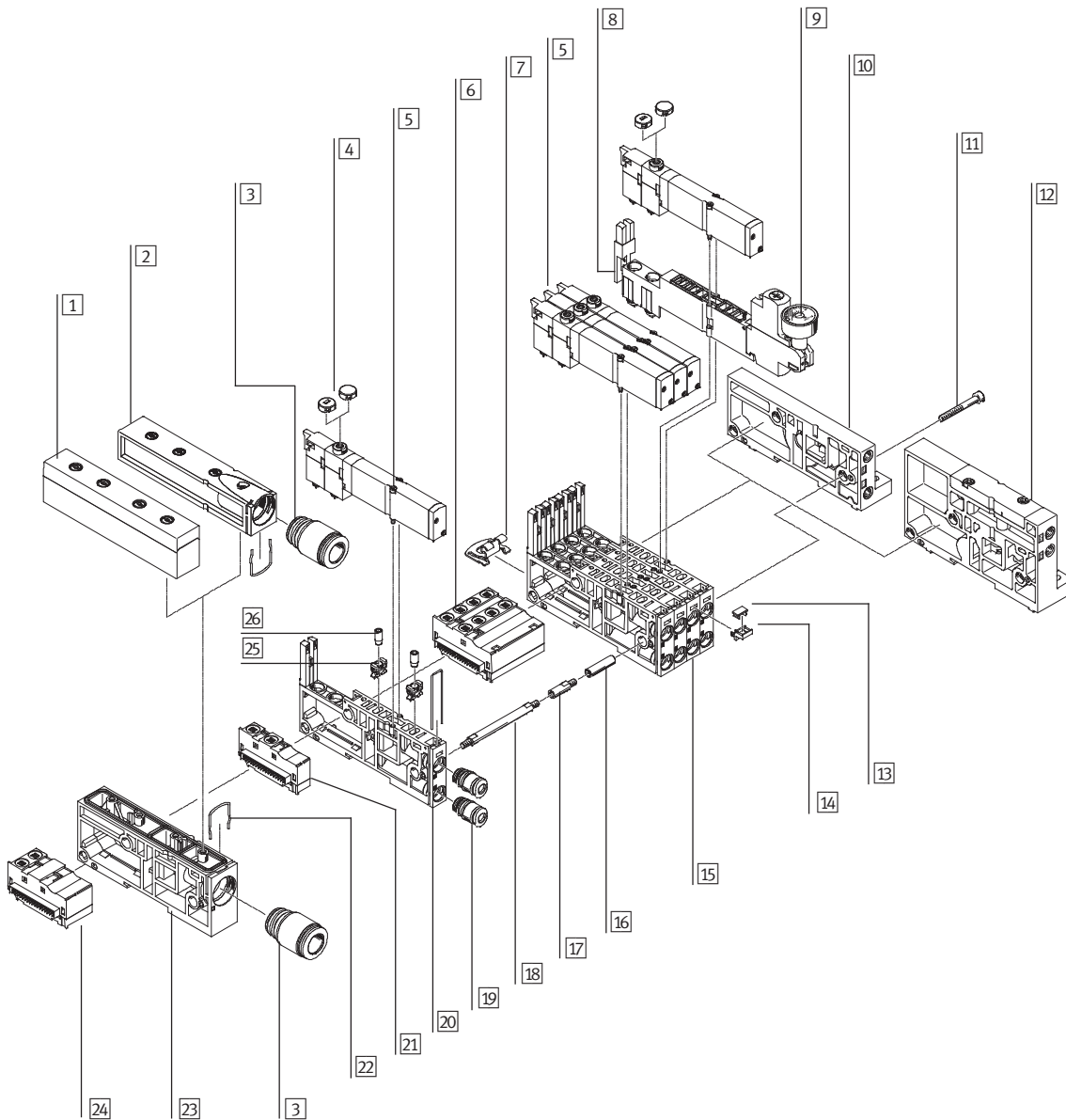

Valve terminals MPA-L

Peripherals overview

FESTO

Valve terminal – pneumatic components			
Designation	Brief description	→ Page/Internet	
1	Plate	Exhaust plate as flat plate silencer	57
2	Plate	Exhaust plate for ducted exhaust air	57
3	Cartridge fitting	For supply and exhaust ports	60
4	Cover cap for manual override	Conversion from detenting/non-detenting to non-detenting or covered	56
5	Solenoid valve	Single solenoid	48
6	Electrical interlinking module, 4-way	Electrical interlinking module for combination of four sub-bases, single solenoid/double solenoid	50
7	Mounting bracket	Mounting bracket for wall mounting	56
8	Regulator plate	Vertical stacking (pressure regulator or vertical pressure shut-off plate)	49
9	Pressure gauge	Can be optionally mounted on a pressure regulator plate	49
10	Right-hand end plate, low	End plate with pilot air selector, with ports 12/14, 82/84	58
11	Screw	Tie rod system, connects the sub-bases	55
12	Right-hand end plate, high	End plate with pilot air selector, with ports 1, 3, 5, 12/14, 82/84	58
13	Inscription label	6 x 10 mm	56
14	Holder for inscription label	–	56
15	Sub-base	Four individual sub-bases screwed together to form one unit	50
16	Sleeve	Tie rod system, connects the sub-bases	55
17	Tie rod extender	For subsequent modular extension of the valve terminal	55
18	Tie rod	Threaded rod, clamps the sub-bases between the end plates	55
19	Cartridge fitting	For working lines	60
20	Sub-base, individual	Sub-base with one valve position	50
21	Electrical interlinking module	Electrical interlinking module for single sub-base, single solenoid/double solenoid	50
22	Clamp strap for cartridge fitting	–	–
23	Supply module	For compressed air supply/exhaust air	57
24	Electrical interlinking module	Electrical interlinking module for supply module, signals are passed through	50
25	Restrictor	Fixed restrictor for installation in duct 3 or 5 of the sub-base	49
26	Retainer for restrictor	Required to install the fixed restrictor	49

Valve terminals MPA-L

Peripherals overview

FESTO

Valve terminal with multi-pin plug connection

Order code:

- 34P-...

MPA-L valve terminals with multi-pin plug connection can be expanded by up to 32 solenoid coils/valve positions.

The multi-pin plug connection is removable and designed as a 9, 25 or 44-pin Sub-D connection. The multi-pin plug connection can alternatively be ordered as a terminal strip (33-pin) or flat cable connection (40-pin).

The Sub-D multi-pin plug connection, 25 and 44-pin, is available in IP40 and IP67 or with multi-pin plug cover, without connecting cable, with a choice of cable outlet to the side or front.

Sub-D multi-pin plug connection, 25 and 44-pin, with multi-pin plug cover with pre-assembled cable:

- 2.5 m
- 5 m
- 10 m
- Variable, up to 30 m

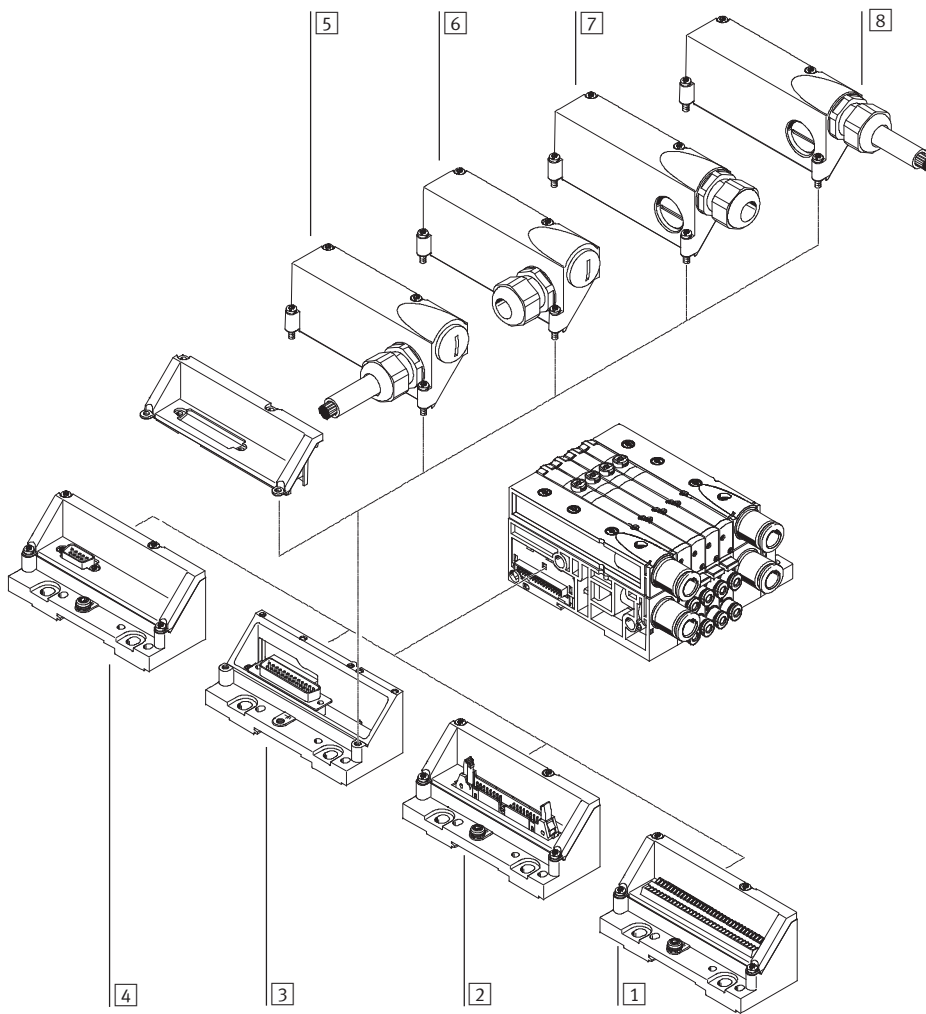

Designation	Brief description	→ Page/Internet
1 Multi-pin plug connection	Terminal strip, 33-pin, IP40	58
2 Multi-pin plug connection	For flat cable, 40-pin, IP40	58
3 Multi-pin plug connection	Sub-D, 25-pin	58
4 Multi-pin plug connection	Sub-D, 9-pin, IP40	58
5 Connecting cable	With cover, pre-assembled, connection on side, IP67	59
6 Cover	For self-assembly, connection on side, IP67	59
7 Cover	For self-assembly, connection on front, IP67	59
8 Connecting cable	With cover, pre-assembled, connection on front, IP67	59

Valve terminals MPA-L

Peripherals overview

Valve terminal with fieldbus connection, control block (electrical peripherals CPX)

Order code:

- 34P-... for the pneumatic components
- 50E-... for the electrical peripherals

Valve terminals with CPX interface can be expanded by up to 32 solenoid coils/valve positions.

Up to 32 valve positions can be equipped in combination with single solenoid valves; the maximum number of valve positions is reduced to 16 if only double solenoid valves are used.

The maximum number of addresses is set in the range 4 ... 32 solenoid coils via a selector switch.

This enables extensions to be pre-assigned in a control program and called up by means of manual settings.

Each valve position can be equipped with any valve or a blanking plate. The rules for CPX apply to the equipment that can be used in combination with the electrical peripherals CPX.

In general:

- Digital inputs/outputs
- Analogue inputs/outputs
- Parameterisation of inputs and outputs
- Integrated multi-featured diagnostic system
- Preventive maintenance concepts

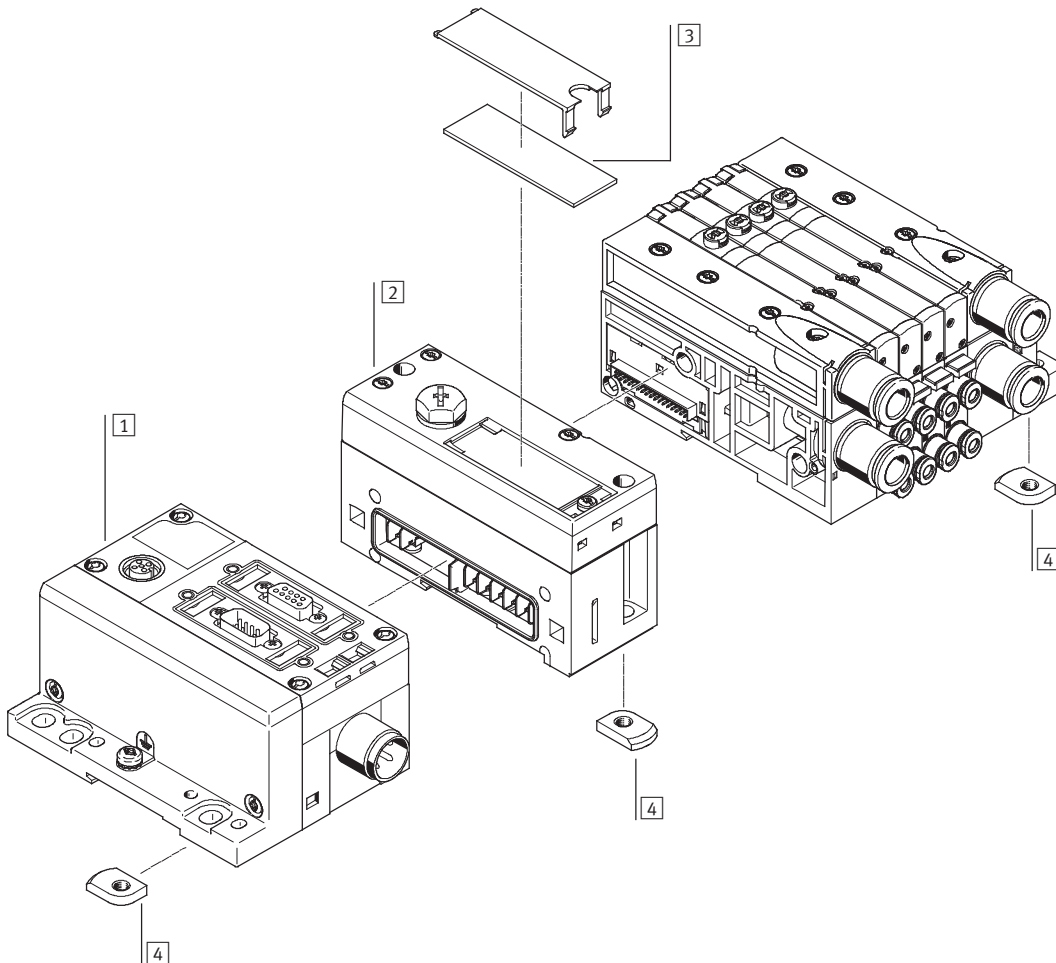

Designation	Brief description	→ Page/Internet
1 CPX modules	Fieldbus node, control block, input and output modules	cpx
2 Left-hand end plate	Pneumatic interface for CPX terminal	58
3 Inscription label	Large, for left-hand end plate/pneumatic interface for CPX terminal	-
4 H-rail mounting	-	56

Valve terminals MPA-L

Peripherals overview

Valve terminal with I-Port interface/IO-Link (and fieldbus node)

Order code:

- 34P-... for the pneumatic components
- CTEU-... for the fieldbus node

Valve terminals with I-Port interface/IO-Link can be expanded by up to 32 solenoid coils/valve positions.

Up to 32 valve positions can be equipped in combination with single solenoid valves.

The maximum number of valve positions is reduced to 16 if only double solenoid valves are used.

Each valve position can be equipped with any valve or a blanking plate.

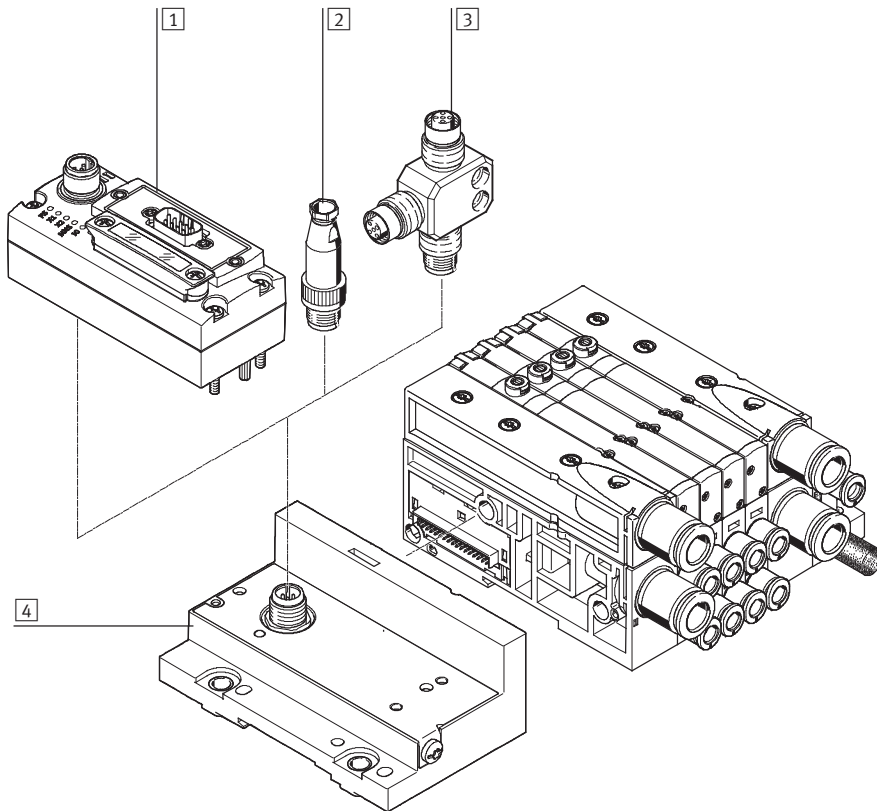

Designation	Brief description	→ Page/Internet
1 Fieldbus node CTEU	Fieldbus node	cteu
2 Plug	For I-Port interface/IO-Link	sea
3 T-adaptor	For I-Port interface/IO-Link	fb-ta
4 Left-hand end plate	End plate with I-Port interface/IO-Link	58

Valve terminals MPA-L

Key features – Pneumatic components

Sub-base valve

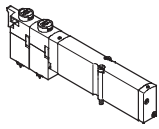

MPA-L offers a comprehensive range of valve functions. All valves are equipped with piston spool and patented sealing system that facilitates efficient sealing, a broad pressure range and long service life. They have a pneumatic pilot control for optimising performance.

Air is supplied by means of pilot air supply.
Sub-base valves can be quickly replaced since the tubing connectors remain on the sub-base.
This design is also particularly slim.

Irrespective of the valve function there are sub-base valves with one solenoid coil (single solenoid) or with two solenoid coils (double solenoid or two single solenoid valves in one housing).

Design

Valve replacement

The valves are attached to the sub-base using two screws, which means that they can be easily

replaced. The mechanical sturdiness of the sub-base guarantees good long-term sealing.

Extension

Blanking plates can be replaced by valves at a later date. The dimensions, mounting points and existing pneumatic installations remain

unchanged during this process. The valve code (e.g. M, J, N, NS, NU, etc.) is located on the front of the valve beneath the manual override.

Note

A filter must be installed upstream of valves operated in vacuum mode. This prevents any foreign matter in

the intake air getting into the valve (e.g. when operating a suction cup).

5/2-way valve

Circuit symbol	Code	Description
	Position function 1-32: M	<ul style="list-style-type: none"> • Single solenoid • Pneumatic spring return • Reversible <ul style="list-style-type: none"> • Operating pressure $-0.9 \dots +10$ bar • Available in width 10 mm, 14 mm and 20 mm
	Position function 1-32: MS	<ul style="list-style-type: none"> • Single solenoid • Mechanical spring return • Reversible <ul style="list-style-type: none"> • Operating pressure $-0.9 \dots +8$ bar • Available in width 10 mm and 20 mm
	Position function 1-32: MU	<ul style="list-style-type: none"> • Single solenoid • Polymer poppet valve • Mechanical spring return <ul style="list-style-type: none"> • Reversible • Operating pressure $-0.9 \dots +10$ bar • Available in width 10 mm
	Position function 1-32: J	<ul style="list-style-type: none"> • Double solenoid • Reversible • Operating pressure $-0.9 \dots +10$ bar <ul style="list-style-type: none"> • Available in width 10 mm, 14 mm and 20 mm

Valve terminals MPA-L

Key features – Pneumatic components



2x 3/2-way valve		
Circuit symbol	Code	Description
	Position function 1-32: N	<ul style="list-style-type: none"> • Single solenoid • Normally open • Pneumatic spring return <ul style="list-style-type: none"> • Operating pressure 3 ... 10 bar • Available in width 10 mm, 14 mm and 20 mm
	Position function 1-32: NS	<ul style="list-style-type: none"> • Single solenoid • Normally open • Mechanical spring return • Reversible <ul style="list-style-type: none"> • Operating pressure -0.9 ... +8 bar • Available in width 10 mm, 14 mm and 20 mm
	Position function 1-32: NU	<ul style="list-style-type: none"> • Single solenoid • Polymer poppet valve • Normally open • Mechanical spring return <ul style="list-style-type: none"> • Reversible • Operating pressure -0.9 ... +10 bar • Available in width 10 mm
	Position function 1-32: K	<ul style="list-style-type: none"> • Single solenoid • Normally closed • Pneumatic spring return <ul style="list-style-type: none"> • Operating pressure 3 ... 10 bar • Available in width 10 mm, 14 mm and 20 mm
	Position function 1-32: KS	<ul style="list-style-type: none"> • Single solenoid • Normally closed • Mechanical spring return • Reversible <ul style="list-style-type: none"> • Operating pressure -0.9 ... +8 bar • Available in width 110 mm, 14 mm and 20 mm
	Position function 1-32: KU	<ul style="list-style-type: none"> • Single solenoid • Polymer poppet valve • Normally closed • Mechanical spring return <ul style="list-style-type: none"> • Reversible • Operating pressure -0.9 ... +10 bar • Available in width 10 mm
	Position function 1-32: H	<ul style="list-style-type: none"> • Single solenoid • Normal position <ul style="list-style-type: none"> - 1x closed - 1x open <ul style="list-style-type: none"> • Pneumatic spring return • Operating pressure 3 ... 10 bar • Available in width 10 mm, 14 mm and 20 mm
	Position function 1-32: HS	<ul style="list-style-type: none"> • Single solenoid • Normal position <ul style="list-style-type: none"> - 1x closed - 1x open • Mechanical spring return <ul style="list-style-type: none"> • Reversible • Operating pressure -0.9 ... +8 bar • Available in width 10 mm, 14 mm and 20 mm
	Position function 1-32: HU	<ul style="list-style-type: none"> • Single solenoid • Polymer poppet valve • Normal position <ul style="list-style-type: none"> - 1x closed - 1x open <ul style="list-style-type: none"> • Mechanical spring return • Reversible • Operating pressure -0.9 ... +10 bar • Available in width 10 mm

Valve terminals MPA-L

Key features – Pneumatic components

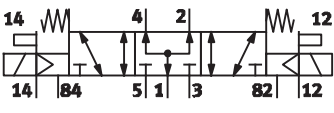
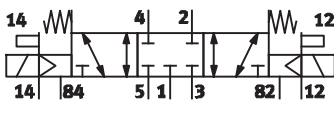
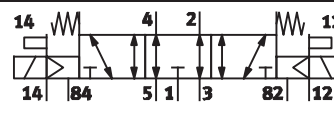
5/3-way valve		
Circuit symbol	Code	Description
	Position function 1-32: B	<ul style="list-style-type: none"> • Mid-position pressurised¹⁾ • Mechanical spring return • Reversible <ul style="list-style-type: none"> • Operating pressure –0.9 ... +10 bar • Available in width 10 mm, 14 mm and 20 mm
	Position function 1-32: G	<ul style="list-style-type: none"> • Mid-position closed¹⁾ • Mechanical spring return • Reversible <ul style="list-style-type: none"> • Operating pressure –0.9 ... +10 bar • Available in width 10 mm, 14 mm and 20 mm
	Position function 1-32: E	<ul style="list-style-type: none"> • Mid-position exhausted¹⁾ • Mechanical spring return • Reversible <ul style="list-style-type: none"> • Operating pressure –0.9 ... +10 bar • Available in width 10 mm, 14 mm and 20 mm

1) If neither solenoid coil is energised, the valve moves to its mid-position by means of spring force.
If both coils are energised at the same time, the valve remains in the previously assumed switching position.

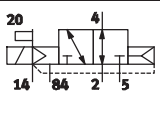
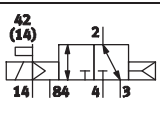
3/2-way valve		
Circuit symbol	Code	Description
	Position function 1-32: W	<ul style="list-style-type: none"> • Single solenoid • Normally open • External compressed air supply • Pneumatic spring return • Reversible • Operating pressure –0.9 ... +10 bar <ul style="list-style-type: none"> • Available in width 10 mm and 20 mm Compressed air (–0.9 ... +10 bar) supplied at working line 2 can be switched with both internal and external pilot air supply.
	Position function 1-32: X	<ul style="list-style-type: none"> • Single solenoid • Normally closed • External compressed air supply • Pneumatic spring return • Reversible • Operating pressure –0.9 ... +10 bar <ul style="list-style-type: none"> • Available in width 10 mm and 20 mm Compressed air (–0.9 ... +10 bar) supplied at working line 4 can be switched with both internal and external pilot air supply.

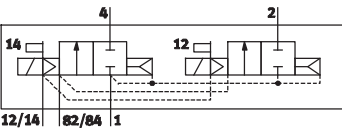
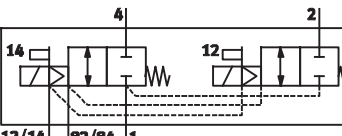
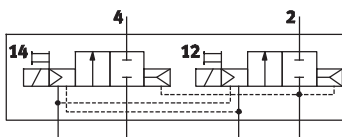
2x 2/2-way valve		
Circuit symbol	Code	Description
	Position function 1-32: D	<ul style="list-style-type: none"> • Single solenoid • Normally closed • Pneumatic spring return <ul style="list-style-type: none"> • Operating pressure 3 ... 10 bar • Available in width 10 mm, 14 mm and 20 mm
	Position function 1-32: DS	<ul style="list-style-type: none"> • Single solenoid • Normally closed • Mechanical spring return • Reversible <ul style="list-style-type: none"> • Operating pressure –0.9 ... +8 bar • Available in width 10 mm, 14 mm and 20 mm
	Position function 1-32: I	<ul style="list-style-type: none"> • Single solenoid • 1x normally closed • 1x normally closed, reversible • Pneumatic spring return <ul style="list-style-type: none"> • Operating pressure 3 ... 10 bar • Vacuum at port 3/5 only • Available in width 10 mm and 20 mm

Valve terminals MPA-L

Key features – Pneumatic components

FESTO

Blanking plate

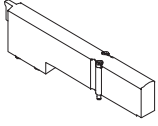

Blanking plate (code L) without valve function, for reserving valve positions on a valve terminal.

Valves and blanking plates are attached to the sub-base using two screws.

Fixed restrictor

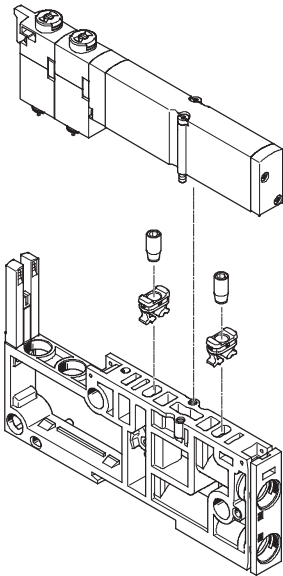

The fixed restrictor can be used to permanently set the flow rate when venting in ducts 3 and 5.

Mounting:

- Press the retainer as far as it will go into the exhaust openings on the sub-base
- Screw the fixed restrictor into the retainer
- Mount the valve on the sub-base

The restrictor cuts a thread into the retainer as it is screwed in. For that reason, the retainer should also be changed when a restrictor is repeatedly replaced.

The restrictor is available in seven different nominal sizes (0.3 ... 1.7 mm). The individual sizes are colour-coded to make them easy to distinguish.

Fixed restrictors enable, for example, the cylinder speed to be set to a predefined limit in response to known flow rate conditions.

They cannot be accessed during operation and are therefore protected against manipulation.

This is beneficial in the production of standard machines since the required speed can be determined once and the installation simply duplicated for further machines, saving time and costs for repeated commissioning.

Note

The fixed restrictors are only available for valves and manifold sub-bases with a width of 10 mm.

Valve terminals MPA-L

Key features – Pneumatic components

FESTO

Vertical stacking

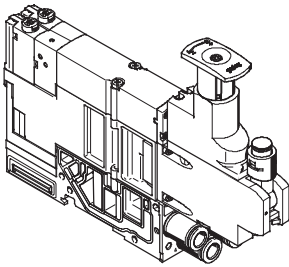

Additional functions can be added to each valve position between the sub-base and the valve.

These functions are known as vertical stacking modules and enable special

functioning or control of an individual valve position.

Pressure regulator plate

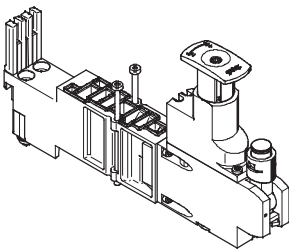

An adjustable pressure regulator can be installed between the sub-base and the valve in order to control the force of the triggered actuator.

This pressure regulator maintains an essentially constant output pressure (secondary side) independent of pressure fluctuations (primary side) and air consumption.

Standard version:

- For supply pressure up to 6 bar or up to 10 bar
- Without pressure gauge (optional, rotatable)
- Adjusted using a screwdriver or regulator knob

Vertical pressure shut-off plate for width 10 mm

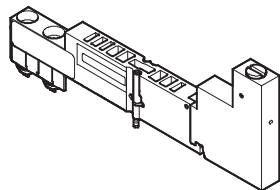

The vertical pressure shut-off plate can be used to hot swap individual valves without switching off the overall air supply.

It allows the working pressure for the individual valve to be switched off manually via the actuating element.

Valve terminals MPA-L

Key features – Pneumatic components



Pressure regulator		
Circuit symbol	Code	Description
	Pressure regulator 1-32: PA Pressure regulator 1-32: PF	<ul style="list-style-type: none"> Regulates the pressure upstream of the valve in duct 1 Same regulated pressure at duct 2 and duct 4 Venting in the valve from duct 2 to duct 3 and from duct 4 to duct 5 <ul style="list-style-type: none"> Regulator not affected by venting Regulator can always be adjusted Available in width 10 mm and 20 mm
	Pressure regulator 1-32: PC Pressure regulator 1-32: PH	<ul style="list-style-type: none"> Regulates the pressure for duct 2 downstream of the valve Venting via the regulator from duct 2 to duct 3 Exhaust flow rate is restricted by the regulator <ul style="list-style-type: none"> Regulator can only be adjusted in switched state Available in width 10 mm and 20 mm
	Pressure regulator 1-32: PB Pressure regulator 1-32: PG	<ul style="list-style-type: none"> Regulates the pressure for duct 4 downstream of the valve Venting via the regulator from duct 4 to duct 5 Exhaust flow rate is restricted by the regulator <ul style="list-style-type: none"> Regulator can only be adjusted in switched state Available in width 10 mm and 20 mm
	Pressure regulator 1-32: PN Pressure regulator 1-32: PL	<ul style="list-style-type: none"> Splits the supply air in duct 1 and regulates the pressure upstream of the valve in duct 3 Valve is operated in reverse mode Venting in the valve from duct 2 to duct 1 <ul style="list-style-type: none"> Regulator not affected by venting Regulator can always be adjusted Available in width 20 mm
	Pressure regulator 1-32: PK Pressure regulator 1-32: PM	<ul style="list-style-type: none"> Splits the supply air in duct 1 and regulates the pressure upstream of the valve in duct 5 Valve is operated in reverse mode Venting in the valve from duct 4 to duct 1 <ul style="list-style-type: none"> Regulator not affected by venting Regulator can always be adjusted Available in width 20 mm

Vertical pressure shut-off plate		
Circuit symbol	Code	Description
	Pressure regulator 1-32: PS	<ul style="list-style-type: none"> Allows the pressure in duct 1 and duct 12/14 to be switched off upstream of the valve Venting in the valve from duct 2 to duct 3 and from duct 4 to duct 5 <ul style="list-style-type: none"> Vertical pressure shut-off plate not affected by venting Operating pressure 3 ... 8 bar Available in width 10 mm

Valve terminals MPA-L

Key features – Pneumatic components

Compressed air supply and venting

Supply module

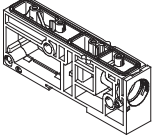

Right-hand end plate

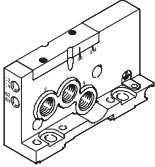

The valve terminal MPA-L can be supplied with compressed air at one or more points via supply modules and/or the right-hand end plate. The generously sized pneumatic system enables good performance from all functional components, even with large-scale expansions.

Venting (ducts 3 and 5) either takes place via silencers or ports for ducted exhaust air via the supply modules or the right-hand end plate.

There are two types of supply module with venting:

- Exhaust air 3/5 via flat plate silencer
- Exhaust air 3/5 ducted

Venting (ducts 3 and 5) can alternatively or additionally take place via the right-hand end plate.

Ducts 3 and 5 are separate in the terminal and are only joined together in the supply module. The exhaust air from the pilot air (duct 82/84) is entirely separate from ducts 3 and 5.

Pilot air supply

The valve terminal MPA-L is supplied with pilot air exclusively via the right-hand end plate. The pilot air

supply can be selected at the pilot air selector on the end plate:

- Internal (from duct 1) or
- External (from duct 12/14)

Switching position for internal, marked "Int"

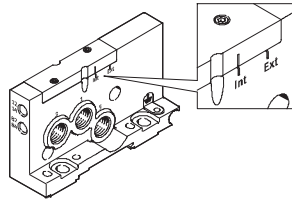
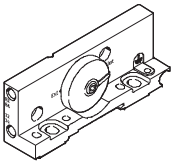

Internal pilot air supply can be selected if the supply pressure for the terminal is between 3 and 8 bar. In this case, the pilot air supply is branched by means of an internal

connection from duct 1 in the right-hand end plate. Port 12/14 on the right-hand end plate can be sealed using a blanking plug.

Switching position for external, marked "Ext"

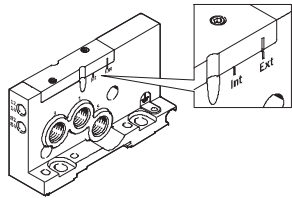
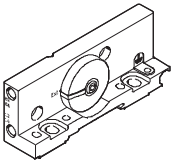

If the supply pressure (at the right-hand end plate) is less than 3 bar or greater than 8 bar, then the valve terminal MPA-L must be operated with an external pilot air supply. The pilot air supply is then fed

via port 12/14 on the right-hand end plate. When using several pressure zones, the supply pressure in the pressure zone with the right-hand end plate is decisive.

Note

If a gradual pressure build-up in the system using a soft-start valve is chosen, an external pilot air supply

should be connected so that the control pressure applied during switch-on is already very high.

Valve terminals MPA-L

Key features – Pneumatic components

Compressed air supply and pilot air supply		
Graphical illustration	Code	Notes
Right-hand end plate, with supply ports		
	Right-hand end plate: D Pilot air: –	Internal pilot air supply <ul style="list-style-type: none"> • Pilot air is branched internally from port 1 in the right-hand end plate • Exhaust air 3/5 via right-hand end plate or supply module • Pilot exhaust air 82/84 via right-hand end plate • For operating pressure in the range 3 ... 8 bar
	Right-hand end plate: D Pilot air: E	External pilot air supply <ul style="list-style-type: none"> • Pilot air supply (3 ... 8 bar) is connected at the right-hand end plate at port 12/14 • Exhaust air 3/5 via right-hand end plate or supply module • Pilot exhaust air 82/84 via right-hand end plate • For operating pressure in the range –0.9 ... 10 bar (suitable for vacuum)
Right-hand end plate, without supply ports		
	Right-hand end plate: – Pilot air: –	Internal pilot air supply <ul style="list-style-type: none"> • Pilot air is branched internally from port 1 in the right-hand end plate • Exhaust air 3/5 via supply module • Pilot exhaust air 82/84 via right-hand end plate • For operating pressure in the range 3 ... 8 bar
	Right-hand end plate: – Pilot air: E	External pilot air supply <ul style="list-style-type: none"> • Pilot air supply (3 ... 8 bar) is connected at the right-hand end plate at port 12/14 • Exhaust air 3/5 via supply module • Pilot exhaust air 82/84 via right-hand end plate • For operating pressure in the range –0.9 ... 10 bar (suitable for vacuum)
Supply module, flat plate silencer		
	Type of module block 1-40: U Exhaust port: –	<ul style="list-style-type: none"> • Exhaust air 3/5 via flat plate silencer • Pilot exhaust air 82/84 via right-hand end plate • For operating pressure in the range –0.9 ... 10 bar (suitable for vacuum)
Supply module, ducted exhaust air		
	Type of module block 1-40: U Exhaust port: UD, UE, UF, UM, UN, UP or UG	<ul style="list-style-type: none"> • Exhaust air 3/5 via supply module • Pilot exhaust air 82/84 via right-hand end plate • For operating pressure in the range –0.9 ... 10 bar (suitable for vacuum)

Valve terminals MPA-L

Key features – Pneumatic components

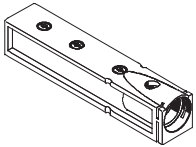
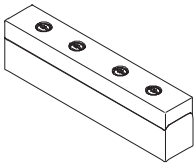
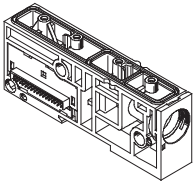
Supply module				
Illustration	Code	Type	Designation	Notes
	Exhaust port: UD, UE, UF, UM, UN, UP or UG	VMPAL-EG	Exhaust plate for ducted exhaust air	Additional supply modules can be used for larger terminals or to create additional pressure zones. Supply modules can be configured at any point upstream or downstream of the sub-bases. Supply modules contain the following ports: <ul style="list-style-type: none"> • Compressed air supply (duct 1) • Exhaust air (duct 3/5) Depending on your order, the exhaust ducts are either ducted or vented via the flat plate silencer.
	Exhaust port: –	VMPAL-EU	Flat plate silencer	
	Type of module block 1-40: U	VMPAL-SP-0	Supply module with electrical interlinking module	

Valve terminals MPA-L

Key features – Pneumatic components



Creating pressure zones and separating exhaust air

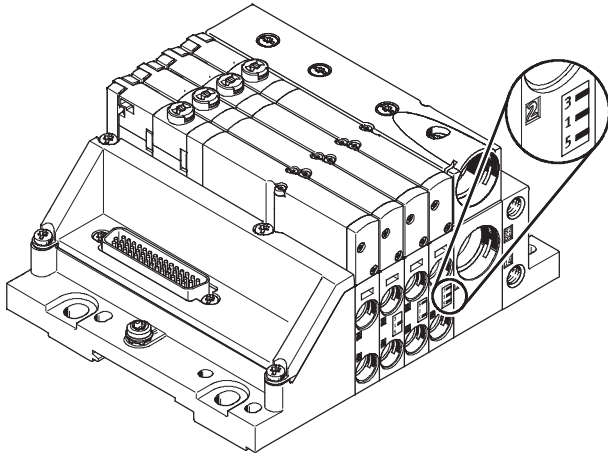

MPA-L offers a number of options for creating pressure zones if different working pressures are required. Up to nine pressure zones in total are possible.

Pressure zones are created by isolating the internal supply ducts in a special sub-base. Each pressure zone must have its own compressed air supply.

Compressed air can be supplied and vented via a supply module and/or the right-hand end plate.

The position of the supply modules and the sub-bases with pressure zone separation can be freely chosen with the valve terminal MPA-L.

The sub-bases with pressure zone separation are integrated in the terminal ex-works as per your order. They can be distinguished by their coding, even when the valve terminal is assembled. Duct separation always takes place to the right of the sub-base.

Creating pressure zones		Code	Notes
Sub-bases with pressure zone separation			
Illustrated examples	Coding		
		Duct separation to the right of sub-base 1 - 40: –	<ul style="list-style-type: none"> No duct separation
		Duct separation to the right of sub-base 1 - 40: T	<ul style="list-style-type: none"> Duct 1 separated VMPAL-...-T1
		Duct separation to the right of sub-base 1 - 40: TR	<ul style="list-style-type: none"> Duct 3/5 separated VMPAL-...-T35
		Duct separation to the right of sub-base 1 - 40: TS	<ul style="list-style-type: none"> Ducts 1 and 3/5 separated VMPAL-...-T135

Valve terminals MPA-L

Key features – Pneumatic components

Examples: Compressed air supply and pilot air supply

Internal pilot air supply, right-hand end plate without supply ports

The illustration opposite shows an example of the configuration and connection of the air supply with internal pilot air supply.

The exhaust air (duct 3/5) is discharged via supply modules.

The pilot exhaust air (duct 82/84) is discharged via the right-hand end plate.

Special sub-bases are used to create pressure zones.

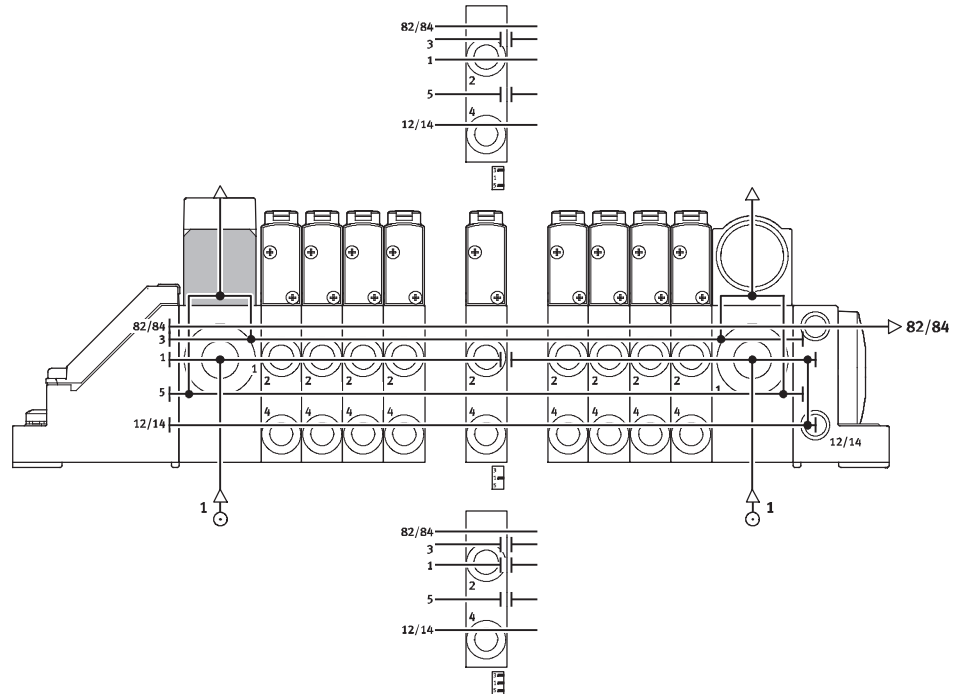

External pilot air supply, right-hand end plate without supply ports

The illustration opposite shows an example of the configuration and connection of the compressed air supply with external pilot air supply.

Port 12/14 on the right-hand end plate is equipped with a fitting for this.

The exhaust air (duct 3/5) is discharged via supply modules.

The pilot exhaust air (duct 82/84) is discharged via the right-hand end plate.

Special sub-bases are used to create pressure zones.

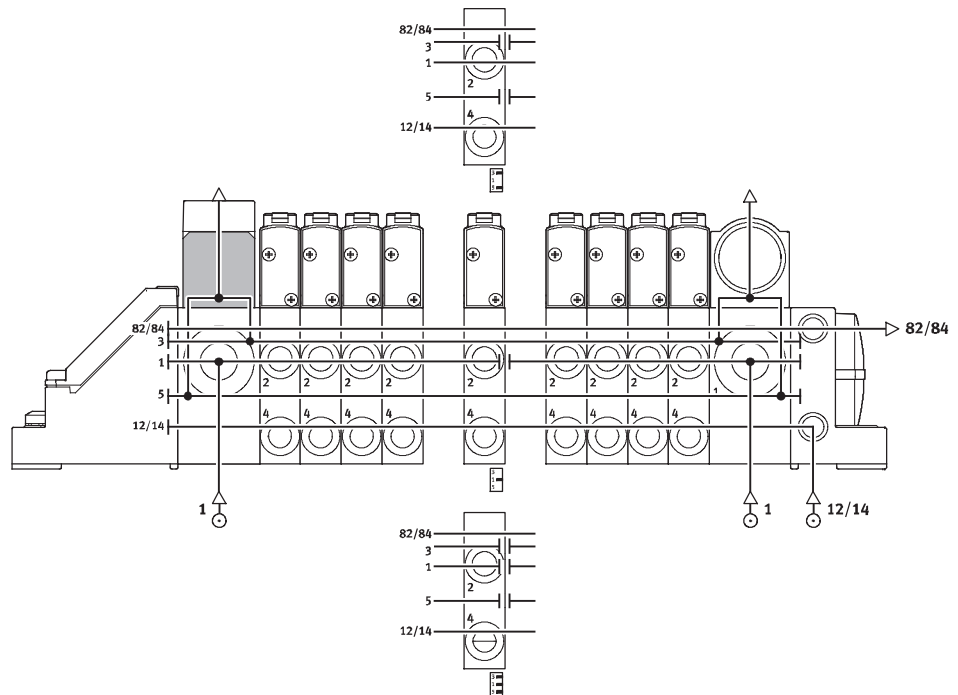

Valve terminals MPA-L

Key features – Pneumatic components

Sub-base

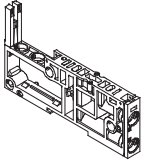

MPA-L is based on a modular system consisting of sub-bases and valves. The sub-bases are connected together using tie rods and thus form the support system for the valves.

They contain the connection ducts for supplying compressed air to and venting from the valve terminal as well as the working lines for the pneumatic drives for each valve.

The sub-bases are joined together via tie rods. The tie rod consists of a threaded rod, threaded sleeve and screw.

In principle, sub-bases have a modular structure. If this modularity is not required within a terminal, then four individual sub-bases can be combined with a 4-way electrical interlinking module to save costs.

The threaded rod/sleeve combination is selected as appropriate to the number and width of the individual sub-bases or sub-base combination. To add further blocks, simply loosen the tie rod and adapt with extenders. There are no restrictions on extensions; a tie rod could be made almost entirely from extenders.

Sub-base variants

Illustration	Code	Type	Notes
	-	VMPAL-AP-10 VMPAL-AP-14 VMPAL-AP-20	<ul style="list-style-type: none"> Working lines 2, 4 on the sub-base Without electrical interlinking module
		VMPAL-AP-...-QS	<ul style="list-style-type: none"> Working lines 2, 4 on the sub-base With electrical interlinking module
		VMPAL-AP-...-T1	<ul style="list-style-type: none"> Working lines 2, 4 on the sub-base With/without electrical interlinking module Duct separation in duct 1
		VMPAL-AP-...-T35	<ul style="list-style-type: none"> Working lines 2, 4 on the sub-base Without electrical interlinking module Duct separation in ducts 3 and 5
		VMPAL-AP-...-T135	<ul style="list-style-type: none"> Working lines 2, 4 on the sub-base Without electrical interlinking module Duct separation in ducts 1, 3 and 5
		Combination manifold block: Z	VMPAL-AP-4x10

Valve terminals MPA-L

Key features – Pneumatic components

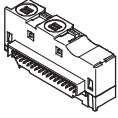
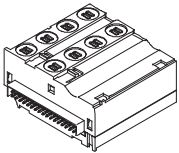
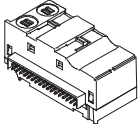
Electrical interlinking module				
Illustration	Code	Type	No. of solenoid coils (valve positions)	Notes
	Type of module block 1-40: A	VMPAL-EVAP-10-...-2	2 (1), double solenoid	Each solenoid coil must be assigned to a specific pin on the multi-pin plug in order for the valve to be actuated. Regardless of whether blanking plates or valves are used, valve positions occupy <ul style="list-style-type: none"> • one coil/address (single solenoid valves) • two coils/addresses (double solenoid valves) The electrical interlinking modules are colour-coded: <ul style="list-style-type: none"> • Single solenoid – grey • Double solenoid – black
	Type of module block 1-40: E	VMPAL-EVAP-14-...-2		
	Type of module block 1-40: B	VMPAL-EVAP-20-...-2		
	Type of module block 1-40: C	VMPAL-EVAP-10-...-1	1 (1), single solenoid	
	Type of module block 1-40: F	VMPAL-EVAP-14-...-1		
	Type of module block 1-40: D	VMPAL-EVAP-20-...-1		
	Type of module block 1-40: A	VMPAL-EVAP-10-2-4	8 (4), double solenoid	
	Type of module block 1-40: C	VMPAL-EVAP-10-1-4	4 (4), single solenoid	
	Type of module block 1-40: U	VMPAL-EVAP-20-SP	–	Electrical interlinking module for supply module

Valve terminals MPA-L

Key features – Pneumatic components

FESTO

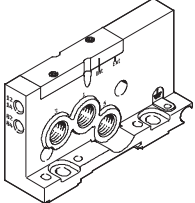
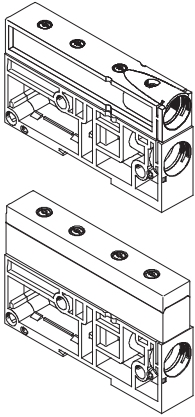
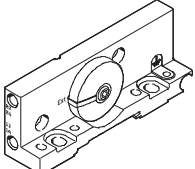
Ports for supply and venting					
	Code	Port		QS push-in fitting/cartridge fitting	
Right-hand end plate with supply ports 1, 3, 5					
	Right-hand end plate: D	1	Air/vacuum supply	Thread G1/4	QS-G1/4, straight, for tubing O.D. Ø 8 mm, 10 mm, 12 mm, 5/16", 3/8", 1/2"
		3	Exhaust air	Thread G1/4	
		5	Exhaust air	Thread G1/4	
		12/14	Pilot air supply	Thread M7	QSM-M7, straight or angled, for tubing O.D. Ø 4 mm, 6 mm, 1/4"
		82/84	Pilot exhaust air	Thread M7	
Supply module					
	Type of module block 1-40: U	1	Air/vacuum supply	Cartridge fitting	QSPKG20, straight, for tubing O.D. Ø 8 mm, 10 mm, 12 mm, 5/16", 3/8", 1/2", adapter for thread G1/4
		3/5	Exhaust air	Flat plate silencer	–
				Cartridge fitting	QSPKG20, straight, for tubing O.D. Ø 8 mm, 10 mm, 12 mm, 5/16", 3/8", 1/2", adapter for thread G1/4
		12/14	Pilot air supply	–	–
		82/84	Pilot exhaust air	–	–
Right-hand end plate without supply ports					
	Right-hand end plate: –	1	Air/vacuum supply	–	–
		3	Exhaust air	–	–
		5	Exhaust air	–	–
		12/14	Pilot air supply	Thread M7	QSM-M7, straight or angled, for tubing O.D. Ø 4 mm, 6 mm, 1/4"
		82/84	Pilot exhaust air	Thread M7	

Valve terminals MPA-L

Key features – Assembly

Valve terminal assembly

Sturdy terminal assembly thanks to:

- Four through-holes for wall mounting
- Additional mounting brackets
- H-rail mounting

Note

If the terminal is subject to strong vibrations or shock loads, use additional mounting brackets of the type VMPAL-BD for wall mounting.

These should be attached to the valve terminal every 13 cm (one mounting bracket every 10 valve positions).

Wall mounting – Multi-pin plug connection

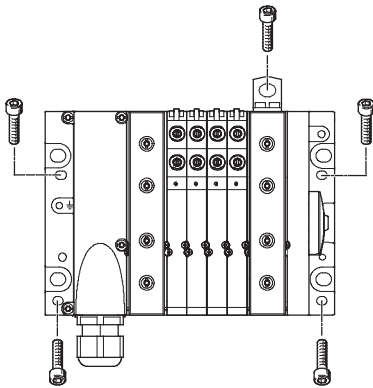

The MPA-L valve terminal is screwed onto the mounting surface using four M4 or M6 screws. The mounting holes are on the multi-pin plug connection

and on the right-hand end plate. Optional mounting brackets are also available.

Wall mounting – Fieldbus connection (CPX terminal)

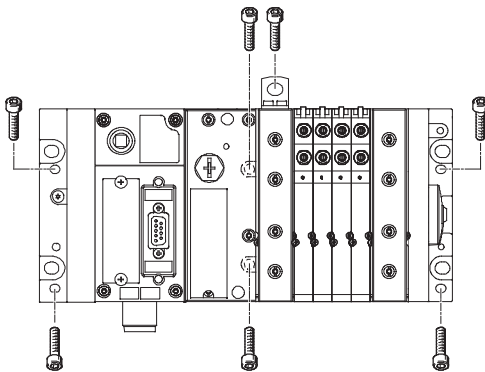

The MPA-L valve terminal is screwed onto the mounting surface using four M4 and two M6 screws or using six M6 screws. The mounting holes are

on the left-hand and right-hand end plate and on the pneumatic interface. Optional mounting brackets are also available.

H-rail mounting

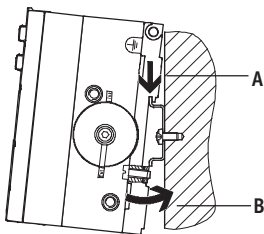

The MPA-L valve terminal is attached to the H-rail (see arrow A). The terminal is then swivelled onto the H-rail and secured in place with the clamping component (see arrow B).

The following MPA-L mounting kit is required for H-rail mounting of the valve terminal:

- With multi-pin plug connection: CPX-CPA-BG-NRH
- With fieldbus connection (CPX terminal): VMPAF-FB-BG-NRH

This enables mounting of the valve terminal on an H-rail to EN 60715.

Note

The mounting kits (see above) only lock the valve terminal in horizontal mounting position.

Valve terminals MPA-L

Key features – Assembly

FESTO

Tie rod

Design

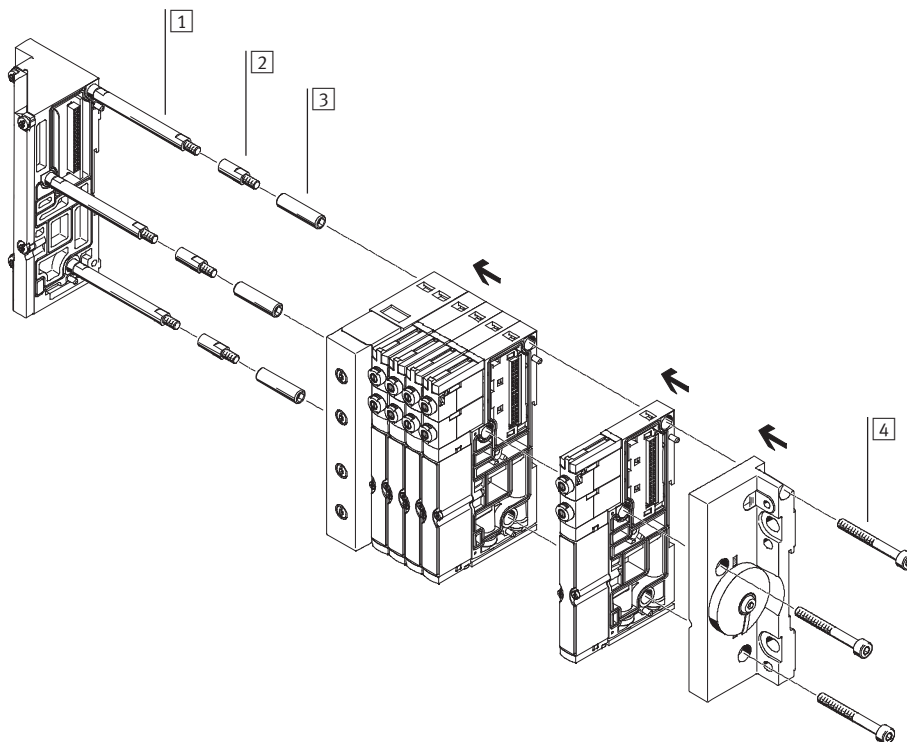

- 1 Threaded rod
- 2 Tie rod extender
- 3 Sleeve
- 4 Screw

Mode of operation

The tie rod for MPA-L consists of four parts:

- Threaded rod
- Tie rod extender
- Sleeve
- Screw

This enables valve terminals of any length to be created.

The tie rod and valve terminal are assembled in just four steps:

- Screw the threaded rods to the left-hand end plate
- Screw the sleeves to the threaded rods
- Push the sub-bases and supply modules onto the rod/sleeve combination
- Push on the right-hand end plate and secure with screws that engage into the sleeves

The tie rod enables subsequent extension of the valve terminal. This is done by loosening the tie rod screws and disassembling the relevant components. The additional sub-base or supply module is inserted at the required location. The previously disassembled components are then re-assembled.

To compensate for the change in length, the tie rod must be extended by the increase in length. This is done by screwing in extenders between the threaded rod and sleeve. There are suitable extenders for each sub-base, combination of four sub-bases and supply module.

Valve terminals MPA-L

Key features – Assembly

Tie rod – Components and design

Tie rod (threaded rod)

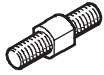

The threaded rod is used to create a cost-optimised fixed-grid tie rod. The threaded rod is required with valve terminal lengths exceeding 42.45 mm, for example at least four sub-bases (10.7 mm each), since only the combination of a threaded rod and sleeve offers the optimum compensation of tolerances (by compressing the seals between the sub-bases).

Tie rod extender

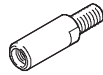

The valve terminal can be extended almost infinitely using tie rod extenders. The tie rod extenders are inserted between the threaded rod and sleeve and are available in appropriate lengths for sub-bases and supply modules.

Sleeve

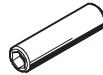

The primary purpose of the sleeve is to compensate tolerances that occur, for example, when the seals are compressed between the sub-bases during assembly. The sleeves come in different lengths, tailored to the use of a tie rod in a fixed grid as well as generally for the modular tie rods.

Screw



The entire valve terminal is clamped via the tie rod using screws. Tolerances that occur, for example, when the seals are compressed between the sub-bases during assembly, are compensated by the interaction of the screws and sleeve.

Individual modular tie rod

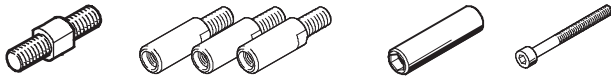

Tie rods can be made entirely using tie rod extenders. The threaded rod and sleeve are required to compensate tolerances that occur, for example,

when the seals are compressed between the sub-bases during assembly.

Fixed-grid tie rod with extension



The tie rod extenders are inserted between the threaded rod and sleeve.

They are available in suitable lengths for sub-bases and supply modules.

Fixed-grid tie rod



The fixed-grid tie rod minimises assembly costs when assembling previously defined valve terminals. These valve terminals can be extended at any time.

The threaded rod (and if applicable also the sleeve) must be replaced if the valve terminal length is reduced.

Short valve terminal

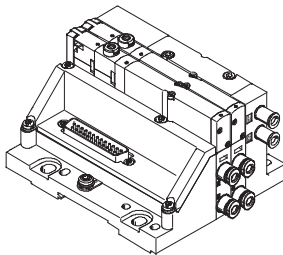

Valve terminals with a small number of valve positions are created by means of the following combinations:

Width 10 mm

- Valve terminals with two valve positions and without a supply module are connected solely using screws
- Valve terminals with three valve positions and without a supply module (or with one valve position and one supply module) are connected using a 10 mm tie rod extender and screw

Width 14 mm

- Valve terminals with two valve positions and without a supply module are connected using a 10 mm tie rod extender and screw

Valve terminals MPA-L

Key features – Assembly

Ordering data – Fixed-grid tie rod				
Reference length	Part No.	Type	Part No.	Type
$L = 10.65 \times V + 14.85 \times W + 21.15 \times Z + 21.15 \times S$	Tie rod		Sleeve	
42.3 ... 62.65	561116	VMPAL-ZAS-5	561135	VMPAL-ZAH-36
62.66 ... 72.30	561116	VMPAL-ZAS-5	561136	VMPAL-ZAH-46
72.31 ... 81.95	561116	VMPAL-ZAS-5	561137	VMPAL-ZAH-56
81.96 ... 91.60	561116	VMPAL-ZAS-5	561138	VMPAL-ZAH-66
91.61 ... 101.25	561117	VMPAL-ZAS-45	561135	VMPAL-ZAH-36
101.26 ... 110.90	561117	VMPAL-ZAS-45	561136	VMPAL-ZAH-46
110.91 ... 120.55	561117	VMPAL-ZAS-45	561137	VMPAL-ZAH-56
120.56 ... 130.20	561117	VMPAL-ZAS-45	561138	VMPAL-ZAH-66
130.21 ... 139.85	561118	VMPAL-ZAS-85	561135	VMPAL-ZAH-36
139.86 ... 149.50	561118	VMPAL-ZAS-85	561136	VMPAL-ZAH-46
149.51 ... 159.50	561118	VMPAL-ZAS-85	561137	VMPAL-ZAH-56
159.51 ... 169.15	561118	VMPAL-ZAS-85	561138	VMPAL-ZAH-66
169.16 ... 178.80	561119	VMPAL-ZAS-125	561135	VMPAL-ZAH-36
178.81 ... 188.45	561119	VMPAL-ZAS-125	561136	VMPAL-ZAH-46
188.46 ... 198.10	561119	VMPAL-ZAS-125	561137	VMPAL-ZAH-56
198.11 ... 207.75	561119	VMPAL-ZAS-125	561138	VMPAL-ZAH-66
207.76 ... 217.40	561120	VMPAL-ZAS-165	561135	VMPAL-ZAH-36
217.41 ... 227.05	561120	VMPAL-ZAS-165	561136	VMPAL-ZAH-46
227.06 ... 236.70	561120	VMPAL-ZAS-165	561137	VMPAL-ZAH-56
236.71 ... 246.35	561120	VMPAL-ZAS-165	561138	VMPAL-ZAH-66
246.36 ... 256.00	561121	VMPAL-ZAS-205	561135	VMPAL-ZAH-36
256.01 ... 266.00	561121	VMPAL-ZAS-205	561136	VMPAL-ZAH-46
266.01 ... 275.65	561121	VMPAL-ZAS-205	561137	VMPAL-ZAH-56
275.66 ... 285.30	561121	VMPAL-ZAS-205	561138	VMPAL-ZAH-66
285.31 ... 294.95	561122	VMPAL-ZAS-245	561135	VMPAL-ZAH-36
294.96 ... 304.60	561122	VMPAL-ZAS-245	561136	VMPAL-ZAH-46
304.61 ... 314.25	561122	VMPAL-ZAS-245	561137	VMPAL-ZAH-56
314.26 ... 323.90	561122	VMPAL-ZAS-245	561138	VMPAL-ZAH-66
323.91 ... 333.55	561123	VMPAL-ZAS-285	561135	VMPAL-ZAH-36
333.56 ... 343.20	561123	VMPAL-ZAS-285	561136	VMPAL-ZAH-46
343.21 ... 352.85	561123	VMPAL-ZAS-285	561137	VMPAL-ZAH-56
352.86 ... 362.50	561123	VMPAL-ZAS-285	561138	VMPAL-ZAH-66
362.51 ... 372.50	561124	VMPAL-ZAS-325	561135	VMPAL-ZAH-36
372.51 ... 382.50	561124	VMPAL-ZAS-325	561136	VMPAL-ZAH-46
382.51 ... 392.50	561124	VMPAL-ZAS-325	561137	VMPAL-ZAH-56
392.51 ... 402.50	561124	VMPAL-ZAS-325	561138	VMPAL-ZAH-66
402.51 ... 412.50	561125	VMPAL-ZAS-365	561135	VMPAL-ZAH-36
412.51 ... 422.50	561125	VMPAL-ZAS-365	561136	VMPAL-ZAH-46
422.51 ... 432.50	561125	VMPAL-ZAS-365	561137	VMPAL-ZAH-56
432.51 ... 442.50	561125	VMPAL-ZAS-365	561138	VMPAL-ZAH-66
442.51 ... 452.50	561126	VMPAL-ZAS-405	561135	VMPAL-ZAH-36
452.51 ... 462.50	561126	VMPAL-ZAS-405	561136	VMPAL-ZAH-46
462.51 ... 472.50	561126	VMPAL-ZAS-405	561137	VMPAL-ZAH-56
472.51 ... 482.50	561126	VMPAL-ZAS-405	561138	VMPAL-ZAH-66
482.51 ... 492.50	561127	VMPAL-ZAS-445	561135	VMPAL-ZAH-36
492.51 ... 502.50	561127	VMPAL-ZAS-445	561136	VMPAL-ZAH-46
502.51 ... 512.50	561127	VMPAL-ZAS-445	561137	VMPAL-ZAH-56
512.51 ... 522.50	561127	VMPAL-ZAS-445	561138	VMPAL-ZAH-66

- V Number of valve positions in width 10 mm
- W Number of valve positions in width 14 mm
- Z Number of valve positions in width 20 mm
- S Number of supply modules

Valve terminals MPA-L

Key features – Assembly

Ordering data – Fixed-grid tie rod				
Reference length	Part No.	Type	Part No.	Type
L = 10.65 x V + 14.85 x W + 21.15 x Z + 21.15 x S	Tie rod		Sleeve	
522.51 ... 532.50	561128	VMPAL-ZAS-485	561135	VMPAL-ZAH-36
532.51 ... 542.50	561128	VMPAL-ZAS-485	561136	VMPAL-ZAH-46
542.51 ... 552.50	561128	VMPAL-ZAS-485	561137	VMPAL-ZAH-56
552.51 ... 562.50	561128	VMPAL-ZAS-485	561138	VMPAL-ZAH-66
562.51 ... 572.50	561129	VMPAL-ZAS-525	561135	VMPAL-ZAH-36
572.51 ... 582.50	561129	VMPAL-ZAS-525	561136	VMPAL-ZAH-46
582.51 ... 592.50	561129	VMPAL-ZAS-525	561137	VMPAL-ZAH-56
592.51 ... 602.50	561129	VMPAL-ZAS-525	561138	VMPAL-ZAH-66
602.51 ... 612.50	561130	VMPAL-ZAS-565	561135	VMPAL-ZAH-36
612.51 ... 622.50	561130	VMPAL-ZAS-565	561136	VMPAL-ZAH-46
622.51 ... 632.50	561130	VMPAL-ZAS-565	561137	VMPAL-ZAH-56
632.51 ... 642.50	561130	VMPAL-ZAS-565	561138	VMPAL-ZAH-66
642.51 ... 652.50	561131	VMPAL-ZAS-605	561135	VMPAL-ZAH-36
652.51 ... 662.50	561131	VMPAL-ZAS-605	561136	VMPAL-ZAH-46
662.51 ... 672.50	561131	VMPAL-ZAS-605	561137	VMPAL-ZAH-56
672.51 ... 682.50	561131	VMPAL-ZAS-605	561138	VMPAL-ZAH-66
682.51 ... 692.50	561132	VMPAL-ZAS-645	561135	VMPAL-ZAH-36
692.51 ... 702.50	561132	VMPAL-ZAS-645	561136	VMPAL-ZAH-46
702.51 ... 712.50	561132	VMPAL-ZAS-645	561137	VMPAL-ZAH-56
712.51 ... 722.50	561132	VMPAL-ZAS-645	561138	VMPAL-ZAH-66
722.51 ... 732.50	561133	VMPAL-ZAS-685	561135	VMPAL-ZAH-36
732.51 ... 742.50	561133	VMPAL-ZAS-685	561136	VMPAL-ZAH-46
742.51 ... 752.50	561133	VMPAL-ZAS-685	561137	VMPAL-ZAH-56
752.51 ... 762.50	561133	VMPAL-ZAS-685	561138	VMPAL-ZAH-66
762.51 ... 772.50	561134	VMPAL-ZAS-725	561135	VMPAL-ZAH-36
772.51 ... 782.50	561134	VMPAL-ZAS-725	561136	VMPAL-ZAH-46
782.51 ... 792.50	561134	VMPAL-ZAS-725	561137	VMPAL-ZAH-56
792.51 ... 802.50	561134	VMPAL-ZAS-725	561138	VMPAL-ZAH-66
802.51 ... 812.50	561175	VMPAL-ZAS-765	561135	VMPAL-ZAH-36
812.51 ... 822.50	561175	VMPAL-ZAS-765	561136	VMPAL-ZAH-46
822.51 ... 832.50	561175	VMPAL-ZAS-765	561137	VMPAL-ZAH-56
832.51 ... 842.50	561175	VMPAL-ZAS-765	561138	VMPAL-ZAH-66
842.51 ... 852.50	561176	VMPAL-ZAS-805	561135	VMPAL-ZAH-36
852.51 ... 862.50	561176	VMPAL-ZAS-805	561136	VMPAL-ZAH-46

- V Number of valve positions in width 10 mm
- W Number of valve positions in width 14 mm
- Z Number of valve positions in width 20 mm
- S Number of supply modules

Valve terminals MPA-L

Key features – Display and operation

Display and operation

Signal status display

Each solenoid coil is allocated an LED that indicates its signal status.

- Indicator 12 shows the switching status of the coil for duct 2
- Indicator 14 shows the switching status of the coil for duct 4

Manual override

The manual override (MO) enables the valve to be actuated when not electrically activated or energised. The valve is switched by pushing the manual override.

Alternatives:

- A cover (code N or as accessory) enables the manual override to be actuated by pressing it using an appropriate tool.
- A cover (code V) can be fitted over the manual override to prevent it from being accidentally actuated.

Pneumatic connection and control elements

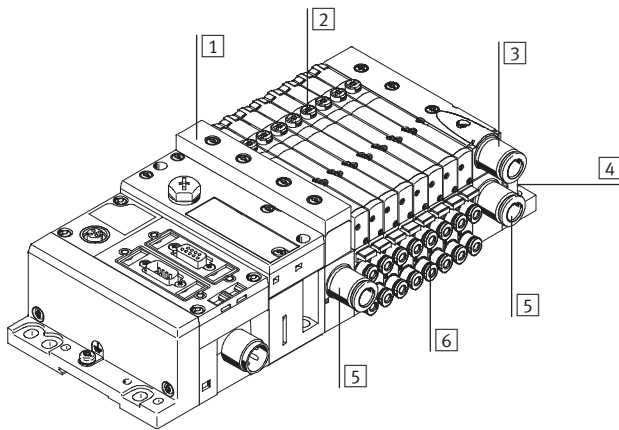

- 1 Flat plate silencer, duct 3/5
- 2 Manual override (for each pilot solenoid coil, non-detenting or non-detenting/detenting)
- 3 Ducted exhaust air, duct 3/5
- 4 Ports 12/14 for external pilot air supply and 82/84 for pilot exhaust air in the right-hand end plate (depending on version also ducts 1, 3 and 5)
- 5 Supply port, duct 1
- 6 Working lines, ducts 2 and 4, for each valve position

Note

A valve actuated manually (by means of the manual override) cannot be reset electrically. Conversely, an electrically actuated valve cannot be reset using the manual override.

Manual override (MO)

MO with automatic return (non-detenting)

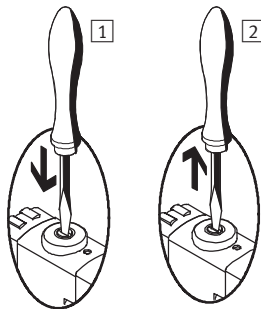

- 1 Press in the stem of the MO with a pointed object or screwdriver. Pilot valve switches and actuates the main valve.
- 2 Remove the pointed object or screwdriver. Spring force pushes the stem of the MO back. Pilot valve returns to its initial position and so too the single solenoid main valve (not with double solenoid valve code J).

MO set via turning (detenting)

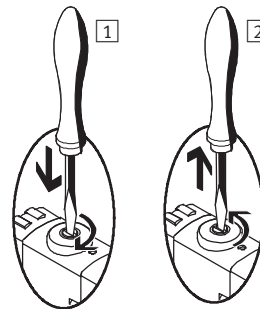

- 1 Press in the stem of the MO with a pointed object or screwdriver until the valve switches and then turn the stem clockwise by 90° until the stop is reached. Valve remains switched.
- 2 Turn the stem anti-clockwise by 90° until the stop is reached and then remove the pointed object or screwdriver. Spring force pushes the stem of the MO back. Valve returns to its initial position (not with double solenoid valve code J).

Valve terminals MPA-L

Key features – Electrical components

Inscription system

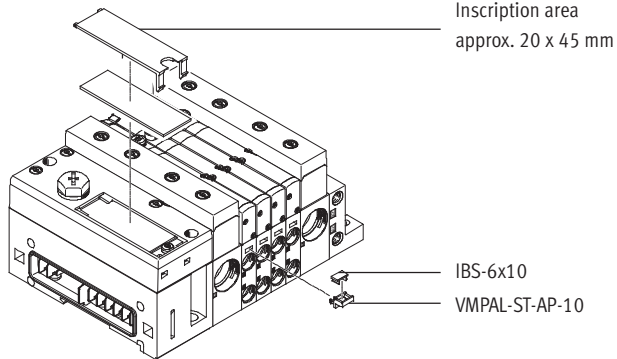

A holder VMPAL-ST-AP-10 (Part No. 561109) with inscription labels (Part No. 18576, IBS-6x10) can be mounted on each sub-base for labelling the valves.

Large inscription labels can be attached to the pneumatic interface as an alternative or in addition to the smaller labels.

Electrical power as a result of current reduction

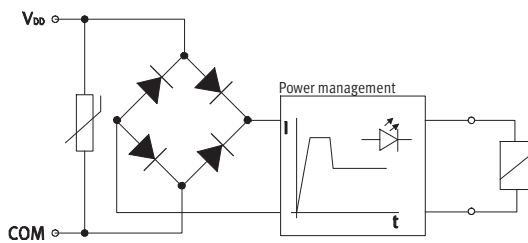

Each solenoid coil is protected with a spark arresting protective circuit as well as against polarity reversal. All valve types are additionally equipped with integrated current reduction.

MPA-L valves are supplied with operating voltage in the range 21.6 ... 26.4 V (24 V +/-10%).

Valve terminals MPA-L

Key features – Electrical components

Electrical connection – Left-hand end plate

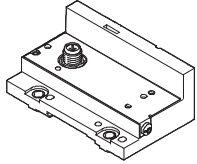

The electrical connection for connecting the valves to a higher-level controller is located in the left-hand end plate. The different connection options can

be easily switched by replacing the left-hand end plate, while the pneumatic connections remain as they are.

The valves are switched by means of positive or negative logic (PNP or NPN). Mixed operation is not permitted.

Guidelines on addressing for valves/solenoid coils

- The numbering of the addresses goes from left to right in ascending consecutive order. The following applies to the individual valve positions: address x for coil 14 and address x+1 for coil 12.
- Each sub-base/electrical interlinking module occupies a defined number of addresses/pins:
 - For single solenoid valve: 1
 - For double solenoid valve: 2
 - For combination of four sub-bases for single solenoid valves: 4
 - For combination of four sub-bases for double solenoid valves: 8

Note

If a single solenoid valve is assembled on a double solenoid valve position, the second address (for coil 12) is also occupied and cannot be used.

Left-hand end plate variants					
Illustration	Code	Type	Max. no. of addresses	Protection class	Notes
Electrical multi-pin connection					
	Electrical connection: MS1	VMPAL-EPL-SD25-IP40	24	IP40	Electrical connection via Sub-D, 25-pin
	Electrical connection: MS2	VMPAL-EPL-SD9-IP40	8	IP40	Electrical connection via Sub-D, 9-pin
	Electrical connection: MS6	VMPAL-EPL-SD25	24	IP65	Electrical connection via Sub-D, 25-pin
	Electrical connection: MS8	VMPAL-EPL-SD44	32	IP65	Electrical connection via Sub-D, 44-pin
	Electrical connection: MF1	VMPAL-EPL-FL40-IP40	32	IP40	Electrical connection via flat cable, 40-pin
	Electrical connection: MC	VMPAL-EPL-KL33-IP40	32	IP40	Electrical connection via terminal strip, 33-pin
Fieldbus connection/CPX terminal					
	Electrical connection: CX	VMPAL-EPL-CPX	32	IP67	Electrical connection via CPX interlinking module
I-Port interface/IO-Link					
	Electrical connection: LK	VMPAL-EPL-IPO32	32	IP65	Electrical connection via M12, 5 pin, IO-Link
	Electrical connection: PT	VMPAL-EPL-IPO32	32	IP65	Electrical connection via M12, 5 pin, I-Port interface

Valve terminals MPA-L

Key features – Electrical components



Pin allocation for electrical multi-pin plug connection – Sub-D plug, 9-pin				
	Pin	Address/coil		
	1	0	6	
	2	1	7	
	3	2	8	
	4	3	9	
	5	4	0 V ¹⁾	
				Note The drawing shows the view onto the pins of the Sub-D plug.

1) 0 V for positive switching control signals; connect 24 V for negative switching control signals; mixed operation is not permitted.

Pin allocation for electrical multi-pin plug connection – Sub-D plug, 25-pin, connecting cable VMPAL-KM								
	Pin	Address/coil	Connecting cable wire colour ²⁾		Pin	Address/coil	Connecting cable wire colour ²⁾	
	1	0	WH		14	13	BN YE	
	2	1	GN		15	14	GY WH	
	3	2	YE		16	15	BN GY	
	4	3	GY		17	16	WH PK	
	5	4	PK		18	17	BN PK	
	6	5	BU		19	18	BU WH	
	7	6	RD		20	19	BN BU	
	8	7	VT		21	20	RD WH	
	9	8	GY PK		22	21	BN RD	
	10	9	RD BU		23	22	BK WH	
	11	10	GN WH		24	23	BN	
	12	11	BN GN		25	0 V ¹⁾	BK	
	13	12	YE WH					
								Note The drawing shows the view onto the pins of the Sub-D plug.

1) 0 V for positive switching control signals; connect 24 V for negative switching control signals; mixed operation is not permitted.

2) To IEC 757

Pin allocation for electrical multi-pin plug connection – Sub-D plug, 44-pin, connecting cable VMPAL-KM											
	Pin	Address/coil	Connecting cable wire colour ²⁾		Pin	Address/coil	Connecting cable wire colour ²⁾		Pin	Address/coil	Connecting cable wire colour ²⁾
	1	0	WH		18	17	BN PK		35	n.c.	n.c.
	2	1	GN		19	18	BU WH		36	n.c.	n.c.
	3	2	YE		20	19	BN BU		37	n.c.	n.c.
	4	3	GY		21	20	RD WH		38	n.c.	n.c.
	5	4	PK		22	21	BN RD		39	n.c.	n.c.
	6	5	BU		23	22	BK WH		40	n.c.	n.c.
	7	6	RD		24	23	BN		41	0 V ¹⁾	RD YE
	8	7	VT		25	24	BK BN		42	0 V ¹⁾	BK GN
	9	8	GY PK		26	25	GN GY		43	0 V ¹⁾	BK YE
	10	9	RD BU		27	26	YE GY		44	0 V ¹⁾	BK
	11	10	GN WH		28	27	GN PK				
	12	11	BN GN		29	28	YE PK				
	13	12	YE WH		30	29	GN BU				
	14	13	BN YE		31	30	YE BU				
	15	14	GY WH		32	31	RD GN				
	16	15	BN GY		33	n.c.	n.c.				
	17	16	WH PK		34	n.c.	n.c.				
											Note The drawing shows the view onto the pins of the Sub-D plug.



1) 0 V for positive switching control signals; connect 24 V for negative switching control signals; mixed operation is not permitted.

2) To IEC 757

Valve terminals MPA-L

Key features – Electrical components

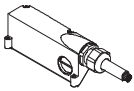
FESTO

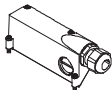
Electrical multi-pin connection – Ordering data						
Designation	Code	Description	Connection	Cable length	Part No.	Type
Connecting cable for multi-pin plug connection with Sub-D plug socket						
	Connecting cable: CA	Cable outlet to front (only with electrical connection code: MS6)	25-pin	2.5 m	560416	VMPAL-KM-V-SD25-IP67-2,5
	Connecting cable: CB			5 m	560417	VMPAL-KM-V-SD25-IP67-5
	Connecting cable: CC			10 m	560418	VMPAL-KM-V-SD25-IP67-10
	Connecting cable: –			Any	562389	VMPAL-KM-V-SD25-IP67-X
	Connecting cable: CQ	Cable outlet to front (only with electrical connection code: MS6) Suitable for use with energy chains	25-pin	2.5 m	560410	VMPAL-KMSK-V-SD25-IP67-2,5
	Connecting cable: CR			5 m	560411	VMPAL-KMSK-V-SD25-IP67-5
	Connecting cable: CS			10 m	560412	VMPAL-KMSK-V-SD25-IP67-10
	Connecting cable: –			Any	562391	VMPAL-KMSK-V-SD25-IP67-X
	Connecting cable: CJ	Cable outlet to front (only with electrical connection code: MS8)	44-pin	2.5 m	560422	VMPAL-KM-V-SD44-IP67-2,5
	Connecting cable: CK			5 m	560423	VMPAL-KM-V-SD44-IP67-5
	Connecting cable: CL			10 m	560424	VMPAL-KM-V-SD44-IP67-10
	Connecting cable: –			Any	562390	VMPAL-KM-V-SD44-IP67-X
	Connecting cable: CD	Cable outlet to side (only with electrical connection code: MS6)	25-pin	2.5 m	560419	VMPAL-KM-S-SD25-IP67-2,5
	Connecting cable: CE			5 m	560420	VMPAL-KM-S-SD25-IP67-5
	Connecting cable: CH			10 m	560421	VMPAL-KM-S-SD25-IP67-10
	Connecting cable: –			Any	562392	VMPAL-KM-S-SD25-IP67-X
	Connecting cable: CT	Cable outlet to side (only with electrical connection code: MS6) Suitable for use with energy chains	25-pin	2.5 m	560413	VMPAL-KMSK-S-SD25-IP67-2,5
	Connecting cable: CU			5 m	560414	VMPAL-KMSK-S-SD25-IP67-5
	Connecting cable: CV			10 m	560415	VMPAL-KMSK-S-SD25-IP67-10
	Connecting cable: –			Any	562394	VMPAL-KMSK-S-SD25-IP67-X
	Connecting cable: CM	Cable outlet to side (only with electrical connection code: MS8)	44-pin	2.5 m	560425	VMPAL-KM-S-SD44-IP67-2,5
	Connecting cable: CN			5 m	560426	VMPAL-KM-S-SD44-IP67-5
	Connecting cable: CP			10 m	560427	VMPAL-KM-S-SD44-IP67-10
	Connecting cable: –			Any	562393	VMPAL-KM-S-SD44-IP67-X
Cover for multi-pin plug connection without connecting cable with Sub-D plug socket						
	Connecting cable: EZ	Cable outlet to side or front (only with electrical connection code: MS6)	25-pin	–	560428	VMPAL-KM-SD25-IP67-0
	Connecting cable: EY	Cable outlet to side or front (only with electrical connection code: MS8)	44-pin	–	560429	VMPAL-KM-SD44-IP67-0

Valve terminals MPA-L

Key features – Electrical components

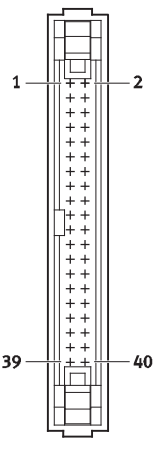
Pin allocation for electrical multi pin-plug connection – Flat cable, 40-pin									
	Pin	Address/coil		Pin	Address/coil		Pin	Address/coil	
	1	0		18	17		35	0 V ¹⁾	
		2	1		19	18		36	0 V ¹⁾
		3	2		20	19		37	0 V ¹⁾
		4	3		21	20		38	0 V ¹⁾
		5	4		22	21		39	0 V ¹⁾
		6	5		23	22		40	0 V ¹⁾
		7	6		24	23	Note The drawing shows the view onto the pins of the flat cable plug. The flat cable connection is established using plug connectors, in accordance with DIN EN 60603-13:1998-09 (NECU-FCG40-K). → Internet: necu		
		8	7		25	24			
		9	8		26	25			
		10	9		27	26			
		11	10		28	27			
		12	11		29	28			
		13	12		30	29			
		14	13		31	30			
		15	14		32	31			
		16	15		33	0 V ¹⁾			
		17	16		34	0 V ¹⁾			

1) 0 V for positive switching control signals; connect 24 V for negative switching control signals; mixed operation is not permitted.

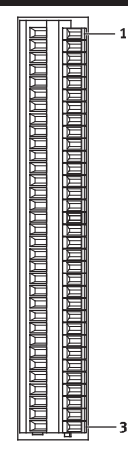
Pin allocation for electrical multi pin-plug connection – Terminal strip, 33-pin									
	Pin	Address/coil		Pin	Address/coil		Pin	Address/coil	
	1	0		16	15		31	30	
		2	1		17	16		32	31
		3	2		18	17		33	0 V ¹⁾
		4	3		19	18	Note The drawing shows the view onto the pins of the terminal strip. Cables with the following specifications can be connected: <ul style="list-style-type: none"> • Cable cross section 0.08 ... 0.5 mm² • Insulation 5 ... 6 mm 		
		5	4		20	19			
		6	5		21	20			
		7	6		22	21			
		8	7		23	22			
		9	8		24	23			
		10	9		25	24			
		11	10		26	25			
		12	11		27	26			
		13	12		28	27			
		14	13		29	28			
		15	14		30	29			

1) 0 V for positive switching control signals; connect 24 V for negative switching control signals; mixed operation is not permitted.

Valve terminals MPA-L

Key features – Electrical components

Fieldbus connection/CPX terminal

All functions and features of the electrical peripherals CPX are permitted in connection with the CPX interface.

This means:

- The valves and outputs are supplied via the system supply for the CPX terminal
- The valves can optionally be actuated or switched off separately from the outputs

The pneumatic interface (left-hand end plate) serves as an adapter between the two current feeds.

In the pneumatic interface, the serial signals from the CPX terminal are converted into parallel signals.

The number of addresses (solenoid coils that can be connected) is set via a selector (rotary switch) on the pneumatic interface to between 4 ... 32 solenoid coils. The default

setting on delivery provides for 32 addresses. This enables extensions to be pre-assigned in a control program and called up by means of manual settings.

After converting or extending the valve terminal, the number of output addresses occupied by the pneumatic components must be checked and if applicable adjusted.

Note

More information can be found at:
→ Internet: cpx

I-Port interface/IO-Link

The I-Port interface/IO-Link enables the valve terminal CPV to be connected to the following systems:

- I-Port master from Festo (CPX terminal, CECC)
- Fieldbus node CTEU from Festo

- IO-Link master

The maximum distance between the I-Port/IO-Link master and valve terminal with I-Port interface/IO-Link is 20 m.

The 5-pin connecting cables contain the power supply for the valves, separate from this is the power supply for the internal valve terminal electronics and the control signals.

Note

More information can be found at:
→ Internet: cteu

Pin allocation I-Port interface/IO-Link

	Pin	Designation
	1	24 V DC supply voltage for electronics and inputs
	2	24 V DC load voltage supply for valves and outputs
	3	0 V DC supply voltage for electronics and sensors
	4	Communication signal C/Q, data cable
	5	0 V DC load voltage supply for valves and outputs

Valve terminals MPA-L

Key features – Electrical components

FESTO

Instructions for use			
Equipment		Bio-oils	Mineral oils
<p>Operate system equipment with unlubricated compressed air if possible. Festo valves and cylinders are designed so that, if used as designated, they will not require additional lubrication and will still achieve a long service life. The quality of compressed air downstream of the compressor must correspond to that of unlubricated compressed air. If possible, do not operate all of your system equipment with lubricated compressed air. The lubricators should, where possible, always be installed directly upstream of the actuator used.</p>	<p>Unsuitable additional oil and too high an oil content in the compressed air reduce the service life of the valve terminal.</p> <p>Use Festo special oil OFSW-32 or the alternatives listed in the Festo catalogue (as specified in DIN 51524 HLP32; basic oil viscosity 32 CST at 40 °C).</p>	<p>When using bio-oils (oils which are based on synthetic or native ester, e.g. rapeseed oil methyl ester), the maximum residual oil content of 0.1 mg/m³ must not be exceeded (see ISO 8573-1 Class 2).</p>	<p>When using mineral oils (e.g. HLP oils to DIN 51524, parts 1 to 3) or similar oils based on poly-alpha-olefins (PAO), the maximum residual oil content of 5 mg/m³ must not be exceeded (see ISO 8573-1 Class 4). A higher residual oil content irrespective of the compressor oil cannot be permitted, as the basic lubricant would be flushed out over time.</p>

Valve terminals MPA-L

Technical data

Flow rate

Up to 870 l/min

- **□** - Valve width
 10 mm
 14 mm
 20 mm

Voltage

24 V DC

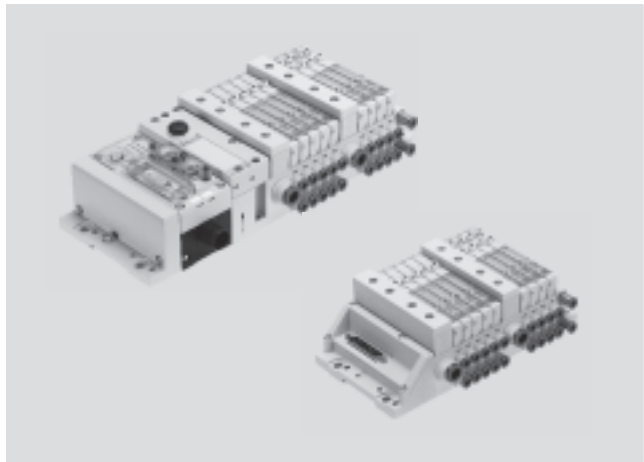

General technical data				
Valve terminal design	Modular, valve sizes can be mixed			
Electrical actuation	Fieldbus	Multi-pin plug	IO-Link	I-Port
Actuation type	Electric			
Nominal operating voltage [V DC]	24			
Max. number of valve positions	32			
Max. number of pressure zones	9			
Valve size [mm]	10, 14, 20			
Switching position display	LED			
Pilot air supply	Internal or external			
Lubrication	Life-time lubrication, PWIS-free (free of paint-wetting impairment substances)			
Type of mounting	Wall mounting On H-rail to EN 60715			
Mounting position	Any (wall mounting) Horizontal only (H-rail)			
Manual override	Non-detenting, detenting, blocked			
Corrosion resistance class CRC ¹⁾	3			
CE marking (see declaration of conformity)	To EU EMC Directive ²⁾			
Note on materials	RoHS-compliant			
Protection class	IP65			

- 1) Corrosion resistance class 3 according to Festo standard 940 070
 Components subject to high corrosion stress. Externally visible parts with primarily functional surface requirements which are in direct contact with a normal industrial environment or media such as solvents and cleaning agents.
- 2) For information about the applicability of the component see the manufacturer's EC declaration of conformity at: www.festo.com → Support → User documentation.
 If the component is subject to restrictions on usage in residential, office or commercial environments or small businesses, further measures to reduce the emitted interference may be necessary.

Operating and environmental conditions	
Operating medium	Compressed air to ISO 8573-1:2010 [7:4:4] → 37
Note about the operating/ pilot medium	Operation with lubricated medium possible (in which case lubricated operation will always be required)
Operating pressure [bar]	-0.9 ... +10
Pilot pressure [bar]	3 ... 8
Ambient temperature [°C]	-5 ... +50
Temperature of medium [°C]	-5 ... +50
Storage temperature ¹⁾ [°C]	-20 ... +40

1) Long-term storage

**New**

Width 14 mm with mechanical spring

FESTO

Valve terminals MPA-L

Technical data

Technical data – Valve width 10 mm														
Code for position function 1-32			M	J	N	K	H	B	G	E	X	W	D	I
Switching times	On	[ms]	10	10	10	10	10	10	10	10	10	10	10	8
	Off	[ms]	20	–	20	20	20	35	35	35	20	20	20	20
	Changeover	[ms]	–	15	–	–	–	–	–	–	–	–	–	–
Operating pressure	[bar]	–0.9 ... +10			3 ... 10			–0.9 ... +10					3 ... 10	
Standard nominal flow rate	[l/min]	360	360	300	230	300	300	320	240	255	255	230	260	
Design		Piston spool valve												
Max. tightening torque of valve mounting	[Nm]	0.25												
Materials		Die-cast aluminium												
Product weight	[g]	49	56	56	56	56	56	56	56	56	49	49	56	–

Technical data – Valve width 10 mm												
Code for position function 1-32			MS	NS	KS	HS	DS	MU	NU	KU	HU	
Switching times	On	[ms]	10	10	10	10	10	10	8	8	8	
	Off	[ms]	27	20	20	20	20	12	8	10	10	
	Changeover	[ms]	–	–	–	–	–	–	–	–	–	
Operating pressure	[bar]	–0.9 ... +8						–0.9 ... +10				
Standard nominal flow rate	[l/min]	360	300	230	300	230	190	190	160	190		
Design		Piston spool valve						Poppet valve with spring return				
Max. tightening torque of valve mounting	[Nm]	0.25										
Materials		Die-cast aluminium						PA reinforced				
Product weight	[g]	56	56	56	56	56	35	42	42	42		

Technical data – Valve width 14 mm																
Code for position function 1-32			M	J	N	K	H	B	G	E	D	NS	KS	HS	DS	
Switching times	On	[ms]	13	22	12	12	12	16	13	13	12	12	12	12	10	
	Off	[ms]	30	–	38	38	38	50	52	50	30	23	23	23	25	
	Changeover	[ms]	–	24	–	–	–	26	26	26	–	–	–	–	–	
Operating pressure	[bar]	–0.9 ... +10										–0.9 ... +8				
Standard nominal flow rate	[l/min]	670	670	650	600	650	630	610	480	650	520	560	520	570		
Design		Piston spool valve														
Max. tightening torque of valve mounting	[Nm]	0.65										0.25				
Materials		Die-cast aluminium														
Product weight	[g]	77														

Technical data – Valve width 20 mm																				
Code for position function 1-32			M	J	N	K	H	B	G	E	X	W	D	I	MS	NS	KS	HS	DS	
Switching times	On	[ms]	15	9	8	8	8	11	10	11	13	13	7	7	8	12	12	12	12	
	Off	[ms]	28	–	28	28	28	46	40	47	22	22	25	23	36	25	25	25	25	
	Changeover	[ms]	–	22	–	–	–	23	21	23	–	–	–	–	–	–	–	–	–	
Operating pressure	[bar]	–0.9 ... +10			3 ... 10			–0.9 ... +10					3 ... 10		–0.9 ... +8					
Standard nominal flow rate	[l/min]	870	860	610	550	550	550	750	700	480	480	840	850	840	620	500	550	820		
Design		Piston spool valve																		
Max. tightening torque of valve mounting	[Nm]	0.65																		
Materials		Die-cast aluminium																		
Product weight	[g]	100												–		100				

Valve terminals MPA-L

Technical data

Pneumatic connections		
Right-hand end plate		
Supply	1	Thread G1/4 (QS-G1/4, straight, for tubing O.D. Ø8 mm, 10 mm, 12 mm, 5/16", 3/8", 1/2")
Exhaust port	3	Thread G1/4 (QS-G1/4, straight, for tubing O.D. Ø8 mm, 10 mm, 12 mm, 5/16", 3/8", 1/2")
	5	Thread G1/4 (QS-G1/4, straight, for tubing O.D. Ø8 mm, 10 mm, 12 mm, 5/16", 3/8", 1/2")
Pilot air supply	12/14	Thread M7 (QSM-M7, straight or angled, for tubing O.D. Ø4 mm, 6 mm, 1/4")
Pilot exhaust air	82/84	Thread M7 (QSM-M7, straight or angled, for tubing O.D. Ø4 mm, 6 mm, 1/4")
Supply module		
Supply	1	Cartridge fitting 20 mm (QSPKG20, straight, for tubing O.D. Ø8 mm, 10 mm, 12 mm, 5/16", 3/8", 1/2", adapter for thread G1/4), flat plate silencer
Exhaust port	3/5	Cartridge fitting 20 mm (QSPKG20, straight, for tubing O.D. Ø8 mm, 10 mm, 12 mm, 5/16", 3/8", 1/2", adapter for thread G1/4), flat plate silencer
Manifold block width 10 mm		
Working lines	2	Cartridge fitting 10 mm (QSPKG10, straight or angled, for tubing O.D. Ø4 mm, 6 mm, 5/32", 1/4", adapter for thread M7)
	4	Cartridge fitting 10 mm (QSPKG10, straight or angled, for tubing O.D. Ø4 mm, 6 mm, 5/32", 1/4", adapter for thread M7)
Manifold block width 14 mm		
Working lines	2	Cartridge fitting 14 mm (QSPKG14, straight or angled, for tubing O.D. Ø6 mm, 8 mm, 1/4", 5/16", adapter for thread G1/8)
	4	Cartridge fitting 14 mm (QSPKG14, straight or angled, for tubing O.D. Ø6 mm, 8 mm, 1/4", 5/16", adapter for thread G1/8)
Manifold block width 20 mm		
Working lines	2	Cartridge fitting 18 mm (QSPKG18, straight or angled, for tubing O.D. Ø8 mm, 10 mm, 5/16", 3/8", adapter for thread G1/4)
	4	Cartridge fitting 18 mm (QSPKG18, straight or angled, for tubing O.D. Ø8 mm, 10 mm, 5/16", 3/8", adapter for thread G1/4)

Valve terminals MPA-L

Technical data

Pilot pressure p2 as a function of working pressure p1 with external pilot air supply

For valves with code for position function 1-32: M, J, B, G, E, W, X

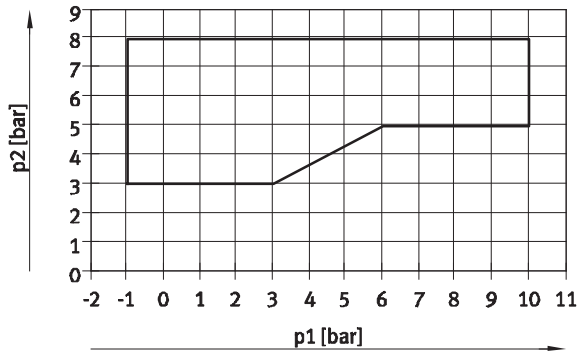

For valves with code for position function 1-32: N, K, H, D, I

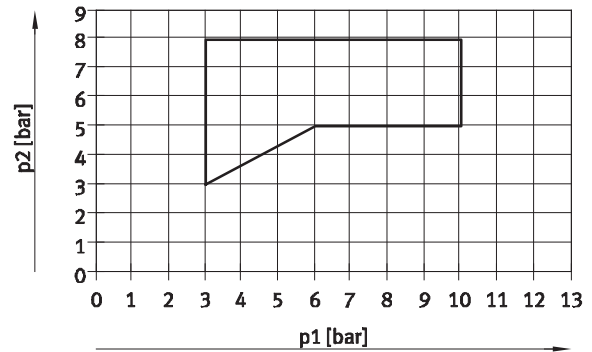

Pilot pressure p2 as a function of working pressure p1 for valves with mechanical spring return

For valves in width 10 mm with code for position function 1-32: MS, NS, KS, HS, DS

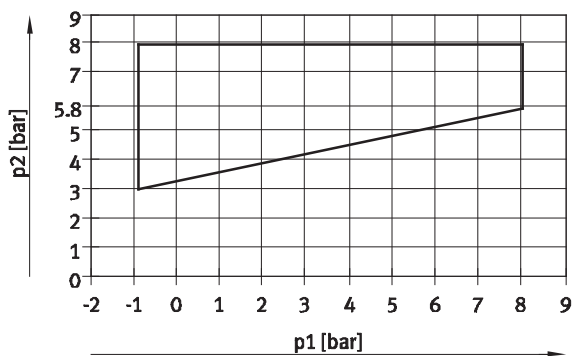

For valves in width 14 mm with code for position function 1-32: NS, KS, HS, DS

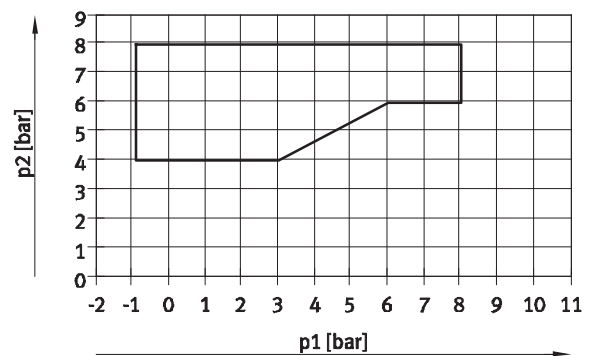

For valves in width 20 mm with code for position function 1-32: MS, NS, KS, HS, DS

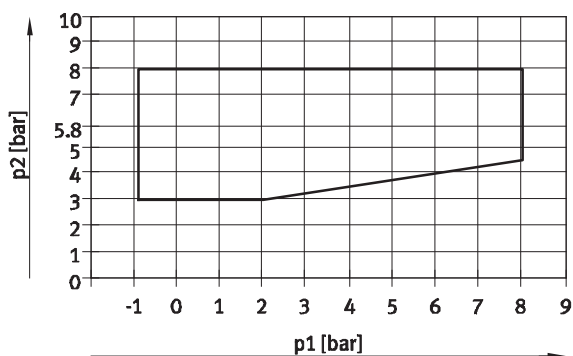

For valves in width 10 mm with code for position function 1-32: MU, NU, KU, HU

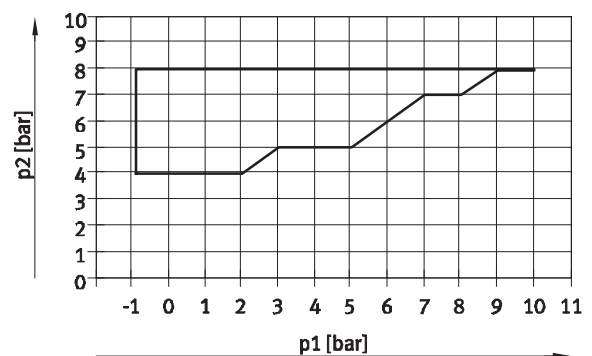

Valve terminals MPA-L

Technical data

Current consumption per solenoid coil at nominal voltage				
		Width		
		10 mm	14 mm	20 mm
Nominal pick-up current	[mA]	50	50	110
Nominal current with current reduction	[mA]	10	10	23
Time until current reduction	[ms]	20	20	20

Electrical data – MPA-L with electrical interface for CPX terminal		
Intrinsic current consumption of valve terminal (internal electronics, without valves)		
At 24 V $U_{EL/SEN}$ ¹⁾	[mA]	Typically 13
At 24 V U_{val} ²⁾	[mA]	Typically 35
Diagnostic message		
Undervoltage U_{OFF} ³⁾	[V]	17.7 ... 17.8

- 1) Power supply for electronics and sensors
- 2) Load voltage supply for valves
- 3) Load voltage outside of function range

Electrical data – MPA-L with I-Port interface/IO-Link		
Intrinsic current consumption of valve terminal (internal electronics, without valves)		
Operating voltage	[mA]	30
Load voltage	[mA]	30

Materials	
Sub-base	PA
Supply module	PPA
End plate	Die-cast aluminium, PA, PBT
Seals	NBR
Exhaust plate	PA
Flat plate silencer	PE
Electrical interlinking module	PBT, PA, copper alloy

Valve terminals MPA-L

Technical data

FESTO

Product weight	
	Approx. weight [g]
CPX module (complete)	Approx. 210
Left-hand end plate, multi-pin plug, Sub-D, 44-pin	130
Left-hand end plate with I-Port interface/IO-Link	170
Supply module with seal, electrical interlinking module	51
Right-hand end plate without supply ports	105
Right-hand end plate with supply ports	160
Valve	→ 39
Supply module with seal, electrical interlinking module	51
Screw for tie rod	3
Threaded rods for tie rod, 5/45/85/125/165/205/245/285/325/365/405/445/485/525 mm	2/11/20/29/38/47/54/65/72/80/89/98/109/118
Sleeve for tie rod, 36/46/56/66 mm	6/8/9/11
Plate for ducted exhaust air/flat plate silencer	36/40
QSM-M7-4-l	4
QSM-M7-6-l	5
QS-G $\frac{1}{4}$ -8-l	22
QS-G $\frac{1}{4}$ -10-l	23
QSPKG10-3	1
QSPKG10-4	1
QSPKG10-6	2
QSPKG20-8	6
QSPKG20-10	9
QSPKG20-12	12

Product weight [g]	Product weight [g]		
	Width 10 mm	Width 14 mm	Width 20 mm
Black sub-base (with seal, fibre-optic cable)	21	33	47
Electrical interlinking module for one sub-base	9	9	14
Electrical interlinking module for combination of four sub-bases	29	–	–
Per vacant position L	24	23	–
Vertical stacking module	74	–	180

Valve terminals MPA-L

Technical data

FESTO

Dimensions

Download CAD Data → www.festo.com/us/cad

Valve terminal with multi-pin plug connection

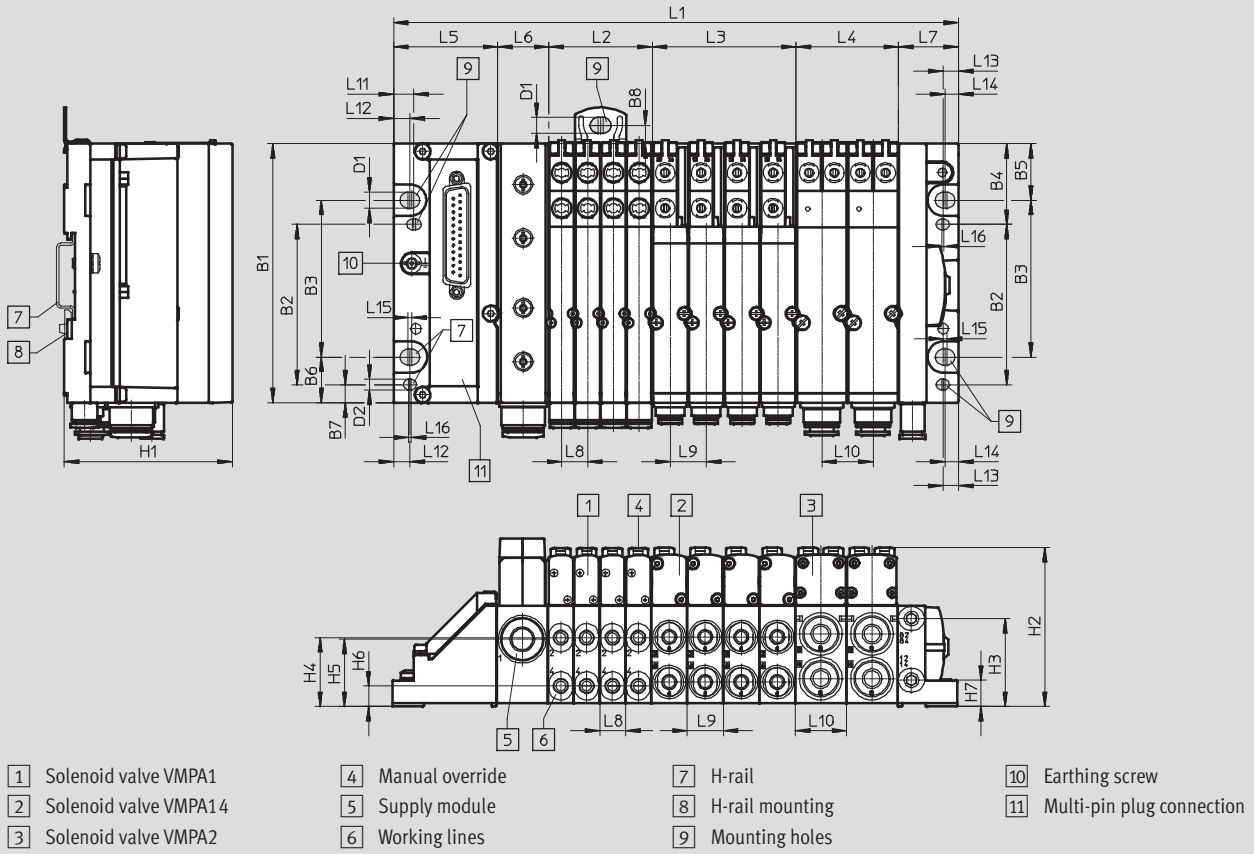

Type	L1 ¹⁾	L2 ¹⁾	L3 ¹⁾	L4 ¹⁾	L5	L6	L7	L8	L9	L10	L11	L12	L13	L14	L15	L16
MPA-L	89.10 + L2 + L3 + L4	m x 10.7	n x 14.9	o x 21.2	43	21.2	24.9	10.7	14.9	21.2	8.5	6.8	6.5	5.6	1.5	1

Type	B1	B2	B3	B4	B5	B6	B7	B8	D1	D2	H1	H2	H3	H4	H5	H6	H7
MPA-L	107.3	66.3	65	33.5	23.5	18.9	7.5	7.5	6.6	4.4	69.6	65.7	36.4	28.5	27.9	8.5	10.9

1) m, n, o = number of sub-bases/valve positions (m = width 10 mm, n = width 14 mm, o = width 20 mm)

Valve terminals MPA-L

Technical data

Dimensions

Download CAD Data → www.festo.com/us/cad

Valve terminal with fieldbus connection

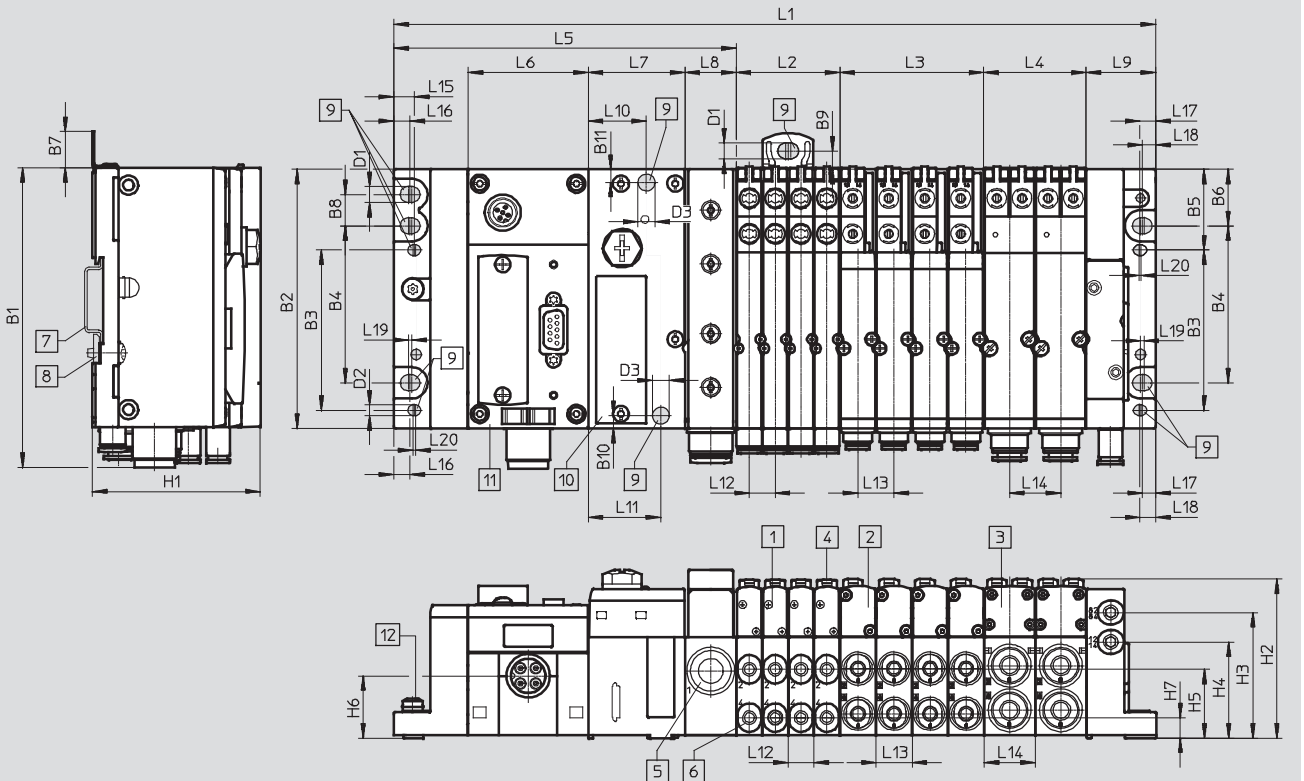

- 1 Solenoid valve VMPA1
- 2 Solenoid valve VMPA14
- 3 Solenoid valve VMPA2
- 4 Manual override
- 5 Supply module
- 6 Working lines
- 7 H-rail
- 8 H-rail mounting
- 9 Mounting holes
- 10 Pneumatic interface for CPX terminal
- 11 CPX module
- 12 Earthing screw

Type	L1 ¹⁾	L2 ¹⁾	L3 ¹⁾	L4 ¹⁾	L5	L6	L7	L8	L9
MPA-L	170.9 + L2 + L3 + L4	m x 10.7	n x 14.9	o x 21.2	141.8	50	40	21.2	28.9

Type	L10	L11	L12	L13	L14	L15	L16	L17	L18	L19	L20
MPA-L	24	30	10.7	14.9	21.2	8.5	6.8	5.6	6.5	1.5	1

Type	B1	B2	B3	B4	B5	B6	B7	B8	B9	B10	B11	D1	D2	D3	H1	H2	H3	H4	H5	H6	H7
MPA-L	124	107.3	66.3	65	33.5	23.5	15	13	7.5	5.3	5.5	6.6	4.4	7	69.6	65.7	52	39.8	28.5	25.8	8.5

1) m, n, o = number of sub-bases/valve positions (m = width 10 mm, n = width 14 mm, o = width 20 mm)

Valve terminals MPA-L

Technical data

FESTO

Dimensions

Download CAD Data → www.festo.com/us/cad

Valve terminal with I-Port interface/IO-Link

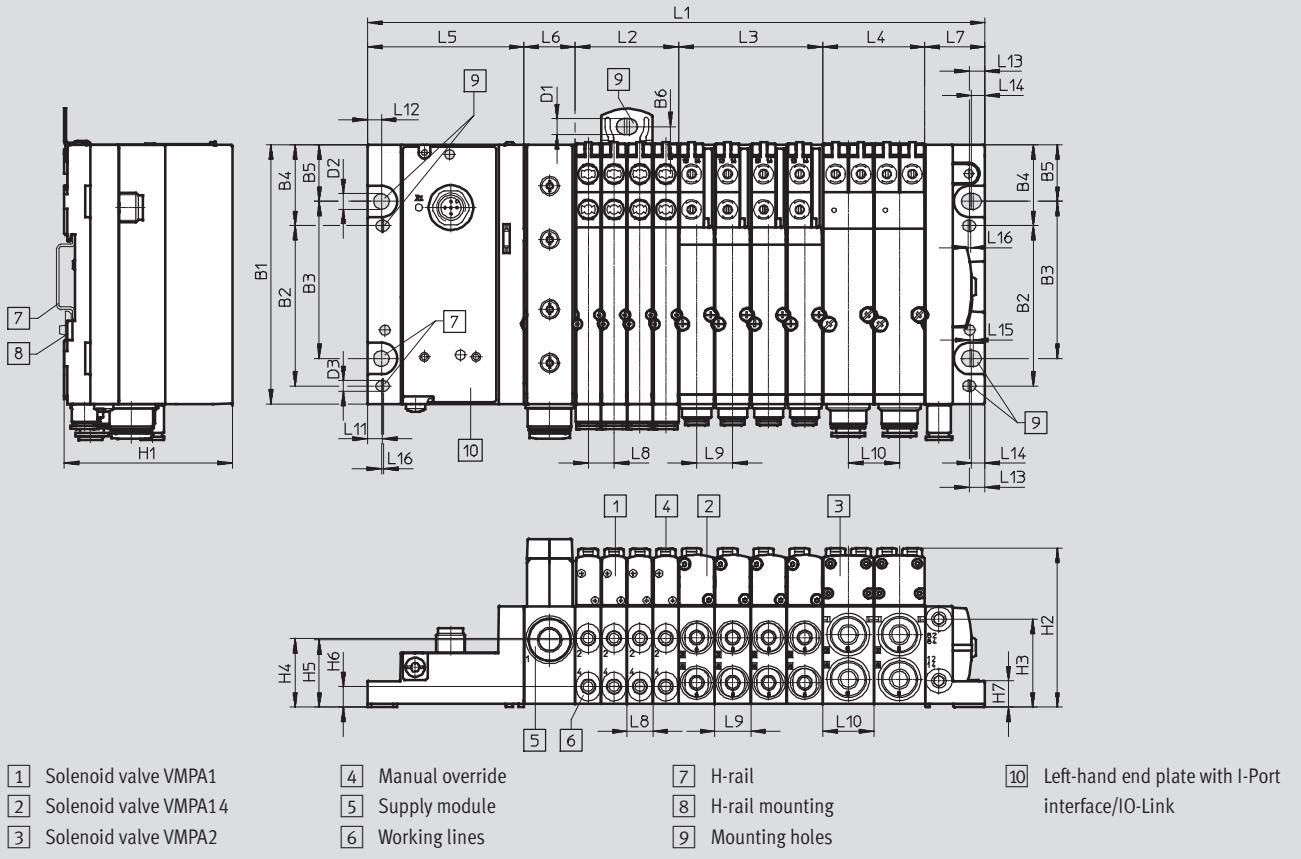

Type	B1	B2	B3	B4	B5	B6	D1	D2	D3	H1	H2	H3	H4	H5	H6	H7
MPA-L	107.3	66.3	65	33.5	23.5	18.9	6.6	6.4	4.5	69.6	65.7	36.4	28.5	27.9	8.5	10.9

Type	L1 ¹⁾	L2 ¹⁾	L3 ¹⁾	L4 ¹⁾	L5	L6	L7	L8	L9	L10	L11	L12	L13	L14	L15	L16
MPA-L	110.9 + L2 + L3 + L4	m x 10.7	n x 14.9	o x 21.2	64.8	21.2	24.9	10.7	14.9	21.2	6.2	5.7	6.5	5.6	1.5	1

1) m, n, o = number of sub-bases/valve positions (m = width 10 mm, n = width 14 mm, o = width 20 mm)

Valve terminals MPA-L

Technical data

Dimensions – Cover for multi-pin plug connection

Download CAD Data → www.festo.com/us/cad

Cable outlet to front

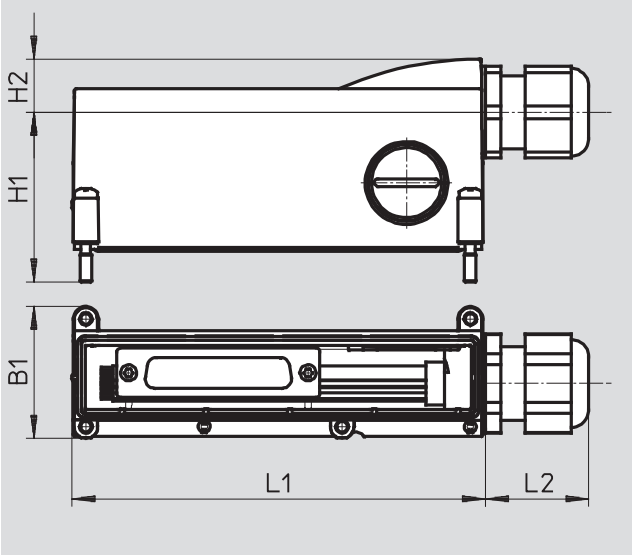

Cable outlet to side

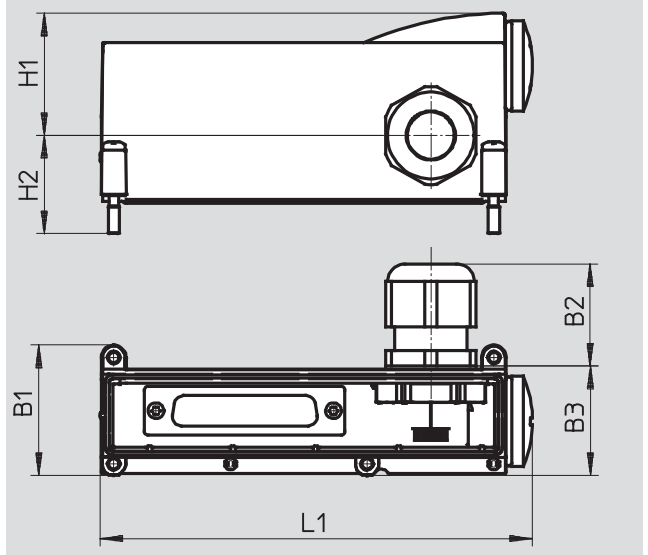

Type	L1	L2	H1	H2	B1	B2	B3
Cable outlet to front	108.3	27	44.4	14	34.5	–	–
Cable outlet to side	114.5	–	32.4	26	34.5	27	29

Valve terminal with vertical stacking (example of a valve terminal with I-Port interface/IO-Link)

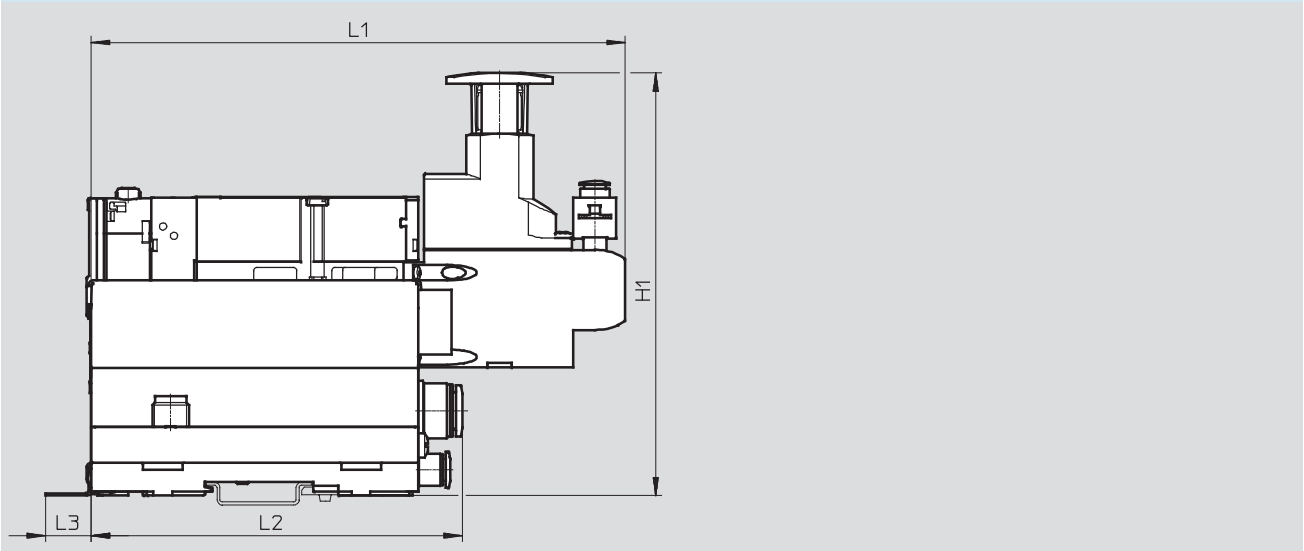

Type	L1	L2	L3	H1
VMPA...B8-R	175.1	120.7	15	138.7

Valve terminals MPA-L



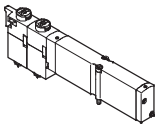
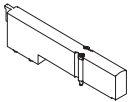



Accessories

Ordering data				
	Code	Valve function	Part No.	Type
Sub-base valve – Width 10 mm				
	5/2-way valve			
	Position function 1-32: M	Single solenoid	533342	VMPA1-M1H-M-PI
	Position function 1-32: MS	Single solenoid, mechanical spring return	571334	VMPA1-M1H-MS-PI
	Position function 1-32: MU	Polymer poppet valve, single solenoid, mechanical spring return	553113	VMPA1-M1H-MU-PI
	Position function 1-32: J	Double solenoid	533343	VMPA1-M1H-J-PI
	2x 3/2-way valve			
	Position function 1-32: N	Normally open	533348	VMPA1-M1H-N-PI
	Position function 1-32: NS	Normally open, mechanical spring return	556839	VMPA1-M1H-NS-PI
	Position function 1-32: NU	Polymer poppet valve, normally open, mechanical spring return	553111	VMPA1-M1H-NU-PI
	Position function 1-32: K	Normally closed	533347	VMPA1-M1H-K-PI
	Position function 1-32: KS	Normally closed, mechanical spring return	556838	VMPA1-M1H-KS-PI
	Position function 1-32: KU	Polymer poppet valve, normally closed, mechanical spring return	553110	VMPA1-M1H-KU-PI
	Position function 1-32: H	1x normally open – 1x normally closed	533349	VMPA1-M1H-H-PI
	Position function 1-32: HS	1x normally open – 1x normally closed, mechanical spring return	556840	VMPA1-M1H-HS-PI
	Position function 1-32: HU	Polymer poppet valve, 1x normally open – 1x normally closed, mechanical spring return	553112	VMPA1-M1H-HU-PI
	5/3-way valve			
	Position function 1-32: B	Mid-position pressurised	533344	VMPA1-M1H-B-PI
	Position function 1-32: G	Mid-position closed	533345	VMPA1-M1H-G-PI
	Position function 1-32: E	Mid-position exhausted	533346	VMPA1-M1H-E-PI
	1x 3/2-way valve			
Position function 1-32: W	Normally open, external compressed air supply	540050	VMPA1-M1H-W-PI	
Position function 1-32: X	Normally closed, external compressed air supply	534415	VMPA1-M1H-X-PI	
2x 2/2-way valve				
Position function 1-32: D	Normally closed	533350	VMPA1-M1H-D-PI	
Position function 1-32: DS	Normally closed, mechanical spring return	556841	VMPA1-M1H-DS-PI	
Position function 1-32: I	1x normally closed 1x normally closed, reversible	543605	VMPA1-M1H-I-PI	
Vacant position – Width 10 mm				
	Position function 1-32: L	Blanking plate for one valve position in width 10 mm A self-adhesive label is supplied	533351	VMPA1-RP

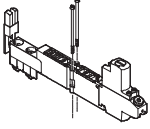
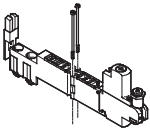
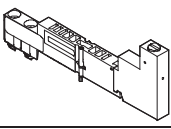
Valve terminals MPA-L

Accessories

FESTO

Ordering data						
	Code	Valve function	Part No.	Type		
Vertical stacking modules – Width 10 mm						
	Pressure regulator 1-32: PF	Pressure regulator plate with fixed threaded connection M5	For port 1	0.5 ... 5	564911	VMPA1-B8-R1-M5-06
	Pressure regulator 1-32: PA			0.5 ... 8.5	564908	VMPA1-B8-R1-M5-10
	Pressure regulator 1-32: PH		For port 2	2 ... 5	564912	VMPA1-B8-R2-M5-06
	Pressure regulator 1-32: PC			2 ... 8.5	564909	VMPA1-B8-R2-M5-10
	Pressure regulator 1-32: PG		For port 4	2 ... 5	564913	VMPA1-B8-R3-M5-06
	Pressure regulator 1-32: PB			2 ... 8.5	564910	VMPA1-B8-R3-M5-10
	Pressure regulator 1-32: PF	Pressure regulator plate with rotatable threaded connection M5	For port 1	0.5 ... 5	549052	VMPA1-B8-R1C2-C-06
	Pressure regulator 1-32: PA			0.5 ... 8.5	543339	VMPA1-B8-R1C2-C-10
	Pressure regulator 1-32: PH		For port 2	2 ... 5	549053	VMPA1-B8-R2C2-C-06
	Pressure regulator 1-32: PC			2 ... 8.5	543340	VMPA1-B8-R2C2-C-10
	Pressure regulator 1-32: PG		For port 4	2 ... 5	549054	VMPA1-B8-R3C2-C-06
	Pressure regulator 1-32: PB			2 ... 8.5	543341	VMPA1-B8-R3C2-C-10
	Pressure regulator 1-32: PS	Vertical pressure shut-off plate For manually separating an individual valve from the compressed air supply for the valve terminal (ducts 1 and 12/14 pilot air supply), operating pressure 3 ... 8 bar			567805	VMPA1-HS
	Pressure gauge 1-32: VE	Screw-in pressure gauge with thread M5 for pressure regulator plate with rotatable threaded connection	Unit bar	132340	MA-15-10-M5	
	Pressure gauge 1-32: VD		Unit psi	132341	MA-15-145-M5-PSI	
	Pressure gauge 1-32: VC	Non-return valve with thread M5 for pressure regulator plate		153291	QSK-M5-4	
Restrictor set – Width 10 mm						
	–	Fixed restrictor, two of each size, two retainers and assembly tool		572543	VMPA1-FT-NW0.3-1.7	
Fixed restrictor – Hollow bolt, for restricting the exhaust air in ducts 3 and 5, 10 pieces – Width 10 mm						
	–	qnN 3.5 ... 5.5 l/min, orange, nominal size 0.3 mm	572544	VMPA1-FT-NW0.3-10		
	–	qnN 9 ... 12 l/min, green, nominal size 0.5 mm	572545	VMPA1-FT-NW0.5-10		
	–	qnN 18 ... 22 l/min, purple, nominal size 0.7 mm	572546	VMPA1-FT-NW0.7-10		
	–	qnN 36 ... 41 l/min, black, nominal size 1.0 mm	572547	VMPA1-FT-NW1.0-10		
	–	qnN 52 ... 58 l/min, red, nominal size 1.2 mm	572548	VMPA1-FT-NW1.2-10		
	–	qnN 81 ... 89 l/min, blue, nominal size 1.5 mm	572549	VMPA1-FT-NW1.5-10		
–	qnN 105 ... 115 l/min, clear, nominal size 1.7 mm	572550	VMPA1-FT-NW1.7-10			
Retainer for fixed restrictor – Width 10 mm						
	–	Retainer for exhaust opening in the sub-base		572542	VMPA1-FTI-10	

Valve terminals MPA-L



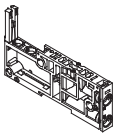
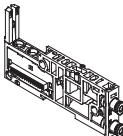
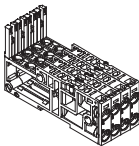
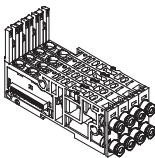
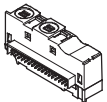
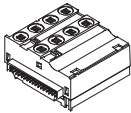

Accessories

FESTO

Ordering data					
	Code	Description	Part No.	Type	
Sub-base – Width 10 mm					
	Duct separation to the right of sub-base 1-40: –	Single, without electrical interlinking module, without cartridge fitting	No duct separation	–	554311 VMPAL-AP-10
	Duct separation to the right of sub-base 1-40: T		Duct 1 separated	–	554312 VMPAL-AP-10-T1
	Duct separation to the right of sub-base 1-40: TR		Ducts 3, 5 separated	–	554313 VMPAL-AP-10-T35
	Duct separation to the right of sub-base 1-40: TS		Ducts 1 and 3, 5 separated	–	554315 VMPAL-AP-10-T135
	–	Single, with electrical interlinking module, single solenoid (for 1 solenoid coil), with cartridge fitting	No duct separation, tubing O.D.	4 mm	560994 VMPAL-AP-10-QS4-1
				6 mm	560987 VMPAL-AP-10-QS6-1
				5/32"	561005 VMPAL-AP-10-QS5/32"-1
				1/4"	560999 VMPAL-AP-10-QS1/4"-1
			Duct 1 separated, tubing O.D.	4 mm	561017 VMPAL-AP-10-QS4-1-T1
				6 mm	561011 VMPAL-AP-10-QS6-1-T1
				5/32"	561029 VMPAL-AP-10-QS5/32"-1-T1
		Single, with electrical interlinking module, double solenoid (for 2 solenoid coils), with cartridge fitting	No duct separation, tubing O.D.	4 mm	560988 VMPAL-AP-10-QS4-2
				6 mm	560993 VMPAL-AP-10-QS6-2
				5/32"	561006 VMPAL-AP-10-QS5/32"-2
				1/4"	561000 VMPAL-AP-10-QS1/4"-2
			Duct 1 separated, tubing O.D.	4 mm	561018 VMPAL-AP-10-QS4-2-T1
				6 mm	561012 VMPAL-AP-10-QS6-2-T1
				5/32"	561030 VMPAL-AP-10-QS5/32"-2-T1
1/4"	561024 VMPAL-AP-10-QS1/4"-2-T1				
Combination of four sub-bases – Width 10 mm					
	Combination manifold block: Z	Without electrical interlinking module, without cartridge fitting	–	–	560981 VMPAL-AP-4x10
	–	With electrical interlinking module, single solenoid (for 1 solenoid coil), with cartridge fitting	No duct separation, tubing O.D.	4 mm	561089 VMPAL-AP-4X10-QS4-1
				6 mm	561083 VMPAL-AP-4X10-QS6-1
				5/32"	561101 VMPAL-AP-4X10-QS5/32"-1
				1/4"	561095 VMPAL-AP-4X10-QS1/4"-1
		With electrical interlinking module, double solenoid (for 2 solenoid coils), with cartridge fitting	No duct separation, tubing O.D.	4 mm	561090 VMPAL-AP-4X10-QS4-2
				6 mm	561084 VMPAL-AP-4X10-QS6-2
				5/32"	561102 VMPAL-AP-4X10-QS5/32"-2
				1/4"	561096 VMPAL-AP-4X10-QS1/4"-2
Electrical interlinking module – Width 10 mm					
	Type of module block 1-40: C	Grey – single solenoid, for one sub-base (with one solenoid coil)			560961 VMPAL-EVAP-10-1
	Type of module block 1-40: A	Black – double solenoid, for one sub-base (with two solenoid coils)			560962 VMPAL-EVAP-10-2
	Type of module block 1-40: C	Grey – single solenoid, for combination of four sub-bases (4 solenoid coils, 4 valve positions)			560967 VMPAL-EVAP-10-1-4
	Type of module block 1-40: A	Black – double solenoid, for combination of four sub-bases (8 solenoid coils, 4 valve positions)			560968 VMPAL-EVAP-10-2-4

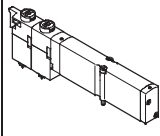
Valve terminals MPA-L

Accessories

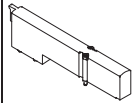
Ordering data				
	Code	Valve function	Part No.	Type
Sub-base valve – Width 14 mm				
	5/2-way valve			
	Position function 1-32: M	Single solenoid	573718	VMPA14-M1H-M-PI
	Position function 1-32: J	Double solenoid	573717	VMPA14-M1H-J-PI
	2x 3/2-way valve			
	Position function 1-32: N	Normally open	573725	VMPA14-M1H-N-PI
	Position function 1-32: NS	Normally open, mechanical spring return	575977	VMPA14-M1H-NS-PI 
	Position function 1-32: K	Normally closed	573724	VMPA14-M1H-K-PI
	Position function 1-32: KS	Normally closed, mechanical spring return	575976	VMPA14-M1H-KS-PI 
	Position function 1-32: H	1x normally open – 1x normally closed	573726	VMPA14-M1H-H-PI
	Position function 1-32: HS	1x normally open – 1x normally closed, mechanical spring return	575979	VMPA14-M1H-HS-PI 
	5/3-way valve			
	Position function 1-32: B	Mid-position pressurised	573719	VMPA14-M1H-B-PI
	Position function 1-32: G	Mid-position closed	573721	VMPA14-M1H-G-PI
	Position function 1-32: E	Mid-position exhausted	573720	VMPA14-M1H-E-PI
2x 2/2-way valve				
Position function 1-32: D	Normally closed	573727	VMPA14-M1H-D-PI	
Position function 1-32: DS	Normally closed, mechanical spring return	575978	VMPA14-M1H-DS-PI 	
Vacant position – Width 14 mm				
	Position function 1-32: L	Blanking plate for one valve position in width 14 mm A self-adhesive label is supplied	573729	VMPA14-RP

Valve terminals MPA-L

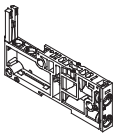
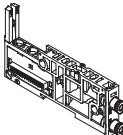
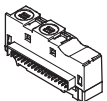

Accessories

FESTO

Ordering data					
	Code	Valve function	Part No.	Type	
Sub-base – Width 14 mm					
	Duct separation to the right of sub-base 1-40: –	Single, without electrical interlinking module, without cartridge fitting	No duct separation	–	560973 VMPAL-AP-14
	Duct separation to the right of sub-base 1-40: T		Duct 1 separated	–	560975 VMPAL-AP-14-T1
	Duct separation to the right of sub-base 1-40: TR		Ducts 3, 5 separated	–	560977 VMPAL-AP-14-T35
	Duct separation to the right of sub-base 1-40: TS		Ducts 1 and 3, 5 separated	–	560979 VMPAL-AP-14-T135
	–	Single, with electrical interlinking module, single solenoid (for 1 solenoid coil), with cartridge fitting	No duct separation, tubing O.D.	6 mm	560995 VMPAL-AP-14-QS6-1
				8 mm	560989 VMPAL-AP-14-QS8-1
				1/4"	561007 VMPAL-AP-14-QS1/4"-1
				5/16"	561001 VMPAL-AP-14-QS5/16"-1
			Duct 1 separated, tubing O.D.	6 mm	561019 VMPAL-AP-14-QS6-1-T1
				8 mm	561013 VMPAL-AP-14-QS8-1-T1
				1/4"	561031 VMPAL-AP-14-QS1/4"-1-T1
				5/16"	561025 VMPAL-AP-14-QS5/16"-1-T1
		Single, with electrical interlinking module, double solenoid (for 2 solenoid coils), with cartridge fitting	No duct separation, tubing O.D.	6 mm	560996 VMPAL-AP-14-QS6-2
				8 mm	560990 VMPAL-AP-14-QS8-2
				1/4"	561008 VMPAL-AP-14-QS1/4"-2
			Duct 1 separated, tubing O.D.	5/16"	561002 VMPAL-AP-14-QS5/16"-2
				6 mm	561020 VMPAL-AP-14-QS6-2-T1
				8 mm	561014 VMPAL-AP-14-QS8-2-T1
		1/4"	561032 VMPAL-AP-14-QS1/4"-2-T1		
		5/16"	561026 VMPAL-AP-14-QS5/16"-2-T1		
Electrical interlinking module – Width 14 mm					
	Type of module block 1-40: F	Grey – single solenoid, for one sub-base (with one solenoid coil)	560963	VMPAL-EVAP-14-1	
	Type of module block 1-40: E	Black – double solenoid, for one sub-base (with two solenoid coils)	560964	VMPAL-EVAP-14-2	

Valve terminals MPA-L

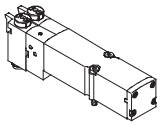
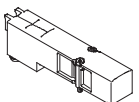
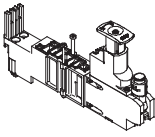
Accessories

Ordering data						
	Code	Valve function	Part No.	Type		
Sub-base valve – Width 20 mm						
	5/2-way valve					
	Position function 1-32: M	Single solenoid	8022034	VMPA2-M1BH-M-PI		
	Position function 1-32: MS	Single solenoid, mechanical spring return	571333	VMPA2-M1H-MS-PI		
	Position function 1-32: J	Double solenoid	8022035	VMPA2-M1BH-J-PI		
	2x 3/2-way valve					
	Position function 1-32: N	Normally open	537958	VMPA2-M1H-N-PI		
	Position function 1-32: NS	Normally open, mechanical spring return	568655	VMPA2-M1H-NS-PI		
	Position function 1-32: K	Normally closed	537957	VMPA2-M1H-K-PI		
	Position function 1-32: KS	Normally closed, mechanical spring return	568656	VMPA2-M1H-KS-PI		
	Position function 1-32: H	1x normally open – 1x normally closed	537959	VMPA2-M1H-H-PI		
	Position function 1-32: HS	1x normally open – 1x normally closed, mechanical spring return	568658	VMPA2-M1H-HS-PI		
	5/3-way valve					
	Position function 1-32: B	Mid-position pressurised	8022036	VMPA2-M1BH-B-PI		
	Position function 1-32: G	Mid-position closed	8022037	VMPA2-M1BH-G-PI		
	Position function 1-32: E	Mid-position exhausted	8022038	VMPA2-M1BH-E-PI		
	1x 3/2-way valve					
	Position function 1-32: W	Normally open, external compressed air supply	8022040	VMPA2-M1BH-W-PI		
	Position function 1-32: X	Normally closed, external compressed air supply	8022039	VMPA2-M1BH-X-PI		
	2x 2/2-way valve					
Position function 1-32: D	Normally closed	537960	VMPA2-M1H-D-PI			
Position function 1-32: DS	Normally closed, mechanical spring return	568657	VMPA2-M1H-DS-PI			
Position function 1-32: I	1x normally closed 1x normally closed, reversible	543703	VMPA2-M1H-I-PI			
Vacant position – Width 20 mm						
	Position function 1-32: L	Blanking plate for one valve position in width 20 mm A self-adhesive label is supplied	537962	VMPA2-RP		
Vertical stacking modules – Width 20 mm						
	Pressure regulator 1-32: PA	Pressure regulator plate (with 10 mm cartridge fitting connection for pressure gauge)	For port 1	0.5 ... 8.5 bar	543342	VMPA2-B8-R1C2-C-10
	Pressure regulator 1-32: PF			0.5 ... 5 bar	549055	VMPA2-B8-R1C2-C-06
	Pressure regulator 1-32: PC		For port 2	2 ... 8.5 bar	543343	VMPA2-B8-R2C2-C-10
	Pressure regulator 1-32: PH			2 ... 5 bar	549056	VMPA2-B8-R2C2-C-06
	Pressure regulator 1-32: PB		For port 4	2 ... 8.5 bar	543344	VMPA2-B8-R3C2-C-10
	Pressure regulator 1-32: PG			2 ... 5 bar	549057	VMPA2-B8-R3C2-C-06
	Pressure regulator 1-32: PL		For port 2, reversible	0.5 ... 8.5 bar	543347	VMPA2-B8-R6C2-C-10
	Pressure regulator 1-32: PN			0.5 ... 5 bar	549113	VMPA2-B8-R6C2-C-06
	Pressure regulator 1-32: PK		For port 4, reversible	0.5 ... 8.5 bar	543348	VMPA2-B8-R7C2-C-10
	Pressure regulator 1-32: PM			0.5 ... 5 bar	549114	VMPA2-B8-R7C2-C-06
	Pressure gauge 1-32: T	Pressure gauge, 10 mm cartridge fitting connection, for pressure regulator plate		0 ... 16 bar	543487	PAGN-26-16-P10
				0 ... 10 bar	543488	PAGN-26-10-P10
	Pressure gauge 1-32: VF	Threaded adapter from 10 mm cartridge fitting connection to thread G1/8			565811	QSP-10-G1/8

Valve terminals MPA-L

Accessories



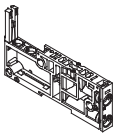
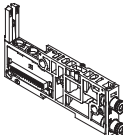
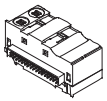

FESTO

Ordering data						
	Code	Description	Part No.	Type		
Sub-base – Width 20 mm						
	Duct separation to the right of sub-base 1-40: –	Single, without electrical interlinking module, without cartridge fitting	No duct separation	–	560974	VMPAL-AP-20
	Duct separation to the right of sub-base 1-40: T		Duct 1 separated	–	560976	VMPAL-AP-20-T1
	Duct separation to the right of sub-base 1-40: TR		Ducts 3, 5 separated	–	560978	VMPAL-AP-20-T35
	Duct separation to the right of sub-base 1-40: TS		Ducts 1 and 3, 5 separated	–	560980	VMPAL-AP-20-T135
	–	Single, with electrical interlinking module, single solenoid (for 1 solenoid coil), with cartridge fitting	No duct separation, tubing O.D.	8 mm	560997	VMPAL-AP-20-QS8-1
				10 mm	560991	VMPAL-AP-20-QS10-1
				5/16"	561009	VMPAL-AP-20-QS5/16"-1
				3/8"	561003	VMPAL-AP-20-QS3/8"-1
			Duct 1 separated, tubing O.D.	8 mm	561021	VMPAL-AP-20-QS8-1-T1
				10 mm	561015	VMPAL-AP-20-QS10-1-T1
				5/16"	561033	VMPAL-AP-20-QS5/16"-1-T1
				3/8"	561027	VMPAL-AP-20-QS3/8"-1-T1
		Single, with electrical interlinking module, double solenoid (for 2 solenoid coils), with cartridge fitting	No duct separation, tubing O.D.	8 mm	560998	VMPAL-AP-20-QS8-2
				10 mm	560992	VMPAL-AP-20-QS10-2
				5/16"	561010	VMPAL-AP-20-QS5/16"-2
			Duct 1 separated, tubing O.D.	3/8"	561004	VMPAL-AP-20-QS3/8"-2
				8 mm	561022	VMPAL-AP-20-QS8-2-T1
				10 mm	561016	VMPAL-AP-20-QS10-2-T1
			5/16"	561034	VMPAL-AP-20-QS5/16"-2-T1	
			3/8"	561028	VMPAL-AP-20-QS3/8"-2-T1	
Electrical interlinking module – Width 20 mm						
	Type of module block 1-40: D	Grey – single solenoid, for one sub-base (with one solenoid coil)	560965	VMPAL-EVAP-20-1		
	Type of module block 1-40: B	Black – double solenoid, for one sub-base (with two solenoid coils)	560966	VMPAL-EVAP-20-2		

Valve terminals MPA-L

Accessories

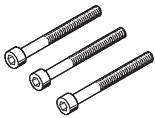





FESTO

Ordering data				
	Code	Description	Part No.	Type
Tie rod				
	Tie rod: –	Threaded rod for tie rod, width across flats 5 mm The threaded rod/sleeve combination is selected based on the number and width of the individual sub-bases.	5 mm	561116 VMPAL-ZAS-5
			45 mm	561117 VMPAL-ZAS-45
			85 mm	561118 VMPAL-ZAS-85
			125 mm	561119 VMPAL-ZAS-125
			165 mm	561120 VMPAL-ZAS-165
			205 mm	561121 VMPAL-ZAS-205
			245 mm	561122 VMPAL-ZAS-245
			285 mm	561123 VMPAL-ZAS-285
			325 mm	561124 VMPAL-ZAS-325
			365 mm	561125 VMPAL-ZAS-365
			405 mm	561126 VMPAL-ZAS-405
			445 mm	561127 VMPAL-ZAS-445
			485 mm	561128 VMPAL-ZAS-485
			525 mm	561129 VMPAL-ZAS-525
			565 mm	561130 VMPAL-ZAS-565
			605 mm	561131 VMPAL-ZAS-605
			645 mm	561132 VMPAL-ZAS-645
685 mm	561133 VMPAL-ZAS-685			
725 mm	561134 VMPAL-ZAS-725			
765 mm	561175 VMPAL-ZAS-765			
805 mm	561176 VMPAL-ZAS-805			
	–	Sleeve, internal hex 4 mm	36 mm	561135 VMPAL-ZAH-36
			46 mm	561136 VMPAL-ZAH-46
			56 mm	561137 VMPAL-ZAH-56
			66 mm	561138 VMPAL-ZAH-66
	–	Tie rod extender for subsequently extending the valve terminal by a sub-base in width	10 mm	561139 VMPAL-ZAE-10
			14 mm	561140 VMPAL-ZAE-14
		Tie rod extender for subsequently extending the valve terminal by a supply module	20 mm	561141 VMPAL-ZAE-20
			20 mm	561141 VMPAL-ZAE-20
	–	Screw M4x30 mm with internal hex 2.5 mm, for tie rod	3 pieces	571924 VMPAL-M-4x30
Screw				
	–	Screw M4x10 mm and nut with internal hex 2.5 mm, for linking four sub-bases	10 pieces	561142 VMPAL-MS-4x10

Valve terminals MPA-L

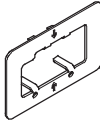
Accessories

FESTO

Ordering data				
	Code	Description	Part No.	Type
Mounting				
	-	Mounting bracket Wall brackets should be mounted max. every 13 cm on the valve terminal	10 pieces	560949 VMPAL-BD
H-rail mounting				
	Mounting accessories: H	MPA-L with multi-pin plug connection	526032	CPX-CPA-BG-NRH
	Mounting accessories: H	MPA-L with fieldbus connection	560798	VMPAF-FB-BG-NRH
Releasing tool				
	-	For releasing the electrical interlinking module from the sub-base	572017	VMPAL-LW
Cover				
	Manual override: N	Cover for manual override, non-detenting (10 pieces)	540897	VMPA-HBT-B
	Manual override: V	Cover for manual override, covered (10 pieces)	540898	VMPA-HBV-B
Inscription label holder/inscription labels				
	Inscription label holder for sub-bases: TM	Holder for inscription label IBS-6x10, 10 pieces	Width 10 mm	561109 VMPAL-ST-AP-10
			Width 14 mm	561112 VMPAL-ST-AP-14
			Width 20 mm	561115 VMPAL-ST-AP-20
	-	Inscription label, 6x10 mm, 64 pieces in frame	18576	IBS-6x10

Valve terminals MPA-L

Accessories

FESTO

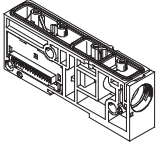
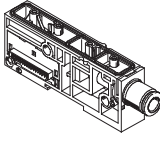
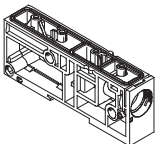
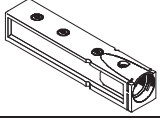
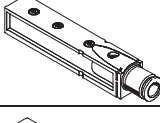
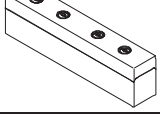
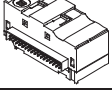
Ordering data				
	Code	Description	Part No.	Type
Supply module				
	Type of module block 1-40: U	With electrical interlinking module, without cartridge fitting	560950	VMPAL-SP-0
	Type of module block 1-40: U	With electrical interlinking module, with cartridge fitting for tubing O.D.	8 mm	573645 VMPAL-SP-QS8
			10 mm	560951 VMPAL-SP-QS10
			12 mm	560952 VMPAL-SP-QS12
			5/16"	573646 VMPAL-SP-QS5/16"
			3/8"	560953 VMPAL-SP-QS3/8"
			1/2"	560954 VMPAL-SP-QS1/2"
	Type of module block 1-40: U	Without electrical interlinking module, without cartridge fitting	570774	VMPAL-SP
Plate				
	Exhaust port: UD, UE, UF, UM, UN, UP or UG	Exhaust plate for ducted exhaust air	560956	VMPAL-EG
	Exhaust port: UE	Exhaust plate for ducted exhaust air, with cartridge fitting for tubing O.D. 10 mm	560957	VMPAL-EG-QS10
	Exhaust port: UN	Exhaust plate for ducted exhaust air, with cartridge fitting for tubing O.D. 3/8"	560959	VMPAL-EG-QS3/8"
	Exhaust port: -	Flat plate silencer	560955	VMPAL-EU
Electrical interlinking module				
	Type of module block 1-40: U	Black for supply module (signals are passed through)	571011	VMPAL-EVAP-20-SP

Valve terminals MPA-L

Accessories

FESTO

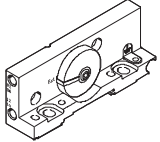
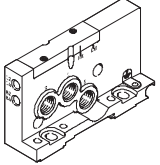
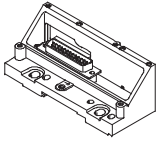
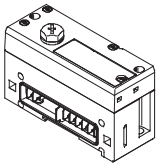
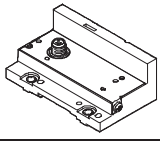



Ordering data				
	Code	Description	Part No.	Type
Right-hand end plate				
	Right-hand end plate: -	Low, with ports 12/14, 82/84, with pilot air selector for choosing the pilot air supply (internal or external)	560945	VMPAL-EPR
	Right-hand end plate: D	High, with ports 1, 3, 5, 12/14, 82/84, with pilot air selector for choosing the pilot air supply (internal or external), reverse operation possible	560947	VMPAL-EPR-SP
Left-hand end plate				
	Electrical connection: MS2	Electrical interface for multi-pin plug connection, IP40	Sub-D, 9-pin, 8 addresses	570777 VMPAL-EPL-SD9-IP40
	Electrical connection: MS1		Sub-D, 25-pin, 24 addresses	560940 VMPAL-EPL-SD25-IP40
	Electrical connection: MS3		Sub-D, 44-pin, 32 addresses	560941 VMPAL-EPL-SD44-IP40
	Electrical connection: MF1		Flat cable, 40-pin, 32 addresses	560942 VMPAL-EPL-FL40-IP40
	Electrical connection: MC		Terminal strip, 33-pin, 32 addresses	560943 VMPAL-EPL-KL33-IP40
	Electrical connection: MS6	Electrical interface for multi-pin plug connection	Sub-D, 25-pin, 24 addresses	560938 VMPAL-EPL-SD25
	Electrical connection: MS8		Sub-D, 44-pin, 32 addresses	560939 VMPAL-EPL-SD44
	Electrical connection: CX	Pneumatic interface for CPX terminal	32 addresses	570783 VMPAL-EPL-CPX
	Electrical connection: LK	Node with IO-Link	32 addresses	575667 VMPAL-EPL-IPO32
	Electrical connection: PT	Node with I-Port interface		

1) A self-adhesive label is supplied.

Valve terminals MPA-L

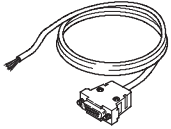
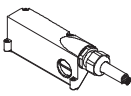
Accessories

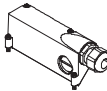



FESTO

Ordering data						
	Code	Description	Part No.	Type		
Connecting cable for multi-pin plug connection with Sub-D plug socket						
	Connecting cable: DA	Socket 9-pin, Sub-D, open cable end 9-pin		2.5 m	531184	KMP6-09P-08-2,5
	Connecting cable: DB			5 m	531185	KMP6-09P-08-5
	Connecting cable: DC			10 m	531186	KMP6-09P-08-10
	–	Socket 25-pin, Sub-D, open cable end 15-pin		2.5 m	530049	KMP6-25P-12-2,5
	–			5 m	530050	KMP6-25P-12-5
	–			10 m	530051	KMP6-25P-12-10
	Connecting cable: DD	Socket 25-pin, Sub-D, open cable end 25-pin		2.5 m	530046	KMP6-25P-20-2,5
	Connecting cable: DK			5 m	530047	KMP6-25P-20-5
	Connecting cable: DF			10 m	530048	KMP6-25P-20-10
	Connecting cable: DG	Socket 44-pin, Sub-D, open cable end 44-pin		2.5 m	575113	NEBV-S1G44-K-2.5-N-LE44-S6
	Connecting cable: DH			5 m	575114	NEBV-S1G44-K-5-N-LE44-S6
	Connecting cable: DJ			10 m	575115	NEBV-S1G44-K-10-N-LE44-S6
		Connecting cable: CA	Cable outlet to front (only with left-hand end plate MS6)	25-pin	2.5 m	560416
Connecting cable: CB		5 m			560417	VMPAL-KM-V-SD25-IP67-5
Connecting cable: CC		10 m			560418	VMPAL-KM-V-SD25-IP67-10
–		0.5 ... 30 m			562389	VMPAL-KM-V-SD25-IP67-X
Connecting cable: CQ		Cable outlet to front (only with left-hand end plate MS6), suitable for use with energy chains	25-pin	2.5 m	560410	VMPAL-KMSK-V-SD25-IP67-2,5
Connecting cable: CR				5 m	560411	VMPAL-KMSK-V-SD25-IP67-5
Connecting cable: CS				10 m	560412	VMPAL-KMSK-V-SD25-IP67-10
–				0.5 ... 30 m	562391	VMPAL-KMSK-V-SD25-IP67-X
Connecting cable: CJ		Cable outlet to front (only with left-hand end plate MS8)	44-pin	2.5 m	560422	VMPAL-KM-V-SD44-IP67-2,5
Connecting cable: CK				5 m	560423	VMPAL-KM-V-SD44-IP67-5
Connecting cable: CL				10 m	560424	VMPAL-KM-V-SD44-IP67-10
–				0.5 ... 30 m	562390	VMPAL-KM-V-SD44-IP67-X
		Connecting cable: CD	Cable outlet to side (only with left-hand end plate MS6)	25-pin	2.5 m	560419
	Connecting cable: CE	5 m			560420	VMPAL-KM-S-SD25-IP67-5
	Connecting cable: CH	10 m			560421	VMPAL-KM-S-SD25-IP67-10
	–	0.5 ... 30 m			562392	VMPAL-KM-S-SD25-IP67-X
	Connecting cable: CT	Cable outlet to side (only with left-hand end plate MS6), suitable for use with energy chains	25-pin	2.5 m	560413	VMPAL-KMSK-S-SD25-IP67-2,5
	Connecting cable: CU			5 m	560414	VMPAL-KMSK-S-SD25-IP67-5
	Connecting cable: CV			10 m	560415	VMPAL-KMSK-S-SD25-IP67-10
	–			0.5 ... 30 m	562394	VMPAL-KMSK-S-SD25-IP67-X
	Connecting cable: CM	Cable outlet to side (only with left-hand end plate MS8)	44-pin	2.5 m	560425	VMPAL-KM-S-SD44-IP67-2,5
	Connecting cable: CN			5 m	560426	VMPAL-KM-S-SD44-IP67-5
	Connecting cable: CP			10 m	560427	VMPAL-KM-S-SD44-IP67-10
	–			0.5 ... 30 m	562393	VMPAL-KM-S-SD44-IP67-X
	Cover for multi-pin plug connection without connecting cable with Sub-D plug socket					
	Electrical multi-pin plug cover: EZ	Cable outlet to side or front (only with left-hand end plate MS6)	25-pin	–	560428	VMPAL-KM-SD25-IP67-0
	Electrical multi-pin plug cover: EY	Outlet either to the side or front (only with left-hand end plate MS8)	44-pin	–	560429	VMPAL-KM-SD44-IP67-0
Plug connector						
	–	Pre-assembled plug connector for flat cable, 40-pin, for flat cable cross section 0.08 ... 0.13 mm ²			570895	NECU-FCG40-K

Valve terminals MPA-L

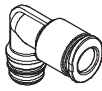
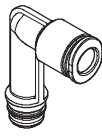
Accessories

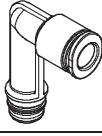
FESTO

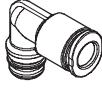
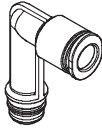

Ordering data							
	Code	Description	Part No.	Type	PU ¹⁾		
Cartridge fitting for sub-base in width 10 mm							
	Standard connection for valve size 10 mm:	AA	10 mm cartridge fitting, plastic, for working lines, connection for tubing O.D.	3 mm	132621	QSPKG10-3	10
		AB		4 mm	132622	QSPKG10-4	10
		–		6 mm	132623	QSPKG10-6	10
		AJ		1/8"	132852	QSPKG10-1/8-U	10
		AQ		5/32"	132624	QSPKG10-5/32-U	10
		AK		3/16"	132625	QSPKG10-3/16-U	10
		AL		1/4"	132626	QSPKG10-1/4-U	10
		–	10 mm cartridge fitting, nickel-plated brass, for working lines, connection for tubing O.D.	4 mm	172972	QSP10-4	10
		–		6 mm	172973	QSP10-6	10
			–	10 mm cartridge fitting, plastic, L-shape, for working lines, connection for tubing O.D.	3 mm	132853	QSPLKG10-3
4 mm	132920				QSPLKG10-4	10	
6 mm	132921				QSPLKG10-6	10	
1/8"	132854				QSPLKG10-1/8-U	10	
5/32"	132922				QSPLKG10-5/32-U	10	
3/16"	132923				QSPLKG10-3/16-U	10	
1/4"	132924				QSPLKG10-1/4-U	10	
	–	10 mm cartridge fitting, plastic, long L-shape, for working lines, connection for tubing O.D.	3 mm	132861	QSPLLKG10-3	10	
			4 mm	132925	QSPLLKG10-4	10	
			6 mm	132926	QSPLLKG10-6	10	
			1/8"	132862	QSPLLKG10-1/8-U	10	
			5/32"	132927	QSPLLKG10-5/32-U	10	
			3/16"	132928	QSPLLKG10-3/16-U	10	
			1/4"	132929	QSPLLKG10-1/4-U	10	
Cartridge fitting for sub-base in width 14 mm							
	Standard connection for valve size 14 mm:	BC	14 mm cartridge fitting, plastic, for working lines, connection for tubing O.D.	6 mm	132930	QSPKG14-6	10
		–		8 mm	132931	QSPKG14-8	10
		BL		1/4"	132932	QSPKG14-1/4-U	10
		BQ		5/16"	132933	QSPKG14-5/16-U	10
	–	14 mm cartridge fitting, plastic, L-shape, for working lines, connection for tubing O.D.	6 mm	132938	QSPLKG14-6	10	
			8 mm	132939	QSPLKG14-8	10	
			1/4"	132940	QSPLKG14-1/4-U	10	
			5/16"	132941	QSPLKG14-5/16-U	10	
	–	14 mm cartridge fitting, plastic, long L-shape, for working lines, connection for tubing O.D.	6 mm	132942	QSPLLKG14-6	10	
			8 mm	132943	QSPLLKG14-8	10	
			1/4"	132944	QSPLLKG14-1/4-U	10	
			5/16"	132945	QSPLLKG14-5/16-U	10	
Cartridge fitting for sub-base in width 20 mm							
	Standard connection for valve size 20 mm:	CD	18 mm cartridge fitting, plastic, for working lines, connection for tubing O.D.	8 mm	132649	QSPKG18-8	10
		–		10 mm	132650	QSPKG18-10	10
		CQ		5/16"	132651	QSPKG18-5/16-U	10
		CT		3/8"	132652	QSPKG18-3/8-U	10
	–	18 mm cartridge fitting, plastic, L-shape, for working lines, connection for tubing O.D.	8 mm	132946	QSPLKG18-8	10	
			10 mm	132947	QSPLKG18-10	10	
			5/16"	132948	QSPLKG18-5/16-U	10	
			3/8"	132949	QSPLKG18-3/8-U	10	
	–	18 mm cartridge fitting, plastic, long L-shape, for working lines, connection for tubing O.D.	8 mm	132950	QSPLLKG18-8	10	
			10 mm	132951	QSPLLKG18-10	10	
			5/16"	132952	QSPLLKG18-5/16-U	10	
			3/8"	132953	QSPLLKG18-3/8-U	10	

1) Packaging unit.

Valve terminals MPA-L

Accessories

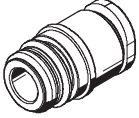
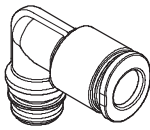
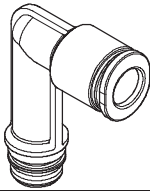
FESTO









Ordering data						
	Code	Description	Part No.	Type	PU ¹⁾	
Cartridge fitting for supply module						
	-	20 mm cartridge fitting, plastic, for supply ports, connection for tubing O.D.	8 mm	132633	QSPKG20-8	10
			10 mm	132634	QSPKG20-10	10
			12 mm	132635	QSPKG20-12	10
			5/16"	132636	QSPKG20-5/16-U	10
			3/8"	132637	QSPKG20-3/8-U	10
			1/2"	132638	QSPKG20-1/2-U	10
	-	20 mm cartridge fitting, plastic, L-shape, for supply ports, connection for tubing O.D.	8 mm	132855	QSPLKG20-8	10
			10 mm	132856	QSPLKG20-10	10
			12 mm	132857	QSPLKG20-12	10
			5/16"	132858	QSPLKG20-5/16-U	10
			3/8"	132859	QSPLKG20-3/8-U	10
			1/2"	132860	QSPLKG20-1/2-U	10
	-	20 mm cartridge fitting, plastic, long L-shape, for supply ports, connection for tubing O.D.	8 mm	132863	QSPLLKG20-8	10
			10 mm	132864	QSPLLKG20-10	10
			12 mm	132865	QSPLLKG20-12	10
			5/16"	132866	QSPLLKG20-5/16-U	10
			3/8"	132867	QSPLLKG20-3/8-U	10
			1/2"	132868	QSPLLKG20-1/2-U	10
Adapter for sub-bases						
	Standard connection for valve size 10 mm: AGG	Adapter from 10 mm cartridge fitting connection to thread M7	572380	VMPAL-F10-M7	10	
	Standard connection for valve size 14 mm: BGG	Adapter from 14 mm cartridge fitting connection to thread G1/8	574084	VMPAL-F14-G1/8	10	
	Standard connection for valve size 20 mm: CGG	Adapter from 18 mm cartridge fitting connection to thread G1/4	573914	VMPAL-F20-G1/4	10	
Adapter for supply module/plate						
	-	Adapter from 20 mm cartridge fitting connection to thread G1/4	572381	VMPAL-FSP-G1/4	10	

1) Packaging unit.

Valve terminals MPA-L

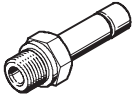
Accessories

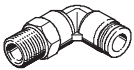
FESTO



Ordering data						
	Code	Description	Part No.	Type	PU ¹⁾	
Push-in fitting						
	-	Connecting thread M7 with sealing ring, with internal hex, for tubing O.D.	4 mm	153319	QSM-M7-4-I	10
			6 mm	153321	QSM-M7-6-I	10
	-	Connecting thread G1/4 with sealing ring, with internal hex, for tubing O.D.	6 mm	186108	QS-G1/4-6-I	10
	-	Connecting thread G1/4 with sealing ring, with external hex, for tubing O.D.	6 mm	186097	QS-G1/4-6	10
			8 mm	186099	QS-G1/4-8	10
			10 mm	186101	QS-G1/4-10	10
		Connecting thread G1/4, metal, with external hex, for tubing O.D.	6 mm	193411	QS-F-G1/4-6	10
			8 mm	193412	QS-F-G1/4-8	10
			10 mm	193413	QS-F-G1/4-10	10
			12 mm	533848	QS-F-G1/4-12	10
	-	Connecting thread G1/4, metal, with internal hex, for tubing O.D.	8 mm	533930	QS-F-G1/4-8-I	10
			10 mm	533931	QS-F-G1/4-10-I	10
	-	Connecting thread G1/4, metal, with push-in sleeve ∅	6 mm	533881	QS-F-G1/4-6H	10
			8 mm	533882	QS-F-G1/4-8H	10
			10 mm	533883	QS-F-G1/4-10H	10
			12 mm	533884	QS-F-G1/4-12H	10
	-	Connecting thread G1/4, with external hex, flame-retardant, for tubing O.D.	6 mm	186316	QS-VO-G1/4-6	10
			8 mm	186317	QS-VO-G1/4-8	10
			10 mm	186318	QS-VO-G1/4-10	10
Push-in L-connector						
	-	Push-in sleeve ∅	6 mm	153057	QSL-6H	10
			8 mm	153058	QSL-8H	10
		Long push-in sleeve ∅	6 mm	153066	QSL-6HL	10
	-	Push-in fitting with sealing ring, connecting thread M7, with external hex, for tubing O.D.	4 mm	186352	QSML-M7-4	10
				130773	QSML-M7-4-100	100
			6 mm	186353	QSML-M7-6	10
		130774	QSML-M7-6-100	100		
	-	Long push-in fitting with sealing ring, connecting thread M7, with external hex, for tubing O.D.	4 mm	186354	QSMML-M7-4	10
			6 mm	186355	QSMML-M7-6	10
	-	Push-in fitting with sealing ring, connecting thread G1/4, with external hex, for tubing O.D.	6 mm	186118	QSL-G1/4-6	10
			8 mm	186120	QSL-G1/4-8	10
			10 mm	186122	QSL-G1/4-10	10
		Push-in fitting, metal, with sealing ring, connecting thread G1/4, with external hex, for tubing O.D.	6 mm	193421	QSL-F-G1/4-6	10
			8 mm	193422	QSL-F-G1/4-8	10
10 mm			193423	QSL-F-G1/4-10	10	
Long push-in fitting, metal, connecting thread G1/4, with external hex, for tubing O.D.		6 mm	533853	QSL-F-G1/4-12	10	
		6 mm	556846	QSLL-F-G1/4-6	10	
		8 mm	556847	QSLL-F-G1/4-8	10	
	10 mm	556848	QSLL-F-G1/4-10	10		
	12 mm	556849	QSLL-F-G1/4-12	10		
	-	Push-in fitting, connecting thread G1/4, with internal hex, for tubing O.D.	6 mm	186149	QSLV-G1/4-6-I	10
			8 mm	186151	QSLV-G1/4-8-I	10

1) Packaging unit.

Valve terminals MPA-L

Accessories

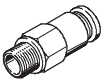
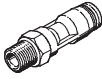
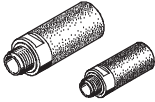
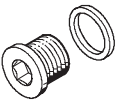
FESTO

Ordering data						
	Code	Description	Part No.	Type	PU ¹⁾	
Push-in fitting, self-sealing						
	-	With sealing ring, with external hex, connecting thread G1/4, for tubing O.D.	6 mm	186296	QSK-G1/4-6	1
			8 mm	186298	QSK-G1/4-8	1
			10 mm	186300	QSK-G1/4-10	1
		With sealing ring, with external hex, L shape, connecting thread G1/4, for tubing O.D.	6 mm	186306	QSKL-G1/4-6	1
			8 mm	186308	QSKL-G1/4-8	1
			10 mm	186310	QSKL-G1/4-10	1
Rotary push-in fitting						
	-	With external hex, connecting thread G1/4, for tubing O.D.	6 mm	186278	QSR-G1/4-6	1
			8 mm	186280	QSR-G1/4-8	1
		With external hex, L-shape, connecting thread G1/4, for tubing O.D.	6 mm	186287	QSRL-G1/4-6	1
			8 mm	186289	QSRL-G1/4-8	1
Silencer						
	-	Connecting thread	M7	161418	UC-M7	1
				534218	UC-M7-50	50
			G1/4	165004	UC-1/4	1
				534220	UC-1/4-20	20
Blanking plug						
	-	Thread	M7	174309	B-M7	10
			G3/8	3570	B-3/8	10
		Cartridge fitting	10 mm	172976	QSP10-PTB	1
			14 mm	172987	QSP14-PTB	1
			18 mm	172996	QSP17-PTB	1
Manual						
	Documentation: DE	MPA-L Pneumatic Components	German	556353	P.BE-MPAL-DE	
	Documentation: EN		English	556354	P.BE-MPAL-EN	
	Documentation: FR		French	556356	P.BE-MPAL-FR	
	Documentation: ES		Spanish	556355	P.BE-MPAL-ES	
	Documentation: IT		Italian	556357	P.BE-MPAL-IT	
	Documentation: SV		Swedish	556358	P.BE-MPAL-SV	

1) Packaging unit.

Product Range and Company Overview

A Complete Suite of Automation Services

Our experienced engineers provide complete support at every stage of your development process, including: conceptualization, analysis, engineering, design, assembly, documentation, validation, and production.



Custom Automation Components
Complete custom engineered solutions



Custom Control Cabinets
Comprehensive engineering support and on-site services



Complete Systems
Shipment, stocking and storage services

The Broadest Range of Automation Components

With a comprehensive line of more than 30,000 automation components, Festo is capable of solving the most complex automation requirements.



Electromechanical
Electromechanical actuators, motors, controllers & drives



Pneumatics
Pneumatic linear and rotary actuators, valves, and air supply



PLCs and I/O Devices
PLC's, operator interfaces, sensors and I/O devices

Supporting Advanced Automation... As No One Else Can!

Festo is a leading global manufacturer of pneumatic and electromechanical systems, components and controls for industrial automation, with more than 12,000 employees in 56 national headquarters serving more than 180 countries. For more than 80 years, Festo has continuously elevated the state of manufacturing with innovations and optimized motion control solutions that deliver higher performing, more profitable automated manufacturing and processing equipment. Our dedication to the advancement of automation extends beyond technology to the education and development of current and future automation and robotics designers with simulation tools, teaching programs, and on-site services.

Quality Assurance, ISO 9001 and ISO 14001 Certifications

Festo Corporation is committed to supply all Festo products and services that will meet or exceed our customers' requirements in product quality, delivery, customer service and satisfaction.

To meet this commitment, we strive to ensure a consistent, integrated, and systematic approach to management that will meet or exceed the requirements of the ISO 9001 standard for Quality Management and the ISO 14001 standard for Environmental Management.



© Copyright 2008, Festo Corporation. While every effort is made to ensure that all dimensions and specifications are correct, Festo cannot guarantee that publications are completely free of any error, in particular typing or printing errors. Accordingly, Festo cannot be held responsible for the same. For Liability and Warranty conditions, refer to our "Terms and Conditions of Sale", available from your local Festo office. All rights reserved. No part of this publication may be reproduced, distributed, or transmitted in any form or by any means, electronic, mechanical, photocopying or otherwise, without the prior written permission of Festo. All technical data subject to change according to technical update.



Printed on recycled paper at New Horizon Graphic, Inc., FSC certified as an environmentally friendly printing plant.

Festo North America

Festo Regional Contact Center

5300 Explorer Drive
Mississauga, Ontario L4W 5G4
Canada

USA Customers:

For ordering assistance,

Call: 1.800.99.FESTO (1.800.993.3786)

Fax: 1.800.96.FESTO (1.800.963.3786)

Email: customer.service@us.festo.com

For technical support,

Call: 1.866.GO.FESTO (1.866.463.3786)

Fax: 1.800.96.FESTO (1.800.963.3786)

Email: product.support@us.festo.com

Canadian Customers:

Call: 1.877.GO.FESTO (1.877.463.3786)

Fax: 1.877.FX.FESTO (1.877.393.3786)

Email: festo.canada@ca.festo.com

USA Headquarters

Festo Corporation
395 Moreland Road
P.O. Box 18023
Hauppauge, NY 11788, USA
www.festo.com/us

USA Sales Offices

Appleton

North 922 Tower View Drive, Suite N
Greenville, WI 54942, USA

Boston

120 Presidential Way, Suite 330
Woburn, MA 01801, USA

Chicago

1441 East Business Center Drive
Mt. Prospect, IL 60056, USA

Dallas

1825 Lakeway Drive, Suite 600
Lewisville, TX 75057, USA

Detroit – Automotive Engineering Center

2601 Cambridge Court, Suite 320
Auburn Hills, MI 48326, USA

New York

395 Moreland Road
Hauppauge, NY 11788, USA

Silicon Valley

4935 Southfront Road, Suite F
Livermore, CA 94550, USA

United States



USA Headquarters, East: Festo Corp., 395 Moreland Road, Hauppauge, NY 11788

Phone: 1.631.435.0800; Fax: 1.631.435.8026;

Email: info@festo-usa.com

www.festo.com/us

Canada



Headquarters: Festo Inc., 5300 Explorer Drive, Mississauga, Ontario L4W 5G4

Phone: 1.905.624.9000; Fax: 1.905.624.9001;

Email: festo.canada@ca.festo.com

www.festo.ca

Mexico



Headquarters: Festo Pneumatic, S.A., Av. Ceylán 3, Col. Tequesquahuac,
54020 Tlalneantla, Edo. de México

Phone: 011 52 [55] 53 21 66 00; Fax: 011 52 [55] 53 21 66 65;

Email: festo.mexico@mx.festo.com

www.festo.com/mx

Central USA

Festo Corporation
1441 East Business
Center Drive
Mt. Prospect, IL 60056, USA
Phone: 1.847.759.2600
Fax: 1.847.768.9480



Western USA

Festo Corporation
4935 Southfront Road,
Suite F
Livermore, CA 94550, USA
Phone: 1.925.371.1099
Fax: 1.925.245.1286



Festo Worldwide

Argentina Australia Austria Belarus Belgium Brazil Bulgaria Canada Chile China Colombia Croatia Czech Republic Denmark
Estonia Finland France Germany Great Britain Greece Hong Kong Hungary India Indonesia Iran Ireland Israel Italy Japan Latvia
Lithuania Malaysia Mexico Netherlands New Zealand Norway Peru Philippines Poland Romania Russia Serbia Singapore
Slovakia Slovenia South Africa South Korea Spain Sweden Switzerland Taiwan Thailand Turkey Ukraine United States Venezuela

www.festo.com