

Solenoid/pneumatic valves, ISO 15407-1

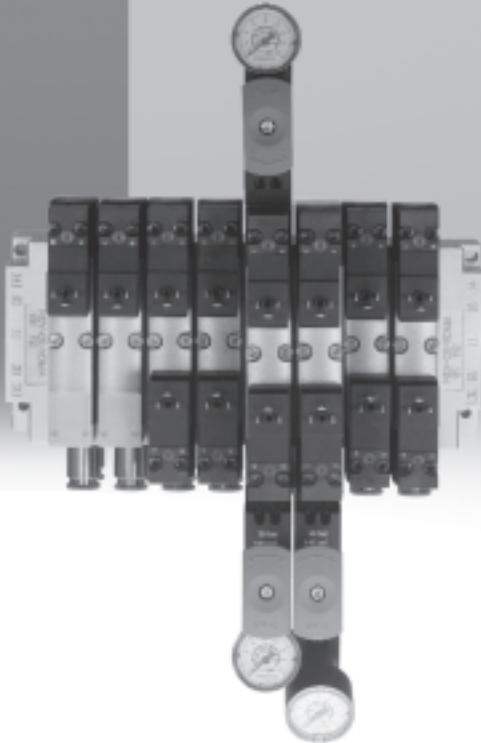

Solenoid/pneumatic valves, ISO 15407-1

Key features

FESTO

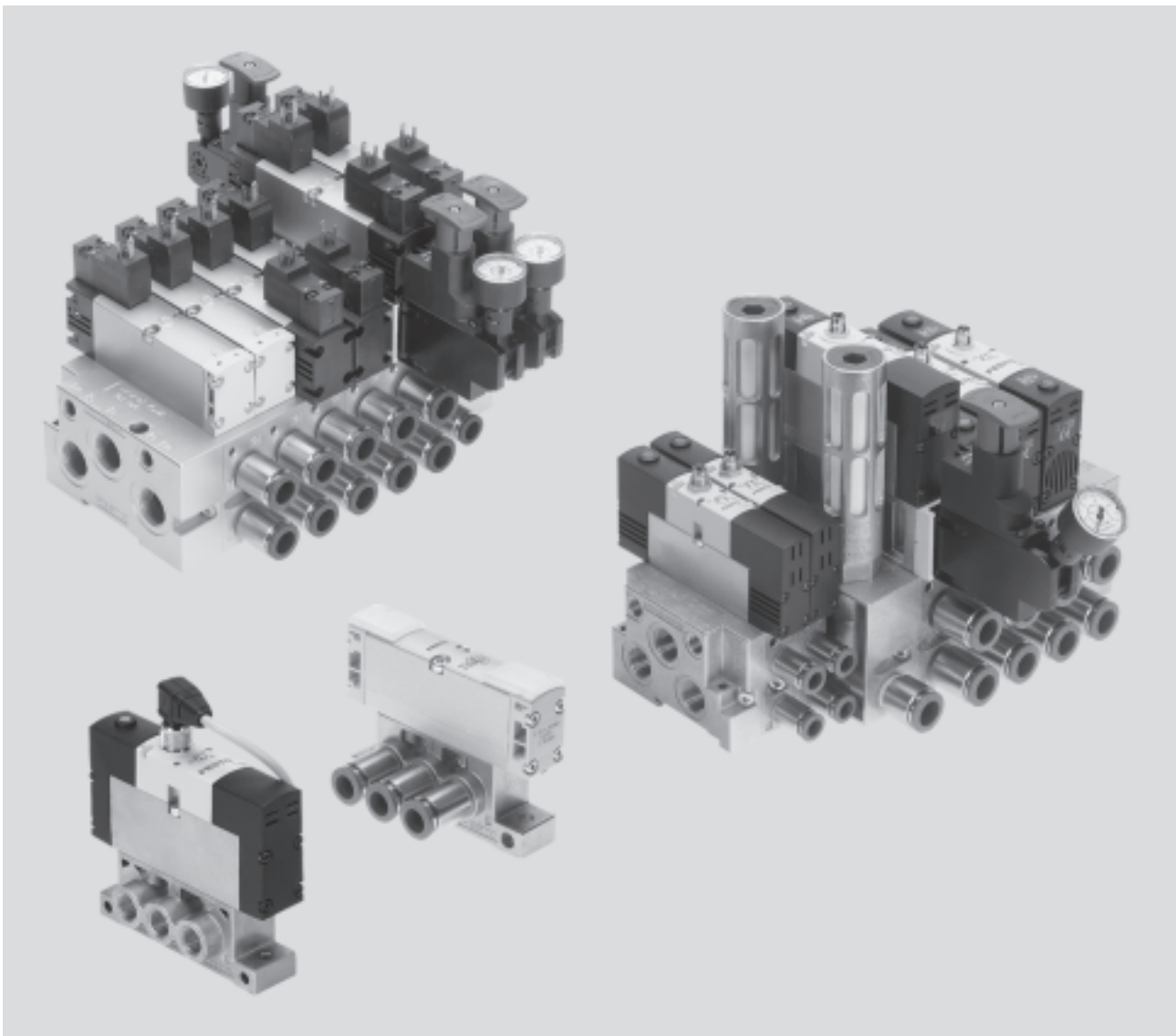

Innovative

- High-performance valves in sturdy metal housing
- Individual electrical connection via square plug sockets or via round plug sockets
- Valve replacement under pressure possible using vertical pressure shut-off plate
- Reverse operation
- Vacuum operation

Flexible

- Modular system offering a range of configuration options
- Conversions and extensions are possible at any time
- Integration of innovative function modules possible
 - Regulator plate
 - Flow control plate
 - Vertical pressure shut-off plate
 - Vertical supply plate
- Vertical supply plates permit a flexible air supply and variable pressure zones
- Wide range of valve functions
- Extensive operating voltage range from 12 V DC to 230 V AC

Reliable

- Sturdy and durable metal components
 - Valves
 - Horizontal stacking plates
 - Vertical stacking plates
- Fast troubleshooting thanks to LEDs
 - in the plug socket or
 - in the illuminating seal or
 - in the valve
- Reliability of service thanks to valves that can be replaced easily and quickly
- Manual override
- Durable thanks to the use of tried-and-tested piston spool valves

Easy to assemble

- Secure wall mounting or H-rail mounting
- Combi manifolds of width 18 mm and 26 mm
- Plug-in pressure gauges on the pressure regulator

Solenoid/pneumatic valves, ISO 15407-1

Key features

Individual valve manifold

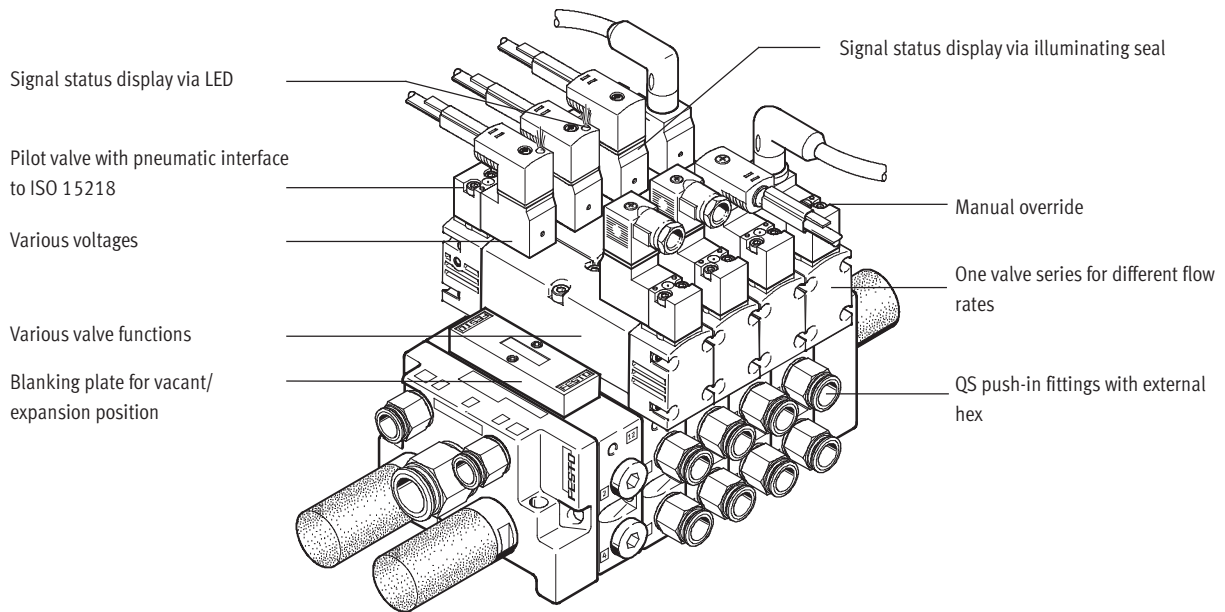

Equipment options

5/2-way valve

- Single solenoid, pneumatic or spring return
- Double solenoid
- Double solenoid with dominant signal at 14

2x 3/2-way valve, single solenoid

- Normally open
- Normally open, reversible (on request)
- Normally closed
- Normally closed, reversible (on request)

- 1x normally open, 1x normally closed
- 1x normally open, 1x normally closed, reversible (on request)

5/3-way valve, single solenoid

- Mid-position valve
 - Normally open
 - Normally closed
 - Normally exhausted

2x 2/2-way valve, single solenoid

- Normally closed

Special features

Operation with external pilot air

- For vacuum applications
- For working pressures lower than 3 bar
- For significant pressure fluctuations in the power section. Power section and pneumatic control section are decoupled
- For heavily lubricated air in the power section
- For manifolds if the pressure zones are created via ducts 3 and 5 (not possible with 2x 3/2)
- For manifolds or pressure zones that are equipped with reversible 2x 3/2-way valves (valves on request)

Operation with internal pilot air

- For small pressure fluctuations in the power section
- For using pressure regulator plates in a vertical stacking construction, also in reverse operation
- As a low-cost solution

Reverse operation with pressure supply via ducts 3 and 5

- Pressure zone separation via ducts 3 and 5
 - Example: Duct 3 vacuum, duct 5 ejector pulse
 - Example: Duct 3 high pressure for advancing the piston rod of a double-acting cylinder. Duct 5 low pressure for retracting the piston rod with low energy consumption
- 2x 3/2-way valves used as 5/4-way valve with controllable overlapping with the reversible variant

Reverse operation with a pressure regulator plate, compressed air supply via duct 1

- Reversible pressure regulator combined with a reversible 2x 3/2-way valve regulates outputs 2 and 4
 - AB regulator for outputs 2 and 4
 - A regulator for output 4
 - B regulator for output 2
- Reversible pressure regulators are in the control position immediately after the power supply is switched on
 - Adjustment possible at all times
 - Dynamic response characteristics
 - Reduced regulator load because the supply pressure is maintained when the valve is switched
 - Venting not via the regulator

Solenoid/pneumatic valves, ISO 15407-1

Key features

FESTO

Valve manifold with combination of sizes and vertical stacking

Solenoid valve with individual pilot valves and pneumatic interface to ISO 15218. Can be connected with square plug sockets or round plugs

Widths of 18 mm and 26 mm can be combined

Solenoid valve with central round plug

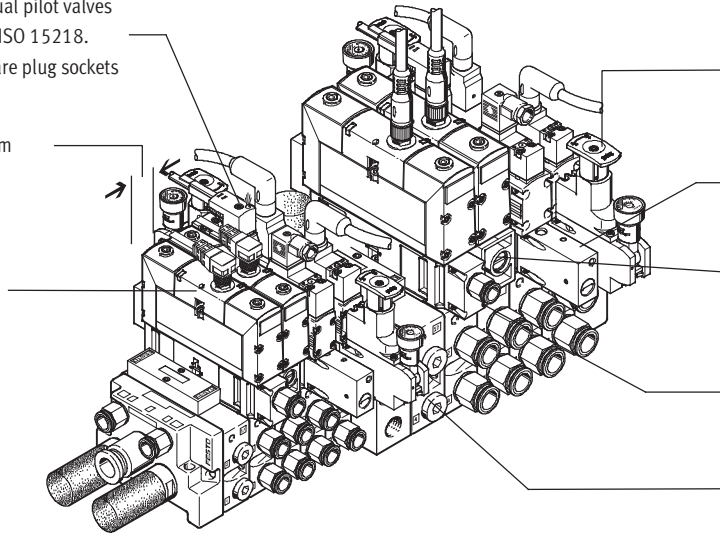

Pressure regulator for adjusting the force of the actuated drive

Pressure shut-off plate for solenoid valve replacement during operation

Flow control plate in the valve manifold for adjusting the speed of the drive

Supply plate for compressed air supply of a control chain as a separate pressure zone

Intermediate plate as interface between width 18 mm and width 26 mm

Vertical stacking function

Pressure regulator

- Single variant to regulate the pressure at output 4(A) or 2(B) or at input 1(P)
- Dual variant to regulate the pressure at output 4(A) and 2(B) individually
- Reverse variant for the outputs so that the regulator is in the control position
- With pressure gauge connection

Flow control plate

- Designed with two flow control valves, on which the exhaust air flow rate at exhausts 5 or 3 can be adjusted. This movement of the drive can thus be initiated and the desired speed set on the manifold using the manual override

Vertical pressure shut-off plate

- Equipped with a switch via which the compressed air supply can be shut off. A directional control valve or subsequent vertical stacking plate can thus be replaced without switching off the overall air supply
- If the control chain has a redundant connection, the cycle can continue even in the case of a cyclical control system

Vertical supply plate

- As additional air supply for one valve
- To supply a third pressure zone

Individual connection with square plug, type C

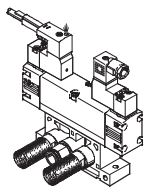

The directional control valve has a pilot control to ISO 15218 and a plug pattern to EN 175301-803, type C.

Individual connection with central round plug

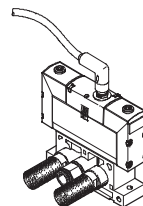

The electrical connection is established using a standardised M12- or M8 socket 24 V DC (EN 61076-2-101).

Solenoid/pneumatic valves, ISO 15407-1

Key features

FESTO

Individual valve manifold, directional control valves with square plug, type C

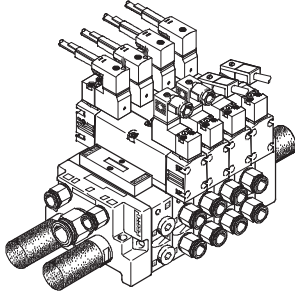

Variant

- Width 26 mm
- Vacant position
- Compressed air supply via duct 1
- External pilot air supply
- QS push-in fittings
- Venting via silencer for ducts 3 and 5

Individual valve manifold, pressure zones via ducts 3 and 5

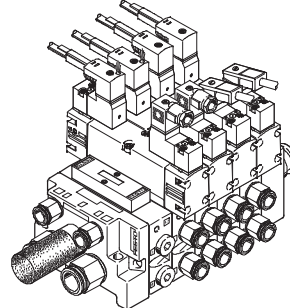

Variant

- Width 26 mm
- Vacant position
- Compressed air supply via ducts 3 and 5
- External pilot air supply
- QS push-in fittings
- Venting via silencer

Valve manifold equipped with width 18 mm and 26 mm, directional control valves with square plug, type C

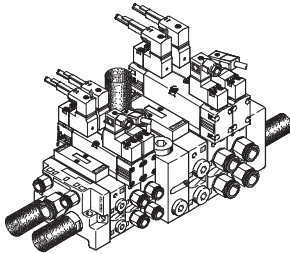

Variant

- Width 18 mm and 26 mm combined via intermediate plate
- Vacant positions
- Compressed air supply via duct 1
- External pilot air supply
- QS push-in fittings
- Venting via silencer for ducts 3 and 5 on the end plates and for duct 3 also on the intermediate plate

Valve manifold equipped with width 18 mm and 26 mm, directional control valves with central round plug

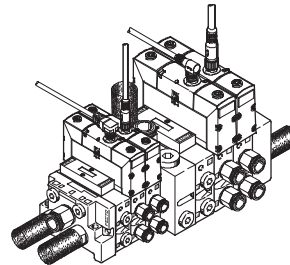

Variant

- Width 18 mm and 26 mm combined via intermediate plate
- Vacant positions
- Compressed air supply via duct 1
- Internal pilot air supply
- QS push-in fittings
- Venting via silencer for ducts 3 and 5 on the end plates and for duct 3 also on the intermediate plate

Maximum valve manifold expansion with all vertical stacking components

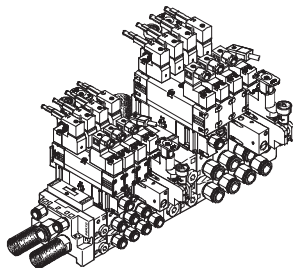

Variant

- Width 18 mm and 26 mm combined via intermediate plate
- Directional control valves with square plug
- Pressure regulators
- Flow control plates
- Pressure shut-off plates
- Supply plates with vacant position

Individual valve manifold with cable routing in one direction

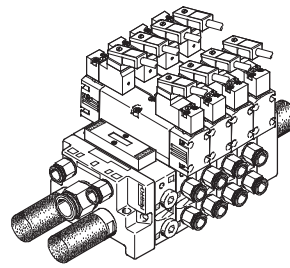

Variant

- Width 26 mm
- Solenoid coils 220 V DC
- Plug socket with cable KMEB-2
 - With plug socket with cable KMEB-1 the outgoing direction of the cable cannot be chosen with AC coils.

Pneumatically actuated directional control valve on individual sub-base

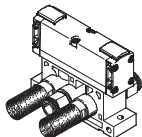

Directional control valves on an individual sub-base can be used for drives that are further away from a valve manifold or when there is only one drive available.

Valve manifold equipped with width 18 mm and 26 mm with pneumatically actuated directional control valves

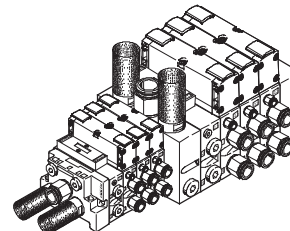

Variant

- Width 18 mm and 26 mm combined via intermediate plate
- Vacant positions
- Compressed air supply via duct 1
- QS push-in fittings
- Venting via silencer for ducts 3 and 5 on the end plates and for ducts 3 and 5 also on the intermediate plate

Solenoid/pneumatic valves, ISO 15407-1

Key features

FESTO

Solenoid valves with square plug, type C

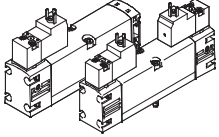

- Variants
- Width 18 mm and 26 mm
 - 2x 2/2-way, 2x 3/2-way, 5/2-way and 5/3-way valves
 - 2x 3/2-way valves for reverse operation
 - Internal or external pilot air supply available
 - 12, 24 V DC, 24, 110 or 220 V AC

Solenoid valves with central round plug

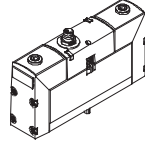

- Variants
- Width 18 mm and 26 mm
 - 2x 3/2-way, 5/2-way and 5/3-way valves
 - Internal or external pilot air supply available
 - 24 V DC

Basic valves with interface to ISO 15218

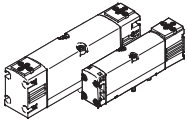

- Variants
- Width 18 mm and 26 mm
 - 2x 2/2-way, 2x 3/2-way, 5/2-way and 5/3-way valves
 - Internal or external pilot air supply available

Solenoid valves with M12 round plug

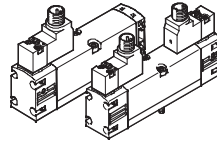

- Variants
- Width 18 mm and 26 mm
 - 2x 2/2-way, 2x 3/2-way, 5/2-way and 5/3-way valves
 - 2x 3/2-way valves for reverse operation
 - Internal or external pilot air supply available
 - 24 V DC

Pilot valve with interface to ISO 15218

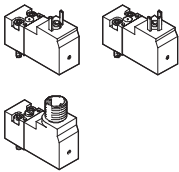

- Variants
- With square plug, type C or M12 round plug
 - For 12, 24 V DC and 24 V AC without protective earth conductor
 - For 110 and 220 V AC with protective earth conductor
 - 3/2-way valve
 - Manual override non-detenting or non-detenting/detenting

Pneumatically actuated directional control valves

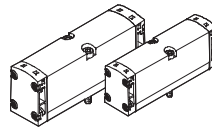

- Variants
- Width 18 mm and 26 mm
 - 2x 3/2-way, 5/2-way and 5/3-way valves
 - Signal inputs 12 and 14 via the sub-base

Individual sub-base

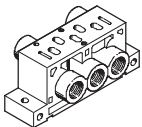

- Variants
- Width 18 mm and 26 mm
 - Ports 12 and 14 for external pilot air supply for solenoid valves and
 - Ports signal inputs 12 and 14 for pneumatically actuated valves are the same

Blanking plate for vacant position

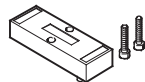

- Variants
- Width 18 mm and 26 mm

End plate kit

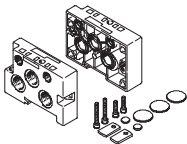

- Variants
- Width 18 mm and 26 mm
 - Ports 12 and 14 for external pilot air supply for solenoid valves
 - For pneumatically actuated valves the signal inputs are only on the manifold sub-base suitable for this purpose

Manifold sub-base/series sub-base

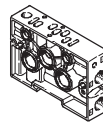

- Variants
- Width 18 mm and 26 mm
 - For solenoid valves
 - For pneumatically actuated valves with additional ports for the signal inputs

Intermediate plate

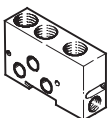

- Variants
- Adapter between width 18 mm and 26 mm
 - With additional air supply port and exhaust ports

Intermediate plate kit

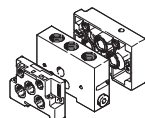

- Variants
- Intermediate plate as adapter between width 18 mm and 26 mm
 - One 18 mm and one 26 mm end plate

Solenoid/pneumatic valves, ISO 15407-1

Key features

FESTO

Pressure regulator plate with one pressure regulator

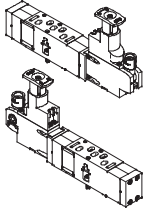

Variants

- Width 18 mm and 26 mm
- For pressure regulation on the supply input 1 (P). Set pressure is the same for outputs 2 and 4
- For pressure regulation on the working port 4 (A)
 - The pressure regulator for reverse operation is supplied via port 1 of the sub-base and supplies port 5 on the directional control valve
 - The directional control valve vents via port 1 to ports 3 and 5 of the sub-base
- For pressure regulation on the working port 2 (B)
 - In reverse operation input 3 is supplied here

Pressure regulator plate with two pressure regulators

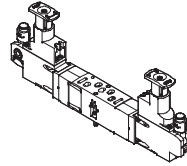

Variants

- Width 18 mm and 26 mm
- For pressure regulation on the working ports 4 (A) and 2 (B)
 - The pressure regulators for reverse operation are supplied via port 1 of the sub-base and supply inputs 5 and 3 on the directional control valve
 - The directional control valve vents via port 1 to ports 3 and 5 of the sub-base

Vertical supply plate

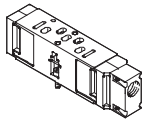

Variants

- Width 18 mm and 26 mm
- As intermediate supply
 - For one valve
 - To supply a third pressure zone
- Can be equipped with a directional control valve

Flow control plate

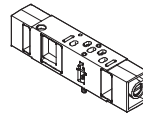

Variants

- Width 18 mm and 26 mm
- Exhaust air restriction in ducts 3 and 5
 - The flow control plates function as supply air restrictors for pressure zones that are formed via ducts 3 and 5

Vertical pressure shut-off plate

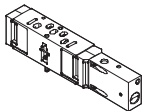

Variants

- Width 18 mm and 26 mm
- A switch activated with a slotted screwdriver shuts off duct 1.
 - The overlying flow control plates, pressure regulator plates or directional control valves can be replaced
 - Other components of the control chain such as drives, for example, can be replaced following venting via the directional control valve

Pressure gauge



Variant

- Can be connected to the pressure regulator plates

Solenoid/pneumatic valves, ISO 15407-1

Key features

FESTO

Port pattern on sub-base to ISO 15407-1

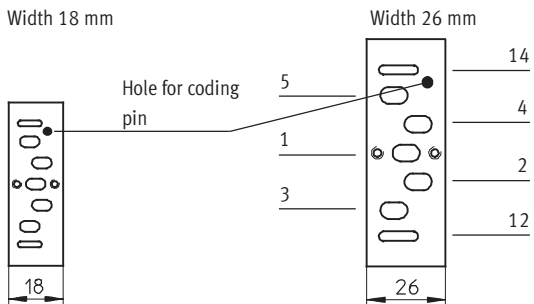

VSVA

Conversion of pilot air venting

VSVA valve manifolds are supplied with unducted ventilation of the pilot air. By turning the seal between the

valve and manifold block, ventilation (pilot air) can be diverted into pilot



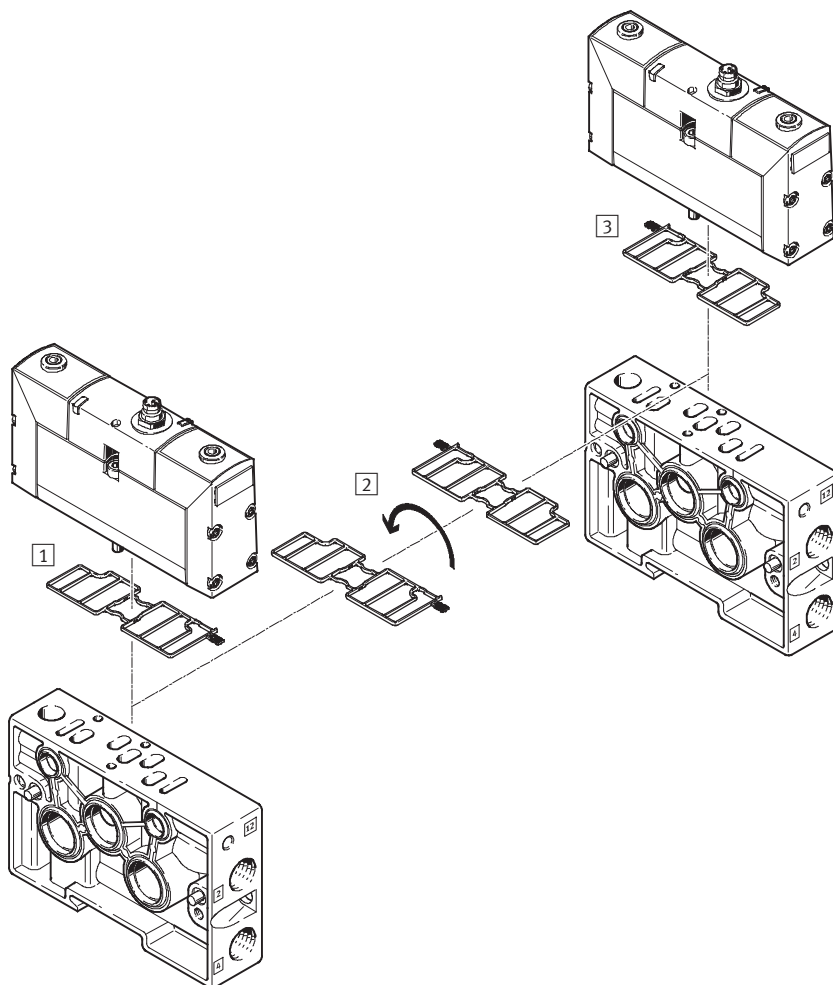







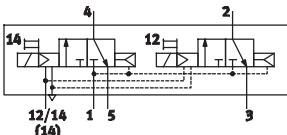







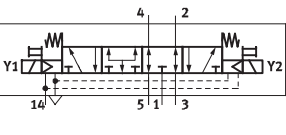



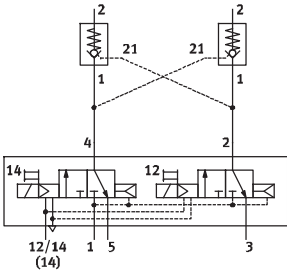







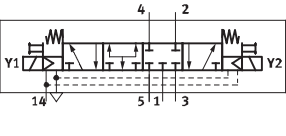



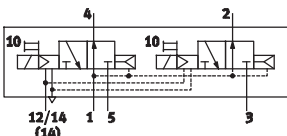







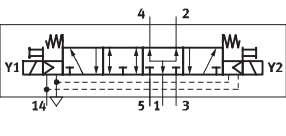



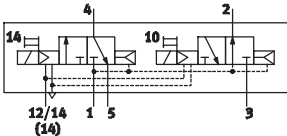

duct 12 and can thus be contained and silenced (see Figure).

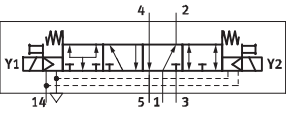

- 1 Ducted pilot air venting
- 2 Turning of seal by 180°
- 3 Unducted pilot air venting (as supplied)

Solenoid/pneumatic valves, ISO 15407-1





Key features

Use of 2x 3/2-way valve as 5/4-way valve																			
Code	Circuit symbol	Value table	Equivalent circuit symbol	Function															
K		<table border="1"> <thead> <tr> <th>Y1</th> <th>Y2</th> <th>A</th> </tr> </thead> <tbody> <tr> <td>0</td> <td>0</td> <td></td> </tr> <tr> <td>0</td> <td>1</td> <td></td> </tr> <tr> <td>1</td> <td>0</td> <td></td> </tr> <tr> <td>1</td> <td>1</td> <td></td> </tr> </tbody> </table>	Y1	Y2	A	0	0		0	1		1	0		1	1			<ul style="list-style-type: none"> • Normally exhausted • The double-acting drive connected to outputs 2 and 4 is unpressurised when the valve is in the normal position and can be moved by an external force • If there is a signal present at Y1(14) and Y2(12), there is pressure at outputs 2 and 4
Y1	Y2	A																	
0	0																		
0	1																		
1	0																		
1	1																		
		<table border="1"> <thead> <tr> <th>Y1</th> <th>Y2</th> <th>A</th> </tr> </thead> <tbody> <tr> <td>0</td> <td>0</td> <td></td> </tr> <tr> <td>0</td> <td>1</td> <td></td> </tr> <tr> <td>1</td> <td>0</td> <td></td> </tr> <tr> <td>1</td> <td>1</td> <td></td> </tr> </tbody> </table>	Y1	Y2	A	0	0		0	1		1	0		1	1			<ul style="list-style-type: none"> • Normally closed (by combining directional control valve code K and two piloted non-return valves) • The piloted non-return valves connected to outputs 2 and 4 are unpressurised when the valve is in the normal position and the pressures in the drive close the non-return valves leak-tight • The drive stops when the forces are in equilibrium • Leakages can only occur via the drive seals • If there is a signal present at Y1(14) and Y2(12), the same pressure is present at outputs 2 and 4
Y1	Y2	A																	
0	0																		
0	1																		
1	0																		
1	1																		
N		<table border="1"> <thead> <tr> <th>Y1</th> <th>Y2</th> <th>A</th> </tr> </thead> <tbody> <tr> <td>0</td> <td>0</td> <td></td> </tr> <tr> <td>0</td> <td>1</td> <td></td> </tr> <tr> <td>1</td> <td>0</td> <td></td> </tr> <tr> <td>1</td> <td>1</td> <td></td> </tr> </tbody> </table>	Y1	Y2	A	0	0		0	1		1	0		1	1			<ul style="list-style-type: none"> • Normally open • The double-acting drive connected to outputs 2 and 4 is supplied with the same compressed air at both ends when the valve is in the normal position and stops when the forces are in equilibrium • If there is a signal present at Y1(10) and Y2(10), outputs 2 and 4 are exhausted, the drive is unpressurised and can be moved by an external force
Y1	Y2	A																	
0	0																		
0	1																		
1	0																		
1	1																		
H		<table border="1"> <thead> <tr> <th>Y1</th> <th>Y2</th> <th>A</th> </tr> </thead> <tbody> <tr> <td>0</td> <td>0</td> <td></td> </tr> <tr> <td>0</td> <td>1</td> <td></td> </tr> <tr> <td>1</td> <td>0</td> <td></td> </tr> <tr> <td>1</td> <td>1</td> <td></td> </tr> </tbody> </table>	Y1	Y2	A	0	0		0	1		1	0		1	1			<ul style="list-style-type: none"> • Normally open after output 2 • The double-acting drive connected to outputs 2 and 4 is supplied with compressed air via output 2 when the valve is in the normal position. Output 4 is exhausted. The drive is thus in a clearly defined position in the initial position of the system, as would also be the case with a single solenoid 5/2-way valve • If there is a signal present at Y1(14) and Y2(10), output 2 is exhausted and there is pressure at output 4. The drive leaves the initial position • A closed circuit can be created with this 2x 3/2-way valve by combining it with piloted non-return valves. However, this is then selected by an active signal at Y2(10)
Y1	Y2	A																	
0	0																		
0	1																		
1	0																		
1	1																		

Solenoid/pneumatic valves, ISO 15407-1

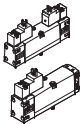
FESTO

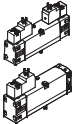
Product range overview

Function	Type	Valve function	Flow rate Valve [l/min]	Working line on the sub-base		Operating voltage					
				G $\frac{1}{8}$	G $\frac{1}{4}$	[V DC]		[V AC]			
						12	24	24	110	230	
Width 18 mm	Valve with pilot interface to ISO 15218										
		VSVA-B-T22...A2	2x 2/2-way valve, single solenoid	700	■	–	■	■	■	■	■
		VSVA-B-T32...A2	2x 3/2-way valve, single solenoid	600	■	–	■	■	■	■	■
		VSVA-B-M52...A2	5/2-way valve, single solenoid	750	■	–	■	■	■	■	■
		VSVA-B-B52...A2	5/2-way valve, double solenoid	750	■	–	■	■	■	■	■
		VSVA-B-P53...A2	5/3-way valve, mid-position valve	650	■	–	■	■	■	■	■
	Valve with central plug										
		VSVA-B-T32...A2	2x 3/2-way valve, single solenoid	600	■	–	–	■	–	–	–
		VSVA-B-M52...A2	5/2-way valve, single solenoid	750	■	–	–	■	–	–	–
		VSVA-B-B52...A2	5/2-way valve, double solenoid	750	■	–	–	■	–	–	–
		VSVA-B-P53...A2	5/3-way valve, mid-position valve	650	■	–	–	■	–	–	–
	Pneumatic valve										
		VSPA-B-T32...A2	2x 3/2-way valve, monostable	550	■	–	–	–	–	–	–
		VSPA-B-M52...A2	5/2-way valve, monostable	700	■	–	–	–	–	–	–
		VSPA-B-B52...A2	5/2-way valve, bistable	700	■	–	–	–	–	–	–
VSPA-B-P53...A2		5/3-way valve, mid-position valve	650	■	–	–	–	–	–	–	
Width 26 mm	Valve with pilot interface to ISO 15218										
		VSVA-B-T22...A1	2x 2/2-way valve, single solenoid	1,350	–	■	■	■	■	■	■
		VSVA-B-T32...A1	2x 3/2-way valve, single solenoid	1,250	–	■	■	■	■	■	■
		VSVA-B-M52...A1	5/2-way valve, single solenoid	1,400	–	■	■	■	■	■	■
		VSVA-B-B52...A1	5/2-way valve, double solenoid	1,400	–	■	■	■	■	■	■
		VSVA-B-P53...A1	5/3-way valve, mid-position valve	1,400	–	■	■	■	■	■	■
	Valve with central plug										
		VSVA-B-T32...A1	2x 3/2-way valve, single solenoid	1,250	–	■	–	■	–	–	–
		VSVA-B-M52...A1	5/2-way valve, single solenoid	1,400	–	■	–	■	–	–	–
		VSVA-B-B52...A1	5/2-way valve, double solenoid	1,400	–	■	–	■	–	–	–
		VSVA-B-P53...A1	5/3-way valve, mid-position valve	1,400	–	■	–	■	–	–	–
	Pneumatic valve										
		VSPA-B-T32...A1	2x 3/2-way valve, monostable	1,250	–	■	–	–	–	–	–
		VSPA-B-M52...A1	5/2-way valve, monostable	1,400	–	■	–	–	–	–	–
		VSPA-B-B52...A1	5/2-way valve, bistable	1,400	–	■	–	–	–	–	–
VSPA-B-P53...A1		5/3-way valve, mid-position valve	1,400	–	■	–	–	–	–	–	

Solenoid/pneumatic valves, ISO 15407-1

Product range overview

Plug			Pilot air			→ Page/ Internet
Square	Round plug		Internal	External		
MEB	M8x1	M12x1				
Valve with pilot interface to ISO 15218						
■	-	■	■	■	Pneumatic spring return, normally closed	20
■	-	■	■	■	Pneumatic spring return, normally closed, open, 1x open/1x closed	20
■	-	■	■	■	Pneumatic or mechanical spring return	20
■	-	■	■	■	Dominance: 1st signal or at 14	20
■	-	■	■	■	Normally closed, exhausted, open	20
Valve with central plug						
-	■	■	■	■	Pneumatic spring return, normally closed, open, 1x open/1x closed	36
-	■	■	■	■	Pneumatic or mechanical spring return	36
-	■	■	■	■	Dominance: 1st signal or at 14	36
-	■	■	■	■	Normally closed, exhausted, open	36
Pneumatic valve						
-	■	■	■	■	Pneumatic spring return, normally closed, open, 1x open/1x closed	36
-	■	■	■	■	Pneumatic or mechanical spring return	36
-	■	■	■	■	Dominance: 1st signal or at 14	36
-	■	■	■	■	Normally closed, exhausted, open	36
Valve with pilot interface to ISO 15218						
■	-	■	■	■	Pneumatic spring return, normally closed	28
■	-	■	■	■	Pneumatic spring return, normally closed, open, 1x open/1x closed	28
■	-	■	■	■	Dominance: 1st signal or at 14	28
■	-	■	■	■	Normally closed, exhausted, open	28
■	-	■	■	■	Normally closed, exhausted, open	28
Valve with central plug						
-	■	■	■	■	Pneumatic spring return, normally closed, open, 1x open/1x closed	41
-	■	■	■	■	Dominance: 1st signal or at 14	41
-	■	■	■	■	Normally closed, exhausted, open	41
-	■	■	■	■	Normally closed, exhausted, open	41
Pneumatic valve						
-	■	■	■	■	Pneumatic spring return, normally closed, open, 1x open/1x closed	41
-	■	■	■	■	Dominance: 1st signal or at 14	41
-	■	■	■	■	Normally closed, exhausted, open	41
-	■	■	■	■	Normally closed, exhausted, open	41

Solenoid valves VSVA, ISO 15407-1

Type codes

VSVA		-	B	-	T	32	C	-	A	Z	H
Valve series											
VSVA	Standard valves to ISO 15407-1/-2										
Valve type											
B	Sub-base valve										
Valve function											
M	Single solenoid										
B	Double solenoid										
D	Double solenoid with dominant signal at 14										
P	Single solenoid, mid-position										
T	2 single solenoid valves in one housing										
Connections/switching positions											
22	2/2-way valve										
32	3/2-way valve										
52	5/2-way valve										
53	5/3-way valve										
Normal position											
C	Closed										
N	Code T with 2x closed, reverse operation										
U	Open										
F	Code T with 2x open, reverse operation										
E	Exhausted										
H	Code T with 1x open, 1x closed										
W	Code T with 1x open, 1x closed, reverse operation										
	Double solenoid valve										
Reset method											
A	Pneumatic spring										
M	Mechanical spring										
	Double solenoid valve										
Pilot air supply											
Z	External										
	Internal										
Manual override											
H	Non-detenting										
D	Non-detenting/detenting										
	Without pilot valve										

Solenoid valves VSVA, ISO 15407-1

Type codes



		-	A1	-	1	C1	
Standard							
A1	ISO size 01, width 26 mm						
A2	ISO size 02, width 18 mm						
Operating voltage							
1	24 V DC						
1A	24 V AC						
2A	110 V AC						
3A	230 V AC						
5	12 V DC						
	Without pilot valve						
Electrical connection							
C1	Type C to EN 175301-803						
R2	Central plug M8x1						
R3	Individual plug M12						
R5	Central plug M12x1						
P1	Without pilot valve						
Signal status display							
L	LED (integrated)						
	Without pilot valve						

Pneumatic valves VSPA, ISO 15407-1

Type codes

VSPA - B - M 52 - A - A1

Valve series	
VSPA	Standard valves ISO 15407-1/-2
Valve type	
B	Sub-base valve
Valve function	
M	Monostable
B	Bistable
D	Bistable with dominant signal at 14
P	Monostable, mid-position
T	2 monostable valves in one housing
Connections/switching positions	
32	3/2-way valve
52	5/2-way valve
53	5/3-way valve
Normal position	
C	Closed
U	Open
E	Exhausted
H	Code T with 1x open, 1x closed
	Bistable valve
Reset method	
A	Pneumatic spring
M	Mechanical spring
	Bistable valve
Standard	
A1	ISO size 01, width 26
A2	ISO size 02, width 18

Solenoid/pneumatic valves, ISO 15407-1

Peripherals overview

FESTO

Individual mounting

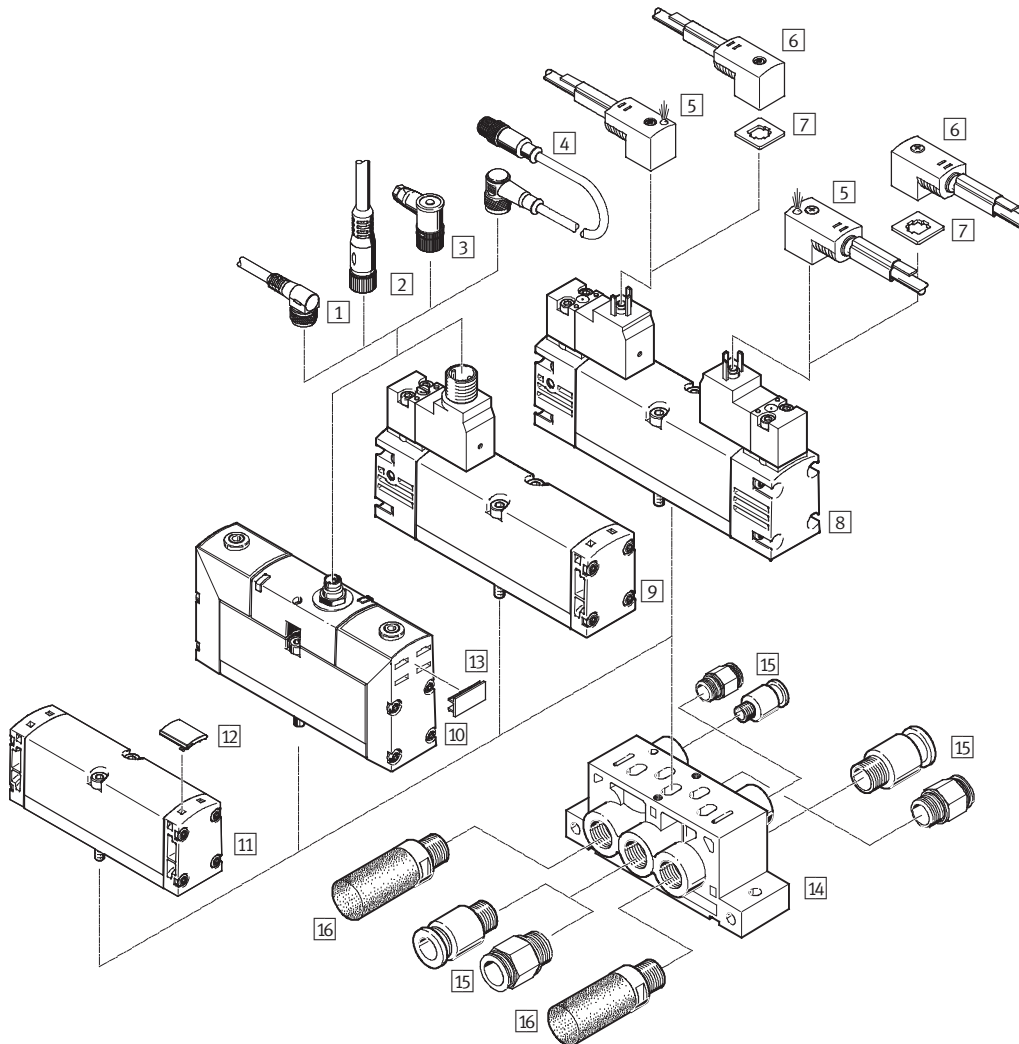

	Type	Brief description	→ Page/Internet
1	SIM-...-4-GD	Angled socket	sim
2	SIM-...-4-GD	Straight socket	sim
3	SEA-M12-4WD	Angled	70
4	KM-12-M12	Angled socket, straight plug	70
5	KMEB...-LED	With PVC casing and LED	70
6	KMEB1	With PVC casing	70
7	MEB-LD	For indicating the signal status	70
8	VSVA-...C	With interface to ISO 15218 and plug pattern type C	20
9	VSVA-...R3	With interface to ISO 15218 and round plug	20
10	VSVA-...R	With round plug	36
11	VSPA	Port pattern to ISO 15407-1	46
12	ASCF	For identifying the VSPA pneumatic valves	69
13	IBS-9x20	For identifying the VSVA valves with round plug	69
14	NAS	With lateral ports	57
15	QS	For standard O.D. tubing	69
16	U	For fitting in exhaust ports	69

Solenoid valves, ISO 15407-1

Peripherals overview

FESTO

Manifold assembly – Solenoid valves

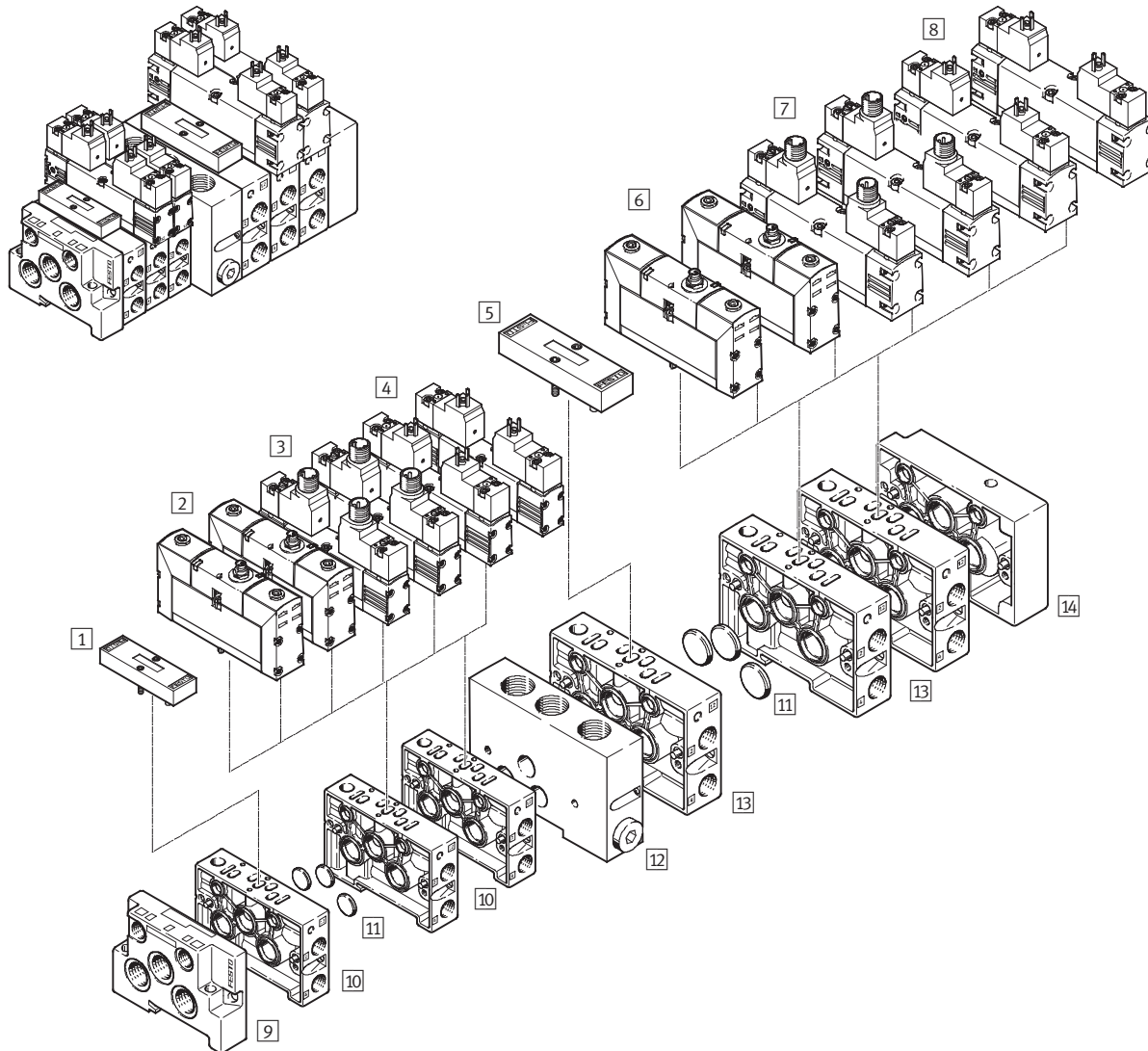

	Type	Brief description	→ Page/Internet	
1	Blanking plate	NDV-02-VDMA	For width 18 mm, vacant or spare position	67
2	Solenoid valve	VSVA...A2...R	Width 18 mm with round plug	36
3	Solenoid valve	VSVA...A2...R3	Width 18 mm, interface to ISO 15218 with round plug	20
4	Solenoid valve	VSVA...A2...C	Width 18 mm, interface to ISO 15218 with plug pattern type C	20
5	Blanking plate	NDV-01-VDMA	For width 26 mm, vacant or spare position	67
6	Solenoid valve	VSVA...A1...R	Width 26 mm with round plug	41
7	Solenoid valve	VSVA...A1...R3	Width 26 mm, interface to ISO 15218 with round plug	28
8	Solenoid valve	VSVA...A1...C	Width 26 mm, interface to ISO 15218 with plug pattern type C	28
9	End plate	NEV	For sealing the manifold sub-bases width 18 mm	58
10	Manifold sub-base	NAW-1/8-02-VDMA	Width 18 mm with lateral ports 2 and 4	58
11	Isolating disc	NSC	For creating pressure zones or for sealing ports on the end plates	67
12	Intermediate plate	NZV-01/02-VDMA	For connecting width 18 mm with width 26 mm	59
13	Manifold sub-base	NAW-1/4-01-VDMA	Width 26 mm with lateral ports 2 and 4	58
14	End plate	NEV	For sealing the manifold sub-bases width 26 mm	58

Pneumatic valves VSPA, ISO 15407-1

Peripherals overview

FESTO

Manifold assembly – Pneumatic valves

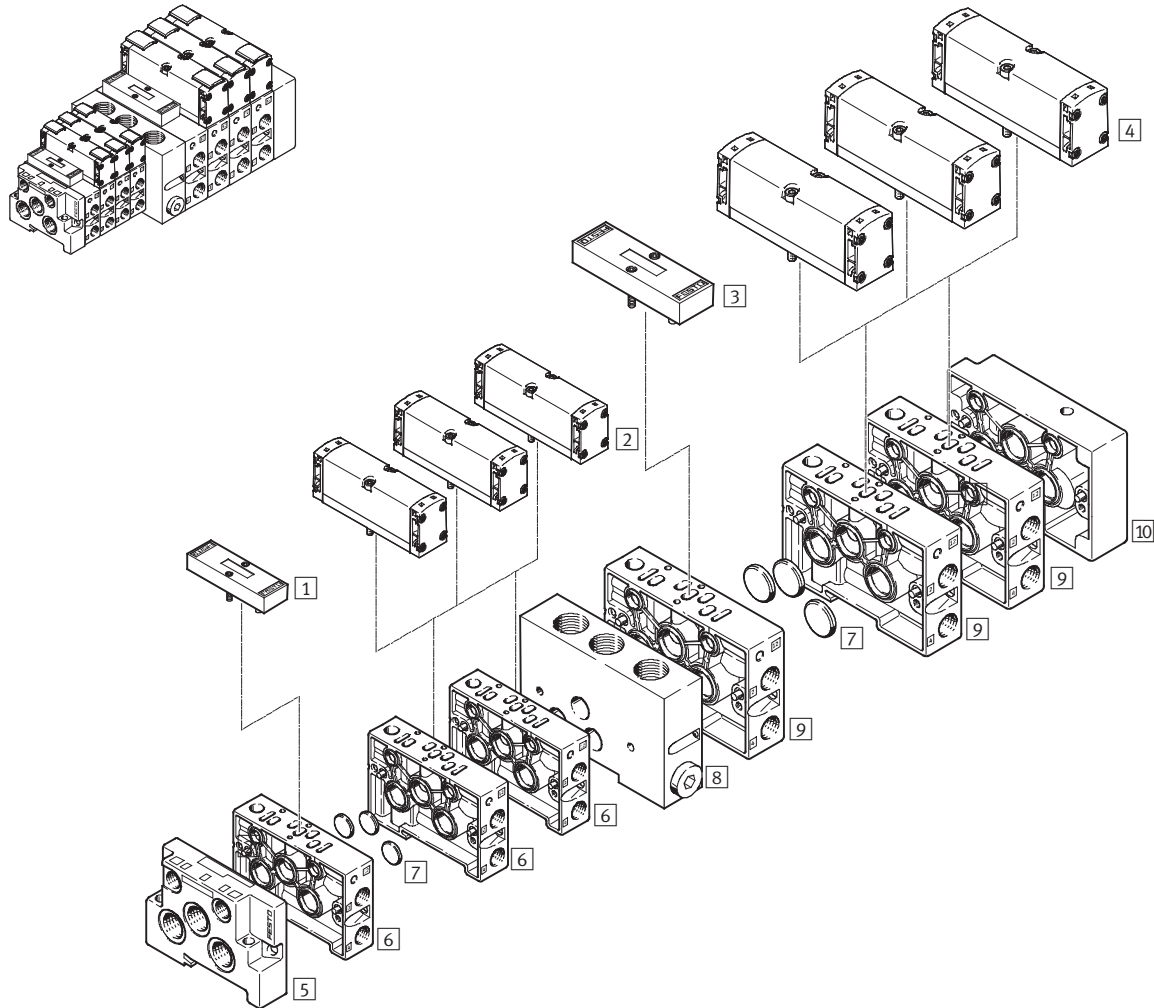

	Type	Brief description	→ Page/Internet	
1	Blanking plate	NDV-02-VDMA	For width 18, vacant or spare position	67
2	Pneumatic valve	VSPA...A2	Width 18	46
3	Blanking plate	NDV-01-VDMA	For width 26, vacant or spare position	67
4	Pneumatic valve	VSPA...A1	Width 26	49
5	End plate	NEV	For sealing the manifold sub-bases width 18	58
6	Manifold sub-base	NAW-1/8-02-VDMA	Width 18 with lateral ports 2 and 4	58
7	Isolating disc	NSC	For creating pressure zones or for sealing ports on the end plates	67
8	Intermediate plate	NZV-01/02-VDMA	For connecting width 18 with width 26	59
9	Manifold sub-base	NAW-1/4-01-VDMA	Width 26 with lateral ports 2 and 4	58
10	End plate	NEV	For sealing the manifold sub-bases width 26	58

Solenoid valves VSVA, ISO 15407-1

Peripherals overview

FESTO

Manifold assembly with vertical stacking

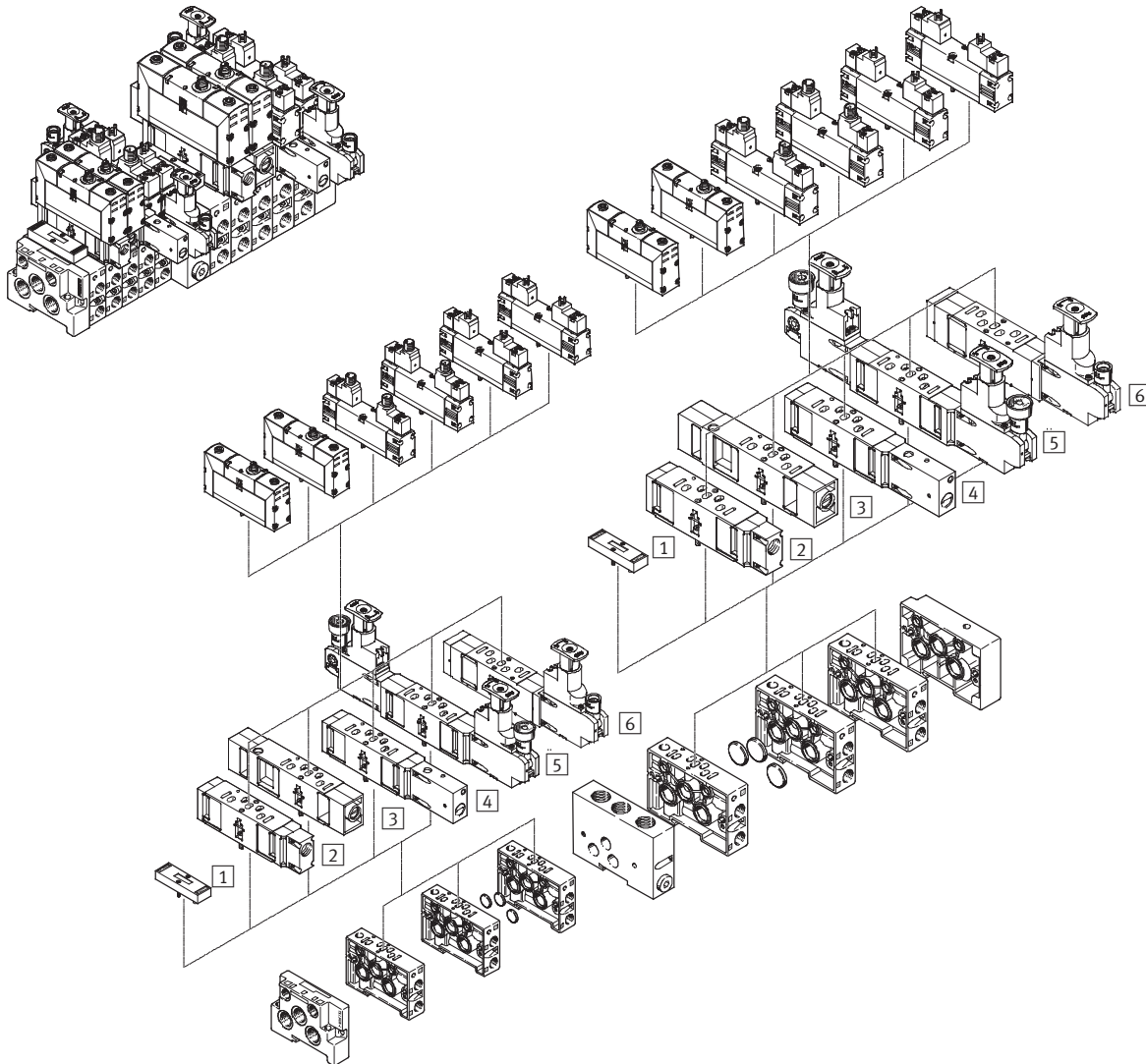

	Type	Brief description	→ Page/Internet	
1	Blanking plate	NDV	For vacant or spare position	67
2	Vertical supply plate	VABF...P1-A3	For intermediate air supply	55
3	Flow control plate	VABF...F1-B1	For flow control in ducts 3 and 5	54
4	Vertical pressure shut-off plate	VABF...L1-D1	With switch for manual shut-off of duct 1	56
5	Regulator plate	VABF...R...-C2	With 2 pressure regulators for working ports 2 and 4	52
6	Regulator plate	VABF...R...-C2	With one pressure regulator for working ports 2 or 4 or for duct 1	52

Solenoid valves VSVA, ISO 15407-1

Peripherals overview

FESTO

Manifold assembly

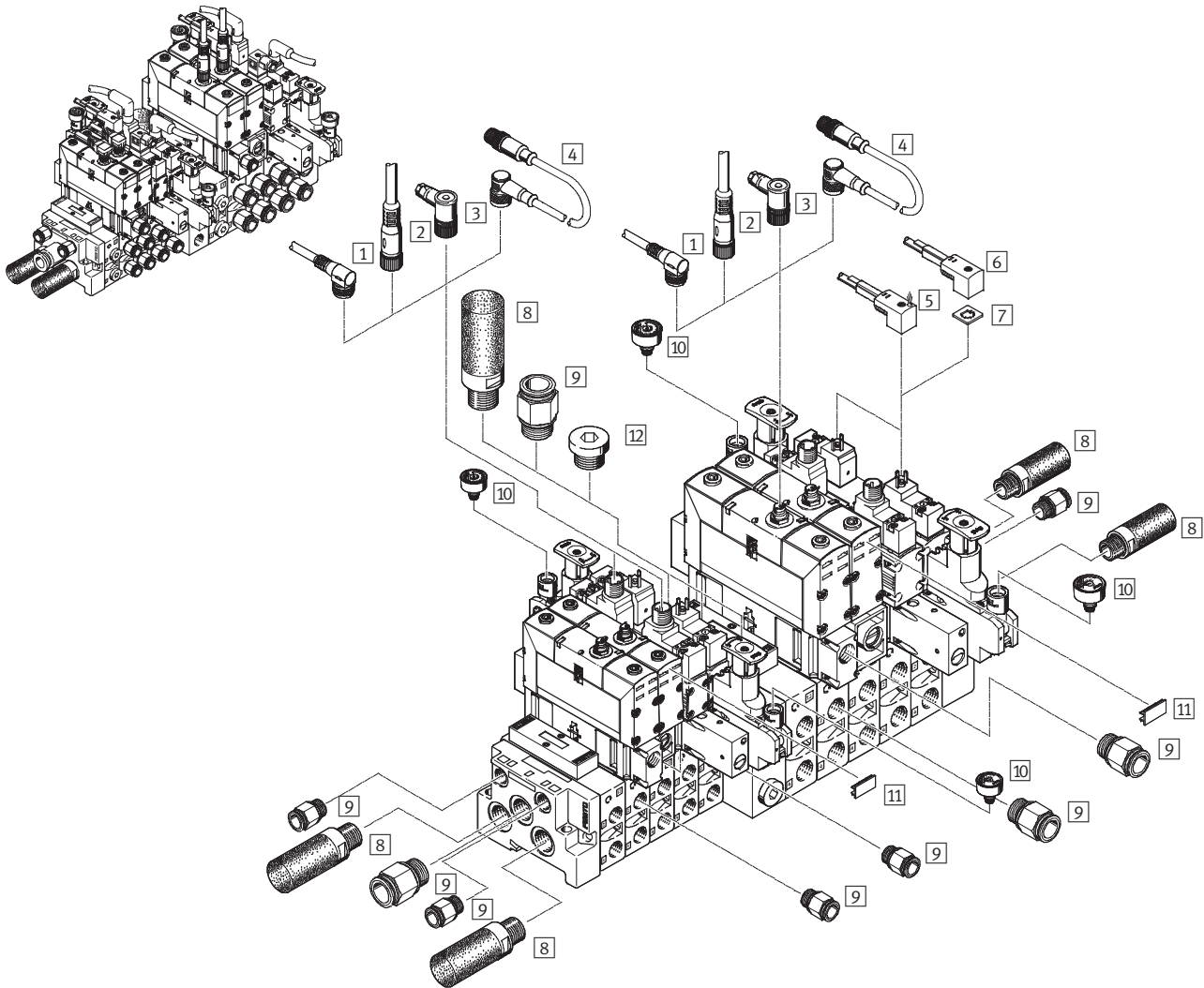



	Type	Brief description	→ Page/Internet	
1	Connecting cable	SIM-...-4-WD	Angled socket	sim
2	Connecting cable	SIM-...-4-GD	Straight socket	sim
3	Plug socket	SEA-M12-4WD	Angled	70
4	Connecting cable	KM-12-M12	Angled socket, straight plug	70
5	Connecting cable	KMEB...-LED	With PVC casing and LED	70
6	Connecting cable	KMEB1	With PVC casing	70
7	Illuminating seal	MEB-LD	For indicating the signal status	70
8	Silencer	U	For fitting in exhaust ports	69
9	Push-in fitting	QS	For standard O.D. tubing	69
10	Pressure gauge	PAGN-26-10-P10	Can be connected to the pressure regulator plate	69
11	Inscription labels	IBS-9x20	For identifying the VSVA valves with round plug	69
12	Blanking plug	B	For sealing unused ports	69

Solenoid valves VSVA, with pilot interface to ISO 15218

FESTO

Technical data – Width 18 mm

-  Flow rate
Max. 750 l/min

-  Voltage
12, 24 V DC
24, 110, 230 V AC

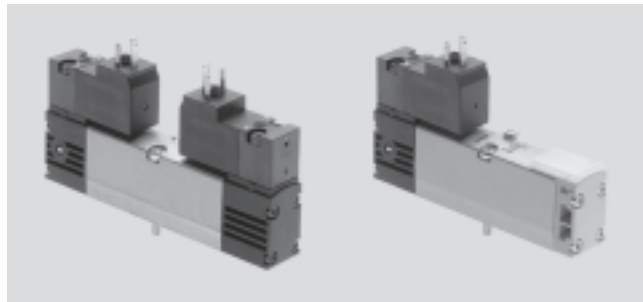

General technical data					
Valve function	2x 2/2	2x 3/2	5/2	5/3	
Normal position	C ¹⁾	C ¹⁾ , U ²⁾ , H ⁴⁾ , N ⁵⁾ , F ⁶⁾ , W ⁷⁾	–	–	C ¹⁾ , U ²⁾ , E ³⁾
Stable position	Monostable	Monostable	Monostable	Bistable	Monostable
Pneumatic spring reset method	Yes	Yes	Yes	–	No
Mechanical spring reset method	No	No	Yes	–	Yes
Design	Piston spool valve				
Sealing principle	Soft				
Actuation type	Electric				
Type of control	Piloted				
Pilot interface	To ISO 15218				
Pilot air supply	Internal or external				
Pilot air supply, exhaust air	Optionally ducted/not ducted				
Direction of flow	Non-reversible or reversible	Non-reversible or reversible only	Reversible with external pilot air supply		
Exhaust function	Flow control				
Manual override	Non-detenting, non-detenting/detenting				
Type of mounting	On sub-base				
Mounting position	Any				
Nominal size	[mm]	5			
Flow rate of valve	[l/min]	700	600	750	650
Flow rate of valve on individual sub-base	[l/min]	450	450	550	500
Flow rate of valve, pneumatically interlinked	[l/min]	500	400	550	450
Standard nominal flow rate	[l/min]	500	400	550	450
Switching time on/off, pneumatic spring	[ms]	13/21	13/21	21/19	–
Switching time on/off, mechanical spring	[ms]	–	–	17/35	–
Switching time on/off, for N, F and W	[ms]	–	21/13	–	–
Changeover time	[ms]	–	–	15	20
Non-overlapping	Yes				
Width	[mm]	18			
Ports on the sub-base	1, 2, 3, 4, 5 12, 14	G1/8 M5			
Tightening torque, valve mounting	[Nm]	0.9 ... 1.1			
Product weight	[g]	174	174	127	174
Noise level	[dB (A)]	85			
Conforms to	ISO 15407-1 and interface for pilot valve ISO 15218				
CE mark ⁸⁾ (see declaration of conformity)	To EU Low Voltage Directive				

- 1) C=Normally closed
- 2) U=Normally open
- 3) E=Normally exhausted
- 4) H=2x 3/2-way valve in one housing with 1x normally closed and 1x normally open
- 5) N=Normally closed, reverse operation, i.e. the pressure supply ports are 3 and 5, venting is via port 1
- 6) F=Normally open, reverse operation, i.e. the pressure supply ports are 3 and 5, venting is via port 1
- 7) W=2x 3/2-way valve in one housing with 1x normally closed and 1x normally open, reverse operation, i.e. the pressure supply ports are 3 and 5, venting is via port 1
- 8) For solenoid valves with 110 V AC and 230 V AC

Solenoid valves VSVA, with pilot interface to ISO 15218

Technical data – Width 18 mm

Operating and environmental conditions					
Valve function		2x 2/2	2x 3/2	5/2	5/3
Operating medium		Compressed air to ISO 8573-1:2010 [7:4:4]			
Pilot medium		Compressed air to ISO 8573-1:2010 [7:4:4]			
Note about the operating/pilot medium		Lubricated operation possible (required during subsequent operation)			
Operating pressure	Internal pilot air supply [bar]	2 ... 10	2 ... 10	2 ... 10, 3 ... 10 with mechanical spring	3 ... 10
	External pilot air supply [bar]	2 ... 10	2 ... 10	-0.9 ... 10	
Pilot pressure with pneumatic spring	[bar]	3 ... 10 ¹⁾	3 ... 10 ¹⁾	3 ... 10	-
Pilot pressure with mechanical spring	[bar]	-	-	3 ... 10	3 ... 10
Ambient temperature	[°C]	-5 ... +50			
Temperature of medium	[°C]	-5 ... +50			
Fire protection classification to UL94		HB			

1) Pilot pressure dependent on operating pressure → Graph

Minimum pilot pressure p12, p14 as a function of operating pressure p1 (external pilot air supply)

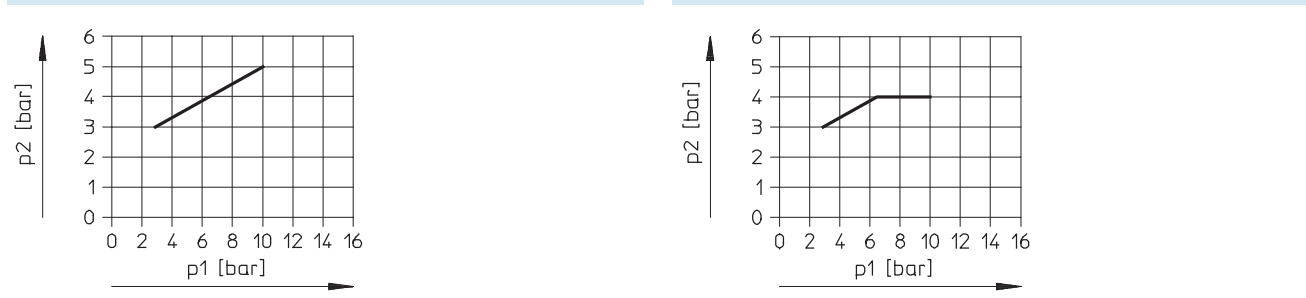

Electrical data			
Electrical connection		Plug, square design to EN 175301-803, type C, 110 V/230 V AC with protective earth conductor	M12 plug, round design
Operating voltage	DC voltage [V DC]	12, 24 +10%/-15%	24 +10%/-15%
	AC voltage [V AC]	24, 110, 230 +10%/-15%	-
Coil characteristics	DC voltage [W]	1.8	1.8
	AC voltage [VA]	2.1 at 110 V/230 V, 2.3 at 24 V	-
Duty cycle	[%]	100	100
Protection class to EN 60529		IP65, Nema 4 (in combination with plug socket)	IP65, Nema 4 (in combination with plug socket)
CE marking (see declaration of conformity)		To EU Low Voltage Directive (only voltage variants 110 V AC and 230 V AC)	-

Solenoid valves VSVA, with pilot interface to ISO 15218

Technical data – Width 18 mm

FESTO

Materials

Sectional view

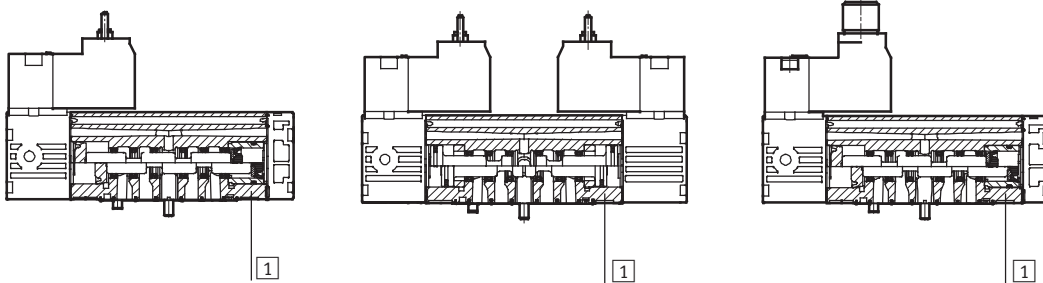

1	Housing	Die-cast aluminium
-	Seals	Nitrile rubber
-	Screws	Galvanised steel
-	Note on materials	RoHS-compliant

Dimensions

Download CAD Data → www.festo.com/us/cad

5/2-way valve, single solenoid, with plug type C, VSVA-B-M52...C1

5/2-way valve, single solenoid with M12 plug, VSVA-B-M52...R3

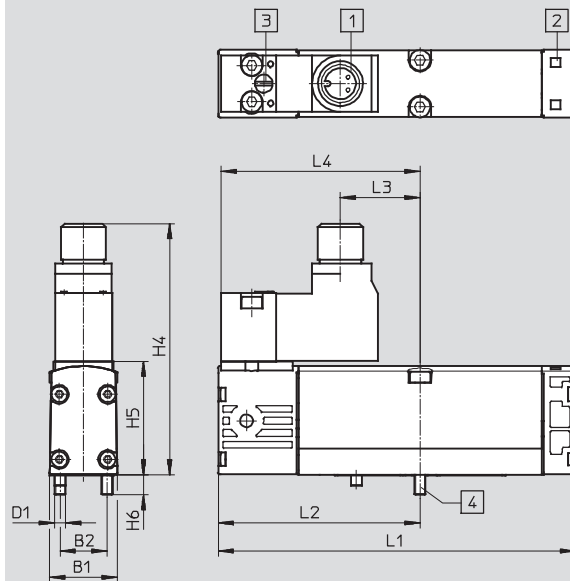
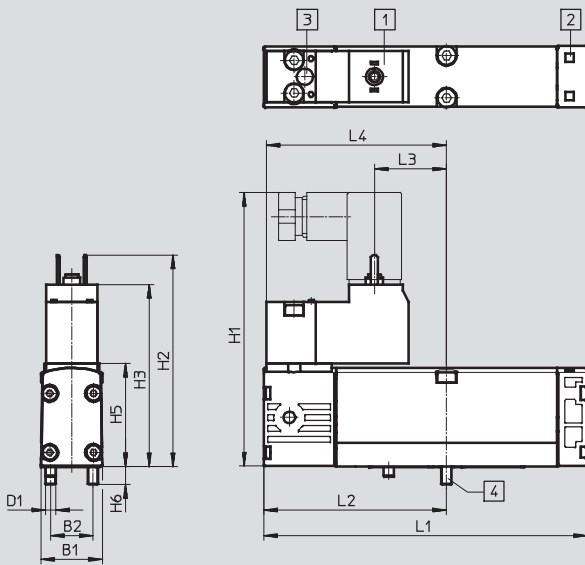

1 Connection dimensions and device plug to EN 175301-803, type C

2 Slot for inscription label
3 Manual override
4 Captive screws

1 Connection dimensions and device plug, M12 plug

2 Slot for inscription label
3 Manual override
4 Captive screws

	B1	B2	D1	H1	H2	H3	H4	H5	H6	L1	L2	L3	L4
VSVA-B-M52...C1	18	12.5	M3	80.6	62.2	53.6	-	30.3	5.4	95.4	53.9	21.3	53.1
VSVA-B-M52...R3	18	12.5	M3	-	-	-	67	30.3	5.4	95.4	53.9	21.3	53.1

Solenoid valves VSVA, with pilot interface to ISO 15218

Technical data – Width 18 mm

Dimensions Download CAD Data → www.festo.com/us/cad
 2x 2/2-way valve, 2x 3/2-way valve, 5/2-way valve, double solenoid, 5/3-way valve

- 1 Connection dimensions and device plug to EN 175301-803, type C
- 2 Connection dimensions and device plug, M12 plug
- 3 Manual override
- 4 Captive screws

	B1	B2	B3	D1	H1	H2	H3	H4	H5	H6	L1	L2	L3	L4	L5
VSVA-B-T22C	18	12.5	15.2	M3	80.6	62.2	53.6	67	30.3	5.4	107.8	53.9	21.3	53.1	102.2
VSVA-B-T32															
VSVA-B-B52															
VSVA-B-D52															
VSVA-B-P53															

Dimensions Download CAD data → www.festo.com/en/engineering
 Pilot valve with plug type C, VSCS-...C1 Pilot valve with M12 plug, VSCS-...R3

- 1 Connection dimensions and device plug to EN 175301-803, type C
- 2 Manual override
- 3 Pneumatic port pattern to ISO 15218

- 1 Connection dimensions and device plug, M12 plug
- 2 Manual override
- 3 Pneumatic port pattern to ISO 15218

	B1	H1	H2	H3	L1
VSCS-...C1	15.2	23.2	10.5	18.2	41.9
VSCS-...R3	15	26.1	10.6	18.2	41.9

Solenoid valves VSVA, with pilot interface to ISO 15218

FESTO

Technical data – Width 18 mm

Ordering data – Pilot control assembled					
Code	Circuit symbol		Part No.	Type	
2x 2/2-way solenoid valve					
T22C	–	Order via online configurator	–	–	
2x 3/2-way solenoid valve, with pilot control with square plug, type C to EN 175301-803					
K		Normal position: 2x closed	Internal pilot air supply	24 V DC	546693 VSVA-B-T32C-AH-A2-1C1
				12 V DC	547129 VSVA-B-T32C-AH-A2-5C1
				230 V AC	547209 VSVA-B-T32C-AH-A2-3AC1
				110 V AC	547169 VSVA-B-T32C-AH-A2-2AC1
				24 V AC	547089 VSVA-B-T32C-AH-A2-1AC1
N		Normal position: 2x open	Internal pilot air supply	24 V DC	546695 VSVA-B-T32U-AH-A2-1C1
				12 V DC	547131 VSVA-B-T32U-AH-A2-5C1
				230 V AC	547211 VSVA-B-T32U-AH-A2-3AC1
				110 V AC	547171 VSVA-B-T32U-AH-A2-2AC1
				24 V AC	547091 VSVA-B-T32U-AH-A2-1AC1
H		Normal position: 1x closed 1x open	Internal pilot air supply	24 V DC	547067 VSVA-B-T32H-AH-A2-1C1
				12 V DC	547133 VSVA-B-T32H-AH-A2-5C1
				230 V AC	547213 VSVA-B-T32H-AH-A2-3AC1
				110 V AC	547173 VSVA-B-T32H-AH-A2-2AC1
				24 V AC	547093 VSVA-B-T32H-AH-A2-1AC1
K		Normal position: 2x closed	External pilot air supply	24 V DC	547069 VSVA-B-T32C-AZH-A2-1C1
				12 V DC	547149 VSVA-B-T32C-AZH-A2-5C1
				230 V AC	547229 VSVA-B-T32C-AZH-A2-3AC1
				110 V AC	547189 VSVA-B-T32C-AZH-A2-2AC1
				24 V AC	547109 VSVA-B-T32C-AZH-A2-1AC1
N		Normal position: 2x open	External pilot air supply	24 V DC	547071 VSVA-B-T32U-AZH-A2-1C1
				12 V DC	547151 VSVA-B-T32U-AZH-A2-5C1
				230 V AC	547231 VSVA-B-T32U-AZH-A2-3AC1
				110 V AC	547191 VSVA-B-T32U-AZH-A2-2AC1
				24 V AC	547111 VSVA-B-T32U-AZH-A2-1AC1
H		Normal position: 1x closed 1x open	External pilot air supply	24 V DC	547073 VSVA-B-T32H-AZH-A2-1C1
				12 V DC	547153 VSVA-B-T32H-AZH-A2-5C1
				230 V AC	547233 VSVA-B-T32H-AZH-A2-3AC1
				110 V AC	547193 VSVA-B-T32H-AZH-A2-2AC1
				24 V AC	547113 VSVA-B-T32H-AZH-A2-1AC1

Solenoid valves VSVA, with pilot interface to ISO 15218

Technical data – Width 18 mm

Ordering data – Pilot control assembled						
Code	Circuit symbol			Part No.	Type	
5/2-way solenoid valve, single solenoid, with pilot control with square plug, type C to EN 175301-803						
M		Pneumatic spring	Internal pilot air supply	24 V DC	546701	VSVA-B-M52-AH-A2-1C1
				12 V DC	547139	VSVA-B-M52-AH-A2-5C1
				230 V AC	547219	VSVA-B-M52-AH-A2-3AC1
				110 V AC	547179	VSVA-B-M52-AH-A2-2AC1
				24 V AC	547099	VSVA-B-M52-AH-A2-1AC1
O		Mechanical spring	Internal pilot air supply	24 V DC	546703	VSVA-B-M52-MH-A2-1C1
				12 V DC	547141	VSVA-B-M52-MH-A2-5C1
				230 V AC	547221	VSVA-B-M52-MH-A2-3AC1
				110 V AC	547181	VSVA-B-M52-MH-A2-2AC1
				24 V AC	547101	VSVA-B-M52-MH-A2-1AC1
M		Pneumatic spring	External pilot air supply	24 V DC	547079	VSVA-B-M52-AZH-A2-1C1
				12 V DC	547159	VSVA-B-M52-AZH-A2-5C1
				230 V AC	547239	VSVA-B-M52-AZH-A2-3AC1
				110 V AC	547199	VSVA-B-M52-AZH-A2-2AC1
				24 V AC	547119	VSVA-B-M52-AZH-A2-1AC1
O		Mechanical spring	External pilot air supply	24 V DC	547081	VSVA-B-M52-MZH-A2-1C1
				12 V DC	547161	VSVA-B-M52-MZH-A2-5C1
				230 V AC	547241	VSVA-B-M52-MZH-A2-3AC1
				110 V AC	547201	VSVA-B-M52-MZH-A2-2AC1
				24 V AC	547121	VSVA-B-M52-MZH-A2-1AC1
5/2-way solenoid valve, double solenoid, with pilot control with square plug, type C to EN 175301-803						
J		Dominant 1st signal	Internal pilot air supply	24 V DC	546697	VSVA-B-B52-H-A2-1C1
				12 V DC	547135	VSVA-B-B52-H-A2-5C1
				230 V AC	547215	VSVA-B-B52-H-A2-3AC1
				110 V AC	547175	VSVA-B-B52-H-A2-2AC1
				24 V AC	547095	VSVA-B-B52-H-A2-1AC1
D		Dominant signal at 14	Internal pilot air supply	24 V DC	546699	VSVA-B-D52-H-A2-1C1
				12 V DC	547137	VSVA-B-D52-H-A2-5C1
				230 V AC	547217	VSVA-B-D52-H-A2-3AC1
				110 V AC	547177	VSVA-B-D52-H-A2-2AC1
				24 V AC	547097	VSVA-B-D52-H-A2-1AC1
J		Dominant 1st signal	External pilot air supply	24 V DC	547075	VSVA-B-B52-ZH-A2-1C1
				12 V DC	547155	VSVA-B-B52-ZH-A2-5C1
				230 V AC	547235	VSVA-B-B52-ZH-A2-3AC1
				110 V AC	547195	VSVA-B-B52-ZH-A2-2AC1
				24 V AC	547115	VSVA-B-B52-ZH-A2-1AC1
D		Dominant signal at 14	External pilot air supply	24 V DC	547077	VSVA-B-D52-ZH-A2-1C1
				12 V DC	547157	VSVA-B-D52-ZH-A2-5C1
				230 V AC	547237	VSVA-B-D52-ZH-A2-3AC1
				110 V AC	547197	VSVA-B-D52-ZH-A2-2AC1
				24 V AC	547117	VSVA-B-D52-ZH-A2-1AC1





Solenoid valves VSVA, with pilot interface to ISO 15218

Technical data – Width 18 mm

Ordering data – Pilot control assembled						
Code	Circuit symbol			Part No.	Type	
5/3-way solenoid valve, with pilot control with square plug, type C to EN 175301-803						
G		Normal position: Closed	Internal pilot air supply	24 V DC	546709	VSVA-B-P53C-H-A2-1C1
				12 V DC	547147	VSVA-B-P53C-H-A2-5C1
				230 V AC	547227	VSVA-B-P53C-H-A2-3AC1
				110 V AC	547187	VSVA-B-P53C-H-A2-2AC1
				24 V AC	547107	VSVA-B-P53C-H-A2-1AC1
B		Normal position: Open	Internal pilot air supply	24 V DC	546705	VSVA-B-P53U-H-A2-1C1
				12 V DC	547143	VSVA-B-P53U-H-A2-5C1
				230 V AC	547223	VSVA-B-P53U-H-A2-3AC1
				110 V AC	547183	VSVA-B-P53U-H-A2-2AC1
				24 V AC	547103	VSVA-B-P53U-H-A2-1AC1
E		Normal position: Exhausted	Internal pilot air supply	24 V DC	546707	VSVA-B-P53E-H-A2-1C1
				12 V DC	547145	VSVA-B-P53E-H-A2-5C1
				230 V AC	547225	VSVA-B-P53E-H-A2-3AC1
				110 V AC	547185	VSVA-B-P53E-H-A2-2AC1
				24 V AC	547105	VSVA-B-P53E-H-A2-1AC1
G		Normal position: Closed	External pilot air supply	24 V DC	547087	VSVA-B-P53C-ZH-A2-1C1
				12 V DC	547167	VSVA-B-P53C-ZH-A2-5C1
				230 V AC	547247	VSVA-B-P53C-ZH-A2-3AC1
				110 V AC	547207	VSVA-B-P53C-ZH-A2-2AC1
				24 V AC	547127	VSVA-B-P53C-ZH-A2-1AC1
B		Normal position: Open	External pilot air supply	24 V DC	547083	VSVA-B-P53U-ZH-A2-1C1
				12 V DC	547163	VSVA-B-P53U-ZH-A2-5C1
				230 V AC	547243	VSVA-B-P53U-ZH-A2-3AC1
				110 V AC	547203	VSVA-B-P53U-ZH-A2-2AC1
				24 V AC	547123	VSVA-B-P53U-ZH-A2-1AC1
E		Normal position: Exhausted	External pilot air supply	24 V DC	547085	VSVA-B-P53E-ZH-A2-1C1
				12 V DC	547165	VSVA-B-P53E-ZH-A2-5C1
				230 V AC	547245	VSVA-B-P53E-ZH-A2-3AC1
				110 V AC	547205	VSVA-B-P53E-ZH-A2-2AC1
				24 V AC	547125	VSVA-B-P53E-ZH-A2-1AC1

Solenoid valves VSVA, with pilot interface to ISO 15218

Technical data – Width 18 mm

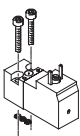
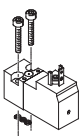
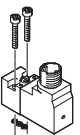
Ordering data – Pilot control separate					
				Part No.	Type
2x 3/2-way valve without pilot valves					
	Internal pilot air supply	2x normally closed	546732	VSVA-B-T32C-A-A2-P1	
		2x normally open	546734	VSVA-B-T32U-A-A2-P1	
5/2-way single solenoid valve without pilot valve					
	Internal pilot air supply	Pneumatic spring	546740	VSVA-B-M52-A-A2-P1	
		Mechanical spring	546742	VSVA-B-M52-M-A2-P1	
5/2-way double solenoid valve, double solenoid, without pilot valve					
	Internal pilot air supply	Dominant 1st signal	546736	VSVA-B-B52-A2-P1	
		Dominant signal at 14	546738	VSVA-B-D52-A2-P1	
5/3-way mid-position valve, single solenoid, without pilot valves					
	Internal pilot air supply	Normally closed	546748	VSVA-B-P53C-A2-P1	
		Normally open	546744	VSVA-B-P53U-A2-P1	
		Normally exhausted	546746	VSVA-B-P53E-A2-P1	
Pilot valve to ISO 15218					
	Square plug, type C to EN 175301-803	12 V DC	MO non-detenting	546257	VSCS-B-M32-MH-WA-5C1
			MO, detenting/ non-detenting	571062	VSCS-B-M32-MD-WA-5C1
		24 V DC	MO non-detenting	546256	VSCS-B-M32-MH-WA-1C1
			MO, detenting/ non-detenting	571061	VSCS-B-M32-MD-WA-1C1
		24 V AC	MO non-detenting	546258	VSCS-B-M32-MH-WA-1AC1
			MO, detenting/ non-detenting	571063	VSCS-B-M32-MD-WA-1AC1
	Square plug, type C to EN 175301-803, with protective earth conductor	110 V AC	MO non-detenting	546259	VSCS-B-M32-MH-WA-2AC1
			MO, detenting/ non-detenting	571064	VSCS-B-M32-MD-WA-2AC1
		230 V AC	MO non-detenting	546260	VSCS-B-M32-MH-WA-3AC1
			MO, detenting/ non-detenting	571065	VSCS-B-M32-MD-WA-3AC1
	M12 round plug to IEC 61076-2-101	24 V DC	MO non-detenting	573214	VSCS-B-M32-MH-WA-1R3
			MO, detenting/ non-detenting	573215	VSCS-B-M32-MD-WA-1R3

MO Type of manual override

Solenoid valves VSVA, with pilot interface to ISO 15218

FESTO

Technical data – Width 26 mm

-  Flow rate
Max. 1,400 l/min

-  Voltage
12, 24 V DC
24, 110, 230 V AC

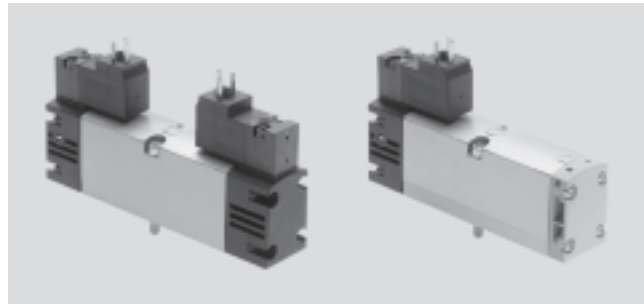

General technical data						
Valve function	2x 2/2	2x 3/2	5/2		5/3	
Normal position	C ¹⁾	C ¹⁾ , U ²⁾ , H ⁴⁾ , N ⁵⁾ , F ⁶⁾ , W ⁷⁾	–	–	C ¹⁾	U ²⁾ E ³⁾
Stable position	Monostable	Monostable	Monostable	Bistable	Monostable	
Pneumatic spring reset method	Yes	Yes	Yes	–	No	
Mechanical spring reset method	No	No	Yes	–	Yes	
Design	Piston spool valve					
Sealing principle	Soft					
Actuation type	Electric					
Type of control	Piloted					
Pilot interface	In accordance with ISO 15218					
Pilot air supply	Internal or external					
Pilot air supply, exhaust air	Optionally ducted/not ducted					
Direction of flow	Non-reversible or reversible	Non-reversible or reversible only	Reversible with external pilot air supply			
Exhaust function	With flow control					
Manual override	Non-detenting, non-detenting/detenting					
Type of mounting	On sub-base					
Mounting position	Any					
Nominal size [mm]	9					
Flow rate of valve [l/min]	1,350	1,250	1,400		1,400	
Flow rate of valve on individual sub-base [l/min]	1,000	1,000	1,100		1,100	
Flow rate of pneumatically interlinked valve [l/min]	1,000	900	1,100		1,000	
Standard nominal flow rate [l/min]	1,000	900	1,100		1,000	
Switching time on/off, pneumatic spring [ms]	20/28	20/28	35/43	–	–	
Switching time on/off, mechanical spring [ms]	–	–	26/56	–	23/58	
Switching time on/off, for N, F and W [ms]	–	28/20	–	–	–	
Changeover time [ms]	–	–	18		35	
Non-overlapping	Yes					
Width [mm]	26					
Connection on the sub-base	1, 2, 3, 4, 5		G1/4		M5	
	12, 14		M5			
Tightening torque for valve mounting [Nm]	1.8 ... 2.2					
Product weight [g]	305	305	180	305		
Noise level [dB (A)]	85					
Conforms to	ISO 15407-1 and ISO 15218 for pilot valve interface					
CE mark ⁸⁾ (see declaration of conformity)	To EU Low Voltage Directive					

- 1) C=Normally closed
- 2) U=Normally open
- 3) E=Normally exhausted
- 4) H=2x 3/2-way valve in one housing with 1x normally closed and 1x normally open
- 5) N=Normally closed, reverse operation, i.e. the pressure supply ports are 3 and 5, venting is via port 1
- 6) F=Normally open, reverse operation, i.e. the pressure supply ports are 3 and 5, venting is via port 1
- 7) W=2x 3/2-way valve in one housing with 1x normally closed and 1x normally open, reverse operation, i.e. the pressure supply ports are 3 and 5, venting is via port 1
- 8) For solenoid valves with 110 V AC and 230 V AC

Solenoid valves VSVA, with pilot interface to ISO 15218

Technical data – Width 26 mm

Operating and environmental conditions				2x 2/2	2x 3/2	5/2	5/3	
Valve function								
Operating medium		Compressed air according to ISO 8573-1:2010 [7:4:4]						
Pilot medium		Compressed air according to ISO 8573-1:2010 [7:4:4]						
Note about the operating/pilot medium		Lubricated operation possible (required during subsequent operation)						
Operating pressure	Internal pilot air supply	[bar]	2 ... 10	2 ... 10	2 ... 10, 3 ... 10 with mechanical spring	3 ... 10		
	External pilot air supply	[bar]	2 ... 10	2 ... 10	-0.9 ... 16	-0.9 ... 16		
Pilot pressure with pneumatic spring		[bar]	3 ... 10 ¹⁾	3 ... 10 ¹⁾	3 ... 10	-		
Pilot pressure with mechanical spring		[bar]	-	-	3 ... 10	3 ... 10		
Ambient temperature		[°C]	-5 ... +50					
Temperature of medium		[°C]	-5 ... +50					
Fire protection classification to UL94			HB					

1) Pilot pressure dependent on operating pressure → Graph

Minimum pilot pressure p12, p14 as a function of operating pressure p1 (external pilot air supply)

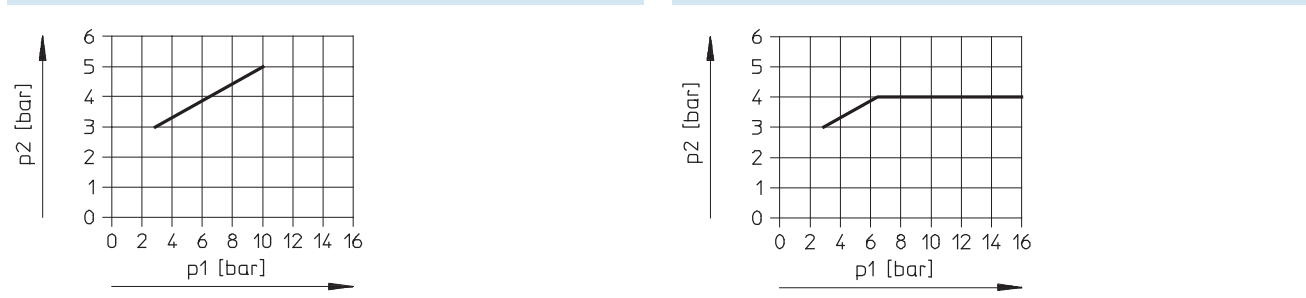

Electrical data				
Electrical connection		Plug, square design to EN 175301-803, type C, 110 V/230 V AC with protective earth conductor		Plug M12, round design
Operating voltage	DC voltage	[V DC]	12, 24 +10%/-15%	24 +10%/-15%
	AC voltage	[V AC]	24, 110, 230 +10%/-15%	-
Coil characteristics	DC voltage	[W]	1.8	1.8
	AC voltage	[VA]	2.1 at 110 V/230 V, 2.3 at 24 V	-
Duty cycle		[%]	100	100
Protection class to EN 60529		IP65, Nema 4 (in combination with plug socket)		IP65, Nema 4 (in combination with plug socket)
CE marking (see declaration of conformity)		To EU Low Voltage Directive (only voltage variants 110 V AC and 230 V AC)		-

Solenoid valves VSVA, with pilot interface to ISO 15218

Technical data – Width 26 mm

Materials

Sectional view

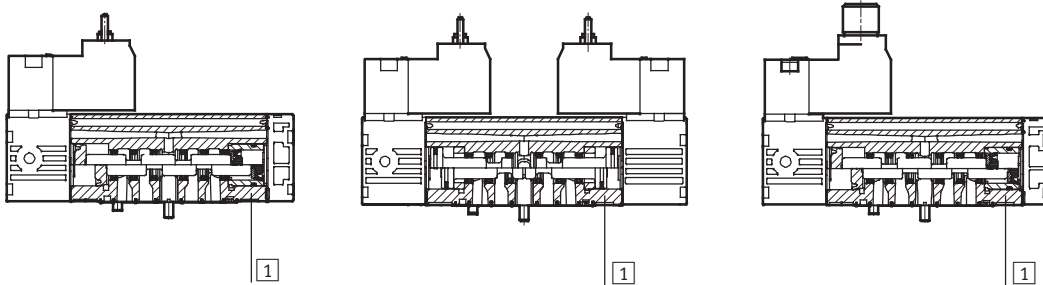

1	Housing	Die-cast aluminium
-	Seals	Nitrile rubber
-	Screws	Galvanised steel
-	Note on materials	RoHS-compliant

Dimensions

Download CAD Data → www.festo.com/us/cad

5/2-way valve, single solenoid, with plug type C, VSVA-B-M52...C1

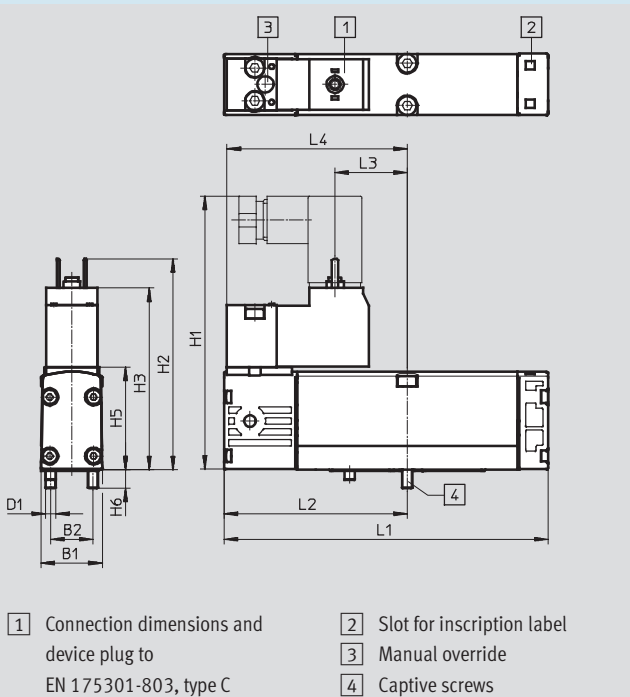

5/2-way valve, single solenoid with plug M12, VSVA-B-M52...R3

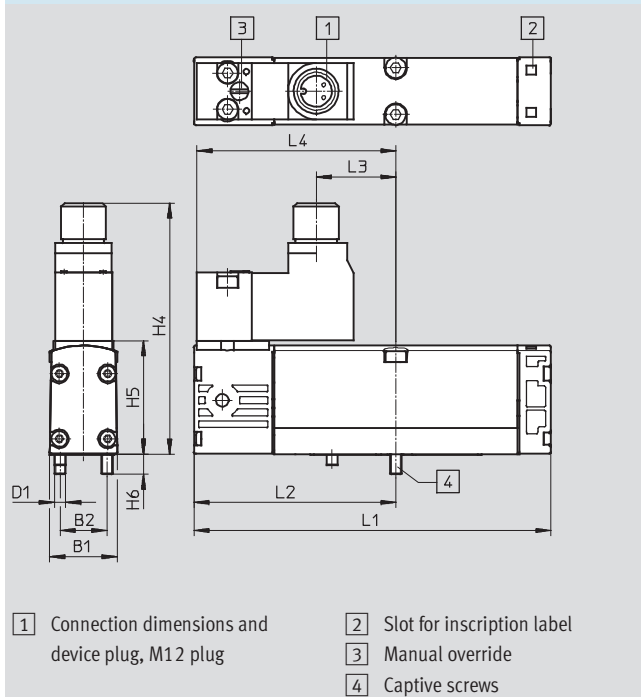

	B1	B2	D1	H1	H2	H3	H4	H5	H6	L1	L2	L3	L4
VSVA-B-M52...C1	26.3	19	M4	89.2	71.2	62.6	-	39.3	7	113.1	63.1	29.8	61.6
VSVA-B-M52...R3	26.3	19	M4	-	-	-	76.1	39.3	7	113.1	63.1	29.8	61.6

Solenoid valves VSVA, with pilot interface to ISO 15218

Technical data – Width 26 mm

Dimensions Download CAD Data → www.festo.com/us/cad

2x 2/2-way valve, 2x 3/2-way valve, 5/2-way valve, double solenoid, 5/3-way valve

- 1 Connection dimensions and device plug to EN 175301-803, type C
- 2 Connection dimensions and device plug, M12 plug
- 3 Manual override
- 4 Captive screws

	B1	B2	B3	D1	H1	H2	H3	H4	H5	H6	L1	L2	L3	L4	L5
VSVA-B-T22C	26.3	19	15.2	M4	89.2	71.2	62.6	76.1	39.3	7	126.2	63.1	29.8	61.6	123.2
VSVA-B-T32															
VSVA-B-B52															
VSVA-B-D52															
VSVA-B-P53															

Dimensions Download CAD Data → www.festo.com/us/cad

Pilot valve with plug type C, VSCS-...C1

- 1 Connection dimensions and device plug to EN 175301-803, type C
- 2 Manual override
- 3 Pneumatic port pattern to ISO 15218

Pilot valve with plug M12, VSCS-...R3

- 1 Connection dimensions and device plug, M12 plug
- 2 Manual override
- 3 Pneumatic port pattern to ISO 15218

	B1	H1	H2	H3	L1
VSCS-...C1	15.2	23.2	10.5	18.2	41.9
VSCS-...R3	15	26.1	10.6	18.2	41.9



Solenoid valves VSVA, with pilot interface to ISO 15218

Technical data – Width 26 mm

Ordering data – Pilot control assembled						
Code	Circuit symbol		Part No.	Type		
2x 2/2-way solenoid valve						
T22C	–	Order via online configurator	–	–		
2x 3/2-way solenoid valve, with pilot control with square plug, type C to EN 175301-803						
K		Normal position: 2x closed	Internal pilot air supply	24 V DC	546692	VSVA-B-T32C-AH-A1-1C1
				12 V DC	547128	VSVA-B-T32C-AH-A1-5C1
				230 V AC	547208	VSVA-B-T32C-AH-A1-3AC1
				110 V AC	547168	VSVA-B-T32C-AH-A1-2AC1
				24 V AC	547088	VSVA-B-T32C-AH-A1-1AC1
N		Normal position: 2x open	Internal pilot air supply	24 V DC	546694	VSVA-B-T32U-AH-A1-1C1
				12 V DC	547130	VSVA-B-T32U-AH-A1-5C1
				230 V AC	547210	VSVA-B-T32U-AH-A1-3AC1
				110 V AC	547170	VSVA-B-T32U-AH-A1-2AC1
				24 V AC	547090	VSVA-B-T32U-AH-A1-1AC1
H		Normal position: 1x closed 1x open	Internal pilot air supply	24 V DC	547066	VSVA-B-T32H-AH-A1-1C1
				12 V DC	547132	VSVA-B-T32H-AH-A1-5C1
				230 V AC	547212	VSVA-B-T32H-AH-A1-3AC1
				110 V AC	547172	VSVA-B-T32H-AH-A1-2AC1
				24 V AC	547092	VSVA-B-T32H-AH-A1-1AC1
K		Normal position: 2x closed	External pilot air supply	24 V DC	547068	VSVA-B-T32C-AZH-A1-1C1
				12 V DC	547148	VSVA-B-T32C-AZH-A1-5C1
				230 V AC	547228	VSVA-B-T32C-AZH-A1-3AC1
				110 V AC	547188	VSVA-B-T32C-AZH-A1-2AC1
				24 V AC	547108	VSVA-B-T32C-AZH-A1-1AC1
N		Normal position: 2x open	External pilot air supply	24 V DC	547070	VSVA-B-T32U-AZH-A1-1C1
				12 V DC	547150	VSVA-B-T32U-AZH-A1-5C1
				230 V AC	547230	VSVA-B-T32U-AZH-A1-3AC1
				110 V AC	547190	VSVA-B-T32U-AZH-A1-2AC1
				24 V AC	547110	VSVA-B-T32U-AZH-A1-1AC1
H		Normal position: 1x closed 1x open	External pilot air supply	24 V DC	547072	VSVA-B-T32H-AZH-A1-1C1
				12 V AC	547152	VSVA-B-T32H-AZH-A1-5C1
				230 V AC	547232	VSVA-B-T32H-AZH-A1-3AC1
				110 V AC	547192	VSVA-B-T32H-AZH-A1-2AC1
				24 V AC	547112	VSVA-B-T32H-AZH-A1-1AC1

Solenoid valves VSVA, with pilot interface to ISO 15218

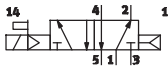
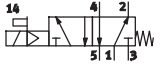
Technical data – Width 26 mm

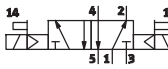
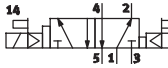
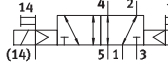
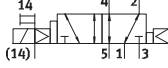
Ordering data – Pilot control assembled						
Code	Circuit symbol			Part No.	Type	
5/2-way solenoid valve, single solenoid, with pilot control with square plug, type C to EN 175301-803						
M		Pneumatic spring	Internal pilot air supply	24 V DC	546700	VSVA-B-M52-AH-A1-1C1
				12 V DC	547138	VSVA-B-M52-AH-A1-5C1
				230 V AC	547218	VSVA-B-M52-AH-A1-3AC1
				110 V AC	547178	VSVA-B-M52-AH-A1-2AC1
				24 V AC	547098	VSVA-B-M52-AH-A1-1AC1
O		Mechanical spring	Internal pilot air supply	24 V DC	546702	VSVA-B-M52-MH-A1-1C1
				12 V DC	547140	VSVA-B-M52-MH-A1-5C1
				230 V AC	547220	VSVA-B-M52-MH-A1-3AC1
				110 V AC	547180	VSVA-B-M52-MH-A1-2AC1
				24 V AC	547100	VSVA-B-M52-MH-A1-1AC1
M		Pneumatic spring	External pilot air supply	24 V DC	547078	VSVA-B-M52-AZH-A1-1C1
				12 V DC	547158	VSVA-B-M52-AZH-A1-5C1
				230 V AC	547238	VSVA-B-M52-AZH-A1-3AC1
				110 V AC	547198	VSVA-B-M52-AZH-A1-2AC1
				24 V AC	547118	VSVA-B-M52-AZH-A1-1AC1
O		Mechanical spring	External pilot air supply	24 V DC	547080	VSVA-B-M52-MZH-A1-1C1
				12 V DC	547160	VSVA-B-M52-MZH-A1-5C1
				230 V AC	547240	VSVA-B-M52-MZH-A1-3AC1
				110 V AC	547200	VSVA-B-M52-MZH-A1-2AC1
				24 V AC	547120	VSVA-B-M52-MZH-A1-1AC1
5/2-way solenoid valve, double solenoid, with pilot control with square plug, type C to EN 175301-803						
J		Dominant 1st signal	Internal pilot air supply	24 V DC	546696	VSVA-B-B52-H-A1-1C1
				12 V DC	547134	VSVA-B-B52-H-A1-5C1
				230 V AC	547214	VSVA-B-B52-H-A1-3AC1
				110 V AC	547174	VSVA-B-B52-H-A1-2AC1
				24 V AC	547094	VSVA-B-B52-H-A1-1AC1
D		Dominant signal at 14	Internal pilot air supply	24 V DC	546698	VSVA-B-D52-H-A1-1C1
				12 V DC	547136	VSVA-B-D52-H-A1-5C1
				230 V AC	547216	VSVA-B-D52-H-A1-3AC1
				110 V AC	547176	VSVA-B-D52-H-A1-2AC1
				24 V AC	547096	VSVA-B-D52-H-A1-1AC1
J		Dominant 1st signal	External pilot air supply	24 V DC	547074	VSVA-B-B52-ZH-A1-1C1
				12 V DC	547154	VSVA-B-B52-ZH-A1-5C1
				230 V AC	547234	VSVA-B-B52-ZH-A1-3AC1
				110 V AC	547194	VSVA-B-B52-ZH-A1-2AC1
				24 V AC	547114	VSVA-B-B52-ZH-A1-1AC1
D		Dominant signal at 14	External pilot air supply	24 V DC	547076	VSVA-B-D52-ZH-A1-1C1
				12 V DC	547156	VSVA-B-D52-ZH-A1-5C1
				230 V AC	547236	VSVA-B-D52-ZH-A1-3AC1
				110 V AC	547196	VSVA-B-D52-ZH-A1-2AC1
				24 V AC	547116	VSVA-B-D52-ZH-A1-1AC1





Solenoid valves VSVA, with pilot interface to ISO 15218

Technical data – Width 26 mm

Ordering data – Pilot control assembled						
Code	Circuit symbol			Part No.	Type	
5/3-way solenoid valve, with pilot control with square plug, type C to EN 175301-803						
G		Normal position: Closed	Internal pilot air supply	24 V DC	546708	VSVA-B-P53C-H-A1-1C1
				12 V DC	547146	VSVA-B-P53C-H-A1-5C1
				230 V AC	547226	VSVA-B-P53C-H-A1-3AC1
				110 V AC	547186	VSVA-B-P53C-H-A1-2AC1
				24 V AC	547106	VSVA-B-P53C-H-A1-1AC1
B		Normal position: Open	Internal pilot air supply	24 V DC	546704	VSVA-B-P53U-H-A1-1C1
				12 V DC	547142	VSVA-B-P53U-H-A1-5C1
				230 V AC	547222	VSVA-B-P53U-H-A1-3AC1
				110 V AC	547182	VSVA-B-P53U-H-A1-2AC1
				24 V AC	547102	VSVA-B-P53U-H-A1-1AC1
E		Normal position: Exhausted	Internal pilot air supply	24 V DC	546706	VSVA-B-P53E-H-A1-1C1
				12 V DC	547144	VSVA-B-P53E-H-A1-5C1
				230 V AC	547224	VSVA-B-P53E-H-A1-3AC1
				110 V AC	547184	VSVA-B-P53E-H-A1-2AC1
				24 V AC	547104	VSVA-B-P53E-H-A1-1AC1
G		Normal position: Closed	External pilot air supply	24 V DC	547086	VSVA-B-P53C-ZH-A1-1C1
				12 V DC	547166	VSVA-B-P53C-ZH-A1-5C1
				230 V AC	547246	VSVA-B-P53C-ZH-A1-3AC1
				110 V AC	547206	VSVA-B-P53C-ZH-A1-2AC1
				24 V AC	547126	VSVA-B-P53C-ZH-A1-1AC1
B		Normal position: Open	External pilot air supply	24 V DC	547082	VSVA-B-P53U-ZH-A1-1C1
				12 V DC	547162	VSVA-B-P53U-ZH-A1-5C1
				230 V AC	547242	VSVA-B-P53U-ZH-A1-3AC1
				110 V AC	547202	VSVA-B-P53U-ZH-A1-2AC1
				24 V AC	547122	VSVA-B-P53U-ZH-A1-1AC1
E		Normal position: Exhausted	External pilot air supply	24 V DC	547084	VSVA-B-P53E-ZH-A1-1C1
				12 V DC	547164	VSVA-B-P53E-ZH-A1-5C1
				230 V AC	547244	VSVA-B-P53E-ZH-A1-3AC1
				110 V AC	547204	VSVA-B-P53E-ZH-A1-2AC1
				24 V AC	547124	VSVA-B-P53E-ZH-A1-1AC1

Solenoid valves VSVA, with pilot interface to ISO 15218

Technical data – Width 26 mm without pilot valve

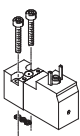
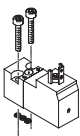
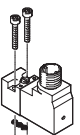
Ordering data – Pilot control separate							
				Part No.	Type		
2x 3/2-way valve without pilot valves							
	Internal pilot air supply	2x normally closed	546731	VSVA-B-T32C-A-A1-P1			
		2x normally open	546733	VSVA-B-T32U-A-A1-P1			
5/2-way single solenoid valve without pilot valve							
	Internal pilot air supply	Pneumatic	546739	VSVA-B-M52-A-A1-P1			
		Mechanical spring	546741	VSVA-B-M52-M-A1-P1			
5/2-way double solenoid valve without pilot valve							
	Internal pilot air supply	Dominant 1st signal	546735	VSVA-B-B52-A1-P1			
		Dominant signal at 14	546737	VSVA-B-D52-A1-P1			
5/3-way mid-position valve monostable without pilot valves							
	Internal pilot air supply	Normally closed	546747	VSVA-B-P53C-A1-P1			
		Normally open	546743	VSVA-B-P53U-A1-P1			
		Normally exhausted	546745	VSVA-B-P53E-A1-P1			
Pilot valve to ISO 15218							
	Square plug, type C to EN 175301-803	12 V DC	MO non-detenting	546257	VSCS-B-M32-MH-WA-5C1		
			MO detenting	571062	VSCS-B-M32-MD-WA-5C1		
		24 V DC	MO non-detenting	546256	VSCS-B-M32-MH-WA-1C1		
			MO detenting	571061	VSCS-B-M32-MD-WA-1C1		
		24 V AC	MO non-detenting	546258	VSCS-B-M32-MH-WA-1AC1		
			MO detenting	571063	VSCS-B-M32-MD-WA-1AC1		
	Square plug, type C to EN 175301-803, with protective earth conductor	24 V DC	MO, detenting/ non-detenting	546262	VSCS-B-M32-MT-WA-1C1		
		12 V DC/24 V AC	MO, detenting/ non-detenting	546261	VSCS-B-M32-MT-WA-5WC1		
			MO, detenting/ non-detenting	546263	VSCS-B-M32-MT-WA-2AC1		
		110 V AC	MO non-detenting	546259	VSCS-B-M32-MH-WA-2AC1		
			MO detenting	571064	VSCS-B-M32-MD-WA-2AC1		
		230 V AC	MO, detenting/ non-detenting	546260	VSCS-B-M32-MH-WA-3AC1		
			MO non-detenting	571065	VSCS-B-M32-MD-WA-3AC1		
			MO, detenting/ non-detenting	546264	VSCS-B-M32-MT-WA-3AC1		
			M12 round plug to IEC 61076-2-101	24 V DC	MO non-detenting	573214	VSCS-B-M32-MH-WA-1R3
					MO detenting	573215	VSCS-B-M32-MD-WA-1R3

MO Type of manual override

Solenoid valves VSVA, with central plug M8x1, M12x1

FESTO

Technical data – Width 18 mm

-  Flow rate
Max. 750 l/min

-  Voltage
24 V DC

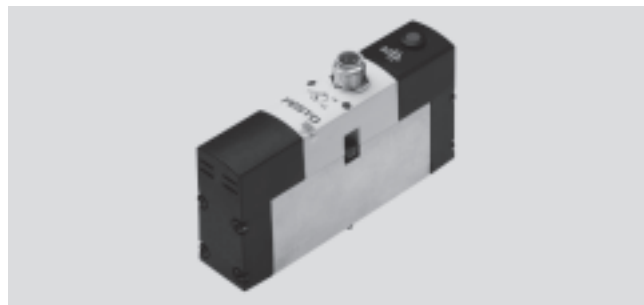

General technical data									
Valve function	2x 3/2			5/2		5/3			
Normal position	C ¹⁾	U ²⁾	H ⁴⁾	–	–	C ¹⁾	U ²⁾	E ³⁾	
Stable position	Monostable					Bistable	Monostable		
Pneumatic spring reset method	Yes			Yes	–	No			
Mechanical spring reset method	No			Yes	–	Yes			
Design	Piston spool valve								
Sealing principle	Soft								
Actuation type	Electric								
Type of control	Piloted								
Pilot air supply	Internal or external								
Direction of flow	Non-reversible				Reversible with external pilot air supply				
Exhaust function	With flow control								
Manual override	Non-detenting								
Type of mounting	On sub-base								
Mounting position	Any								
Nominal size	[mm]	5							
Flow rate of valve	[l/min]	600			750	650			
Flow rate of valve on individual sub-base	[l/min]	450			550	500			
Flow rate of pneumatically interlinked valve	[l/min]	400			550	450			
Standard nominal flow rate	[l/min]	400			550	450			
Switching time on/off, pneumatic spring	[ms]	10/22			20/25	–	–		
Switching time on/off, mechanical spring	[ms]	–			12/34	–	15/36		
Changeover time	[ms]	–			–	10	–		
Non-overlapping	Yes								
Width	[mm]	18							
Ports on the sub-base	1, 2, 3, 4, 5	G1/8							
	12, 14	M5							
Tightening torque, valve mounting	[Nm]	0.9 ... 1.1							
Product weight	[g]	140							
Noise level	[dB (A)]	85							
Conforms to	ISO 15407-1								
Corrosion resistance class	CRC	2 ⁵⁾							

1) C=Normally closed

2) U=Normally open

3) E=Normally exhausted

4) H=2x 3/2-way valve in one housing with 1x normally closed and 1x normally open

5) Corrosion resistance class 2 according to Festo standard 940 070

Components subject to moderate corrosion stress. Externally visible parts with primarily decorative surface requirements which are in direct contact with a normal industrial environment or media such as coolants or lubricating agents.

Solenoid valves VSVA, with central plug M8x1, M12x1

Technical data – Width 18 mm

Operating and environmental conditions			
Valve function		2x 3/2	5/2 5/3
Operating medium	Compressed air to ISO 8573-1:2010 [7:4:4]		
Note about the operating/pilot medium	Lubricated operation possible (required during subsequent operation)		
Operating pressure	Internal pilot air supply [bar]	3 ... 8	3 ... 8 3 ... 8
	External pilot air supply [bar]	3 ... 10	-0.9 ... 10 -0.9 ... 10
Pilot pressure [bar]		3 ... 8 ¹⁾	3 ... 8 3 ... 8
Ambient temperature [°C]	-5 ... +50		
Temperature of medium [°C]	-5 ... +50		

1) Pilot pressure dependent on operating pressure → Graph

Minimum pilot pressure p12, p14 as a function of operating pressure p1 (external pilot air supply) for the 2x 3/2-way solenoid valves

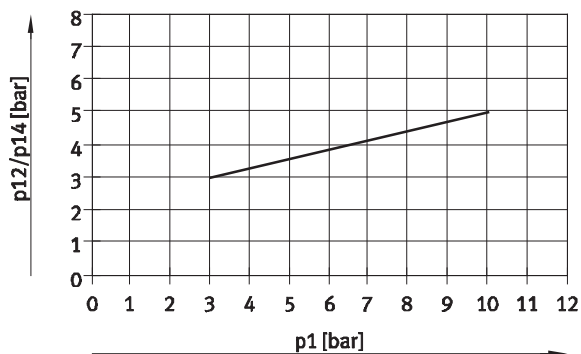

Electrical data			
Electrical connection	Central plug, round design, M8x1 4-pin or M12x1 3-pin		
Coil characteristics	Voltage [V DC]	24±10% = 21.6 ... 26.4	
	Output [W]	High-current phase: 2.4 ; low-current phase: 1 ¹⁾	
Duty cycle	%	100	
Protection class to EN 60529	IP65 (in combination with plug socket)		
Protective circuit and LED	Integrated in the valve		
Certification	C-Tick		
CE marking (see declaration of conformity)	To EU EMC Directive ²⁾		

- 1) Controlled by integrated current reduction
- 2) For information about the applicability of the component see the manufacturer's EC declaration of conformity at: www.festo.com → Support → User documentation.
If the component is subject to restrictions on usage in residential, office or commercial environments or small businesses, further measures to reduce the emitted interference may be necessary.

Solenoid valves VSVA, with central plug M8x1, M12x1

Technical data – Width 18 mm

FESTO

Materials

Sectional view

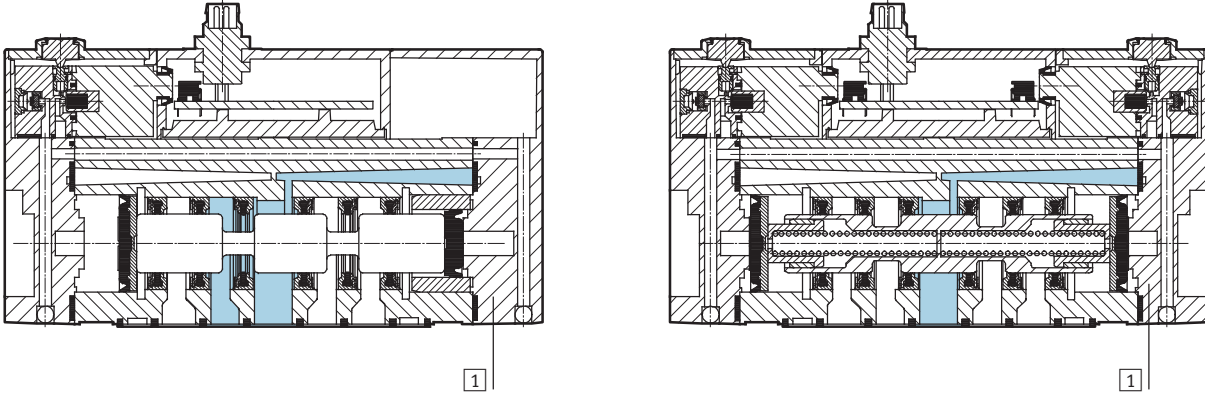

1	Housing	Die-cast aluminium, polyacetal
-	Seals	Nitrile rubber
-	Note on materials	RoHS-compliant

Dimensions

Download CAD Data → www.festo.com/us/cad

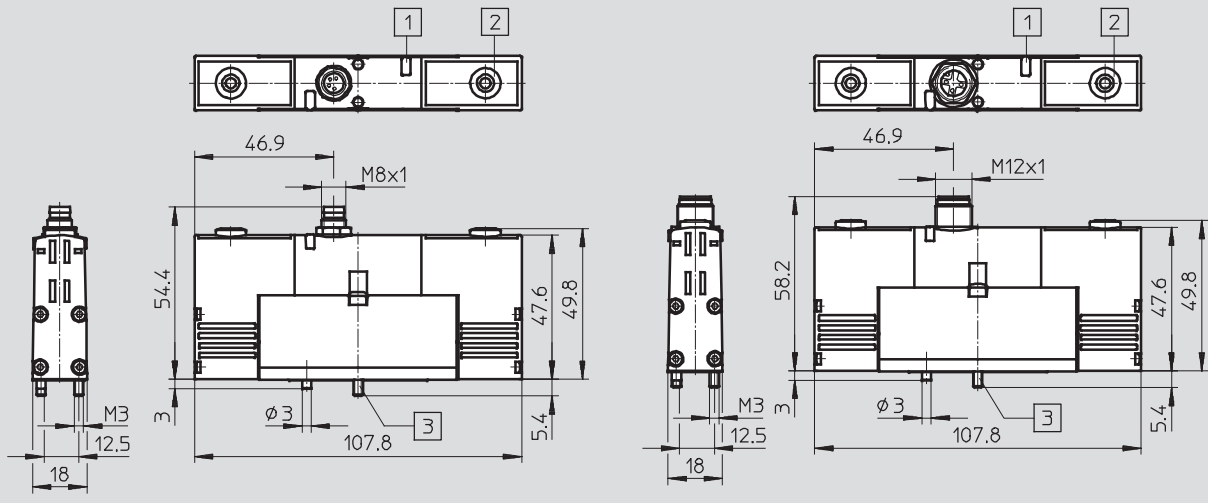

- 1 Light-emitting diode (LED)
- 2 Manual override
- 3 Captive mounting screws

Terminal allocation

M8x1

M12x1

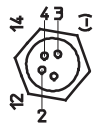

- 1 Unused
- 2 Signal (+) Solenoid 12/10
- 3 com (-)
- 4 Signal (+) Solenoid 14/10

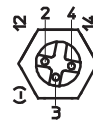

- 1 Unused
- 2 Signal (+) Solenoid 12
- 3 com (-)
- 4 Signal (+) Solenoid 14

Solenoid valves VSVA, with central plug M8x1, M12x1

Technical data – Width 18 mm

Ordering data						
Code	Circuit symbol			Part No.	Type	
2x 3/2-way solenoid valve						
K		Normal position: 2x closed	Internal pilot air supply	M8x1	534771	VSVA-B-T32C-AH-A2-1R2L
				M12x1	546764	VSVA-B-T32C-AH-A2-1R5L
N		Normal position: 2x open	Internal pilot air supply	M8x1	534772	VSVA-B-T32U-AH-A2-1R2L
				M12x1	546765	VSVA-B-T32U-AH-A2-1R5L
H		Normal position: 1x closed 1x open	Internal pilot air supply	M8x1	534773	VSVA-B-T32H-AH-A2-1R2L
				M12x1	546766	VSVA-B-T32H-AH-A2-1R5L
K		Normal position: 2x closed	External pilot air supply	M8x1	534781	VSVA-B-T32C-AZH-A2-1R2L
				M12x1	546774	VSVA-B-T32C-AZH-A2-1R5L
N		Normal position: 2x open	External pilot air supply	M8x1	534782	VSVA-B-T32U-AZH-A2-1R2L
				M12x1	546775	VSVA-B-T32U-AZH-A2-1R5L
H		Normal position: 1x closed 1x open	External pilot air supply	M8x1	534783	VSVA-B-T32H-AZH-A2-1R2L
				M12x1	546776	VSVA-B-T32H-AZH-A2-1R5L
5/2-way valve, single solenoid						
M		Pneumatic spring	Internal pilot air supply	M8x1	534774	VSVA-B-M52-AH-A2-1R2L
				M12x1	546767	VSVA-B-M52-AH-A2-1R5L
O		Mechanical spring	Internal pilot air supply	M8x1	534775	VSVA-B-M52-MH-A2-1R2L
				M12x1	546768	VSVA-B-M52-MH-A2-1R5L
M		Pneumatic spring	External pilot air supply	M8x1	534784	VSVA-B-M52-AZH-A2-1R2L
				M12x1	546777	VSVA-B-M52-AZH-A2-1R5L
O		Mechanical spring	External pilot air supply	M8x1	534785	VSVA-B-M52-MZH-A2-1R2L
				M12x1	546778	VSVA-B-M52-MZH-A2-1R5L

Solenoid valves VSVA, with central plug M8x1, M12x1

Technical data – Width 18 mm

Ordering data						
Code	Circuit symbol			Part No.	Type	
5/2-way valve, double solenoid						
J		Dominant 1st signal	Internal pilot air supply	M8x1	534776	VSVA-B-B52-H-A2-1R2L
				M12x1	546769	VSVA-B-B52-H-A2-1R5L
D		Dominant signal at 14	Internal pilot air supply	M8x1	534777	VSVA-B-D52-H-A2-1R2L
				M12x1	546770	VSVA-B-D52-H-A2-1R5L
J		Dominant 1st signal	External pilot air supply	M8x1	534786	VSVA-B-B52-ZH-A2-1R2L
				M12x1	546779	VSVA-B-B52-ZH-A2-1R5L
D		Dominant signal at 14	External pilot air supply	M8x1	534787	VSVA-B-D52-ZH-A2-1R2L
				M12x1	546780	VSVA-B-D52-ZH-A2-1R5L
5/3-way valve						
G		Normally closed	Internal pilot air supply	M8x1	534778	VSVA-B-P53C-H-A2-1R2L
				M12x1	546771	VSVA-B-P53C-H-A2-1R5L
B		Normally open	Internal pilot air supply	M8x1	534780	VSVA-B-P53U-H-A2-1R2L
				M12x1	546773	VSVA-B-P53U-H-A2-1R5L
E		Normally exhausted	Internal pilot air supply	M8x1	534779	VSVA-B-P53E-H-A2-1R2L
				M12x1	546772	VSVA-B-P53E-H-A2-1R5L
G		Normally closed	External pilot air supply	M8x1	534788	VSVA-B-P53C-ZH-A2-1R2L
				M12x1	546781	VSVA-B-P53C-ZH-A2-1R5L
B		Normally open	External pilot air supply	M8x1	534790	VSVA-B-P53U-ZH-A2-1R2L
				M12x1	546783	VSVA-B-P53U-ZH-A2-1R5L
E		Normally exhausted	External pilot air supply	M8x1	534789	VSVA-B-P53E-ZH-A2-1R2L
				M12x1	546782	VSVA-B-P53E-ZH-A2-1R5L

Solenoid valves VSVA, with central plug M8x1, M12x1

FESTO

Technical data – Width 26 mm

-  - Flow rate
Max. 1,400 l/min

-  - Voltage
24 V DC

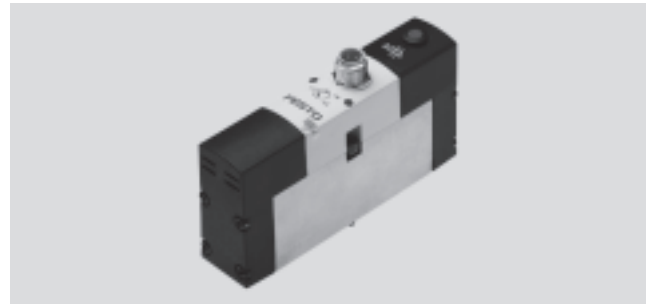

General technical data									
Valve function	2x 3/2			5/2		5/3			
Normal position	C ¹⁾	U ²⁾	H ⁴⁾	–	–	C ¹⁾	U ²⁾	E ³⁾	
Stable position	Monostable			Monostable	Bistable	Monostable			
Pneumatic spring reset method	Yes			Yes	–	No			
Mechanical spring reset method	No			Yes	–	Yes			
Design	Piston spool valve								
Sealing principle	Soft								
Actuation type	Electric								
Type of control	Piloted								
Pilot air supply	Internal or external								
Direction of flow	Non-reversible			Reversible with external pilot air supply					
Exhaust function	With flow control								
Manual override	Non-detenting								
Type of mounting	On sub-base								
Mounting position	Any								
Nominal size	[mm]	9							
Flow rate of valve	[l/min]	1,250		1,400		1,400			
Flow rate of valve on individual sub-base	[l/min]	1,000		1,100		1,100			
Flow rate of pneumatically interlinked valve	[l/min]	900		1,100		1,000			
Standard nominal flow rate	[l/min]	900		1,100		1,000			
Switching time on/off, pneumatic spring	[ms]	20/33		25/40		–		–	
Switching time on/off, mechanical spring	[ms]	–		20/52		–		20/52	
Changeover time, dominant 1st signal	[ms]	–		–		15		–	
Changeover time, dominance at 14	[ms]	–		–		25		–	
Non-overlapping	Yes								
Width	[mm]	26							
Connection on the sub-base	1, 2, 3, 4, 5 12, 14	G1/4 M5							
Tightening torque for valve mounting	[Nm]	1.8 ... 2.2							
Product weight	[g]	270							
Noise level	[dB (A)]	85							
Conforms to	ISO 15407-1								
Corrosion resistance class	CRC	2 ⁵⁾							

1) C=Normally closed

2) U=Normally open

3) E=Normally exhausted

4) H=2x 3/2-way valve in one housing with 1x normally closed and 1x normally open

5) Corrosion resistance class 2 according to Festo standard 940 070

Components subject to moderate corrosion stress. Externally visible parts with primarily decorative surface requirements which are in direct contact with a normal industrial environment or media such as coolants or lubricating agents.

Solenoid valves VSVA, with central plug M8x1, M12x1

FESTO

Technical data – Width 26 mm

Operating and environmental conditions			
Valve function		2x 3/2	5/2
			5/3
Operating medium		Compressed air to ISO 8573-1:2010 [7:4:4]	
Note about the operating/pilot medium		Lubricated operation possible (required during subsequent operation)	
Operating pressure	Internal pilot air supply [bar]	3 ... 8	3 ... 8
	External pilot air supply [bar]	3 ... 10	-0.9 ... 16
Pilot pressure [bar]		3 ... 8 ¹⁾	3 ... 8
Ambient temperature [°C]		-5 ... +50	
Temperature of medium [°C]		-5 ... +50	
Fire protection classification to UL94		V0	

1) Pilot pressure dependent on operating pressure → Graph

Minimum pilot pressure p12, p14 as a function of operating pressure p1 (external pilot air supply) for the 2x 3/2-way solenoid valves

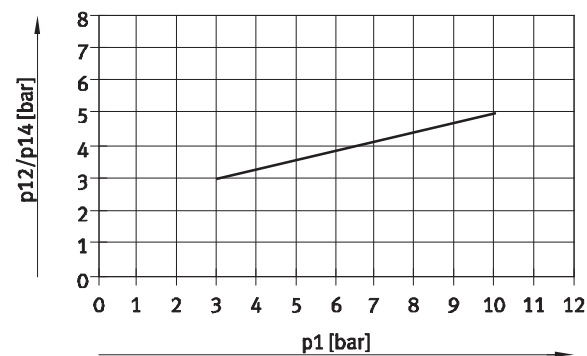

Electrical data			
Electrical connection		Central plug, round design, M8x1 4-pin or M12x1 3-pin	
Coil characteristics	Voltage [V DC]	24±10% = 21.6 ... 26.4	
	Output [W]	High-current phase: 2.4 ; low-current phase: 1 ¹⁾	
Duty cycle %		100	
Protection class to EN 60529		IP65 (in combination with plug socket)	
Protective circuit and LED		Integrated in the valve	
Certification		C-Tick	
CE marking (see declaration of conformity)		To EU EMC Directive ²⁾	

1) Controlled by integrated current reduction

2) For information about the applicability of the component see the manufacturer's EC declaration of conformity at: www.festo.com → Support → User documentation.

If the component is subject to restrictions on usage in residential, office or commercial environments or small businesses, further measures to reduce the emitted interference may be necessary.

Solenoid valves VSVA, with central plug M8x1, M12x1

Technical data – Width 26 mm

Materials

Sectional view

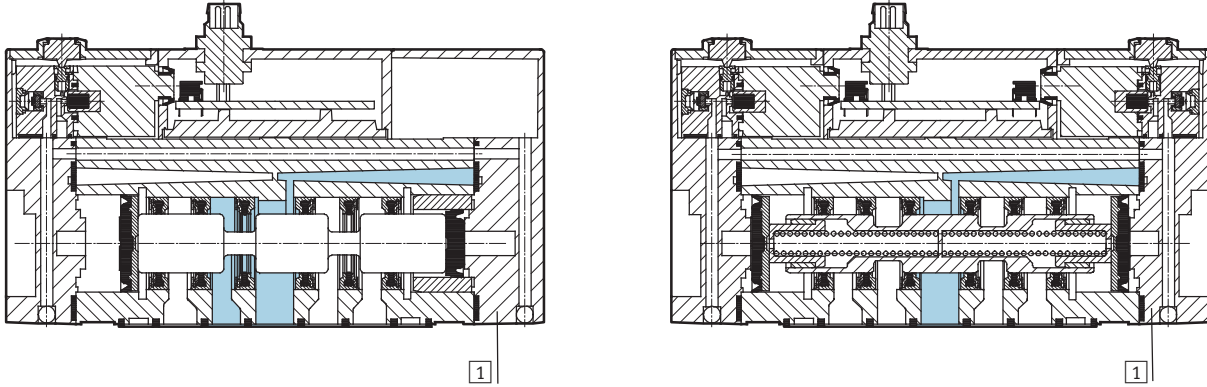

1	Housing	Die-cast aluminium, polyacetal
-	Seals	Nitrile rubber
-	Note on materials	RoHS-compliant

Dimensions

Download CAD Data → www.festo.com/us/cad

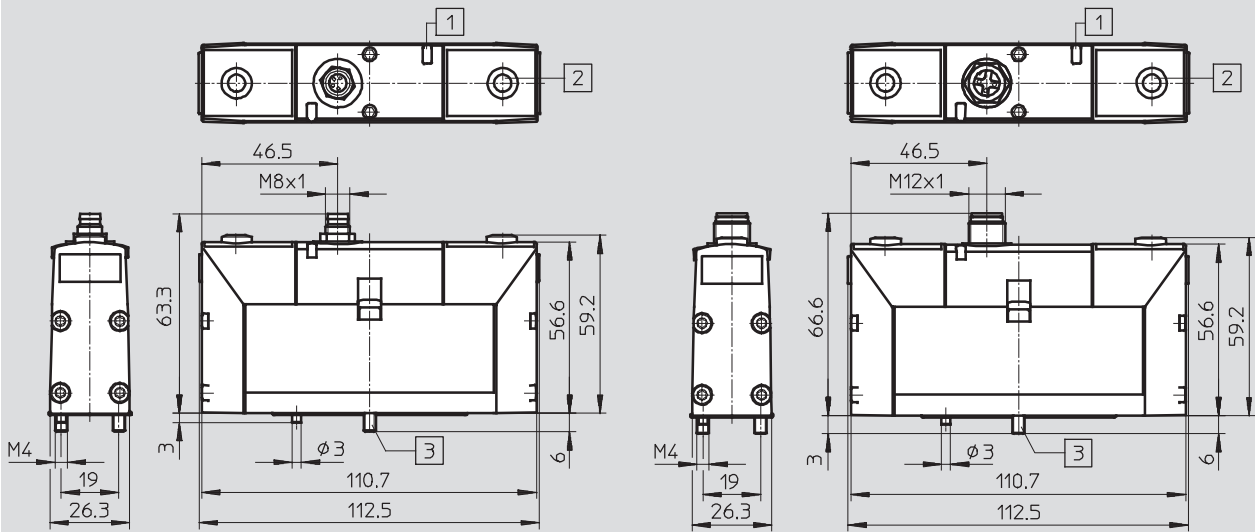

- 1 Light-emitting diode (LED)
- 2 Manual override
- 3 Captive mounting screws

Terminal allocation

M8x1

M12x1

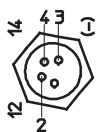

- 1 Unused
- 2 Signal (+) Solenoid 12/10
- 3 com (-)
- 4 Signal (+) Solenoid 14/10

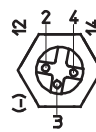



- 2 Signal (+) Solenoid 12
- 3 com (-)
- 4 Signal (+) Solenoid 14

Solenoid valves VSVA, with central plug M8x1, M12x1

FESTO

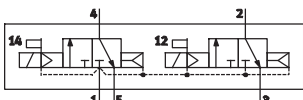
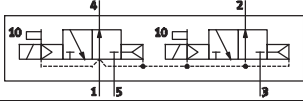
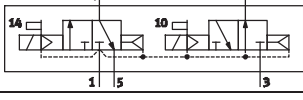
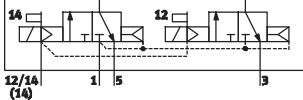
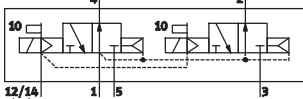
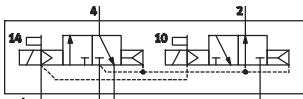
Technical data – Width 26 mm

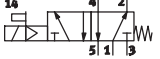
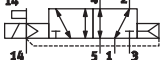
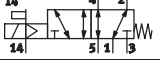
Ordering data						
Code	Circuit symbol			Part No.	Type	
2x 3/2-way solenoid valve						
K		Normal position: 2x closed	Internal pilot air supply	M8x1	534532	VSVA-B-T32C-AH-A1-1R2L
				M12x1	534552	VSVA-B-T32C-AH-A1-1R5L
N		Normal position: 2x open	Internal pilot air supply	M8x1	534533	VSVA-B-T32U-AH-A1-1R2L
				M12x1	534553	VSVA-B-T32U-AH-A1-1R5L
H		Normal position: 1x closed 1x open	Internal pilot air supply	M8x1	534534	VSVA-B-T32H-AH-A1-1R2L
				M12x1	534554	VSVA-B-T32H-AH-A1-1R5L
K		Normal position: 2x closed	External pilot air supply	M8x1	534522	VSVA-B-T32C-AZH-A1-1R2L
				M12x1	534542	VSVA-B-T32C-AZH-A1-1R5L
N		Normal position: 2x open	External pilot air supply	M8x1	534523	VSVA-B-T32U-AZH-A1-1R2L
				M12x1	534543	VSVA-B-T32U-AZH-A1-1R5L
H		Normal position: 1x closed 1x open	External pilot air supply	M8x1	534524	VSVA-B-T32H-AZH-A1-1R2L
				M12x1	534544	VSVA-B-T32H-AZH-A1-1R5L
5/2-way valve, single solenoid						
M		Pneumatic spring	Internal pilot air supply	M8x1	534535	VSVA-B-M52-AH-A1-1R2L
				M12x1	534555	VSVA-B-M52-AH-A1-1R5L
O		Mechanical spring	Internal pilot air supply	M8x1	534536	VSVA-B-M52-MH-A1-1R2L
				M12x1	534556	VSVA-B-M52-MH-A1-1R5L
M		Pneumatic spring	External pilot air supply	M8x1	534525	VSVA-B-M52-AZH-A1-1R2L
				M12x1	534545	VSVA-B-M52-AZH-A1-1R5L
O		Mechanical spring	External pilot air supply	M8x1	534526	VSVA-B-M52-MZH-A1-1R2L
				M12x1	534546	VSVA-B-M52-MZH-A1-1R5L

Solenoid valves VSVA, with central plug M8x1, M12x1

Technical data – Width 26 mm

Ordering data						
Code	Circuit symbol				Part No.	Type
5/2-way valve, double solenoid						
J		Dominant 1st signal	Internal pilot air supply	M8x1	534537	VSVA-B-B52-H-A1-1R2L
				M12x1	534557	VSVA-B-B52-H-A1-1R5L
D		Dominant signal at 14	Internal pilot air supply	M8x1	534538	VSVA-B-D52-H-A1-1R2L
				M12x1	534558	VSVA-B-D52-H-A1-1R5L
J		Dominant 1st signal	External pilot air supply	M8x1	534527	VSVA-B-B52-ZH-A1-1R2L
				M12x1	534547	VSVA-B-B52-ZH-A1-1R5L
D		Dominant signal at 14	External pilot air supply	M8x1	534528	VSVA-B-D52-ZH-A1-1R2L
				M12x1	534548	VSVA-B-D52-ZH-A1-1R5L
5/3-way solenoid valve						
G		Normally closed	Internal pilot air supply	M8x1	534539	VSVA-B-P53C-H-A1-1R2L
				M12x1	534559	VSVA-B-P53C-H-A1-1R5L
B		Normally open	Internal pilot air supply	M8x1	534541	VSVA-B-P53U-H-A1-1R2L
				M12x1	534561	VSVA-B-P53U-H-A1-1R5L
E		Normally exhausted	Internal pilot air supply	M8x1	534540	VSVA-B-P53E-H-A1-1R2L
				M12x1	534560	VSVA-B-P53E-H-A1-1R5L
G		Normally closed	External pilot air supply	M8x1	534529	VSVA-B-P53C-ZH-A1-1R2L
				M12x1	534549	VSVA-B-P53C-ZH-A1-1R5L
B		Normally open	External pilot air supply	M8x1	534531	VSVA-B-P53U-ZH-A1-1R2L
				M12x1	534551	VSVA-B-P53U-ZH-A1-1R5L
E		Normally exhausted	External pilot air supply	M8x1	534530	VSVA-B-P53E-ZH-A1-1R2L
				M12x1	534550	VSVA-B-P53E-ZH-A1-1R5L

Pneumatic valves VSPA, ISO 15407-1

FESTO

Technical data – Width 18 mm

-  - Flow rate
550 ... 750 l/min



General technical data					
Valve function	2x 3/2		5/2		5/3
Normal position	C ¹⁾ , U ²⁾ , H ⁴⁾		–		C ¹⁾ , U ²⁾ , E ³⁾
Stable position	Monostable		Monostable	Bistable	Monostable
Pneumatic spring reset method	Yes		Yes	–	No
Mechanical spring reset method	No		Yes	–	Yes
Design	Piston spool valve				
Sealing principle	Soft				
Actuation type	Pneumatic				
Type of control	Direct				
Direction of flow	Non-reversible		Reversible	Reversible	Reversible
Exhaust function	With flow control				
Type of mounting	On sub-base				
Mounting position	Any				
Nominal size [mm]	5				
Flow rate of valve [l/min]	600		750	750	650
Flow rate of valve on individual sub-base [l/min]	450		550	550	500
Flow rate of pneumatically interlinked valve [l/min]	400		550	550	450
Standard nominal flow rate [l/min]	400		550	550	450
Switching time on/off, pneumatic spring [ms]	10/15		11/20	–	–
Switching time on/off, mechanical spring [ms]	–		8/18	–	9/18
Changeover time [ms]	–		–	6	–
Changeover time (dominant) [ms]	–		–	6	–
Width [mm]	18				
Ports on the sub-base	1, 2, 3, 4, 5	G1/8			
	12, 14	M5			
Tightening torque for valve mounting [Nm]	0.9 ... 1.1				
Product weight [g]	80				
Conforms to	ISO 15407-1, VDMA 24563				

- 1) C=Normally closed
 2) U=Normally open
 3) E=Normally exhausted
 4) H=2x3/2-way valve in one housing with 1x normally closed and 1x normally open

Operating and environmental conditions					
Valve function	2x3/2	5/2-way, monostable		5/2-way, bistable	5/3
		Pneumatic spring	Mechanical spring		
Operating medium	Compressed air in accordance with ISO 8573-1:2010 [7:4:4]				
Pilot medium	Compressed air in accordance with ISO 8573-1:2010 [7:4:4]				
Note about the operating/pilot medium	Lubricated operation possible (required during subsequent operation)				
Operating pressure [bar]	2 ... 10	2 ... 10	–0.9 ... 10	–0.9 ... 10	–0.9 ... 10
Pilot pressure [bar]	2 ... 10	2 ... 10	3 ... 10	2 ... 10	3 ... 10
Ambient temperature [°C]	–10 ... +60				
Temperature of medium [°C]	–10 ... +60				
Fire protection classification to UL94	HB				

Pneumatic valves VSPA, ISO 15407-1

Technical data – Width 18 mm

Materials

Sectional view

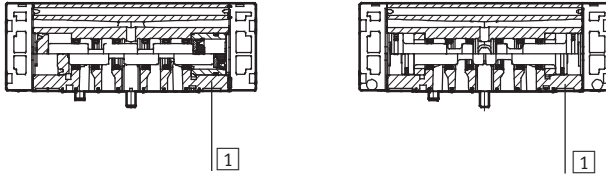

1	Housing	Die-cast aluminium
-	Seals	Nitrile rubber
-	Screws	Galvanised steel
-	Note on materials	RoHS-compliant

Dimensions

Download CAD Data → www.festo.com/us/cad

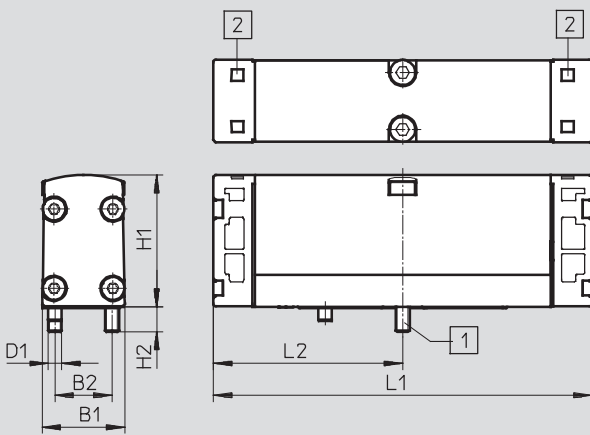

1 Captive screws 2 Slot for inscription label

	B1	B2	D1	H1	H2	L1	L2
VSPA-B	18	12.5	M3	29	5.4	83	41.5

Pneumatic valves VSPA, ISO 15407-1

Technical data – Width 18 mm

Ordering data			
Code	Circuit symbol	Part No.	Type
2x 3/2-way pneumatic valve			
K		2x normally closed	546721 VSPA-B-T32C-A2
N		2x normally open	546722 VSPA-B-T32U-A2
H		Normal position: 1x closed 1x open	546723 VSPA-B-T32H-A2
5/2-way pneumatic valve, monostable			
M		Pneumatic spring	546726 VSPA-B-M52-A-A2
O		Mechanical spring	546727 VSPA-B-M52-M-A2
5/2-way pneumatic valve, bistable			
J		Dominant 1st signal	546724 VSPA-B-B52-A2
D		Dominant signal at 14	546725 VSPA-B-D52-A2
5/3-way pneumatic valve			
G		Normally closed	546730 VSPA-B-P53C-A2
B		Normally open	546728 VSPA-B-P53U-A2
E		Normally exhausted	546729 VSPA-B-P53E-A2

Pneumatic valves VSPA, ISO 15407-1

Technical data – Width 26 mm

-  Flow rate
1,250 ... 1,400 l/min



General technical data					
Valve function	2x 3/2		5/2		5/3
Normal position	C ¹⁾ , U ²⁾ , H ⁴⁾		–	–	C ¹⁾ , U ²⁾ , E ³⁾
Stable position	Monostable		Monostable	Bistable	Monostable
Pneumatic spring reset method	Yes		Yes	–	No
Mechanical spring reset method	No		Yes	–	Yes
Design	Piston spool valve				
Sealing principle	Soft				
Actuation type	Pneumatic				
Type of control	Direct				
Direction of flow	Non-reversible		Reversible	Reversible	Reversible
Exhaust function	With flow control				
Type of mounting	On sub-base				
Mounting position	Any				
Nominal size [mm]	9				
Flow rate of valve [l/min]	1,250	1,400	1,400	1,400	1,400
Flow rate of valve on individual sub-base [l/min]	1,000	1,100	1,100	1,100	1,100
Flow rate of pneumatically interlinked valve [l/min]	900	1,100	1,100	1,100	1,000
Standard nominal flow rate [l/min]	900	1,100	1,100	1,100	1,000
Switching time on/off, pneumatic spring [ms]	15/28	18/30	–	–	–
Switching time on/off, mechanical spring [ms]	–	10/35	–	–	13/32
Changeover time [ms]	–	–	10	–	–
Changeover time (dominant) [ms]	–	–	10	–	–
Width [mm]	26				
Connection on the sub-base	1, 2, 3, 4, 5	G1/4			
	12, 14	M5			
Tightening torque for valve mounting [Nm]	1.8 ... 2.2				
Product weight [g]	180				
Conforms to	ISO 15407-1, VDMA 24563				

- 1) C=Normally closed
- 2) U=Normally open
- 3) E=Normally exhausted
- 4) H=2x3/2-way valve in one housing with 1x normally closed and 1x normally open

Operating and environmental conditions					
Valve function	2x3/2	5/2-way, monostable		5/2-way, bistable	5/3
		Pneumatic spring	Mechanical spring		
Operating medium	Compressed air in accordance with ISO 8573-1:2010 [7:4:4]				
Pilot medium	Compressed air in accordance with ISO 8573-1:2010 [7:4:4]				
Note about the operating/pilot medium	Lubricated operation possible (required during subsequent operation)				
Operating pressure [bar]	2 ... 10	2 ... 10	–0.9 ... 16	–0.9 ... 16	–0.9 ... 16
Pilot pressure [bar]	2 ... 10	2 ... 10	3 ... 10	2 ... 10	3 ... 10
Ambient temperature [°C]	–10 ... +60				
Temperature of medium [°C]	–10 ... +60				
Fire protection classification to UL94	HB				

Pneumatic valves VSPA, ISO 15407-1

Technical data – Width 26 mm

Materials

Sectional view

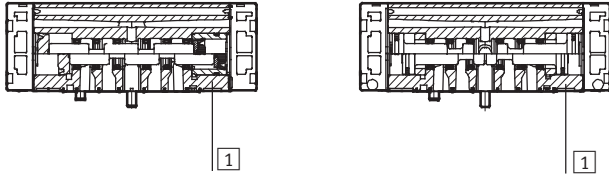

1	Housing	Die-cast aluminium
-	Seals	Nitrile rubber
-	Screws	Galvanised steel
-	Note on materials	RoHS-compliant

Dimensions

Download CAD Data → www.festo.com/us/cad

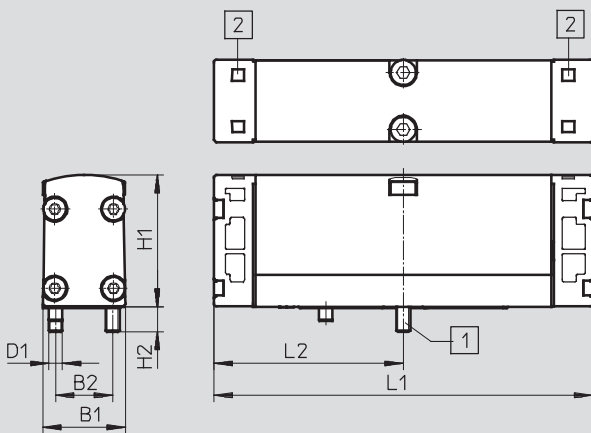



1 Captive screws 2 Slot for inscription label

	B1	B2	D1	H1	H2	L1	L2
VSPA-B	26.2	19	M4	38	7	100	50

Pneumatic valves VSPA, ISO 15407-1

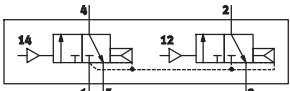
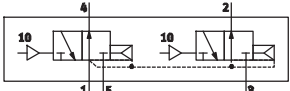
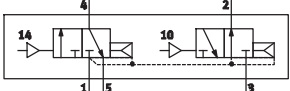
Technical data – Width 26 mm

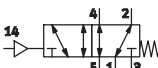
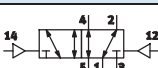
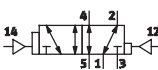
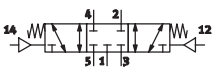
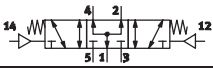
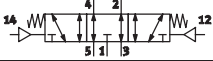
Ordering data				
Code	Circuit symbol		Part No.	Type
2x 3/2-way pneumatic valve				
K		2x normally closed	546711	VSPA-B-T32C-A1
N		2x normally open	546712	VSPA-B-T32U-A1
H		Normal position: 1x closed 1x open	546713	VSPA-B-T32H-A1
5/2-way pneumatic valve, monostable				
M		Pneumatic spring	546716	VSPA-B-M52-A-A1
O		Mechanical spring	546717	VSPA-B-M52-M-A1
5/2-way pneumatic valve, bistable				
J		Dominant 1st signal	546714	VSPA-B-B52-A1
D		Dominant signal at 14	546715	VSPA-B-D52-A1
5/3-way pneumatic valve				
G		Normally closed	546720	VSPA-B-P53C-A1
B		Normally open	546718	VSPA-B-P53U-A1
E		Normally exhausted	546719	VSPA-B-P53E-A1

Manifold components, ISO 15407-1

Vertical stacking



Regulator plate

VABF-S3-2-R

VABF-S3-1-R

Temperature range

-5 ... +50 °C

Pressure

0.5 ... 10 bar

Pressure regulation ranges:

0.5 ... 6 bar, 0.5 ... 10 bar

Output pressure constant with secondary venting

Material:

Housing: Die-cast aluminium

Control section: PA

Note on materials:

RoHS-compliant

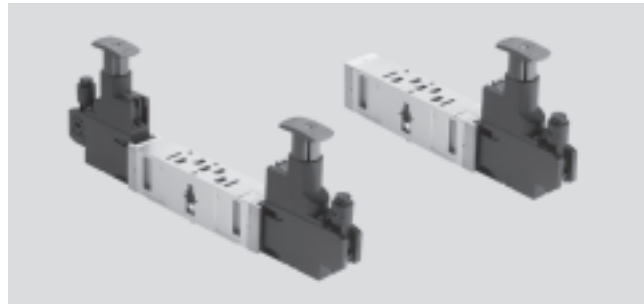

Operating and environmental conditions	
Operating medium	Compressed air according to ISO 8573-1:2010 [7:4:4]
Note about the operating/pilot medium	Lubricated operation possible (required during subsequent operation)

Dimensions Download CAD Data → www.festo.com/us/cad

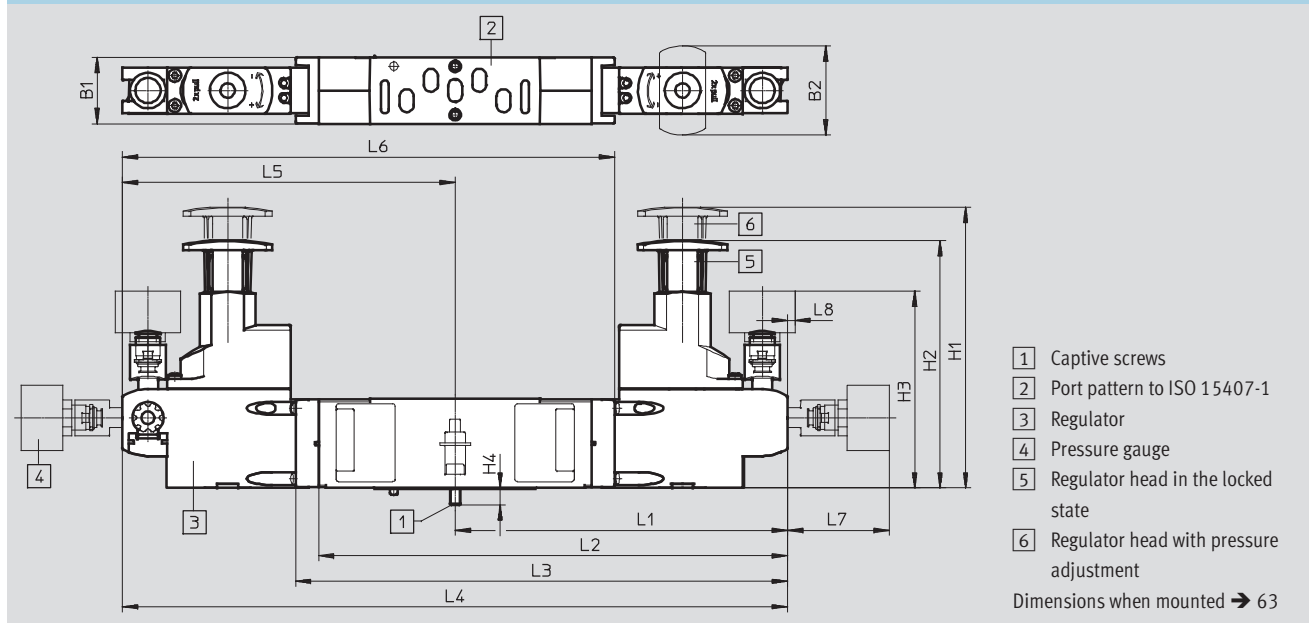

- 1 Captive screws
 - 2 Port pattern to ISO 15407-1
 - 3 Regulator
 - 4 Pressure gauge
 - 5 Regulator head in the locked state
 - 6 Regulator head with pressure adjustment
- Dimensions when mounted → 63

Type	B1	B2	H1	H2	H3	H4	L1	L2	L3	L4	L5	L6	L7	L8
VABF-S3-2-R1	18	35	110	97	77.3	5.6	126.7	180.6	-	-	-	-	39.8	2.9
VABF-S3-2-R2							126.7	-	187.7	-	-	-		
VABF-S3-2-R3							-	-	-	-	126.7	187.7		
VABF-S3-2-R4							126.7	-	-	253.4	-	-		
VABF-S3-2-R5							126.7	-	-	253.4	-	-		
VABF-S3-2-R6							126.7	-	187.7	-	-	-		
VABF-S3-2-R7							-	-	-	-	126.7	187.7		
VABF-S3-1-R1	26	35	110	97	77.3	5.6	130.4	183.9	183.9	-	-	-	39.8	2.9
VABF-S3-1-R2							130.4	-	192.9	-	-	-		
VABF-S3-1-R3							-	-	-	-	130.4	192.9		
VABF-S3-1-R4							130.4	-	-	260.7	-	-		
VABF-S3-1-R5							130.4	-	-	260.7	-	-		
VABF-S3-1-R6							130.4	195	195	-	-	-		
VABF-S3-1-R7							-	-	-	-	130.4	192.9		

Manifold components, ISO 15407-1

Vertical stacking



Ordering data										
Code	Circuit symbol	For port	Regulator	Control range	Width [mm]	Weight [g]	Part No.	Type		
ZA		1	P	0.5 ... 10 bar	18	380	543526	VABF-S3-2-R1C2-C-10		
					26	439	543527	VABF-S3-1-R1C2-C-10		
ZF		0.5 ... 6 bar		18	380	543524	VABF-S3-2-R1C2-C-6			
				26	439	543525	VABF-S3-1-R1C2-C-6			
ZC			2	B	0.5 ... 10 bar	18	390	543534	VABF-S3-2-R2C2-C-10	
						26	452	543535	VABF-S3-1-R2C2-C-10	
ZH			0.5 ... 6 bar		18	390	543532	VABF-S3-2-R2C2-C-6		
					26	452	543533	VABF-S3-1-R2C2-C-6		
ZB				4	A	0.5 ... 10 bar	18	390	543530	VABF-S3-2-R3C2-C-10
							26	452	543531	VABF-S3-1-R3C2-C-10
ZG	0.5 ... 6 bar	18		390		543528	VABF-S3-2-R3C2-C-6			
		26		452		543529	VABF-S3-1-R3C2-C-6			
ZD		2 and 4		AB	0.5 ... 10 bar	18	650	543538	VABF-S3-2-R4C2-C-10	
						26	712	543539	VABF-S3-1-R4C2-C-10	
ZI		0.5 ... 6 bar	18		650	543536	VABF-S3-2-R4C2-C-6			
			26		712	543537	VABF-S3-1-R4C2-C-6			
ZE			2 and 4, reversible	AB	0.5 ... 10 bar	18	650	543542	VABF-S3-2-R5C2-C-10	
						26	712	543543	VABF-S3-1-R5C2-C-10	
ZJ	0.5 ... 6 bar		18		650	543540	VABF-S3-2-R5C2-C-6			
			26		712	543541	VABF-S3-1-R5C2-C-6			
ZL			2, reversible	B	0.5 ... 10 bar	18	390	546788	VABF-S3-2-R6C2-C-10	
						26	452	546789	VABF-S3-1-R6C2-C-10	
ZN		0.5 ... 6 bar	18		390	546786	VABF-S3-2-R6C2-C-6			
			26		452	546787	VABF-S3-1-R6C2-C-6			
ZK			4, reversible	A	0.5 ... 10 bar	18	390	546792	VABF-S3-2-R7C2-C-10	
						26	452	546793	VABF-S3-1-R7C2-C-10	
ZM	0.5 ... 6 bar		18		390	546790	VABF-S3-2-R7C2-C-6			
			26		452	546791	VABF-S3-1-R7C2-C-6			

Manifold components, ISO 15407-1

Vertical stacking

FESTO

Flow control plate

VABF-S3-2-F

VABF-S3-1-F

Material:

Housing: Die-cast aluminium

Note on materials:

RoHS-compliant

Temperature range

-5 ... +50 °C

Pressure

-0.9 ... 10 bar

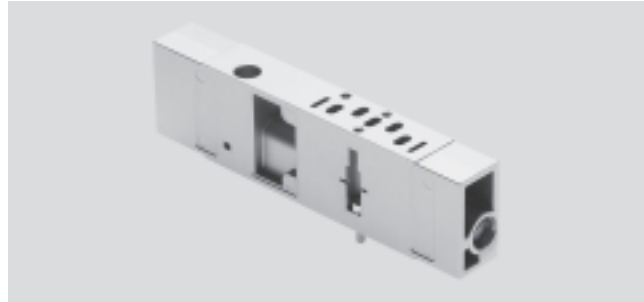

Operating and environmental conditions	
Operating medium	Compressed air according to ISO 8573-1:2010 [7:4:4]
Note about the operating/pilot medium	Lubricated operation possible (required during subsequent operation)

Dimensions Download CAD Data → www.festo.com/us/cad

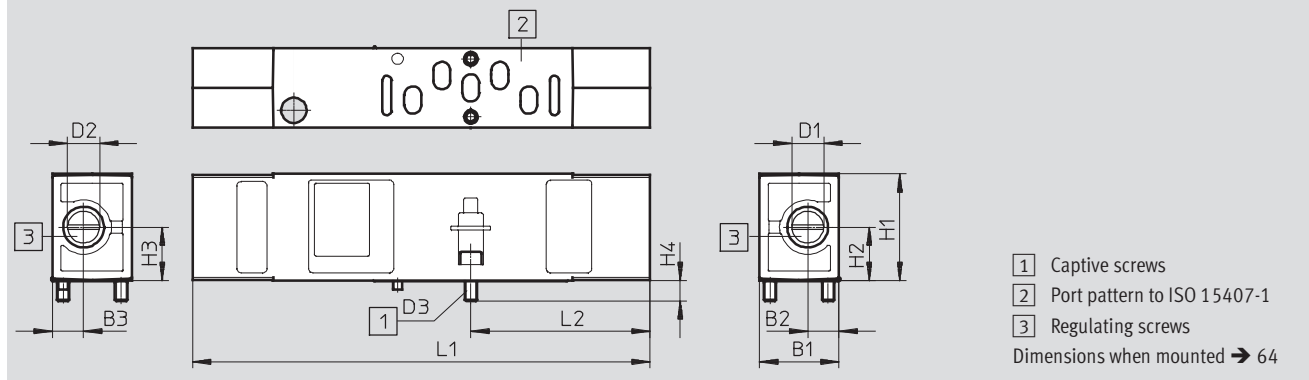

Type	B1	B2	B3	D1	D2	D3	H1	H2	H3	H4	L1	L2
VABF-S3-2-F1B1-C	18	6.5	6.5	9.3	9.3	M3x 12	35	12	12	5.6	130	43.3
VABF-S3-1-F1B1-C	26	10.2	10.2	11.2	11.2	M4x 12	35	17.5	17.5	6.7	150	58.8

Ordering data						
Code	Circuit symbol	Description	Width [mm]	Weight [g]	Part No.	Type
X		For exhaust air flow control in ducts 3 and 5 on the valve	18	228	543603	VABF-S3-2-F1B1-C
			26	320	543604	VABF-S3-1-F1B1-C

Manifold components, ISO 15407-1

Vertical stacking

Vertical supply plate

VABF-S3-2-P

VABF-S3-1-P

Material:
Housing: Die-cast aluminium

Note on materials:
RoHS-compliant

Temperature range
-5 ... +50°C
Pressure
-0.9 ... +10 bar



Operating and environmental conditions	
Operating medium	Compressed air according to ISO 8573-1:2010 [7:4:4]
Note about the operating/pilot medium	Lubricated operation possible (required during subsequent operation)

Dimensions Download CAD Data → www.festo.com/us/cad

1 Captive screws
2 Port pattern to ISO 15407-1
 Dimensions when mounted → 65

Type	B1	B2	D1	D2	H1	H2	H3	L1	L2
VABF-S3-2-P1A3-G18	18	9	G $\frac{1}{8}$	M3x 12	35	23.4	5.6	121.6	67.7
VABF-S3-1-P1A3-G14	26	13	G $\frac{1}{4}$	M4x 12	35	23.2	6.7	128.1	74.6

Ordering data							
Code	Circuit symbol	Description	Width [mm]	Flow rates [l/min]	Weight [g]	Part No.	Type
ZU		For the independent supply of a valve	18	500	146	544435	VABF-S3-2-P1A3-G18
			26	1,000	201	544434	VABF-S3-1-P1A3-G14

Manifold components, ISO 15407-1

Vertical stacking



Vertical pressure shut-off plate

VABF-S3-2-L

VABF-S3-1-L

Material:

Housing: Die-cast aluminium

Note on materials:

RoHS-compliant

Temperature range

-5 ... +50 °C

Pressure

-0.9 ... +10 bar

Flow rate

800 l/min



Operating and environmental conditions	
Operating medium	Compressed air according to ISO 8573-1:2010 [7:4:4]
Note about the operating/pilot medium	Lubricated operation possible (required during subsequent operation)

Dimensions Download CAD Data → www.festo.com/us/cad

1 Captive screws
 2 Port pattern to ISO 15407-1
 3 Plug screw
 Dimensions when mounted → 66

Type	B1	B2	B3	D1	D2	H1	H2	H3	H4	L1	L2
VABF-S3-2-L1D1-C	18	9	5.1	M5	M3x 12	35	11.7	5.6	5.3	163.7	109.8
VABF-S3-1-L1D1-C	26	13	9.1	M5	M4x 12	35	11.6	6.7	5.3	167	113.4

Ordering data

Code	Circuit symbol	Description	Width [mm]	Flow rates [l/min]	Weight [g]	Part No.	Type
ZT		For shutting off a valve from the supply pressure	18	400	212	543601	VABF-S3-2-L1D1-C
			26	800	286	543602	VABF-S3-1-L1D1-C

Manifold components, ISO 15407-1

Individual linking



Individual sub-base NAS

Material:
Die-cast aluminium

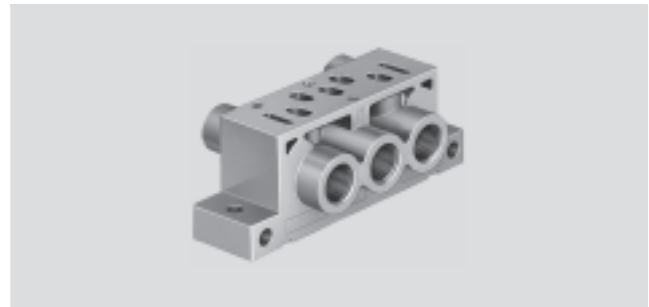

Operating and environmental conditions	
Operating medium	Compressed air according to ISO 8573-1:2010 [7:4:4]
Note about the operating/pilot medium	Lubricated operation possible (required during subsequent operation)

Dimensions Download CAD Data → www.festo.com/us/cad

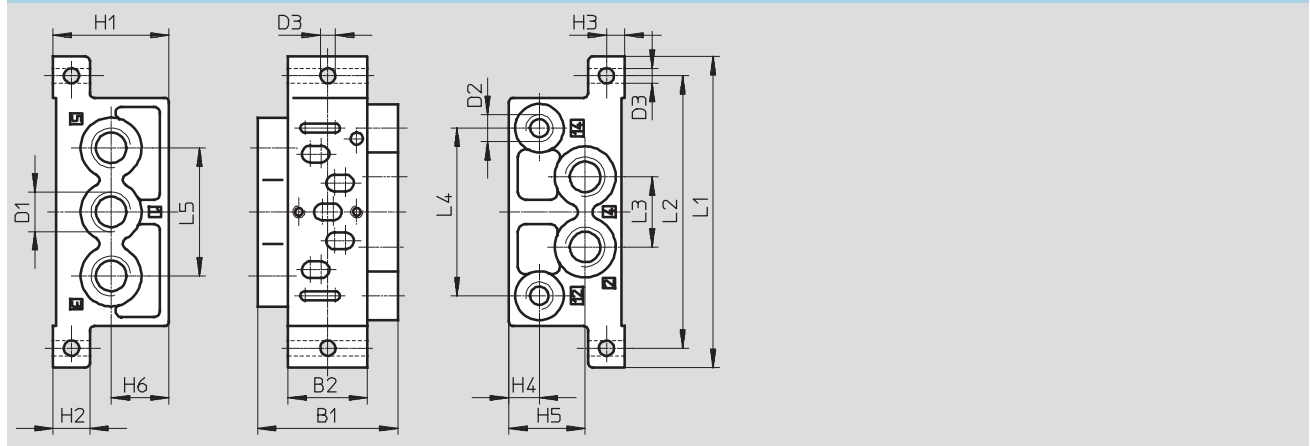

Type	B1	B2	D1	D2	D3	H1	H2	H3	H4	H5	H6	L1	L2	L3	L4	L5
NAS-1/8-02-VDMA	28.5	18	G1/8	M5	5.5	31	10	5	7	20	14.5	79	66.5	17	40	32
NAS-1/4-01-VDMA	46	26	G1/4	G1/8	5	38	12	6	10	25	19	102	89.4	23	55	42

Ordering data						
Type of mounting	Width [mm]	Pneumatic connection		Weight [g]	Part No.	Type
		1, 2, 3, 4, 5	12, 14			
2 through-holes in housing	18	G1/8	M5	67	161115	NAS-1/8-02-VDMA
	26	G1/4	G1/8	160	161109	NAS-1/4-01-VDMA

Manifold components, ISO 15407-1

Horizontal stacking

FESTO

Manifold sub-base NAW

Material:
Die-cast aluminium



Operating and environmental conditions	
Operating medium	Compressed air according to ISO 8573-1:2010 [7:4:4]
Note about the operating/pilot medium	Lubricated operation possible (required during subsequent operation)

Ordering data						
Manifold sub-base	Width [mm]	Pneumatic connection		Weight [g]	Part No.	Type
		2, 4	12, 14			
For solenoid valves	18	G $\frac{1}{8}$	–	130	161110	NAW- $\frac{1}{8}$ -02-VDMA
	26	G $\frac{1}{4}$	–	225	161102	NAW- $\frac{1}{4}$ -01-VDMA
For pneumatic valves	18	G $\frac{1}{8}$	M5	130	161111	NAW- $\frac{1}{8}$ -02-VDMA-VL
	26	G $\frac{1}{4}$	M5	225	161103	NAW- $\frac{1}{4}$ -01-VDMA-VL

Dimensions → 60

End plate kit NEV

Material:
Die-cast aluminium



Operating and environmental conditions	
Operating medium	Compressed air according to ISO 8573-1:2010 [7:4:4]
Note about the operating/pilot medium	Lubricated operation possible (required during subsequent operation)

Ordering data						
Scope of delivery	Width [mm]	Pneumatic connection		Weight [g]	Part No.	Type
		1, 3, 5	12, 14			
End plate left and right, screws, H-rail mounting, one isolating disc each for ports 1, 3, 5, 12 and 14	18	G $\frac{3}{8}$	G $\frac{1}{8}$	280	161112	NEV-02-VDMA
	26	G $\frac{1}{2}$	G $\frac{1}{8}$	445	161104	NEV-01-VDMA
End plate left 18 mm and right 26 mm, screws, H-rail mounting	18, 26	G $\frac{3}{8}$, G $\frac{1}{2}$	G $\frac{1}{8}$	372	191405	NEV-02-01-VDMA

Dimensions → 60

Manifold components, ISO 15407-1

Horizontal stacking

Intermediate plate NZV

For combi manifold with widths of 18 mm and 26 mm

Material:
Die-cast aluminium



Operating and environmental conditions	
Operating medium	Compressed air according to ISO 8573-1:2010 [7:4:4]
Note about the operating/pilot medium	Lubricated operation possible (required during subsequent operation)

Dimensions Download CAD Data → www.festo.com/us/cad

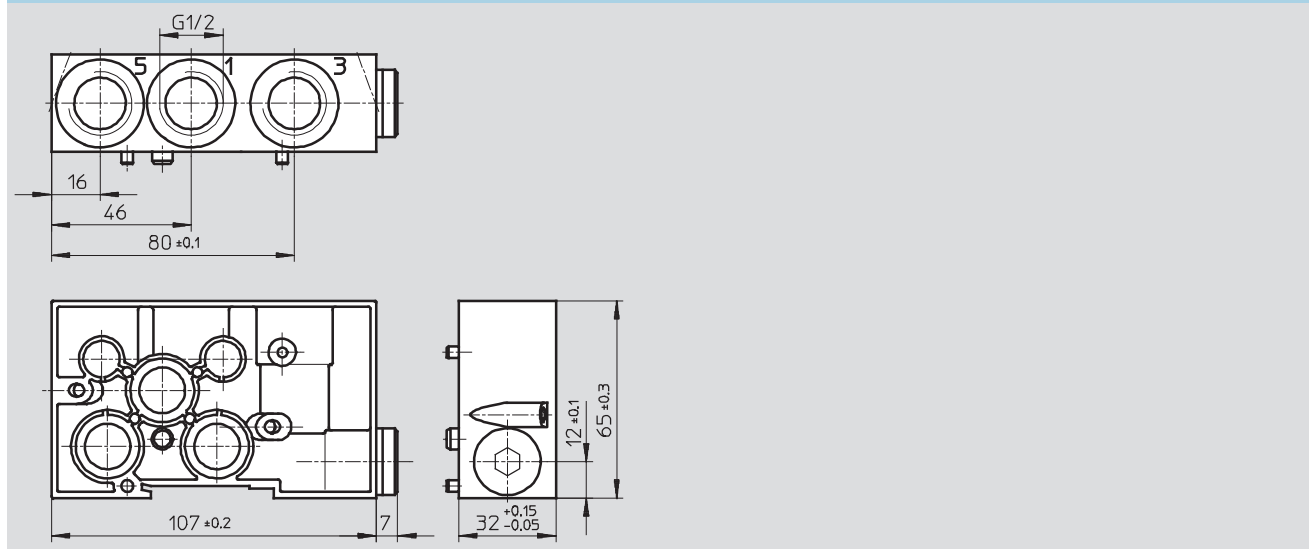

Ordering data						
Description	Width [mm]	Pneumatic connection		Weight [g]	Part No.	Type
		1, 3, 5	12, 14			
Intermediate plate to combine manifold sub-bases of widths 18 mm and 26 mm	18 and 26	G1/2	–	270	161108	NZV-01/02-VDMA

Manifold components, ISO 15407-1

Technical data

FESTO

Dimensions – Manifold sub-bases without valves

Download CAD Data → www.festo.com/us/cad

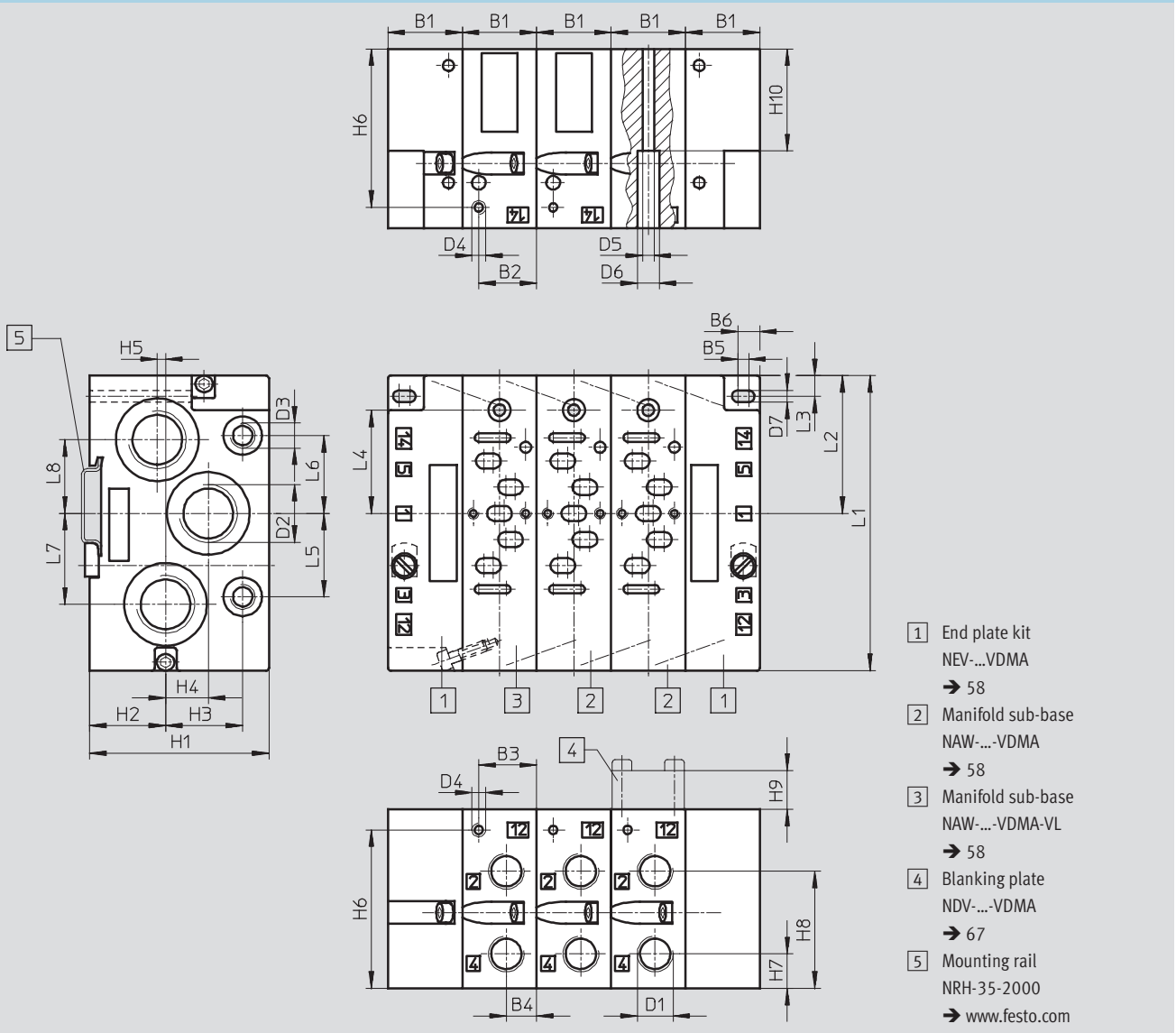

Width [mm]	B1	B2	B3	B4	B5	B6	D1	D2	D3	D4	D5	D6	D7
18	19	6	13	7.5	1	4.5	G $\frac{3}{8}$	G $\frac{3}{8}$	G $\frac{3}{8}$	M5	3.3	6.3	4.3
26	27	21	21	11	4	8	G $\frac{3}{4}$	G $\frac{1}{2}$	G $\frac{3}{8}$	M5	4.2	8	4.2

Width [mm]	H1	H2	H3	H4	H5	H6	H7	H8	H9	H10	L1	L2	L3	L4	L5	L6	L7	L8
18	55	17	28.8	18.5	–	48	10.5	35.5	12	40	81	36.5	5.6	30.9	20	20	18	18
26	65	27.5	28	15.5	3	57.5	12.5	42.5	14	37	107	50	7.5	37.5	30.3	28.3	33	26.8

Manifold components, ISO 15407-1

Technical data

FESTO

Dimensions – Manifold assembly, width 18 mm

Download CAD Data → www.festo.com/us/cad

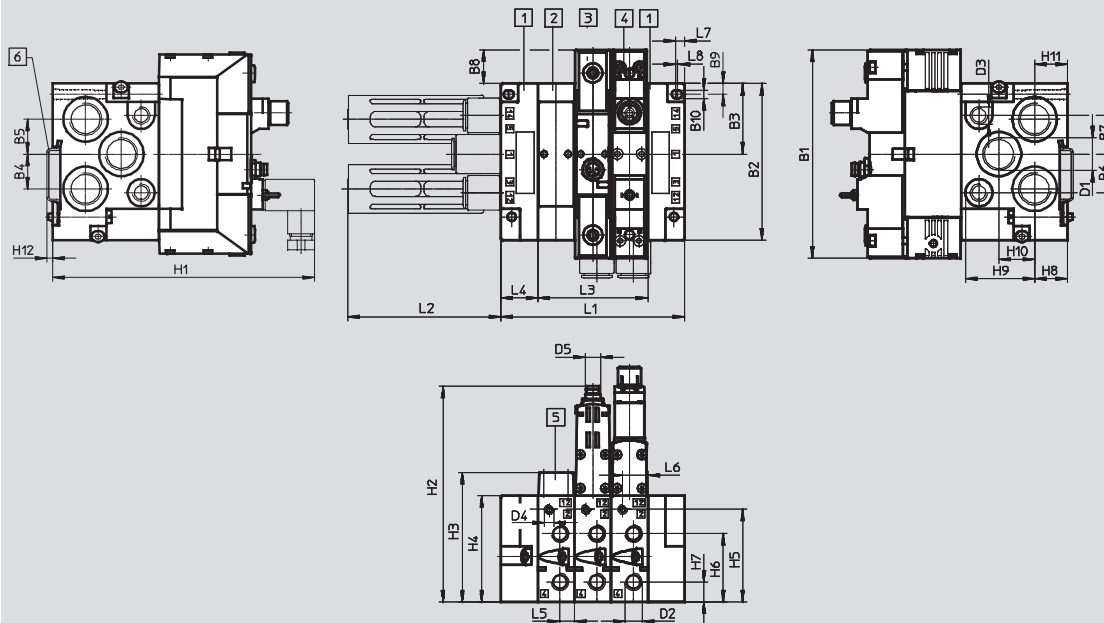

- 1 End plate kit type NEV-02-VDMA
- 2 Manifold sub-bases type NAW-1/8-02-VDMA
- 3 Solenoid valve with central plug
- 4 Solenoid valve with pilot interface to ISO 15218
- 5 Blanking plate NDV-02-VDMA
- 6 Mounting rail NRH-35-2000
- 7 Solenoid valve with central plug
- 8 Solenoid valve with pilot interface to ISO 15218

	B1	B2	B3	B4	B5	B6	B7	B8	B9	B10	D1	D2	D3	D4	D5	H1	H2	H3
VSVA-B-...A2	107.8	81	36.5	18	18	20	20	17.4	5.6	4.3	G3/8	G1/8	G1/8	M5	–	135.6	55	67
VSVA-B-M52-...A2	95.4	81	36.5	18	18	20	20	5	5.6	4.3	G3/8	G1/8	G1/8	M5	–	135.6	55	67
VSVA-B-...A2-R2L	107.8	81	36.5	18	18	20	20	17.4	5.6	4.3	G3/8	G1/8	G1/8	M5	M8	121.8	111.8	67
VSVA-B-...A2-R5L	107.8	81	36.5	18	18	20	20	17.4	5.6	4.3	G3/8	G1/8	G1/8	M5	M12	121.8	111.8	67

	H4	H5	H6	H7	H8	H9	H10	H11	H12	L1	L2	L3	L4	L5	L6	L7	L8
VSVA-B-...A2	55	48	35.5	10.5	17	35.9	18.5	17	3.5	38 + nx 19	79.1	nx 19	19	7.5	13	4.5	1
VSVA-B-M52-...A2	55	48	35.5	10.5	17	35.9	18.5	17	3.5	38 + nx 19	79.1	nx 19	19	7.5	13	4.5	1
VSVA-B-...A2-R2L	55	48	35.5	10.5	17	35.8	18.5	17	3.5	38 + nx 19	79.1	nx 19	19	7.5	13	4.5	1
VSVA-B-...A2-R5L	55	48	35.5	10.5	17	35.8	18.5	17	3.5	38 + nx 19	79.1	nx 19	19	7.5	13	4.5	1

Manifold components, ISO 15407-1

Technical data

FESTO

Dimensions – Manifold assembly, width 26 mm

Download CAD Data → www.festo.com/us/cad

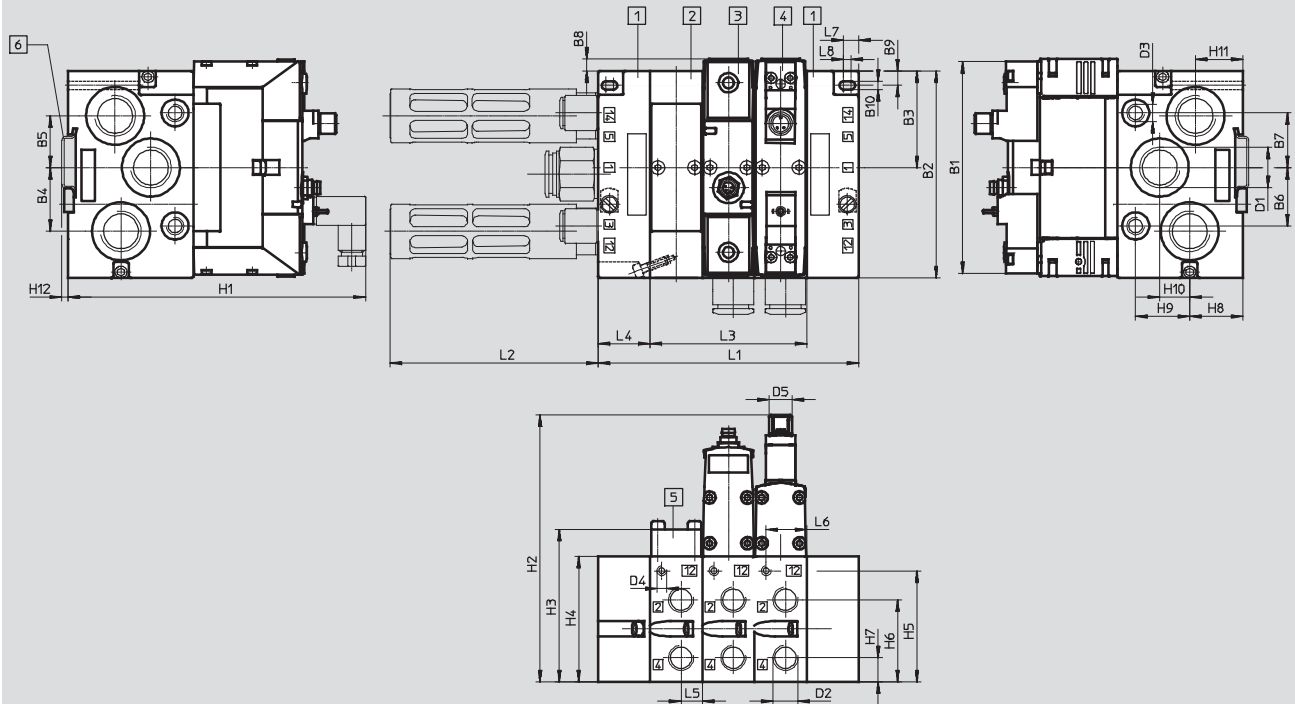

- | | | | |
|--|---|---------------------------------------|---|
| 1 End plate kit
type NEV-01-VDMA | 4 Solenoid valve with pilot
interface to ISO 15218 | 6 Mounting rail NRH-35-2000 | 8 Solenoid valve with pilot
interface to ISO 15218 |
| 2 Manifold sub-bases
type NAW-1/4-01-VDMA | 5 Blanking plate NDV-01-VDMA | 7 Solenoid valve with central
plug | |
| 3 Solenoid valve with central
plug | | | |

	B1	B2	B3	B4	B5	B6	B7	B8	B9	B10	D1	D2	D3	D4	D5	H1	H2
VSVA-B-...A1	113.1	107	50	33	26.8	30.3	28.3	13.1	7.5	4.2	G½	G¼	G⅛	M5	-	154.2	65
VSVA-B-M52-...A1	126.2	107	50	33	26.8	30.3	28.3	13.1	7.5	4.2	G½	G¼	G⅛	M5	-	154.2	65
VSVA-B-...A1-R2L	112.5	107	50	33	26.8	30.3	28.3	6.3	7.5	4.2	G½	G¼	G⅛	M5	M8x 1	157	128.3
VSVA-B-...A1-R5L	112.5	107	50	33	26.8	30.3	28.3	6.3	7.5	4.2	G½	G¼	G⅛	M5	M12x 1	157	131.6

	H3	H4	H5	H6	H7	H8	H9	H10	H11	H12	L1	L2	L3	L4	L5	L6	L7	L8
VSVA-B-...A1	79	65	57.5	42.5	12.5	27.5	28	15.5	24.5	3.5	54 + nx 27	107.5	nx 27	27	11	21	8	4
VSVA-B-M52-...A1	79	65	57.5	42.5	12.5	27.5	28	15.5	24.5	3.5	54 + nx 27	107.5	nx 27	27	11	21	8	4
VSVA-B-...A1-R2L	79	65	57.5	42.5	12.5	27.5	28	15.5	24.5	3.5	54 + nx 27	107.5	nx 27	27	11	21	8	4
VSVA-B-...A1-R5L	79	65	57.5	42.5	12.5	27.5	28	15.5	24.5	3.5	54 + nx 27	107.5	nx 27	27	11	21	8	4

Manifold components, ISO 15407-1

Technical data

Dimensions - Pressure regulator

Download CAD Data → www.festo.com/us/cad

Width 18 mm with manifold sub-base and solenoid valve with central plug

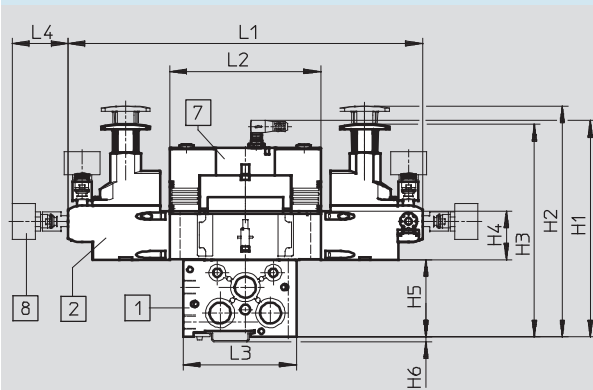

- 1 Manifold sub-base NAW
- 2 Regulator plate
- 7 Solenoid valve VSVA
- 8 Pressure gauge, freely positionable

Width 18 mm with manifold sub-base and solenoid valve with pilot interface to ISO 15218

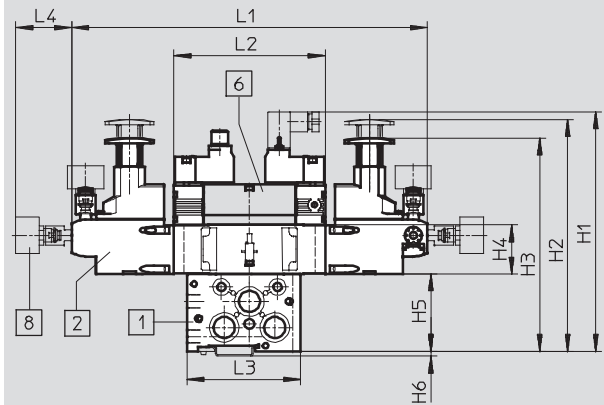

- 1 Manifold sub-base NAW
- 2 Regulator plate
- 6 Solenoid valve VSVA
- 8 Pressure gauge, freely positionable

Width 26 mm with manifold sub-base and solenoid valve with central plug

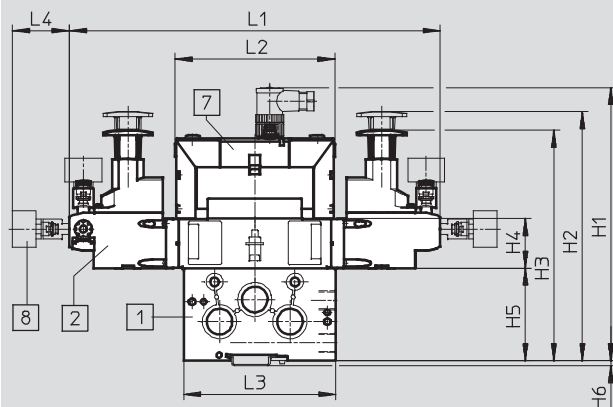

- 1 Manifold sub-base NAW
- 2 Regulator plate
- 7 Solenoid valve VSVA
- 8 Pressure gauge, freely positionable

Width 26 mm with manifold sub-base and solenoid valve with pilot interface to ISO 15218

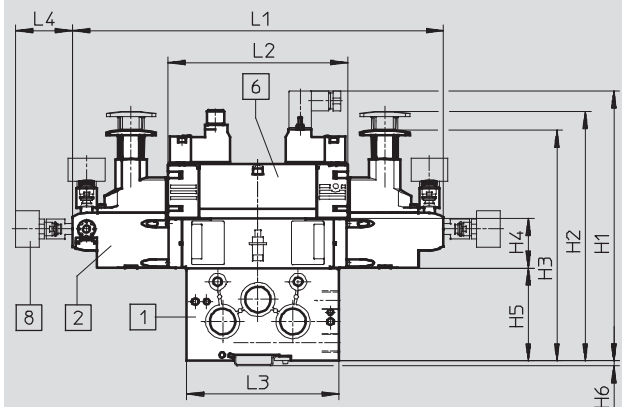

- 1 Manifold sub-base NAW
- 2 Regulator plate
- 6 Solenoid valve VSVA
- 8 Pressure gauge, freely positionable

Width [mm]	Solenoid valve	H1	H2	H3	H4	H5	H6	L1	L2	L3	L4
18	With central plug	156.8	165	152	35	55	3.5	253.4	107.8	81	39.8
	With pilot interface to ISO 15218	170.6									
26	With central plug	192	175	162	35	65	3.5	260.7	112.5	107	39.8
	With pilot interface to ISO 15218	189.6							126.2		

Manifold components, ISO 15407-1

Technical data

FESTO

Dimensions – Flow control plate

Download CAD Data → www.festo.com/us/cad

Width 18 mm with manifold sub-base and solenoid valve with central plug

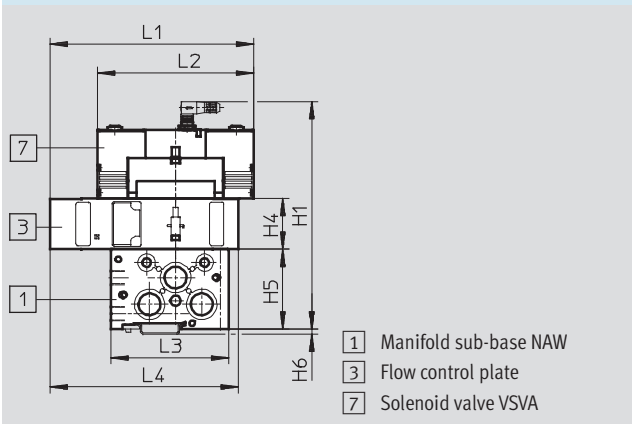

Width 18 mm with manifold sub-base and solenoid valve with pilot interface to ISO 15218

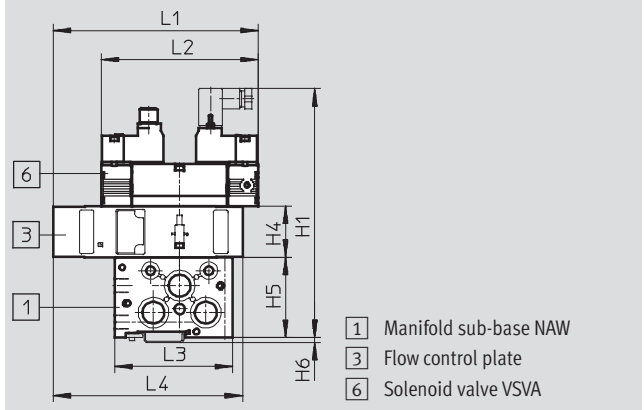

Width 26 mm with manifold sub-base and solenoid valve with central plug

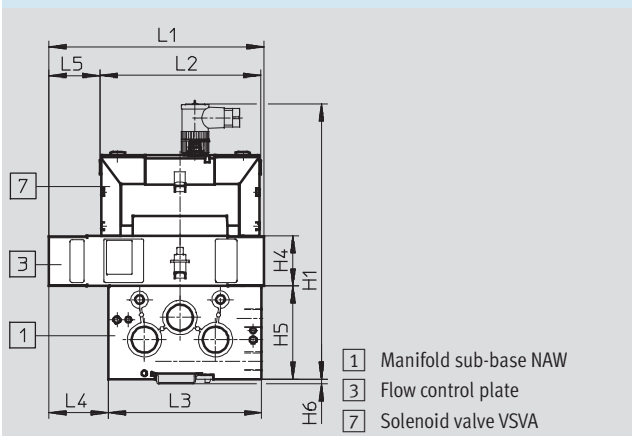

Width 26 mm with manifold sub-base and solenoid valve with pilot interface to ISO 15218

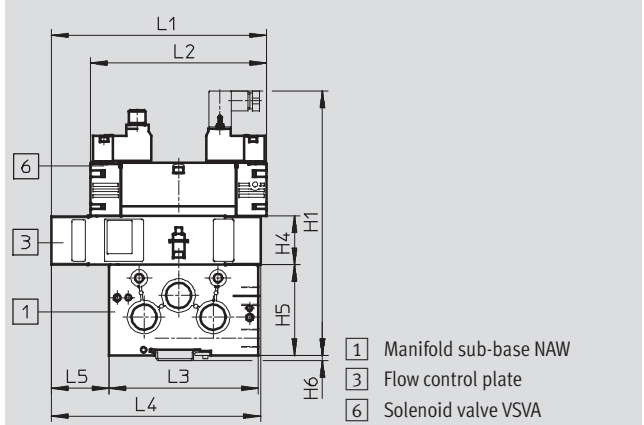

Width [mm]	Solenoid valve	H1	H4	H5	H6	L1	L2	L3	L4	L5
18	With central plug	156.8	35	55	3.5	140.8	107.8	81	130	-
	With pilot interface to ISO 15218	170.6								
26	With central plug	192	35	65	3.5	150	112.5	107	41.3	35
	With pilot interface to ISO 15218	189.6							150	41.3

Manifold components, ISO 15407-1

Technical data

Dimensions – Vertical supply plate

Download CAD Data → www.festo.com/us/cad

Width 18 mm with manifold sub-base and solenoid valve with central plug

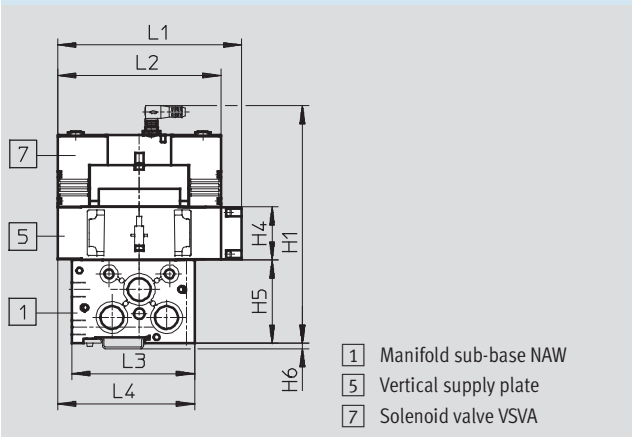

Width 18 mm with manifold sub-base and solenoid valve with pilot interface to ISO 15218

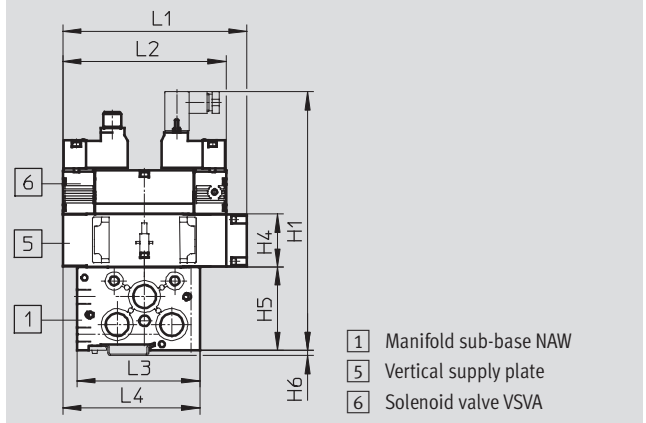

Width 26 mm with manifold sub-base and solenoid valve with central plug

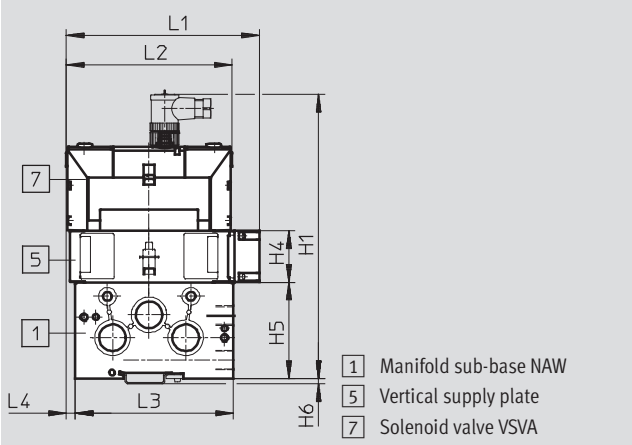

Width 26 mm with manifold sub-base and solenoid valve with pilot interface to ISO 15218

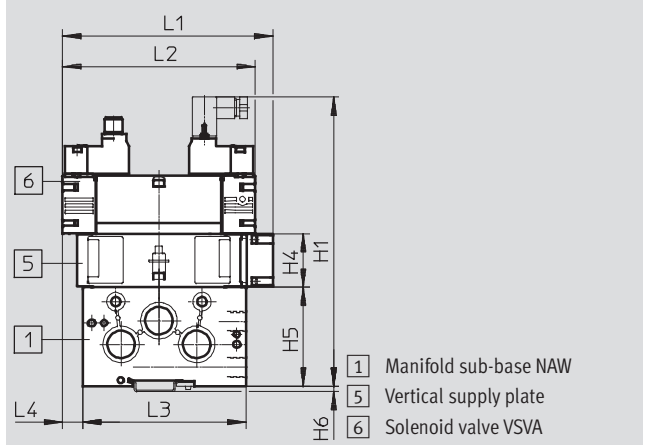

Width [mm]	Solenoid valve	H1	H4	H5	H6	L1	L2	L3	L4
18	With central plug	156.8	35	55	3.5	121.55	107.8	81	90.4
	With pilot interface to ISO 15218	170.6							
26	With central plug	192	35	65	3.5	130.8	112.5	107	6.3
	With pilot interface to ISO 15218	189.6							

Manifold components, ISO 15407-1

Technical data

Dimensions – Vertical pressure shut-off plate

Download CAD Data → www.festo.com/us/cad

Width 18 mm with manifold sub-base and solenoid valve with central plug

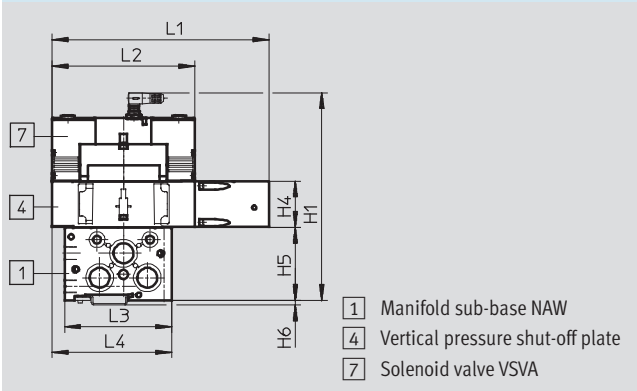

Width 18 mm with manifold sub-base and solenoid valve with pilot interface to ISO 15218

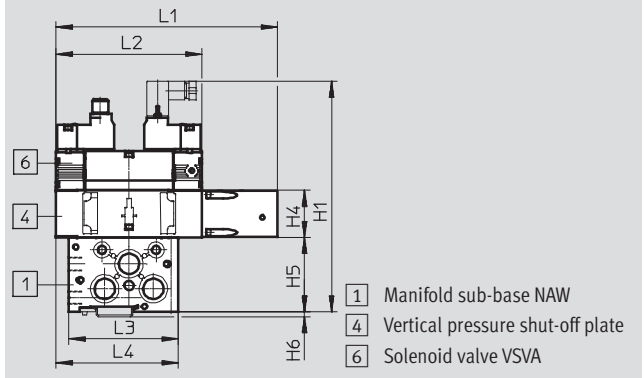

Width 26 mm with manifold sub-base and solenoid valve with central plug

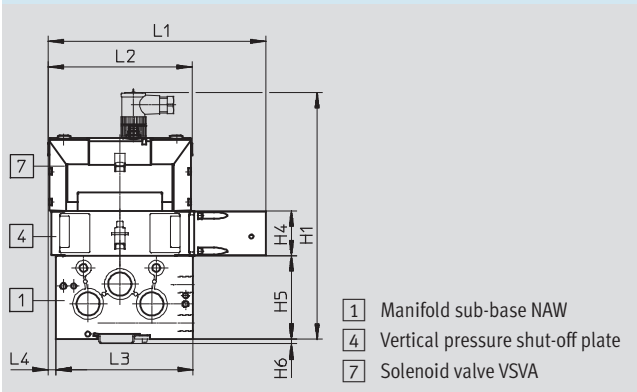

Width 26 mm with manifold sub-base and solenoid valve with pilot interface to ISO 15218

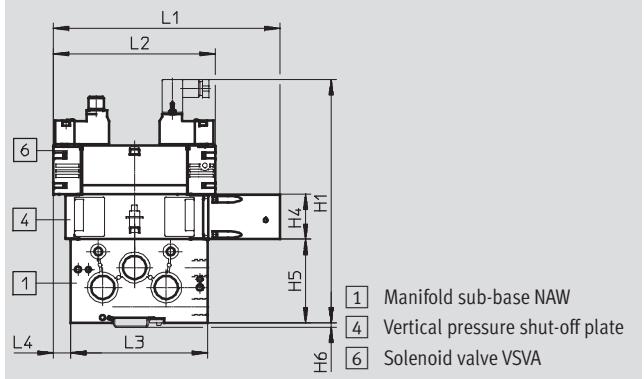

Width [mm]	Solenoid valve	H1	H4	H5	H6	L1	L2	L3	L4
18	With central plug	156.8	35	55	3.5	163.8	107.8	81	90.4
	With pilot interface to ISO 15218	170.6							
26	With central plug	192	35	65	3.5	169.7	112.5	107	6.3
	With pilot interface to ISO 15218	189.6							

Solenoid/pneumatic valves, ISO 15407-1

Accessories

Isolating disc NSC

Material:
Aluminium



Operating and environmental conditions	
Operating medium	Compressed air according to ISO 8573-1:2010 [7:4:4]
Note about the operating/pilot medium	Lubricated operation possible (required during subsequent operation)

Ordering data				
Description	Width [mm]	Weight [g]	Part No.	Type
Isolating disc for ports 1, 3, 5 (solenoid/pneumatic valves)	18	2	161113	NSC-3/8-02-VDMA
	26	2	161105	NSC-1/2-01-VDMA
Isolating disc for ports 12, 14 (pneumatic valves)	18	2	161106	NSC-1/8-01-VDMA
	26	2	161106	NSC-1/8-01-VDMA

Blanking plate NDV

Material:
Polymer
Free of copper and PTFE

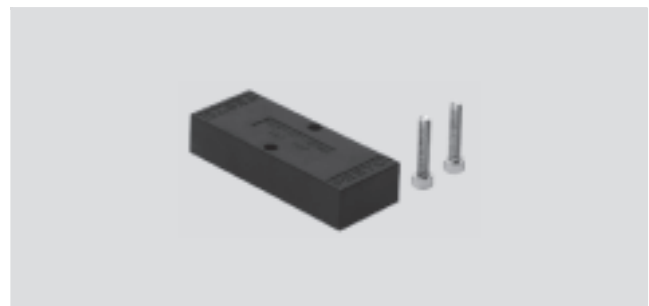

Operating and environmental conditions	
Operating medium	Compressed air according to ISO 8573-1:2010 [7:4:4]
Note about the operating/pilot medium	Lubricated operation possible (required during subsequent operation)

Ordering data				
Description	Width [mm]	Weight [g]	Part No.	Type
Blanking plate to seal spare or vacant valve positions	18	22	161114	NDV-02-VDMA
	26	36	161107	NDV-01-VDMA

Solenoid/pneumatic valves, ISO 15407-1

Accessories



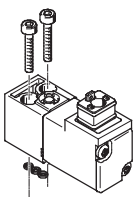
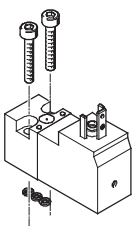
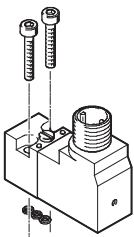
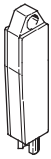



FESTO

Ordering data – Pilot valve to ISO 15218							
		Output		Voltage		Part No.	Type
		[W]	[VA]	[V DC]	[V AC]		
Plug, square design, type C EN 175301-803							
	Manual override, non-detenting and detenting via tool	1.5	–	24	–	546262	VSCS-B-M32-MT-WA-1C1
		1.4	3/2.4	12	24	546261	VSCS-B-M32-MT-WA-5WC1
		–	3/2.4	–	110	546263	VSCS-B-M32-MT-WA-2AC1
		–	3/2.4	–	230	546264	VSCS-B-M32-MT-WA-3AC1
Plug, square design, type C EN 175301-803							
	Manual override, non-detenting	1.8	–	12	–	546257	VSCS-B-M32-MH-WA-5C1
		–	–	24	–	546256	VSCS-B-M32-MH-WA-1C1
		–	3.1/2.3	–	24	546258	VSCS-B-M32-MH-WA-1AC1
		–	2.9/2.1	–	110	546259	VSCS-B-M32-MH-WA-2AC1
	Manual override, detenting/non-detenting	–	2.9/2.1	–	230	546260	VSCS-B-M32-MH-WA-3AC1
		1.8	–	12	–	571062	VSCS-B-M32-MD-WA-5C1
		–	–	24	–	571061	VSCS-B-M32-MD-WA-1C1
		–	3.1/2.3	–	24	571063	VSCS-B-M32-MD-WA-1AC1
–	2.9/2.1	–	230	571065	VSCS-B-M32-MD-WA-3AC1		
–	2.9/2.1	–	110	571064	VSCS-B-M32-MD-WA-2AC1		
M12 plug IEC 61076-2-101							
	Manual override, detenting/non-detenting	1.8	–	24	–	573215	VSCS-B-M32-MD-WA-1R3
	Manual override, detenting	1.8	–	24	–	573214	VSCS-B-M32-MH-WA-1R3
Tool for manual override							
	For manual override, detenting, with pilot valve VSCS-B-M32-MT					157601	AHB-MEB

Solenoid/pneumatic valves, ISO 15407-1

Accessories

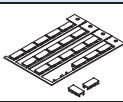











FESTO

Ordering data					
				Part No.	Type
Pressure gauge Technical data → Internet: pagn					
	With cartridge connection for regulator	0 ... 16 bar		543487	PAGN-26-16-P10
		0 ... 10 bar		543488	PAGN-26-10-P10
Cartridge for regulator plate					
	For tubing O.D.	4 mm	10 pieces	172972	QSP10-4
Push-in fitting Technical data → Internet: qs					
	Connecting thread M5 for tubing O.D.	4 mm	10 pieces	153315	QSM-M5-4-I
		6 mm	10 pieces	153317	QSM-M5-6-I
	Connecting thread G $\frac{1}{8}$ for tubing O.D.	6 mm	10 pieces	186096	QS-G$\frac{1}{8}$-6
		8 mm	10 pieces	186098	QS-G$\frac{1}{8}$-8
	Connecting thread G $\frac{1}{4}$ for tubing O.D.	8 mm	10 pieces	186099	QS-G$\frac{1}{4}$-8
		10 mm	10 pieces	186101	QS-G$\frac{1}{4}$-10
	Connecting thread G $\frac{3}{8}$ for tubing O.D.	12 mm	10 pieces	186103	QS-G$\frac{3}{8}$-12
		16 mm	1 piece	186347	QS-G$\frac{3}{8}$-16
Connecting thread G $\frac{1}{2}$ for tubing O.D.	12 mm	1 piece	186104	QS-G$\frac{1}{2}$-12	
	16 mm	1 piece	186105	QS-G$\frac{1}{2}$-16	
Blanking plug Technical data → Internet: b					
	For sealing unused ports	For thread M5	10 pieces	3843	B-M5
		For thread G $\frac{1}{8}$	10 pieces	3568	B-$\frac{1}{8}$
		For thread G $\frac{1}{4}$	10 pieces	3569	B-$\frac{1}{4}$
		For thread G $\frac{3}{8}$	10 pieces	3570	B-$\frac{3}{8}$
		For thread G $\frac{1}{2}$	10 pieces	3571	B-$\frac{1}{2}$
Silencer Technical data → Internet: u					
	For noise reduction at venting ports	For thread G $\frac{1}{8}$		6841	U-$\frac{1}{8}$-B
		For thread G $\frac{1}{4}$		6842	U-$\frac{1}{4}$-B
		For thread G $\frac{3}{8}$		6843	U-$\frac{3}{8}$-B
		For thread G $\frac{1}{2}$		6844	U-$\frac{1}{2}$-B
Inscription label Technical data → Internet: ibs					
	Inscription label, 9x20 mm, for valves	In frames	24 units	18182	IBS-9x20
Inscription label holder Technical data → Internet: ascf					
	Clip-on inscription label holder for valve cap, for pneumatic valves VSPA		5 pieces	540888	ASCF-T-S6

Solenoid/pneumatic valves, ISO 15407-1

Accessories

FESTO

Ordering data				Part No.	Type	
Plug sockets for plug pattern EN 175301-803, type C				Technical data → Internet: mssd		
	Via screw terminals	Cable connector Pg7	151687	MSSD-EB		
		Cable connector M12	539712	MSSD-EB-M12		
	With insulation displacement connection	Cable connector M14	192745	MSSD-EB-S-M14		
Connecting cable for plug pattern EN 175301-803, type C				Technical data → Internet: kmeb		
	With LED switching status display	24 V DC	2.5 m	151688	KMEB-1-24-2,5-LED	
		24 V DC	5 m	151689	KMEB-1-24-5-LED	
		24 V DC	10 m	193457	KMEB-1-24-10-LED	
	Without switching status display	Up to 240 V	2.5 m	151690	KMEB-1-230AC-2,5	
		Up to 240 V	5 m	151691	KMEB-1-230AC-5	
		Up to 240 V	10 m	193458	KMEB-1-230AC-10	
	With LED switching status display	24 V DC	2.5 m	174844	KMEB-2-24-2,5-LED	
		24 V DC	5 m	174845	KMEB-2-24-5-LED	
	Without switching status display	Up to 240 V	2.5 m	174846	KMEB-2-230-2,5	
		Up to 240 V	5 m	174847	KMEB-2-230-5	
	Illuminating seal for plug pattern EN 175301-803, type C				Technical data → Internet: meb-ld	
		To display the switching status	12 ... 24 V DC	–	151717	MEB-LD-12-24DC
230 V AC			–	151718	MEB-LD-230AC	
Plug sockets for valves, round plug M12x1				Technical data → Internet: sea		
	Angled socket, 4-pin, type A, screw terminal	Cable connector Pg7	185498	SEA-M12-4WD-PG7		
Connecting cable for valves with round plug M8x1				Technical data → Internet: nebu		
	Straight socket, 4-pin Open cable end, 4-pin	2.5 m	541342	NEBU-M8G4-K-2,5-LE4		
		5 m	541343	NEBU-M8G4-K-5-LE4		
	Angled socket, 4-pin Open cable end, 4-pin	2.5 m	541344	NEBU-M8W4-K-2,5-LE4		
		5 m	541345	NEBU-M8W4-K-5-LE4		
Connecting cable for valves with round plug M12x1				Technical data → Internet: nebu		
	Straight plug, 4-pin Angled socket, 4-pin	1 m	185499	KM-12-M12-GSWD-1-4		
		2.5 m	550326	NEBU-M12G5-K-2,5-LE4		
	Straight socket, 5-pin Open cable end, 4-wire	5 m	541328	NEBU-M12G5-K-5-LE4		
		2.5 m	550325	NEBU-M12W5-K-2,5-LE4		
	Angled socket, 5-pin Open cable end, 4-wire	5 m	541329	NEBU-M12W5-K-5-LE4		
		2.5 m	550327	NEBU-M12G5-K-2,5-LE4		
H-rail mounting						
	For end plate width 18 mm	2 pieces	553996	VAME-S3-2-H		
	For end plate width 26 mm	2 pieces	553995	VAME-S3-1-H		

Product Range and Company Overview

A Complete Suite of Automation Services

Our experienced engineers provide complete support at every stage of your development process, including: conceptualization, analysis, engineering, design, assembly, documentation, validation, and production.



Custom Automation Components
Complete custom engineered solutions



Custom Control Cabinets
Comprehensive engineering support and on-site services



Complete Systems
Shipment, stocking and storage services

The Broadest Range of Automation Components

With a comprehensive line of more than 30,000 automation components, Festo is capable of solving the most complex automation requirements.



Electromechanical
Electromechanical actuators, motors, controllers & drives



Pneumatics
Pneumatic linear and rotary actuators, valves, and air supply



PLCs and I/O Devices
PLC's, operator interfaces, sensors and I/O devices

Supporting Advanced Automation... As No One Else Can!

Festo is a leading global manufacturer of pneumatic and electromechanical systems, components and controls for industrial automation, with more than 12,000 employees in 56 national headquarters serving more than 180 countries. For more than 80 years, Festo has continuously elevated the state of manufacturing with innovations and optimized motion control solutions that deliver higher performing, more profitable automated manufacturing and processing equipment. Our dedication to the advancement of automation extends beyond technology to the education and development of current and future automation and robotics designers with simulation tools, teaching programs, and on-site services.

Quality Assurance, ISO 9001 and ISO 14001 Certifications

Festo Corporation is committed to supply all Festo products and services that will meet or exceed our customers' requirements in product quality, delivery, customer service and satisfaction.

To meet this commitment, we strive to ensure a consistent, integrated, and systematic approach to management that will meet or exceed the requirements of the ISO 9001 standard for Quality Management and the ISO 14001 standard for Environmental Management.



© Copyright 2008, Festo Corporation. While every effort is made to ensure that all dimensions and specifications are correct, Festo cannot guarantee that publications are completely free of any error, in particular typing or printing errors. Accordingly, Festo cannot be held responsible for the same. For Liability and Warranty conditions, refer to our "Terms and Conditions of Sale", available from your local Festo office. All rights reserved. No part of this publication may be reproduced, distributed, or transmitted in any form or by any means, electronic, mechanical, photocopying or otherwise, without the prior written permission of Festo. All technical data subject to change according to technical update.



Printed on recycled paper at New Horizon Graphic, Inc., FSC certified as an environmentally friendly printing plant.

Festo North America

Festo Regional Contact Center

5300 Explorer Drive
Mississauga, Ontario L4W 5G4
Canada

USA Customers:

For ordering assistance,

Call: 1.800.99.FESTO (1.800.993.3786)

Fax: 1.800.96.FESTO (1.800.963.3786)

Email: customer.service@us.festo.com

For technical support,

Call: 1.866.GO.FESTO (1.866.463.3786)

Fax: 1.800.96.FESTO (1.800.963.3786)

Email: product.support@us.festo.com

Canadian Customers:

Call: 1.877.GO.FESTO (1.877.463.3786)

Fax: 1.877.FX.FESTO (1.877.393.3786)

Email: festo.canada@ca.festo.com

USA Headquarters

Festo Corporation
395 Moreland Road
P.O. Box 18023
Hauppauge, NY 11788, USA
www.festo.com/us

USA Sales Offices

Appleton

North 922 Tower View Drive, Suite N
Greenville, WI 54942, USA

Boston

120 Presidential Way, Suite 330
Woburn, MA 01801, USA

Chicago

1441 East Business Center Drive
Mt. Prospect, IL 60056, USA

Dallas

1825 Lakeway Drive, Suite 600
Lewisville, TX 75057, USA

Detroit – Automotive Engineering Center

2601 Cambridge Court, Suite 320
Auburn Hills, MI 48326, USA

New York

395 Moreland Road
Hauppauge, NY 11788, USA

Silicon Valley

4935 Southfront Road, Suite F
Livermore, CA 94550, USA

United States



USA Headquarters, East: Festo Corp., 395 Moreland Road, Hauppauge, NY 11788

Phone: 1.631.435.0800; Fax: 1.631.435.8026;

Email: info@festo-usa.com

www.festo.com/us

Canada



Headquarters: Festo Inc., 5300 Explorer Drive, Mississauga, Ontario L4W 5G4

Phone: 1.905.624.9000; Fax: 1.905.624.9001;

Email: festo.canada@ca.festo.com

www.festo.ca

Mexico



Headquarters: Festo Pneumatic, S.A., Av. Ceylán 3, Col. Tequesquahuac,
54020 Tlalneantla, Edo. de México

Phone: 011 52 [55] 53 21 66 00; Fax: 011 52 [55] 53 21 66 65;

Email: festo.mexico@mx.festo.com

www.festo.com/mx

Central USA

Festo Corporation
1441 East Business
Center Drive
Mt. Prospect, IL 60056, USA
Phone: 1.847.759.2600
Fax: 1.847.768.9480



Western USA

Festo Corporation
4935 Southfront Road,
Suite F
Livermore, CA 94550, USA
Phone: 1.925.371.1099
Fax: 1.925.245.1286



Festo Worldwide

Argentina Australia Austria Belarus Belgium Brazil Bulgaria Canada Chile China Colombia Croatia Czech Republic Denmark
Estonia Finland France Germany Great Britain Greece Hong Kong Hungary India Indonesia Iran Ireland Israel Italy Japan Latvia
Lithuania Malaysia Mexico Netherlands New Zealand Norway Peru Philippines Poland Romania Russia Serbia Singapore
Slovakia Slovenia South Africa South Korea Spain Sweden Switzerland Taiwan Thailand Turkey Ukraine United States Venezuela

www.festo.com