

Pneumatic valves VUWG



Pneumatic valves VUWG

Key features

FESTO

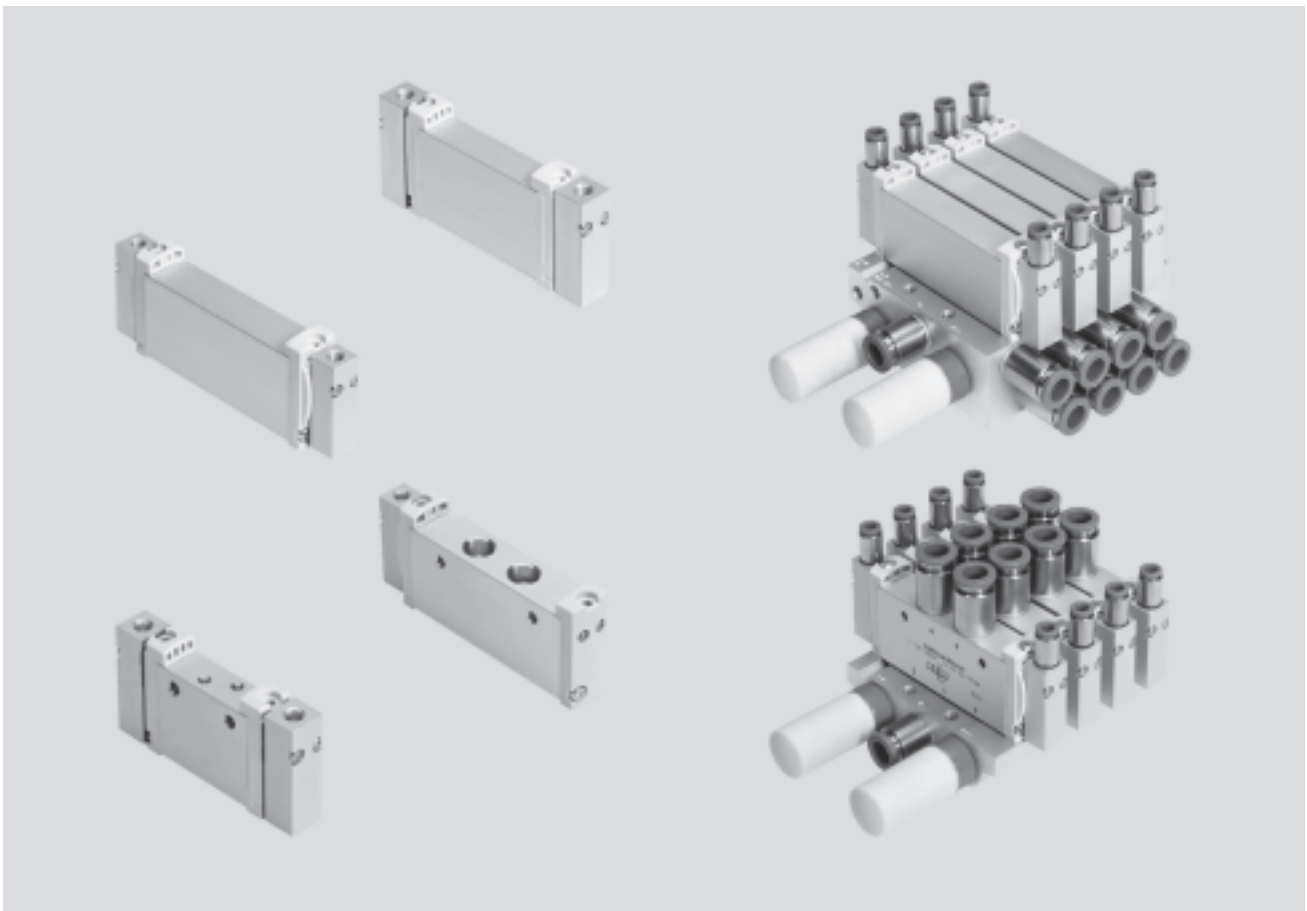

Innovative

- Various connection sizes (M3, M5, M7, G $\frac{1}{8}$, G $\frac{1}{4}$)
- Maximum pressure 10 bar
- 2x3/2-way valve in one valve housing

Versatile

- Wide range of valve functions
- In-line valves can be used as individual valves or manifold valves
- M5/M7 in-line valves can be mixed on one manifold rail
- Identical sub-base valves for M5 or M7 manifold rail
- Manifolds with pressure zones
- Choice of quick plug connectors

Reliable

- Sturdy and durable metal components
 - Valves
 - Manifold rails
- Convenient servicing thanks to valves that can be replaced quickly and easily

Easy to mount

- Secure mounting on wall or H-rail
- Easy mounting thanks to captive screws and seals

Pneumatic valves VUWG

Key features – Pneumatic components

Individual valves and valve manifolds

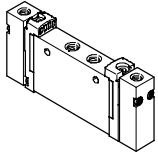

VUWG-L in-line valve as individual valve

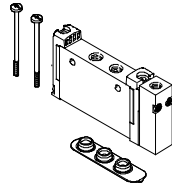

VUWG-S in-line valve for manifold assembly

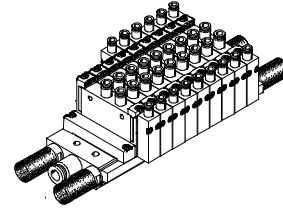

VUWG-S valve manifold consisting of in-line valves

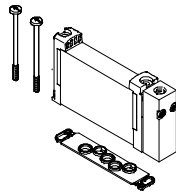

VUWG-B sub-base valve for manifold assembly

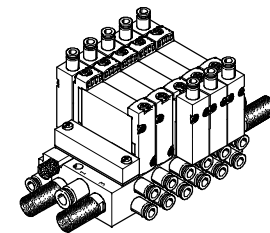

VUWG-B valve manifold consisting of sub-base valves

VUWG basic valves

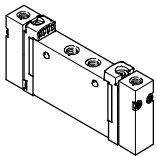

- Width 10, 14 and 18 mm
- 2x3/2-way, 5/2-way and 5/3-way valves
- In-line valves
- Sub-base valves

Pneumatic valves VUWG

Key features – Pneumatic components

Manifold rail for in-line valves

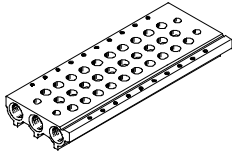

- For in-line valves M3, M5, M7, G¹/₈ and G¹/₄, width 10/14/18
- For 2x3/2-way, 5/2-way and 5/3-way valves
- 2 to 10 and 12, 14, 16 valve positions

Manifold rail for sub-base valves

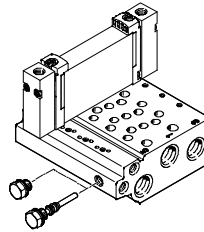

- For sub-base valves 10A, 10, 14 and 18, width 10/14/18
- Manifold rail with M3, M5/M7, G¹/₈ and G¹/₄ working ports
- For 2x3/2-way, 5/2-way and 5/3-way valves
- 2 to 10, 12, 14 and 16 valve positions
- The sub-base valves always have external pilot air. The pilot air is set via the manifold rail. A short (for internal pilot air) and long (for external pilot air) blanking plug are included with the manifold rail for this purpose.

 Note

Duct 84 must not be sealed by a blanking plug when connecting a sub-base valve.

Blanking plate for vacant position



- For covering unused valve positions

Supply plate



- For additional air supply and exhaust via a valve position

Separator for pressure zones



- For creating multiple pressure zones in a valve manifold

Pilot pressure p₂ as a function of operating pressure p₁

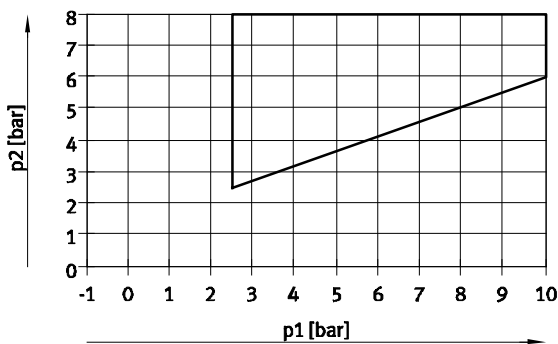

This graph applies to the 2x3/2-way valves and 5/2-way single pilot valves with air spring:

- T32CA, T32UA, T32HA
- M52a, M52r

 Note

The compressed air for the air springs is supplied from port 1 (operating pressure). To ensure reliable valve switching, the minimum pressure as per the graph must always be adhered to for the pilot pressure.

Pneumatic valves VUWG

Key features – Pneumatic components

Creating pressure zones and separating exhaust air

Compressed air is supplied and exhausted via the manifold rail and the supply plates.

The position of the supply plates and duct separations can be freely selected with the VUWG.



Pressure zones are created by isolating the internal supply ducts between the manifold sub-bases by means of appropriate duct separation.

Pressure zone separation can be used for the following ducts:

- Duct 1
- Duct 3
- Duct 5

 - Note

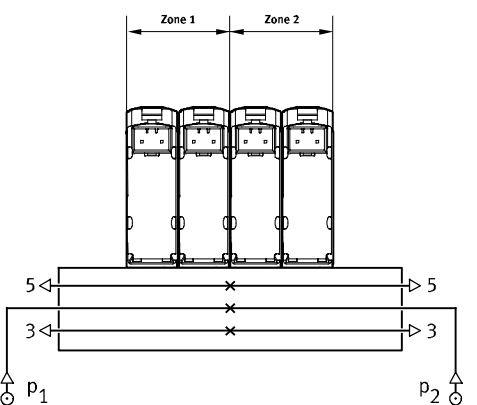
- Use separators if the exhaust air pressures are high
- Use at least one supply plate/supply for each pressure zone

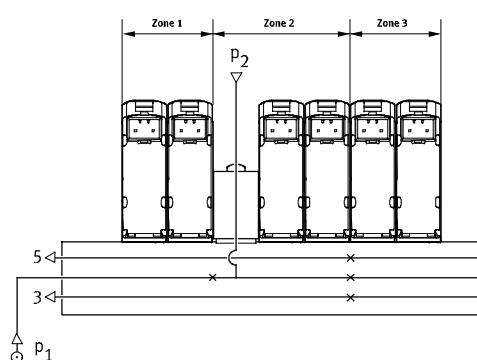
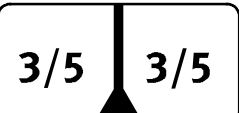
Duct separation	Description	Symbol
	<p>The pressure zones can be freely configured with the VUWG. The following duct separations are possible:</p> <ul style="list-style-type: none"> • Duct 1 closed 	
	<p>The number of pressure zones with the VUWG is only limited by the number of valve positions on the manifold rail. Note that each supply plate occupies one valve position.</p>	<ul style="list-style-type: none"> • Duct 1/3/5 closed • Duct 3/5 closed 

Separator VABD

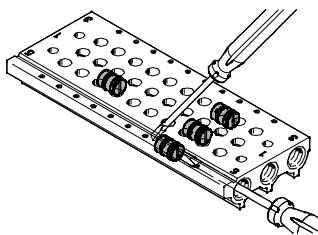

 - Note

As the separators are mounted from only one side using a slotted screwdriver, several pressure zones can be created in one profile.

Pneumatic valves VUWG

Key features – Pneumatic components

Operation with different pressures

Vacuum operation

Note the following with vacuum operation:

- M52 in-line valves with pneumatic spring and pneumatic/mechanical spring reset (vacuum only at 3/5)
- T32 valves with pneumatic spring reset (vacuum only at 3/5)

If external pilot air via duct 14 is used, M52 sub-base valves (B) can be used without restriction.

The remaining valve types can be used without restriction for vacuum.

Reverse operation

The valves with pneumatic spring are not suitable for reverse operation, since at least the minimum pilot pressure must be present in duct 1.



Note

Pressure must be present at port 1.

Pressure deflector (internal pilot air)

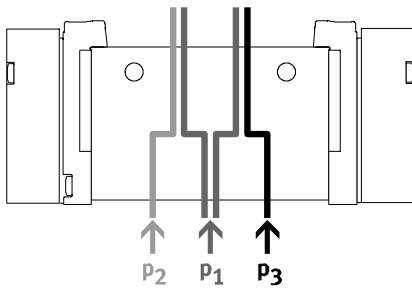

- If two different pressures are required.

- Different pressures can be supplied at duct 1, 3 and 5.

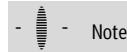

Note

- With internal pilot air, the minimum pilot pressure must be adhered to in duct 1

- With 2x3/2-way valves without spring return, the minimum pilot pressure must always be adhered to in duct 1

Advantages

Any pressure or vacuum can be connected at ducts 3 and 5 both with external and internal pilot air.

Vacuum, ejector pulse and normal position

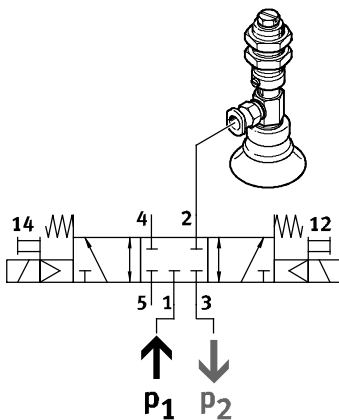

Vacuum, ejector pulse and normal position with internal pilot air can be achieved by connecting vacuum

at duct 3 and pressure for the ejector pulse at duct 1.

Pneumatic valves VUWG

Product range overview

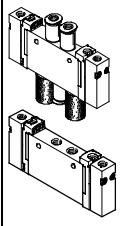
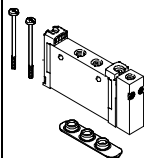
Design	Working port	Type code	Functions and flow rate [l/min]												→ Page/ Internet
			T32C	T32U	T32H	T32C/M	T32U/M	T32H/M	M52	M52/M	B52	P53C	P53U	P53E	
In-line valve as individual valve, VUWG-L															
	M3	10A	-	-	-	-	-	-	100	80	100	90	90	90	12
	M5	10	■	■	■	■	■	■	■	■	■	■	■	■	17
	M7	10	150	150	150	135	125	125	220	190	220	210	210	210	17
	G1/8	14	■	■	■	■	■	■	■	■	■	■	■	■	24
	G1/4	18	650	600	650	550	500	500	780	780	780	650	600	600	29
			1,000	1,000	1,000	1,000	1,000	1,000	1,300	1,300	1,300	1,200	1,200	1,200	
In-line valve for manifold assembly, VUWG-S															
	M3	10A	-	-	-	-	-	-	100	80	100	90	90	90	15
	M5	10	■	■	■	■	■	■	■	■	■	■	■	■	22
	M7	10	150	150	150	135	125	125	220	190	220	210	210	210	22
	G1/8	14	■	■	■	■	■	■	■	■	■	■	■	■	47
	G1/4	18	620	580	580	520	480	480	730	730	730	620	580	580	32
			1,000	1,000	1,000	1,000	1,000	1,000	1,300	1,300	1,300	1,200	1,200	1,200	

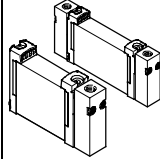
Design	Working port	Type code	Functions and flow rate [l/min]												→ Page/ Internet
			T32C	T32U	T32H	T32C/M	T32U/M	T32H/M	M52	M52/M	B52	P53C	P53U	P53E	
Sub-base valve, VUWG-B															
	-	100	-	-	-	-	-	-	100	80	100	90	90	90	34
	-	10	■	■	■	■	■	■	■	■	■	■	■	■	39
	-	10	150	150	150	130	120	120	210	180	210	200	200	200	39
	-	14	■	■	■	■	■	■	■	■	■	■	■	■	44
	-	18	160	160	160	140	130	130	270	230	270	250	250	250	49
			540	510	540	430	410	410	580	580	580	540	510	510	
			900	900	900	900	900	900	1,000	1,000	1,000	950	950	950	

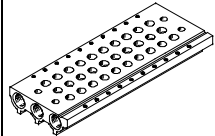
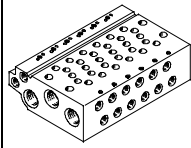
Design	Working port	Type code	Description	→ Page/ Internet
Manifold rail VABM- ... -S- ... , for in-line valves (manifold assembly)				
	-	-	Valve size M3, M5, M7, G1/8, G1/4	vabm
Manifold rail VABM, for sub-base valves				
	-	10AW	Connection size M3	vabm
	-	10W	Connection size M5	
	-	10HW	Connection size M7	
	-	14W	Connection size G1/8	
	-	18W	Connection size G1/4	

Pneumatic valves VUWG

Overview of valve functions

FESTO

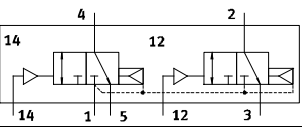
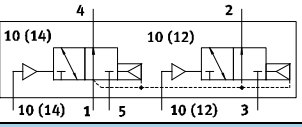
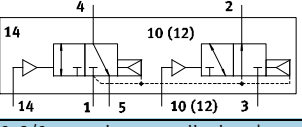
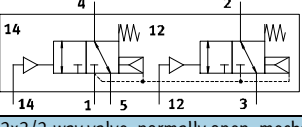
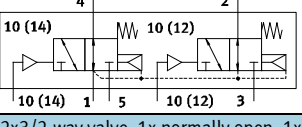
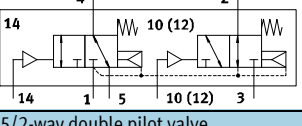
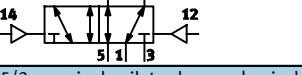
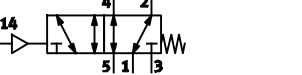
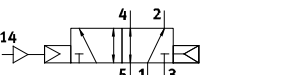
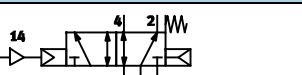
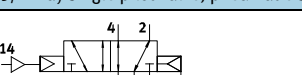
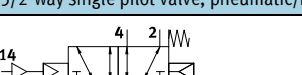
Valve	Valve code	Description	Valve terminal/ position function order code	Size			
				M3	M5/M7	G1/8	G1/4
2x3/2-way valve, normally closed, pneumatic spring							
	T32C-A	External pilot air supply	K	-	■	■	■
2x3/2-way valve, normally open, pneumatic spring							
	T32U-A	External pilot air supply	N	-	■	■	■
2x3/2-way valve, 1x normally open, 1x normally closed, pneumatic spring							
	T32H-A	External pilot air supply	H	-	■	■	■
2x3/2-way valve, normally closed, mechanical spring							
	T32C-M	External pilot air supply	VK	-	■	■	■
2x3/2-way valve, normally open, mechanical spring							
	T32U-M	External pilot air supply	VN	-	■	■	■
2x3/2-way valve, 1x normally open, 1x normally closed, mechanical spring							
	T32H-M	External pilot air supply	VH	-	■	■	■
5/2-way double pilot valve							
	B52	External pilot air supply	J	■	■	■	■
5/2-way single pilot valve, mechanical spring							
	M52-M	External pilot air supply	A	■	■	■	■
5/2-way single pilot valve, pneumatic spring							
	M52-A	In-line valve, external pilot air supply	M	-	-	■	-
5/2-way single pilot valve, pneumatic/mechanical spring							
	M52-R	In-line valve, external pilot air supply	P	■	■	-	■
5/2-way single pilot valve, pneumatic spring							
	M52-A	Sub-base valve, external pilot air supply	M	-	-	■	-
5/2-way single pilot valve, pneumatic/mechanical spring							
	M52-R	Sub-base valve, external pilot air supply	P	■	■	-	■

Pneumatic valves VUWG

Overview of valve functions

Valve	Valve type code	Description	Valve terminal/ position function order code	Size			
				M3	M5/M7	G1/8	G1/4
5/3-way valve, mid-position closed							
	P53C	External pilot air supply	G	■	■	■	■
5/3-way valve, mid-position pressurised							
	P53U	External pilot air supply	B	■	■	■	■
5/3-way valve, mid-position exhausted							
	P53E	External pilot air supply	E	■	■	■	■

Pneumatic valves VUWG

Sample system overview – VUWG-L10 and VUWG-S10, in-line valves M5/M7

FESTO

Manifold assembly

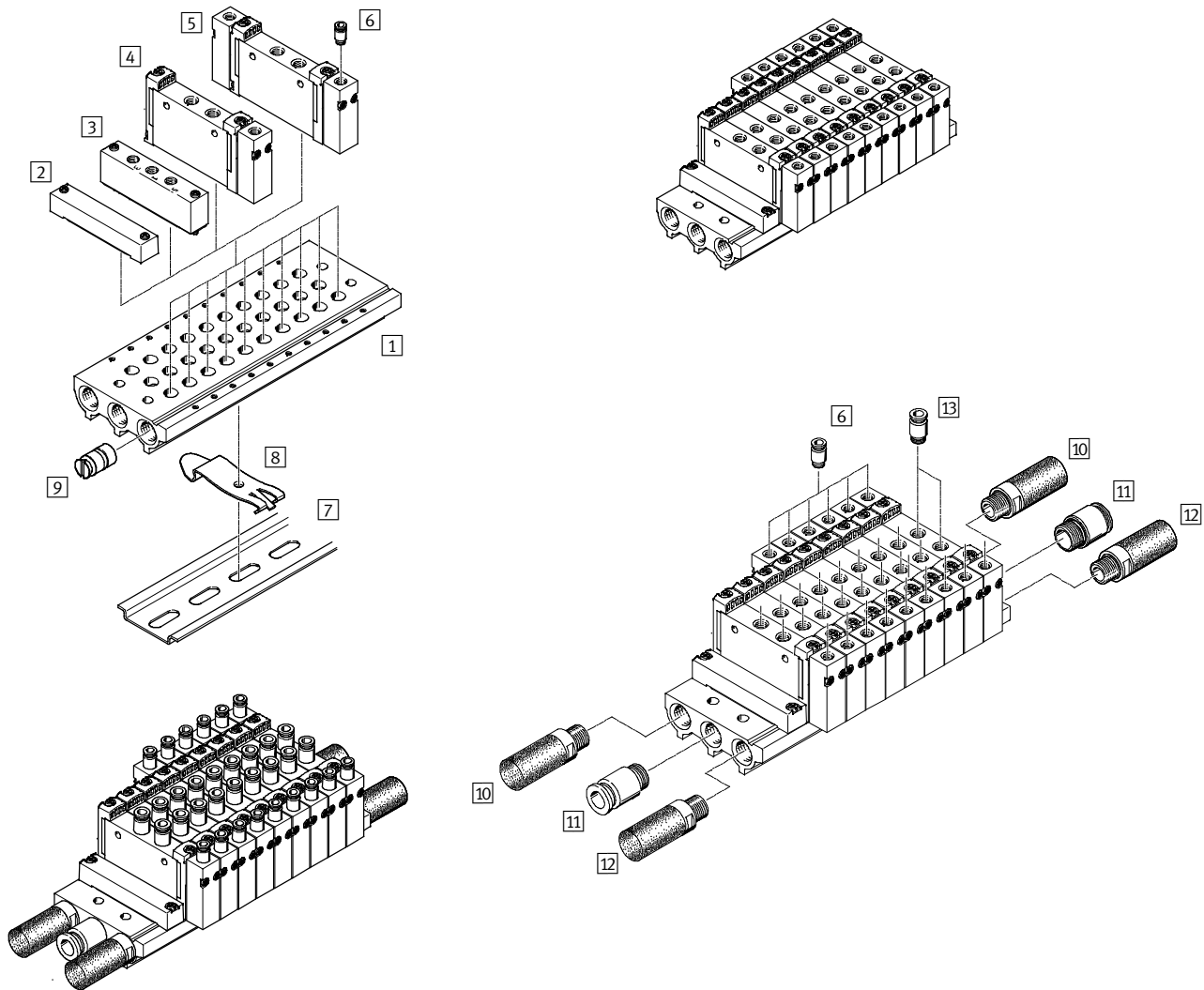

Manifold assembly and accessories

	Type	Brief description	→ Page/Internet
1	VABM-L1-10S-G18	For 2 to 10, 12, 14 and 16 valve positions	23
2	VABB-L1-10-S	For covering an unused valve position	23
3	VABF-L1-10-P3A4	For air supply port 1 and ports 3 and 5	23
4	VUWG	Single pilot pneumatic valve	17
5	VUWG	Double pilot pneumatic valve	17
6	QS	For adapter plate for port 12 or 14	54
7	NRH-35-2000	For mounting the valve manifold	54
8	VAME-T-M4	2 pieces for fitting the valve manifold on an H-rail	54
9	VABD-8-B	For creating pressure zones	54
10	U	For port 3	54
11	QS	For port 1	54
12	U	For port 5	54
13	QS	For ports 2 and 4	54

Pneumatic valves VUWG

Sample system overview – VUWG-B10, sub-base valves

Manifold assembly

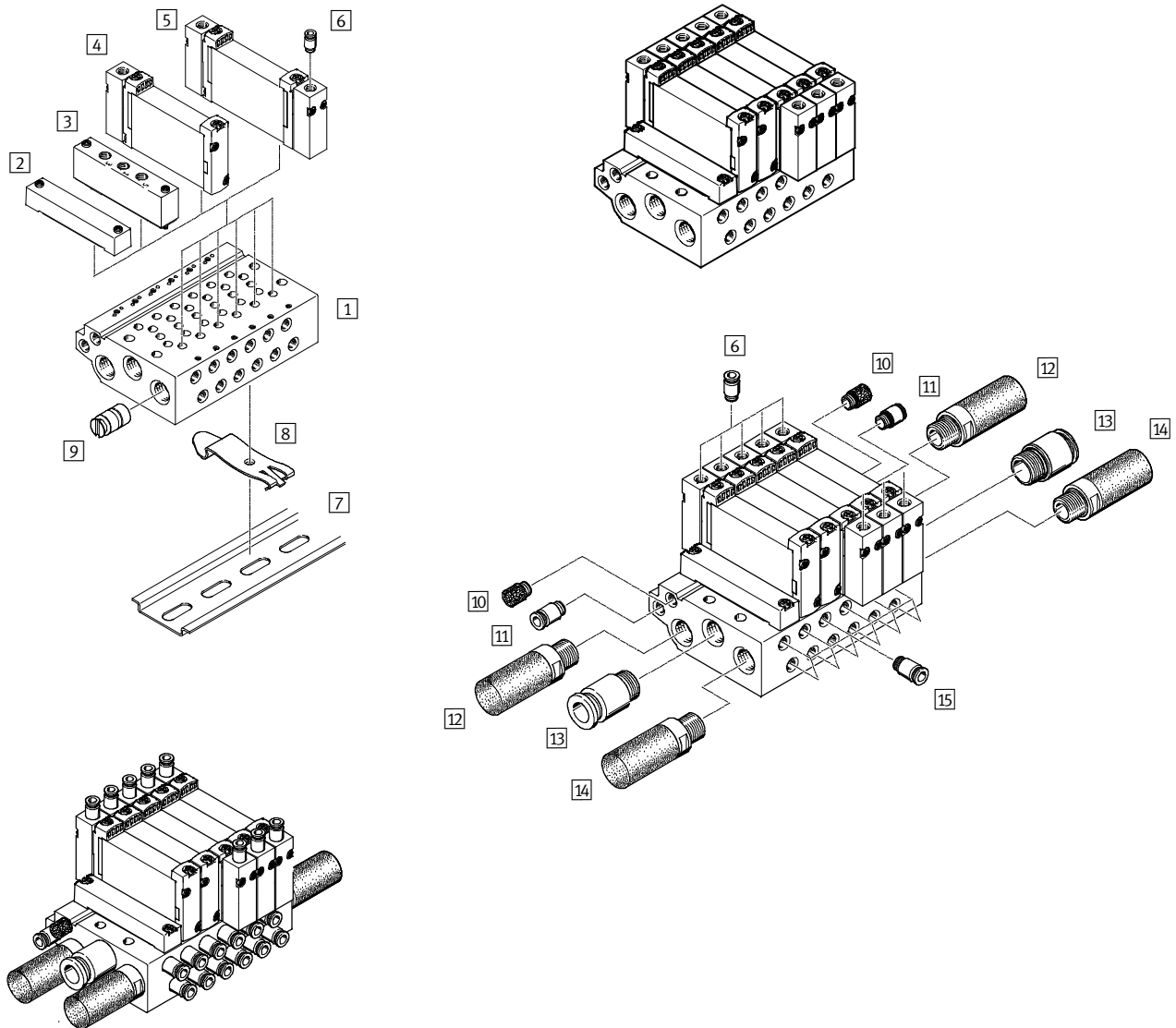

Manifold assembly and accessories				
	Type	Brief description	→ Page/Internet	
1	Manifold rail	VABM-L1-10W-G18	For 2 to 10, 12, 14 and 16 valve positions	43
2	Blanking plate	VABB-L1-10-W	For covering an unused valve position	43
3	Supply plate	VABF-L1-10-P3A4-M5	For air supply port 1 and ports 3 and 5	43
4	Pneumatic valve	VUWG	Single pilot pneumatic valve	39
5	Pneumatic valve	VUWG	Double pilot pneumatic valve	39
6	Push-in fitting	QS	For adapter plate for port 12 or 14	54
7	H-rail	NRH-35-2000	For mounting the valve manifold	54
8	H-rail mounting	VAME-T-M4	2 pieces for fitting the valve manifold on an H-rail	54
9	Separator	VABD-6-B	For creating pressure zones	43
10	Silencer	U	For port 84	54
11	Push-in fitting	QS	For port 14	54
12	Silencer	U	For port 5	54
13	Push-in fitting	QS	For port 1	54
14	Silencer	U	For port 3	54
15	Push-in fitting	QS	For ports 2 and 4	54

Pneumatic valves VUWG-L10A, in-line valves M3

Technical data

Function

- 5/2-way, single pilot
- 5/2-way, double pilot
- 5/3-way, closed, exhausted, pressurised

-  - Width 10 mm

-  - Flow rate
90 ... 100 l/min



General technical data						
Valve function	M52-R	B52	M52-M	P53		
Normal position	-	-	-	C ¹⁾	U ²⁾	E ³⁾
Pneumatic spring reset method	Yes ⁵⁾	-	No	No		
Mechanical spring reset method	Yes ⁵⁾	-	Yes	Yes		
Vacuum operation at port 1	No	Yes	Yes	Yes		
Design	Piston spool valve					
Sealing principle	Soft					
Actuation type	Pneumatic					
Type of control	Direct					
Pilot air supply	External					
Exhaust function	With flow control					
Type of mounting	Optionally via through-holes ⁷⁾ or on manifold rail					
Mounting position	Any					
Standard nominal flow rate	[l/min]	100		80	90	
Switching time on/off	[ms]	5/11	-	5/16	7/19	
Changeover time	[ms]	-	5	-	9	
Width	[mm]	10				
Port	1, 2, 3, 4, 5	M3				
	12, 14	M5				
Product weight	[g]	37	40	34	40	
Corrosion resistance class	CRC	2 ⁶⁾				

- 1) C = Normally closed
- 2) U = Normally open
- 3) E = Normally exhausted
- 4) H=2x3/2-way valve in one housing with 1x normally closed and 1x normally open
- 5) Combined reset method
- 6) Corrosion resistance class 2 according to Festo standard 940 070
Components subject to moderate corrosion stress. Externally visible parts with primarily decorative surface requirements which are in direct contact with a normal industrial environment or media such as coolants or lubricating agents.
- 7) If several valves are to be screwed together via the through-holes to form a block, a minimum gap of 0.3 mm must be ensured by placing spacer discs between them.

Pneumatic valves VUWG-L10A, in-line valves M3

Technical data

Operating and environmental conditions				
Valve function	M52-R ⁴⁾	B52	M52-M ³⁾	P53
Operating medium	Compressed air according to ISO 8573-1:2010 [7:4:4]			
Note on operating/pilot medium	Lubricated operation possible (in which case lubricated operation will always be required)			
Operating pressure [bar]	2.5 ... 10	-0.9 ... 10	-0.9 ... 8	-0.9 ... 10
Pilot pressure ¹⁾ [bar]	2.5 ... 10	1.5 ... 10	3 ... 10	
Ambient temperature [°C]	-5 ... +60			
Temperature of medium [°C]	-5 ... +50			

- 1) Note operating pressure/pilot pressure graph → page 4
- 2) Pneumatic spring
- 3) Mechanical spring
- 4) Mixed, pneumatic/mechanical spring

Information on materials	
Housing	Anodised aluminium
Seals	HNBR, NBR
Note on materials	RoHS-compliant

Dimensions Download CAD data → www.festo.com

5/2-way and 5/3-way valve

1) Ports 2, 4: M3 2) Port 14: M5 4) M2.5 mounting screw

3) Port 12: M5

Type	B1	B2	D1	D2	H1	H2	L1	L2	L3	L4	L5	L6	L7	L8	L9	L10
VUWG-L-10A-...	10.3	3.6	M3	3.2	32.5	9.1	59.9	50.7	34.9	18.5	20.7	7	9	7.9	7.3	12.4
VUWG-L-10A-M52...							49.9									

Pneumatic valves VUWG-L10A and VUWG-S10A, in-line valves M3

Order code

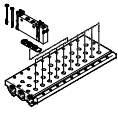
VUWG	-	10A	-
Valve design			
In-line, individual valve		L	
			
In-line, manifold valve incl. seal and screws		S	
			
Width			
10 mm		10A	

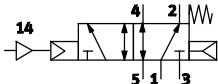
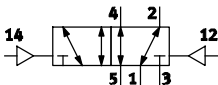
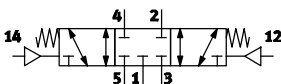
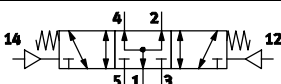
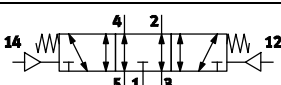
Valve functions	
	M52
	B52
	P53C
	P53U
	P53E

- 1) If Q... is chosen for the pneumatic connection, this also applies to the exhaust ports 3 and 5 (only possible with Q3)
- 2) Flow rate applies to 5/2-way individual valve

Exhausting with VUWG-L		
QN	Via fitting ¹⁾	
U	Silencer	
-	M3	
Pneumatic connection		
M3	Thread M3	Flow rate [l/min] ²⁾
Q3	Push-in connector 3 mm/M3	80
Q4	Push-in connector 4 mm/M3	100
T18	Push-in connector 1/8"	80
T532	Push-in connector 5/32"	100
Reset method		
M	Mechanical spring for M52	
R	Pneu./mech. spring for M52	
-	With B52 and P53	

Pneumatic valves VUWG-S10A, in-line valves M3

Manifold assembly

In-line valves for manifold assembly



Dimensions

Download CAD data → www.festo.com

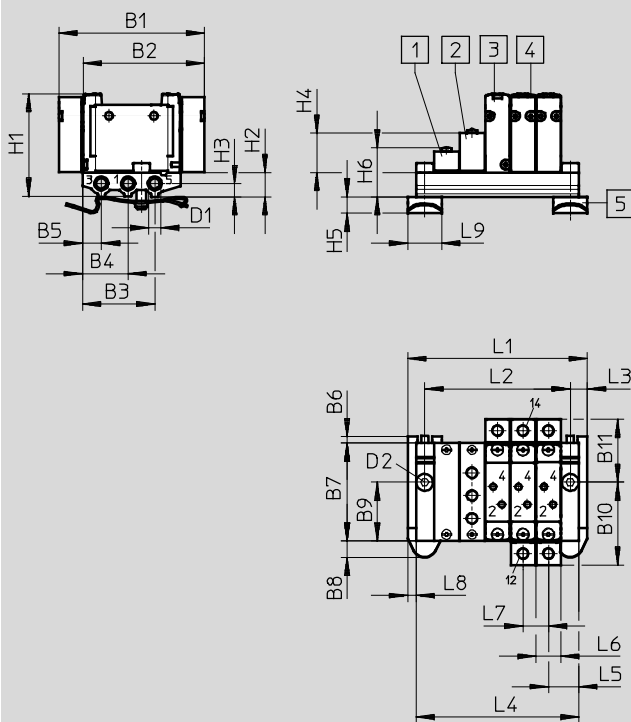

- 1 Blanking plate
VABB-L1-10A-S
- 2 Supply plate
VABF-L1-10A-P3A4-M5

- 3 Single pilot pneumatic valve
- 4 Double pilot pneumatic valve

- 5 H-rail mounting (two M4x15 screws to DIN 912 are required for mounting)

Type												
VABM-L1-10AS-M5	B1	B2	B3	B4	B5	B6	B7	B8	B9	B10	B11	D1
	59.9	49.9	29.7	18.7	7.7	2.95	40.3	6.75	24.2	34	25.9	M5
	D2	H1	H2	H3	H4	H5	H6	L3	L5	L6	L7	L8
	∅ 4.5	42.5	10	5.5	16.2	6.8	20.3	7	12.5	10.3	10.5	3.5
	L9											
	14											

Valve positions	2	3	4	5	6	7	8	9	10	12	14	16
L1 [mm]	42.5	53	63.5	74	84.5	95	105.5	116	126.5	147.5	168.5	189.5
L2 [mm]	28.5	39	49.5	60	70.5	81	91.5	102	112.5	133.5	154.5	175.5
L4 [mm]	35.5	46	56.5	67	77.5	88	98.5	109	119.5	140.5	161.5	182.5

Pneumatic valves VUWG-S10A, in-line valves M3

Ordering data

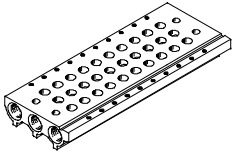



Technical data – Manifold rails							
	Port	CRC	Material ²⁾	Operating pressure	Max. tightening torque for assembly [Nm]		
	1, 3, 5			[bar]	Valve	H-rail	Wall
	M5	2 ¹⁾	Wrought aluminium alloy	-0.9 ... 10	0.45	1.5	3

- 1) Corrosion resistance class 2 according to Festo standard 940 070
Components subject to moderate corrosion stress. Externally visible parts with primarily decorative surface requirements which are in direct contact with a normal industrial environment or media such as coolants or lubricating agents.
- 2) Note on materials: RoHS-compliant

Order code – Manifold rails

VABM	-	L1	-	10A	S	-	M5	-	
Manifold assembly parts								Number of valve positions	
Manifold rail		VABM						2 to 10, 12, 14 and 16	
Valve series							Ports 1, 3, 5		
VUWG		L1					M5	M5	
Valve width									
10 mm				10A					
Manifold rail with ports 1, 3, 5									
For M3 in-line valves					S				



Ordering data – Accessories

				Type
Blanking plate				Technical data → Internet: vabb
	For manifold rail for M3 in-line valves	Incl. screws and seal		VABB-L1-10A
Separator				Technical data → Internet: vabd
	For manifold rail for M3 in-line valves	Separator for pressure zones		VABD-4.2-B
Supply plate				Technical data → Internet: vabf
	For manifold rail for M3 in-line valves	Incl. screws and seal		VABF-L1-10A-P3A4-M5
Seals for in-line valves				Technical data → Internet: vabd
	M3	10 seals and 20 screws		VABD-L1-10AX-S-M3

Pneumatic valves VUWG-L10 and VUWG-S10, in-line valves M5

Technical data

Function
 2x3/2C, 2x3/2U, 2x3/2H
 5/2-way, single pilot
 5/2-way, double pilot
 5/3C, 5/3U, 5/3E

-  - Width 10 mm
 -  - Flow rate
 150 ... 220 l/min



General technical data												
Valve function	T32-A			T32-M			M52-R	B52	M52-M	P53		
Normal position	C ¹⁾	U ²⁾	H ⁴⁾	C ¹⁾	U ²⁾	H ⁴⁾	-	-	-	C ¹⁾	U ²⁾	E ³⁾
Pneumatic spring reset method	Yes			No			Yes ⁵⁾	-	No	No		
Mechanical spring reset method	No			Yes			Yes ⁵⁾	-	Yes	Yes		
Vacuum operation at port 1	No			Yes			Yes					
Design	Piston spool valve											
Sealing principle	Soft											
Actuation type	Pneumatic											
Type of control	Direct											
Pilot air supply	External											
Exhaust function	With flow control											
Type of mounting	Optionally via through-holes ⁷⁾ or on manifold rail											
Mounting position	Any											
Standard nominal flow rate	[l/min]	150	135	125	220			190	210			
Switching time on/off	[ms]	4/9	6/7		6/12	-		7/16	8/25			
Changeover time	[ms]	-						5	-	11		
Width	[mm]	10										
Port	1, 2, 3, 4, 5	M5										
	12, 14	M5										
Product weight	[g]	48	51		45	48	41	48				
Corrosion resistance class	CRC	2 ⁶⁾										

- 1) C = Normally closed
- 2) U = Normally open
- 3) E = Normally exhausted
- 4) H=2x3/2-way valve in one housing with 1x normally closed and 1x normally open
- 5) Combined reset method
- 6) Corrosion resistance class 2 according to Festo standard 940 070
 Components subject to moderate corrosion stress. Externally visible parts with primarily decorative surface requirements which are in direct contact with a normal industrial environment or media such as coolants or lubricating agents.
- 7) If several valves are to be screwed together via the through-holes to form a block, a minimum gap of 0.3 mm must be ensured by placing spacer discs between them.

Pneumatic valves VUWG-L10 and VUWG-S10, in-line valves M5

FESTO

Technical data

Operating and environmental conditions						
Valve function		T32-A ²⁾	T32-M ³⁾	M52-R ⁴⁾	B52	M52-M ³⁾ P53
Operating medium		Compressed air according to ISO 8573-1:2010 [7:4:4]				
Note on operating/pilot medium		Lubricated operation possible (in which case lubricated operation will always be required)				
Operating pressure	[bar]	1.5 ... 10	-0.9 ... 10	2.5 ... 10	-0.9 ... 10	-0.9 ... 8 -0.9 ... 10
Pilot pressure ¹⁾	[bar]	1.5 ... 10	2 ... 10	2.5 ... 10	1.5 ... 10	3 ... 10
Ambient temperature	[°C]	-5 ... +60				
Temperature of medium	[°C]	-5 ... +50				

- 1) Note operating pressure/pilot pressure graph → page 4
- 2) Pneumatic spring
- 3) Mechanical spring
- 4) Mixed, pneumatic/mechanical spring

Information on materials	
Housing	Wrought aluminium alloy
Seals	HNBR, NBR
Note on materials	RoHS-compliant

Dimensions Download CAD data → www.festo.com

2x3/2-way, 5/2-way and 5/3-way valve

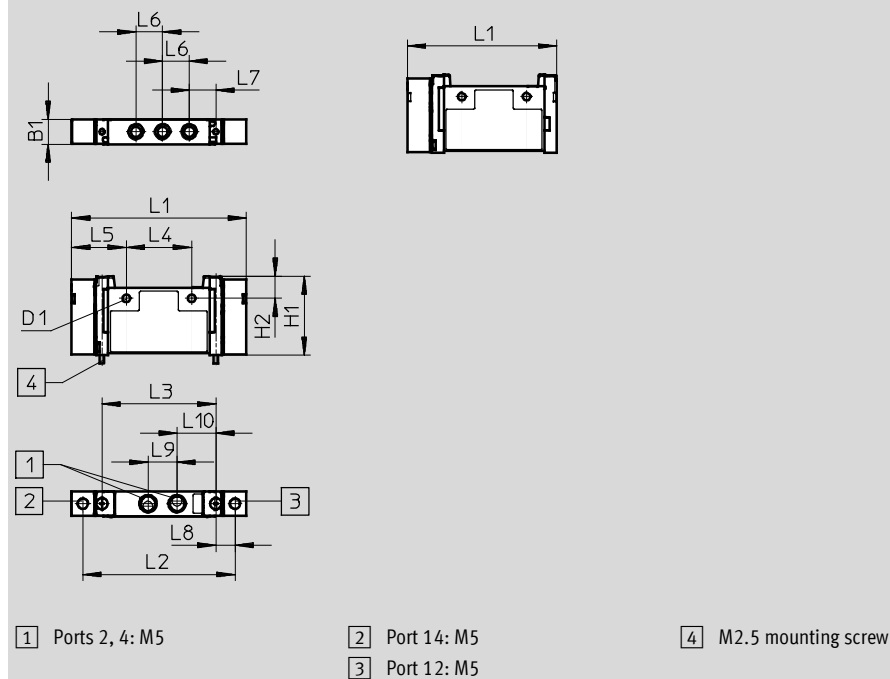

Type	B1	D1	H1	H2	L1	L2	L3	L4	L5	L6	L7	L8	L9	L10
VUWG-L-10-...	10.2	3.2	32.5	9.1	72	62.8	47	27	22.5	11	11	7.9	12	16
VUWG-L-10-M52-...					62									

Pneumatic valves VUWG-L10 and VUWG-S10, in-line valves M7

FESTO

Technical data

Function

2x3/2C, 2x3/2U, 2x3/2H

5/2-way, single pilot

5/2-way, double pilot

5/3C, 5/3U, 5/3E

-  - Width 10 mm

-  - Flow rate
190 ... 380 l/min



General technical data													
Valve function	T32-A			T32-M			M52-R	B52	M52-M	P53			
Normal position	C ¹⁾	U ²⁾	H ⁴⁾	C ¹⁾	U ²⁾	H ⁴⁾	-	-	-	C ¹⁾	U ²⁾	E ³⁾	
Pneumatic spring reset method	Yes			No			Yes ⁵⁾	-	No	No			
Mechanical spring reset method	No			Yes			Yes ⁵⁾	-	Yes	Yes			
Vacuum operation at port 1	No			Yes			No	Yes					
Design	Piston spool valve												
Sealing principle	Soft												
Actuation type	Pneumatic												
Type of control	Direct												
Pilot air supply	External												
Exhaust function	With flow control												
Type of mounting	Optionally via through-holes ⁷⁾ or on manifold rail												
Mounting position	Any												
Standard nominal flow rate	[l/min]	190		150	140		380		320				
Switching time on/off	[ms]	4/9		6/7		6/12		-	7/16		8/25		
Changeover time	[ms]	-						5		-		11	
Width	[mm]	10											
Port	1, 2, 3, 4, 5	M7											
	12, 14	M5											
Product weight	[g]	48		51		45		48		41		48	
Corrosion resistance class	CRC	2 ⁶⁾											

1) C = Normally closed

2) U = Normally open

3) E = Normally exhausted

4) H=2x3/2-way valve in one housing with 1x normally closed and 1x normally open

5) Combined reset method

6) Corrosion resistance class 2 according to Festo standard 940 070

Components subject to moderate corrosion stress. Externally visible parts with primarily decorative surface requirements which are in direct contact with a normal industrial environment or media such as coolants or lubricating agents.

7) If several valves are to be screwed together via the through-holes to form a block, a minimum gap of 0.3 mm must be ensured by placing spacer discs between them.

Pneumatic valves VUWG-L10 and VUWG-S10, in-line valves M7

Technical data

Operating and environmental conditions						
Valve function		T32-A ²⁾	T32-M ³⁾	M52-R ⁴⁾	B52	M52-M ³⁾ P53
Operating medium	Compressed air according to ISO 8573-1:2010 [7:4:4]					
Note on operating/pilot medium	Lubricated operation possible (in which case lubricated operation will always be required)					
Operating pressure	[bar]	1.5 ... 10	-0.9 ... 10	2.5 ... 10	-0.9 ... 10	-0.9 ... 8 -0.9 ... 10
Pilot pressure ¹⁾	[bar]	1.5 ... 10	2 ... 10	2.5 ... 10	1.5 ... 10	3 ... 10
Ambient temperature	[°C]	-5 ... +60				
Temperature of medium	[°C]	-5 ... +50				

- 1) Note operating pressure/pilot pressure graph → page 4
- 2) Pneumatic spring
- 3) Mechanical spring
- 4) Mixed, pneumatic/mechanical spring

Information on materials	
Housing	Wrought aluminium alloy
Seals	HNBR, NBR
Note on materials	RoHS-compliant

Dimensions Download CAD data → www.festo.com

2x3/2-way, 5/2-way and 5/3-way valve

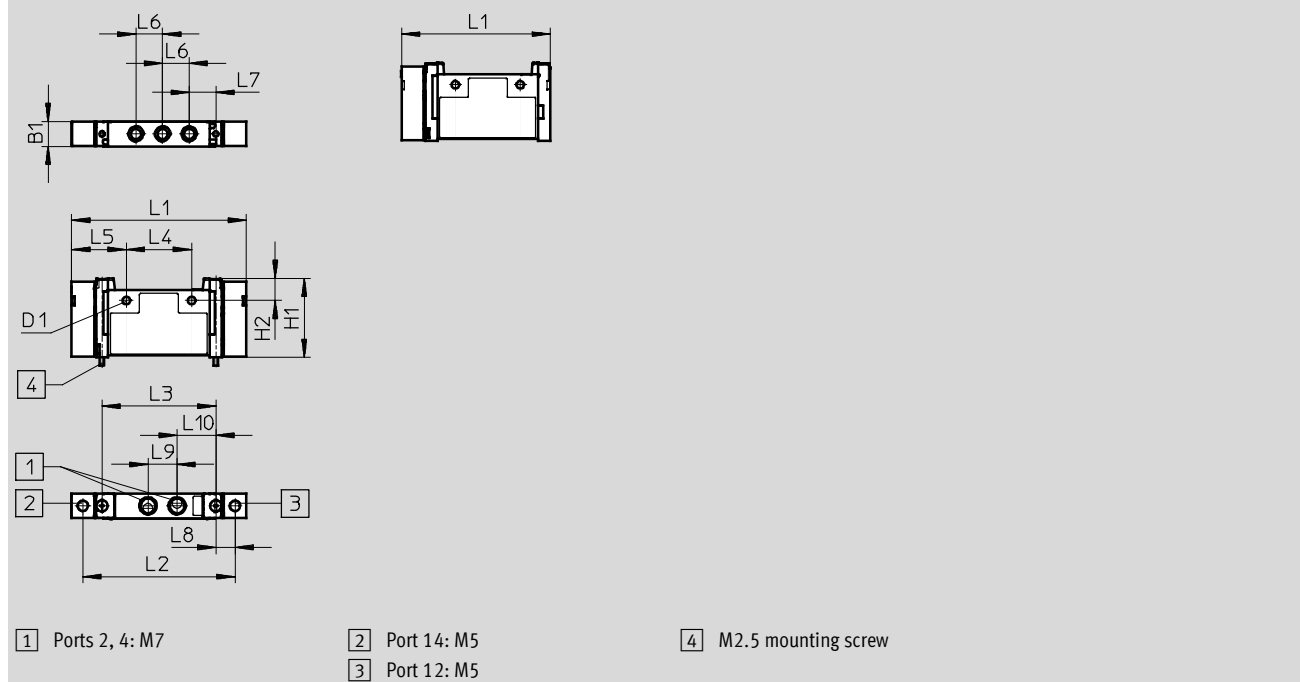

Type	B1	D1	H1	H2	L1	L2	L3	L4	L5	L6	L7	L8	L9	L10
VUWG-L-10 ...-	10.2	3.2	32.5	9.1	72	62.8	47	27	22.5	11	11	7.9	12	16
VUWG-L-10-M52 ...					62									

Pneumatic valves VUWG-L10 and VUWG-S10, in-line valves M5/M7

Order code

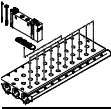
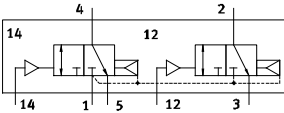
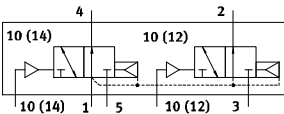
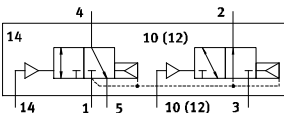
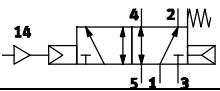
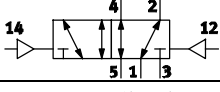
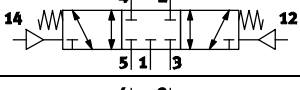
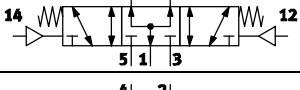
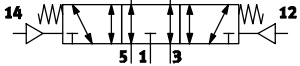
VUWG	-	10	-
Valve design			
In-line, individual valve		L	
			
In-line valve, manifold valve incl. seal and screws		S	
			
Width			
10 mm		10	
Valve functions			
			T32C
			T32U
			T32H
			M52
			B52
			P53C
			P53U
			P53E

- 1) If Q... is chosen for the pneumatic connection, this also applies to the exhaust ports 3 and 5
- 2) Flow rate applies to 5/2-way individual valve

		Exhausting with VUWG-L	
QN	QS if QS ¹⁾		
U	Silencer		
-	M5 and M7		
Pneumatic connection		Flow rate [(l/min)²]	
M5	Thread M5	220	
Q3	Push-in connector 3 mm/M5	100	
Q4	Push-in connector 4 mm/M5	200	
Q6	Push-in connector 6 mm/M5	220	
T14	Push-in connector 1/4"	220	
T18	Push-in connector 3/8"	100	
T316	Push-in connector 3/16"	200	
T532	Push-in connector 5/32"	200	
M7	Thread M7	380	
Q4H	Push-in connector 4 mm/M7	220	
Q6H	Push-in connector 6 mm/M7	330	
T14H	Push-in connector 1/4", M7	330	
T316H	Push-in connector 3/16", M7	200	
Reset method			
A	Pneumatic spring for T32 and M52		
M	Mechanical spring for T32 and M52		
R	Pneu./mech. spring for M52		
-	With B52 and P53		

Pneumatic valves VUWG-S10, in-line valves M5/M7

FESTO

Manifold assembly

In-line valves for manifold assembly



Dimensions

Download CAD data → www.festo.com

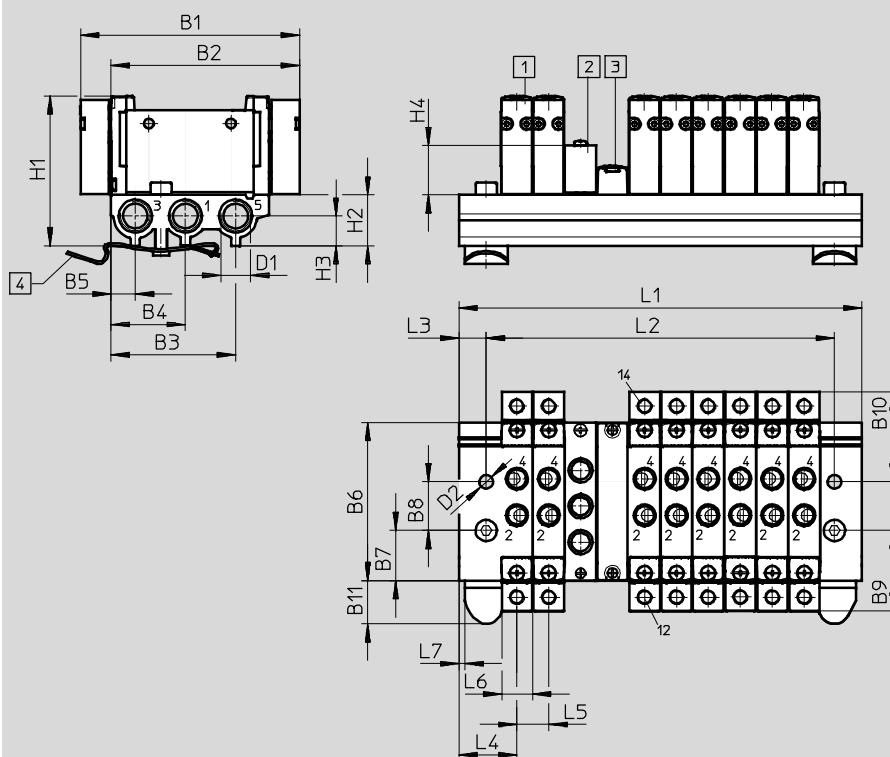

- 1 Pneumatic valve
- 2 Supply plate M5 or M7 for 1, 3, 5
- 3 Blanking plate VABB-L1-10-S
- 4 H-rail mounting (two M4x20 screws to DIN 912 are required)

Type	B1	B2	B3	B4	B5	B6	B7	B8	B9	B10	B11
VABM-L1-10S-G18	72	62	41	24.5	8	52	16.5	16	26.5	29.5	14.45
	D1	D2	H1	H2	H3	H4	H4	L3	L4	L5	L6
	G $\frac{1}{8}$	4.5	49.3	16.8	7	16.2	16.2	9	19	10.5	10.3
	L7										
	2										

Valve positions	2	3	4	5	6	7	8	9	10	12	14	16	22
L1 [mm]	48.5	59	69.5	80	90.5	101	111.5	122	132.5	153.5	174.5	195.5	258.5
L2 [mm]	30.5	41	51.5	62	72.5	83	93.5	104	114.5	135.5	156.5	177.5	240.5

Pneumatic valves VUWG-S10, in-line valves M5/M7

FESTO

Ordering data

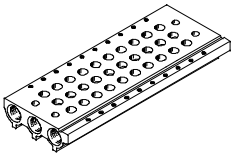



Technical data – Manifold rails							
	Port	CRC	Material ²⁾	Operating pressure	Max. tightening torque for assembly [Nm]		
	1, 3, 5			[bar]	Valve	H-rail	Wall
	G $\frac{1}{8}$	2 ¹⁾	Wrought aluminium alloy	-0.9 ... 10	0.45	1.5	3

- 1) Corrosion resistance class 2 according to Festo standard 940 070
Components subject to moderate corrosion stress. Externally visible parts with primarily decorative surface requirements which are in direct contact with a normal industrial environment or media such as coolants or lubricating agents.
- 2) Note on materials: RoHS-compliant

Order code – Manifold rails

VABM	-	L1	-	10	S	-	G18	-	
Manifold assembly parts								Number of valve positions	
Manifold rail		VABM						2 to 10, 12, 14 and 16	
Valve series								Ports 1, 3, 5	
VUWG		L1						G18 G $\frac{1}{8}$	
Valve width									
10 mm				10					
Manifold rail with ports 1, 3, 5									
For M5 and M7 in-line valves				S					

Ordering data – Accessories

			Type
Blanking plate Technical data → Internet: vabb			
	For manifold rail for M5/M7 in-line valves	Incl. screws and seal	VABB-L1-10-S
Separator Technical data → Internet: vabd			
	For manifold rail for M5/M7 in-line valves	Separator for pressure zones	VABD-8-B
Supply plate Technical data → Internet: vabf			
	For manifold rail for M5 in-line valves	Incl. screws and seal	VABF-L1-10-P3A4-M5
	For manifold rail for M7 in-line valves		VABF-L1-10-P3A4-M7
Seals for in-line valves Technical data → Internet: vabd			
	M5	10 seals and 20 screws	VABD-L1-10X-S-M5
	M7		VABD-L1-10X-S-M7

Pneumatic valves VUWG-L14 and VUWG-S14, in-line valves G¹/₈

FESTO

Technical data

Function

2x3/2C, 2x3/2U, 2x3/2H

5/2-way, single pilot

5/2-way, double pilot

5/3C, 5/3U, 5/3E

-  - Width 14 mm

-  - Flow rate
580 ... 780 l/min



General technical data													
Valve function	T32-A			T32-M			M52-A	B52	M52-M	P53			
Normal position	C ¹⁾	U ²⁾	H ⁴⁾	C ¹⁾	U ²⁾	H ⁴⁾	-	-	-	C ¹⁾	U ²⁾	E ³⁾	
Pneumatic spring reset method	Yes			No			Yes	-	No	No			
Mechanical spring reset method	No			Yes			No	-	Yes	Yes			
Vacuum operation at port 1	No			Yes			No	Yes					
Design	Piston spool valve												
Sealing principle	Soft												
Actuation type	Pneumatic												
Type of control	Direct												
Pilot air supply	External												
Exhaust function	With flow control												
Type of mounting	Optionally via through-holes ⁷⁾ or on manifold rail												
Mounting position	Any												
Standard nominal flow rate	[l/min]			650	600	650	550	500	780			650	600
Switching time on/off	[ms]			6/19			9/13			12/22	-	12/32	8/30
Changeover time	[ms]			-			-			6	16		
Width	[mm]			14									
Port	1, 2, 3, 4, 5			G ¹ / ₈									
	14			M5									
Product weight	[g]			81			77			75	81	67	81
Corrosion resistance class	CRC			2 ⁶⁾									

1) C = Normally closed

2) U = Normally open

3) E = Normally exhausted

4) H=2x3/2-way valve in one housing with 1x normally closed and 1x normally open

6) Corrosion resistance class 2 according to Festo standard 940 070

Components subject to moderate corrosion stress. Externally visible parts with primarily decorative surface requirements which are in direct contact with a normal industrial environment or media such as coolants or lubricating agents.

7) If several valves are to be screwed together via the through-holes to form a block, a minimum gap of 0.3 mm must be ensured by placing spacer discs between them.

Pneumatic valves VUWG-L14 and VUWG-S14, in-line valves G1/8

Technical data

Operating and environmental conditions						
Valve function		T32-A ²⁾	T32-M ³⁾	M52-A ²⁾	B52	M52-M ³⁾ P53
Operating medium		Compressed air according to ISO 8573-1:2010 [7:4:4]				
Note on operating/pilot medium		Lubricated operation possible (in which case lubricated operation will always be required)				
Operating pressure	[bar]	1.5 ... 10	-0.9 ... 10	2.5 ... 10	-0.9 ... 10	-0.9 ... 8
Pilot pressure ¹⁾	[bar]	1.5 ... 10	2 ... 10	2.5 ... 10	1.5 ... 10	3 ... 10
Ambient temperature	[°C]	-5 ... +60				
Temperature of medium	[°C]	-5 ... +50				

- 1) Note operating pressure/pilot pressure graph → page 4
- 2) Pneumatic spring
- 3) Mechanical spring
- 4) Mixed, pneumatic/mechanical spring

Information on materials	
Housing	Wrought aluminium alloy
Seals	HNBR, NBR
Note on materials	RoHS-compliant

Dimensions Download CAD data → www.festo.com

2x3/2-way, 5/2-way and 5/3-way valve

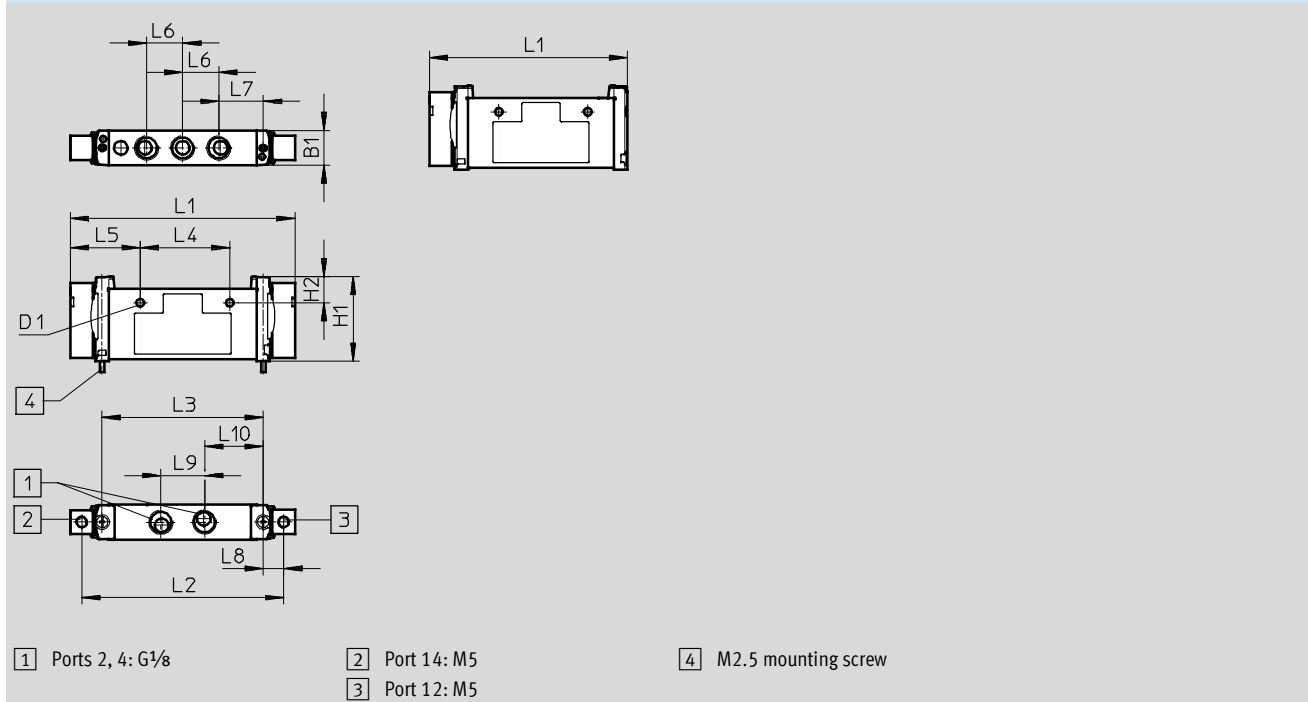

Type	B1	D1	H1	H2	L1	L2	L3	L4	L5	L6	L7	L8	L9	L10
VUWG-L-14-...	14.4	3.2	34.8	10.8	92.6	83.4	66.5	37	28.8	14.9	18.35	8.45	18	24.25
VUWG-L14-M52 ...					82.25									

Pneumatic valves VUWG-L14 and VUWG-S14, in-line valves G¹/₈

Order code

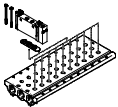
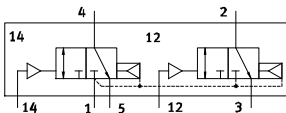
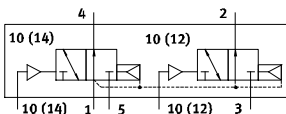
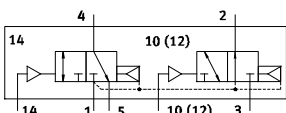
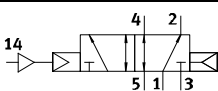
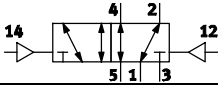
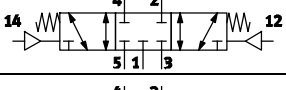
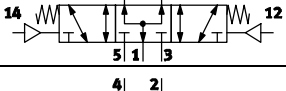
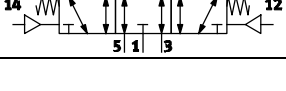
VUWG	-	14	-
Valve design			
In-line, individual valve		L	
			
In-line valve, manifold valve incl. seal and screws		S	
			
Width			
14 mm		14	
Valve functions			
			T32C
			T32U
			T32H
			M52
			B52
			P53C
			P53U
			P53E

- 1) If Q... is chosen for the pneumatic connection, this also applies to the exhaust ports 3 and 5
- 2) Flow rate applies to 5/2-way individual valve

Exhausting with VUWG-L	
QN	QS if QS ¹⁾
U	Silencer
-	G ¹ / ₈
Pneumatic connection	
G18	Thread G ¹ / ₈
Q4	Push-in connector 4 mm/G ¹ / ₈
Q6	Push-in connector 6 mm/G ¹ / ₈
Q8	Push-in connector 8 mm/G ¹ / ₈
T14	Push-in connector 1/4"
T516	Push-in connector 5/16"
Flow rate [l/min]²⁾	
	780
	200
	400
	700
	400
	700
Reset method	
A	Pneumatic spring for T32 and M52
M	Mechanical spring for T32 and M52
-	With B52 and P53

Pneumatic valves VUWG-S14, in-line valves G1/8

Manifold assembly

In-line valves for manifold assembly



Dimensions

Download CAD data → www.festo.com

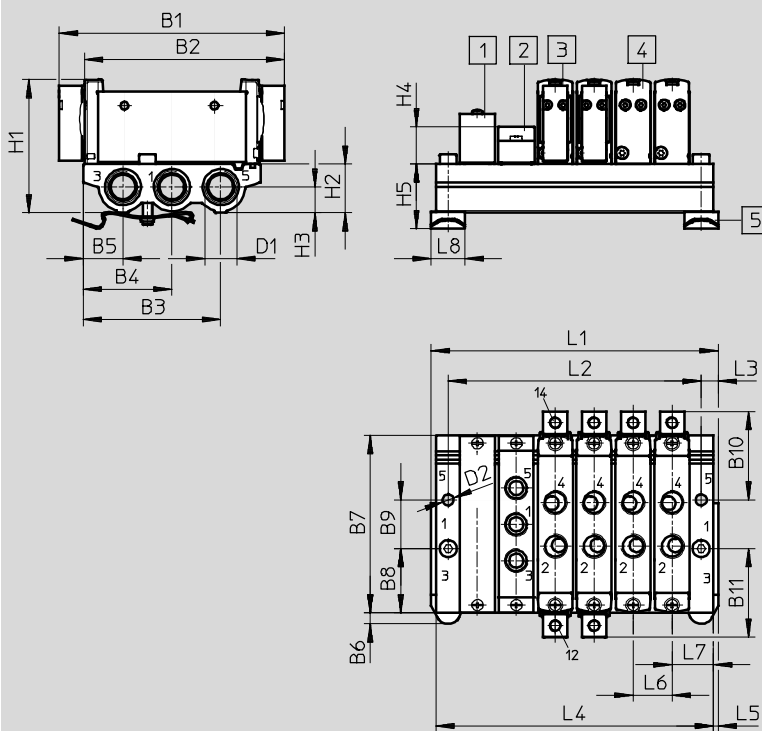

- 1 Blanking plate
VABB-L1-14
- 2 Supply plate
VABF-L1-14-P3A4-G18
- 3 Double pilot pneumatic valve
- 4 Single pilot pneumatic valve
- 5 H-rail mounting
(two M4x25 screws to DIN 912 are required for mounting)

Type												
VABM-L1-14S-G14	B1	B2	B3	B4	B5	B6	B7	B8	B9	B10	B11	D1
	92.6	82.3	56.6	36.5	16.4	4.5	72.9	26.45	20	36.3	36.3	G1/4
	D2	H1	H2	H3	H4	H5	L3	L5	L6 ¹⁾	L7		
	∅ 4.5	54.8	20	10.6	15.4	26.4	7	2	16	17		

Valve positions	2	3	4	5	6	7	8	9	10	12	14	16
L1 [mm]	54	70	86	98	118	134	150	166	182	214	246	278
L2 [mm]	40	56	72	88	104	120	136	152	168	200	232	264
L4 [mm]	50	66	82	98	114	130	146	162	178	210	242	274

1) Grid dimension

Pneumatic valves VUWG-S14, in-line valves G1/8

Ordering data

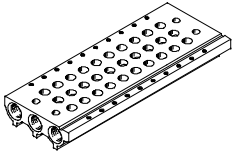



Technical data – Manifold rails							
	Port	CRC	Material ²⁾	Operating pressure	Max. tightening torque for assembly [Nm]		
	1, 3, 5			[bar]	Valve	H-rail	Wall
	G1/4	2 ¹⁾	Wrought aluminium alloy	-0.9 ... 10	0.65	1.5	3

- 1) Corrosion resistance class 2 according to Festo standard 940 070
Components subject to moderate corrosion stress. Externally visible parts with primarily decorative surface requirements which are in direct contact with a normal industrial environment or media such as coolants or lubricating agents.
- 2) Note on materials: RoHS-compliant

Order code – Manifold rails

VABM	-	L1	-	14	S	-	G14	-	
Manifold assembly parts									
Manifold rail	VABM								
Valve series									
VUWG	L1								
Valve width									
14 mm	14								
Manifold rail with ports 1, 3, 5									
For G1/8 in-line valves	S								
				Number of valve positions					
				2 to 10, 12, 14 and 16					
				Ports 1, 3, 5					
				G14 G1/4					

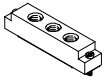
Ordering data – Accessories

				Type
Blanking plate				Technical data → Internet: vabb
	For manifold rail for M5/M7 in-line valves	Incl. screws and seal		VABB-L1-14
Separator				Technical data → Internet: vabd
	For manifold rail for G1/8 in-line valves	Separator for pressure zones		VABD-10-B
Supply plate				Technical data → Internet: vabf
	For manifold rail for G1/8 in-line valves	Incl. screws and seal		VABF-L1-14-P3A4-G18
Seals for in-line valves				Technical data → Internet: vabd
	G1/8	10 seals and 20 screws		VABD-L1-14X-S-G18

Pneumatic valves VUWG-L18 and VUWG-S18, in-line valves G1/4

FESTO

Technical data

Function

2x3/2C, 2x3/2U, 2x3/2H

5/2-way, single pilot

5/2-way, double pilot

5/3C, 5/3U, 5/3E

 Width 18 mm

 Flow rate
1,000 ... 1,300 l/min

General technical data												
Valve function	T32-A			T32-M			M52-R	B52	M52-M	P53		
Normal position	C ¹⁾	U ²⁾	H ⁴⁾	C ¹⁾	U ²⁾	H ⁴⁾	–	–	–	C ¹⁾	U ²⁾	E ³⁾
Pneumatic spring reset method	Yes			No			Yes ⁵⁾	–	No	No		
Mechanical spring reset method	No			Yes			Yes ⁵⁾	–	Yes	Yes		
Vacuum operation at port 1	No			Yes			No	Yes				
Design	Piston spool valve											
Sealing principle	Soft											
Actuation type	Pneumatic											
Type of control	Direct											
Pilot air supply	External											
Exhaust function	With flow control											
Type of mounting	Optionally via through-holes ⁷⁾ or on manifold rail											
Mounting position	Any											
Standard nominal flow rate	[l/min]	1,000						1,300				1,200
Switching time on/off	[ms]	12/25			14/22			14/30	–	12/45	12/45	
Changeover time	[ms]	–							10	–	25	
Width	[mm]	18										
Port		1, 2, 3, 4, 5			G1/4							
		12/14			M5							
Product weight	[g]	160						152	160	152		
Corrosion resistance class	CRC	2 ⁶⁾										

1) C = Normally closed

2) U = Normally open

3) E = Normally exhausted

4) H=2x3/2-way valve in one housing with 1x normally closed and 1x normally open

6) Corrosion resistance class 2 according to Festo standard 940 070

Components subject to moderate corrosion stress. Externally visible parts with primarily decorative surface requirements which are in direct contact with a normal industrial environment or media such as coolants or lubricating agents.

7) If several valves are to be screwed together via the through-holes to form a block, a minimum gap of 0.3 mm must be ensured by placing spacer discs between them.

Pneumatic valves VUWG-L18 and VUWG-S18, in-line valves G^{1/4}

Technical data

Operating and environmental conditions						
Valve function	T32-A ²⁾	T32-M ³⁾	M52-R ⁴⁾	B52	M52-M ³⁾	P53
Operating medium	Compressed air according to ISO 8573-1:2010 [7:4:4]					
Note on operating/pilot medium	Lubricated operation possible (in which case lubricated operation will always be required)					
Operating pressure [bar]	1.5 ... 10	-0.9 ... 10	2.5 ... 10	-0.9 ... 10	-0.9 ... 8	-0.9 ... 10
Pilot pressure ¹⁾ [bar]	1.5 ... 10	2 ... 10	2.5 ... 10	1.5 ... 10	3 ... 10	
Ambient temperature [°C]	-5 ... +60					
Temperature of medium [°C]	-5 ... +50					

- 1) Note operating pressure/pilot pressure graph → page 4
- 2) Pneumatic spring
- 3) Mechanical spring
- 4) Mixed, pneumatic/mechanical spring

Information on materials	
Housing	Wrought aluminium alloy
Seals	HNBR, NBR
Note on materials	RoHS-compliant

Dimensions Download CAD data → www.festo.com

2x3/2-way, 5/2-way and 5/3-way valve

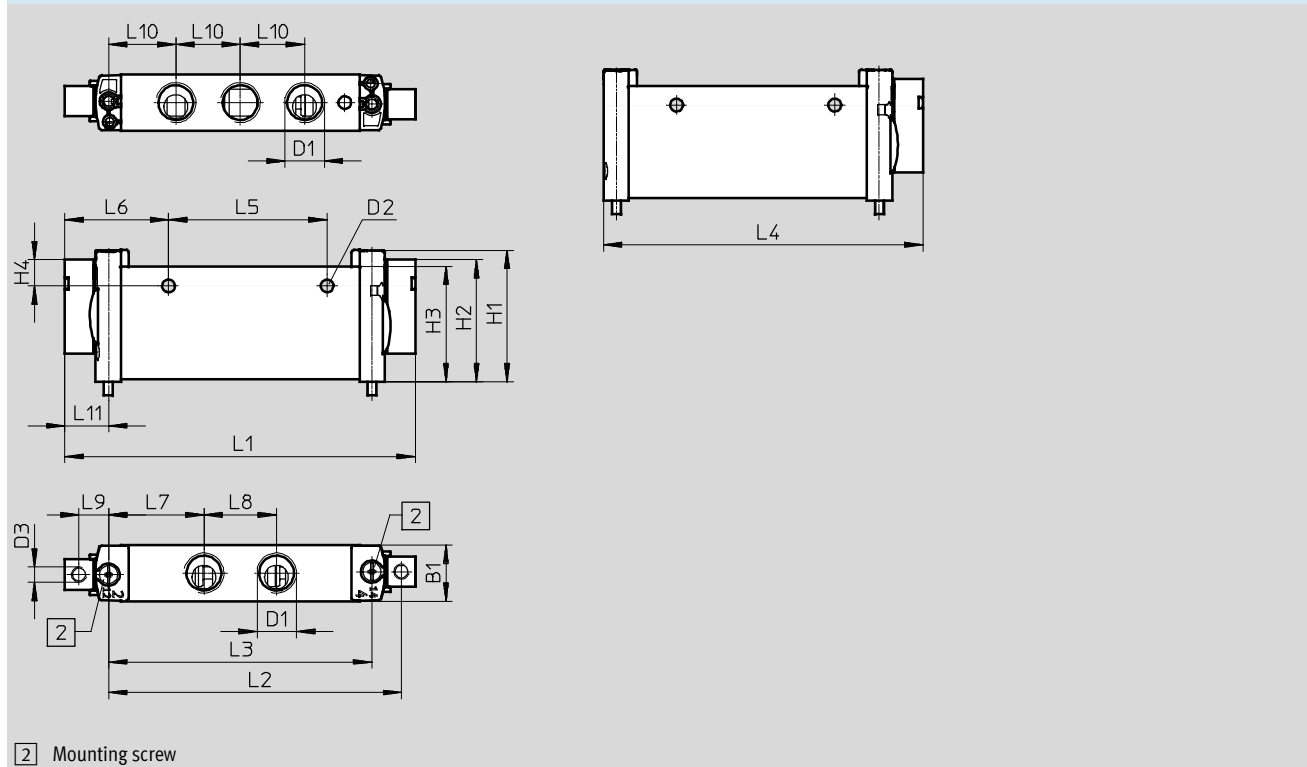

Type	B1	D1	D2	D3	H1	H2	H3	H4	L1	L2	L3	L4	L5	L6	L7	L8	L9	L10	L11
VUWG-L-18-... G14	18.3	D ^{1/4}	4.2	M5	43.1	40	37.8	6.4	115	96.1	86.4	105	52	34	31.3	23.8	9.7	21.1	14.3

Pneumatic valves VUWG-L18 and VUWG-S18, in-line valves G1/4

FESTO

Order code

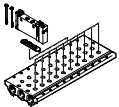
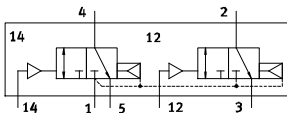
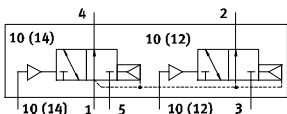
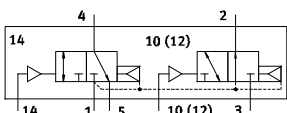
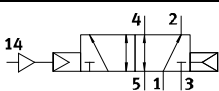
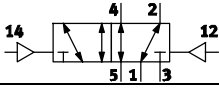
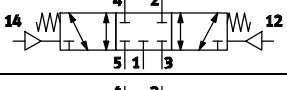
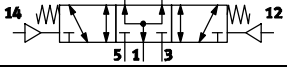
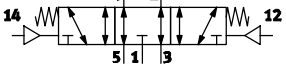
VUWG	-	18	-
Valve design			
In-line, individual valve		L	
			
In-line valve, manifold valve incl. seal and screws		S	
			
Width			
18 mm		18	
Valve functions			
			T32C
			T32U
			T32H
			M52
			B52
			P53C
			P53U
			P53E

- 1) If Q... is chosen for the pneumatic connection, this also applies to the exhaust ports 3 and 5
- 2) Flow rate applies to 5/2-way individual valve

Exhausting with VUWG-L	
QN	QS if QS ¹⁾
U	Silencer
-	G1/8
Pneumatic connection	
G14	Thread G1/4
Q6	Push-in connector 6 mm
Q8	Push-in connector 8 mm
Q10	Push-in connector 10 mm
T14	Push-in connector 1/4"
T38	Push-in connector 3/8"
T516	Push-in connector 5/16"
Flow rate [l/min]²⁾	
G14	1,300
Q6	400
Q8	700
Q10	1,100
T14	400
T38	1,200
T516	700
Reset method	
A	Pneumatic spring for T32 and M52
M	Mechanical spring for T32 and M52
R	Pneu./mech. spring for M52
-	With B52 and P53

Pneumatic valves VUWG-S18, in-line valves G1/4

Manifold assembly

In-line valves for manifold assembly



Dimensions

Download CAD data → www.festo.com

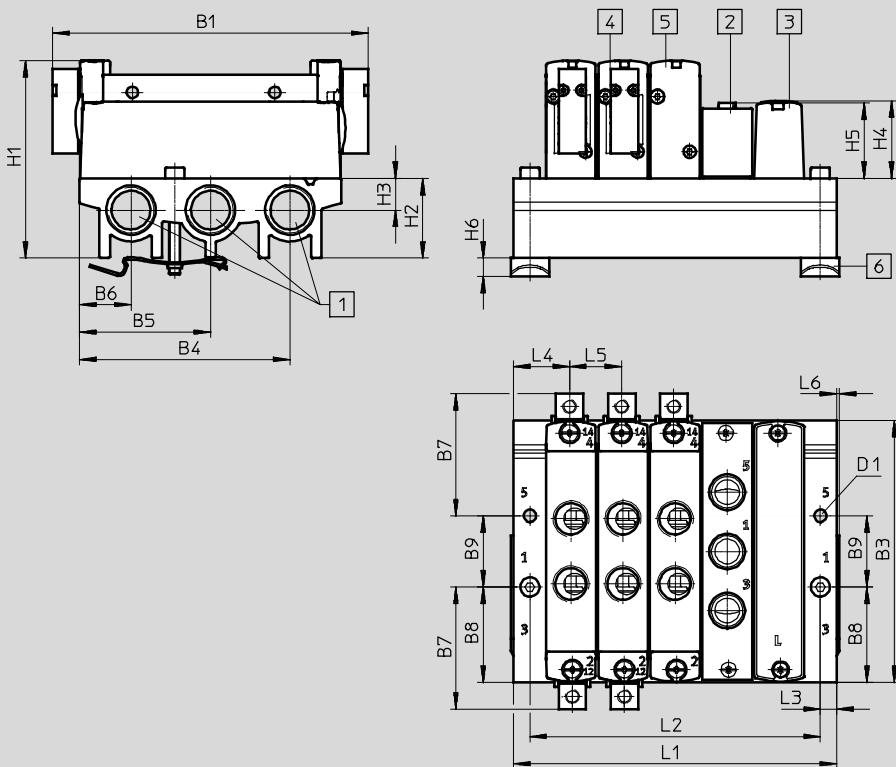

- 1 Ports 1, 3 and 5: G3/8
- 2 Blanking plate VABB-L1-18
- 3 Supply plate VABF-L1-18-P3A4-G14
- 4 Double pilot pneumatic valve
- 5 Single pilot pneumatic valve
- 6 H-rail mounting (two M4x35 screws to DIN 912 are required)

Type	B1	B3	B4	B5	B6	B7	B8	B9	D1	H1	H2
VABM-L1-18S-G38	115	95.6	76.8	47.8	18.8	44.5	34.8	26	4.5	72.1	29
	H3	H4	H5	H6	L3	L4	L6				
	11.5	28.4	27.6	6.5	6	20.5	1				

Valve positions	2	3	4	5	6	7	8	9	10	12	14	16
L1 [mm]	63.5	82.5	101.5	120.5	139.5	158.5	177.5	196.5	215.5	253.5	291.5	329.5
L2 [mm]	49	68	87	106	125	144	163	182	201	239	277	315

1) Grid dimension

Pneumatic valves VUWG-S18, in-line valves G1/4

FESTO

Ordering data

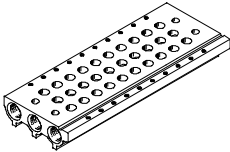



Technical data – Manifold rails							
	Port	CRC	Material ²⁾	Operating pressure	Max. tightening torque for assembly [Nm]		
	1, 3, 5			[bar]	Valve	H-rail	Wall
	G3/8	2 ¹⁾	Wrought aluminium alloy	-0.9 ... 10	0.65	1.5	3

- 1) Corrosion resistance class 2 according to Festo standard 940 070
Components subject to moderate corrosion stress. Externally visible parts with primarily decorative surface requirements which are in direct contact with a normal industrial environment or media such as coolants or lubricating agents.
- 2) Note on materials: RoHS-compliant

Order code – Manifold rails

VABM	-	L1	-	18	S	-	G38	-	
Manifold assembly parts								Number of valve positions	
Manifold rail		VABM						2 to 10, 12, 14 and 16	
Valve series								Ports 1, 3, 5	
VUWG		L1						G38 G3/8	
Valve width									
18 mm				18					
Manifold rail with ports 1, 3, 5									
For G1/8 in-line valves				S					

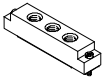
Ordering data – Accessories

			Type
Blanking plate Technical data → Internet: vabb			
	For manifold rail for M5/M7 in-line valves	Incl. screws and seal	VABB-L1-18
Separator Technical data → Internet: vabd			
	For manifold rail for G1/8 in-line valves	Separator for pressure zones	VABD-14-B
Supply plate Technical data → Internet: vabf			
	For manifold rail for G1/8 in-line valves	Incl. screws and seal	VABF-L1-18-P3A4-G14
Seals for in-line valves Technical data → Internet: vabd			
	G1/8	10 seals and 20 screws	VABD-L1-18X-S-G14

Pneumatic valves VUWG-B10A, sub-base valves

Technical data

Function
 5/2-way, single pilot
 5/2-way, double pilot
 5/3-way, closed, exhausted,
 pressurised

-  - Width 10 mm

-  - Flow rate
 90 ... 100 l/min



General technical data						
Valve function	M52-R	B52	M52-M	P53		
Normal position	-	-	-	C ¹⁾	U ²⁾	E ³⁾
Pneumatic spring reset method	Yes ⁵⁾	-	No	Yes		
Mechanical spring reset method	Yes ⁵⁾	-	Yes	No		
Vacuum operation at port 1	No	Yes		Yes		
Design	Piston spool valve					
Sealing principle	Soft					
Actuation type	Pneumatic					
Type of control	Direct					
Pilot air supply	External					
Exhaust function	With flow control					
Type of mounting	On manifold rail					
Mounting position	Any					
Standard nominal flow rate	[l/min]	100		80	90	
Switching time on/off	[ms]	5/11	-	5/16	7/19	
Changeover time	[ms]	-	5		9	
Width	[mm]	10				
Port	1, 3, 5	M5/M7				
	2, 4	M3				
	12, 14, 82/84	M5				
Product weight	[g]	37	40	34	40	
Corrosion resistance class	CRC	2 ⁶⁾				

1) C = Normally closed

2) U = Normally open

3) E = Normally exhausted

5) Combined reset method

6) Corrosion resistance class 2 according to Festo standard 940 070

Components subject to moderate corrosion stress. Externally visible parts with primarily decorative surface requirements which are in direct contact with a normal industrial environment or media such as coolants or lubricating agents.

Pneumatic valves VUWG-B10A, sub-base valves

Technical data

Operating and environmental conditions				
Valve function	M52-R ⁴⁾	B52	M52-M ³⁾	P53
Operating medium	Compressed air according to ISO 8573-1:2010 [7:4:4]			
Note on operating/pilot medium	Lubricated operation possible (in which case lubricated operation will always be required)			
Operating pressure [bar]	2.5 ... 10	-0.9 ... 10	-0.9 ... 8	-0.9 ... 10
Pilot pressure ¹⁾ [bar]	2.5 ... 10	1.5 ... 10	3 ... 10	
Ambient temperature [°C]	-5 ... +60			
Temperature of medium [°C]	-5 ... +50			

- 1) Note operating pressure/pilot pressure graph → page 4
- 2) Pneumatic spring
- 3) Mechanical spring
- 4) Mixed, pneumatic/mechanical spring

Information on materials	
Housing	Anodised aluminium
Seals	HNBR, NBR
Note on materials	RoHS-compliant

Dimensions Download CAD data → www.festo.com

5/2-way and 5/3-way valve

The image contains three technical drawings. Two are side views of the valve, each with a dimension line labeled 'L1' indicating the length. The third is a front view showing the valve's profile and mounting holes. Below the front view is a detailed view of the valve symbol, which consists of a square with a circle inside, and a smaller square with a circle inside, connected by a line.

Type	B1	L1
VUWG-B10A-...	10.3	59.9
VUWG-B10A-M52...		49.9

- 1) Only with external pilot air

Pneumatic valves VUWG-B10A, sub-base valves

Order code

VUWG	- B	10A
Valve design Sub-base, manifold valve incl. seal and screws		
		B
Width 10 mm		
		10A

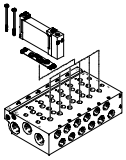

Valve functions	
	M52
	B52
	P53C
	P53U
	P53E

-	F
Pneumatic connection	
F	In the manifold rail
Reset method	
M	Mechanical spring for M52
R	Pneu./mech. spring for M52
-	With B52 and P53

Pneumatic valves VUWG-B10A, sub-base valves

Manifold assembly



Sub-base valve for manifold assembly
M5 connection

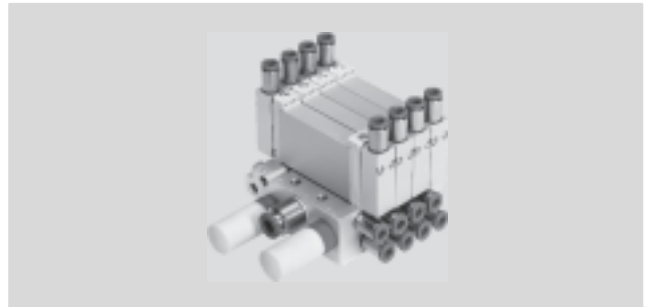

Dimensions

Download CAD data → www.festo.com

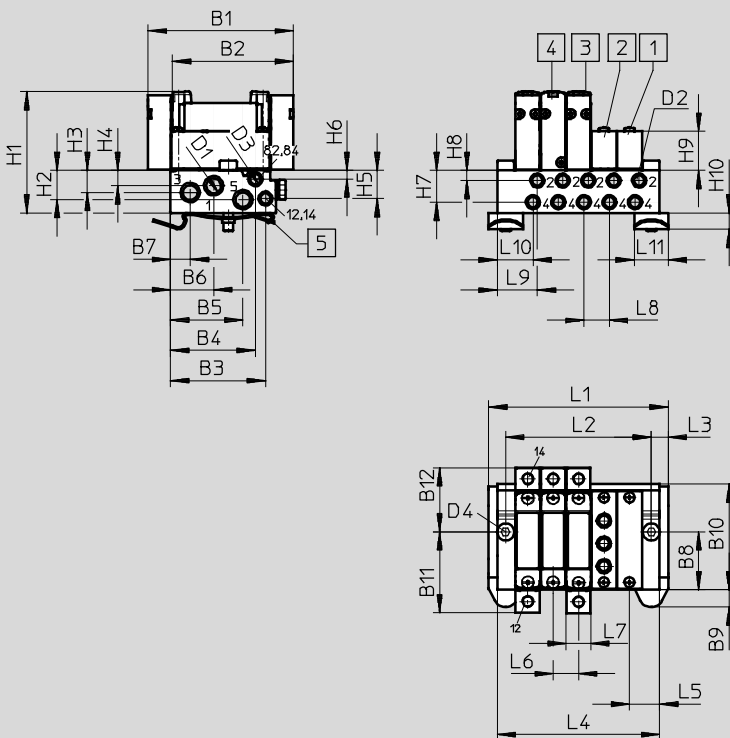

- 1 Blanking plate VABB-L1-10A
- 2 Supply plate VABF-L1-10A-P3A4-M5
- 3 Double pilot pneumatic valve
- 4 Single pilot pneumatic valve
- 5 H-rail mounting (two M4x25 screws to DIN 912 are required)

Type	B1	B2	B3	B4	B5	B6	B7	B8	B9	B10	B11	B12
VABM-L1-10AW-M7	59.9	49.9	39.1	35	29.8	17.8	8.2	24	7.15	43.5	33.45	26.45
	H1	H2	H3	H4	H5	H6	H7	H8	H9	H10	D1	D2
	50	12	9.1	6.3	11.6	3.6	13.1	4.2	16.2	6.8	M7	M5
	D3	D4	L3	L5	L6	L7	L8	L9	L10	L11		
	M5	∅ 4.5	7	12.5	10.5	10.2	10.5	16.5	14.7	11		

Valve positions	2	3	4	5	6	7	8	9	10	12	14	16
L1 [mm]	42.5	53	63.5	74	84.5	96	106.5	116	126.5	147.5	168.5	189.5
L2 [mm]	28.5	39	49.5	60	70.5	81	91.5	102	112.5	133.5	154.5	175.5
L4 [mm]	35.5	46	56.5	67	77.5	89	99.5	109	119.5	140.5	161.5	182.5

Pneumatic valves VUWG-B10A, sub-base valves

Ordering data

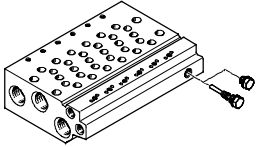



Technical data – Manifold rails ¹⁾									
	Port			CRC	Material ³⁾	Operating pressure [bar]	Max. tightening torque for assembly [Nm]		
	2, 4	1, 3, 5	12/14, 82/84				Valve	H-rail	Wall
	M5	M7	M5	2 ²⁾	Wrought aluminium alloy	-0.9 ... 10	0.45	1.5	1.5

- 1) Blanking plugs are included with the manifold rail.
- 2) Corrosion resistance class 2 according to Festo standard 940 070
Components subject to moderate corrosion stress. Externally visible parts with primarily decorative surface requirements which are in direct contact with a normal industrial environment or media such as coolants or lubricating agents.
- 3) Note on materials: RoHS-compliant

Order code – Manifold rails M3

VABM	-	L1	-	10A	W	-	M7	-	
Manifold assembly parts									Number of valve positions
Manifold rail		VABM							2 to 10, 12, 14 and 16
Valve series							Ports 1, 3, 5		
VUWG		L1					M7	M7	
Valve width									
10 mm				10A					
Rail with ports 1, 2, 3, 4, 5, 12/14, 82/84									
Ports 2 and 4 in M5					W				



Ordering data – Accessories

				Type
Blanking plate				Technical data → Internet: vabb
	For manifold rail 10AW	Incl. screws and seal		VABB-L1-10A
Separator				Technical data → Internet: vabd
	For manifold rail 10AW	Separator for pressure zones		VABD-4.2-B
Supply plate				Technical data → Internet: vabf
	For manifold rail 10AW	Incl. screws and seal		VABF-L1-10A-P3A4-M5
Seals				Technical data → Internet: vabd
	For sub-base valves B10A	10 seals and 20 screws		VABD-L1-10AB-S-M3

Pneumatic valves VUWG-B10, sub-base valves

Technical data

Function
 2x3/2C, 2x3/2U, 2x3/2H
 5/2-way, single pilot
 5/2-way, double pilot
 5/3C, 5/3U, 5/3E

-  - Width 10 mm
 -  - Flow rate
 150 ... 270 l/min

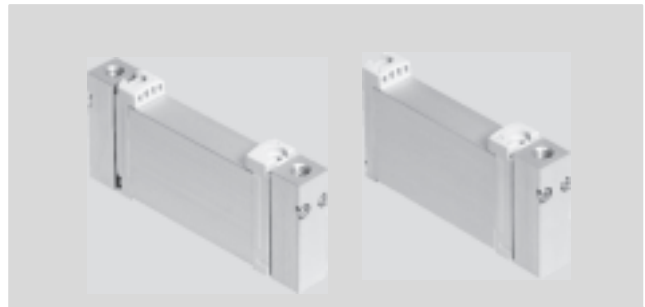

General technical data										
Valve function	T32-A			T32-M			M52-R	B52	M52-M	P53
Normal position	C ¹⁾	U ²⁾	H ⁴⁾	C ¹⁾	U ²⁾	H ⁴⁾	-	-		C ¹⁾ U ²⁾ E ³⁾
Pneumatic spring reset method	Yes			Yes			Yes ⁵⁾	-		No
Mechanical spring reset method	No			No			Yes ⁵⁾	-		Yes
Vacuum operation at port 1	No							Yes		
Design	Piston spool valve									
Sealing principle	Soft									
Actuation type	Pneumatic									
Type of control	Direct									
Pilot air supply	External									
Exhaust function	With flow control									
Type of mounting	On manifold rail									
Mounting position	Any									
Standard nominal flow rate M5	[l/min] 150			130	120	210			180	200
Standard nominal flow rate M7	[l/min] 160			140	130	270			230	250
Switching time on/off	[ms] 4/9			6/7			6/12		-	7/16 8/25
Changeover time	[ms] -						5		-	11
Width	[mm] 10									
Port	1, 3, 5			G1/8						
	2, 4			M5/M7						
	12/14, 82/84			M5						
Product weight	[g] 48			51		45		48	41	48
Corrosion resistance class	CRC			2 ⁶⁾						

1) C = Normally closed
 2) U = Normally open
 3) E = Normally exhausted
 4) H=2x3/2-way valve in one housing with 1x normally closed and 1x normally open
 5) Combined reset method
 6) Corrosion resistance class 2 according to Festo standard 940 070
 Components subject to moderate corrosion stress. Externally visible parts with primarily decorative surface requirements which are in direct contact with a normal industrial environment or media such as coolants or lubricating agents.

Pneumatic valves VUWG-B10, sub-base valves

Technical data

Operating and environmental conditions							
Valve function	T32-A ²⁾	T32-M ³⁾	M52-R ⁴⁾	B52	M52-M ²⁾	P53	
Operating medium	Compressed air according to ISO 8573-1:2010 [7:4:4]						
Note on operating/pilot medium	Lubricated operation possible (in which case lubricated operation will always be required)						
Operating pressure [bar]	1.5 ... 10	-0.9 ... 10	2.5 ... 10	-0.9 ... 10	-0.9 ... 8	-0.9 ... 10	
Pilot pressure ¹⁾ [bar]	1.5 ... 10	2 ... 10	2.5 ... 10	1.5 ... 10	3 ... 10		
Ambient temperature [°C]	-5 ... +60						
Temperature of medium [°C]	-5 ... +60						

- 1) Note operating pressure/pilot pressure graph → page 4
- 2) Pneumatic spring
- 3) Mechanical spring
- 4) Mixed, pneumatic/mechanical spring

Information on materials	
Housing	Wrought aluminium alloy
Seals	HNBR, NBR
Note on materials	RoHS-compliant

Dimensions Download CAD data → www.festo.com

2x3/2-way, 5/2-way and 5/3-way valve

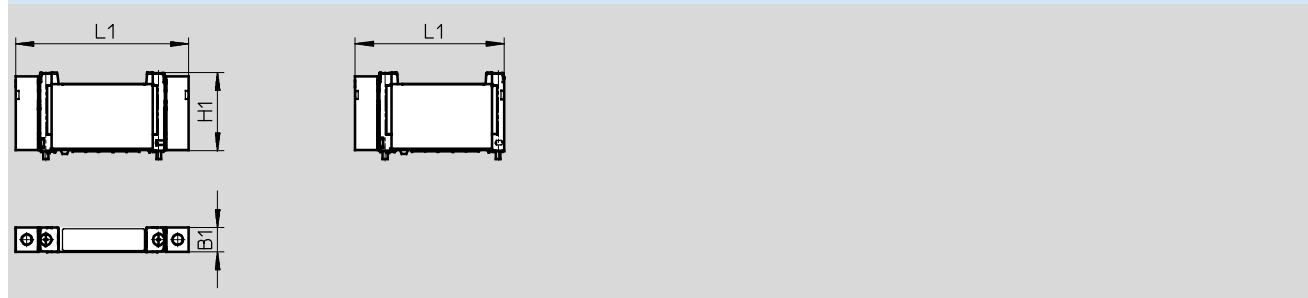

Type	B1	H1	L1
VUWG-B10-...	10.3	32.5	72
VUWG-B10-M52-...			62

- 1) Only with external pilot air

Pneumatic valves VUWG-B10, sub-base valves

Order code

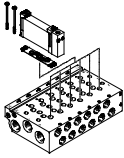
VUWG	-	B	10	-
Valve design				
Sub-base, manifold valve incl. seal and screws		B		
				
Width				
10 mm		10		

- F	
Pneumatic connection	
F	In the manifold rail
Reset method	
A	Pneumatic spring for T32 and M52
M	Mechanical spring for T32 and M52
R	Pneu./mech. spring for T32 and M52
-	With B52 and P53

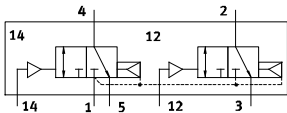
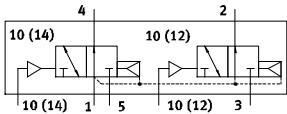
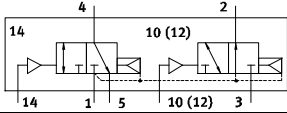
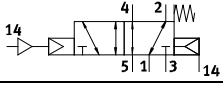
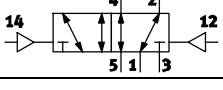
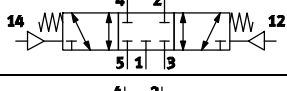
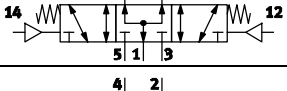
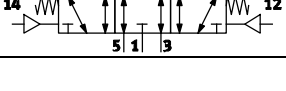
Valve functions	
	T32C
	T32U
	T32H
	M52
	B52
	P53C
	P53U
	P53E

Pneumatic valves VUWG-B10, sub-base valves

Manifold assembly



Sub-base valve for manifold assembly
M5 or M7 connection

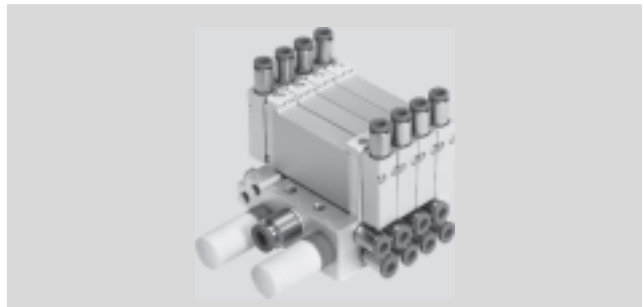

Dimensions

Download CAD data → www.festo.com

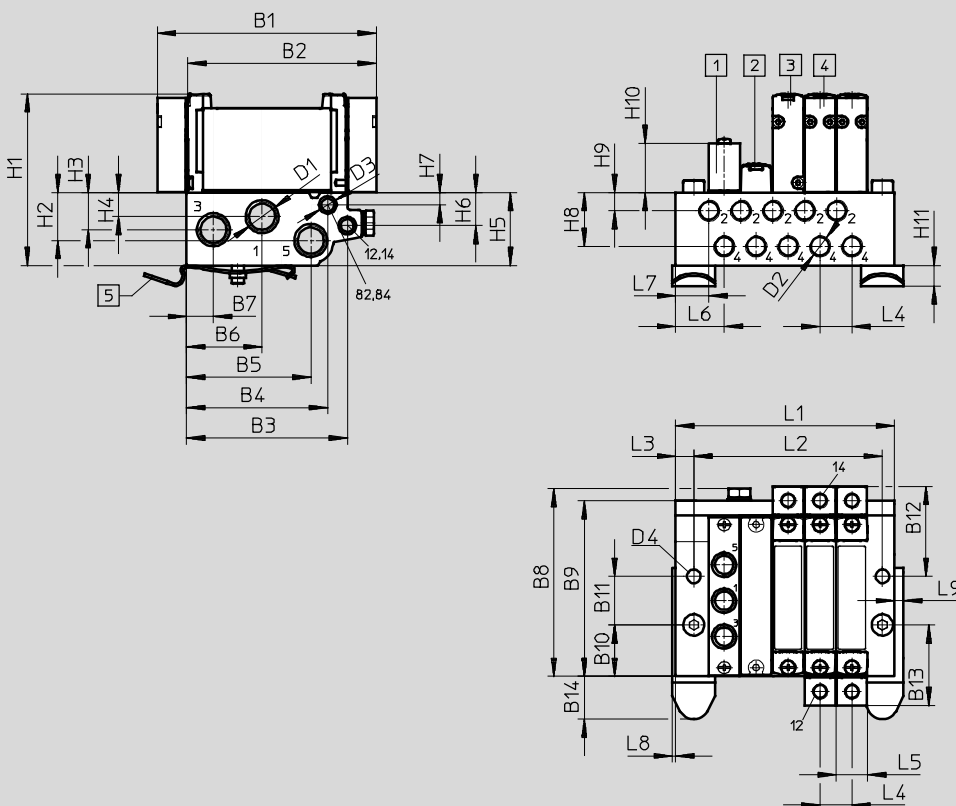

- 1 Supply plate
VABF-L1-10-P3A4-M5
- 2 Blanking plate
VABB-L1-10-W
- 3 Single pilot pneumatic valve,
VUWG-B10-M52
- 4 Double pilot pneumatic valve,
VUWG-B10
- 5 H-rail mounting (two M4x30
screws to DIN 912 are
required)

Type	B1	B2	B3	B4	B5	B6	B7	B8	B9	B10	B11	B12
VABM-L1-...G18	72	62	52.9	46.5	40.9	24.9	8.9	62	57.7	16.9	16	29.5
	B13	B14	D1	D2	D3	D4	H1	H2	H3	H4	H5	H6
	26.5	14.1	G $\frac{1}{8}$	M5	M5	4.5	56.4	15.7	12.2	7.9	23.9	10.8
	H7	H8	H9	H10	H11	L3	L4	L5	L6	L7	L8	L9
	4	17.6	5.9	16.2	6.8	4	10.5	10.3	16	11	1	3
	L8	L9	L15									
	1	3	10									

Valve positions	2	3	4	5	6	7	8	9	10	12	14	16	22
L1 [mm]	48.5	59	69.5	80	90.5	101	111.5	122	132.5	153.5	174.5	195.5	258.5
L2 [mm]	30.5	41	51.5	62	72.5	83	93.5	104	114.5	135.5	156.5	177.5	240.5

Pneumatic valves VUWG-B10, sub-base valves

Ordering data

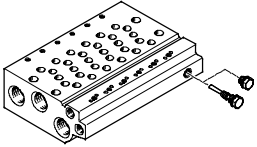

Technical data – Manifold rails ¹⁾									
	Port			CRC	Material ³⁾	Operating pressure [bar]	Max. tightening torque for assembly [Nm]		
	2, 4	1, 3, 5	12/14, 82/84				Valve	H-rail	Wall
	M5 or M7	G $\frac{1}{8}$	M5	2 ²⁾	Wrought aluminium alloy	-0.9 ... 10	0.45	1.5	3

- 1) Blanking plugs are included with the manifold rail.
- 2) Corrosion resistance class 2 according to Festo standard 940 070
Components subject to moderate corrosion stress. Externally visible parts with primarily decorative surface requirements which are in direct contact with a normal industrial environment or media such as coolants or lubricating agents.
- 3) Note on materials: RoHS-compliant

Order code – Manifold rails M5 and M7

VABM	-	L1	-	10	-	G18	-		
Manifold assembly parts				Number of valve positions					
Manifold rail VABM				2 to 10, 12, 14 and 16					
Valve series				Ports 1, 3, 5					
VUWG L1				G18 G $\frac{1}{8}$					
Valve width									
10 mm 10									
Manifold rail with ports 1, 2, 3, 4, 5, 12/14, 82/84									
Ports 2 and 4 in M5				W					
Ports 2 and 4 in M7				HW					

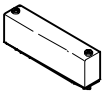
Ordering data – Accessories

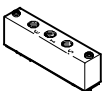
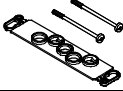
			Type
Blanking plate			Technical data → Internet: vabb
	For manifold rail 10W/10HW, sub-base valves	Incl. screws and seal	VABB-L1-10-W
Separator			Technical data → Internet: vabd
	For manifold rail 10W and 10HW, sub-base valves	Separator for pressure zones	VABD-6-B
Supply plate			Technical data → Internet: vabf
	For manifold rail 10W	Incl. screws and seal	VABF-L1-10-P3A4-M5
	For manifold rail 10HW		VABF-L1-10-P3A4-M7
Seals			Technical data → Internet: vabd
	For sub-base valves B10	10 seals and 20 screws	VABD-L1-10B-S-M7

Pneumatic valves VUWG-B14, sub-base valves

FESTO

Technical data

Function
 2x3/2C, 2x3/2U, 2x3/2H
 5/2-way, single pilot
 5/2-way, double pilot
 5/3C, 5/3U, 5/3E

-  - Width 14 mm

-  - Flow rate
 510 ... 580 l/min



General technical data												
Valve function	T32-A			T32-M			M52-A	B52	M52-M	P53		
Normal position	C ¹⁾	U ²⁾	H ⁴⁾	C ¹⁾	U ²⁾	H ⁴⁾	-	-		C ¹⁾	U ²⁾	E ³⁾
Pneumatic spring reset method	Yes							-		No		
Mechanical spring reset method	No							-		Yes		
Vacuum operation at port 1	No			No			Yes					
Design	Piston spool valve											
Sealing principle	Soft											
Actuation type	Pneumatic											
Type of control	Direct											
Pilot air supply	External											
Exhaust function	With flow control											
Type of mounting	On manifold rail											
Mounting position	Any											
Standard nominal flow rate	[l/min]	540	510	540	430	410	580			540	510	
Switching time on/off	[ms]	6/19			9/13			12/22		-	8/30	
Changeover time	[ms]	-							6		16	
Width	[mm]	14										
Port	1, 3, 5	G1/4										
	2, 4	G1/8										
	12/14, 82/84	M5										
Product weight	[g]	83			83			75	81			
Corrosion resistance class	CRC	2 ⁶⁾										

- 1) C = Normally closed
- 2) U = Normally open
- 3) E = Normally exhausted
- 4) H=2x3/2-way valve in one housing with 1x normally closed and 1x normally open
- 6) Corrosion resistance class 2 according to Festo standard 940 070
 Components subject to moderate corrosion stress. Externally visible parts with primarily decorative surface requirements which are in direct contact with a normal industrial environment or media such as coolants or lubricating agents.

Pneumatic valves VUWG-B14, sub-base valves

Technical data

Operating and environmental conditions						
Valve function	T32-A ²⁾	T32-M ³⁾	M52-A ²⁾	B52	M52-M ³⁾	P53
Operating medium	Compressed air according to ISO 8573-1:2010 [7:4:4]					
Note on operating/pilot medium	Lubricated operation possible (in which case lubricated operation will always be required)					
Operating pressure [bar]	1.5 ... 10	-0.9 ... 10	2.5 ... 10	-0.9 ... 10	-0.9 ... 8	-0.9 ... 10
Pilot pressure ¹⁾ [bar]	1.5 ... 10	2 ... 10	2.5 ... 10	1.5 ... 10	3 ... 10	
Ambient temperature [°C]	-5 ... +60					
Temperature of medium [°C]	-5 ... +50					

- 1) Note operating pressure/pilot pressure graph → page 4
- 2) Pneumatic spring
- 3) Mechanical spring
- 4) Mixed, pneumatic/mechanical spring

Information on materials	
Housing	Wrought aluminium alloy
Seals	HNBR, NBR
Note on materials	RoHS-compliant

Dimensions Download CAD data → www.festo.com

2x3/2-way, 5/2-way and 5/3-way valve

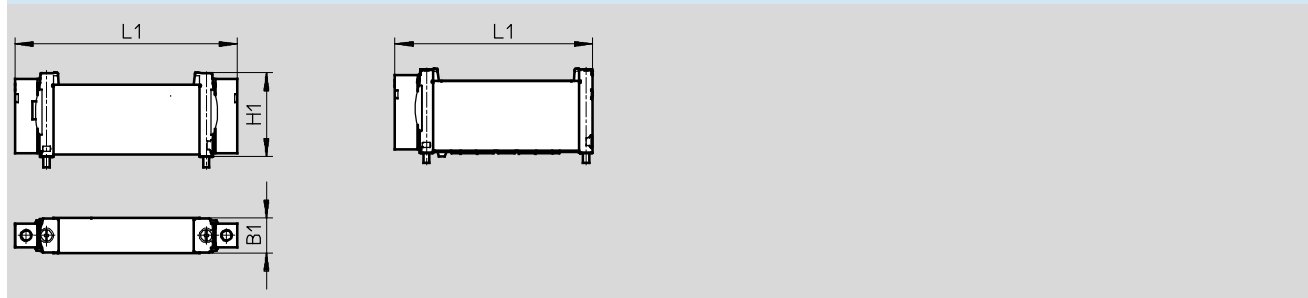

Type	B1	H1	L1
VUWG-B14-...	14.4	34.8	92.6
VUWG-B14-M52-...			82.3

Pneumatic valves VUWG-B14, sub-base valves

Order code

VUWG	-	B	14
Valve design			
Sub-base, manifold valve incl. seal and screws		B	
Width			
10 mm		14	

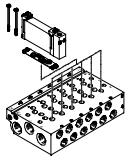

-	F
Pneumatic connection	
F	In the manifold rail
Reset method	
A	Pneumatic spring for T32 and M52
M	Mechanical spring for T32 and M52
-	With B52 and P53

Valve functions	
	T32C
	T32U
	T32H
	M52
	B52
	P53C
	P53U
	P53E

- 1) If Q... is chosen for the pneumatic connection, this also applies to the exhaust ports 3 and 5
- 2) Flow rate applies to 5/2-way individual valve

Pneumatic valves VUWG-B14, sub-base valves

Manifold assembly



Sub-base valve for manifold assembly
G $\frac{1}{8}$ connection

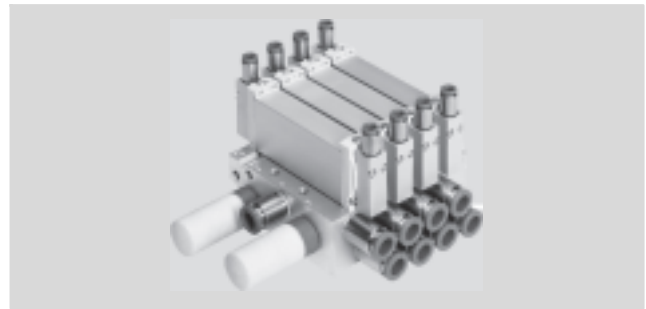

Dimensions

Download CAD data → www.festo.com

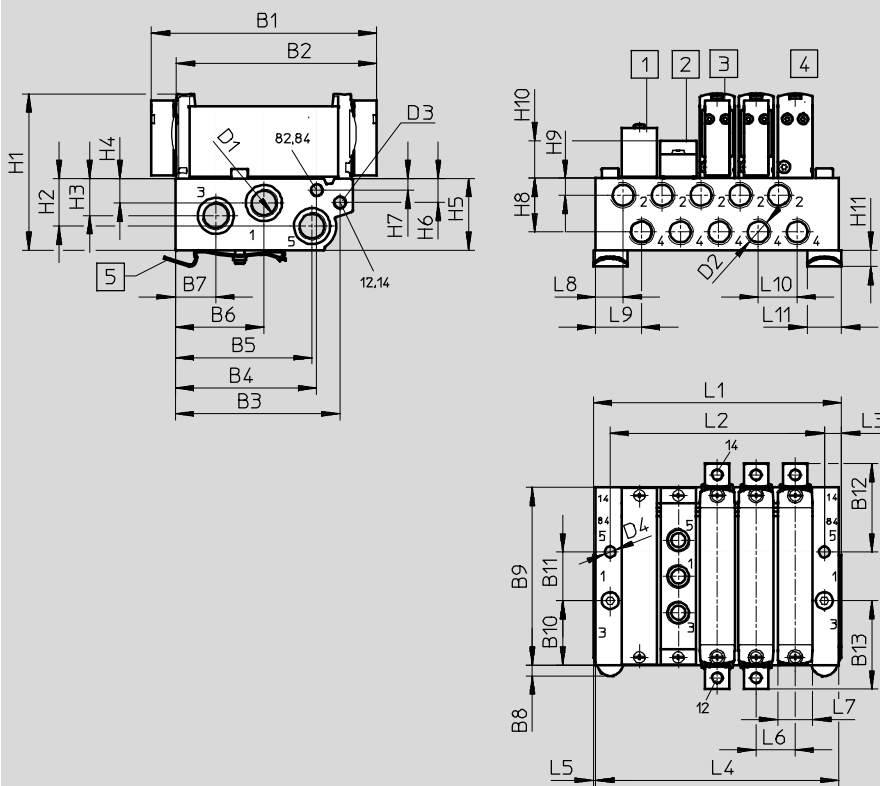

- 1 Blanking plate VABB-L1-14
- 2 Supply plate VABF-L1-14-P3A4-G18
- 3 Double pilot pneumatic valve
- 4 Single pilot pneumatic valve
- 5 H-rail mounting (two M4x25 screws to DIN 912 are required)

Type	B1	B2	B3	B4	B5	B6	B7	B8	B9	B10	B11	B12
VUWG-B14 -...-F- ...	92.6	82.3	67.7	58.2	56.3	36.6	16.7	4.5	72.9	26.5	20	36.3
	B13	D1	D2	D3	D4	H1	H2	H3	H4	H5	H6	H7
	36.3	G $\frac{1}{4}$	G $\frac{1}{8}$	M5	Ø 4.5	64.3	19.6	15.3	10.1	29.5	9.8	4.8
	H8	H9	H10	H11	L3	L5	L6	L7	L8	L9	L10	L11
	22.1	7	15.4	6.8	6	1	16	14.4	11.3	18.5	16	14

Valve positions	2	3	4	5	6	7	8	9	10	12	14	16
L1 [mm]	56.3	72.3	88.3	104.3	120.3	136.3	152.3	168.3	184.3	216.3	248.3	280.3
L2 [mm]	40	56	72	88	104	120	136	152	168	200	232	264
L4 [mm]	54.3	70.3	86.3	102.3	118.3	134.3	150.3	166.3	182.3	214.3	246.6	278.3

Pneumatic valves VUWG-B14, sub-base valves

Ordering data

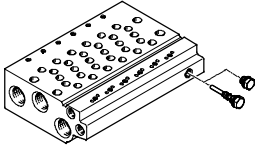



Technical data – Manifold rails ¹⁾									
	Port			CRC	Material ³⁾	Operating pressure [bar]	Max. tightening torque for assembly [Nm]		
	2, 4	1, 3, 5	12/14, 82/84				Valve	H-rail	Wall
	G $\frac{1}{8}$	G $\frac{1}{4}$	M5	2 ²⁾	Wrought aluminium alloy	-0.9 ... 10	0.65	1.5	3

- 1) Blanking plugs are included with the manifold rail.
- 2) Corrosion resistance class 2 according to Festo standard 940 070
Components subject to moderate corrosion stress. Externally visible parts with primarily decorative surface requirements which are in direct contact with a normal industrial environment or media such as coolants or lubricating agents.
- 3) Note on materials: RoHS-compliant

Order code – Manifold rails G $\frac{1}{8}$

VABM	-	L1	-	14	W	-	G14	-	
Manifold assembly parts									
Manifold rail	VABM			Number of valve positions 2 to 10, 12, 14 and 16					
Valve series	Ports 1, 3, 5								
VUWG	L1			G14 G $\frac{1}{4}$					
Valve width	14 mm								
Manifold rail with ports 1, 2, 3, 4, 5, 12/14, 82/84									
Ports 2 and 4 in G $\frac{1}{8}$									W

Ordering data – Accessories

			Type	
Blanking plate				Technical data → Internet: vabb
	For manifold rail 14W, sub-base valves	Incl. screws and seal	VABB-L1-14	
Separator				Technical data → Internet: vabd
	For manifold rail 14W, sub-base valves	Separator for pressure zones	VABD-10-B	
Supply plate				Technical data → Internet: vabf
	For manifold rail 14W	Incl. screws and seal	VABF-L1-14-P3A4-G18	
Seals				Technical data → Internet: vabd
	For sub-base valves B14	10 seals and 20 screws	VABD-L1-14B-S-G18	

Pneumatic valves VUWG-B18, sub-base valves

FESTO

Technical data

Function

2x3/2C, 2x3/2U, 2x3/2H

5/2-way, single pilot

5/2-way, double pilot

5/3C, 5/3U, 5/3E

 Width 18 mm

 Flow rate
900 ... 1,000 l/min

General technical data													
Valve function	T32-A			T32-M			M52-R	B52	M52-M	P53			
Normal position	C ¹⁾	U ²⁾	H ⁴⁾	C ¹⁾	U ²⁾	H ⁴⁾	–	–		C ¹⁾	U ²⁾	E ³⁾	
Pneumatic spring reset method	Yes							–		No			
Mechanical spring reset method	No							–		Yes			
Vacuum operation at port 1	No			No			Yes						
Design	Piston spool valve												
Sealing principle	Soft												
Actuation type	Pneumatic												
Type of control	Direct												
Pilot air supply	External												
Exhaust function	With flow control												
Type of mounting	On manifold rail												
Mounting position	Any												
Standard nominal flow rate	[l/min]	900			1,000			950					
Switching time on/off	[ms]	12/25			14/22			14/30			–	12/45	12/45
Changeover time	[ms]	–							10		–		25
Width	[mm]	18											
Port	1, 3, 5	G1/4											
	2, 4	G1/8											
	12/14, 82/84	M5											
Product weight	[g]	83			83			75		81			
Corrosion resistance class	CRC	2 ⁶⁾											

1) C = Normally closed

2) U = Normally open

3) E = Normally exhausted

4) H=2x3/2-way valve in one housing with 1x normally closed and 1x normally open

6) Corrosion resistance class 2 according to Festo standard 940 070

Components subject to moderate corrosion stress. Externally visible parts with primarily decorative surface requirements which are in direct contact with a normal industrial environment or media such as coolants or lubricating agents.

Pneumatic valves VUWG-B18, sub-base valves

Technical data

Operating and environmental conditions							
Valve function	T32-A ²⁾	T32-M ³⁾	M52-R ⁴⁾	B52	M52-M ³⁾	P53	
Operating medium	Compressed air according to ISO 8573-1:2010 [7:4:4]						
Note on operating/pilot medium	Lubricated operation possible (in which case lubricated operation will always be required)						
Operating pressure [bar]	1.5 ... 10	-0.9 ... 10	2.5 ... 10	-0.9 ... 10	-0.9 ... 8	-0.9 ... 10	
Pilot pressure ¹⁾ [bar]	1.5 ... 10	2 ... 10	2.5 ... 10	1.5 ... 10	3 ... 10		
Ambient temperature [°C]	-5 ... +60		-5 ... +60				
Temperature of medium [°C]	-5 ... +50		-5 ... +50				

- 1) Note operating pressure/pilot pressure graph → page 4
- 2) Pneumatic spring
- 3) Mechanical spring
- 4) Mixed, pneumatic/mechanical spring

Information on materials	
Housing	Wrought aluminium alloy
Seals	HNBR, NBR
Note on materials	RoHS-compliant

Dimensions Download CAD data → www.festo.com

2x3/2-way, 5/2-way and 5/3-way valve

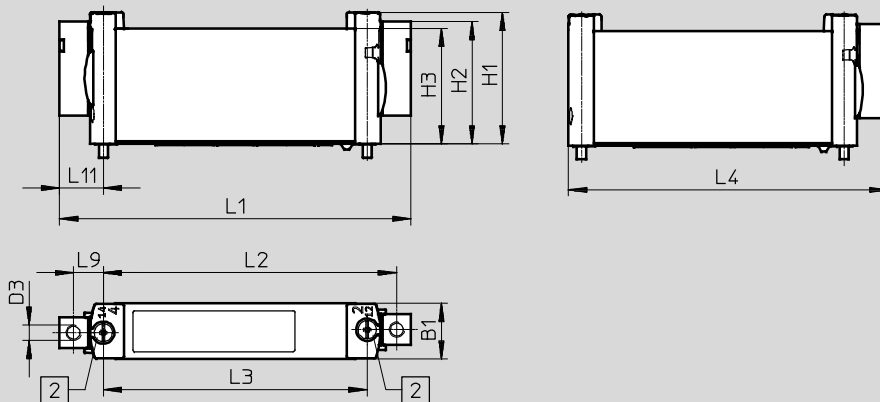

 Mounting screw

Type	B1	D3	H1	H2	H3	L1	L2	L3	L4	L9	L11
VUWG-B18...	18.3	M5	43.1	40	37.8	115	96.1	86.4	105	9.7	14.3

Pneumatic valves VUWG-B18, sub-base valves

Order code

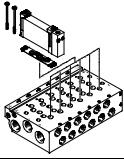
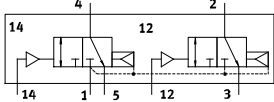
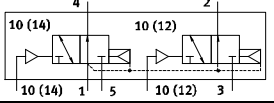
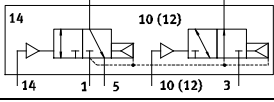
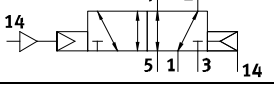
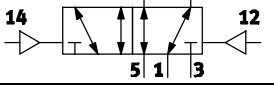
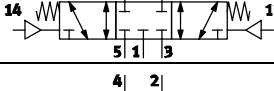
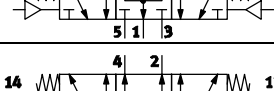
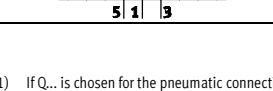
VUWG	-	B	18	-
Valve design				
Sub-base, manifold valve incl. seal and screws		B		
				
Width				
18 mm		18		
Valve functions				
				T32C
				T32U
				T32H
				M52
				B52
				P53C
				P53U
				P53E

-	F
Pneumatic connection	
F	In the manifold rail
Reset method	
A	Pneumatic spring for T32 and M52
M	Mechanical spring for T32 and M52
R	Pneu./mech. spring for M52
-	With B52 and P53

- 1) If Q... is chosen for the pneumatic connection, this also applies to the exhaust ports 3 and 5
- 2) Flow rate applies to 5/2-way individual valve

Pneumatic valves VUWG-B18, sub-base valves

Manifold assembly

Sub-base valve for manifold assembly
G $\frac{3}{8}$ connection

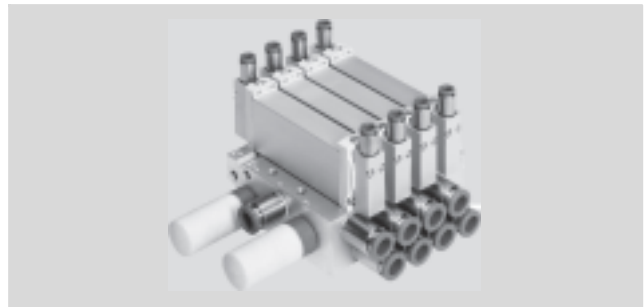

Dimensions

Download CAD data → www.festo.com

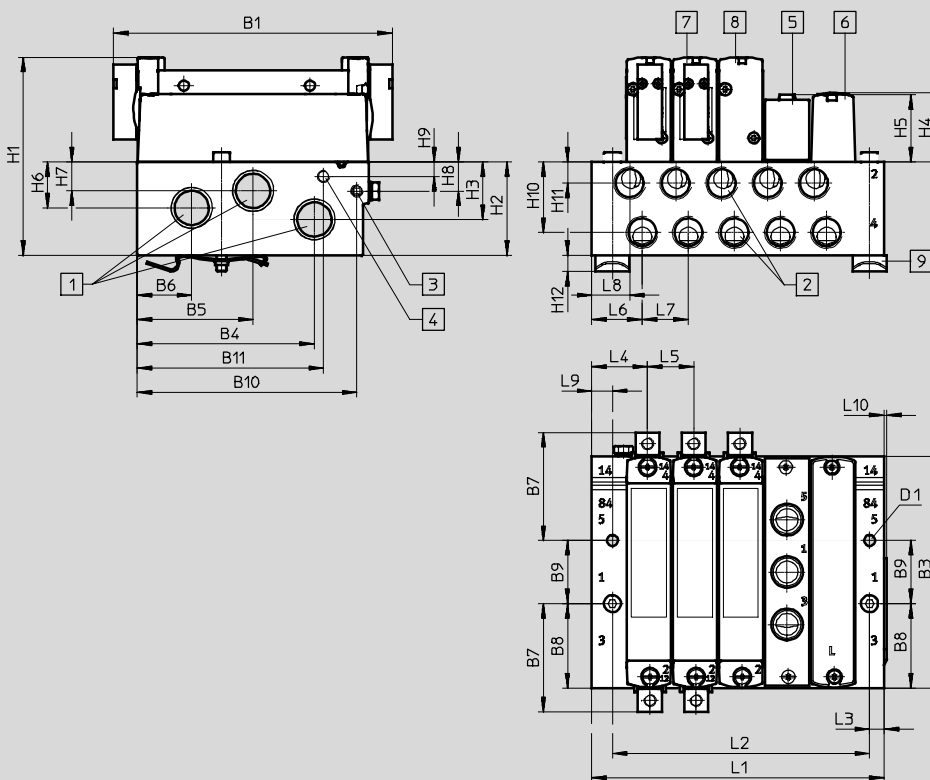

- 1 Ports 1, 3 and 5: G $\frac{3}{8}$ (at both ends)
- 2 Ports 2 and 4: G $\frac{1}{4}$
- 3 Port 12/14 for external pilot air: M5
- 4 Port 82/84 for external pilot air: M5
- 5 Supply plate VABF-L1-18-P3A4-G14
- 6 Blanking plate VABB-L1-18
- 7 Double pilot pneumatic valve
- 8 Single pilot pneumatic valve
- 9 H-rail mounting (two M4x40 screws to DIN 912 are required for mounting)

Type	B1	B3	B4	B5	B6	B7	B8	B9	B10	B11	D1	H1
VUWG-B14 -...-F- ...	115	95.6	73.1	47.8	22.5	51.7	34.8	26	90.6	76.8	4.5	81.6
	H2	H3	H4	H5	H6	H7	H8	H9	H10	H11	H12	L3
	38.5	23.8	28.4	27.6	19	12	12.1	6.1	29.1	8.8	6.5	6
	L4	L5	L6	L7	L8	L9	L10					
	23	19	20.8	19	15.6	8.5						

Valve positions	2	3	4	5	6	7	8	9	10	12	14	16
L1 [mm]	56.3	72.3	88.3	104.3	120.3	136.3	152.3	168.3	184.3	216.3	248.3	280.3
L2 [mm]	40	56	72	88	104	120	136	152	168	200	232	264
L4 [mm]	54.3	70.3	86.3	102.3	118.3	134.3	150.3	166.3	182.3	214.3	246.6	278.3

Pneumatic valves VUWG-B18, sub-base valves

Ordering data

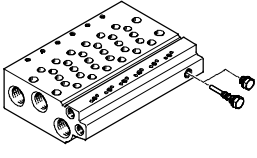



Technical data – Manifold rails ¹⁾									
	Port			CRC	Material ³⁾	Operating pressure [bar]	Max. tightening torque for assembly [Nm]		
	2, 4	1, 3, 5	12/14, 82/84				Valve	H-rail	Wall
	G $\frac{1}{4}$	G $\frac{3}{8}$	M5	2 ²⁾	Wrought aluminium alloy	-0.9 ... 10	0.65	1.5	3

- 1) Blanking plugs are included with the manifold rail.
- 2) Corrosion resistance class 2 according to Festo standard 940 070
Components subject to moderate corrosion stress. Externally visible parts with primarily decorative surface requirements which are in direct contact with a normal industrial environment or media such as coolants or lubricating agents.
- 3) Note on materials: RoHS-compliant

Order code – Manifold rails G $\frac{1}{4}$

VABM	-	L1	-	18	W	-	G38	-	
Manifold assembly parts								Number of valve positions	
Manifold rail		VABM						2 to 10, 12, 14 and 16	
Valve series								Ports 1, 3, 5	
VUWG		L1				G38		G $\frac{3}{8}$	
Valve width									
18 mm				18					
Manifold rail with ports 1, 2, 3, 4, 5, 12/14, 82/84									
Ports 2 and 4 in G $\frac{1}{4}$									
W									







Ordering data – Accessories

			Type	
Blanking plate				Technical data → Internet: vabb
	For manifold rail 18W, sub-base valves	Incl. screws and seal	VABB-L1-18	
Separator				Technical data → Internet: vabd
	For manifold rail 14W, sub-base valves	Separator for pressure zones	VABD-14-B	
Supply plate				Technical data → Internet: vabf
	For manifold rail 14W	Incl. screws and seal	VABF-L1-18-P3A4-G14	
Seals				Technical data → Internet: vabd
	For sub-base valves B14	10 seals and 20 screws	VABD-L1-18B-S-G14	

Pneumatic valves VUWG

Accessories

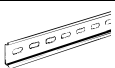
FESTO

Ordering data			
	Description		Type
Blanking plug			Technical data → Internet: b
	For manifold rail and valve		B-M5-B
	For manifold rail		B-M7
			B-1/8
			B-1/4
Blanking plug			Technical data → Internet: qsc
	For valve		QSC-F-G1/8-I
Reducing nipple			
			D-M5I-M7A-ISK
Fittings			Technical data → Internet: qs
	For tubing Ø 3 mm	100 pieces	QSM-M3-3-I-R-100
	For tubing Ø 4 mm		QSM-M3-4-I-R-100
	For tubing Ø 3 mm		QSM-M5-3-I-R100
	For tubing Ø 4 mm		QSM-M5-4-I-R100
	For tubing Ø 6 mm		QSM-M5-6-I-R100
	For tubing Ø 6 mm		QSM-M7-6-I-R100
	For tubing Ø 3 mm	10 pieces	QSM-M5-3-I
	For tubing Ø 4 mm		QSM-M5-4-I
	For tubing Ø 6 mm		QSM-M5-6-I
	For tubing Ø 4 mm		QSM-M7-4-I
	For tubing Ø 6 mm		QSM-M7-6-I
	For tubing Ø 4 mm	10 pieces	QS-G1/8-4-I
	For tubing Ø 6 mm		QS-G1/8-6-I
	For tubing Ø 8 mm		QS-G1/8-8-I
	For tubing Ø 10 mm		QS-G1/8-10-I
	For tubing Ø 6 mm	10 pieces	QS-G1/4-6-I
	For tubing Ø 8 mm		QS-G1/4-8-I
	For tubing Ø 10 mm		QS-G1/4-10-I
Silencer			Technical data → Internet: uc
	For thread M5		U-M5
	For thread M7		UC-M7
	For thread G1/8		UC-1/8
	For thread G1/4		UC-1/4
H-rail			Technical data → Internet: nrh
	To EN 60715, 35 x 7.5 (WxH)	2 m	NRH-35-2000
H-rail mounting			Technical data → Internet: vame
	-	2 pieces	VAME-T-M4