

# Radial grippers DHR5



# Radial grippers DHRS

Key features

## At a glance

### General information

- Lateral gripper jaw support for high torque loads
- Self-centring
- Gripper jaw centring options
- Max. repetition accuracy
- Gripping force retention
- Internal fixed flow control
- Wide range of options for mounting on drive units

- Sensor technology:
  - Adaptable position sensor for the small gripper sizes
  - Integratable proximity sensors for the medium and large gripper sizes

### Flexible range of applications

- Can be used as a double-acting and single-acting gripper
- Compression spring for supplementary or retaining gripping forces
- Suitable for external and internal gripping

## The technology in detail

### Gripper closed

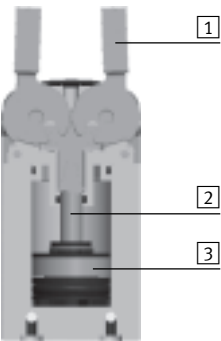

### Gripper open

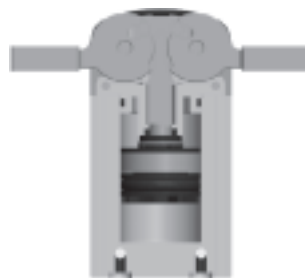

- 1 Gripper jaw
- 2 Slotted guide plate
- 3 Piston with magnet

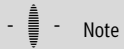

Note

Gripper selection  
sizing software  
→ [www.festo.com](http://www.festo.com)

## Position sensing/force control

### With position transmitter SMAT-8M



- Infinite position sensing possible
- Analogue output 0 ... 10 V

### With proportional pressure regulator VPPM



- Infinite adjustment of the gripping force possible
- Setpoint input
    - 0 ... 10 V
    - 4 ... 20 mA

### With proximity sensor SMT-8G



- Multiple positions can be sensed:
- Open
  - Closed
  - Workpiece gripped

# Radial grippers DHRS

Key features

## Supply ports

At the side

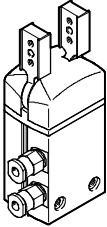

## Mounting options

At the side

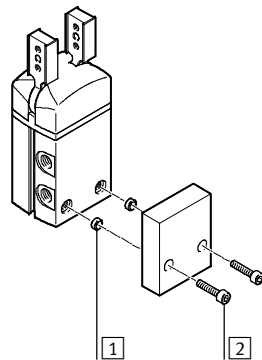
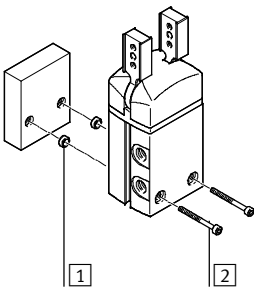

From underneath

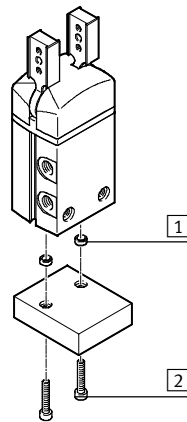

- 1 Centring sleeves
- 2 Mounting screws

## Mounting options for external gripper fingers

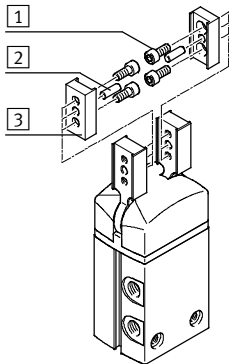

- 1 Mounting screws
- 2 Centring pins
- 3 Gripper fingers

### Note

These grippers are not designed for the following or similar sample applications:

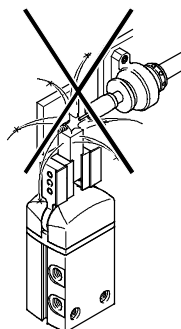

- Welding spatter

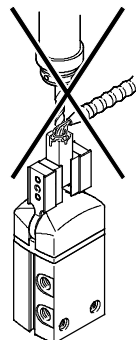

- Machining
- Aggressive media

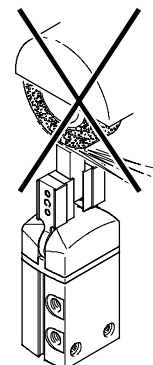

- Grinding dust

# Radial grippers DHRS

Peripherals overview

**Peripherals overview**

DHRS-10

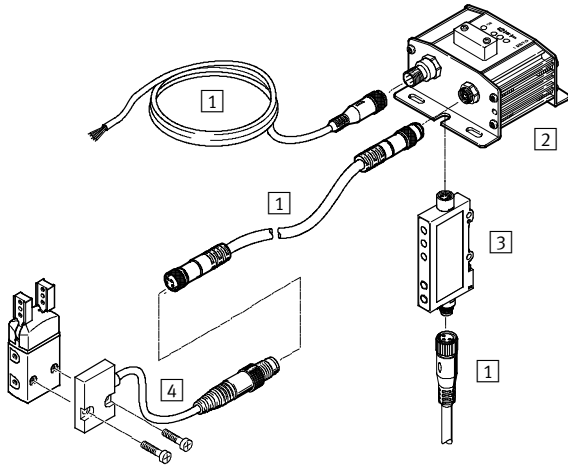

DHRS-16 ... 40

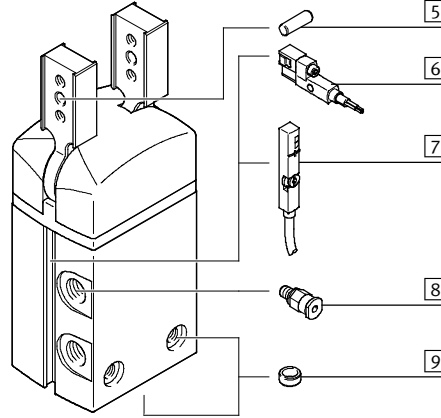

**System product for handling and assembly technology**

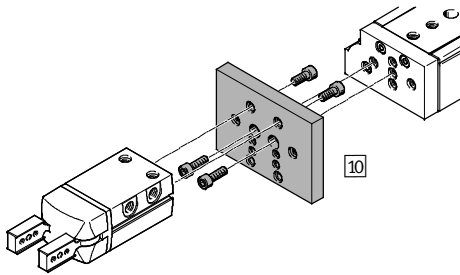

**Proportional pressure regulator VPPM**

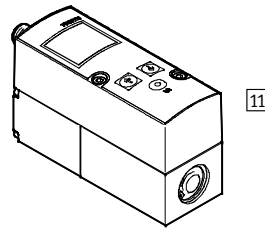

## Radial grippers DHRS

Peripherals overview

Accessories			
	Type	Brief description	→ Page/Internet
1	Connecting cable NEBU	For connecting evaluation unit and signal converter	21
2	Evaluation unit SMH-AE1	<ul style="list-style-type: none"> <li>For evaluating signals for position sensor SMH-S1</li> <li>For size 10</li> </ul>	21
3	Signal converter SVE4	<ul style="list-style-type: none"> <li>For evaluating signals for position sensor SMH-S1</li> <li>For size 10</li> </ul>	21
4	Position sensor SMH-S1	<ul style="list-style-type: none"> <li>Adaptable and integratable sensor technology, for sensing the piston position</li> <li>For size 10</li> </ul>	21
5	Centring pin	For centring the gripper fingers on the gripper jaws	–
6	Proximity sensor SMT-8G	<ul style="list-style-type: none"> <li>For sensing the piston position</li> <li>Proximity sensor does not project past the housing at the bottom</li> <li>For size 16 ... 40</li> </ul>	22
7	Position transmitter SMAT-8M	<ul style="list-style-type: none"> <li>Continuously senses the position of the piston. Has an analogue output with an output signal in proportion to the piston position</li> <li>For size 16 ... 40</li> </ul>	22
8	Push-in fitting QS	For connecting compressed air tubing with standard O.D.	quick star
9	Centring sleeve ZBH	<ul style="list-style-type: none"> <li>For centring the gripper during mounting</li> <li>The scope of delivery of the gripper includes 2 centring sleeves</li> </ul>	21
10	Adapter kit HMSV, HAPG, HAPS, HMVA	Connecting plate between drive and gripper	16
11	Proportional pressure regulator VPPM	For infinite adjustment of the gripping force	vppm

# Radial grippers DHRS

Type codes

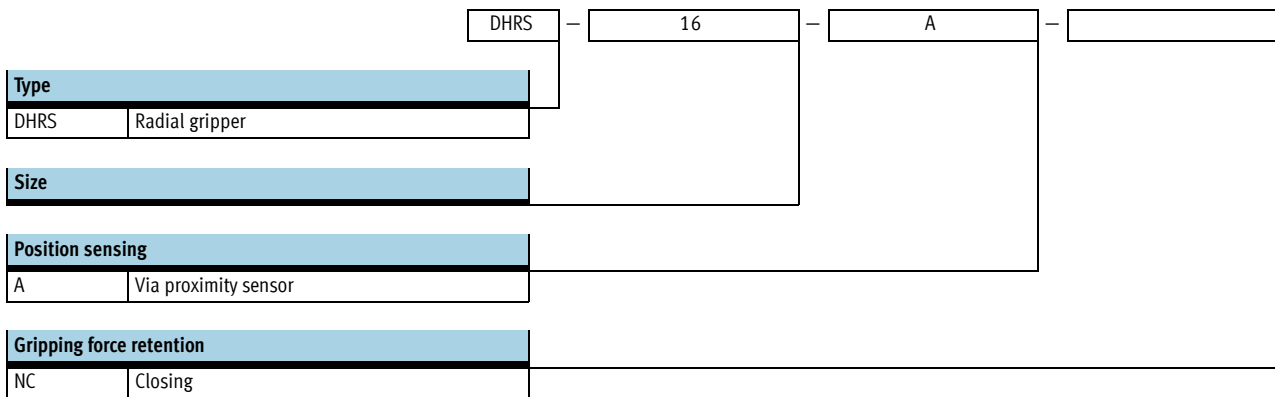

# Radial grippers DHRS

Technical data

Function  
Double-acting  
DHRS-...-A

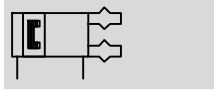

-  Size  
10 ... 40 mm
-  Opening angle  
180°

-  www.festo.com

Function – Variants  
Single-acting or  
with gripping force retention ...  
... closing DHRS-...-NC

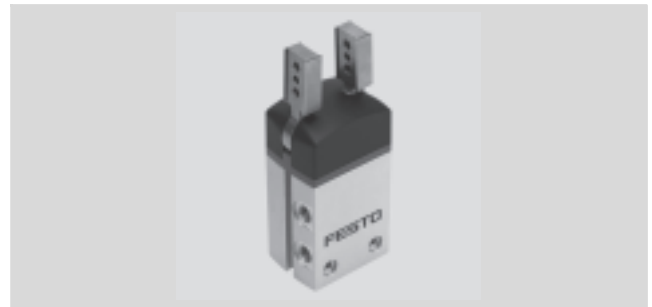

General technical data					
Size	10	16	25	32	40
Design	Forced motion sequence				
Mode of operation	Double-acting				
Gripper function	Radial				
Guide	Plain-bearing guide				
Gripping force retention	–	NC	NC	NC	NC
Number of gripper jaws	2				
Opening angle per gripper jaw	[°] 90				
Pneumatic connection	M3	M3	M5	G1/8	G1/8
Repetition accuracy <sup>1)</sup>	[mm] ≤ 0.1				
Max. interchangeability	[mm] ≤ ±0.2				
Max. operating frequency	[Hz] 4		3		2
Rotational symmetry	[mm] < Ø 0.2				
Position sensing	Via position sensor		Via proximity sensor, position transmitter		
Type of mounting	Via through-hole and centring sleeve				
	Via female thread and centring sleeve				
Mounting position	Any				

1) End-position drift under constant conditions of use with 100 consecutive strokes in the direction of movement of the gripper jaws

Operating and environmental conditions					
Size	10	16	25	32	40
Min. operating pressure					
DHRS-...-A	[bar] 2				
DHRS-...-A-NC	[bar] –	4			
Max. operating pressure	[bar] 8				
Operating medium	Compressed air in accordance with ISO 8573-1:2010 [7:4:4]				
Note on operating/pilot medium	Operation with lubricated medium possible (in which case lubricated operation will always be required)				
Ambient temperature <sup>1)</sup>	[°C] +5 ... +60				
Corrosion resistance class CRC <sup>2)</sup>	1				

1) Note operating range of proximity sensors

2) Corrosion resistance class 1 according to Festo standard 940 070

Components subject to low corrosion stress. Transport and storage protection. Parts that do not have primarily decorative surface requirements, e.g. in internal areas that are not visible or behind covers.

Weight [g]					
Size	10	16	25	32	40
DHRS-...-A	44	114	270	480	829
DHRS-...-A-NC	–	118	277	490	844

# Radial grippers DHRS

Technical data

## Materials

Sectional view

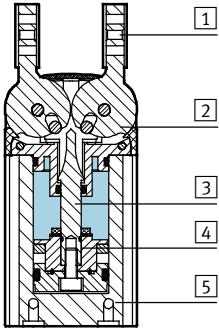

Radial gripper

1	Gripper jaw	High-alloy stainless steel
2	Cover cap	Polyamide
3	Slotted guide plate	Tempered steel
4	Piston	Polyacetal
5	Housing	Hard anodised wrought aluminium alloy
-	Seals	Nitrile rubber
-	Note on materials	Free of copper and PTFE RoHS-compliant

## Total gripping torque [Ncm] at 6 bar

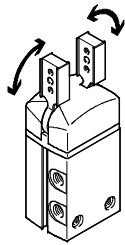

The gripping torque is not constant within the opening angle → 12.

Size	10	16	25	32	40	
DHRS-...-A	Opening	21	62	233	423	725
	Closing	15	55	215	390	660

## Static characteristic load values at the gripper jaws

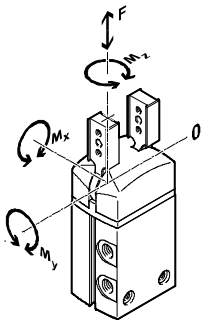

The indicated permissible forces and torques apply to a single gripper jaw. They include the lever arm, additional applied loads due to the workpiece or external gripper fingers and

acceleration forces occurring during movement.

The zero coordinate line (gripper jaw guide) must be taken into consideration for the calculation of torques.

Size		10	16	25	32	40
Max. permissible force $F_z$	[N]	30	40	75	120	200
Max. permissible torque $M_x$	[Nm]	0.8	1.3	3.2	6.2	14
Max. permissible torque $M_y$	[Nm]	0.8	1.3	3.2	6.2	14
Max. permissible torque $M_z$	[Nm]	0.8	1.3	3.2	6.2	14

## Mass moment of inertia [ $\text{kgm}^2 \times 10^{-4}$ ]

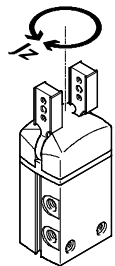

Mass moment of inertia of the radial gripper in relation to the central axis, without external gripper fingers, without load.

Size	10	16	25	32	40
DHRS-...-A	0.03	0.14	0.69	1.66	4.18
DHRS-...-A-NC	-	0.15	0.71	1.69	4.24



# Radial grippers DHRS

Technical data

FESTO

## Opening and closing times [ms] at 6 bar

Without external gripper fingers

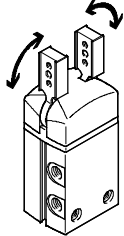

The indicated opening and closing times [ms] were measured at room temperature at an operating pressure of 6 bar with horizontally mounted grippers without additional gripper

fingers (average values). The grippers must be throttled for greater applied loads. Opening and closing times must then be adjusted accordingly.

Size		10	16	25	32	40
Without external gripper fingers						
DHRS-...-A	Opening	35	61	102	111	113
	Closing	91	63	105	119	142
DHRS-...-A-NC	Opening	-	75	150	131	151
	Closing	-	43	96	88	110

## Opening and closing times t to be set at 6 bar as a function of mass moment of inertia of the gripper fingers

DHRS-10

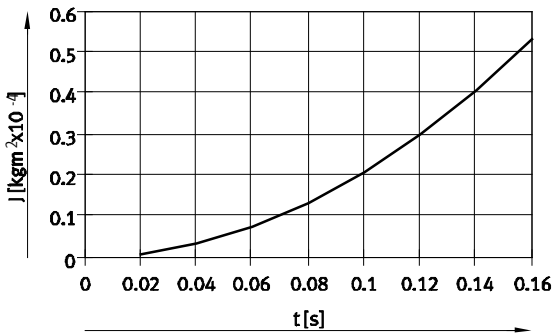

DHRS-16

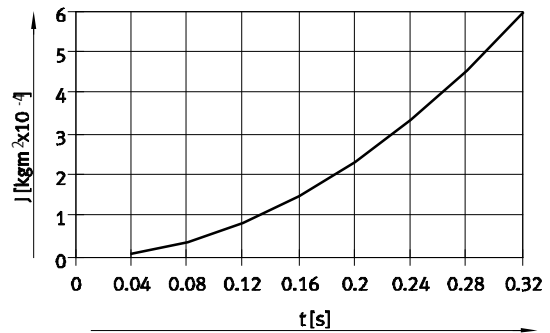

DHRS-25

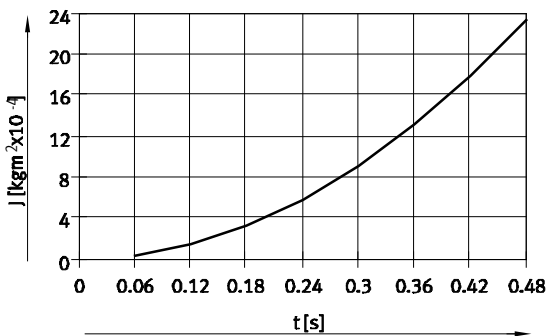

DHRS-32

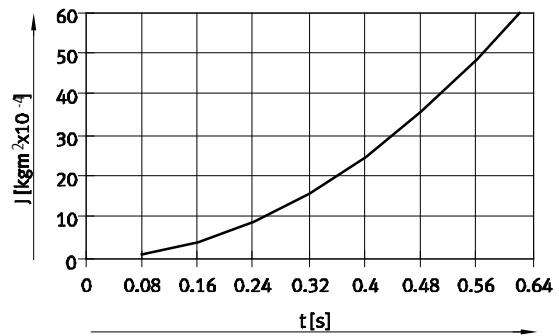

DHRS-40

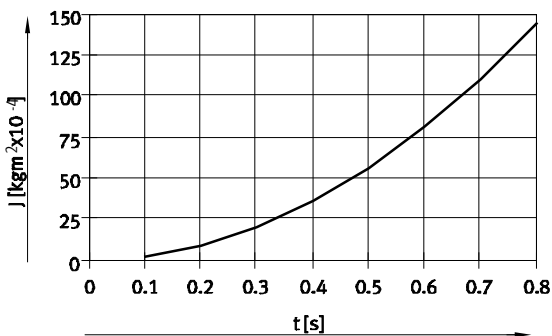

# Radial grippers DHRS

Technical data



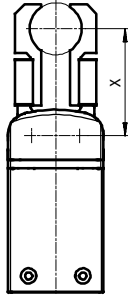

## Gripping force $F_H$ per gripper jaw as a function of operating pressure and lever arm $x$

The gripping forces as a function of operating pressure and lever arm can be determined from the following graphs.

The gripping torque is not constant within the opening angle  $\rightarrow 12$ .



 Note  
Gripper selection sizing software  
[www.festo.com](http://www.festo.com)

-  2 bar
-  4 bar
-  6 bar
-  8 bar

### External gripping (closing)

DHRS-10

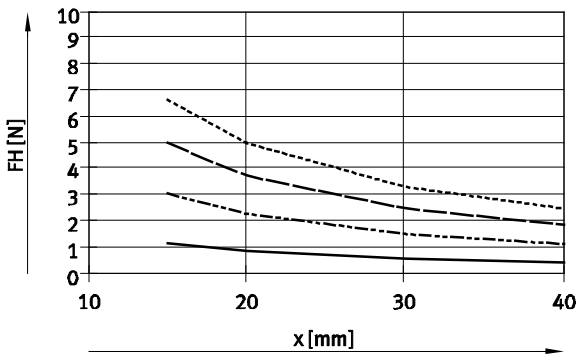

DHRS-16

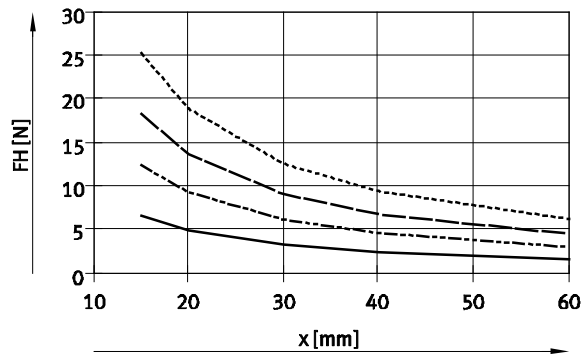

DHRS-25

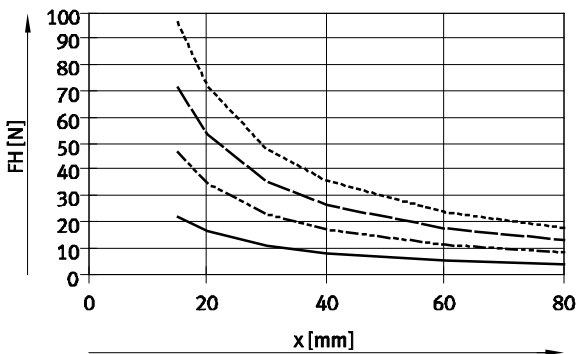

DHRS-32

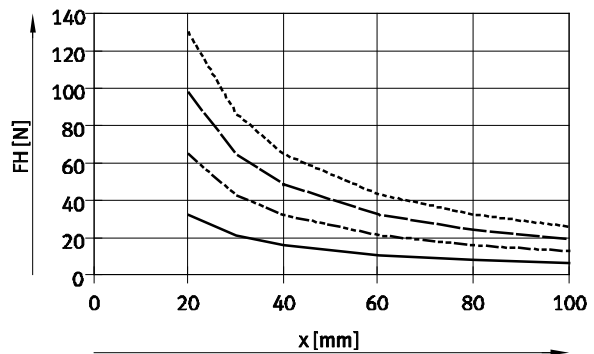

DHRS-40

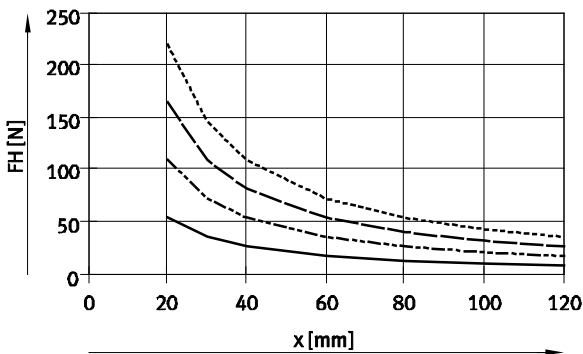

# Radial grippers DHRS

Technical data

## Gripping force $F_H$ per gripper jaw as a function of operating pressure and lever arm $x$

The gripping forces as a function of operating pressure and lever arm can be determined from the following graphs.

The gripping torque is not constant within the opening angle  $\rightarrow$  12.

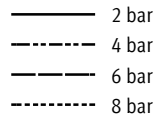
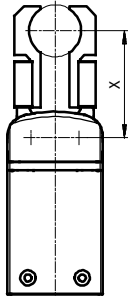

 Note  
 Gripper selection  
 sizing software  
[www.festo.com](http://www.festo.com)

### Internal gripping (opening)

DHRS-10

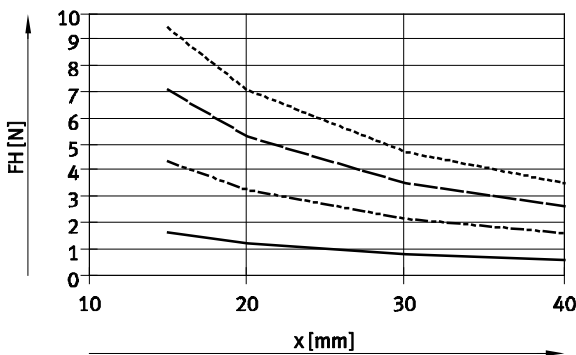

DHRS-16

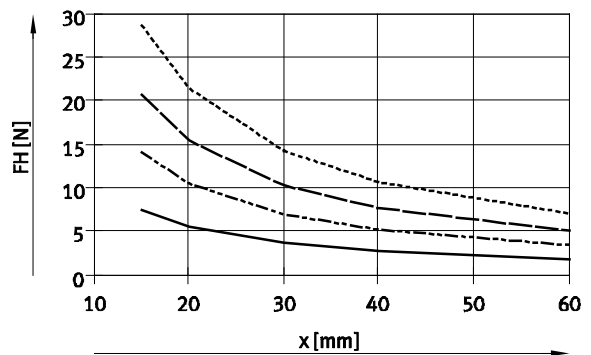

DHRS-25

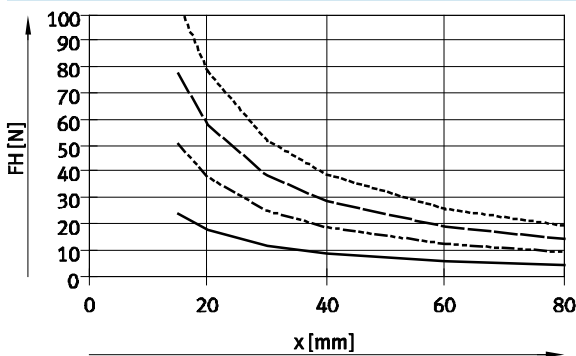

DHRS-32

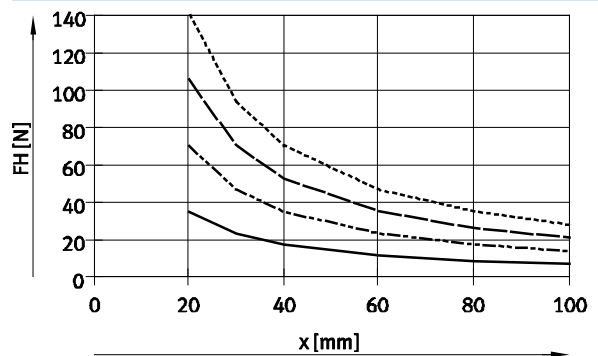

DHRS-40

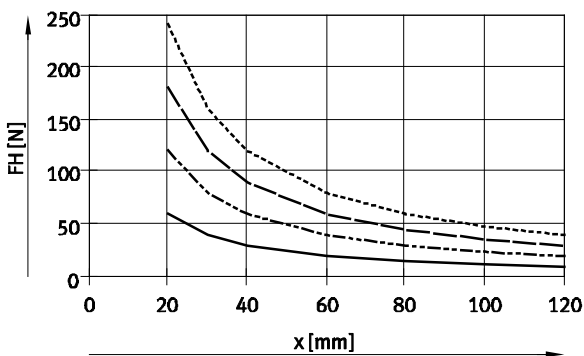

# Radial grippers DHRS

Technical data

## Gripping force $F_H$ per gripper jaw at 6 bar as a function of lever arm $x$ and eccentricity $a$ and $b$

The following formula must be used to calculate the lever arm  $x$  with eccentric gripping:

$$x = \sqrt{a^2 + b^2}$$

The gripping force  $F_H$  can be read from the graphs (→ 10/11) using the calculated value  $x$ .

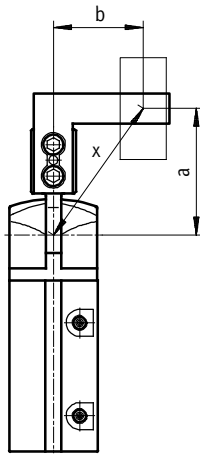

### Calculation example

Given:  
 Distance  $a = 25$  mm  
 Distance  $b = 20$  mm  
 To be calculated:  
 The gripping force at 6 bar, with a DHRS-16, used as an external gripper

Procedure:  
 Calculating the lever arm  $x$   
 $x = \sqrt{25^2 + 20^2}$   
 $x = 32$  mm

The graph (→ 10) gives a value of  $F_H = 8$  N for the gripping force.

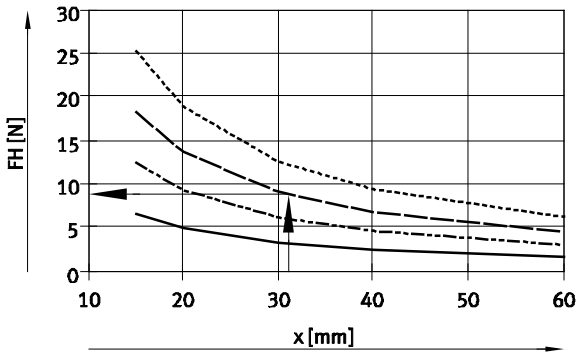

### Torque curve $M$ as a function of opening angle $\alpha$

The drive principle of the gripper jaws means that the torque is not constant within the opening angle. The percentage of torque available in each case can be seen in the graph. An opening angle of  $0^\circ$  means a parallel gripper jaw position.

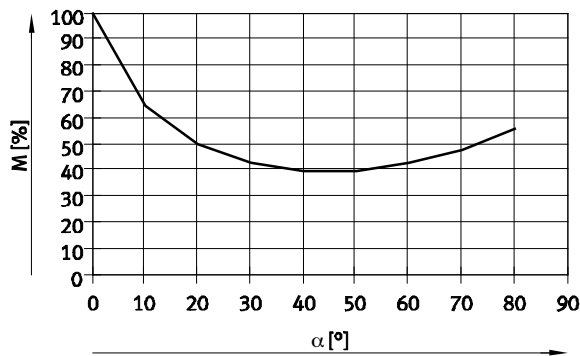

# Radial grippers DHRS

Technical data

## Spring torque $M_F$ as a function of opening angle $\alpha$

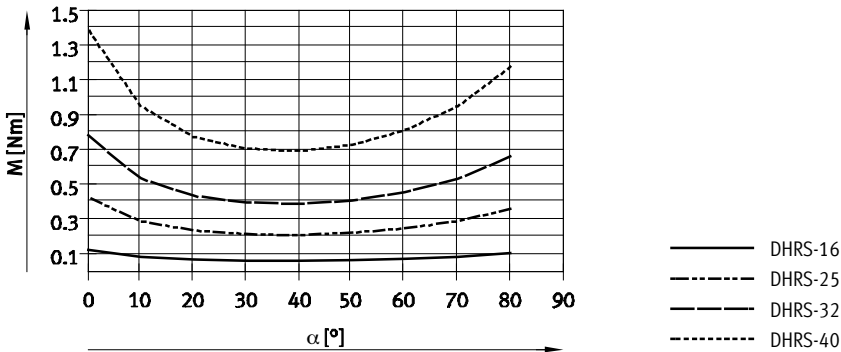

## Determination of the actual gripping torques $M_{Gtotal}$ for DHRS...-NC as a function of application

The radial gripper with integrated spring type DHRS...-NC (closing gripping force retention) can be used as:

- single-acting grippers
- grippers with supplementary gripping force and
- grippers with gripping force retention depending on requirements.

In order to calculate the available gripping torque  $M_{Gtotal}$  (per gripper jaw), the data from the graphs for the gripping force  $F_H$  (→ 10/11), the

torque curve (→ 12) and the spring torque  $M_F$  (→ 13) must be combined accordingly.

$$M_{Gr} = F_H * x * M \text{ [%]}$$

- $M_{Gr}$  Gripping torque
- $F_H$  Gripping force
- $x$  Lever arm
- $M$  Torque curve

### Application

Single-acting	Supplementary gripping force	Gripping force retention
<ul style="list-style-type: none"> <li>• Gripping with spring force: <math>M_{Gtotal} = M_F</math></li> <li>• Gripping with pressure force: <math>M_{Gtotal} = M_{Gr} - M_F</math></li> </ul>	<ul style="list-style-type: none"> <li>• Gripping with pressure and spring force: <math>M_{Gtotal} = M_{Gr} + M_F</math></li> </ul>	<ul style="list-style-type: none"> <li>• Gripping with spring force: <math>M_{Gtotal} = M_F</math></li> </ul>

# Radial grippers DHRS

Technical data

Dimensions

Download CAD data → [www.festo.com](http://www.festo.com)

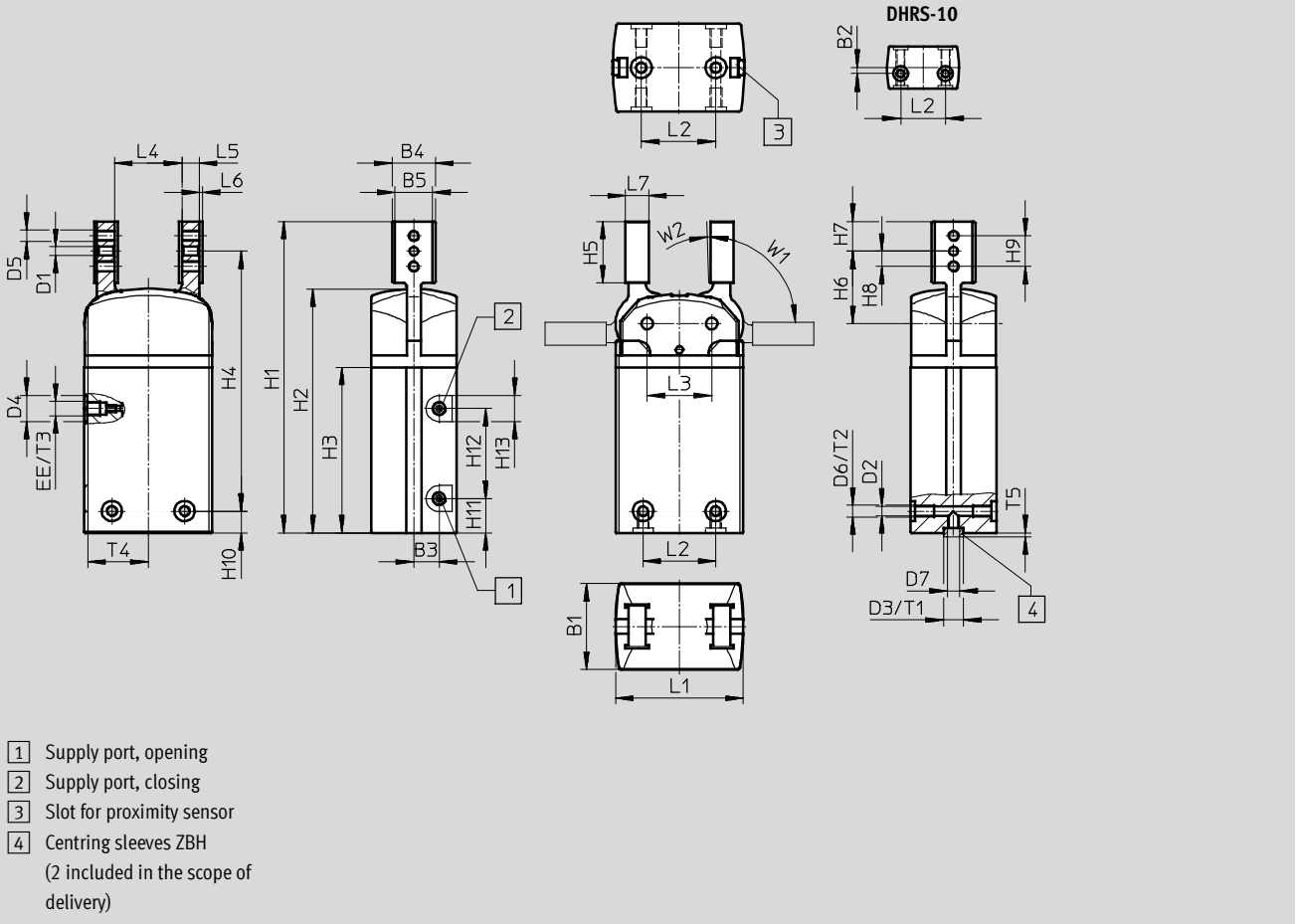

Size	B1	B2 <sup>1)</sup>	B3	B4	B5	D1	D2	D3	D4	D5
[mm]	±0.05				+0.03/ +0.01	∅ H8	∅ +0.1	∅ H8/h7	∅	
10	14	2	2	8.5	6.5	2	2.4	5	7	M2.5
16	19	–	5.8	14	10	2	2.5	5	–	M3
25	29.5	–	8.75	15	13	3	3.3	7	9	M4
32	38	–	11	16	14	4	5.1	9	15	M5
40	49	–	11	24	20	5	6.4	12	15	M6

Size	D6	D7	EE	H1	H2	H3	H4	H5	H6
[mm]		∅					±0.25	±0.2	±0.05
10	M3	3.2	M3	60.8	46	30.8	42.25	13.8	14.95
16	M3	3.2	M3	88.2	70.5	49	73.70	16.5	19.7
25	M4	5.3	M5	107.2	84	57	89.45	21.2	24.95
32	M6	6.4	G <sup>1</sup> / <sub>8</sub>	128.5	96.2	65	103.5	29.5	32
40	M8	10.3	G <sup>1</sup> / <sub>8</sub>	140	108.4	71.5	108.7	29.5	33.7

1) Tolerance for centring hole ±0.02 mm; tolerance for thread ±0.1 mm

# Radial grippers DHRS

Technical data

**FESTO**

Size	H7	H8	H9	H10 <sup>2)</sup>	H11	H12	H13	L1	L2 <sup>1)</sup>	L3
[mm]	-0.1							±0.05		±0.02
10	6.25	4	8	12.3	8.8	16	7	24	15	12.4
16	7	4	8	7.5	12.25	23	7	33.4	16	17
25	10.25	5.25	10.5	7.5	11.8	31	9	44	25	22.2
32	14	7	14	11	20	25	15	51	29	25.8
40	13.8	8	16	17.5	9	46	15	59	33	30

Size	L4	L5	L6	L7	T1	T2	T3	T4	T5	W1	W2
[mm]		±0.05			+0.1	+1	+0.5		-0.3	±2°	+3°
10	12	4	0.5	5	1.2	through	3.5	11.6	1.2	90	2
16	21	4	1	6	1.2	5.8	4.5	16	1.2	90	2
25	23.2	6	1	8	1.6	6.4	4.5	21	1.4	90	2
32	24.8	8	1	10	2.1	12.9	6.5	24	1.9	90	2
40	29.6	10	1	12	2.6	13.4	6	28.4	2.4	90	2

1) Tolerance for centring hole ±0.02 mm, tolerance for thread ±0.1 mm

2) Tolerance for centring hole -0.05 mm, tolerance for thread ±0.1 mm

Ordering data				
Size	Double-acting without compression spring		Single-acting or with gripping force retention	
	Part No.	Type	Closing Part No.	Type
10	<b>1310159</b>	<b>DHRS-10-A</b>	-	
16	<b>1310160</b>	<b>DHRS-16-A</b>	<b>1310161</b>	<b>DHRS-16-A-NC</b>
25	<b>1310162</b>	<b>DHRS-25-A</b>	<b>1310163</b>	<b>DHRS-25-A-NC</b>
32	<b>1310164</b>	<b>DHRS-32-A</b>	<b>1310165</b>	<b>DHRS-32-A-NC</b>
40	<b>1310166</b>	<b>DHRS-40-A</b>	<b>1310167</b>	<b>DHRS-40-A-NC</b>

# Radial grippers DHRS

Accessories

**Adapter kit**  
HMSV, HAPG, HAPS, HMVA, DHAA

Material:  
Wrought aluminium alloy  
Free of copper and PTFE  
RoHS-compliant

 **Note**  
The kit includes the individual mounting interface as well as the necessary mounting material.

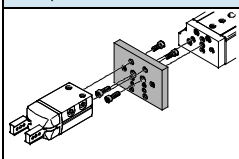
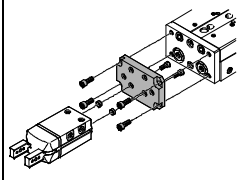
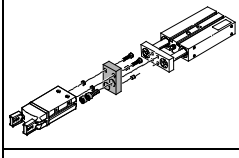
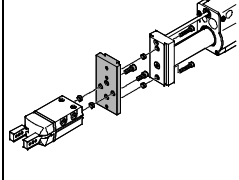
Permissible drive/gripper combinations with adapter kit							Download CAD data → <a href="http://www.festo.com">www.festo.com</a>	
Combination	Drive	Gripper	Mounting option		Adapter kit			
			Size	Size	CRC <sup>1)</sup>	Part No.	Type	
								
<b>DGSL/DHRS</b>	DGSL	DHRS			HMSV			
	8, 10	10	■	■	2	548784	HMSV-54	
	12, 16	16	■	■		548785	HMSV-55	
	20, 25	25, 32	■	■		548786	HMSV-56	
<b>SLT/DHRS</b>	SLT	DHRS			HAPS			
	10	10	■	–	2	178448	HAPS-2	
	16	16	■	–		178449	HAPS-3	
	20	25	■	–		178450	HAPS-4	
	25	32	■	–		178451	HAPS-5	
<b>DPZ/DHRS</b>	DPZ	DHRS			HAPG			
	10, 16	16	■	–	2	163250	HAPG-1	
	16	25	■	–		163251	HAPG-2	
	20	25	■	–		163252	HAPG-3	
	25, 32	32	■	–		163253	HAPG-4	
<b>HMP/DHRS</b>	HMP	DHRS			HMSV			
	Direct mounting				2			
	16, 20	16	■	■		177666	HMSV-20	
	16, 20, 25	25	■	■		177761	HMSV-21	
	16, 20, 25, 32	32	■	■		177762	HMSV-22	
	25	40	■	■		177763	HMSV-23	
	32	40	■	■		177764	HMSV-24	
	Dovetail mounting				2			
	16, 20	16	■	■		177767	HMSV-27	
	16, 20, 25	25	■	■		177768	HMSV-28	
	16, 20, 25, 32	32	■	■		177769	HMSV-29	
	25	40	■	■		177770	HMSV-30	
	32	40	■	■		178211	HMSV-31	

1) Corrosion resistance class 2 according to Festo standard 940 070  
Components subject to moderate corrosion stress. Externally visible parts with primarily decorative surface requirements which are in direct contact with a normal industrial environment or media such as coolants or lubricating agents.





# Radial grippers DHRS

Accessories

**Adapter kit**  
 HMSV, HAPG, HAPS, HMVA, DHAA

**Material:**  
 Wrought aluminium alloy  
 Free of copper and PTFE  
 RoHS-compliant

**Note**  
 The kit includes the individual mounting interface as well as the necessary mounting material.

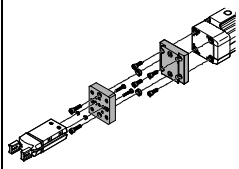
Permissible drive/gripper combinations with adapter kit					Download CAD data → <a href="http://www.festo.com">www.festo.com</a>		
Combination	Drive Size	Gripper Size	Mounting option		Adapter kit		
					CRC <sup>1)</sup>	Part No. Type	
DGP..., DGE..., DGEA/DHRS	DG...	DHRS			HMVA, HAPG, HMSV		
	<b>Direct mounting</b>						
	18 <sup>2)</sup> , 25 <sup>3)</sup>	10	■	■	2	196788 HMVA-DLA18/25 192706 HAPG-37-S1	
	40 <sup>3)</sup>	10	■	■		196790 HMVA-DLA40 192706 HAPG-37-S1	
	18 <sup>2)</sup> , 25 <sup>3)</sup>	16	■	■		196788 HMVA-DLA18/25 192705 HAPG-36-S1	
	40 <sup>3)</sup>	16	■	■		196790 HMVA-DLA40 192705 HAPG-36-S1	
	18 <sup>2)</sup> , 25 <sup>3)</sup>	25	■	■		196788 HMVA-DLA18/25 193922 HAPG-37-S4	
	40 <sup>3)</sup>	25	■	■		196790 HMVA-DLA40 193922 HAPG-37-S4	
	<b>Dovetail mounting</b>						
	18 <sup>2)</sup> , 25	16	■	■		2	196788 HMVA-DLA18/25 177767 HMSV-27
	40	16	■	■			196790 HMVA-DLA40 177767 HMSV-27
	18 <sup>2)</sup> , 25	25	■	■			196788 HMVA-DLA18/25 177768 HMSV-28
	40	25	■	■			196790 HMVA-DLA40 177768 HMSV-28
	40	32	■	■			196790 HMVA-DLA40 177769 HMSV-29
	40	40	■	■	196790 HMVA-DLA40 177770 HMSV-30		

1) Corrosion resistance class 2 according to Festo standard 940 070  
 Components subject to moderate corrosion stress. Externally visible parts with primarily decorative surface requirements which are in direct contact with a normal industrial environment or media such as coolants or lubricating agents.

2) Only for DGEA-...

3) Only for DGE.../DGP...



# Radial grippers DHRS

Accessories

**Adapter kit**  
HMSV, HAPG, HAPS, HMVA, DHAA

Material:  
Wrought aluminium alloy  
Free of copper and PTFE  
RoHS-compliant

 **Note**  
The kit includes the individual mounting interface as well as the necessary mounting material.

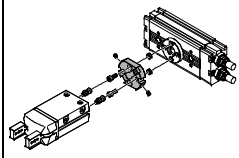
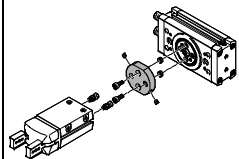
Permissible drive/gripper combinations with adapter kit						Download CAD data → <a href="http://www.festo.com">www.festo.com</a>		
Combination	Drive Size	Gripper Size	Mounting option		Adapter kit			
					CRC <sup>1)</sup>	Part No.	Type	
<b>DRQD/DHRS</b>	<b>DRQD-...-FW</b>	<b>DHRS</b>			<b>HAPG</b>			
	6, 8, 12	10	■	■	2	187568	HAPG-34	
	16 <sup>2)</sup>	10	■	■		187566	HAPG-SD2-12	
	16 <sup>2)</sup>	16	■	■		184477	HAPG-SD2-1	
	16 <sup>2)</sup>	25	■	■		184478	HAPG-SD2-2	
	20 <sup>2)</sup>	25	■	■		184479	HAPG-SD2-3	
	20 <sup>2)</sup>	32	■	■		184480	HAPG-SD2-4	
	25 <sup>3)</sup>	25	■	■		184482	HAPG-SD2-6	
	25 <sup>3)</sup>	32	■	■		184483	HAPG-SD2-7	
	32 <sup>3)</sup>	32	■	■		184485	HAPG-SD2-9	
	32 <sup>3)</sup>	40	■	■		184486	HAPG-SD2-10	
	40, 50	40	■	■		526027	HAPG-SD2-21	
	<b>DRQD-...ZW</b>	<b>DHRS</b>				<b>HAPG</b>		
	16	16	■	■		2	163267	HAPG-18
	16	25	■	■			163268	HAPG-19
20	25	■	■	163269	HAPG-20			
20	32	■	■	163270	HAPG-21			
25	32	■	■	163271	HAPG-22			
<b>DRRD/DHRS</b>	<b>DRRD</b>	<b>DHRS</b>			<b>DHAA</b>			
	16	16	■	■	2	1979085	DHAA-G-Q11-16-B2/B3-16	
	16	25	■	■		1978889	DHAA-G-Q11-16-B2/B3-25	
	20	25	■	■		1978443	DHAA-G-Q11-20-B2/B3-25	
	20	32	■	■		1979912	DHAA-G-Q11-20-B2/B3-32	
	25	25	■	■		1801802	DHAA-G-Q11-25-B2/B3-25	
	25	32	■	■		1802969	DHAA-G-Q11-25-B2/B3-32	
	32	32	■	■		1979992	DHAA-G-Q11-32-B2/B3-32	
	32	40	■	■		1980014	DHAA-G-Q11-32-B2/B3-40	
	35, 40	40	■	■		1980059	DHAA-G-Q11-35/40-B2/B3-40	

1) Corrosion resistance class 2 according to Festo standard 940 070  
Components subject to moderate corrosion stress. Externally visible parts with primarily decorative surface requirements which are in direct contact with a normal industrial environment or media such as coolants or lubricating agents.

2) Possible in combination with DRQD-...-E422 (flanged shaft with energy through-feed).

3) Possible in combination with DRQD-...-E444 (flanged shaft with energy through-feed).

# Radial grippers DHRS

Accessories

**Adapter kit**  
 HMSV, HAPG, HAPS, HMVA, DHAA

**Material:**  
 Wrought aluminium alloy  
 Free of copper and PTFE  
 RoHS-compliant

**Note**

The kit includes the individual mounting interface as well as the necessary mounting material.

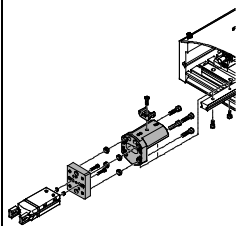
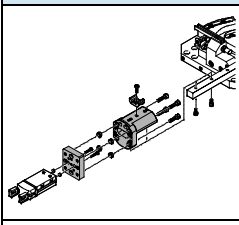
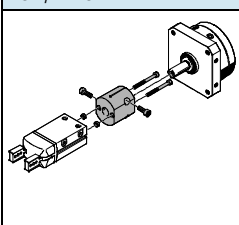
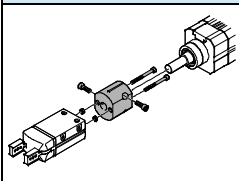
Permissible drive/gripper combinations with adapter kit					Download CAD data → <a href="http://www.festo.com">www.festo.com</a>			
Combination	Drive	Gripper	Mounting option		Adapter kit			
			Size	Size	CRC <sup>1)</sup>	Part No.	Type	
								
	HSP	DHRS			HAPG			
	12	10	■	–	2	192709	HAPG-60-S1	
	16	10	■	–		540881	HAPG-70-B	
	16	16	■	–		192706	HAPG-37-S1	
	25	16	■	–		540882	HAPG-71-B	
	25	16	■	–		192705	HAPG-36-S1	
25	25	■	–	540882		HAPG-71-B		
	HSW	DHRS			HAPG			
	12, 16	10	■	–	2	192706	HAPG-37-S1	
	12, 16	16	■	–		540882	HAPG-71-B	
				192705		HAPG-36-S1		
	DSM-...-FW	DHRS	■	■	2	187568	HAPG-34	
	DSM-...	DHRS			HAPG			
	12	16	■	■	2	163266	HAPG-17	
	16	16	■	■		163267	HAPG-18	
	16	25	■	■		163268	HAPG-19	
	25	25	■	■		163269	HAPG-20	
	25	32	■	■		163270	HAPG-21	
	32	32	■	■		163271	HAPG-22	
	DSL	DHRS	■	■		HAPG		
	16	16	■	■		2	163266	HAPG-17
	20	16	■	■	163267		HAPG-18	
	20	25	■	■	163268		HAPG-19	
	25	25	■	■	163269		HAPG-20	
	25	32	■	■	163270		HAPG-21	
	32	32	■	■	163271		HAPG-22	

1) Corrosion resistance class 2 according to Festo standard 940 070

Components subject to moderate corrosion stress. Externally visible parts with primarily decorative surface requirements which are in direct contact with a normal industrial environment or media such as coolants or lubricating agents.



# Radial grippers DHRS

Accessories

**Adapter kit**  
HMSV, HAPG, HAPS, HMVA, DHAA

Material:  
Wrought aluminium alloy  
Free of copper and PTFE  
RoHS-compliant

 **Note**  
The kit includes the individual mounting interface as well as the necessary mounting material.

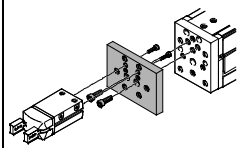
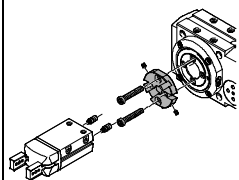
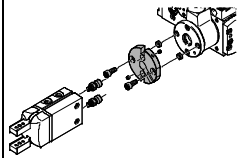
Permissible drive/gripper combinations with adapter kit							Download CAD data → <a href="http://www.festo.com">www.festo.com</a>	
Combination	Drive Size	Gripper Size	Mounting option		Adapter kit			
					CRC <sup>1)</sup>	Part No.	Type	
<b>EGSL/DHRS</b>	<b>EGSL</b>	<b>DHRS</b>			<b>HMSV</b>			
	35	10	■	■	2	548784	HMSV-54	
	45, 55	16	■	■		1088262	HMSV-70	
	75	25, 32	■	■		548785	HMSV-55	
							548786	HMSV-56
<b>ERMB/DHRS</b>	<b>ERMB</b>	<b>DHRS</b>			<b>HAPG</b>			
	20	25	■	■	2	184479	HAPG-SD2-3	
	25	25	■	■		184482	HAPG-SD2-6	
	20	32	■	■		184480	HAPG-SD2-4	
	25	32	■	■		184483	HAPG-SD2-7	
	32	32	■	■		184485	HAPG-SD2-9	
	32	40	■	■		184486	HAPG-SD2-10	
<b>EHMB/DHRS</b>	<b>EHMB</b>	<b>DHRS</b>			<b>HAPG</b>			
	20	32	■	■	2	184485	HAPG-SD2-9	
	20	40	■	■		184486	HAPG-SD2-10	
	25, 32	40	■	■		526027	HAPG-SD2-21	

1) Corrosion resistance class 2 according to Festo standard 940 070  
Components subject to moderate corrosion stress. Externally visible parts with primarily decorative surface requirements which are in direct contact with a normal industrial environment or media such as coolants or lubricating agents.

# Radial grippers DHRS

Accessories

Ordering data						
	For size [mm]	Description	Weight [g]	Part No.	Type	PU <sup>1)</sup>
Centring sleeve ZBH <span style="float: right;">Technical data → Internet: zbh</span>						
	10, 16	For centring the gripper during mounting	1	189652	ZBH-5	10
	25		1	186717	ZBH-7	
	32		1	150927	ZBH-9	
	40		1	189653	ZBH-12	

1) Packaging unit

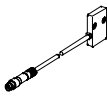

Ordering data			
Type	For size	Weight [g]	Part No. Type
Position sensor SMH-S1 <span style="float: right;">Technical data → Internet: smh-s1</span>			
	10	20	175712 SMH-S1-HGR10



## Signal converter/evaluation unit for position sensor SMH-S1

Signal converter SVE4

Evaluation unit SMH-AE1



- Converts analogue signals into switching points
- Switching function freely programmable with teach-in
- Threshold value, hysteresis or window comparator
- Converts analogue signals into switching points
- With 3 potentiometers for setting 3 switching points

Ordering data						
Type	For size	Input connection	Output connection	Switching output	Weight [g]	Part No. Type
Signal converter SVE4 <span style="float: right;">Technical data → Internet: sve4</span>						
	10	Socket M8x1, 4-pin	Plug M8x1, 4-pin	2x PNP	19	544216 SVE4-HS-R-HM8-2P-M8
				2x NPN		544219 SVE4-HS-R-HM8-2N-M8
Evaluation unit SMH-AE1 <span style="float: right;">Technical data → Internet: smh-ae</span>						
	10	Socket M8x1, 4-pin	Plug M12x1, 5-pin	3x PNP	170	175708 SMH-AE1-PS3-M12
				3x NPN		175709 SMH-AE1-NS3-M12

Ordering data – Connecting cables					
	Electrical connection, left	Electrical connection, right	Cable length [m]	Part No.	Type
Connection between position sensor and signal converter/evaluation unit					
	Straight socket, M8x1, 4-pin	Straight plug, M8x1, 4-pin	2.5	554035	NEBU-M8G4-K-2.5-M8G4
Connection between evaluation unit and controller					
	Straight socket, M12x1, 5-pin	Cable, open end, 5-wire	2.5	541330	NEBU-M12G5-K-2.5-LE5
			5	541331	NEBU-M12G5-K-5-LE5

## Radial grippers DHRS

Accessories

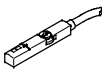

Ordering data – Connecting cables					Technical data → Internet: nebu	
	Electrical connection, left	Electrical connection, right	Cable length [m]	Part No.	Type	
Connection between signal converter and controller						
	Straight socket, M8x1, 4-pin	Cable, open end, 4-wire	2.5	541342	NEBU-M8G4-K-2.5-LE4	
			5	541343	NEBU-M8G4-K-5-LE4	
	Angled socket, M8x1, 4-pin	Cable, open end, 4-wire	2.5	541344	NEBU-M8W4-K-2.5-LE4	
			5	541345	NEBU-M8W4-K-5-LE4	

Ordering data – Proximity sensors for T-slot, magneto-resistive					Technical data → Internet: smt	
	Type of mounting	Electrical connection, connection direction	Switching output	Cable length [m]	Part No.	Type
N/O contact						
	Insertable in the slot lengthwise	Cable, 3-wire, lateral	PNP	2.5	547859	SMT-8G-PS-24V-E-2,5Q-OE
		Plug M8x1, 3-pin, lateral		0.3	547860	SMT-8G-PS-24V-E-0,3Q-M8D

Ordering data – Position transmitters for T-slot					Technical data → Internet: smat	
	Type of mounting	Electrical connection, connection direction	Analogue output [V]	Cable length [m]	Part No.	Type
	Insertable in the slot from above	Plug M8x1, 3-pin, in-line	0 ... 10	0.3	553744	SMAT-8M-U-E-0,3-M8D

 **Note**

**Mode of operation:**  
The position transmitter continuously senses the position of the piston. It has an analogue output with an output signal in proportion to the piston position.

Ordering data – Connecting cables					Technical data → Internet: nebu	
	Electrical connection, left	Electrical connection, right	Cable length [m]	Part No.	Type	
	Straight socket, M8x1, 3-pin	Cable, open end, 3-wire	2.5	541333	NEBU-M8G3-K-2.5-LE3	
			5	541334	NEBU-M8G3-K-5-LE3	
	Angled socket, M8x1, 3-pin	Cable, open end, 3-wire	2.5	541338	NEBU-M8W3-K-2.5-LE3	
			5	541341	NEBU-M8W3-K-5-LE3	