

Inscription label holders ASCF

Technical data

Inscription label holder IBT, VMPA1, CPX, CPVSC1-ST, CPV
Identification clip MN2H, MVH

Inscription label holders enable inscription labels to be attached to components without pre-assembled carriers, or with special carriers for holders of this type.

If display components are concealed by the inscription label holder, the carrier is either semi-transparent or completely transparent.



 Note
 Microsoft Word templates for inscription label holders/ identification strips can be found at:
 → www.festo.com

| Materials | | | | | | | | |
|--------------------------|------|-----|-----|------------|------------|-----|-----------|-----|
| Type | MN2H | MVH | IBT | VMPA1-ST-1 | VMPA1-ST-2 | CPX | CPVSC1-ST | CPV |
| Inscription label holder | PA | PA | PC | PP | POM | PP | PVC | PVC |

Examples illustrating the attachment of inscription label holders

MVH-BZ (similar to MN2H-BZT-...)

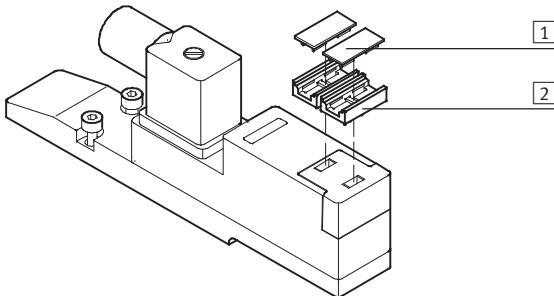

- 1 Inscription labels IBS-9x17
- 2 Inscription label holder MVH-BZ

- The inscription label holder is snapped into recesses on the valve
- The inscription is created using inscription labels

IBT-...

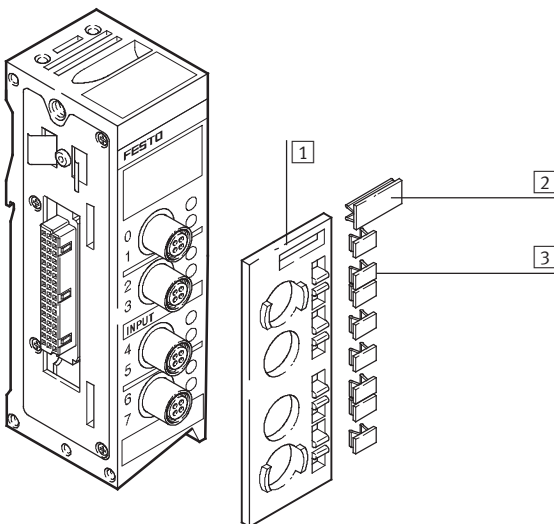

- 1 Inscription label holder IBT-03...
- 2 Inscription label IBS-9x20
- 3 Inscription labels IBS-6x20

- The inscription label holder is pushed in
- The inscription is created using inscription labels

Inscription label holders ASCF

Technical data

Examples illustrating the attachment of inscription label holders

VMPA1-ST-...

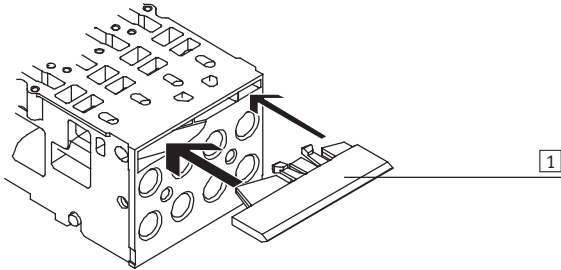

1 Inscription label holder VMPA-ST...

- The inscription label holder is snapped into recesses on the valve terminal
- The inscription is created by inserting identification strips

CPVSC1-ST-...

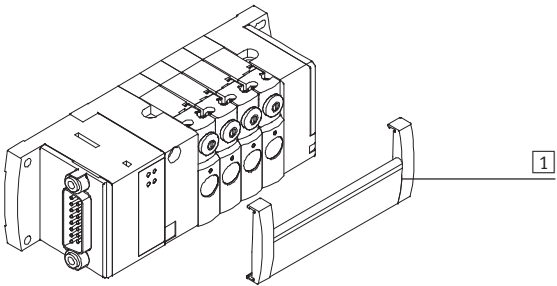

1 Inscription label holder CPVSC1-ST...

- The inscription label holder is clipped onto the valve terminal
- The inscription is created by inserting identification strips

CPV10-VI-...

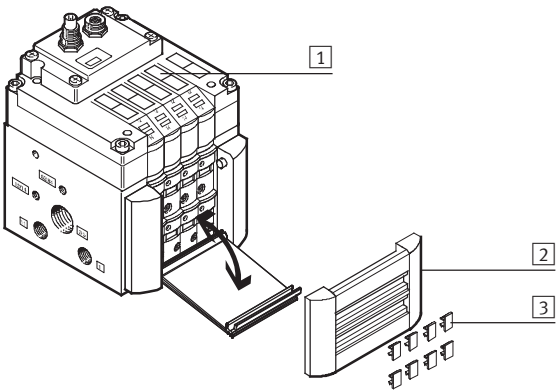

1 Inscription labels IBS-9x20
2 Inscription label holder CPV10-VI-BZT...
3 Inscription labels IBS-6x10

- The inscription label holder is snapped into recesses on the valve terminal
- The inscription is created using inscription labels or by inserting identification strips

- - Note

The inscription label holder cannot be used together with relay slices.

- 1 - Type discontinued
Available up until 2017

FESTO

Inscription label holders ASCF

Technical data

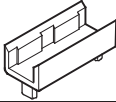
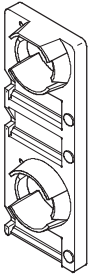
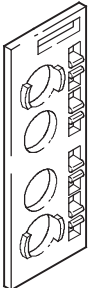
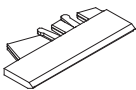
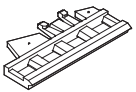
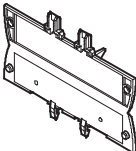
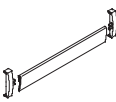
| Ordering data | | | | | | |
|---|--|--|---|--------|----------|----------------|
| | Carriers for inscription labels | Use | For modules with the following number of valves | Weight | Part No. | Type |
| | | | | [g] | | |
|  | IBS-9x17 (1 piece) | Valve terminal type 14 | - | 7 | 161936 | MN2H-BZT-10X |
| | IBS-9x17 (1 piece) | - | - | 19 | 18575 | MVH-BZ |
|  | IBS-9x20 (3 pieces) | Valve terminal type 02 | - | 47 | 158968 | IBT-02-E/A |
|  | IBS-9x20 (1 piece) IBS-6x10 (8 pieces) | Modular electrical peripherals for valve terminal type 03/04 | - | 38 | 18183 | IBT-03-E/A - 1 |
|  | Insertable label or paper/ cardboard strips | Valve terminal type 32 MPA | - | 6 | 533362 | VMPA1-ST-1-4 |
|  | IBS-6x10 (4 pieces) | Valve terminal type 32 MPA | - | 8 | 544384 | VMPA1-ST-2-4 |
|  | Insertable label or paper/ cardboard strips | Modular electrical terminal CPX | - | 5 | 536593 | CPX-ST-1 |
|  | Insertable label or paper/ cardboard strips | Valve terminal type 80 CPV-SC | 2 | 5 | 547395 | CPVSC1-ST-2 |
| | | | 3 | 6 | 547396 | CPVSC1-ST-3 |
| | | | 4 | 7 | 527631 | CPVSC1-ST-4 |
| | | | 5 | 7 | 547397 | CPVSC1-ST-5 |
| | | | 6 | 8 | 547398 | CPVSC1-ST-6 |
| | | | 7 | 8 | 547399 | CPVSC1-ST-7 |
| | | | 8 | 9 | 527633 | CPVSC1-ST-8 |
| | | | 9 | 10 | 547400 | CPVSC1-ST-9 |
| | | | 10 | 12 | 547401 | CPVSC1-ST-10 |
| | | | 11 | 13 | 547402 | CPVSC1-ST-11 |
| | | | 12 | 15 | 527635 | CPVSC1-ST-12 |
| | | | 13 | 16 | 547403 | CPVSC1-ST-13 |
| | | | 14 | 17 | 547404 | CPVSC1-ST-14 |
| | | | 15 | 18 | 547405 | CPVSC1-ST-15 |
| 16 | 20 | 527637 | CPVSC1-ST-16 | | | |

Inscription label holders ASCF

Technical data

FESTO

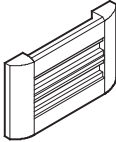
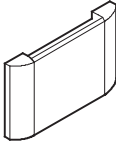
| Ordering data | | | | | | |
|---|--|--|---|---------------|-----------------|-----------------|
| | Carriers for inscription labels | Use | For modules with the following number of valves | Weight | Part No. | Type |
| | | | | [g] | | |
|  | IBS-6x10 (4 pieces) | Valve terminal type 10 CPV in size 10 | 2 | 9 | 162560 | CPV10-VI-BZ-T-2 |
| | IBS-6x10 (6 pieces) | | 3 | 10 | 162561 | CPV10-VI-BZ-T-3 |
| | IBS-6x10 (8 pieces) | | 4 | 11 | 162562 | CPV10-VI-BZ-T-4 |
| | IBS-6x10 (10 pieces) | | 5 | 15 | 162563 | CPV10-VI-BZ-T-5 |
| | IBS-6x10 (12 pieces) | | 6 | 14 | 162564 | CPV10-VI-BZ-T-6 |
| | IBS-6x10 (14 pieces) | | 7 | 15 | 162565 | CPV10-VI-BZ-T-7 |
| | IBS-6x10 (16 pieces) | | 8 | 16 | 162566 | CPV10-VI-BZ-T-8 |
| | IBS-6x10 (4 pieces) | | Valve terminal type 10 CPV in size 14 | 2 | 10 | 162567 |
| | IBS-6x10 (6 pieces) | 3 | | 11 | 162568 | CPV14-VI-BZ-T-3 |
| | IBS-6x10 (8 pieces) | 4 | | 13 | 162569 | CPV14-VI-BZ-T-4 |
| | IBS-6x10 (10 pieces) | 5 | | 15 | 162570 | CPV14-VI-BZ-T-5 |
| | IBS-6x10 (12 pieces) | 6 | | 16 | 162571 | CPV14-VI-BZ-T-6 |
| | IBS-6x10 (14 pieces) | 7 | | 19 | 162572 | CPV14-VI-BZ-T-7 |
| | IBS-6x10 (16 pieces) | 8 | | 21 | 162573 | CPV14-VI-BZ-T-8 |
| | IBS-6x10 (4 pieces) | Valve terminal type 10 CPV in size 18 | | 2 | 11 | 163293 |
| | IBS-6x10 (6 pieces) | | 3 | 12 | 163294 | CPV18-VI-BZ-T-3 |
| | IBS-6x10 (8 pieces) | | 4 | 17 | 163295 | CPV18-VI-BZ-T-4 |
| | IBS-6x10 (10 pieces) | | 5 | 18 | 163296 | CPV18-VI-BZ-T-5 |
| | IBS-6x10 (12 pieces) | | 6 | 20 | 163297 | CPV18-VI-BZ-T-6 |
| | IBS-6x10 (14 pieces) | | 7 | 23 | 163298 | CPV18-VI-BZ-T-7 |
| IBS-6x10 (16 pieces) | 8 | | 29 | 163299 | CPV18-VI-BZ-T-8 | |
|  | Insertable label or paper/ cardboard strips | | Valve terminal type 10 CPV in size 10 | 2 | 8 | 194066 |
| | | 3 | | 10 | 194067 | CPV10-VI-ST-3 |
| | | 4 | | 11 | 194068 | CPV10-VI-ST-4 |
| | | 5 | | 13 | 194069 | CPV10-VI-ST-5 |
| | | 6 | | 14 | 194070 | CPV10-VI-ST-6 |
| | | 7 | | 15 | 194071 | CPV10-VI-ST-7 |
| | | 8 | | 16 | 194072 | CPV10-VI-ST-8 |
| | | Valve terminal type 10 CPV in size 14 | | 2 | 10 | 194073 |
| | | | 3 | 11 | 194074 | CPV14-VI-ST-3 |
| | | | 4 | 14 | 194075 | CPV14-VI-ST-4 |
| | | | 5 | 15 | 194076 | CPV14-VI-ST-5 |
| | | | 6 | 20 | 194077 | CPV14-VI-ST-6 |
| | | | 7 | 19 | 194078 | CPV14-VI-ST-7 |
| | | | 8 | 22 | 194079 | CPV14-VI-ST-8 |
| | | | Valve terminal type 10 CPV in size 18 | 2 | 11 | 194080 |
| | | 3 | | 13 | 194081 | CPV18-VI-ST-3 |
| | | 4 | | 15 | 194082 | CPV18-VI-ST-4 |
| | | 5 | | 18 | 194083 | CPV18-VI-ST-5 |
| | | 6 | | 21 | 194084 | CPV18-VI-ST-6 |
| | | 7 | | 23 | 194085 | CPV18-VI-ST-7 |
| 8 | 28 | 194086 | | CPV18-VI-ST-8 | | |

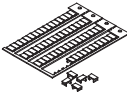
| Ordering data – Accessories | | | |
|---|--|----------|----------|
| | Description | Part No. | Type |
|  | Inscription labels 6x10 mm, 64 pieces, in frames | 18576 | IBS-6x10 |
| | Inscription labels 9x17 mm, 24 pieces, in frames | 161937 | IBS-9x17 |
| | Inscription labels 9x20 mm, 20 pieces, in frames | 18182 | IBS-9x20 |