

Solenoid valves VZWD, directly actuated, NPT



Solenoid valves VZWD, directly actuated, NPT

Key features and overview

General

Directly actuated solenoid valves VZWD are mainly intended for applications with high pressure ranges and low flow rates. This type of valve switches the sealing

element directly via the solenoid system. The seal generally has to lift away from the seat against the effective operating pressure using just the drive. A closing spring

keeps the valve closed assisted by the pressure of the medium. The function is dependent on the seat size, the effective operating

pressure and the magnetic force. The difference with force pilot operated solenoid valves (VZWF) lies in the flow rate.

General

-N- Connecting thread
N $\frac{1}{4}$, N $\frac{1}{8}$

-  - Flow rate Kv
0.06 ... 0.4 m³/h

Areas of application

- Use in vacuum technology
- Venting gas and tank systems
- Safety shut-offs for burner controllers

Design

- Design insensitive to slight contamination of the media

Advantages

- Valves switch from 0 bar up to the max. operating pressure
- Excellent tightness

Solenoid valves VZWD, directly actuated, NPT

Key features and overview

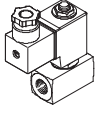
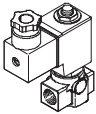
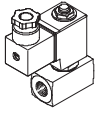
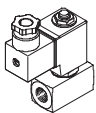
Version	Type	Process valve connection	Nominal size (DN)	Operating pressure [bar]	→ Page/Internet
Brass housing					
	VZWD-L-...	NPT $\frac{1}{4}$	1	0 ... 50	5
			1.5	0 ... 30	
			2	0 ... 15	
			2.5	0 ... 8	
		NPT $\frac{3}{8}$	1	0 ... 50	5
			1.5	0 ... 30	
			2	0 ... 15	
Brass housing					
	VZWD-L-...	NPT $\frac{1}{4}$	1	0 ... 90	8
			1.5	0 ... 85	
			2	0 ... 40	
			2.5	0 ... 22	
			3	0 ... 15	
			4	0 ... 8	
			5	0 ... 5	
			6	0 ... 4	
		NPT $\frac{3}{8}$	1	0 ... 90	8
			1.5	0 ... 85	
			2	0 ... 40	
			2.5	0 ... 22	
			3	0 ... 15	
			4	0 ... 8	
Stainless steel housing					
	VZWD-L-...-R1	NPT $\frac{1}{4}$	1	0 ... 90	13
			1.5	0 ... 85	
			2	0 ... 40	
			2.5	0 ... 22	
			3	0 ... 15	
			4	0 ... 8	
			5	0 ... 5	
			6	0 ... 4	
	VZWD-L-...-R1	NPT $\frac{3}{8}$	1	0 ... 90	13
			1.5	0 ... 85	
			2	0 ... 40	
			2.5	0 ... 22	
			3	0 ... 15	
			4	0 ... 8	
			5	0 ... 5	
			6	0 ... 4	

Solenoid valves VZWD, directly actuated, NPT

Type codes

VZWD - L - M22C - M - N18 - 15 - V - 2AP4 - 40 - R1

Type

VZWD	Solenoid valve, directly actuated
------	-----------------------------------

Type of directional control valve

L	In-line valve
---	---------------

Valve function

M22C	2/2-way valve, normally closed, mechanical reset
------	--

Reset method

M	Mechanical spring
---	-------------------

Process valve connection

N18	NPT ¹ / ₈
N14	NPT ¹ / ₄

Nominal size (DN)

10	1.0 mm
15	1.5 mm
20	2.0 mm
25	2.5 mm
30	3.0 mm
40	4.0 mm
50	5.0 mm
60	6.0 mm

Sealing material

V	FPM
---	-----

Nominal operating voltage

1	24 V DC
2A	110 V AC/50-60 Hz
3A	230 V AC/50-60 Hz

Electrical connection

P4	Plug socket, 3-pin
----	--------------------

Operating pressure

4	Max. 4 bar
5	Max. 5 bar
8	Max. 8 bar
15	Max. 15 bar
22	Max. 22 bar
30	Max. 30 bar
40	Max. 40 bar
50	Max. 50 bar
85	Max. 85 bar
90	Max. 90 bar

Corrosion protection

	Brass
R1	Stainless steel

Solenoid valves VZWD, directly actuated, NPT

Technical data – Brass housing

Function

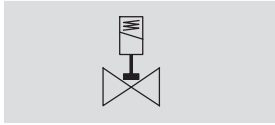

-  - Flow rate Kv
0.06 ... 0.16 m³/h

-N- Connecting thread
N¹/₄, N¹/₈



General technical data		1.0	1.5	2.0	2.5
Nominal size (DN)		1.0	1.5	2.0	2.5
Valve function		2/2-way, single solenoid, closed			
Design		Directly actuated poppet valve			
Type of mounting		In-line installation			
Actuation type		Electric			
Reset method		Mechanical spring			
Direction of flow		Non-reversible			
Type of control		Direct			
Manual override		None			
Mounting position		Any			
Sealing principle		Soft			
Max. viscosity	[mm ² /s]	22			
Protection class		IP65			

Operating and environmental conditions		1.0	1.5	2.0	2.5
Nominal size (DN)		1.0	1.5	2.0	2.5
Standard nominal flow rate	[l/min]	60	95	140	170
Flow rate	[m ³ /h]	0.06	0.09	0.13	0.16
Process valve nominal pressure (PN)		50			
Process valve operating medium		Filtered compressed air, grade of filtration 40 µm, lubricated or unlubricated, neutral gases, vacuum, neutral liquids, water, mineral oil			
Differential pressure	[bar]	0			
Ambient temperature	[°C]	-10 ... +35 °C			
Temperature of medium	[°C]	-10 ... +80 °C			
Leak rate to EN 12266-1		A			
Corrosion resistance class CRC ¹⁾		1			

1) Corrosion resistance class 1 according to Festo standard 940 070
Components subject to low corrosion stress. Transport and storage protection. Parts that do not have primarily decorative surface requirements, e.g. in internal areas that are not visible or behind covers.

Solenoid valves VZWD, directly actuated, NPT

Technical data – Brass housing

Electrical data		VZWD- ... 1	VZWD- ... 2A	VZWD- ... 3A
Electrical connection	Plug to EN 175301-803 type A, square design			
CE marking	–		73/23/EEC	73/23/EEC
Insulation class	H		F	F
Duty cycle	[%]	100		
Permissible voltage fluctuations	[%]	±10		
Coil characteristics	Direct current DC	[V]	24	–
	Alternating current AC	[V]	–	110
		[W]	11	–
	Pick-up power	[VA]	–	10.5
	Holding power	[VA]	–	8
		[Hz]	–	50, 60
	Switching time on	[ms]	25	
Switching time off	[ms]	10		

Materials		
Solenoid valves		Material number
1 Housing	High-alloy stainless steel	1.4305
	Brass	CW614N
2 Seals	FPM	
– Note on materials	Contains PWIS (paint-wetting impairment substances), RoHS-compliant	

Dimensions Download CAD data → www.festo.com/en/engineering

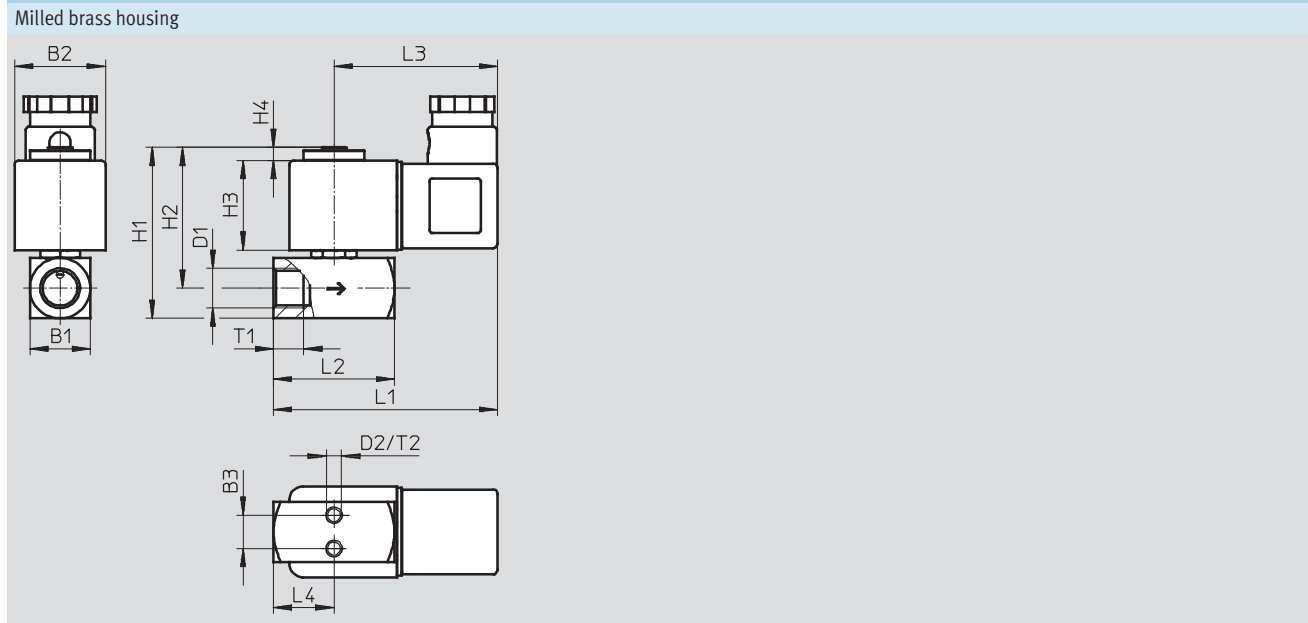

Type	B1	B2	B3	D1	D2	H1	H2	H3	H4	L1	L2	L3	L4	L5	T1	T2
VZWD-...-N1/8-10-...-50	15	30	8	NPT1/8	M5	52	44	30	5	70	32	54	16	–	8	5
VZWD-...-N1/8-15-...-30																
VZWD-...-N1/8-20-...-15																
VZWD-...-N1/4-10-...-50	20	30	11	NPT1/4	M5	57	47	30	5	74	40	54	20	–	10	5
VZWD-...-N1/4-15-...-30																
VZWD-...-N1/4-20-...-15																
VZWD-...-N1/4-25-...-8																

Solenoid valves VZWD, directly actuated, NPT

FESTO

Technical data – Brass housing

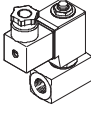
Ordering data						
	Process valve connection	Nominal size	Operating pressure	Product weight	Brass housing	
		DN	[bar]	[g]	Part No.	Type
	N $\frac{1}{4}$	1	0 ... 50	350	1491945	VZWD-L-M22C-M-N14-10-V-2AP4-50
					1492023	VZWD-L-M22C-M-N14-10-V-3AP4-50
					1491867	VZWD-L-M22C-M-N14-10-V-1P4-50
		1.5	0 ... 30	350	1491946	VZWD-L-M22C-M-N14-15-V-2AP4-30
					1492024	VZWD-L-M22C-M-N14-15-V-3AP4-30
					1491868	VZWD-L-M22C-M-N14-15-V-1P4-30
		2	0 ... 15	350	1491947	VZWD-L-M22C-M-N14-20-V-2AP4-15
					1492025	VZWD-L-M22C-M-N14-20-V-3AP4-15
					1491869	VZWD-L-M22C-M-N14-20-V-1P4-15
		2.5	0 ... 8	350	1491948	VZWD-L-M22C-M-N14-25-V-2AP4-8
					1492026	VZWD-L-M22C-M-N14-25-V-3AP4-8
					1491870	VZWD-L-M22C-M-N14-25-V-1P4-8

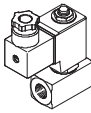
Ordering data						
	Process valve connection	Nominal size	Operating pressure	Product weight	Brass housing	
		DN	[bar]	[g]	Part No.	Type
	N $\frac{1}{8}$	1	0 ... 50	300	1491942	VZWD-L-M22C-M-N18-10-V-2AP4-50
					1492020	VZWD-L-M22C-M-N18-10-V-3AP4-50
					1491864	VZWD-L-M22C-M-N18-10-V-1P4-50
		1.5	0 ... 30	300	1491943	VZWD-L-M22C-M-N18-15-V-2AP4-30
					1492021	VZWD-L-M22C-M-N18-15-V-3AP4-30
					1491865	VZWD-L-M22C-M-N18-15-V-1P4-30
		2	0 ... 15	300	1491944	VZWD-L-M22C-M-N18-20-V-2AP4-15
					1492022	VZWD-L-M22C-M-N18-20-V-3AP4-15
					1491866	VZWD-L-M22C-M-N18-20-V-1P4-15

Solenoid valves VZWD, directly actuated, NPT

Technical data – Brass housing

Function

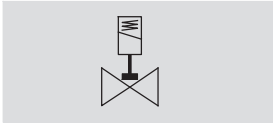

 Flow rate Kv
0.06 ... 0.4 m³/h

Nominal size (DN)
1.0 ... 6.0 mm

-N- Connecting thread
N¹/₄, N¹/₈



General technical data								
Nominal size (DN)	1.0	1.5	2.0	2.5	3.0	4.0	5.0	6.0
Valve function	2/2-way, single solenoid, closed							
Design	Directly actuated poppet valve							
Type of mounting	In-line installation							
Actuation type	Electric							
Reset method	Mechanical spring							
Direction of flow	Non-reversible							
Type of control	Direct							
Manual override	None							
Mounting position	Any							
Sealing principle	Soft							
Max. viscosity [mm ² /s]	22							
Protection class	IP65							

Operating and environmental conditions								
Nominal size (DN)	1.0	1.5	2.0	2.5	3.0	4.0	5.0	6.0
Standard nominal flow rate [l/min]	60	95	140	170	210	310	375	430
Flow rate [m ³ /h]	0.06	0.09	0.13	0.16	0.2	0.3	0.35	0.4
Process valve nominal pressure (PN)	100							
Differential pressure [bar]	0							
Process valve operating medium	Filtered compressed air, grade of filtration 40 µm, lubricated or unlubricated, neutral gases, vacuum, neutral liquids, water, mineral oil							
Ambient temperature [°C]	-10 ... +35 °C							
Temperature of medium [°C]	-10 ... +80 °C							
Leak rate to EN 12266-1	A							
Corrosion resistance class CRC ¹⁾	1							

1) Corrosion resistance class 1 according to Festo standard 940 070
Components subject to low corrosion stress. Transport and storage protection. Parts that do not have primarily decorative surface requirements, e.g. in internal areas that are not visible or behind covers.

Solenoid valves VZWD, directly actuated, NPT

Technical data – Brass housing



Electrical data			
	VZWD- ... 1	VZWD- ... 2A	VZWD- ... 3A
Electrical connection	Plug to EN 175301-803 type A, square design		
CE marking	–	73/23/EEC	73/23/EEC
Insulation class	H	F	F
Duty cycle	[%] 100		
Permissible voltage fluctuations	[%] ±10		
Coil characteristics	Direct current DC	[V] 24	–
	Alternating current AC	[V] –	110
		[W] 11	–
	Pick-up power	[VA] –	19
	Holding power	[VA] –	16
		[Hz] –	50, 60
	Switching time on	[ms] 20	
Switching time off	[ms] 18		

Materials		
Solenoid valves		Material number
1 Housing	High-alloy stainless steel	1.4305
	Brass	CW614N
2 Seals	FPM	
– Note on materials	Contains PWIS (paint-wetting impairment substances), RoHS-compliant	

Solenoid valves VZWD, directly actuated, NPT

Technical data – Brass housing

Dimensions

Download CAD data → www.festo.com/en/engineering

Die-cast brass housing

Milled brass housing

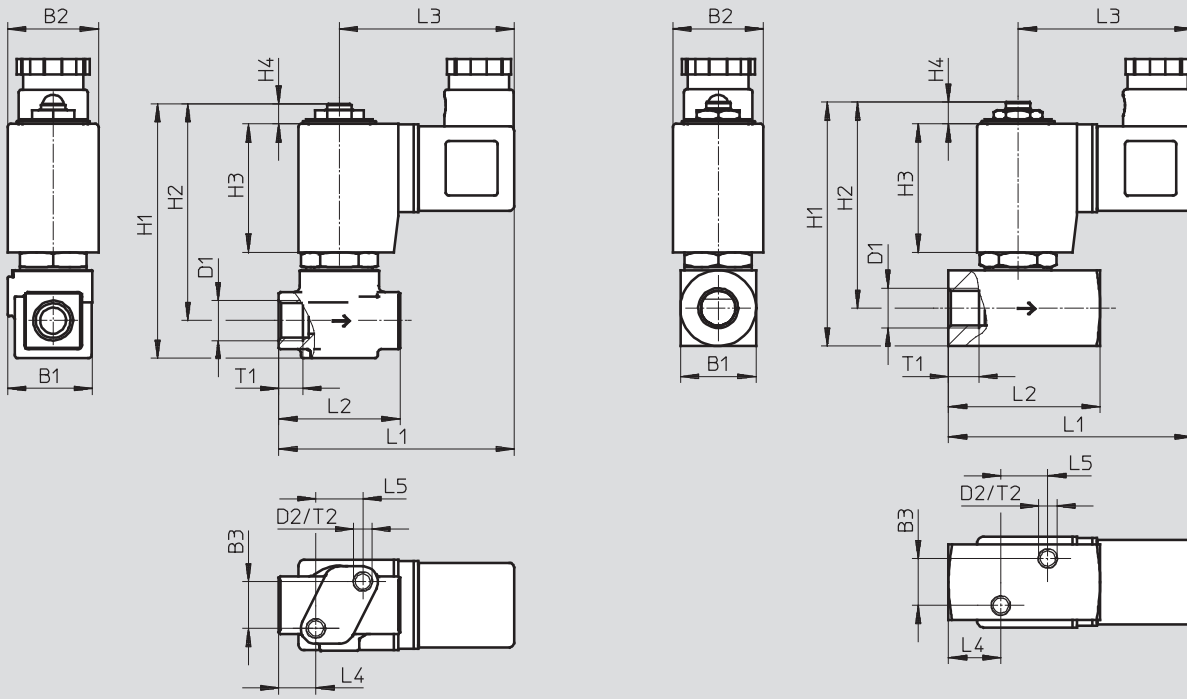

Type	B1	B2	B3	D1	D2	H1	H2	H3	H4	L1	L2	L3	L4	L5	T1	T2
VZWD-...-N1/8-10-...-90	28	30	15.5	NPT1/8	M6	84	72	42.5	6.5	78	40	58	12	15.5	8	6
VZWD-...-N1/8-15-...-85																
VZWD-...-N1/8-20-...-40																
VZWD-...-N1/8-25-...-22																
VZWD-...-N1/8-30-...-15																
VZWD-...-N1/8-40-...-8																
VZWD-...-N1/4-10-...-90	28	30	15.5	NPT1/4	M6	84	72	42.5	6.5	78	40	58	12	15.5	10	6
VZWD-...-N1/4-15-...-85																
VZWD-...-N1/4-20-...-40																
VZWD-...-N1/4-25-...-22																
VZWD-...-N1/4-30-...-15																
VZWD-...-N1/4-40-...-8																
VZWD-...-N1/8-50-...-5	25	30	15.5	NPT1/8	M6	81	68	42.5	7	78	40	58	12	15.5	8	6
VZWD-...-N1/8-60-...-4																
VZWD-...-N1/4-50-...-5	25	30	15.5	NPT1/4	M6	81	68	42.5	7	85	50	58	17	15.5	10	6
VZWD-...-N1/4-60-...-4																

Solenoid valves VZWD, directly actuated, NPT

Technical data – Brass housing

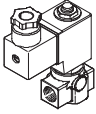
Ordering data						
	Process valve connection	Nominal size	Operating pressure	Product weight	Brass housing	
		DN	[bar]	[g]	Part No.	Type
	NPT $\frac{1}{4}$	1	0 ... 90	550	1491957	VZWD-L-M22C-M-N14-10-V-2AP4-90
					1492040	VZWD-L-M22C-M-N14-10-V-3AP4-90
					1491879	VZWD-L-M22C-M-N14-10-V-1P4-90
		1.5	0 ... 85	550	1491958	VZWD-L-M22C-M-N14-15-V-2AP4-85
					1492041	VZWD-L-M22C-M-N14-15-V-3AP4-85
					1491880	VZWD-L-M22C-M-N14-15-V-1P4-85
		2	0 ... 40	550	1491959	VZWD-L-M22C-M-N14-20-V-2AP4-40
					1492042	VZWD-L-M22C-M-N14-20-V-3AP4-40
					1491881	VZWD-L-M22C-M-N14-20-V-1P4-40
		2.5	0 ... 22	550	1491960	VZWD-L-M22C-M-N14-25-V-2AP4-22
					1492043	VZWD-L-M22C-M-N14-25-V-3AP4-22
					1491882	VZWD-L-M22C-M-N14-25-V-1P4-22
		3	0 ... 15	550	1491961	VZWD-L-M22C-M-N14-30-V-2AP4-15
					1492044	VZWD-L-M22C-M-N14-30-V-3AP4-15
					1491883	VZWD-L-M22C-M-N14-30-V-1P4-15
		4	0 ... 8	550	1491962	VZWD-L-M22C-M-N14-40-V-2AP4-8
					1492045	VZWD-L-M22C-M-N14-40-V-3AP4-8
					1491884	VZWD-L-M22C-M-N14-40-V-1P4-8

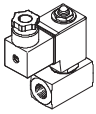
Ordering data						
	Process valve connection	Nominal size	Operating pressure	Product weight	Brass housing	
		DN	[bar]	[g]	Part No.	Type
	NPT $\frac{1}{4}$	5	0 ... 5	600	1491885	VZWD-L-M22C-M-N14-50-V-1P4-5
					1491963	VZWD-L-M22C-M-N14-50-V-2AP4-5
					1492046	VZWD-L-M22C-M-N14-50-V-3AP4-5
		6	0 ... 4	600	1491886	VZWD-L-M22C-M-N14-60-V-1P4-4
					1491964	VZWD-L-M22C-M-N14-60-V-2AP4-4
					1492047	VZWD-L-M22C-M-N14-60-V-3AP4-4

Solenoid valves VZWD, directly actuated, NPT

Technical data – Brass housing

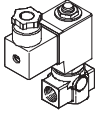
Ordering data					
	Process valve connection	Nominal size	Operating pressure	Product weight	Brass housing
		DN	[bar]	[g]	Part No. Type
	NPT $\frac{1}{8}$	1	0 ... 90	550	1491949 VZWD-L-M22C-M-N18-10-V-2AP4-90
					1492027 VZWD-L-M22C-M-N18-10-V-3AP4-90
					1491871 VZWD-L-M22C-M-N18-10-V-1P4-90
		1.5	0 ... 85	550	1491950 VZWD-L-M22C-M-N18-15-V-2AP4-85
					1492028 VZWD-L-M22C-M-N18-15-V-3AP4-85
					1491872 VZWD-L-M22C-M-N18-15-V-1P4-85
		2	0 ... 40	550	1491951 VZWD-L-M22C-M-N18-20-V-2AP4-40
					1492029 VZWD-L-M22C-M-N18-20-V-3AP4-40
					1491873 VZWD-L-M22C-M-N18-20-V-1P4-40
		2.5	0 ... 22	550	1491952 VZWD-L-M22C-M-N18-25-V-2AP4-22
					1492030 VZWD-L-M22C-M-N18-25-V-3AP4-22
					1491874 VZWD-L-M22C-M-N18-25-V-1P4-22
		3	0 ... 15	550	1491953 VZWD-L-M22C-M-N18-30-V-2AP4-15
					1492031 VZWD-L-M22C-M-N18-30-V-3AP4-15
					1491875 VZWD-L-M22C-M-N18-30-V-1P4-15
		4	0 ... 8	550	1491954 VZWD-L-M22C-M-N18-40-V-2AP4-8
					1492032 VZWD-L-M22C-M-N18-40-V-3AP4-8
					1491876 VZWD-L-M22C-M-N18-40-V-1P4-8

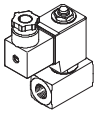
Ordering data					
	Process valve connection	Nominal size	Operating pressure	Product weight	Brass housing
		DN	[bar]	[g]	Part No. Type
	NPT $\frac{1}{8}$	5	0 ... 5	600	1491877 VZWD-L-M22C-M-N18-50-V-1P4-5
					1491955 VZWD-L-M22C-M-N18-50-V-2AP4-5
					1492033 VZWD-L-M22C-M-N18-50-V-3AP4-5
		6	0 ... 4	600	1491878 VZWD-L-M22C-M-N18-60-V-1P4-4
					1491956 VZWD-L-M22C-M-N18-60-V-2AP4-4
					1492034 VZWD-L-M22C-M-N18-60-V-3AP4-4

Solenoid valves VZWD, directly actuated, NPT

Technical data – Stainless steel housing



Function

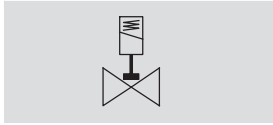

-  - Flow rate Kv
0.06 ... 0.4 m³/h

-N- Connecting thread
N¹/₄, N¹/₈



General technical data								
Nominal size (DN)	1.0	1.5	2.0	2.5	3.0	4.0	5.0	6.0
Valve function	2/2-way, single solenoid, closed							
Design	Directly actuated poppet valve							
Type of mounting	In-line installation							
Actuation type	Electric							
Reset method	Mechanical spring							
Type of control	Direct							
Manual override	None							
Mounting position	Any							
Sealing principle	Soft							
Direction of flow	Non-reversible							
Max. viscosity [mm ² /s]	22							
Protection class	IP65							

Operating and environmental conditions								
Nominal size (DN)	1.0	1.5	2.0	2.5	3.0	4.0	5.0	6.0
Standard nominal flow rate [l/min]	60	95	140	170	210	310	375	430
Flow rate [m ³ /h]	0.06	0.09	0.13	0.16	0.2	0.3	0.35	0.4
Process valve nominal pressure (PN)	100							
Process valve operating medium	Filtered compressed air, grade of filtration 40 µm, lubricated or unlubricated, neutral gases, vacuum, neutral liquids, water, mineral oil							
Differential pressure [bar]	0							
Ambient temperature [°C]	-10 ... +35 °C							
Temperature of medium [°C]	-10 ... +80 °C							
Leak rate to EN 12266-1	A							
Corrosion resistance class CRC ¹⁾	3							

- 1) Corrosion resistance class 3 according to Festo standard 940 070
Components subject to high corrosion stress. Externally visible parts with primarily decorative surface requirements which are in direct contact with a normal industrial environment or media such as solvents and cleaning agents.

Solenoid valves VZWD, directly actuated, NPT

Technical data – Stainless steel housing

Electrical data		VZWD- ... 1	VZWD- ... 2A	VZWD- ... 3A
Electrical connection		Plug to EN 175301-803 type A, square design		
CE marking		–	73/23/EEC	73/23/EEC
Insulation class		H	F	F
Duty cycle	[%]	100		
Permissible voltage fluctuations	[%]	±10		
Coil characteristics	Direct current DC	[V]	24	–
	Alternating current AC	[V]	–	110
		[W]	11	–
	Pick-up power	[VA]	–	10.5
	Holding power	[VA]	–	8
		[Hz]	–	50, 60
	Switching time on	[ms]	20	
Switching time off	[ms]	18		

Materials		
Solenoid valves		Material number
1 Housing	High-alloy stainless steel	1.4305
2 Seals	FPM	
– Note on materials	Contains PWIS (paint-wetting impairment substances), RoHS-compliant	

Dimensions Download CAD data → www.festo.com/en/engineering

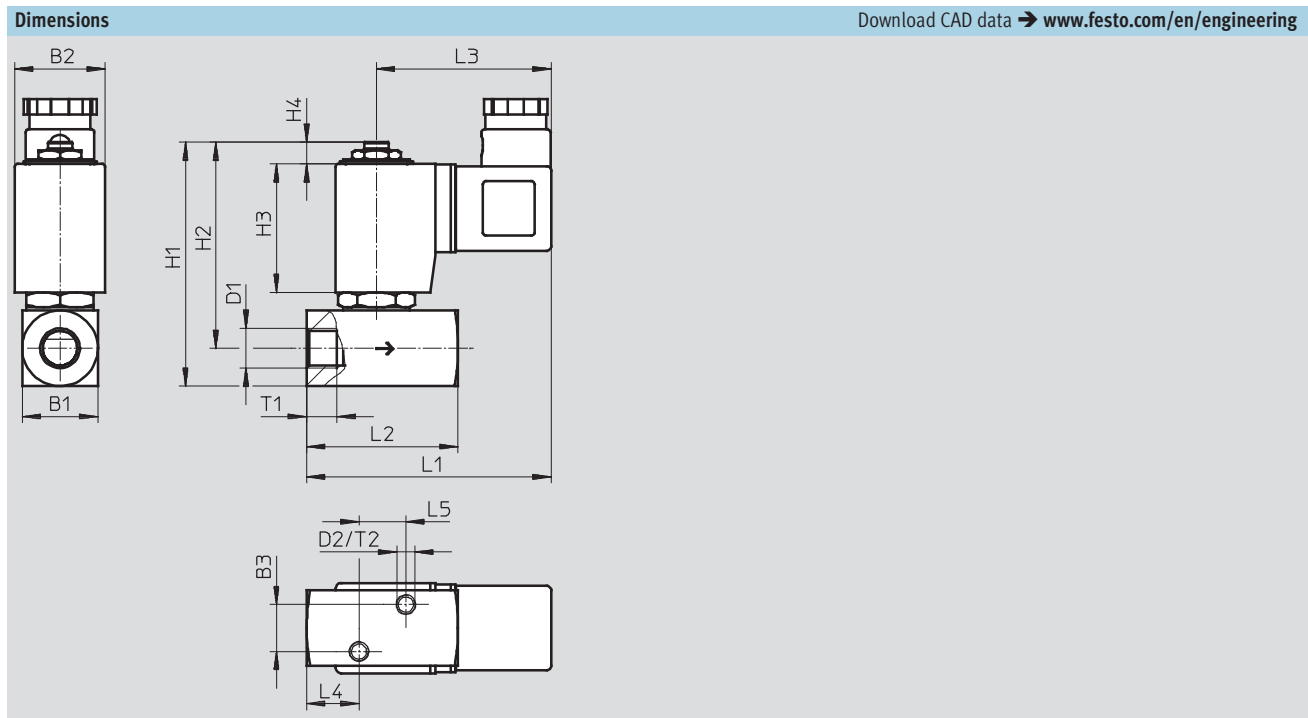

Type	B1	B2	B3	D1	D2	H1	H2	H3	H4	L1	L2	L3	L4	L5	T1	T2
VZWD-...-N $\frac{1}{8}$ -50-...-5	25	30	15.5	NPT $\frac{1}{8}$	M6	81	68	42.5	7	78	40	58	12	15.5	8	6
VZWD-...-N $\frac{1}{8}$ -60-...-4																
VZWD-...-N $\frac{1}{4}$ -50-...-5	25	30	15.5	NPT $\frac{1}{4}$	M6	81	68	42.5	7	85	50	58	17	15.5	10	6
VZWD-...-N $\frac{1}{4}$ -60-...-4																

Solenoid valves VZWD, directly actuated, NPT

Technical data – Stainless steel housing

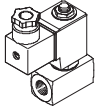

Ordering data – Solenoid valve VZWD						
	Process valve connection	Nominal size DN	Operating pressure [bar]	Product weight [g]	Stainless steel casting housing	
					Part No.	Type
	NPT $\frac{1}{4}$	1	0 ... 90	650	1491895	VZWD-L-M22C-M-N14-10-V-1P4-90-R1
					1491973	VZWD-L-M22C-M-N14-10-V-2AP4-90-R1
					1492090	VZWD-L-M22C-M-N14-10-V-3AP4-90-R1
		1.5	0 ... 85	650	1491896	VZWD-L-M22C-M-N14-15-V-1P4-85-R1
					1491974	VZWD-L-M22C-M-N14-15-V-2AP4-85-R1
					1492091	VZWD-L-M22C-M-N14-15-V-3AP4-85-R1
		2	0 ... 40	650	1491897	VZWD-L-M22C-M-N14-20-V-1P4-40-R1
					1491975	VZWD-L-M22C-M-N14-20-V-2AP4-40-R1
					1492092	VZWD-L-M22C-M-N14-20-V-3AP4-40-R1
		2.5	0 ... 22	650	1491898	VZWD-L-M22C-M-N14-25-V-1P4-22-R1
					1491976	VZWD-L-M22C-M-N14-25-V-2AP4-22-R1
					1492093	VZWD-L-M22C-M-N14-25-V-3AP4-22-R1
		3	0 ... 15	650	1491899	VZWD-L-M22C-M-N14-30-V-1P4-15-R1
					1491977	VZWD-L-M22C-M-N14-30-V-2AP4-15-R1
					1492094	VZWD-L-M22C-M-N14-30-V-3AP4-15-R1
		4	0 ... 8	650	1491900	VZWD-L-M22C-M-N14-40-V-1P4-8-R1
					1491978	VZWD-L-M22C-M-N14-40-V-2AP4-8-R1
					1492095	VZWD-L-M22C-M-N14-40-V-3AP4-8-R1
		5	0 ... 5	650	1491901	VZWD-L-M22C-M-N14-50-V-1P4-5-R1
					1491979	VZWD-L-M22C-M-N14-50-V-2AP4-5-R1
					1492096	VZWD-L-M22C-M-N14-50-V-3AP4-5-R1
		6	0 ... 4	650	1491902	VZWD-L-M22C-M-N14-60-V-1P4-4-R1
					1491980	VZWD-L-M22C-M-N14-60-V-2AP4-4-R1
					1492097	VZWD-L-M22C-M-N14-60-V-3AP4-4-R1

Solenoid valves VZWD, directly actuated, NPT

Technical data – Stainless steel housing

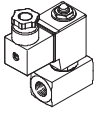
Ordering data – Solenoid valve VZWD						
	Process valve connection	Nominal size DN	Operating pressure [bar]	Product weight [g]	Stainless steel casting housing	
					Part No.	Type
	NPT $\frac{1}{8}$	1	0 ... 90	500	1491887	VZWD-L-M22C-M-N18-10-V-1P4-90-R1
					1491965	VZWD-L-M22C-M-N18-10-V-2AP4-90-R1
					1492048	VZWD-L-M22C-M-N18-10-V-3AP4-90-R1
		1.5	0 ... 85	500	1491888	VZWD-L-M22C-M-N18-15-V-1P4-85-R1
					1491966	VZWD-L-M22C-M-N18-15-V-2AP4-85-R1
					1492049	VZWD-L-M22C-M-N18-15-V-3AP4-85-R1
		2	0 ... 40	500	1491889	VZWD-L-M22C-M-N18-20-V-1P4-40-R1
					1491967	VZWD-L-M22C-M-N18-20-V-2AP4-40-R1
					1492050	VZWD-L-M22C-M-N18-20-V-3AP4-40-R1
		2.5	0 ... 22	500	1491890	VZWD-L-M22C-M-N18-25-V-1P4-22-R1
					1491968	VZWD-L-M22C-M-N18-25-V-2AP4-22-R1
					1492051	VZWD-L-M22C-M-N18-25-V-3AP4-22-R1
		3	0 ... 15	500	1491891	VZWD-L-M22C-M-N18-30-V-1P4-15-R1
					1491969	VZWD-L-M22C-M-N18-30-V-2AP4-15-R1
					1492052	VZWD-L-M22C-M-N18-30-V-3AP4-15-R1
		4	0 ... 8	500	1491892	VZWD-L-M22C-M-N18-40-V-1P4-8-R1
					1491970	VZWD-L-M22C-M-N18-40-V-2AP4-8-R1
					1492053	VZWD-L-M22C-M-N18-40-V-3AP4-8-R1
		5	0 ... 5	500	1491893	VZWD-L-M22C-M-N18-50-V-1P4-5-R1
					1491971	VZWD-L-M22C-M-N18-50-V-2AP4-5-R1
					1492054	VZWD-L-M22C-M-N18-50-V-3AP4-5-R1
		6	0 ... 4	500	1491894	VZWD-L-M22C-M-N18-60-V-1P4-4-R1
					1491972	VZWD-L-M22C-M-N18-60-V-2AP4-4-R1
					1492055	VZWD-L-M22C-M-N18-60-V-3AP4-4-R1

Product Range and Company Overview

A Complete Suite of Automation Services

Our experienced engineers provide complete support at every stage of your development process, including: conceptualization, analysis, engineering, design, assembly, documentation, validation, and production.



Custom Automation Components
Complete custom engineered solutions



Custom Control Cabinets
Comprehensive engineering support and on-site services



Complete Systems
Shipment, stocking and storage services

The Broadest Range of Automation Components

With a comprehensive line of more than 30,000 automation components, Festo is capable of solving the most complex automation requirements.



Electromechanical
Electromechanical actuators, motors, controllers & drives



Pneumatics
Pneumatic linear and rotary actuators, valves, and air supply



PLCs and I/O Devices
PLC's, operator interfaces, sensors and I/O devices

Supporting Advanced Automation... As No One Else Can!

Festo is a leading global manufacturer of pneumatic and electromechanical systems, components and controls for industrial automation, with more than 12,000 employees in 56 national headquarters serving more than 180 countries. For more than 80 years, Festo has continuously elevated the state of manufacturing with innovations and optimized motion control solutions that deliver higher performing, more profitable automated manufacturing and processing equipment. Our dedication to the advancement of automation extends beyond technology to the education and development of current and future automation and robotics designers with simulation tools, teaching programs, and on-site services.

Quality Assurance, ISO 9001 and ISO 14001 Certifications

Festo Corporation is committed to supply all Festo products and services that will meet or exceed our customers' requirements in product quality, delivery, customer service and satisfaction.

To meet this commitment, we strive to ensure a consistent, integrated, and systematic approach to management that will meet or exceed the requirements of the ISO 9001 standard for Quality Management and the ISO 14001 standard for Environmental Management.



© Copyright 2008, Festo Corporation. While every effort is made to ensure that all dimensions and specifications are correct, Festo cannot guarantee that publications are completely free of any error, in particular typing or printing errors. Accordingly, Festo cannot be held responsible for the same. For Liability and Warranty conditions, refer to our "Terms and Conditions of Sale", available from your local Festo office. All rights reserved. No part of this publication may be reproduced, distributed, or transmitted in any form or by any means, electronic, mechanical, photocopying or otherwise, without the prior written permission of Festo. All technical data subject to change according to technical update.



Printed on recycled paper at New Horizon Graphic, Inc., FSC certified as an environmentally friendly printing plant.

Festo North America

Festo Regional Contact Center

5300 Explorer Drive
Mississauga, Ontario L4W 5G4
Canada

USA Customers:

For ordering assistance,

Call: 1.800.99.FESTO (1.800.993.3786)

Fax: 1.800.96.FESTO (1.800.963.3786)

Email: customer.service@us.festo.com

For technical support,

Call: 1.866.GO.FESTO (1.866.463.3786)

Fax: 1.800.96.FESTO (1.800.963.3786)

Email: product.support@us.festo.com

Canadian Customers:

Call: 1.877.GO.FESTO (1.877.463.3786)

Fax: 1.877.FX.FESTO (1.877.393.3786)

Email: festo.canada@ca.festo.com

USA Headquarters

Festo Corporation
395 Moreland Road
P.O. Box 18023
Hauppauge, NY 11788, USA
www.festo.com/us

USA Sales Offices

Appleton

North 922 Tower View Drive, Suite N
Greenville, WI 54942, USA

Boston

120 Presidential Way, Suite 330
Woburn, MA 01801, USA

Chicago

1441 East Business Center Drive
Mt. Prospect, IL 60056, USA

Dallas

1825 Lakeway Drive, Suite 600
Lewisville, TX 75057, USA

Detroit – Automotive Engineering Center

2601 Cambridge Court, Suite 320
Auburn Hills, MI 48326, USA

New York

395 Moreland Road
Hauppauge, NY 11788, USA

Silicon Valley

4935 Southfront Road, Suite F
Livermore, CA 94550, USA

United States



USA Headquarters, East: Festo Corp., 395 Moreland Road, Hauppauge, NY 11788

Phone: 1.631.435.0800; Fax: 1.631.435.8026;

Email: info@festo-usa.com

www.festo.com/us

Canada



Headquarters: Festo Inc., 5300 Explorer Drive, Mississauga, Ontario L4W 5G4

Phone: 1.905.624.9000; Fax: 1.905.624.9001;

Email: festo.canada@ca.festo.com

www.festo.ca

Mexico



Headquarters: Festo Pneumatic, S.A., Av. Ceylán 3, Col. Tequesquahuac,
54020 Tlalneantla, Edo. de México

Phone: 011 52 [55] 53 21 66 00; Fax: 011 52 [55] 53 21 66 65;

Email: festo.mexico@mx.festo.com

www.festo.com/mx

Central USA

Festo Corporation
1441 East Business
Center Drive
Mt. Prospect, IL 60056, USA
Phone: 1.847.759.2600
Fax: 1.847.768.9480



Western USA

Festo Corporation
4935 Southfront Road,
Suite F
Livermore, CA 94550, USA
Phone: 1.925.371.1099
Fax: 1.925.245.1286



Festo Worldwide

Argentina Australia Austria Belarus Belgium Brazil Bulgaria Canada Chile China Colombia Croatia Czech Republic Denmark
Estonia Finland France Germany Great Britain Greece Hong Kong Hungary India Indonesia Iran Ireland Israel Italy Japan Latvia
Lithuania Malaysia Mexico Netherlands New Zealand Norway Peru Philippines Poland Romania Russia Serbia Singapore
Slovakia Slovenia South Africa South Korea Spain Sweden Switzerland Taiwan Thailand Turkey Ukraine United States Venezuela

www.festo.com