

Proximity sensors SMT/SME-8, for T-slot



Proximity sensors SMT/SME

Product range overview

FESTO

Design	Type of mounting	Measuring principle	Type	Operating voltage range	Switching output	Switching element function	→ Page/Internet
For T-slot	Standard						
	Insertable in slot from above, flush with cylinder profile	Magneto-resistive	SMT-8M	10 ... 30 V DC	PNP	N/O contact	9
						N/C contact	
				NPN	N/O contact		
		8 ... 30 V DC	Contactless, 2-wire	N/O contact			
		Magnetic reed	SME-8M	5 ... 30 V AC/DC	Contacting, bipolar	N/O contact	15
					N/C contact		
	Insertable in slot lengthwise, flush with cylinder profile	Magneto-resistive	SMT-8	10 ... 30 V DC	PNP	N/O contact	22
					NPN		
	Insertable in slot lengthwise, flush with cylinder profile	Magnetic reed	SME-8	12 ... 30 V AC/DC	Contacting, bipolar	N/O contact	26
						N/C contact	
				3 ... 230 V AC/DC		N/O contact	29
	Insertable in slot lengthwise	Magneto-resistive	SMT-8G	10 ... 30 V DC	PNP	N/O contact	31
		Magneto-resistive	SMT-8-SL	10 ... 30 V DC	PNP	N/O contact	22
		Magnetic reed	SME-8-SL	10 ... 30 V AC/DC	Contacting, bipolar	N/O contact	26
	Insertable in slot from above	Magnetic reed	SME-8-FM	10 ... 30 V AC/DC	Contacting, bipolar	N/O contact	35
	Via accessories	Magneto-resistive	SMT0-8E	10 ... 30 V DC	PNP	N/O contact	38
					NPN		
		Magnetic reed	SME0-8E	12 ... 30 V DC	Contacting, bipolar	N/O contact	42
			3 ... 250 V DC				
				3 ... 230 V AC			
	Corrosion resistant						
	Insertable in slot lengthwise, flush with cylinder profile	Magneto-resistive	CRSMT-8	10 ... 30 V DC	PNP	N/O contact	22
Welding field immune							
Via accessories	Magneto-inductive	SMTSO-8E	10 ... 30 V DC	PNP	N/O contact	38	
				NPN			
Heat resistant up to 120 °C							
Insertable in slot lengthwise, flush with cylinder profile	Magnetic reed	SME-8-...-S6	0 ... 30 V AC/DC	Contacting, bipolar	N/O contact	29	
Via accessories	Magnetic reed	SME0-8E-...-S6	0 ... 30 V DC	Contacting	N/O contact	42	
			0 ... 30 V AC				

Proximity sensors SMT/SME

Product range overview

Design	Type of mounting	Measuring principle	Type	Operating voltage range	Switching output	Switching element function	→ Page/Internet
For C-slot	Standard						
	Insertable in slot from above, flush with cylinder profile	Magneto-resistive	SMT-10F	5 ... 30 V DC	PNP	N/O contact	c-slot
				10 ... 30 V DC	NPN		
		Magnetic reed	SME-10F	10 ... 30 V AC/DC	Contacting, bipolar	N/O contact	
				5 ... 30 V AC/DC			
	Insertable in slot lengthwise	Magneto-resistive	SMT-10G	10 ... 30 V DC	PNP	N/O contact	
		Magneto-resistive	SMT-10	10 ... 30 V DC	PNP	N/O contact	
					NPN		
Magnetic reed	SME-10	12 ... 27 V AC/DC	Contacting	N/O contact			

Proximity sensors SMT/SME

Selection aid

FESTO

Drive		SMT-8, SMTO-8E CRSMT-8 SME-8, SMEO-8E SMPO-8E	SMT-10 SME-10	SMTO-4U SMEO-4U CRSMEO-4	SMTO-1 SMTO-6 SMEO-1 SMPO-1	SMT-C1
Standards-based cylinders						
Standard cylinders DSNU, ESNU	∅ 8 ... 25 mm	■	■	■	■	-
Standard cylinders DSN, ESN	∅ 8 ... 25 mm	■	■	■	■	-
Standard cylinders DNCB		■	-	-	-	-
Standard cylinders DNC		■	-	-	-	-
Standard cylinders DNG		■	-	-	■	-
Standard cylinders CDN...-R with sensor rail		-	-	-	-	■
Standard cylinders ADN		■	-	-	-	-
Cylinders with piston rod						
Compact cylinders ADVU, AEVU		■	-	-	-	-
Short-stroke cylinders ADVC, AEVC	∅ 6 ... 25 mm	-	■	-	-	-
	∅ 32 ... 100 mm	■	-	-	-	-
Flat cylinders EZH-10/40-40-A-B		■	-	-	-	-
Flat cylinders DZF		■	-	-	-	-
Flat cylinders DZH	∅ 16 ... 25 mm	■	-	-	-	-
	∅ 32 ... 63 mm	-	-	-	■	-
Round cylinders DSNU, ESNU	∅ 32 ... 63 mm	■	■	■	■	-
Round cylinders DSW, ESW		■	■	■	■	-
Round cylinders DSEU, ESEU		■	■	■	■	-
Multimount cylinders DMM, EMM		■	-	-	-	-
Round cylinders CRDG		-	-	■	-	-
Round cylinders CRDSW		■	■	■	■	-
Standard cylinders CRHD		■	-	-	-	-
Standard cylinders CRDSNU		■	-	■	-	-
Standard cylinders CRDNG		■	-	■	-	-
Standard cylinders CRDNGS		■	-	■	-	-
Rodless cylinders						
Linear drives DGC	∅ 8, 12 mm	-	■	-	-	-
	∅ 18 ... 63 mm	■	-	-	-	-
Linear drives DGP, DGPL		■	-	-	-	-
Linear drives SLG		-	■	-	-	-
Linear drives DGO		-	-	■	-	-
Linear drives SLM		■	-	-	-	-
Semi-rotary drives						
Semi-rotary drives DSM	∅ 6 ... 10 mm	-	■	-	-	-
Semi-rotary drives DSM-B	∅ 12 ... 40 mm	-	■	-	-	-
	∅ 63 mm	■	-	-	-	-
Semi-rotary drives DRQ	∅ 16 ... 32 mm	■	-	-	-	-
	∅ 40 ... 100 mm	-	-	-	■	-
Semi-rotary drives DRQD	∅ 6 ... 12 mm	-	■	-	-	-
	∅ 16 ... 32 mm	■	-	-	-	-
Technical data → Page/Internet		9	c-slot	smto, crsmeo	smto	smt-c1

Proximity sensors SMT/SME

Selection aid

FESTO

Drive	SMT-8, SMTO-8E CRSMT-8 SME-8, SMEO-8E, SMPO-8E	SMT-10 SME-10	SMH-S1
Function-oriented drives			
Stopper cylinders STA, STAF	■	-	-
Linear/swivel clamps CLR	■	-	-
Swivel/linear units DSL	■	-	-
Swivel/linear units DSL-B	-	■	-
Drives with linear guide			
Mini slides SLS, SLF, SLT	-	■	-
Mini slides DGSL	-	■	-
Twin-piston cylinders SPZ	■	-	-
Slide units SLZ	■	-	-
Guided drives DFP	∅ 6 ... 16 mm	-	■
	∅ 25 ... 80 mm	■	-
Mini guide units DFC	-	■	-
Guide units DFM	■	-	-
Guide units DFM-B	■ ¹⁾	-	-
Linear drive units SLE	∅ 32 ... 50 mm	■	-
Twin-piston cylinders DPZ	■	-	-
Handling units			
Linear modules HMP	■	-	-
Linear modules HMPL	■	-	-
Handling modules HSP, HSW	■	-	-
Feed separators HPV	■	-	-
Three-point grippers DHDS	∅ 16 mm	-	■
	∅ 32, 50 mm	■ ²⁾	-
Three-point grippers HGDT	-	■	-
Parallel grippers DHPS	∅ 6 mm	-	■
	∅ 10 ... 35 mm	■ ²⁾	-
Parallel grippers HGPC	-	■	-
Parallel grippers HGPP	∅ 12 ... 32 mm	-	■
Parallel grippers HGPT	∅ 16 ... 63 mm	-	■
Angle grippers DHWS	∅ 10 mm	-	■
	∅ 16 ... 40 mm	■	-
Radial grippers DHRS	∅ 10 mm	-	■
	∅ 16 ... 40 mm	■	-
Swivel gripper units HGDS	-	■	-
Cushioning components			
Stop elements YSRWJ	■	-	-
Electrical positioning systems			
Toothed belt axes DGE-ZR	■	-	-
Spindle axes DGE-SP	■	-	-
System components			
Heavy-duty guides HD	■	-	-
Valve actuators			
Linear actuators, Copac DLP-A	■	-	-
Technical data → Page/Internet	9	c-slot	smh

1) Not SM...O-8E.

2) SME-8M only for DHDS-50, DHPS-20 ... 35.

Proximity sensors SMT/SME-8, for T-slot

Peripherals overview

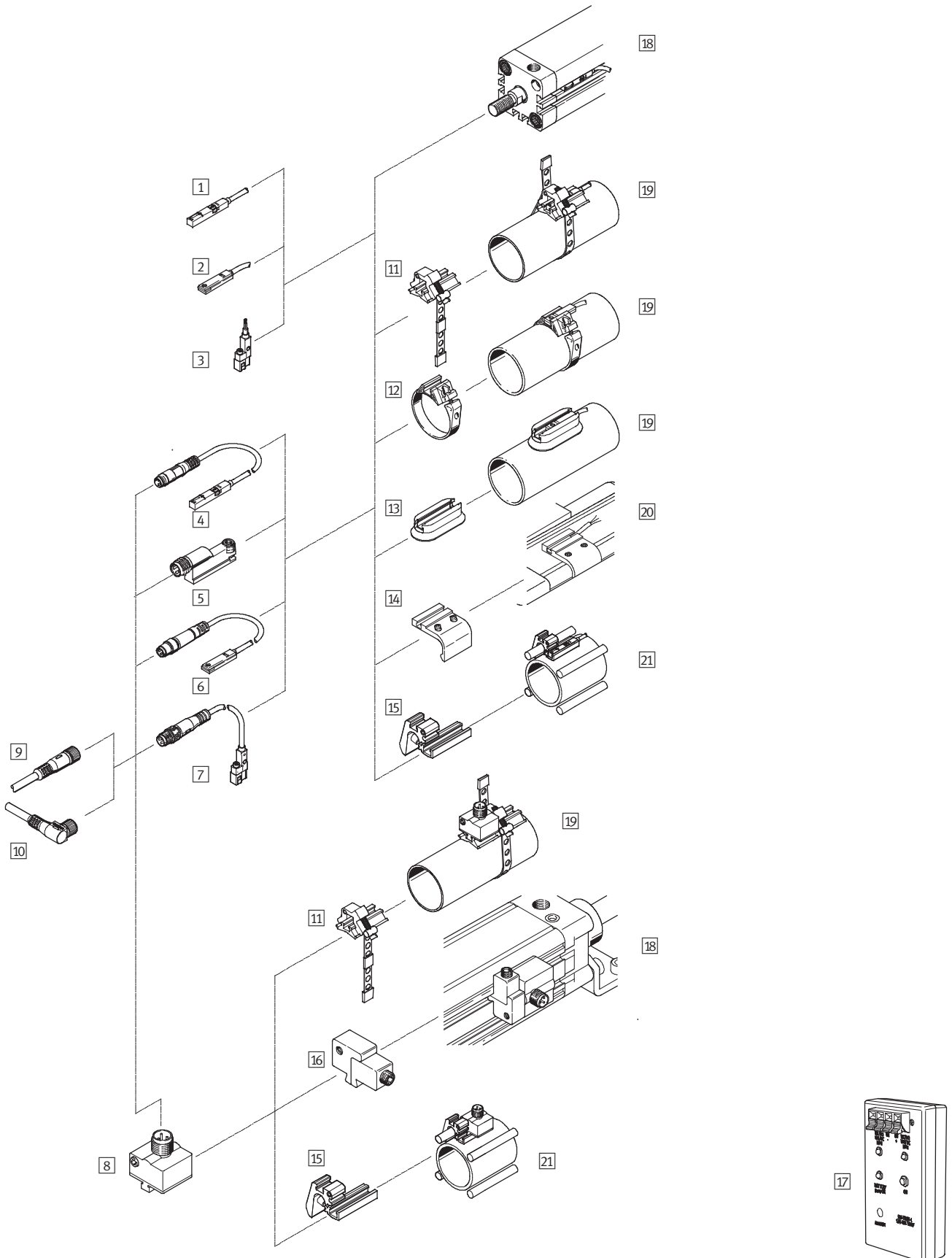

Proximity sensors SMT/SME-8, for T-slot

Peripherals overview



Mounting attachments and accessories		→ Page/ Internet
Proximity sensors		
1	SMT/SME-8M-...-OE, with cable	9
2	SMT/SME-8-K-..., with cable	22
	SME-8-FM-...-K-..., with cable	35
	CRSMT-8-K-..., with cable, corrosion resistant	22
3	SMT-8G-...-OE, with cable	32
4	SMT/SME-8M-...-M..., with cable and plug	9
5	SMT-8-SL-..., with plug	22
	SME-8-SL-..., with plug	26
6	SMT-8-S-..., with cable and plug	22
	SME-8-S-..., with cable and plug	26
7	SMT-8G-...-M..., with cable and plug	32
8	SMT0/SMTSO, with plug	38
	SME0-8E, with cable or plug	42
Connecting cables		
9	NEBU-M...G...	49
10	NEBU-M...W...	49

Mounting attachments and accessories		→ Page/ Internet
Mounting kits and accessories		
11	Mounting kit SMBR-8-8/100-S6, heat resistant	46
12	Mounting kit SMBR	46
13	Mounting kit CRSMB, corrosion resistant	47
13	Mounting kit SMB-8-FENG	47
15	Mounting SMBZ-8-...	48
16	Mounting kit SMB-8E	47
17	Sensor tester SM-TEST-1	49
-	Positioning component SMM-8	48
-	Clip SMBK-8	49
-	Inscription label ASLR	49
-	Safety clip NEAU	49
Drives		
18	Drives with T-slot	-
19	Round cylinders	-
20	Standard cylinders DNC, DNCB, DNCKE	-
21	Drives with tie or mounting rod	-

Proximity sensors SMT/SME-8M, for T-slot

Type codes

FESTO

SMT/SME-8M

SMT - 8M - PO - 24V - K - 7,5 - OE -

Function	
SMT	Proximity sensor, magneto-resistive
SME	Proximity sensor, magnetic reed

Design	
8M	For T-slot, insertable in slot from above

Switching output, switching element function	
PS	PNP, N/O contact, 3-wire
PO	PNP, N/C contact, 3-wire
NS	NPN, N/O contact, 3-wire
ZS	N/O contact, 2-wire
DS	N/O contact, 3-wire
DO	N/C contact, 3-wire

Rated operating voltage	
24V	24 V DC

Cable properties	
K	Standard + energy chain
E	Energy chain + robot applications

Cable length [m]	
7,5	

Electrical connection	
OE	Open end
M8	Cable with plug M8x1, snap-on flange
M8D	Cable with plug M8x1, rotatable thread
M12	Cable with plug M12x1, rotatable thread

EU certification	
EX2	II 3GD to EU Directive 94/9/EG

Proximity sensors SMT-8M, for T-slot

Technical data – Magneto-resistive

Function

e.g. PNP, N/O contact, with cable

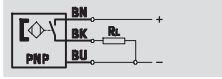

e.g. NPN, N/O contact, with cable

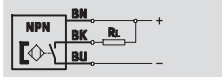

- Magneto-resistive measuring principle
- Insertable in slot from above, does not protrude over the cylinder profile
- Cable clip and inscription labels included in the scope of delivery
- Variant EX2 for use in potentially explosive areas in zones 2 and 22

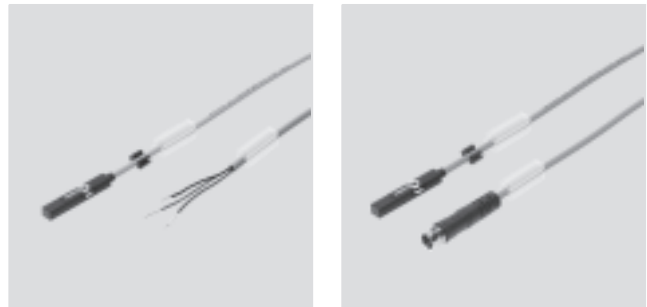

General technical data	
Design	For T-slot
Based on standard	EN 60947-5-2
Certification	c UL us - Listed (OL) C-Tick
CE mark (see declaration of conformity)	To EU EMC Directive
Note on materials	Free of copper and PTFE RoHS-compliant

Input signal/measuring element	
Measuring principle	Magneto-resistive
Ambient temperature [°C]	-20 ... +70

Switching output				
Type	SMT-8M-PS	SMT-8M-NS	SMT-8M-PO	SMT-8M-ZS
Switching output	PNP	NPN	PNP	Contactless, 2-wire
Switching element function	N/O contact		N/C contact	N/O contact
Max. output current [mA]	100			80
Max. switching capacity DC [W]	3			2.4
Voltage drop ¹⁾ [V]	≤2			≤6

1) Applies to cable length 2.5 m. Max. 0.03 V voltage drop per metre of additional cable length

Output, additional data	
Protection against short circuit	Pulsed
Protection against overloading	Yes

Electronic components				
Type	SMT-8M-PS	SMT-8M-NS	SMT-8M-PO	SMT-8M-ZS
Operating voltage range [V DC]	10 ... 30			8 ... 30
Reverse polarity protection	For all electrical connections			

Proximity sensors SMT-8M, for T-slot

Technical data – Magneto-resistive

FESTO

Electromechanical components				
Electrical connection	OE	M8D	M8	M12
Electrical connection	Cable, 3-wire	Cable with plug, 3-pin		
		M8x1	M8x1	M12x1
		Rotatable thread	Snap-on flange	Rotatable thread
Connection direction	In-line			
Cable test conditions	K	Energy chain: 5 million cycles, bending radius 75 mm		
		Resistance to bending: to Festo standard; test conditions on request		
	E	Energy chain: 5 million cycles, bending radius 28 mm		
		Torsional strength: $\pm 270^\circ/0.1\text{ m}$ Resistance to bending: to Festo standard; test conditions on request		
Cable length	[m]	0.2 ... 30		
Cable properties	K	Standard + energy chain		
	E	Energy chain + robot applications		
Cable sheath material	K	TPE-U(PU), oil resistant		
	E	TPE-U(PU), oil resistant, halogen free		

Mechanical components		
Electrical connection	OE	M...
Type of mounting	Screw-clamped in slot, insertable from above	
Housing	PA	PA
	High-alloy stainless steel	High-alloy stainless steel
	–	Nickel-plated brass
	–	TPE-U(PU)

Display/operation	
Switching status display	Yellow LED

Immissions/emissions	
Ambient temperature with flexible cable installation [°C]	–5 ... +70
Protection class	IP65, IP68

ATEX	
SMT-8M-ZS-...-	EX2
ATEX category gas	II 3G
Ex-ignition protection type gas	Ex nA II T4 X
ATEX category dust	II 3D
EX-ignition protection type dust	Ex tD A22 IP65 T120°C X
ATEX ambient temperature	$-20\text{ °C} \leq T_a \leq +70\text{ °C}$
ATEX certification	For zones 2 and 22
CE mark (see declaration of conformity)	To EU Explosion Protection Directive (ATEX)

Proximity sensors SMT-8M, for T-slot

Technical data – Magneto-resistive

Pin allocation to EN 60947-5-2			
M8x1, 2-pin			
N/O contact			
	Pin	Wire colour	Allocation
	1	Brown	+
	4	Black	Output

Pin allocation to EN 60947-5-2			
M12x1, 2-pin			
N/O contact			
	Pin	Wire colour	Allocation
	1	Brown	+
	4	Black	Output

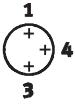
Pin allocation to EN 60947-5-2			
MM8x1, 3-pin			
N/O contact and N/C contact			
	Pin	Wire colour	Allocation
	1	Brown	+
	3	Blue	-
	4	Black	Output

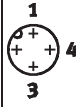
Pin allocation to EN 60947-5-2			
M12x1, 3-pin			
N/O contact			
	Pin	Wire colour	Allocation
	1	Brown	+
	3	Blue	-
	4	Black	Output

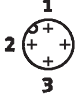
Pin allocation to EN 60947-5-2			
M12x1, 3-pin			
N/C contact			
	Pin	Wire colour	Allocation
	1	Brown	+
	3	Blue	-
	4	White	Output

Proximity sensors SMT-8M, for T-slot

Technical data – Magneto-resistive

Dimensions

Download CAD Data → www.festo.com/us/cad

SMT-8M-...-OE – Cable

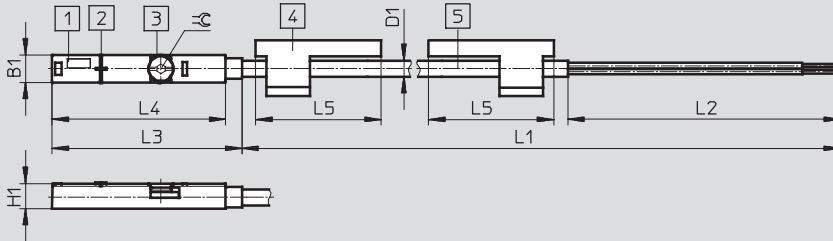

- 1 Yellow LED
- 2 Centre of the sensor element
- 3 Clamping component, tightening torque 0.6 Nm
- 4 Inscription label holder
- 5 Connecting cable

L1 Cable length

SMT-8M-...-M8D – Cable with plug M8x1, rotatable thread

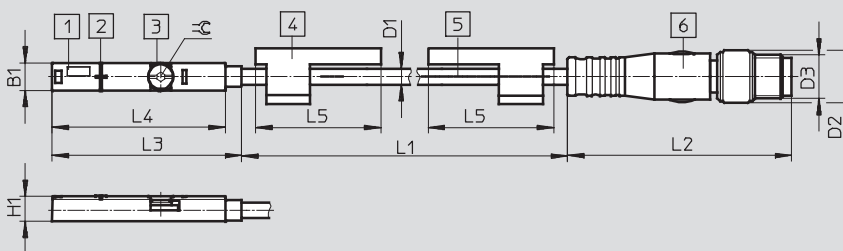

- 1 Yellow LED
- 2 Centre of the sensor element
- 3 Clamping component, tightening torque 0.6 Nm
- 4 Inscription label holder
- 5 Connecting cable
- 6 Plug to fit connecting cable NEBU-M8

L1 Cable length

SMT-8M-...-M8 – Cable with plug M8x1, snap-on flange

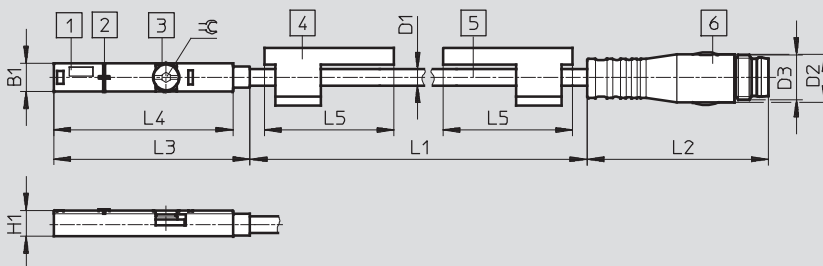

- 1 Yellow LED
- 2 Centre of the sensor element
- 3 Clamping component, tightening torque 0.6 Nm
- 4 Inscription label holder
- 5 Connecting cable
- 6 Plug to fit connecting cable NEBU-M8

L1 Cable length

SMT-8M-...-M12 – Cable with plug M12x1, rotatable thread

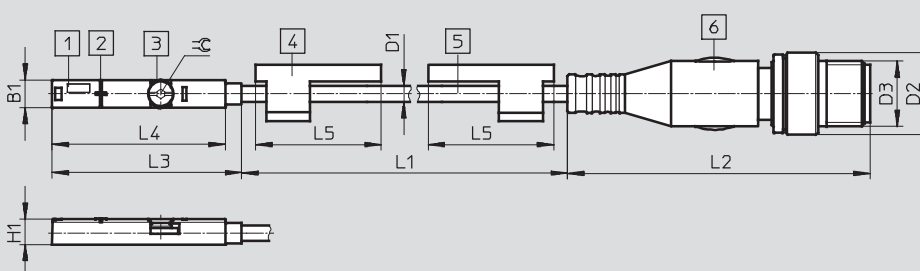

- 1 Yellow LED
- 2 Centre of the sensor element
- 3 Clamping component, tightening torque 0.6 Nm
- 4 Inscription label holder
- 5 Connecting cable
- 6 Plug to fit connecting cable NEBU-M12



L1 Cable length

Type	B1	D1	D2	D3	H1	L2	L3	L4	L5	⌀
SMT-8M-...-OE	5	2.9	-	-	4.6	50	34.8	31.8	23	1.5
SMT-8M-...-M8D			9.6	M8x1		41				
SMT-8M-...-M8			8.8	M8x1		35				
SMT-8M-...-M12			15	M12x1		55.5				

Proximity sensors SMT-8M, for T-slot

Technical data – Magneto-resistive

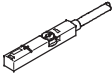
FESTO

Ordering data							
	Switching output	Electrical connection			Cable length [m]	Part No.	Type
		Cable	Cable with plug, rotatable thread				
			M8x1	M12x1			
	N/O contact						
	PNP	3-wire	–	–	2.5	543867	SMT-8M-PS-24V-K-2,5-OE
			–	–	5.0	543868	SMT-8M-PS-24V-K-5,0-OE
		–	3-pin	–	0.3	543866	SMT-8M-PS-24V-K-0,3-M8D
			–	3-pin		543869	SMT-8M-PS-24V-K-0,3-M12
	NPN	3-wire	–	–	2.5	543870	SMT-8M-NS-24V-K-2,5-OE
			–	3-pin	–	0.3	543871
	Contactless, 2-wire	2-wire	–	–	5.0	543874	SMT-8M-ZS-24V-K-5,0-OE-EX2 
	N/C contact						
	PNP	3-wire	–	–	7.5	543873	SMT-8M-PO-24V-K-7,5-OE

New
SMT-8M-ZS-...-EX2

Proximity sensors SMT-8M, for T-slot

Modular products – Magneto-resistive



M Mandatory data							O Options
Module No.	Function	Switching output	Rated operating voltage	Cable characteristics	Cable length	Connection technology	EU certification
543893	SMT-8M	PS NS PO ZS	24V	K E	0.2 ... 30	OE M8D M8 M12	EX2
Ordering example							
543893	SMT-8M	- NS	- 24V	- E	- 3	- M8D	- EX2

Ordering table				
Size	8	Condition s	Code	Enter code
M Module No.	543893			
Function	Proximity sensor for T-slot, non-contacting		SMT-8M	SMT-8M
Switching output	3-wire PNP N/O contact		PS	-
	3-wire NPN N/O contact		NS	-
	3-wire PNP N/C contact		PO	-
	2-wire N/O contact		ZS	-
Rated operating voltage [V DC]	24		24V	24V
			-	-
Cable characteristics	Standard + energy chain		K	-
	Energy chain + robot		E	-
Cable length [m]	0.2 ... 30 (0.2 ... 5.0 m in 0.1 m increments, 5.0 ... 30 m in 0.5 m increments)		...	-
			-	-
Connection technology	Open end		OE	-
	M8, rotatable thread		M8D	-
	M8, snap-on flange		M8	-
	M12, rotatable thread		M12	-
O EU certification	II 3GD in accordance with EU Directive 94/9/EC	1	-EX2	

1 EX2 Only with switching output ZS

Transfer order code

543893 **SMT-8M** - - **24V** - - - -

Proximity sensors SME-8M, for T-slot

Technical data – Magnetic reed

Function

e.g. N/O contact, 3-wire, with cable

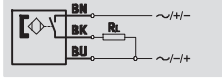

e.g. N/O contact, 3-wire, with plug

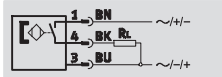

- Magnetic reed measuring principle
- Insertable in slot from above, does not protrude over the cylinder profile
- Cable clip and inscription labels included in the scope of delivery



General technical data	
Design	For T-slot
Based on standard	EN 60947-5-2
Certification	cULus listed (OL) C-Tick
CE mark (see declaration of conformity)	To EU EMC Directive
Note on materials	Free of copper and PTFE RoHS-compliant

Input signal/measuring element	
Measuring principle	Magnetic reed
Ambient temperature	[°C] -40 ... +70

Switching output			
Type	SME-8M-DS	SME-8M-ZS	SME-8M-DO
Switching output	Contacting, bipolar		
Switching element function	N/O contact	N/O contact	N/C contact
Max. output current [mA]	500	80	
Max. output current in mounting kits [mA]	80	80	
Max. switching capacity DC [W]	10	2.4	
Max. switching capacity DC in mounting kits [W]	2.4	2.4	
Max. switching capacity AC [VA]	10	2.4	
Max. switching capacity AC in mounting kits [VA]	2.4	2.4	
Voltage drop ¹⁾ [V]	≤1.5	≤4.8	≤3.5

1) Applies to cable length 2.5 m. Max. 0.15 V voltage drop per metre of additional cable length

Output, additional data	
Protection against short circuit	No
Protection against overloading	No

Electronic components	
Operating voltage range DC [V]	5 ... 30
Operating voltage range AC [V]	5 ... 30
Reverse polarity protection	No

Proximity sensors SME-8M, for T-slot

Technical data – Magnetic reed



Electromechanical components									
Switching element function	DS/DO				ZS				
Electrical connection	OE	M8D	M8	M12	OE	M8D	M8	M12	
Electrical connection	Cable, 3-wire	Cable with plug, 3-pin			Cable, 2-wire	Cable with plug, 2-pin			
		M8x1	M8x1	M12x1		M8x1	M8x1	M12x1	
		Rotatable thread	Snap-on flange	Rotatable thread		Rotatable thread	Snap-on flange	Rotatable thread	
Connection direction	In-line								
Cable test conditions	K	Energy chain: 5 million cycles, bending radius 75 mm							
		Resistance to bending: to Festo standard; test conditions on request							
	E	Energy chain: 5 million cycles, bending radius 28 mm							
		Torsional strength: $\pm 270^\circ/0.1\text{ m}$							
		Resistance to bending: to Festo standard; test conditions on request							
Cable length	[m]	0.2 ... 10							
Cable properties	K	Standard + energy chain							
	E	Energy chain + robot applications							
Cable sheath material	K	TPE-U(PU), oil resistant							
	E	TPE-U(PU), oil resistant, halogen free							

Mechanical components		
Electrical connection	OE	M...
Type of mounting	Screw-clamped in slot, insertable from above	
Housing	PA	PA
	High-alloy stainless steel	High-alloy stainless steel
	–	Nickel-plated brass
	–	TPE-U(PU)

Display/operation	
Switching status display	Yellow LED

Immissions/emissions	
Ambient temperature with flexible cable installation [°C]	–5 ... +70
Protection class	IP65, IP68

Pin allocation to EN 60947-5-2			
M8x1, 2-pin		M12x1, 2-pin	
N/O contact		N/O contact	
	Pin	Wire colour	Allocation
	1	Brown	+
	4	Black	Output
	1	Brown	+
	4	Black	Output

Pin allocation to EN 60947-5-2			
M8x1, 3-pin		M12x1, 3-pin	
N/O contact and N/C contact		N/O contact	
	Pin	Wire colour	Allocation
	1	Brown	+
	3	Blue	–
	4	Black	Output
	1	Brown	+
	3	Blue	–
	4	Black	Output

Proximity sensors SME-8M, for T-slot

Technical data – Magnetic reed

Pin allocation to EN 60947-5-2			
M12x1, 3-pin			
N/C contact			
	Pin	Wire colour	Allocation
	1	Brown	+
	3	Blue	-
	2	White	Output

Dimensions Download CAD Data → www.festo.com/us/cad

SME-8M-...-OE – Cable

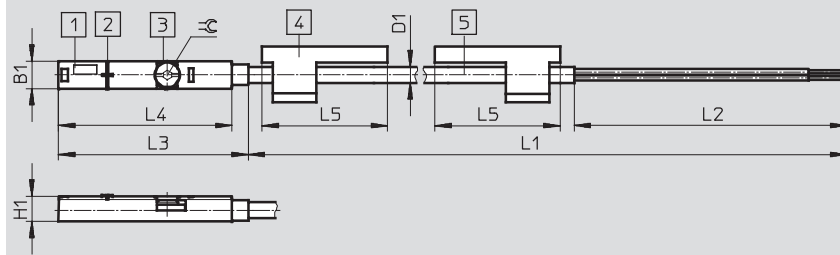

- 1 Yellow LED
- 2 Centre of the sensor element
- 3 Clamping component, tightening torque 0.6 Nm
- 4 Inscription label holder
- 5 Connecting cable

L1 Cable length

SME-8M-...-M8D – Cable with plug M8x1, rotatable thread

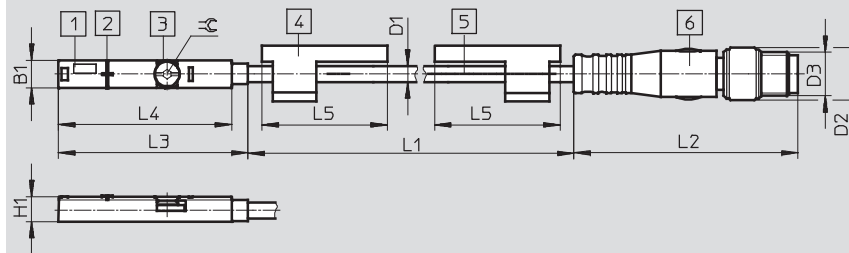

- 1 Yellow LED
- 2 Centre of the sensor element
- 3 Clamping component, tightening torque 0.6 Nm
- 4 Inscription label holder
- 5 Connecting cable
- 6 Plug to fit connecting cable NEBU-M8

L1 Cable length

SME-8M-...-M8 – Cable with plug M8x1, snap-on flange

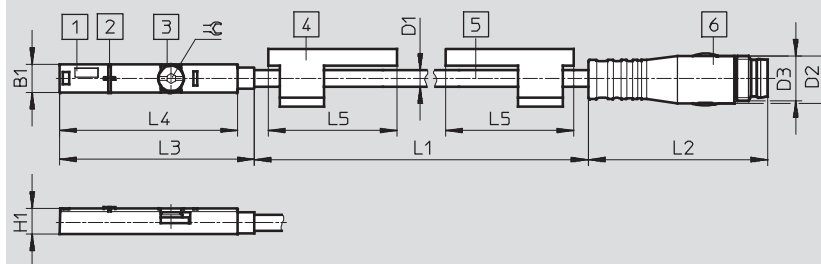

- 1 Yellow LED
- 2 Centre of the sensor element
- 3 Clamping component, tightening torque 0.6 Nm
- 4 Inscription label holder
- 5 Connecting cable
- 6 Plug to fit connecting cable NEBU-M8

L1 Cable length

Type	B1	D1	D2	D3	H1	L2	L3	L4	L5	⌀
SME-8M-...-OE	5	2.9	-	-	4.6	50	34.8	31.8	23	1.5
SME-8M-...-M8D			9.6	M8x1		41				
SME-8M-...-M8			8.8	M8x1		35				

Proximity sensors SME-8M, for T-slot

Technical data – Magnetic reed



Dimensions

Download CAD Data → www.festo.com/us/cad

SME-8M-...-M12 – Cable with plug M12x1, rotatable thread

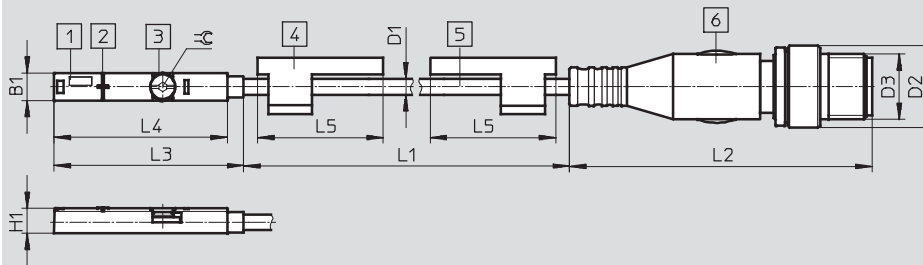

- 1 Yellow LED
- 2 Centre of the sensor element
- 3 Clamping component, tightening torque 0.6 Nm
- 4 Inscription label holder
- 5 Connecting cable
- 6 Plug to fit connecting cable NEBU-M12

L1 Cable length

Type	B1	D1	D2	D3	H1	L2	L3	L4	L5	⌀
SME-8M-...-M12	5	2.9	15	M12x1	4.6	55.5	34.8	31.8	23	1.5

Ordering data

	Switching output	Electrical connection		Cable length [m]	Part No.	Type
		Cable	Cable with plug, rotatable thread, M8x1			
	N/O contact					
	Contacting, bipolar	3-wire	-	2.5	543862	SME-8M-DS-24V-K-2,5-OE
				5.0	543863	SME-8M-DS-24V-K-5,0-OE
				7.5	543876	SME-8M-DS-24V-K-7,5-OE
		-	3-pin	0.3	543861	SME-8M-DS-24V-K-0,3-M8D
2-wire	-	2.5	543872	SME-8M-ZS-24V-K-2,5-OE		
N/C contact						
Contacting, bipolar	3-wire	-	7.5	546799	SME-8M-DO-24V-K-7,5-OE	

Proximity sensors SME-8M, for T-slot

Modular products – Magnetic reed

M Mandatory data						
Module No.	Function	Switching output	Rated operating voltage	Cable properties	Cable length	Connection technology
543892	SME-8M	DS ZS DO	24V	K E	0.2 ... 10	OE M8D M8 M12
Ordering example						
543892	SME-8M	ZS	24V	K	0.8	OE

Ordering table							
Size	8	Conditions		Code		Enter code	
M Module No.	543892						
Function	Proximity sensor for T-slot, contacting			SME-8M		SME-8M	
				-		-	
Switching output	3-wire N/O contact			DS			
	2-wire N/O contact			ZS			
	3-wire N/C contact			DO			
				-		-	
Rated operating voltage [V DC]	24			24V		24V	
				-		-	
Cable properties	Standard + energy chain			K			
	Energy chain + robot applications			E			
				-		-	
Cable length [m]	0.2 ... 10			...			
	(0.2 ... 5.0 m in 0.1 m steps, 5.0 ... 10 m in 0.5 m steps)						
				-		-	
Connection technology	Open end			OE			
	M8, rotatable thread			M8D			
	M8, snap-on flange			M8			
	M12, rotatable thread			M12			

Transfer order code

543892	SME-8M	-		-	24V	-		-		-	
--------	--------	---	--	---	-----	---	--	---	--	---	--

Proximity sensors SMT/CRSMT/SME-8, for T-slot

Type codes

SMT/SME-8		SMT	8	PS	K	LED	24		B
Function									
SMT	Proximity sensor, magneto-resistive								
SME	Proximity sensor, magnetic reed								
Design									
8	For T-slot, insertable in slot lengthwise								
Switching output, switching element function									
PS	PNP, N/O contact, 3-wire								
NS	NPN, N/O contact, 3-wire								
ZS	N/O contact, 2-wire								
O	N/C contact, 3-wire								
Electrical connection, cable length									
K	Cable, 2.5 m or 7.5 m								
K2,5	Cable, 2.5 m								
K5	Cable, 5.0 m								
K-7,5	Cable, 7.5 m								
KL	Cable, 2.5 m								
S	Plug M8x1 with cable, 0.3 m								
Switching status display									
LED	Yellow LED								
Rated operating voltage									
24	24 V DC								
230	230 V AC								
Variant									
S6	Heat resistant								
Generation									
B	B series								

SMT/SME-8-SL		SMT	8	SL	PS	LED	24
Function							
SMT	Proximity sensor, magneto-resistive						
SME	Proximity sensor, magnetic reed						
Design							
8	For T-slot, insertable in slot lengthwise						
Electrical connection							
SL	Plug						
Switching output, switching element function							
PS	PNP, N/O contact, 3-wire						
Switching status display							
LED	Yellow LED						
Rated operating voltage							
24	24 V DC						

Proximity sensors SMT/CRSMT/SME-8, for T-slot

Type codes

CRSMT-8	
<div style="display: flex; justify-content: space-around; align-items: center;"> <div style="border: 1px solid black; padding: 2px;">CRSMT</div> – <div style="border: 1px solid black; padding: 2px;">8</div> – <div style="border: 1px solid black; padding: 2px;">PS</div> – <div style="border: 1px solid black; padding: 2px;">K2,5</div> – <div style="border: 1px solid black; padding: 2px;">LED</div> – <div style="border: 1px solid black; padding: 2px;">24</div> </div>	
Function	
CRSMT	Proximity sensor, magneto-resistive, suitable for the food industry, resistant to acids and cooling lubricants
Design	
8	For T-slot, insertable in slot lengthwise
Switching output, switching element function	
PS	PNP, N/O contact, 3-wire
Electrical connection, cable length	
K2,5	Cable, 2.5 m
K5	Cable, 5.0 m
Switching status display	
LED	Yellow LED
Rated operating voltage	
24	24 V DC

Proximity sensors SMT-8/CRSMT-8, for T-slot

Technical data – Magneto-resistive

FESTO

Function

e.g. PNP, N/O contact, with plug

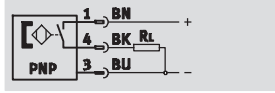

e.g. NPN, N/O contact, with plug

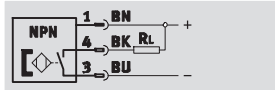

- Magneto-resistive measuring principle
- Insertable in slot lengthwise
- Corrosion-resistant designs

SMT-8-SL

- Sturdy thanks to long guides
- Plug directly on sensor



SMT-8



SMT-8-SL

General technical data				
Type	SMT-8		CRSMT	SMT-8-SL
Switching output	PNP	NPN	PNP	PNP
Design	For T-slot		For T-slot	For T-slot
Conforms to	–		EN 60947-5-2	–
Based on standard	EN 60947-5-2	–	–	EN 60947-5-2
Certification	C-Tick		C-Tick	C-Tick
	–		–	c UL us - Listed (OL)
CE mark (see declaration of conformity)	To EU EMC Directive		To EU EMC Directive	To EU EMC Directive
Note on materials	Free of copper and PTFE		Free of copper and PTFE	Free of copper and PTFE
	–		–	RoHS-compliant

Input signal/measuring element				
	SMT-8		CRSMT	SMT-8-SL
Measuring principle	Magneto-resistive		Magneto-resistive	Magneto-resistive
Ambient temperature	[°C]	–20 ... +60	–20 ... +60	–20 ... +70

Switching output				
Type	SMT-8		CRSMT	SMT-8-SL
Switching output	PNP	NPN	PNP	PNP
Switching output	PNP	NPN	PNP	PNP
Switching element function	N/O contact		N/O contact	N/O contact
Reproducibility of switching value	[mm]	±0.1	±0.1	–
Switch-on time	[ms]	≤ 0.2	≤ 0.2	≤ 1
Switch-off time	[ms]	≤ 0.5	≤ 0.5	3 ... 5
Max. switching frequency	[Hz]	–	1 000	140
Max. output current	[mA]	100	100	100
Max. switching capacity DC	[W]	3	3	3
Voltage drop	[V]	≤ 1.8	≤ 1.8	≤ 2
Residual current	[µmA]	≤ 100	≤ 100	≤ 1.5

Output, additional data				
Type	SMT-8		CRSMT	SMT-8-SL
Switching output	PNP	NPN	PNP	PNP
Protection against short circuit	Pulsed		Yes	Yes
Protection against overloading	Yes		–	Yes

Electronic components				
Type	SMT-8		CRSMT	SMT-8-SL
Switching output	PNP		PNP	PNP
Rated operating voltage	[V DC]	–	–	24
Operating voltage range	[V DC]	10 ... 30	10 ... 30	10 ... 30
Reverse polarity protection	For all electrical connections			

Proximity sensors SMT-8/CRSMT-8, for T-slot

Technical data – Magneto-resistive

Electromechanical components						
Type	SMT-8				CRSMT	SMT-8-SL
Switching output	PNP		NPN		PNP	PNP
Electrical connection	Cable, 3-wire	Cable with plug, 3-pin	Cable, 3-wire	Cable with plug, 3-pin	Cable, 3-wire	Plug M8x1, 3-pin
Connection direction	In-line				–	In-line
Cable length [m]	2.5	0.3	2.5	0.3	2.5	–
	5	–	–	–	5	
Cable properties	Standard		–		–	–
Cable sheath material	Polyurethane				Thermoplastic polyolefin elastomer	–

Mechanical components						
Type	SMT-8				CRSMT	SMT-8-SL
Switching output	PNP		NPN		PNP	PNP
Electrical connection	Cable, 3-wire	Cable with plug M8x1, 3-pin	Cable, 3-wire	Cable with plug M8x1, 3-pin	Cable, 3-wire	Plug M8x1, 3-pin
Type of mounting	Clamped in T-slot				Clamped in T-slot	Screw-clamped
	Insertable in slot lengthwise				–	Insertable in slot lengthwise
Housing material	High-alloy stainless steel				High-alloy stainless steel	Polyamide
	Thermoplastic polyurethane elastomer				Polypropylene	–
	–	Brass	–	Brass	–	–
	–	Nickel-plated	–	Nickel-plated	–	–

Display/operation	
Switching status display	Yellow LED

Immissions/emissions			
Type	SMT-8	CRSMT	SMT-8-SL
Ambient temperature with flexible cable installation [°C]	–5 ... +60	–5 ... +60	–
Protection class	IP65	IP65	IP65
	IP67	IP68	IP68
	–	IP69K	–
Insulation voltage [V]	–	500	–
Degree of contamination	–	3	–
Corrosion resistance class CRC	2	4	3

Pin allocation to EN 60947-5-2			
PS/NS			
Plug, 3-pin			
M8x1	Pin	Wire colour	Allocation
	1	Brown	+
	3	Blue	–
	4	Black	Output

Proximity sensors SMT-8/CRSMT-8, for T-slot

Technical data – Magneto-resistive



Dimensions

Download CAD Data → www.festo.com/us/cad

SMT-8-...S-K

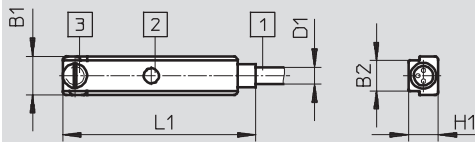

- 1 Connecting cable
- 2 Yellow LED
- 3 Clamping component

SMT-8-...S-S

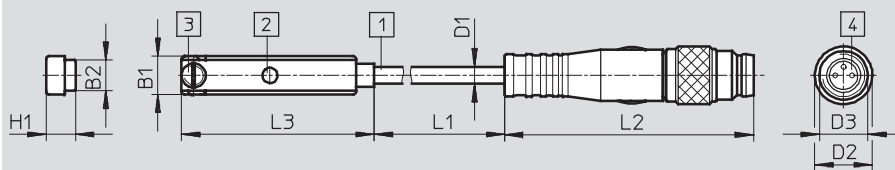

- 1 Connecting cable
- 2 Yellow LED
- 3 Clamping component
- 4 Plug to fit connecting cable NEBU-M8

CRSMT

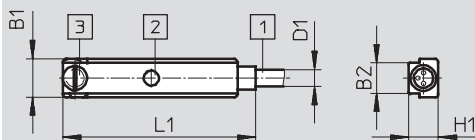

- 1 Connecting cable
- 2 Yellow LED
- 3 Clamping component

SMT-8-SL

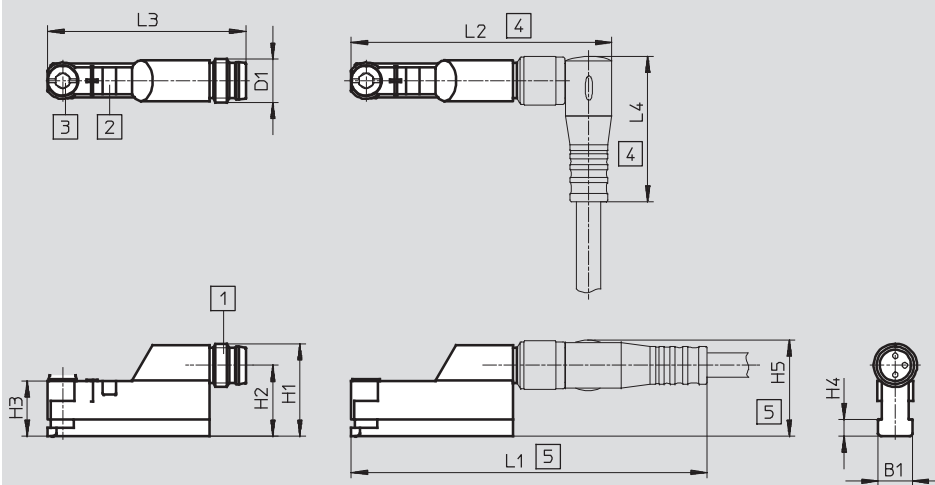



- 1 Plug to fit connecting cable NEBU-M8
- 2 Yellow LED
- 3 Clamping component
- 4 Fitting space for connecting cable NEBU-M8W3
- 5 Fitting space for connecting cable NEBU-M8G3

Type	B1	B2	D1	D2	D3	H1	H2	H3	H4	H5	L1	L2	L3	L4
SMT-8-...S-K	6.3	5	2.9	-	-	4.9	-	-	-	-	32.4	-	-	-
SMT-8-...S-S	6.3 -0.1	5 ±0.05	2.9	9.5	M8x1	4.9 ±0.1	-	-	-	-	310 +30/-10	41.1 ±0.1	32.4 +0.4/-0.2	-
CRSMT	6.3	5	2.9	-	-	4.9	-	-	-	-	32.4	-	-	-
SMT-8-SL	6.7	-	M8x1	-	-	17.1	13.1	10.2	3.1	17.6	66	48.4	36.6	26.9

Proximity sensors SMT-8/CRSMT-8, for T-slot

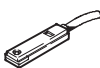
Technical data – Magneto-resistive

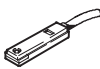
Ordering data							
	Switching output	Electrical connection			Cable length [m]	Part No.	Type
		Cable	Cable with plug M8x1	Plug M8x1			
N/O contact, basic version							
	PNP	3-wire	–	–	2.5	175436	SMT-8-PS-K-LED-24-B
			–	3-pin	–	0.3	175434
	NPN	3-wire	–	–	2.5	171180	SMT-8-PS-S-LED-24-B
			–	3-pin	–	0.3	171181
	PNP	–	–	3-pin	–	562019	SMT-8-SL-PS-LED-24-B
N/O contact, corrosion resistant							
	PNP	3-wire	–	–	2.5	525563	CRSMT-8-PS-K-LED-24
					5.0	525564	CRSMT-8-PS-K5-LED-24

Proximity sensors SME-8, for T-slot

Technical data – Magnetic reed



Function

e.g. N/O contact, with cable, 3-wire

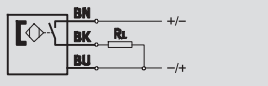

e.g. N/O contact, with plug, 3-pin

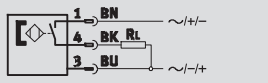

- Magnetic reed measuring principle
- Insertable in slot lengthwise

SME-8-SL

- Sturdy thanks to long guides
- Plug directly on sensor



General technical data					
Type	SME-8-K	SME-8-S	SME-8-ZS	SME-8-O	SME-8-SL
Design	For T-slot				
Conforms to	EN 60947-5-2				
Certification	C-Tick				
CE mark (see declaration of conformity)	To EU EMC Directive ¹⁾				
Note on materials	Free of copper and PTFE				
	RoHS-compliant	–		RoHS-compliant	

1) For information about the applicability of the component see the manufacturer's EC declaration of conformity at: www.festo.com → Support → User documentation.
If the component is subject to restrictions on usage in residential, office or commercial environments or small businesses, further measures to reduce the emitted interference may be necessary.

Input signal/measuring element							
Type	SME-8-K	SME-8-K5	SME-8-K-7,5	SME-8-S	SME-8-ZS	SME-8-O	SME-8-SL
Measuring principle	Magnetic reed						
Ambient temperature [°C]	–40 ... +60	–40 ... +70	–40 ... +70	–40 ... +70	–40 ... +60	–40 ... +60	–40 ... +60

Switching output					
Type	SME-8-K	SME-8-S	SME-8-ZS	SME-8-O	SME-8-SL
Switching output	Contacting, bipolar				
Switching element function	N/O contact	N/O contact	N/O contact	N/C contact	N/O contact
Reproducibility of switching value [mm]	±0.1	±0.1	±0.1	±0.1	±0.1
Switch-on time [ms]	≤ 0.5	≤ 0.5	≤ 0.5	≤ 2	≤ 0.6
Switch-off time [ms]	≤ 0.03	≤ 0.03	≤ 0.03	≤ 0.2	≤ 0.05
Max. switching frequency [Hz]	800	–	800	–	500
Max. output current [mA]	500	500	80	50	500
Max. switching capacity AC [VA]	10	10	–	1.5	10
Max. switching capacity DC [W]	10	10	2.16	1.5	10
Voltage drop [V]	0	–	≤ 3.5	≤ 2.5	0

Output, additional data	
Protection against short circuit	No
Protection against overloading	No

Electronic components					
Type	SME-8-K	SME-8-S	SME-8-ZS	SME-8-O	SME-8-SL
Operating voltage range [V AC]	12 ... 30	12 ... 30	–	12 ... 30	10 ... 30
Operating voltage range [V DC]	12 ... 30	12 ... 30	12 ... 27	12 ... 30	10 ... 30
Reverse polarity protection	No				

Proximity sensors SME-8, for T-slot

Technical data – Magnetic reed

Electromechanical components							
Type	SME-8-K	SME-8-K5	SME-8-K-7,5	SME-8-S	SME-8-ZS	SME-8-O	SME-8-SL
Electrical connection	Cable, 3-wire			Cable with plug M8x1, 3-pin	Cable, 2-wire	Cable, 3-wire	Plug M8x1, 3-pin
Connection direction	In-line						
Cable length [m]	2.5	5	7.5	0.3	2.5	7.5	–
Cable sheath material	Polyurethane						

Mechanical components							
Type	SME-8-K	SME-8-K5	SME-8-K-7,5	SME-8-S	SME-8-ZS	SME-8-O	SME-8-SL
Type of mounting	Clamped in T-slot Insertable in slot lengthwise						
Housing material	Epoxy resin Polycarbonate Polybutylene terephthalate High-alloy stainless steel						

Display/operation	
Switching status display	Yellow LED

Immissions/emissions							
Type	SME-8-K	SME-8-K5	SME-8-K-7,5	SME-8-S	SME-8-ZS	SME-8-O	SME-8-SL
Ambient temperature with flexible cable installation [°C]	–5 ... +60	–5 ... +70	–5 ... +70	–5 ... +70	–5 ... +60	–5 ... +60	–
Protection class	IP65 IP67			– IP67	IP65 IP67	– IP67	IP65 IP67
Insulation voltage [V]	50						
Surge capacity [kV]	3	3	3	3	3	3	3
Degree of contamination	3						

Pin allocation to EN 60947-5-2			
S			
Plug, 3-pin			
M8x1	Pin	Wire colour	Allocation
	1	Brown	+
	3	Blue	–
	4	Black	Output

Proximity sensors SME-8, for T-slot

Technical data – Magnetic reed



Dimensions

Download CAD Data → www.festo.com/us/cad

N/O contact, cable

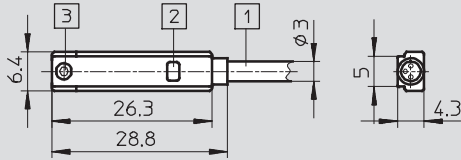

- 1 Connecting cable
- 2 Yellow LED
- 3 Clamping component

N/C contact, cable

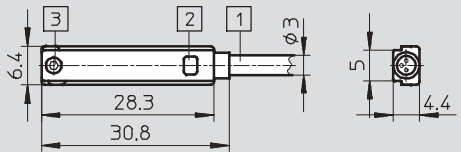

- 1 Connecting cable
- 2 Yellow LED
- 3 Clamping component

Plug M8x1

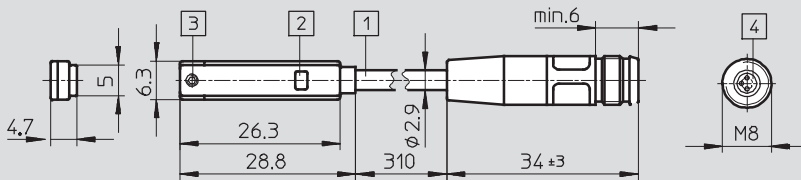

- 1 Connecting cable
- 2 Plug to fit connecting cable NEBU-M8
- 3 Clamping component
- 4 Yellow LED

Ordering data

	Switching output	Electrical connection			Cable length [m]	Part No.	Type
		Cable	Cable with plug M8x1	Plug M8x1			
N/O contact, basic version							
	Contacting, bipolar	3-wire	-	-	2.5	150855	SME-8-K-LED-24
			-	-	5.0	175404	SME-8-K5-LED-24
			-	-	7.5	530491	SME-8-K-7,5-LED-24
		-	3-pin	-	0.3	150857	SME-8-S-LED-24
	Contacting, bipolar	2-wire	-	-	2.5	171169	SME-8-ZS-KL-LED-24
		-	-	3-pin	-	526622	SME-8-SL-LED-24
N/C contact							
	Contacting, bipolar	3-wire	-	-	7.5	160251	SME-8-O-K-LED-24

Proximity sensors SME-8, for T-slot

Technical data – Magnetic reed

Function

e.g. N/O contact, with cable, 2-wire,
0 ... 30 V AC/DC

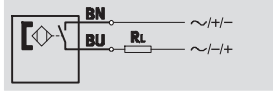

e.g. N/O contact, with cable, 2-wire,
3 ... 230 V AC/DC

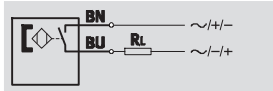

- Magnetic reed measuring principle
- Insertable in slot lengthwise
- Heat-resistant design
- Variants with operating voltage range up to 230 V DC/AC

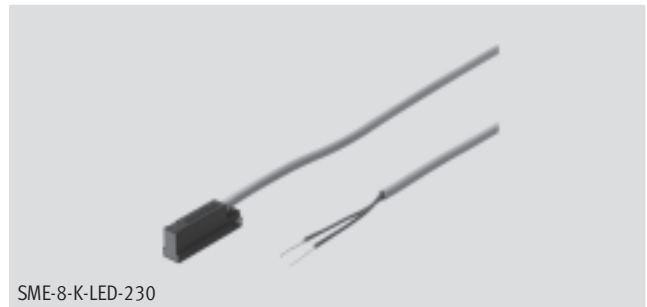

General technical data		
	SME-8-...-S6	SME-8-...-230
Design	For T-slot	
Conforms to	EN 60947-5-2	
CE mark (see declaration of conformity)	–	To EU EMC Directive ¹⁾
	–	To EU Low Voltage Directive
Note on materials	Free of copper and PTFE	
	RoHS-compliant	

1) For information about the applicability of the component see the manufacturer's EC declaration of conformity at: www.festo.com → Support → User documentation.
If the component is subject to restrictions on usage in residential, office or commercial environments or small businesses, further measures to reduce the emitted interference may be necessary.

Input signal/measuring element		
	SME-8-...-S6	SME-8-...-230
Measuring principle	Magnetic reed	
Ambient temperature [°C]	–40 ... +120	–30 ... +60

Switching output		
	SME-8-...-S6	SME-8-...-230
Switching output	Contacting, bipolar	Contacting, bipolar, without LED function
Switching element function	N/O contact	
Reproducibility of switching value [mm]	±0.1	±0.1
Switch-on time [ms]	≤ 0.5	2
Switch-off time [ms]	≤ 0.03	0.03
Max. switching frequency [Hz]	800	500
Max. output current [mA]	500	120
Max. switching capacity AC [VA]	10	
Max. switching capacity DC [W]	10	
Voltage drop [V]	≤ 0	≤ 3.9
Residual current [mA]	–	0

Output, additional data		
	SME-8-...-S6	SME-8-...-230
Protection against short circuit	No	
Protection against overloading	No	

Electronic components		
	SME-8-...-S6	SME-8-...-230
Operating voltage range [V AC]	0 ... 30	3 ... 230
Operating voltage range [V DC]	0 ... 30	3 ... 230
Reverse polarity protection	No	

Proximity sensors SME-8, for T-slot

FESTO

Technical data – Magnetic reed

Electromechanical components		
	SME-8-...-S6	SME-8-...-230
Electrical connection	Cable, 2-wire	
Connection direction	In-line	
Cable length [m]	2.5	2.5
	–	–
Cable sheath material	Thermoplastic styrene elastomer	Polyurethane



Mechanical components		
	SME-8-...-S6	SME-8-...-230
Type of mounting	Clamped in T-slot Insertable in slot lengthwise	
Housing material	Epoxy resin Polycarbonate Polyethylene terephthalate High-alloy stainless steel	Epoxy resin Polystyrene Polyethylene terephthalate High-alloy stainless steel

Display/operation		
	SME-8-...-S6	SME-8-...-230
Switching status display	–	Yellow LED

Immissions/emissions		
	SME-8-...-S6	SME-8-...-230
Ambient temperature with flexible cable installation [°C]	–5 ... +120	–5 ... +60
Protection class	– IP67	– IP67
Insulation voltage [V]	50	–
Surge capacity [kV]	0.8	4
Degree of contamination	3	3

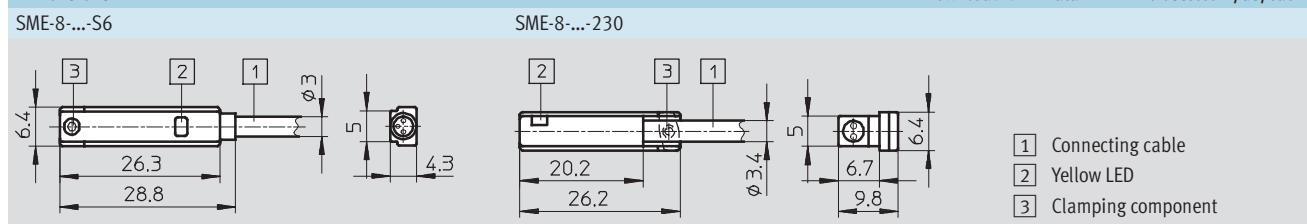
Dimensions Download CAD Data → www.festo.com/us/cad

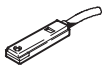

Ordering data						
	Switching output	Electrical connection	Connection direction	Cable length [m]	Part No.	Type
		Cable				
N/O contact, heat resistant						
	Contacting, bipolar	2-wire	In-line	2.5	161756	SME-8-K-24-S6
N/O contact, operating voltage range up to 230 V AC/DC						
	Contacting, bipolar	2-wire	In-line	2.5	152820	SME-8-K-LED-230

Proximity sensors SMT-8G, for T-slot

Type codes

FESTO

SMT-8G

SMT - 8G - PS - 24V - E - 2,5Q - OE

Function

SMT	Proximity sensor, magneto-resistive
-----	-------------------------------------

Design

8G	For T-slot, insertable in slot lengthwise
----	---

Switching output, switching element function

PS	PNP, N/O contact, 3-wire
----	--------------------------

Rated operating voltage

24V	24 V DC
-----	---------

Cable properties

E	Energy chain + robot applications
---	-----------------------------------

Cable length [m], connection direction

2,5Q	Cable, 2.5 m, lateral ¹⁾
0,3Q	Cable with plug, 0.3 m, lateral ²⁾

Electrical connection

OE	Open end
M8D	Cable with plug M8x1, rotatable thread

1) Only with electrical connection OE
 2) Not with electrical connection OE

Proximity sensors SMT-8G, for T-slot

Technical data – Magneto-resistive

Function

PNP, N/O contact, with cable, 3-wire

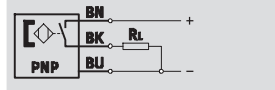

PNP, N/O contact, with plug

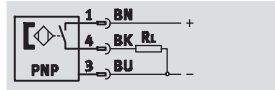

- Magneto-resistive measuring principle
- Insertable in slot lengthwise
- Design ideally matched to gripper sensing



General technical data	
Design	For T-slot
Based on standard	EN 60947-5-2
Certification	c UL us - Listed (OL)
CE mark (see declaration of conformity)	To EU EMC Directive
Note on materials	Free of copper and PTFE RoHS-compliant

Input signal/measuring element	
Measuring principle	Magneto-resistive
Ambient temperature [°C]	-20 ... +70

Switching output	
Switching output	PNP
Switching element function	N/O contact
Max. output current [mA]	80
Max. switching capacity DC [W]	2.4

Output, additional data	
Protection against short circuit	Pulsed
Protection against overloading	Yes

Electronic components	
Operating voltage range [V DC]	10 ... 30
Reverse polarity protection	For all electrical connections

Electromechanical components		
Type	SMT-8G-...-OE	SMT-8G-...-M8D
Electrical connection	Cable, 3-wire	Cable with plug M8x1, 3-pin, rotatable thread
Connection direction	Lateral	
Cable test conditions	Energy chain: 5 million cycles, bending radius 28 mm	
	Torsional strength: > 300,000 cycles, ±270°/0.1 m	
	Resistance to bending: to Festo standard; test conditions on request	
Cable length [m]	2.5	0.3
Cable properties	Energy chain + robot applications	
Cable sheath material	Thermoplastic polyurethane elastomer	

Mechanical components	
Type of mounting	Clamped in T-slot Insertable in slot lengthwise
Housing material	Reinforced polyamide

Proximity sensors SMT-8G, for T-slot

Technical data – Magneto-resistive

Display/operation	
Switching status display	Yellow LED

Immissions/emissions	
Ambient temperature with flexible cable installation	[°C] –5 ... +70
Protection class	IP65
	IP68

Pin allocation to EN 60947-5-2			
PS			
Plug, 3-pin			
M8x1	Pin	Wire colour	Allocation
	1	Brown	+
	3	Blue	-
	4	Black	Output

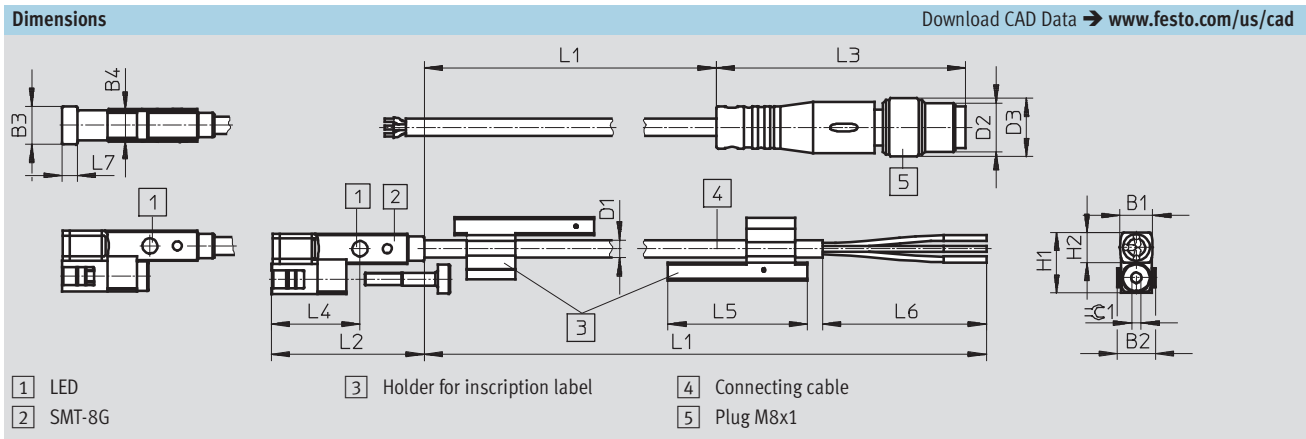

	D1	D2	D3	B1	B2	B3	B4	H1	H2	L1	L2	L3	L4	L5	L6	L7	
SMT-8G-...-OE	2.9	-	-	5.4	5	6.3	5	10	5	2500 +70	25	-	14.4	23	50	2.5	1.5
SMT-8G-...-M8D		M8x1	9.6							41.1							

Ordering data						
	Switching output	Electrical connection		Cable length [m]	Part No.	Type
		Cable	Cable with plug, rotatable thread, M8x1			
N/O contact						
	PNP	3-wire	-	2.5	547859	SMT-8G-PS-24V-E-2,5Q-OE
		-	3-pin	-	0.3	547860

Proximity sensors SME-8-FM, for T-slot

Type codes

SME-8-FM

SME – 8 – FM – DS – 24V – K – 1,0 – OE

Function	
SME	Proximity sensor, magnetic reed

Design	
8	For T-slot

Sensor design	
FM	Screw-clamped in slot, insertable from above

Switching output	
DS	3-wire N/O contact
ZS	2-wire N/O contact

Nominal operating voltage	
24V	24 V AC/DC

Cable properties	
K	Standard

Cable length [m]	
1,0	1

Electrical connection	
OE	Open end

Proximity sensors SME-8-FM, for T-slot

Technical data – Magnetic reed

Function

N/O contact, with cable, 3-wire

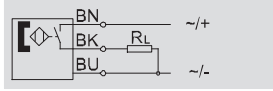

N/O contact, with cable, 2-wire

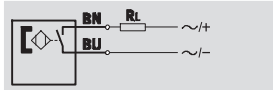

- Magnetic reed measuring principle
- Insertable in slot from above



SME-8-FM-DS

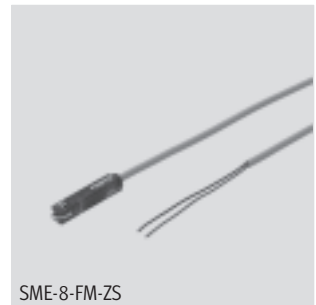

SME-8-FM-ZS

General technical data	
Design	For T-slot
Based on standard	EN-60947-5-2
Certification	C-Tick
CE mark (see declaration of conformity)	To EU EMC Directive
Note on materials	Free of copper and PTFE RoHS-compliant

Input signal/measuring element	
Measuring principle	Magnetic reed
Ambient temperature [°C]	-10 ... +60

Switching output		
Type	SME-8-FM-DS	SME-8-FM-ZS
Switching output	Contacting, bipolar	
Switching element function	N/O contact	
Max. output current [mA]	100	
Max. switching capacity AC [VA]	3	
Max. switching capacity DC [W]	3	

Output, additional data	
Protection against short circuit	No
Protection against overloading	No

Electronic components		
Operating voltage range [V AC]	10 ... 30	
Operating voltage range [V DC]	10 ... 30	

Electromechanical components		
Type	SME-8-FM-DS	SME-8-FM-ZS
Electrical connection	Cable, 3-wire	Cable, 2-wire
Connection direction	In-line	
Cable test conditions	Test conditions on request	
Cable length [m]	1	
Cable properties	Standard	
Cable sheath material	Polyvinyl chloride	

Mechanical components		
Type	SME-8-FM-DS	SME-8-FM-ZS
Type of mounting	Screw-clamped Insertable in slot from above	
Housing material	Polyamide	

Proximity sensors SME-8-FM, for T-slot

Technical data – Magnetic reed

Display/operation	
Switching status display	Yellow LED

Immissions/emissions	
Ambient temperature with flexible cable installation [°C]	-5 ... +60
Protection class	IP67

Dimensions Download CAD Data → www.festo.com/us/cad

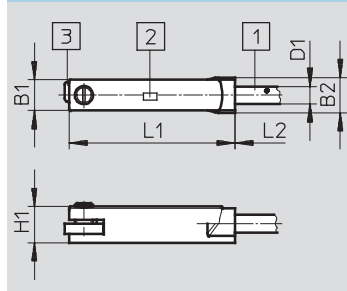

1 Connecting cable
 2 Yellow LED
 3 Clamping component

	B1	B2	D1	H1	L1	L2
SME-8-FM	5.1	5.8	2.9	6	27.4	1 000

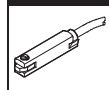
Ordering data						
	Switching output	Electrical connection	Cable length [m]	Part No.	Type	
		Cable				
	Contacting, bipolar	3-wire	1	562515	SME-8-FM-DS-24V-K-1,0-OE	
		2-wire	1	562516	SME-8-FM-ZS-24V-K-1,0-OE	

Proximity sensors SMTO/SMTSO/SMEO-8E, for T-slot

Type codes

SMTO/SMTSO/SMEO-8E	
SMTO – 8E – PS – M12 – LED – 24 –	
Function	
SMTO	Proximity sensor, magneto-resistive
SMTSO	Proximity sensor, magneto-inductive, welding field immune
SMEO	Proximity sensor, magnetic reed
Design	
8E	For T-slot, mounting via accessories
Switching output, switching element function	
PS	PNP, N/O contact, 3-wire
NS	NPN, N/O contact, 3-wire
Electrical connection, cable length	
K	Cable, 2.5 m or 7.5 m
S	Plug M8x1
M12	Plug M12x1
Switching status display	
LED	Yellow LED
Rated operating voltage	
24	24 V DC
230	230 V AC
Variant	
S6	Heat resistant

Proximity sensors SMTO-8E/SMTSO-8E, for T-slot

Technical data – Magneto-resistive



Function

PNP, N/O contact, with plug

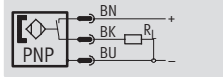

NPN, N/O contact, with plug

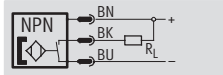

- Magneto-resistive measuring principle
- Welding field immune designs



General technical data		
Type	SMTO-8E	SMTSO-8E, welding field immune
Design	For T-slot	
Certification	C-Tick	
CE mark (see declaration of conformity)	To EU EMC Directive ¹⁾	
Note on materials	Free of copper and PTFE	
	RoHS-compliant	–

- 1) For information about the applicability of the component see the manufacturer's EC declaration of conformity at: www.festo.com → Support → User documentation.
If the component is subject to restrictions on usage in residential, office or commercial environments or small businesses, further measures to reduce the emitted interference may be necessary.

Input signal/measuring element		
Type	SMTO-8E	SMTSO-8E, welding field immune
Measuring principle	Magneto-resistive	Magneto-inductive
Ambient temperature [°C]	–20 ... +60	–25 ... +70

Switching output				
Type	SMTO-8E		SMTSO-8E, welding field immune	
Switching output	PNP	NPN	PNP	NPN
Switching element function	N/O contact			
Reproducibility of switching value [mm]	±0.1			
Switch-on time [ms]	0 ... 0.5		0 ... 38	
Switch-off time [ms]	10 ... 25		0 ... 20	
Max. output current [mA]	100		200	
Max. switching capacity DC [W]	3		6	
Voltage drop [V]	0 ... 1.8		0 ... 1.8	0 ... 3
Residual current [µmA]	0.01			

Output, additional data				
Type	SMTO-8E		SMTSO-8E, welding field immune	
Switching output	PNP	NPN	PNP	NPN
Protection against short circuit	Pulsed		Yes	Pulsed
Protection against overloading	Yes			

Electronic components		
Operating voltage range DC [V]	10 ... 30	
Reverse polarity protection	For all electrical connections	

Proximity sensors SMTO-8E/SMTSO-8E, for T-slot

Technical data – Magneto-resistive

Electromechanical components			
Type	SMTO-8E-...-S	SMTO-8E-...-M12	SMTSO-8E-...-M12, welding field immune
Electrical connection	Plug M8x1, 3-pin	Plug M12x1, 3-pin	Plug M12x1, 3-pin
Connection direction	Lateral		
Max. tightening torque for plug [Nm]	0.3	0.5	0.5

Mechanical components			
Type	SMTO-8E-...-S	SMTO-8E-...-M12	SMTSO-8E-...-M12, welding field immune
Type of mounting	Clamped in T-slot Insertable in slot from above Via accessories		
Tightening torque [Nm]	1	0.5	0.5
Housing materials	TPE-U(PU)	TPE-U(PU)	TPE-U(PU)
	Nickel-plated brass	High-alloy stainless steel	High-alloy stainless steel
	–	Wrought aluminium alloy	Wrought aluminium alloy
		–	PA

Display/operation	
Switching status display	Yellow LED

Immissions/emissions			
Type	SMTO-8E-...-S	SMTO-8E-...-M12	SMTSO-8E-...-M12, welding field immune
Protection class	IP65 IP67		
Resistance to interference from magnetic fields	–	–	Alternating magnetic field 45 ... 65 Hz

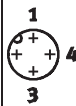
Pin allocation to EN 60947-5-2							
M8x1, 3-pin				M12x1, 3-pin			
N/O contact				N/O contact			
	Pin	Wire colour	Allocation		Pin	Wire colour	Allocation
	1	Brown	+		1	Brown	+
	3	Blue	–		3	Blue	–
	4	Black	Output		4	Black	Output

Proximity sensors SMT0-8E/SMTS0-8E, for T-slot

Technical data – Magneto-resistive



Dimensions

Download CAD Data → www.festo.com/us/cad

SMT0-8E-...-S-LED-24 – Plug M8x1

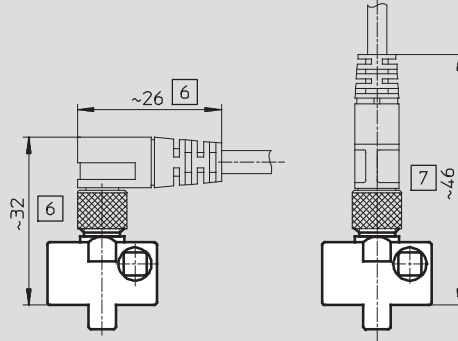
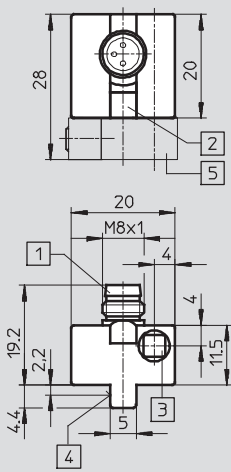

- 1 Plug to fit connecting cable NEBU-M8
- 2 Yellow LED
- 3 Mounting screw
- 4 Theoretical switching point
- 5 Mounting kit SMB-8E (not included in the scope of delivery)
- 6 Fitting space for connecting cable NEBU-M8W3
- 7 Fitting space for connecting cable NEBU-M8G3

SMT0-8E-...-M12-LED-24 – Plug M12x1

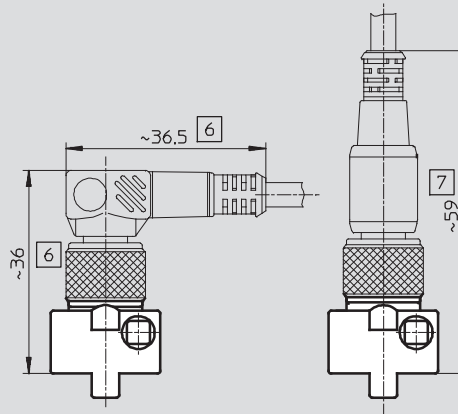
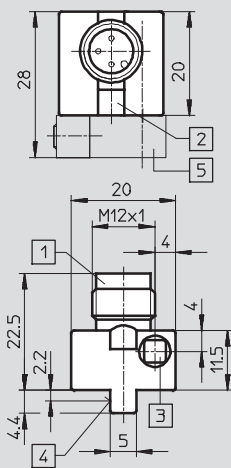

- 1 Plug to fit connecting cable NEBU-M12
- 2 Yellow LED
- 3 Mounting screw
- 4 Theoretical switching point
- 5 Mounting kit SMB-8E (not included in the scope of delivery)
- 6 Fitting space for connecting cable NEBU-M12W5
- 7 Fitting space for connecting cable NEBU-M12G5

Proximity sensors SMT0-8E/SMTSO-8E, for T-slot

Technical data – Magneto-resistive



Dimensions

Download CAD Data → www.festo.com/us/cad

SMTSO-8E-...-M12-LED-24 – Plug M12x1

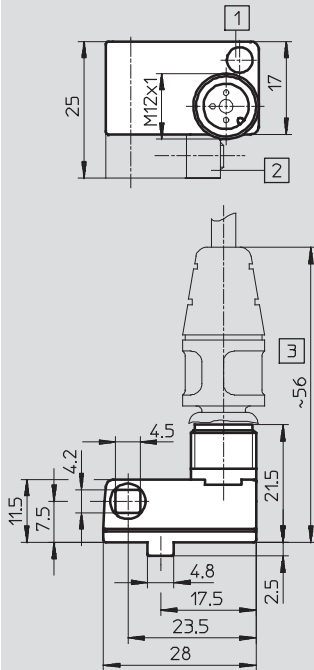

- 1 Yellow LED
- 2 Mounting kit SMB-8E (not included in the scope of delivery)
- 3 Fitting space for connecting cable NEBU-M12G5

Ordering data

	Switching output	Electrical connection		Part No.	Type
		Plug M8x1	Plug M12x1		
N/O contact, basic version					
	PNP	3-pin	–	171178	SMT0-8E-PS-S-LED-24
		–	3-pin	171179	SMT0-8E-PS-M12-LED-24
	NPN	3-pin	–	171166	SMT0-8E-NS-S-LED-24
		–	3-pin	171176	SMT0-8E-NS-M12-LED-24
N/O contact, welding field immune					
	PNP	–	3-pin	191986	SMTSO-8E-PS-M12-LED-24
	NPN	–	3-pin	175825	SMTSO-8E-NS-M12-LED-24

Proximity sensors SMEO-8E, for T-slot

Technical data – Magnetic reed



Function

E.g. N/O contact, 3-wire, with plug

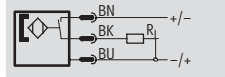

- Magnetic reed measuring principle
- Heat-resistant variant



E.g. N/O contact, 2-wire, with cable

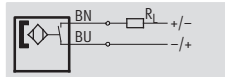

General technical data			
	SMEO-8E-...-24	SMEO-8E-...-24-S6, heat-resistant	SMEO-8E-...-230
Design	For T-slot	For T-slot	For T-slot
Conforms to	EN 60947-5-2	–	EN 60947-5-2
Certification	C-Tick	–	C-Tick
CE mark (see declaration of conformity)	To EU EMC Directive ¹⁾ –	–	To EU EMC Directive ¹⁾ To EU Low Voltage Directive
Note on materials	Free of copper and PTFE RoHS-compliant	Free of copper and PTFE –	Free of copper and PTFE –

1) For information about the applicability of the component see the manufacturer's EC declaration of conformity at: www.festo.com → Support → User documentation.
If the component is subject to restrictions on usage in residential, office or commercial environments or small businesses, further measures to reduce the emitted interference may be necessary.

Input signal/measuring element			
	SMEO-8E-...-24	SMEO-8E-...-24-S6, heat-resistant	SMEO-8E-...-230
Measuring principle	Magnetic reed	Magnetic reed	Magnetic reed
Ambient temperature [°C]	–40 ... +60	–40 ... +120	–20 ... +60

Switching output			
	SMEO-8E-...-24	SMEO-8E-...-24-S6, heat-resistant	SMEO-8E-...-230
Switching output	Contacting, bipolar –	Contacting –	Contacting, bipolar Without LED function
Switching element function	N/O contact	N/O contact	N/O contact
Reproducibility of switching value [mm]	±0.1	±0.1	±0.1
Switch-on time [ms]	0 ... 0.5	0 ... 0.5	0 ... 2
Switch-off time [ms]	0.03	0.03	0.03
Max. switching frequency [Hz]	800	500	500
Max. output current [mA]	500	500	120
Max. switching capacity DC [W]	10	10	10
Max. switching capacity AC [VA]	10	10	10
Voltage drop [V]	–	0.5	3.9

Output, additional data	
Protection against short circuit	No
Protection against overloading	No

Electronic components			
	SMEO-8E-...-24	SMEO-8E-...-24-S6, heat-resistant	SMEO-8E-...-230
Operating voltage range DC [V]	12 ... 30	0 ... 30	3 ... 250
Operating voltage range AC [V]	12 ... 30	0 ... 30	3 ... 230
Reverse polarity protection	No	For all electrical connections	No

Proximity sensors SMEO-8E, for T-slot

Technical data – Magnetic reed

Electromechanical components				
Type	SMEO-8E-S-LED-24	SMEO-8E-M12-LED-24	SMEO-8E-K-24-S6, heat-resistant	SMEO-8E-M12-LED-230
Electrical connection	Plug M8x1, 3-pin	Plug M12x1, 3-pin	Cable, 2-wire	Plug M12x1, 3-pin
Connection direction	Lateral	Lateral	Lateral	In-line
Pin contact materials	Nickel-plated brass	Brass	–	–
Cable length [m]	–	–	2.5	–
Cable sheath materials	–	–	TPE-S	–

Mechanical components				
Type	SMEO-8E-S-LED-24	SMEO-8E-M12-LED-24	SMEO-8E-K-24-S6, heat-resistant	SMEO-8E-M12-LED-230
Type of mounting	Via accessories		Via accessories	Via accessories
Tightening torque [Nm]	0.5	0.5	0.5	0.5
Housing materials	TPE-U(PU)	TPE-U(PU)	TPE-U(PU)	TPE-U(PU)
	High-alloy stainless steel	High-alloy stainless steel	–	High-alloy stainless steel
	Wrought aluminium alloy	Wrought aluminium alloy	–	Wrought aluminium alloy
	Nickel-plated brass	–	–	–

Display/operation			
	SMEO-8E-...-24	SMEO-8E-...-24-S6, heat-resistant	SMEO-8E-...-230
Switching status display	Yellow LED	–	Yellow LED

Immissions/emissions			
	SMEO-8E-...-24	SMEO-8E-...-24-S6, heat-resistant	SMEO-8E-...-230
Ambient temperature with flexible cable installation [°C]	–	–40 ... +120	–
Protection class	IP65	IP65	IP65
	IP67	IP67	IP67
Insulation voltage [V]	–	50	–
Surge capacity [kV]	0.8	–	4
Degree of contamination	3	3	3

Pin allocation to EN 60947-5-2				
M8x1, 3-pin			M12x1, 3-pin, 24 V	
N/O contact			N/O contact	
	Pin	Wire colour	Allocation	
	1	Brown	+	
	3	Blue	–	
	4	Black	Output	

Pin allocation to EN 60947-5-2			
M12x1, 3-pin, 230 V			
N/O contact			
	Pin	Wire colour	Allocation
	4	Black	~ / +
	3	Blue	~ / –

Proximity sensors SMEO-8E, for T-slot

Technical data – Magnetic reed

FESTO

Dimensions

Download CAD Data → www.festo.com/us/cad

SMEO-8E-S-LED-24 – Plug M8x1

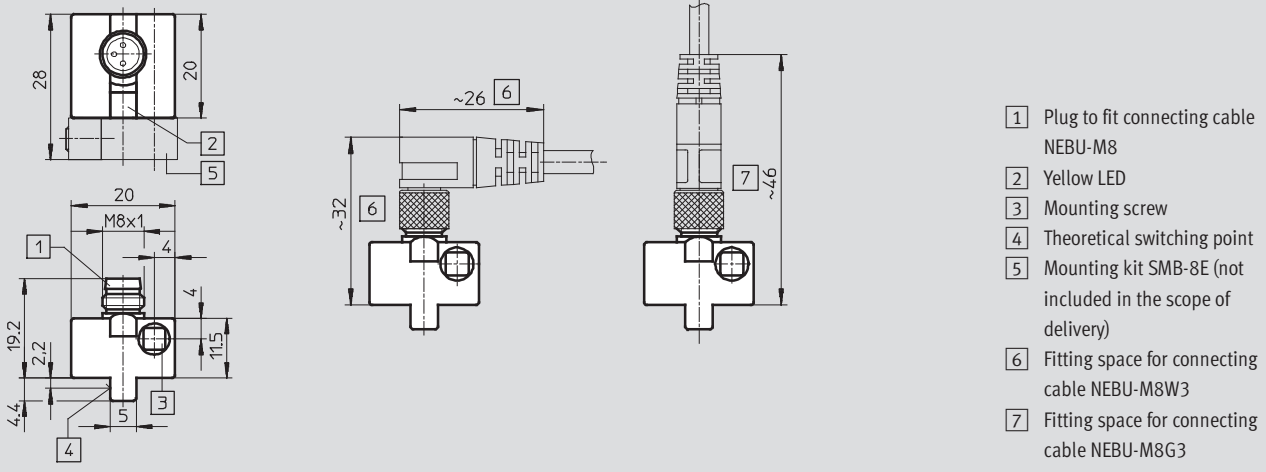

SMEO-8E-M12-LED-24 – Plug M12x1

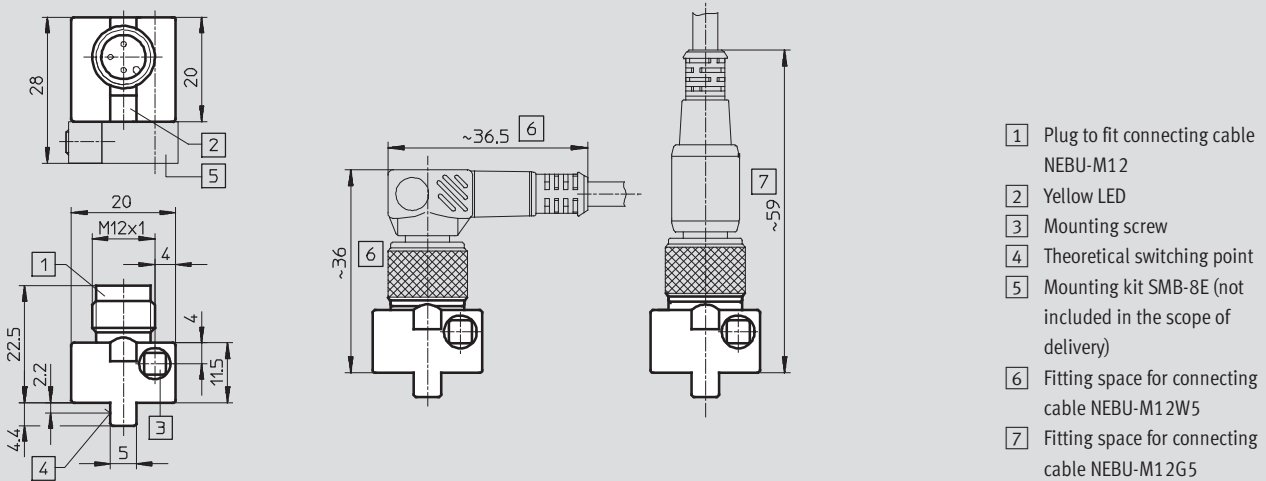

SMEO-8E-K24-S6 – Cable, heat-resistant up to 120 °C

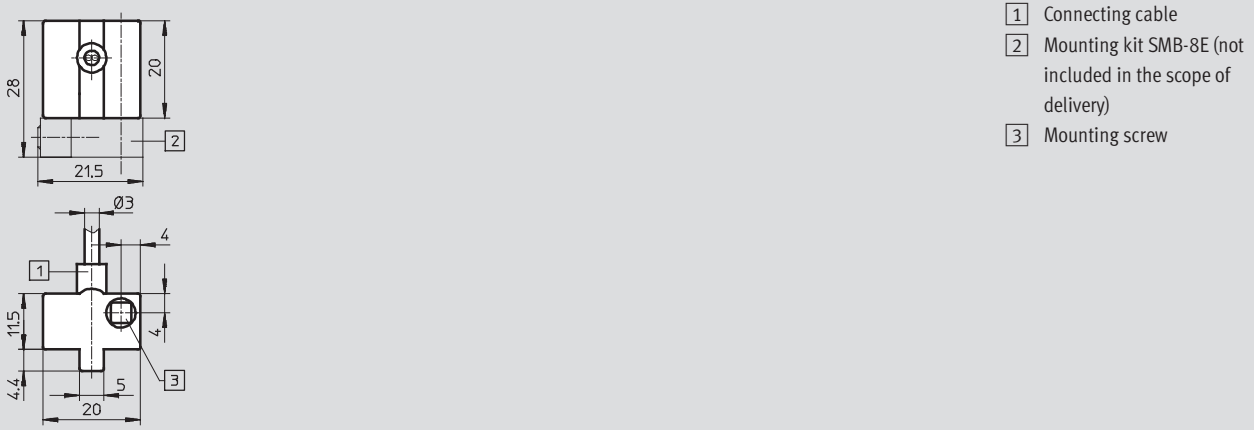

Proximity sensors SMEO-8E, for T-slot

Technical data – Magnetic reed

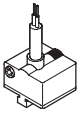
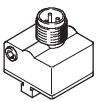
Ordering data								
	Switching output	Electrical connection			Cable length [m]	Product weight [g]	Part No.	Type
		Cable	Plug M8x1	Plug M12x1				
N/O contact, basic version								
	Contacting, bipolar	-	3-pin	-		10	171163	SMEO-8E-S-LED-24
			-	3-pin			9	171164
N/O contact, heat-resistant								
	Contacting, bipolar		2-wire	-	2.5	40	171158	SMEO-8E-K-24-S6
N/O contact, operating voltage range 3 ... 250 V AC/DC								
	Contacting, bipolar		-	3-pin	-	9	171160	SMEO-8E-M12-LED-230

Proximity sensors SMT/SME-8, for T-slot

Accessories



Mounting kit SMBR-8-8/100-S6

Materials:

Rail: Anodised wrought aluminium alloy

Clamping strap, screws: High-alloy stainless steel

Free of copper and PTFE

RoHS-compliant

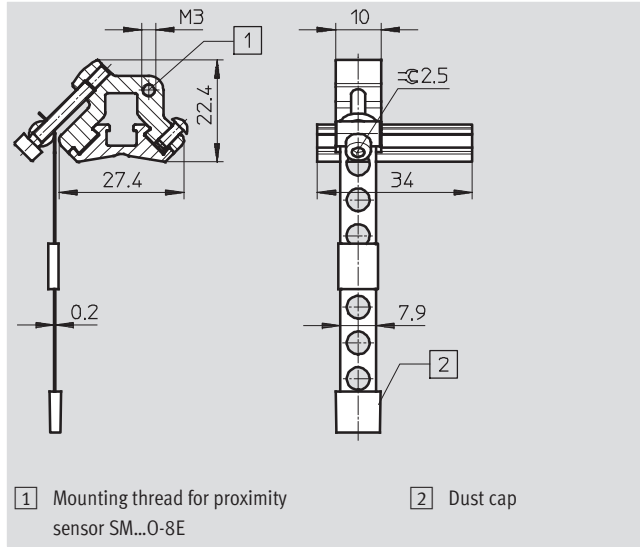

Dimensions and ordering data			
For piston Ø	Corrosion resistance class CRC ¹⁾	Part No.	Type
8 ... 100	4	538937	SMBR-8-8/100-S6

1) Corrosion resistance class 4 according to Festo standard 940 070
Components subject to particularly high corrosion stress. Parts used with aggressive media, e.g. in the food or chemical industry. These applications should be supported with special tests with the media if required.

Mounting kit SMBR

Material:

Polyacetal

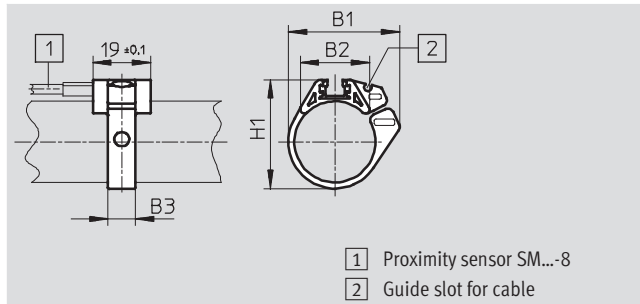

Dimensions and ordering data						
For piston Ø	B1	B2	B3	H1	Part No.	Type
8	18.9	12.3	7	17.5	175091	SMBR-8-8
10	20.4	13.7	7	19.9	175092	SMBR-8-10
12	22.7	14.3	7	21.9	175093	SMBR-8-12
16	28.2	16.9	8	25.7	175094	SMBR-8-16
20	34.5	20.8	9	30.4	175095	SMBR-8-20
25	36.7	22.7	9	35.6	175096	SMBR-8-25
32	41.7	24.6	9	42.7	175097	SMBR-8-32
40	47.1	26.5	9	50.7	175098	SMBR-8-40
50	56.4	28.6	9	61.5	175099	SMBR-8-50
63	69.4	32	9	74.5	175100	SMBR-8-63

Proximity sensors SMT/SME-8, for T-slot

Accessories

Mounting kit CRSMB

Materials:
 Housing: Polyurethane
 Rail: Hard anodised aluminium
 Free of copper and PTFE

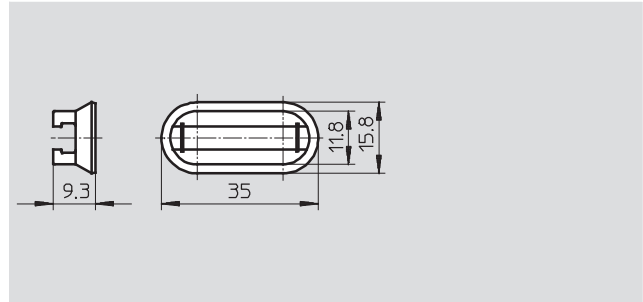

Note

The mounting kit is secured to the cylinder using the double-sided adhesive tape provided.

Dimensions and ordering data

For piston \varnothing	Part No.	Type
32 ... 100	525565	CRSMB-8-32/100

Mounting kit SMB-8-FENG

Material:
 Wrought aluminium alloy
 Free of copper and PTFE

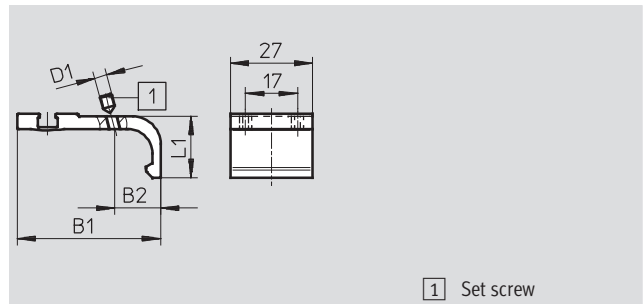
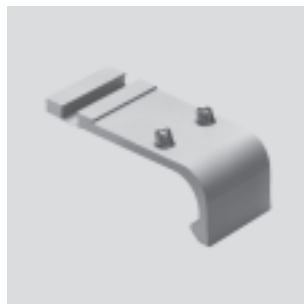

1 Set screw

Dimensions and ordering data

For piston \varnothing	B1	B2	D1	L1	Tightening torque [Nm]	Part No.	Type
32/40	35.1	8.7	M3	15.5	0.2	175705	SMB-8-FENG-32/40
50/63	47	12.3	M4	20	0.5	175706	SMB-8-FENG-50/63
80/100	64.3	15.7	M5	24.3	0.7	175707	SMB-8-FENG-80/100

Mounting kit SMB-8E

Material:
 Polyacetal

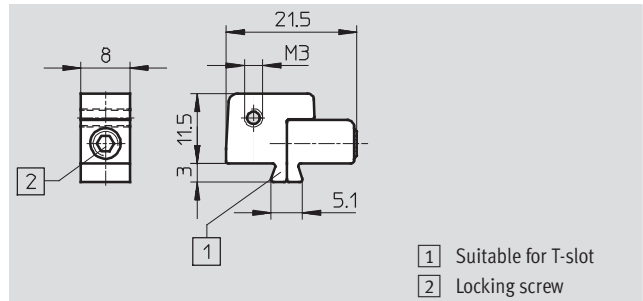

1 Suitable for T-slot
 2 Locking screw

Ordering data

For piston \varnothing	Part No.	Type
10 ... 125	178230	SMB-8E

Proximity sensors SMT/SME-8, for T-slot

Accessories



Mounting SMBZ-8-...

Materials:

- Rail: Anodised wrought aluminium alloy
- Screws: High-alloy stainless steel
- Free of copper and PTFE
- RoHS-compliant

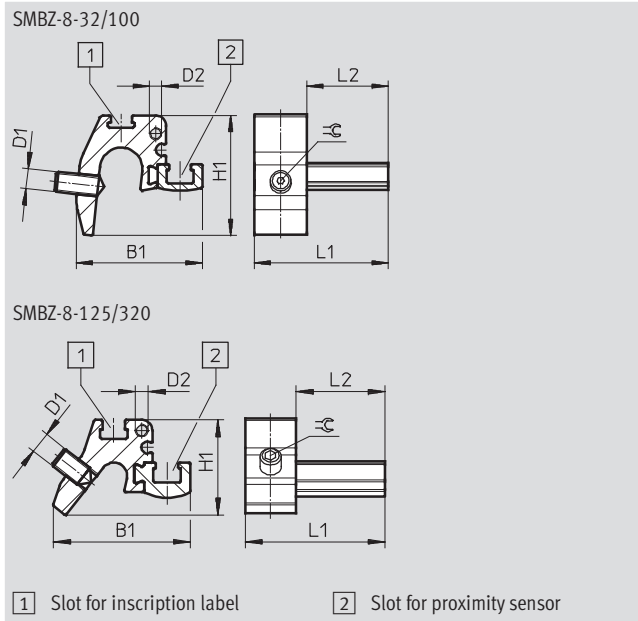

Dimensions and ordering data									
For piston \varnothing	B1	D1	D2	H1	L1	L2	$\approx C$	Part No.	Type
32 ... 100	31	M5	M3	30	33	20	1.5	537806	SMBZ-8-32/100
125 ... 320	32.3			22			2.5	537808	SMBZ-8-125/320

Positioning component SMM

Insertable in slot lengthwise

Ambient temperature: -40 ... +120 °C

Materials:

- Housing: Anodised wrought aluminium alloy
- Screws: High-alloy stainless steel
- Note on materials: RoHS-compliant

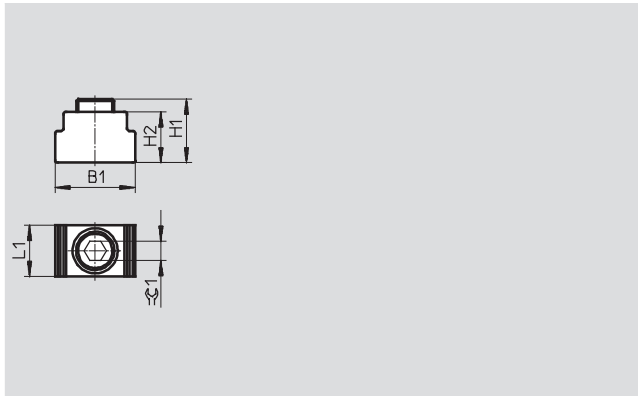

Dimensions and ordering data								
B1	H1	H2	L1	$\approx C1$	CRC ¹⁾	Part No.	Type	PU ²⁾
6.3	5.0	4.0	4.0	1.5	3	547941	SMM-8	10





1) Corrosion resistance class 4 according to Festo standard 940 070
 Components subject to particularly high corrosion stress. Parts used with aggressive media, e.g. in the food or chemical industry. These applications should be supported with special tests with the media if required.



2) Packaging unit

Proximity sensors SMT/SME-8, for T-slot

Accessories

FESTO

Ordering data – Connecting cables				Technical data → Internet: nebu	
		Number of wires	Cable length [m]	Part No.	Type
Socket M8x1, 3-pin					
	For SMT/SME-8... and SMT0/SMTSO/SME0-8E	3	2.5	541333	NEBU-M8G3-K-2.5-LE3
			5	541334	NEBU-M8G3-K-5-LE3
	For SMT/SME-8... and SMT0/SMTSO/SME0-8E	3	2.5	541338	NEBU-M8W3-K-2.5-LE3
			5	541341	NEBU-M8W3-K-5-LE3
Socket M12x1, 5-pin					
	For SMT/SME-8M and SMT0/SMTSO/SME0-8E	3	2.5	541363	NEBU-M12G5-K-2.5-LE3
			5	541364	NEBU-M12G5-K-5-LE3
	For SMT/SME-8M and SMT0/SMTSO/SME0-8E	3	2.5	541367	NEBU-M12W5-K-2.5-LE3
			5	541370	NEBU-M12W5-K-5-LE3

Ordering data – Inscription labels, safety clips				
	Size	Part No.	Type	PU ¹⁾
	23x4 mm	541598	ASLR-L-423	34
	M8	548067	NEAU-M8-GD	1
	M12	548068	NEAU-M12-GD	1

1) Packaging unit per frame

Ordering data – Mounting attachments			
	For Ø	Part No.	Type
	–	534254	SMBK-8

Ordering data – Sensor tester	
	Part No. Type
	158481 SM-TEST-1

Product Range and Company Overview

A Complete Suite of Automation Services

Our experienced engineers provide complete support at every stage of your development process, including: conceptualization, analysis, engineering, design, assembly, documentation, validation, and production.



Custom Automation Components
Complete custom engineered solutions



Custom Control Cabinets
Comprehensive engineering support and on-site services



Complete Systems
Shipment, stocking and storage services

The Broadest Range of Automation Components

With a comprehensive line of more than 30,000 automation components, Festo is capable of solving the most complex automation requirements.



Electromechanical
Electromechanical actuators, motors, controllers & drives



Pneumatics
Pneumatic linear and rotary actuators, valves, and air supply



PLCs and I/O Devices
PLC's, operator interfaces, sensors and I/O devices

Supporting Advanced Automation... As No One Else Can!

Festo is a leading global manufacturer of pneumatic and electromechanical systems, components and controls for industrial automation, with more than 12,000 employees in 56 national headquarters serving more than 180 countries. For more than 80 years, Festo has continuously elevated the state of manufacturing with innovations and optimized motion control solutions that deliver higher performing, more profitable automated manufacturing and processing equipment. Our dedication to the advancement of automation extends beyond technology to the education and development of current and future automation and robotics designers with simulation tools, teaching programs, and on-site services.

Quality Assurance, ISO 9001 and ISO 14001 Certifications

Festo Corporation is committed to supply all Festo products and services that will meet or exceed our customers' requirements in product quality, delivery, customer service and satisfaction.

To meet this commitment, we strive to ensure a consistent, integrated, and systematic approach to management that will meet or exceed the requirements of the ISO 9001 standard for Quality Management and the ISO 14001 standard for Environmental Management.



© Copyright 2008, Festo Corporation. While every effort is made to ensure that all dimensions and specifications are correct, Festo cannot guarantee that publications are completely free of any error, in particular typing or printing errors. Accordingly, Festo cannot be held responsible for the same. For Liability and Warranty conditions, refer to our "Terms and Conditions of Sale", available from your local Festo office. All rights reserved. No part of this publication may be reproduced, distributed, or transmitted in any form or by any means, electronic, mechanical, photocopying or otherwise, without the prior written permission of Festo. All technical data subject to change according to technical update.



Printed on recycled paper at New Horizon Graphic, Inc., FSC certified as an environmentally friendly printing plant.

Festo North America

Festo Regional Contact Center

5300 Explorer Drive
Mississauga, Ontario L4W 5G4
Canada

USA Customers:

For ordering assistance,

Call: 1.800.99.FESTO (1.800.993.3786)

Fax: 1.800.96.FESTO (1.800.963.3786)

Email: customer.service@us.festo.com

For technical support,

Call: 1.866.GO.FESTO (1.866.463.3786)

Fax: 1.800.96.FESTO (1.800.963.3786)

Email: product.support@us.festo.com

Canadian Customers:

Call: 1.877.GO.FESTO (1.877.463.3786)

Fax: 1.877.FX.FESTO (1.877.393.3786)

Email: festo.canada@ca.festo.com

USA Headquarters

Festo Corporation
395 Moreland Road
P.O. Box 18023
Hauppauge, NY 11788, USA
www.festo.com/us

USA Sales Offices

Appleton

North 922 Tower View Drive, Suite N
Greenville, WI 54942, USA

Boston

120 Presidential Way, Suite 330
Woburn, MA 01801, USA

Chicago

1441 East Business Center Drive
Mt. Prospect, IL 60056, USA

Dallas

1825 Lakeway Drive, Suite 600
Lewisville, TX 75057, USA

Detroit – Automotive Engineering Center

2601 Cambridge Court, Suite 320
Auburn Hills, MI 48326, USA

New York

395 Moreland Road
Hauppauge, NY 11788, USA

Silicon Valley

4935 Southfront Road, Suite F
Livermore, CA 94550, USA

United States



USA Headquarters, East: Festo Corp., 395 Moreland Road, Hauppauge, NY 11788

Phone: 1.631.435.0800; Fax: 1.631.435.8026;

Email: info@festo-usa.com

www.festo.com/us

Canada



Headquarters: Festo Inc., 5300 Explorer Drive, Mississauga, Ontario L4W 5G4

Phone: 1.905.624.9000; Fax: 1.905.624.9001;

Email: festo.canada@ca.festo.com

www.festo.ca

Mexico



Headquarters: Festo Pneumatic, S.A., Av. Ceylán 3, Col. Tequesquahuac,
54020 Tlalneantla, Edo. de México

Phone: 011 52 [55] 53 21 66 00; Fax: 011 52 [55] 53 21 66 65;

Email: festo.mexico@mx.festo.com

www.festo.com/mx

Central USA

Festo Corporation
1441 East Business
Center Drive
Mt. Prospect, IL 60056, USA
Phone: 1.847.759.2600
Fax: 1.847.768.9480



Western USA

Festo Corporation
4935 Southfront Road,
Suite F
Livermore, CA 94550, USA
Phone: 1.925.371.1099
Fax: 1.925.245.1286



Festo Worldwide

Argentina Australia Austria Belarus Belgium Brazil Bulgaria Canada Chile China Colombia Croatia Czech Republic Denmark
Estonia Finland France Germany Great Britain Greece Hong Kong Hungary India Indonesia Iran Ireland Israel Italy Japan Latvia
Lithuania Malaysia Mexico Netherlands New Zealand Norway Peru Philippines Poland Romania Russia Serbia Singapore
Slovakia Slovenia South Africa South Korea Spain Sweden Switzerland Taiwan Thailand Turkey Ukraine United States Venezuela

www.festo.com