

Pressure sensors SPBA, for valves

Technical data

Pressure sensor SPBA

- Pressure sensor with permanently set switching point
- Electrical connection: Plug M12x1 to EN 60947-5-2
- Mounting: Screw-in

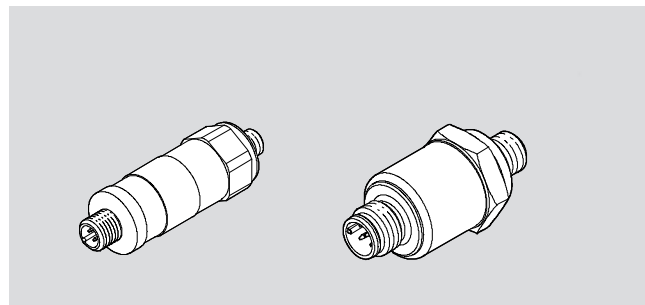

General technical data		
Type	SPBA-P2R-G18-2P-...	SPBA-P2R-G18-W-...
Electrical connection	Plug to EN 60947-5-2, M12x1, 4-pin, round	
Operating voltage range	[V DC]	21.6 ... 26.4
Max. output current	[mA]	500
Minimum load current (at 24 V)	[mA]	–
Protection against short circuit	Yes	–
Reverse polarity protection	For all electrical connections	–
Type of mounting	Screw-in, 22 mm A/F	Screw-in, 24 mm A/F
Mounting position	Any	
Pneumatic connection	G $\frac{1}{8}$	
Weight	[g]	50
Protection class to EN 60529	IP65	

Materials		
Type	SPBA-P2R-G18-2P-...	SPBA-P2R-G18-W-...
Housing	High-alloy stainless steel	Steel
Plug	PBT	POM
Note on materials	RoHS-compliant	

Operating and environmental conditions		
Type	SPBA-P2R-G18-2P-...	SPBA-P2R-G18-W-...
Operating medium	Compressed air in accordance with ISO 8573-1:2010 [7:4:4]	
Note about the operating/pilot medium	Operation with lubricated medium possible	
Ambient temperature	[°C]	–5 ... +50
Operating pressure	[bar]	–1 ... +10
Corrosion resistance class CRC ¹⁾	4	0
CE marking (see declaration of conformity)	To EU EMC Directive ²⁾	–
	To EU Machinery Directive	To EU Machinery Directive

- 1) Corrosion resistance class 4 according to Festo standard 940 070
 Components subject to particularly high corrosion stress. Parts used with aggressive media, e.g. in the food or chemical industry. These applications should be supported with special tests with the media if required.
- 2) For information about the applicability of the component see the manufacturer's EC declaration of conformity at: www.festo.com → Support → User documentation.
 If the component is subject to restrictions on usage in residential, office or commercial environments or small businesses, further measures to reduce the emitted interference may be necessary.

Pressure sensors SPBA, for valves

Technical data

Input signal/measuring element		
Type	SPBA-P2R-G18-2P-...	SPBA-P2R-G18-W-...
Measured variable	Relative pressure	Relative pressure
Method of measurement	Thin-film metal pressure sensor	Pneumatic/electrical pressure transducer

Electrical data		
Type	SPBA-P2R-G18-2P-...	SPBA-P2R-G18-W-...
Switching output	2x PNP	Contacting
Switching function	Threshold value - fixed hysteresis	
Switching element function	Antivalent	Changeover switch
Switch-on point	[bar]	0.25, permanently set
Max. switch-on point	[bar]	0.40
Min. switch-off point	[bar]	0.05

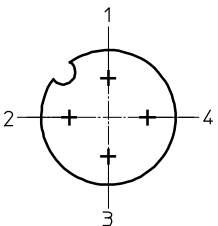
Pin allocation to EN 60947-5-2			
Plug, 4-pin			
M12x1	Pin	SPBA-P2R-G18-2P-...	SPBA-P2R-G18-W-... ¹⁾
	1	Operating voltage +24 V DC	Operating voltage +24 V DC
	2	N/C contact	N/C contact
	3	0 V	n.c.
	4	N/O contact	N/O contact

1) Allocation applies to PNP switching logic, other connection types possible

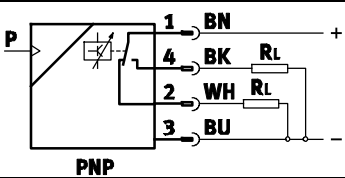
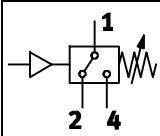
Circuit symbol	
SPBA-P2R-G18-2P-...	SPBA-P2R-G18-W-...
 <p>PNP</p>	

Pressure sensors SPBA, for valves

Technical data

Dimensions

Download CAD data → www.festo.com

SPBA-P2R-G18-2P-...

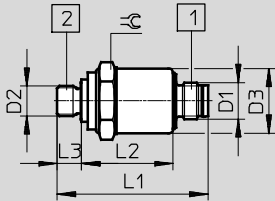

- 1 Plug M12x1
- 2 Pressure supply port G¹/₈

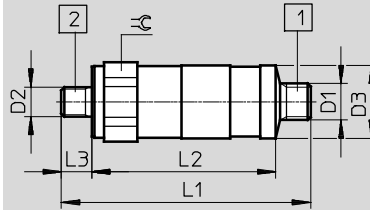

SPBA-P2R-G18-W-...



- 1 Plug M12x1
- 2 Pressure supply port G¹/₈

Type	D1	D2	D3	L1	L2	L3	⌀
SPBA-P2R-G18-2P-M12-0,25X	M12x1	G ¹ / ₈	21.3	49.6	38.1	8	22
SPBA-P2R-G18-W-M12-0,25X	M12x1	G ¹ / ₈	25	82	60.5	10	24

Ordering data

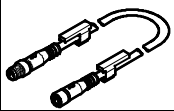
	Description	Part No.	Type
Pressure switch			
	Mechanical pressure switch, pneumatic/electrical pressure transducer, contacting switching output	8000033	SPBA-P2R-G18-W-M12-0,25X
	Electrical pressure switch, thin-film metal pressure sensor, 2xPNP switching output	8000210	SPBA-P2R-G18-2P-M12-0,25X
Connecting cable			
	Socket M12x1, 5-pin; plug M12x1, 4-pin; for connecting pressure sensor	0.5 m	8000208 NEBU-M12G5-K-0.5-M12G4