

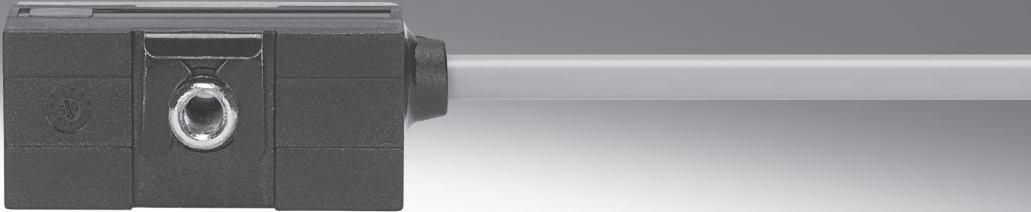





Proximity sensors, block design

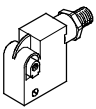

# Proximity sensors, block design

Product range overview

Measuring principle	Version	Type	Mounting	Switching element function		Switching output	Electrical connection	
				N/O contact	N/C contact		Cable	Plug
Magneto-resistive	Operating voltage range 10 ... 30 V DC							
		SMTSO-1 Welding field immune	Via accessories	■	-	PNP	3-wire	M8x1, 3-pin
				■	-	NPN	3-wire	M8x1, 3-pin
		■		-	PNP	-	M12x1, 3-pin	
Magnetic reed	Operating voltage range 0 ... 30 V DC							
		SMEO-1	Via accessories	■	-	Contacting	-	M8x1, 3-pin <sup>1)</sup>
				■	-		3-wire	M8x1, 3-pin
	Operating voltage range 0 ... 250 V AC, 0 ... 200 V DC							
		SMEO-1-B	Via accessories	■	-	Contacting	2-wire	-
		SMEO-1		■	-		2-wire	-
				■	-		2-wire	-
	SMEO-1-S6-C Heat-resistant up to 120 °C	■		-	2-wire		-	
Magnetic	Pneumatic proximity sensor, operating pressure 2 ... 6 bar							
		SMPO-1	Via accessories	■ <sup>2)</sup>	-	-	-	-
Magneto-inductive	Operating voltage range 10 ... 30 V DC							
		SMT-C1	Clamped	■	-	PNP	3-wire	M8x1, 3-pin M12x1, 3-pin

1) The proximity sensor has 2 wires internally. One pin of the M8 plug is unused.

2) 3/2-way valve, normally closed

# Proximity sensors, block design

Product range overview

Type	Connection direction		Replacement with- out re-adjustment	Switching status display via LED	Free of copper and PTFE	→ Page/Internet
	In-line	Lateral				
<b>Operating voltage range 10 ... 30 V DC</b>						
SMT0-1	■	-	■ 1)	■	■	7
	■	-	■ 1)	■	-	
SMTSO-1 Welding field immune	■	-	-	■	-	9
<b>Operating voltage range 0 ... 30 V DC</b>						
SME0-1	■	-	■ 1)	-	■	11
	■	-	■ 1)	■	■	
<b>Operating voltage range 0 ... 250 V DC, 0 ... 200 V DC</b>						
SME0-1-B	■	-	■ 1)	-	-	11
SME0-1	■	-	■ 1)	■	-	
	■	-	■ 1)	-	-	
SME0-1-S6-C Heat-resistant up to 120 °C	■	-	■ 1)	■	-	
<b>Pneumatic proximity sensor, operating pressure 2 ... 6 bar</b>						
SMPO-1	■	-	■ 1)	- 2)	-	14
<b>Operating voltage range 10 ... 30 V DC</b>						
SMT-C1	■	-	-	■	■	16

1) Not in combination with mounting kit SMB-1 or SMBS-...

2) Switching status is indicated via a pneumatic pin

# Proximity sensors, block design

Overview of peripherals

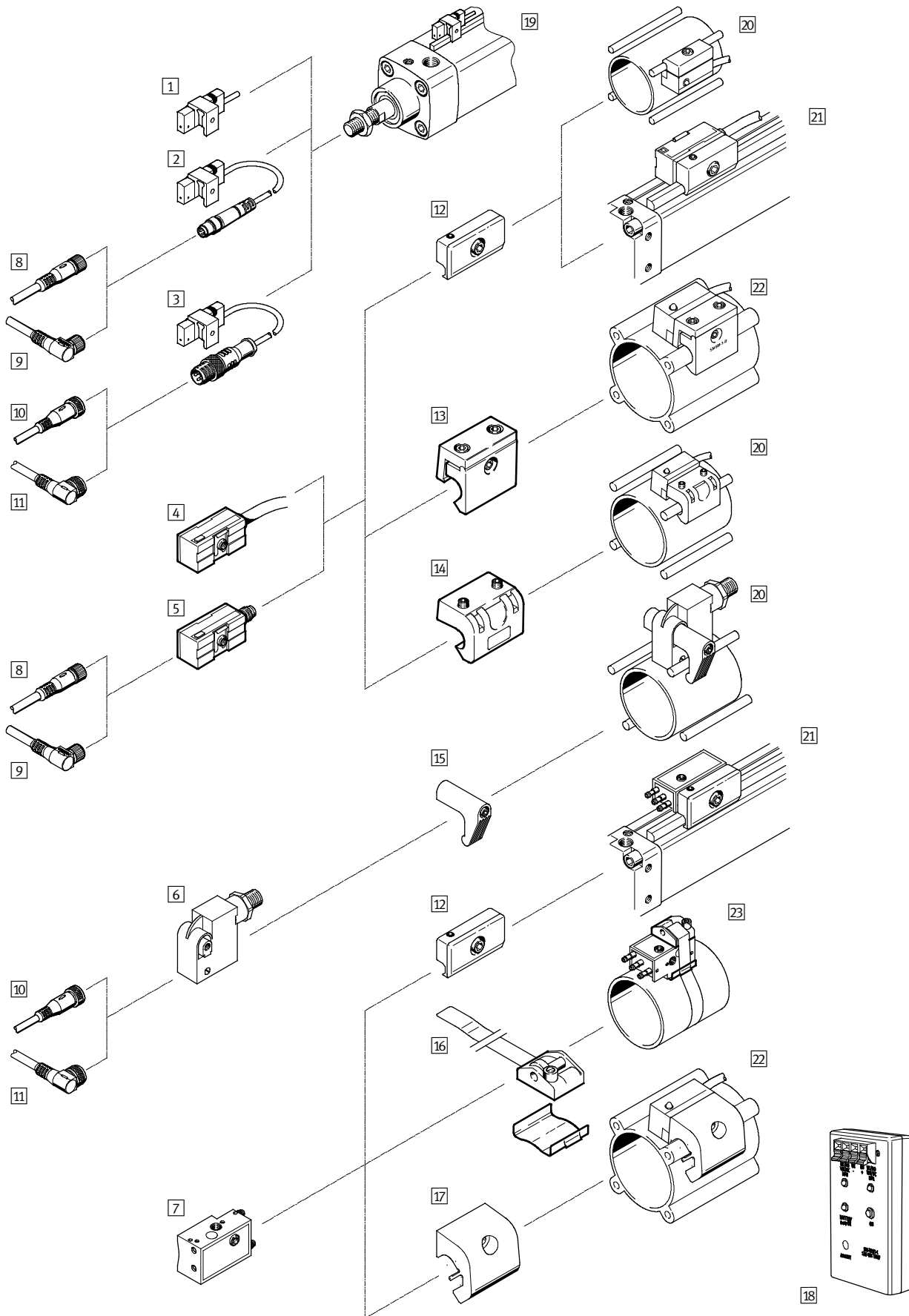

# Proximity sensors, block design

Overview of peripherals

Mounting attachments and accessories		
	Brief description	→ Page/Internet
<b>Proximity sensors</b>		
1	SMT-C1-...	Magneto-inductive, with cable and clamping component
2	SMT-C1-...	Magneto-inductive, with cable and plug M8x1 and clamping component
3	SMT-C1-...	Magneto-inductive, with cable and plug M12x1 and clamping component
4	SMT0-1-...	Magneto-resistive, with cable
	SME0-1-...	Magnetic reed, with cable
5	SMT0-1-...	Magneto-resistive, with plug M8x1
	SME0-1-...	Magnetic reed, with plug M8x1
6	SMTSO-1-...	Magneto-resistive, welding field immune, with plug M12x1
7	SMPO-1-...	Pneumatic
<b>Accessories</b>		
8	Connecting cable NEBU-M8G3-...	Straight socket, M8x1, 3-pin
9	Connecting cable NEBU-M8W3-...	Angled socket, M8x1, 3-pin
10	Connecting cable NEBU-M12G5-...	Straight socket, M12x1, 3-pin
11	Connecting cable NEBU-M12W5-...	Angled socket, M12x1, 3-pin
12	Mounting kit SMB-1	For drives with tie rod $\varnothing$ 6 mm or mounting rail For standard cylinders DNG
13	Mounting kit SMBU-1-B	For standard cylinders DNU
14	Mounting kits SMB-2-B, SMB-3-B	For standard cylinders DNG
15	Mounting kit SMBT-1	For standard cylinders DNG
16	Mounting kit SMBS-...	For round cylinders
17	Mounting kit SMBU-1-H-32	For standard cylinders DNU
18	Sensor tester SM-TEST-1	sm-test-1
<b>Drives</b>		
19	Standard cylinder DSBF-C or CDN-...-R with sensor rail	$\varnothing$ 32 ... 100 mm
20	Standard cylinder DNG	$\varnothing$ 32 ... 320 mm
21	Flat cylinder DZH	$\varnothing$ 32 ... 63 mm
	Semi-rotary drive DRQ	$\varnothing$ 40 ... 100 mm
22	Standard cylinder DNU	$\varnothing$ 32 ... 125 mm
23	Round cylinder	$\varnothing$ 8 ... 100 mm

# Proximity sensors, block design

Type codes

## Proximity sensor for cylinders with tie or mounting rod

		SMT0-1	-	PS	-	K	-	LED	-	24	-	C
<b>Function</b>												
SMT0-1	Proximity sensor, block design, magneto-resistive											
SMTSO-1	Proximity sensor, block design, magneto-resistive, welding field immune											
SME0-1	Proximity sensor, block design, magnetic reed											
SMPO-1	Proximity sensor, block design, magnetic											
<b>Switching output, switching element function</b>												
PS	PNP, N/O contact, 3-wire											
NS	NPN, N/O contact, 3-wire											
	N/O contact, 2 or 3-wire											
<b>Electrical connection, cable length</b>												
K	Cable, 2.5 m											
S	Plug M8x1											
<b>Switching status display</b>												
LED	Yellow LED											
<b>Rated operating voltage</b>												
24	24 V DC											
230	230 V AC											
<b>Generation</b>												
B	B series											
C	C series											

## Proximity sensor for standard cylinders DSBF-C or CDN-...-R with sensor strip

		SMT-C1	-	PS	-	24V	-	K	-	5,0	-	OE
<b>Function</b>												
SMT-C1	Proximity sensor, block design, magneto-inductive											
<b>Switching element function, switching output</b>												
PS	N/O contact, 3-wire, PNP											
<b>Rated operating voltage</b>												
24V	24 V DC											
<b>Version</b>												
K	Cable											
<b>Cable length</b>												
0,3	0.3 m											
5,0	5.0 m											
10,0	10.0 m											
<b>Electrical connection</b>												
OE	Open end											
M8D	Cable with plug M8x1, rotatable thread											
M12	Cable with plug M12x1											

# Proximity sensors SMTO-1, block design, magneto-resistive

## Technical data

### Function

e.g. PNP, N/O contact, with cable

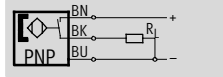

e.g. NPN, N/O contact, with cable

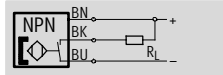

- Magneto-resistive measuring principle

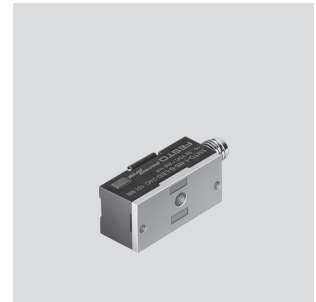
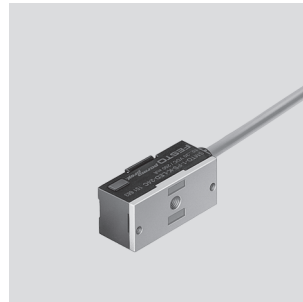

Design	
Constructional design	Block design
Type of mounting	Via accessories
Connection direction	In-line
Reproducibility of switching point <sup>1)</sup>	[mm] ±0.1
Switching status display	Yellow LED

1) Only applicable to drives secured against rotation.

Technical data – N/O contact		
Switch output	PNP	
	NPN	
Electrical connection	Cable, 3-wire	Plug M8x1, 3-pin
Cable length	[m] 2.5	–
Operating voltage range	[V DC] 10 ... 30	
Max. switching current	[mA] 200	
Max. switching capacity	[W] 6	
Voltage drop	[V] 3	
Residual current	[mA] ≤0.01	
Switch-on time	[ms] ≤1	
Switch-off time	[ms] ≤1	
Protection against short circuit	Yes	
Protection against polarity reversal	For all electrical connections	
Protection class	IP67	

Operating and environmental conditions			
Electrical connection	Cable		Plug
Cable installation	Fixed	Flexible	
Ambient temperature	[°C] –25 ... +70	–5 ... +70	–25 ... +70
Corrosion resistance class CRC <sup>1)</sup>	4		2
CE symbol (declaration of conformity)	In accordance with EU EMC directive <sup>2)</sup>		
Certification	C-Tick		

- 1) Corrosion resistance class 2 according to Festo standard 940 070  
Components requiring moderate corrosion resistance. Externally visible parts with primarily decorative surface requirements which are in direct contact with a normal industrial environment or media such as coolants or lubricating agents.
- Corrosion resistance class 4 according to Festo standard 940 070  
Components requiring higher corrosion resistance. Parts used with aggressive media, e.g. food or chemical industry. These applications should be supported with special tests with the media if required.
- 2) For information about the applicability of the component see the manufacturer's EC declaration of conformity at: [www.festo.com](http://www.festo.com) → Support → User documentation.  
If the component is subject to restrictions on usage in residential, office or commercial environments or small businesses, further measures to reduce the emitted interference may be necessary.

Materials	
Housing	Die-cast zinc, polyester
Cable sheath	Polyvinyl chloride
Note on materials	Free of copper and PTFE

# Proximity sensors SMTO-1, block design, magneto-resistive

Technical data

Product weights [g]		
Electrical connection	Cable	Plug
N/O contact		
PNP	85	20
NPN	85	20

**Dimensions** Download CAD data → [www.festo.com](http://www.festo.com)

Cable type

1 Connecting cable  
2 Yellow LED

**Plug type M8x1**

2 Yellow LED  
3 Plug suitable for plug socket with cable NEBU-M8...  
4 Installation space for angled socket

**Ordering data**

	Switch output	Electrical connection		Cable length [m]	Part No.	Type
		Cable	Plug M8x1			
	N/O contact					
	PNP	3-wire	–	2.5	151683	SMTO-1-PS-K-LED-24-C
		–	3-pin	–	151685	SMTO-1-PS-S-LED-24-C
	NPN	3-wire	–	2.5	151684	SMTO-1-NS-K-LED-24-C
–		3-pin	–	151686	SMTO-1-NS-S-LED-24-C	



# Proximity sensors SMTSO-1, block design, magneto-resistive

## Technical data

### Function

PNP, N/O contact, with plug

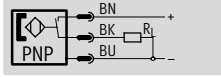

- Welding field immune
- Magneto-resistive measuring principle



Design	
Constructional design	Block design
Type of mounting	Via accessories
Connection direction	In-line
Reproducibility of switching point <sup>1)</sup>	[mm] ±0.1
Switching status display	Yellow LED
Ready status display	Green LED

1) Only applicable to drives secured against rotation

Technical data – PNP, N/O contact	
Electrical connection	Plug M12x1, 3-pin
Operating voltage range	[V DC] 10 ... 30
Max. switching current	[mA] 200
Max. switching capacity	[W] 6
Voltage drop	[V] 3
Residual current	[mA] 0.01
Switch-on time	[ms] ≤35
Switch-off time	[ms] ≤20
Resistance to interference from magnetic fields	Alternating magnetic field 50 ... 60 Hz
Protection against short circuit	Yes
Protection against polarity reversal	For all electrical connections
Protection class	IP65/IP67

Operating and environmental conditions	
Ambient temperature	[°C] -25 ... +70
Corrosion resistance class CRC <sup>1)</sup>	1
CE symbol (declaration of conformity)	In accordance with EU EMC directive <sup>2)</sup>
Certification	C-Tick

- 1) Corrosion resistance class 1 according to Festo standard 940 070  
Components requiring low corrosion resistance. Transport and storage protection. Parts that do not have primarily decorative surface requirements, e.g. in internal areas that are not visible or behind covers.
- 2) For information about the applicability of the component see the manufacturer's EC declaration of conformity at: [www.festo.com](http://www.festo.com) → Support → User documentation.  
If the component is subject to restrictions on usage in residential, office or commercial environments or small businesses, further measures to reduce the emitted interference may be necessary.

Materials	
Housing	Die-cast zinc

Product weights [g]	
N/O contact	
PNP	70

# Proximity sensors SMTSO-1, block design, magneto-resistive

Technical data

**Dimensions** Download CAD data → [www.festo.com](http://www.festo.com)

Plug type M12x1

Technical drawing showing dimensions and callouts for the SMTSO-1 proximity sensor. The drawing includes a front view and a side view. Dimensions are provided in millimeters: 25, 17, 22, 34, 22, 7.5, 10, 34, 11, 55, and ~85. Callouts 1, 2, 3, and 4 point to specific features: 1 (Green LED), 2 (Yellow LED), 3 (Mounting kit), and 4 (Installation space for socket). The side view also shows an M4 thread and an M12x1 plug type.

- 1 Green LED
- 2 Yellow LED
- 3 Mounting kit
- 4 Installation space for socket

Ordering data				
	Switch output	Electrical connection	Part No.	Type
	N/O contact			
	Welding field immune			
	PNP	Plug M12x1, 3-pin	30441	SMTSO-1-PS-S-LED-24

# Proximity sensors SMEO-1, block design, magnetic reed

## Technical data

### Function

e.g. N/O contact, 3-wire, with cable

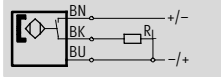

e.g. N/O contact, 3-wire, with plug

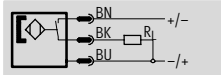

- Magnetic reed measuring principle

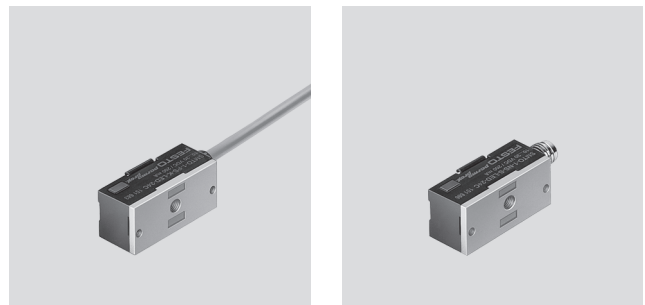

Technical data				
Electrical connection	3-wire		2-wire	
Type	SMEO-1-...-24		SMEO-1-LED-230	SMEO-1-B SMEO-1-S6, heat-resistant
Design	Block design		Block design	
Conforms to	-		EN 60947-5-2	
Certification	C-Tick		C-Tick	
CE mark (see declaration of conformity)	To EU EMC Directive <sup>1)</sup> -		To EU EMC Directive <sup>1)</sup> To EU Low Voltage Directive	
Note on materials	Free of copper and PTFE		Free of copper and PTFE	

1) For information about the applicability of the component see the manufacturer's EC declaration of conformity at: [www.festo.com](http://www.festo.com) → Support → User documentation.  
If the component is subject to restrictions on usage in residential, office or commercial environments or small businesses, further measures to reduce the emitted interference may be necessary.

Input signal/measuring element		
Type	SMEO-1	SMEO-1-S6, heat-resistant
Measuring principle	Magnetic reed	Magnetic reed
Ambient temperature	[°C] -20 ... +70	-50 ... +120

Switching output				
Electrical connection	3-wire		2-wire	
Type	SMEO-1-...-24		SMEO-1-LED-230	SMEO-1-B SMEO-1-S6, heat-resistant
Switching output	Contacting, bipolar -		Contacting, bipolar Without LED function -	
Switching element function	N/O contact		N/O contact	
Reproducibility of switching point <sup>1)</sup>	[mm]	±0.1	±0.1	
Switch-on time	[ms]	≤0.5	≤0.5	
Switch-off time	[ms]	≤0.03	≤0.03	
Max. switching frequency	[Hz]	-	500	500
Max. output current	[mA]	1,000	-	1,000
Max. output current DC	[mA]	-	120	1,000
Max. output current AC	[mA]	-	250	1,000
Max. switching capacity DC	[W]	27	40	
Max. switching capacity AC	[VA]	-	40	
Voltage drop	[V]	-	0 ... 4.5	0
Residual current	[mA]	-	0	

1) Only applicable to drives secured against rotation.

Output, additional data	
Protection against short circuit	No
Protection against overloading	No

# Proximity sensors SMEO-1, block design, magnetic reed

FESTO

Technical data

Electronic components					
Electrical connection		3-wire		2-wire	
Type		SMEO-1-...-LED-24	SMEO-1-S-24-B	SMEO-1-LED-230	SMEO-1-B SMEO-1-S6, heat-resistant
Operating voltage range DC	[V]	12 ... 27	0 ... 30	5 ... 200	0 ... 200
Operating voltage range AC	[V]	–	–	5 ... 250	0 ... 250
Reverse polarity protection		No		No	

Electromechanical components					
Electrical connection		3-wire		2-wire	
Type		SMEO-1-LED-24	SMEO-1-S-...-B	SMEO-1-LED-230	SMEO-1-B SMEO-1-S6, heat-resistant
Electrical connection		Cable, 3-wire	Plug M8x1, 3-pin	Cable, 2-wire	
Connection direction		In-line			
Cable length	[m]	2.5	–	2.5	2.5
		5		5	–
Cable sheath materials		PVC	–	PVC	PVC TPE-S

Mechanical components			
Electrical connection		3-wire	2-wire
Type of mounting		Via accessories	
Tightening torque	[Nm]	–	2.9
Product weight	[g]		
Housing materials		Die-cast zinc	Die-cast zinc
		–	Epoxy resin
			TPE-O
			Steel
			PET
			PC

Display/operation					
Electrical connection		3-wire		2-wire	
Type		SMEO-1-...-LED-24	SMEO-1-S-24-B	SMEO-1-LED-230	SMEO-1-B SMEO-1-S6, heat-resistant
Switching status display		Yellow LED	–	Yellow LED	–

Immissions/emissions					
Electrical connection		3-wire		2-wire	
Type		SMEO-1-...-LED-24	SMEO-1-S-24-B	SMEO-1-LED-230	SMEO-1-B SMEO-1-S6, heat-resistant
Ambient temperature with flexible cable installation	[°C]	–5 ... +70	–	–5 ... +70	–5 ... +70 –40 ... +120
Protection class		IP67		IP67	
Surge capacity	[kV]	–		4	
Degree of contamination		–		3	

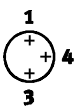
Pin allocation to EN 60947-5-2			
M8x1, 3-pin			
N/O contact			
	Pin	Wire colour	Allocation
	1	Brown	+
	3	Blue	–
	4	Black	Output

# Proximity sensors SMEO-1, block design, magnetic reed

Technical data

**Dimensions** Download CAD data → [www.festo.com](http://www.festo.com)

SMEO-1 – Cable SMEO-1-S – Plug M8x1

1 Connecting cable  
2 Yellow LED

2 Yellow LED  
3 Plug to fit connecting cable NEBU-M8  
4 Installation space for angled socket

Ordering data							
	Electrical connection		Cable length [m]	Switching status display	Product weight [g]	Part No.	Type
	Cable	Plug M8x1					
	N/O contact						
	Operating voltage range 12 ... 27 V DC						
	3-wire	–	2.5	■	85	30459	SMEO-1-LED-24-B
			5.0	■	130	151672	SMEO-1-LED-24-K5-B
	–	3-pin	–	■	20	150848	SMEO-1-S-LED-24-B
	Operating voltage range 0 ... 30 V DC						
	–	3-pin <sup>1)</sup>	–	–	20	150847	SMEO-1-S-24-B
	Operating voltage range 0 ... 250 V AC, 0 ... 200 V DC						
	2-wire	–	2.5	■	100	151671	SMEO-1-LED-230-B
			5.0	■	130	160998	SMEO-1-LED-230-K5-B
			2.5	–	100	30457	SMEO-1-B
	Heat-resistant up to 120 °C						
2-wire	–	2.5	–	100	151673	SMEO-1-S6-C	

1) The proximity sensor has 2 wires internally. One pin of the M8 plug is unused.

# Proximity sensors SMPO-1, block design, pneumatic

## Technical data

Function  
3/2-way valve,  
normally closed

- Pneumatic proximity sensor
- Magnetic measuring principle

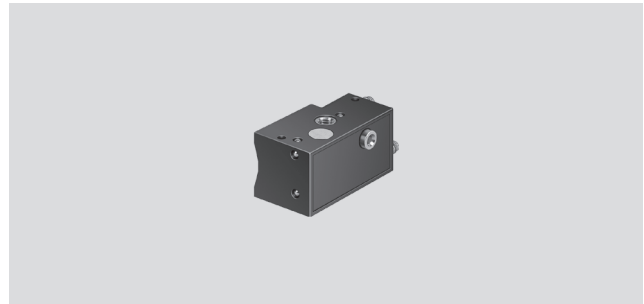
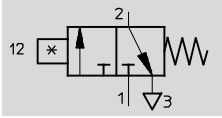

Design	
Constructional design	Block design
Type of mounting	Via accessories
Connection direction	In-line
Reproducibility of switching point <sup>1)</sup>	[mm] ±0.1
Switching status display	Optical

1) Only applicable to drives secured against rotation.

Technical data	
Switching element function	3/2-way valve, normally closed
Operating medium	Filtered, unlubricated compressed air
Operating pressure	[bar] 2 ... 6
Switch-on time	[ms] 12
Switch-off time	[ms] 30
Pneumatic connection	Barbed connector for tubing, nominal diameter 3 mm
Protection class	IP65

Operating and environmental conditions	
Ambient temperature	[°C] -15 ... +60
Corrosion resistance class CRC <sup>1)</sup>	1

1) Corrosion resistance class 1 according to Festo standard 940 070  
Components requiring low corrosion resistance. Transport and storage protection. Parts that do not have primarily decorative surface requirements, e.g. in internal areas that are not visible or behind covers.

Materials	
Housing	Polyamide
Barbed connector	Brass
Note on materials	Free of copper and PTFE

Product weights [g]	
PNP	14

# Proximity sensors SMPO-1, block design, pneumatic

Technical data

**Dimensions**

Download CAD data → [www.festo.com](http://www.festo.com)

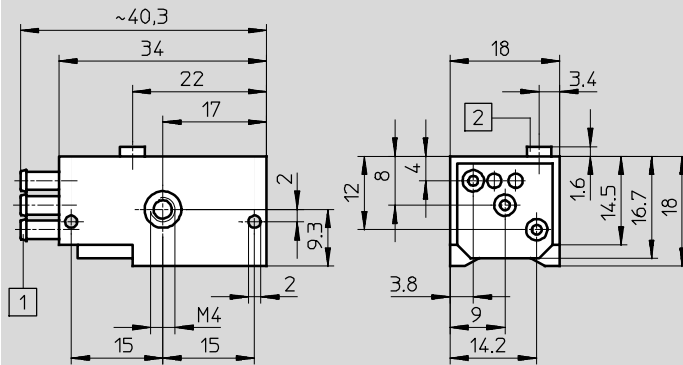

- 1 Barbed connector for tubing, nominal diameter 3 mm
- 2 Visual indicator

**Ordering data**

	Pneumatic connection	Part No.	Type
	3/2-way valve, normally closed		
	Barbed connector for 3 mm I.D. tubing	<b>31008</b>	<b>SMPO-1-H-B</b>

# Proximity sensors SMT-C1, block design, magneto-inductive

Technical data

Function

PNP, N/O contact, with cable

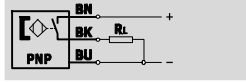

- Magneto-inductive measuring principle
- For standard cylinders DSBF-C or CDN-...-R with sensor strip

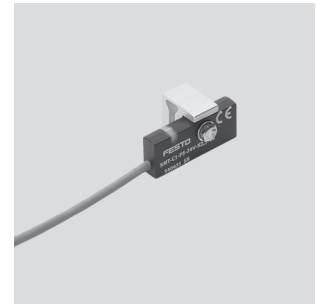

Function

PNP, N/O contact, with plug

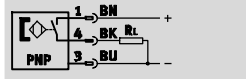

Technical data	
Design	Block design
Based on standard	EN 60947-5-2
Certification	C-Tick
Suitability for use in the food industry	As per manufacturer's declaration
CE mark (see declaration of conformity)	To EU EMC Directive <sup>1)</sup>
Note on materials	Cable free of halogen Free of copper and PTFE

1) For information about the applicability of the component see the manufacturer's EC declaration of conformity at: [www.festo.com](http://www.festo.com) → Support → User documentation.  
If the component is subject to restrictions on usage in residential, office or commercial environments or small businesses, further measures to reduce the emitted interference may be necessary.

Input signal/measuring element	
Measuring principle	Magneto-inductive
Ambient temperature [°C]	-20 ... +70

Switching output	
Switching output	PNP
Switching element function	N/O contact
Switch-on time [ms]	0 ... 0.5
Switch-off time [ms]	0 ... 0.5
Max. output current [mA]	200
Max. switching capacity DC [W]	6
Voltage drop [V]	0 ... 1.8

Output, additional data	
Protection against short circuit	Pulsed
Protection against overloading	Yes



# Proximity sensors SMT-C1, block design, magneto-inductive

Technical data

Electronic components		
Operating voltage range DC	[V]	10 ... 30
Residual ripple	[%]	10
Reverse polarity protection		For all electrical connections

Electromechanical components			
Type	SMT-C1-...-OE	SMT-C1-...-M8D	SMT-C1-...-M12
Electrical connection	Cable, 3-wire	Cable with plug M8x1, 3-pin, rotatable thread	Cable with plug M12x1, 3-pin
Connection direction	In-line		
Cable length	[m]	–	0.3
		5	–
		10	–
Cable sheath materials	TPE-O		
Wire ends	Wire end sleeve		

Mechanical components	
Type of mounting	Clamped
Tightening torque	[Nm] 1.2
Mounting position	Any
Housing materials	High-alloy stainless steel
	Wrought aluminium alloy
	Nickel-plated brass
	PP
	TPE-O
	TPE-U(PU)

Display/operation	
Switching status display	Yellow LED

Immissions/emissions	
Ambient temperature with flexible cable installation	[°C] –20 ... +70
Protection class	To IEC 60529
	IP65
	IP68

# Proximity sensors SMT-C1, block design, magneto-inductive

Technical data

Pin allocation to EN 60947-5-2				Pin allocation to EN 60947-5-2			
M8x1, 3-pin				M12x1, 3-pin			
N/O contact				N/O contact			
	Pin	Wire colour	Allocation		Pin	Wire colour	Allocation
	1	Brown	+		1	Brown	+
	3	Blue	-		3	Blue	-
	4	Black	Output		4	Black	Output

**Dimensions** Download CAD data → [www.festo.com](http://www.festo.com)

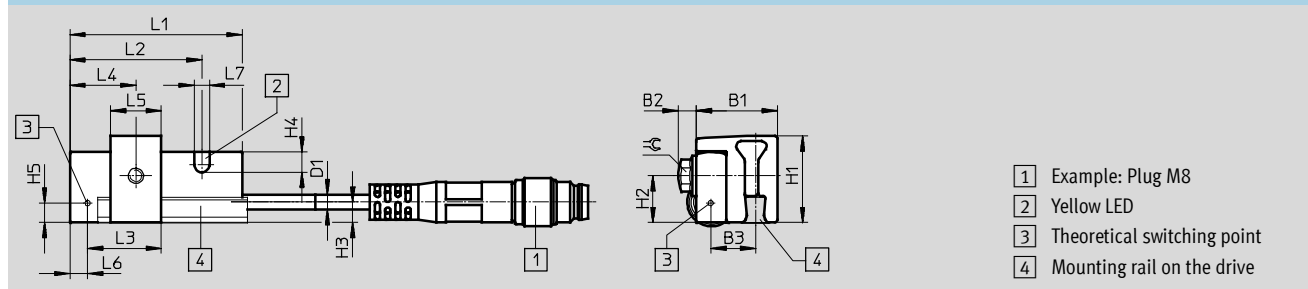

	B1	B2	B3	D1	H1	H2	H3	H4	H5	L1	L2	L3	L4	L5	L6	L7	⌀
SMT-C1	16	3.5	8.8	3	17	9.2	4	4	3.8	34	26	14.5	13	10	3.5	3	5.5

**Ordering data**

	Switching output	Electrical connection		Cable length [m]	Weight [g]	Part No.	Type	
		Cable	Cable with plug					
			M8x1, rotatable thread					M12x1
	N/O contact							
	PNP	3-wire	-	-	5	65.9	571339	SMT-C1-PS-24V-K-5,0-OE
			-	-	10	114.5	571340	SMT-C1-PS-24V-K-10,0-OE
		-	3-pin	-	0.3	24.4	571342	SMT-C1-PS-24V-K-0,3-M8D
-	-	3-pin	0.3	32.6	571341	SMT-C1-PS-24V-K-0,3-M12		

# Proximity sensors, block design

Accessories

## Mounting kit SMB-1

Material:  
Die-cast zinc

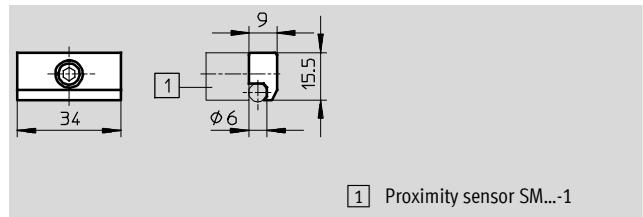

1 Proximity sensor SM...-1

Dimensions and ordering data		
For piston $\varnothing$	Part No.	Type
32 ... 100	11886	SMB-1

## Mounting kit SMB-2-B/SMB-3-B

Material:  
Die-cast aluminium

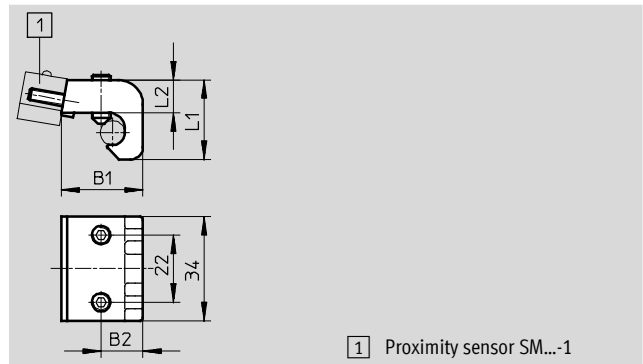

1 Proximity sensor SM...-1

Dimensions and ordering data						
For piston $\varnothing$	B1	B2	L1	L2	Part No.	Type
32 ... 50	18	11	23	11.6	36162	SMB-2-B
63 ... 100	26.8	13.7	26	10.8	36163	SMB-3-B

## Mounting kit SMBU

Material:  
Die-cast aluminium

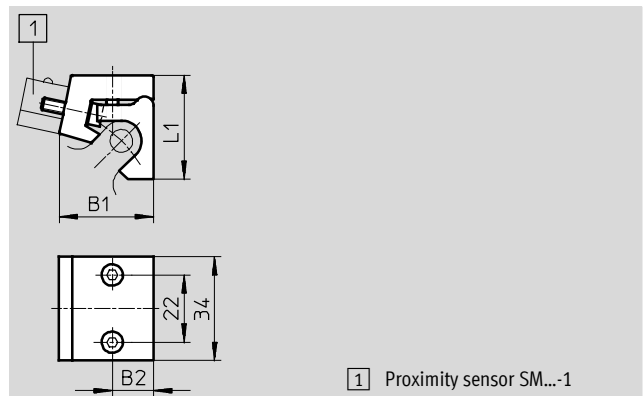

1 Proximity sensor SM...-1

Dimensions and ordering data					
For piston $\varnothing$	B1	B2	L1	Part No.	Type
32 ... 50	19	8.5	30	36173	SMBU-1-B <sup>1)</sup>
63 ... 100	31	13.5	34	36174	SMBU-2-B <sup>1)</sup>
125	31	13.5	37	125828	SMBU-3-B

1) Free of copper and PTFE

# Proximity sensors, block design

Accessories

## Mounting kit SMBU-1-H-32

Material:  
Aluminium

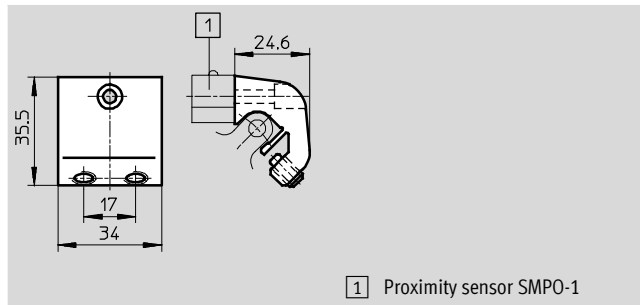
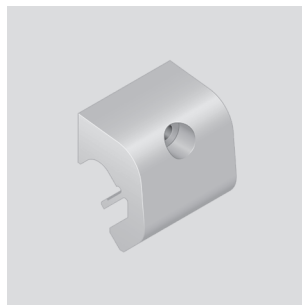

1 Proximity sensor SMPO-1

Dimensions and ordering data		
For piston Ø	Part No.	Type
32	150216	SMBU-1-H-32

## Mounting kit SMBS

Material:  
Brass, plastic

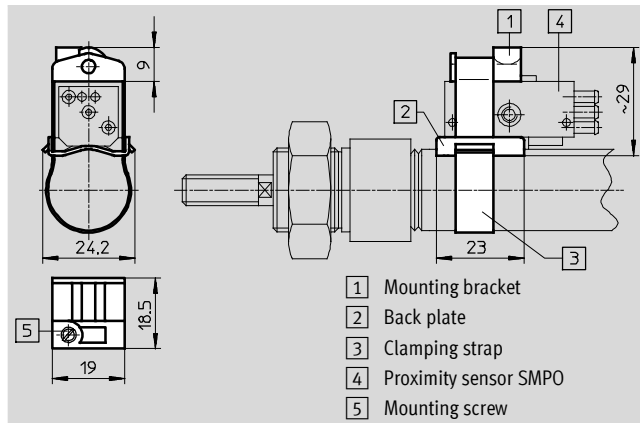

1 Mounting bracket  
2 Back plate  
3 Clamping strap  
4 Proximity sensor SMPO  
5 Mounting screw

Dimensions and ordering data		
For piston Ø	Part No.	Type
8 ... 25	151225	SMBS-1
32 ... 100	151226	SMBS-2

## Mounting kit SMBT-1

Material:  
Die-cast zinc

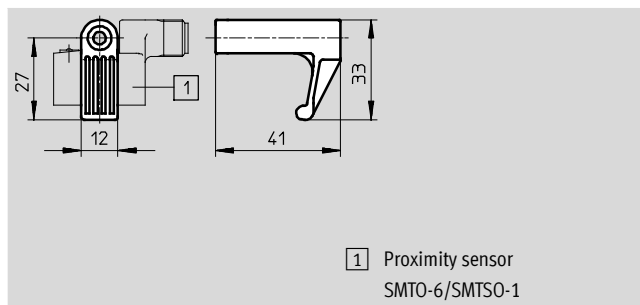
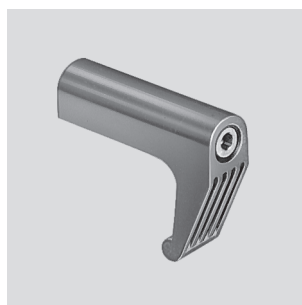





1 Proximity sensor SMT0-6/SMTSO-1

Dimensions and ordering data		
For piston Ø	Part No.	Type
32 ... 200	150002	SMBT-1

# Proximity sensors, block design

Accessories

Ordering data – Connecting cables			Technical data → Internet: nebu		
		Number of wires	Cable length [m]	Part No.	Type
<b>Socket M8x1, 3-pin</b>					
	For SMT-C1 and SMT0/SME0-1	3	2.5	541333	NEBU-M8G3-K-2.5-LE3
			5	541334	NEBU-M8G3-K-5-LE3
	For SMT-C1 and SMT0/SME0-1	3	2.5	541338	NEBU-M8W3-K-2.5-LE3
			5	541341	NEBU-M8W3-K-5-LE3
<b>Socket M12x1, 5-pin</b>					
	For SMT-C1 and SMT0-6, SMTSO-1	3	2.5	541363	NEBU-M12G5-K-2.5-LE3
			5	541364	NEBU-M12G5-K-5-LE3
	For SMT-C1 and SMT0-6, SMTSO-1	3	2.5	541367	NEBU-M12W5-K-2.5-LE3
			5	541370	NEBU-M12W5-K-5-LE3