

Mini slides EGSL, electric



# Mini slides EGSL, electric

Key features

## At a glance

- Electric slide series
- Maximum performance in compact space:
  - Precision
  - Load capacity
  - Dynamic response
- Choice of homing:
  - To fixed stop
  - To reference switch
- Perfect for vertical applications
- System product for handling and assembly technology
- Wide range of options for mounting on drives

## Motor mounting variants

Axial

Parallel

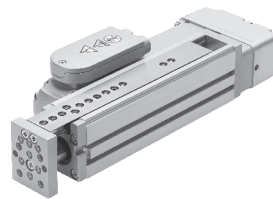
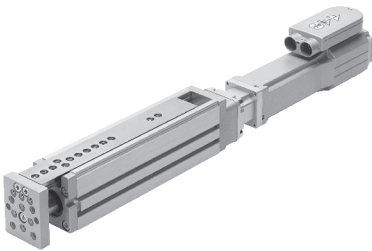

## Characteristic values of the axes

The specifications shown in the table are maximum values.

The precise values for each of the variants can be found in the relevant technical data.

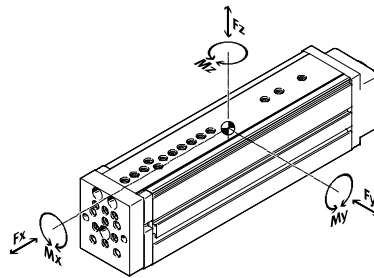

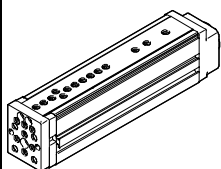
Version	Size	Working stroke [mm]	Speed [m/s]	Max. acceleration [m/s <sup>2</sup> ]	Repetition accuracy [mm]	Feed force Fx [N]	Guide characteristics				
							Forces and torques				
							Fy [N]	Fz [N]	Mx [Nm]	My [Nm]	Mz [Nm]
	35	50	0.5	25	±0.015	75	512	512	6.2	6.0	6.0
	45	100, 200	1.0	25	±0.015	150	631	631	18.6	16.3	16.3
	55	100, 200, 250	1.0	25	±0.015	300	1,047	1,047	33.1	33.3	33.3
	75	100, 200, 300	1.3	25	±0.015	450	1,539	1,539	67.4	47.1	47.1

 Note

PositioningDrives  
sizing software  
[www.festo.com](http://www.festo.com)

# Mini slides EGSL, electric

Key features

Complete system comprising mini slide, motor, motor controller and motor mounting kit

Mini slide

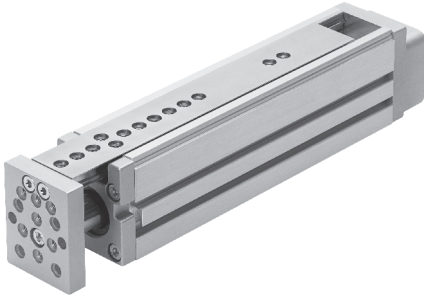

## Motor

→ 22

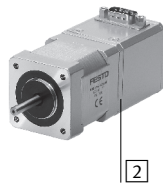
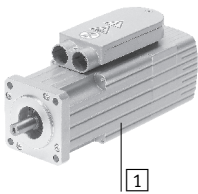

- 1 Servo motor EMMS-AS
- 2 Stepper motor EMMS-ST

 Note  
A range of specially adapted complete solutions is available for the mini slide EGSL and the motors.

## Motor controller

Technical data → Internet: motor controller



- 1 Servo motor controller CMMP-AS, CMMS-AS
- 2 Stepper motor controller EMMS-ST

## Motor mounting kit

→ 22

Axial kit

Parallel kit



There are complete kits for both parallel and axial motor mounting.

# Mini slides EGSL, electric

Key features and type codes

System product for handling and assembly technology

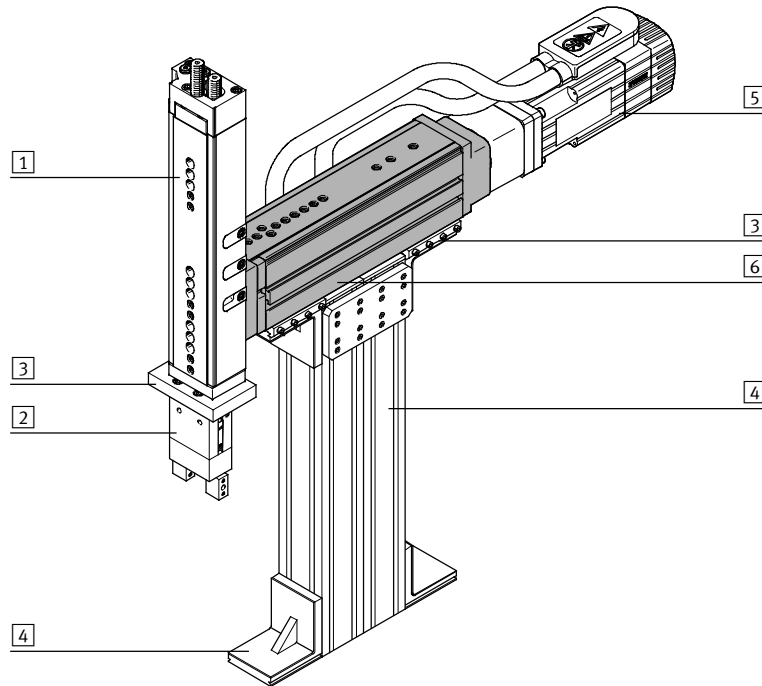

System components and accessories		
	Brief description	→ Page/Internet
1	Drives	Wide range of combinations possible within handling and assembly technology drive
2	Grippers	Wide range of variations possible within handling and assembly technology gripper
3	Adapters	For drive/drive and drive/gripper connections adapter kit
4	Basic components	Profiles and profile connections as well as profile/drive connections basic component
5	Motors	Servo and stepper motors, with or without gearing motor
6	Axes	Wide range of combinations possible within handling and assembly technology axis
-	Installation components	For a clear, safe layout of electrical cables and tubing installation component

## Type codes

	EGSL	-	BS	-	45	-	200	-	10P
<b>Type</b>									
EGSL	Mini slide								
<b>Drive function</b>									
BS	Ball screw spindle								
<b>Size</b>									
<b>Stroke [mm]</b>									
<b>Spindle pitch [mm]</b>									

# Mini slides EGSL, electric

Peripherals overview

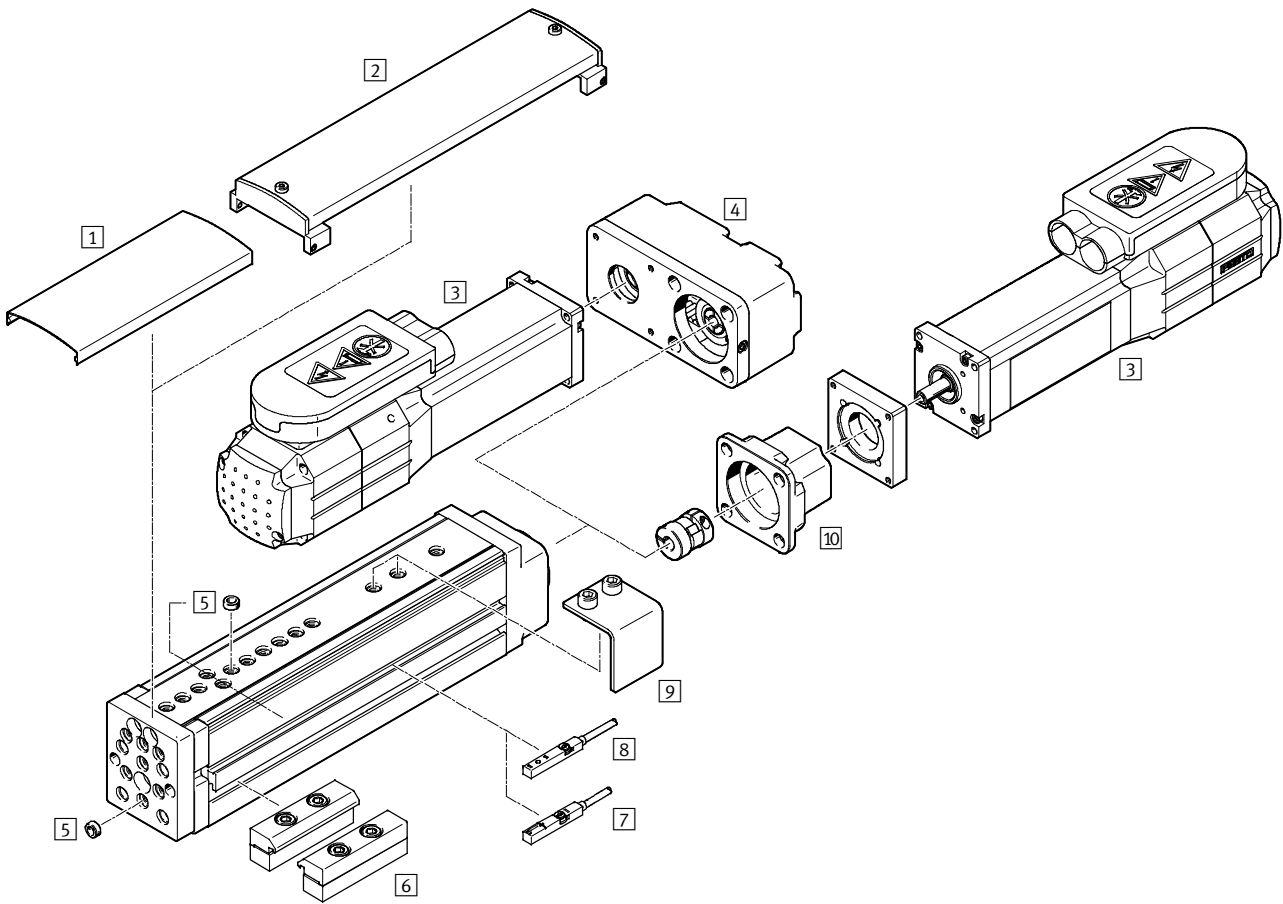

Variants and accessories		
Type	Brief description	→ Page/Internet
1 Cover EASC-...	<ul style="list-style-type: none"> <li>For protection, so that no foreign parts can get into the guide</li> <li>The cover can be shortened by the customer as required</li> </ul>	26
2 Cover EASC-...-F	<ul style="list-style-type: none"> <li>This cover must be used in combination with the switching lug EAPM</li> <li>For protection, so that no foreign parts can get into the guide</li> </ul>	26
3 Motor EMMS	Motors specially matched to the axis, with or without brake	22
4 Parallel kit EAMM-U	<ul style="list-style-type: none"> <li>For parallel motor mounting</li> <li>The motor can only be mounted at the side and underneath</li> <li>(comprising: housing, clamping sleeve, toothed belt pulley, toothed belt)</li> </ul>	23
5 Centring sleeve ZBH	<ul style="list-style-type: none"> <li>For centring loads and attachments</li> <li>Makes lateral mounting on the slide much easier</li> </ul>	27
6 Profile mounting EAHF, MUE	For mounting the axis	25
7 Proximity sensor SIES	Inductive proximity sensor, for slot type 8	27
8 Proximity sensor SMT-8-...-B	Magnetic proximity sensor, for slot type 8	27
9 Switching lug EAPM	For sensing the slide position via proximity sensors SIES	25
10 Axial kit EAMM-A	For axial motor mounting (comprising: coupling, coupling housing and motor flange)	22
- Connecting cable NEBU	For proximity sensor SIES or SMT-8-...-B	27

# Mini slides EGSL, electric

Technical data

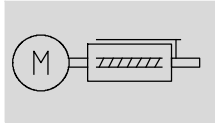

Function

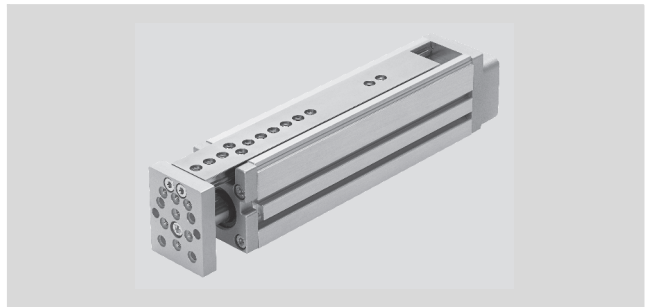

 Note

All values are based on a room temperature of 20 °C.



-  Size  
35, 45, 55, 75
-  Stroke length  
50 ... 300 mm

General technical data								
Size	35		45		55		75	
Spindle pitch [mm]	8	3	10	5	12.7	10	20	
Design	Electric mini slide							
	With recirculating ball spindle							
	With guide							
Guide	Ball bearing cage guide							
Type of mounting	Via female thread							
	Via centring sleeve							
	Via accessories							
Mounting position	Any							
Working stroke [mm]	50	100, 200		100, 200, 250		100, 200, 300		
Max. permissible applied load, horizontal [kg]	2	6		10		14		
Max. permissible applied load, vertical [kg]	2	6		10		14		
Continuous feed force $F_x$ [N]	50	100		200		300		
Max. feed force $F_x$ [N]	75	150		300		450		
Max. no-load driving torque [Nm]	0.015	0.055	0.050	0.100	0.135	0.265	0.165	
Max. driving torque <sup>1)</sup> [Nm]	0.2	0.45	0.51	0.9	1.25	3.25	3.25	
Max. radial force <sup>2)</sup> [N]	20	120		260		300		
Max. speed [m/s]	0.5	0.3	1.0	0.4	1.0	0.65	1.3	
Nominal acceleration [m/s <sup>2</sup> ]	15							
Max. acceleration <sup>3)</sup> [m/s <sup>2</sup> ]	25							
Repetition accuracy [mm]	±0.015							
Max. reversing backlash <sup>4)</sup> [µm]	≤50							

- 1) Friction and acceleration torque of the rotating load taken into consideration
- 2) At the drive shaft
- 3) The max. acceleration is dependent on the moving load, the driving torque and the max. feed force
- 4) In new condition

Operating and environmental conditions								
Size	35		45		55		75	
Ambient temperature [°C]	0 ... +60							
Protection class	IP40							
Duty cycle [%]	100							
Noise level [dB (A)]	60				65			
Maintenance interval	Maintenance-free							

# Mini slides EGSL, electric

Technical data

FESTO

Weight [kg]			
Size	35		45
Stroke [mm]	50	100	200
Product weight	0.6	1.6	2.2
Moving load	0.3	0.7	0.9
Dead weight of guide rail and yoke plate	0.13	0.4	0.58

Size	55			75		
Stroke [mm]	100	200	250	100	200	300
Product weight	2.6	3.4	4.1	5.1	6.5	8.1
Moving load	1.2	1.5	1.8	2.3	2.9	3.4
Dead weight of guide rail and yoke plate	0.61	0.87	1.07	1.2	1.64	2.07

Mass moment of inertia – for sizing the motor								
Size	35				45			
Spindle pitch [mm]	8				3		10	
Stroke [mm]	50				100	200	100	200
$J_0$ [kg mm <sup>2</sup> ]	4.26				4.59	5.14	6.14	7.31
$J_L$ per kg effective load [kg mm <sup>2</sup> /kg]	1.62				0.23	0.23	2.53	2.53

Size	55						75					
Spindle pitch [mm]	5			12.7			10			20		
Stroke [mm]	100	200	250	100	200	250	100	200	300	100	200	300
$J_0$ [kg mm <sup>2</sup> ]	13.52	14.77	15.74	18.27	21.13	23.27	86.95	96.49	106.67	105.12	119.45	134.59
$J_L$ per kg effective load [kg mm <sup>2</sup> /kg]	0.63	0.63	0.63	4.09	4.09	4.09	2.53	2.53	2.53	10.13	10.13	10.13

The mass moment of inertia  $J_A$  of the entire axis is calculated as follows:  
 $J_A = J_0 + J_L \times m_{\text{effective load}}$  [kg]

The inertia of the motor mounting kit and motor is not taken into consideration here.

## Materials

Sectional view

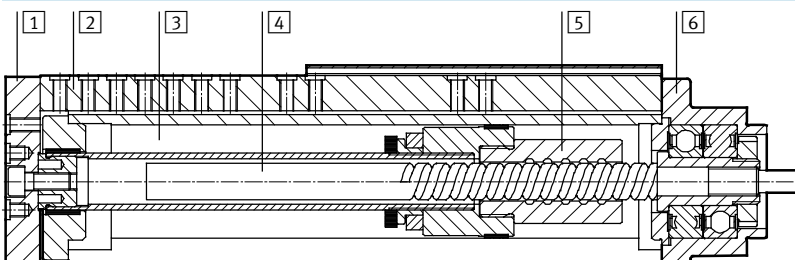

Axis	
1	Yoke plate Anodised wrought aluminium alloy
2	Guide rail Rolled steel
3	Housing Anodised wrought aluminium alloy
4	Spindle Rolled steel
5	Spindle nut Rolled steel
6	End cap Painted aluminium
Note on materials	
RoHS-compliant	
Contains PWIS (paint-wetting impairment substances)	

# Mini slides EGSL, electric

Technical data

## Possible combinations

Via guide

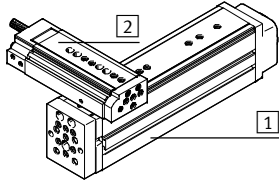

Direct mounting

		1 Basic drive							
		EGSL-35		EGSL-45		EGSL-55		EGSL-75	
2 Assembly drive	EGSL-35	1088327	HMSV-73	1088338	HMSV-74	1088338	HMSV-74	-	
	EGSL-45	-		1088338	HMSV-74	1088338	HMSV-74	1089092	HMSV-75
	EGSL-55	-		-		1088338	HMSV-74	1089092	HMSV-75
	EGSL-75	-		-		-		1089092	HMSV-75
	DGSL-4	1088327	HMSV-73	-		-		-	
	DGSL-6	1088327	HMSV-73	-		-		-	
	DGSL-8	1088327	HMSV-73	ZBV-M5-7		ZBV-M5-7		-	
	DGSL-10	1088327	HMSV-73	ZBV-M5-7		ZBV-M5-7		-	
	DGSL-12	-		M5x14 ZBH-7		M5x16 ZBH-7		ZBV-M6-9	
	DGSL-16	-		M5x14 ZBH-7		M5x16 ZBH-7		ZBV-M6-9	
DGSL-20	-		-		-		M6x20 ZBH-9		

Via yoke plate

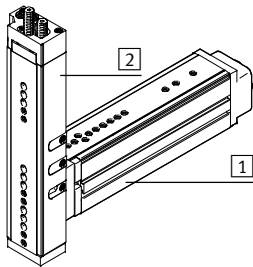

Direct mounting

		1 Basic drive							
		EGSL-35		EGSL-45		EGSL-55		EGSL-75	
2 Assembly drive	EGSL-35	M4x12 ZBH-7		1088295	HMSV-71	1088295	HMSV-71	-	
	EGSL-45	-		M5x12 ZBH-7	M5x14 ZBH-7		1088311 HMSV-72		
	EGSL-55	-		-		M5x14 ZBH-7	1088311 HMSV-72		
	EGSL-75	-		-		-		M6x18 ZBH-9	
	DGSL-4	1088262	HMSV-70	-		-		-	
	DGSL-6	1088262	HMSV-70	-		-		-	
	DGSL-8	1088262	HMSV-70	ZBV-M5-7		ZBV-M5-7		-	
	DGSL-10	1088262	HMSV-70	ZBV-M5-7		ZBV-M5-7		-	
	DGSL-12	-		M5x14 ZBH-7		M5x12 ZBH-7		ZBV-M6-9	
	DGSL-16	-		M5x14 ZBH-7		M5x12 ZBH-7		ZBV-M6-9	
DGSL-20	-		-		-		M6x20 ZBH-9		

 - Note

Ordering data for centring sleeves  
ZBH and connecting sleeves ZBV  
→ 27.



# Mini slides EGSL, electric

Technical data

## Parallelism [mm]

The term parallelism refers to the accuracy of alignment between the mounting surface and the slide surface.

Specifications apply in retracted state.

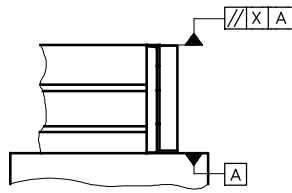

Size	Stroke [mm]	35	45	55	75
Parallelism X	50	0.03	–	–	–
	100	–	0.05	0.05	0.05
	200	–	0.1	0.1	0.1
	250	–	–	0.125	–
	300	–	–	–	0.15

## Linearity [mm]

Linearity refers to the max. difference between normal position and the reference plane experienced at any point of the moving axis components when traversing the entire stroke.

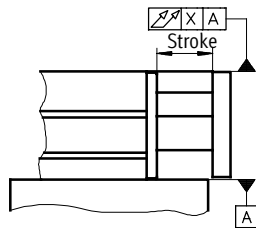

Size	Stroke [mm]	35	45	55	75
Linearity X	50	0.02	–	–	–
	100	–	0.04	0.04	0.04
	200	–	0.08	0.08	0.08
	250	–	–	0.10	–
	300	–	–	–	0.12

# Mini slides EGSL, electric

Technical data

## Dynamic characteristic load values

The indicated forces and torques refer to the centre of the guide.  
These values must not be exceeded during dynamic operation.

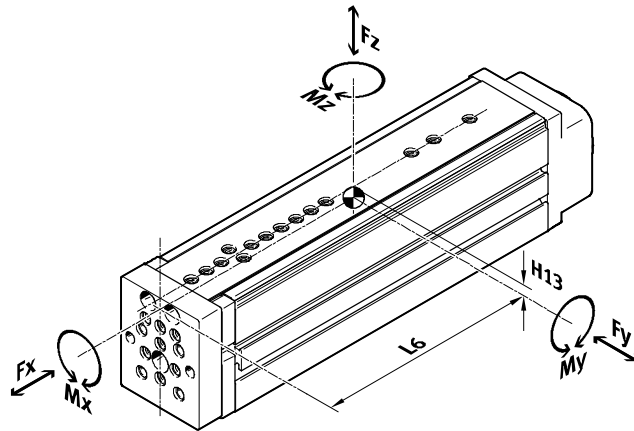

If the axis is subjected to more than two of the indicated forces and torques simultaneously, the following equation (guide comparison index  $f_v$ ) must be satisfied in addition to the indicated maximum loads:

$$f_v = \frac{|F_{y,dyn}|}{F_{y,max.}} + \frac{|F_{z,dyn}|}{F_{z,max.}} + \frac{|M_{x,dyn}|}{M_{x,max.}} + \frac{|M_{y,dyn}|}{M_{y,max.}} + \frac{|M_{z,dyn}|}{M_{z,max.}}$$

Permissible forces and torques						Geometric characteristics	
Size	Stroke [mm]	$F_{y,max}$ [N]	$F_{z,max}$ [N]	$M_{x,max}$ [Nm]	$M_{y,max}, M_{z,max}$ [Nm]	H13 [mm]	L6 [mm]
<b>35</b>							
	50	512	512	6.2	6.0	4.2	106
<b>45</b>							
	100	631	631	18.6	16.3	6.4	162
	200	291	291	14.3	12.3	6.4	262
<b>55</b>							
	100	1,047	1,047	33.1	31.0	6.4	180
	200	490	490	24.2	22.6	6.4	280
	250	563	563	27.0	33.3	6.4	344
<b>75</b>							
	100	1,539	1,539	67.4	47.1	7.6	187
	200	714	714	48.5	33.8	7.6	287
	300	555	555	46.4	36.5	7.6	389

 **Note**

PositioningDrives  
sizing software  
[www.festo.com](http://www.festo.com)

# Mini slides EGSL, electric

Technical data

## Position of the guide centre

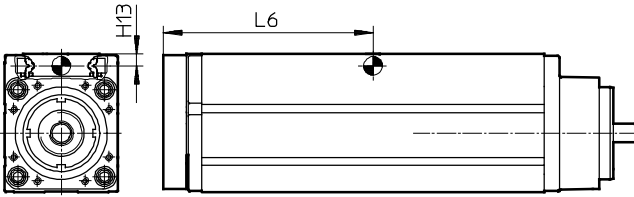

## Calculation example

Given:

Type: EGSL-BS-45-100-10P  
 Stroke length = 100 mm  
 Lever arm  $L_x$  = 30 mm  
 Lever arm  $L_y$  = 10 mm  
 Mass  $F_z$  = 5 kg  
 Acceleration  $a$  = 0 m/s<sup>2</sup>  
 Mounting position: Horizontal

To be calculated:

- $F_y, F_z, M_x, M_y, M_z$
- Verification of operation with combined load
- Service life estimate

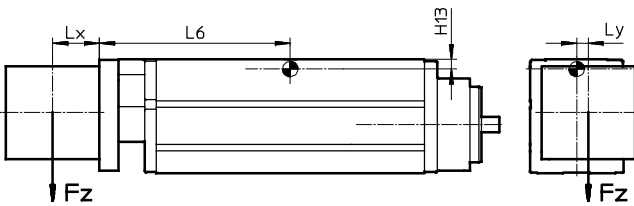

## Solution:

$$L6 = 0.162 \text{ m from table}$$

$$F_y = 0 \text{ N}$$

$$F_z = m \times g \\ = 5 \text{ kg} \times 9.81 \text{ m/s}^2 = 49.05 \text{ N}$$

$$M_x = F_z \times L_y \\ = 49.05 \text{ N} \times 0.01 \text{ m} = 0.4905 \text{ Nm}$$

$$M_y = F_z \times (L6 + L_x) \\ = 49.05 \text{ N} \times (0.162 \text{ m} + 0.03 \text{ m}) = 9.42 \text{ Nm}$$

$$M_z = 0 \text{ Nm}$$

Combined load:

$$\frac{|F_y|}{F_{y_{\max}}} + \frac{|F_z|}{F_{z_{\max}}} + \frac{|M_x|}{M_{x_{\max}}} + \frac{|M_y|}{M_{y_{\max}}} + \frac{|M_z|}{M_{z_{\max}}} \\ = 0 + \frac{49.05 \text{ N}}{631 \text{ N}} + \frac{0.49 \text{ Nm}}{18.6 \text{ Nm}} + \frac{9.42 \text{ Nm}}{16.3 \text{ Nm}} + 0 = 0.68$$

The diagram on page 12 shows a service life of approx. 30 million cycles when  $f_v = 0.68$ .

## Mini slides EGSL, electric

Technical data

### Calculating service life

The service life of the guide depends on the load. To provide a rough indication of the service life of the guide, the graph below plots the load comparison factor  $f_v$  against the service life.

The spindle module even exceeds the guide's high load capacity and service life. The load characteristics of the spindle therefore need not be considered for the service life calculation.

These values are only theoretical. Consultation with your local contact person at Festo is mandatory for load comparison factors  $f_v$  greater than 1.5.

### Load comparison factor $f_v$ as a function of service life

Example:

A user wants to move an X kg load. Using the formula  $\rightarrow 10$  gives a value of 1.5 for the load comparison factor  $f_v$ . According to the graph, the guide would have a service life of

approx. 3 million cycles. Reducing the acceleration reduces the Mz and My values. A load comparison factor  $f_v$  of 1 now gives a service life of 10 million cycles.

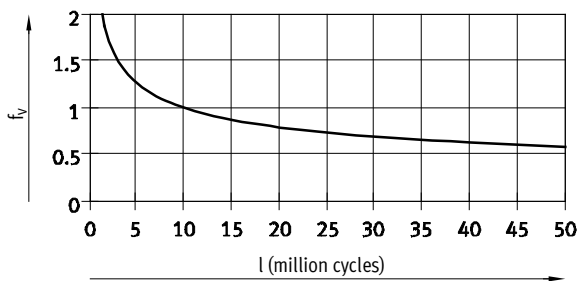

# Mini slides EGSL, electric

Technical data

## Rotational speed $n$ as a function of feed speed $v$

EGSL-35

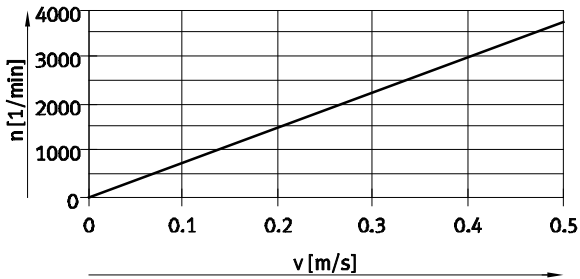

EGSL-BS-35- ... -8P

EGSL-45

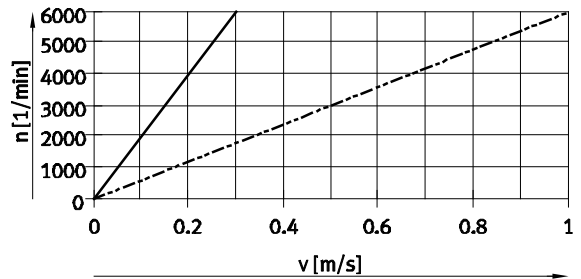

EGSL-BS-45- ... -3P  
EGSL-BS-45- ... -10P

EGSL-55

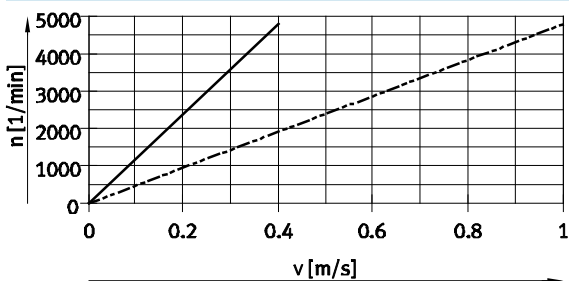

EGSL-BS-55- ... -5P  
EGSL-BS-55- ... -12.7P

EGSL-75

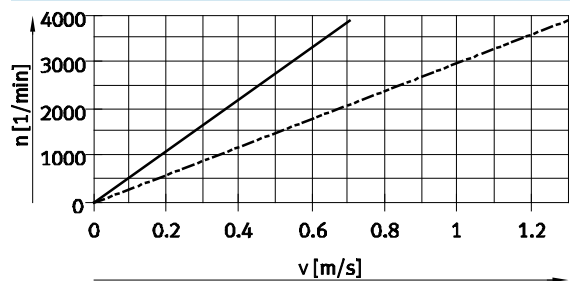

EGSL-BS-75- ... -10P  
EGSL-BS-75- ... -20P

## Driving torque $M$ as a function of feed force $F$

EGSL-35

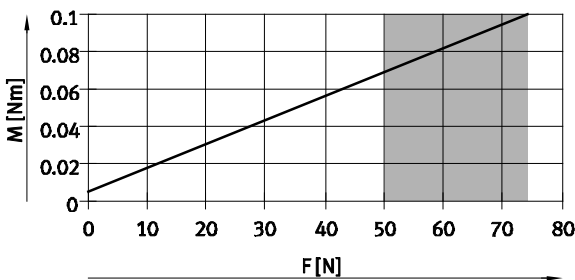

EGSL-BS-35- ... -8P

EGSL-45

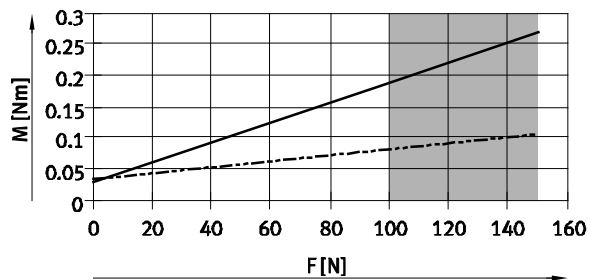

EGSL-BS-45- ... -10P  
EGSL-BS-45- ... -3P

EGSL-55

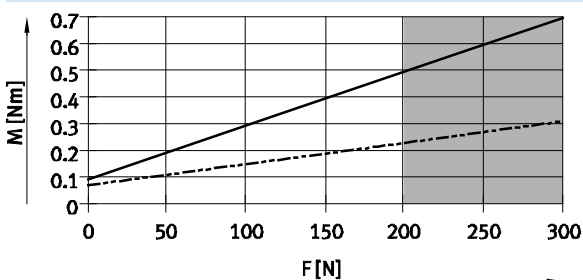

EGSL-BS-55- ... -12.7P  
EGSL-BS-55- ... -5P

EGSL-75

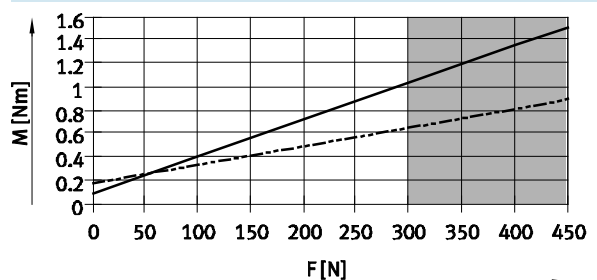

EGSL-BS-75- ... -20P  
EGSL-BS-75- ... -10P

 This range should be used only briefly.

# Mini slides EGSL, electric

Technical data

## Deflection x as a function of force Fz and stroke l

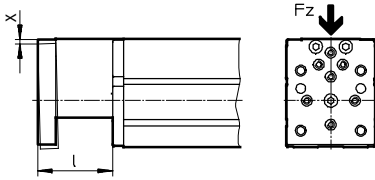

### EGSL-35

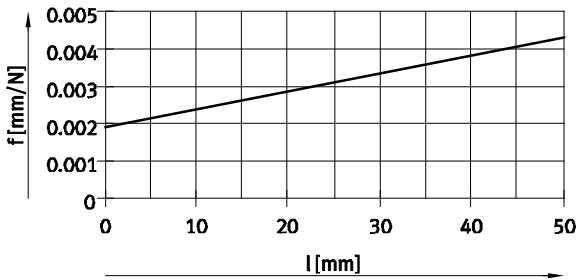

EGSL-BS-35-50

### EGSL-45

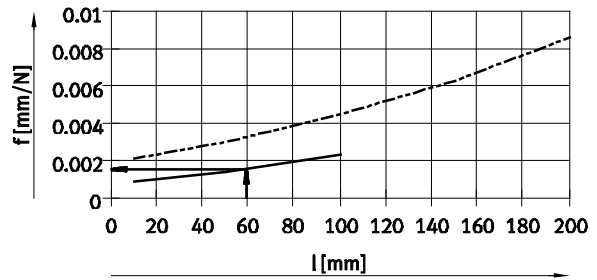

EGSL-BS-45-100  
EGSL-BS-45-200

### EGSL-55

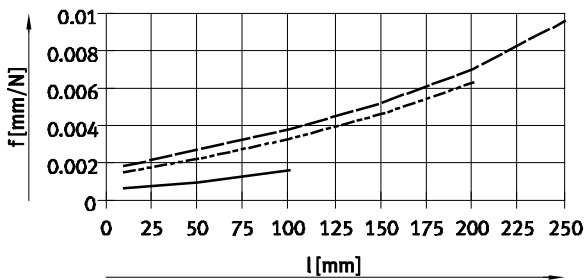

EGSL-BS-55-100  
EGSL-BS-55-200  
EGSL-BS-55-250

### EGSL-75

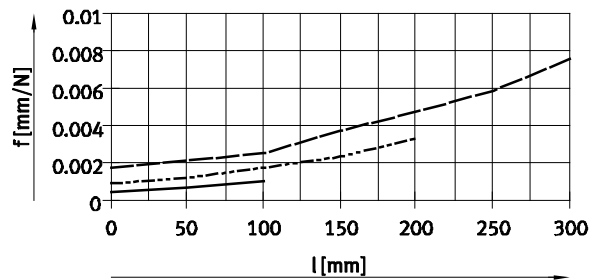

EGSL-BS-75-100  
EGSL-BS-75-200  
EGSL-BS-75-300

## Calculation example

Given:

EGSL-BS-45-100

l = 60 mm

Fz = 30 N

Mounting position:

Horizontal

Result:

The graph shows a resilience of  $f = 0.0015 \text{ mm/N}$  with a stroke of 60 mm.

$$x = f \times F_z$$

$$x = 0.0015 \text{ mm/N} \times 30 \text{ N}$$

$$x = 0.045 \text{ mm}$$

# Mini slides EGSL, electric

Technical data

## Deflection $x$ as a function of force $F_y$ and stroke $l$

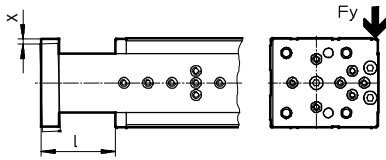

### EGSL-35

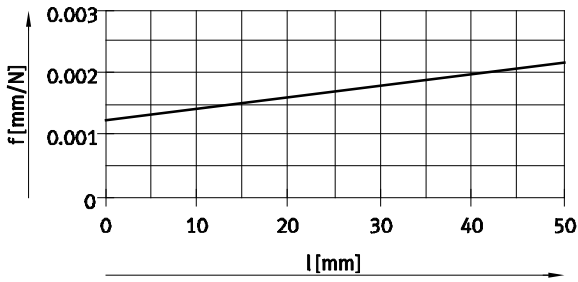

EGSL-BS-35-50

### EGSL-45

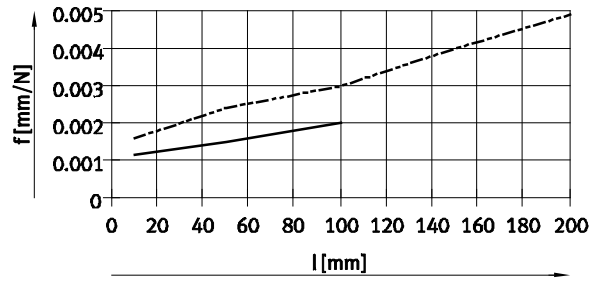

EGSL-BS-45-100

EGSL-BS-45-200

### EGSL-55

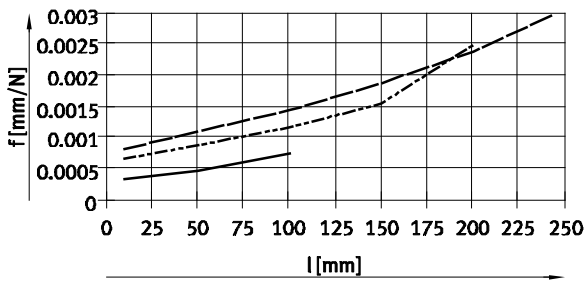

EGSL-BS-55-100

EGSL-BS-55-200

EGSL-BS-55-250

### EGSL-75

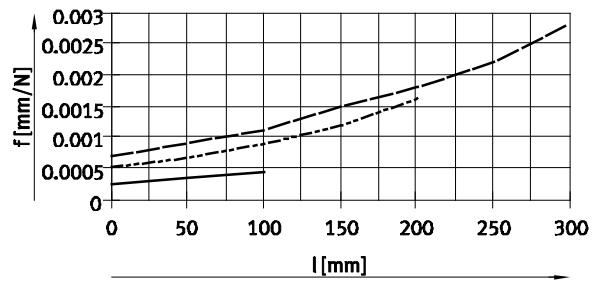

EGSL-BS-75-100

EGSL-BS-75-200

EGSL-BS-75-300

# Mini slides EGSL, electric

Technical data

**Dimensions**

Download CAD data → [www.festo.com](http://www.festo.com)

**Size 35**

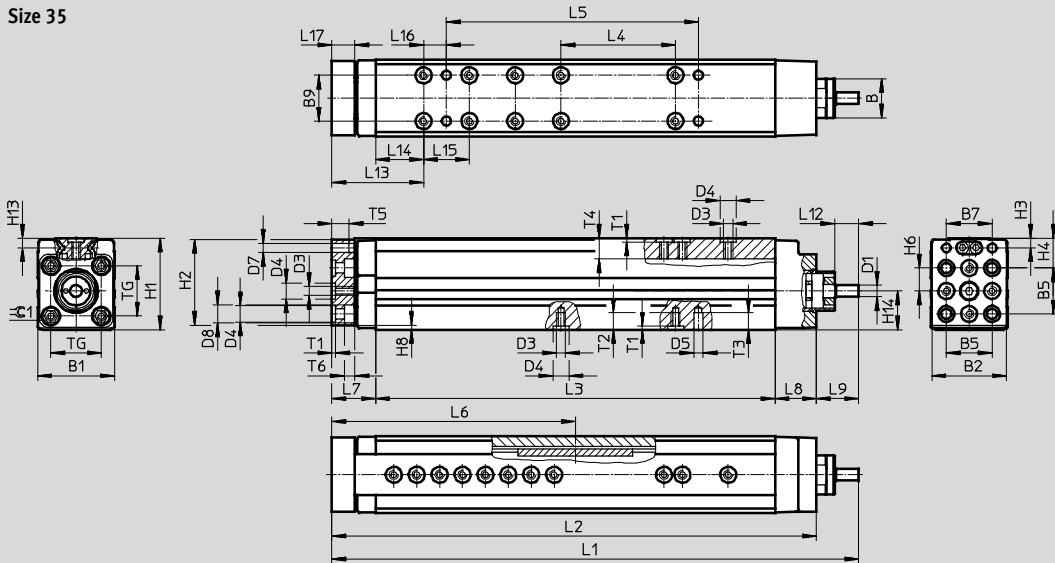

**Size 45/55/75**

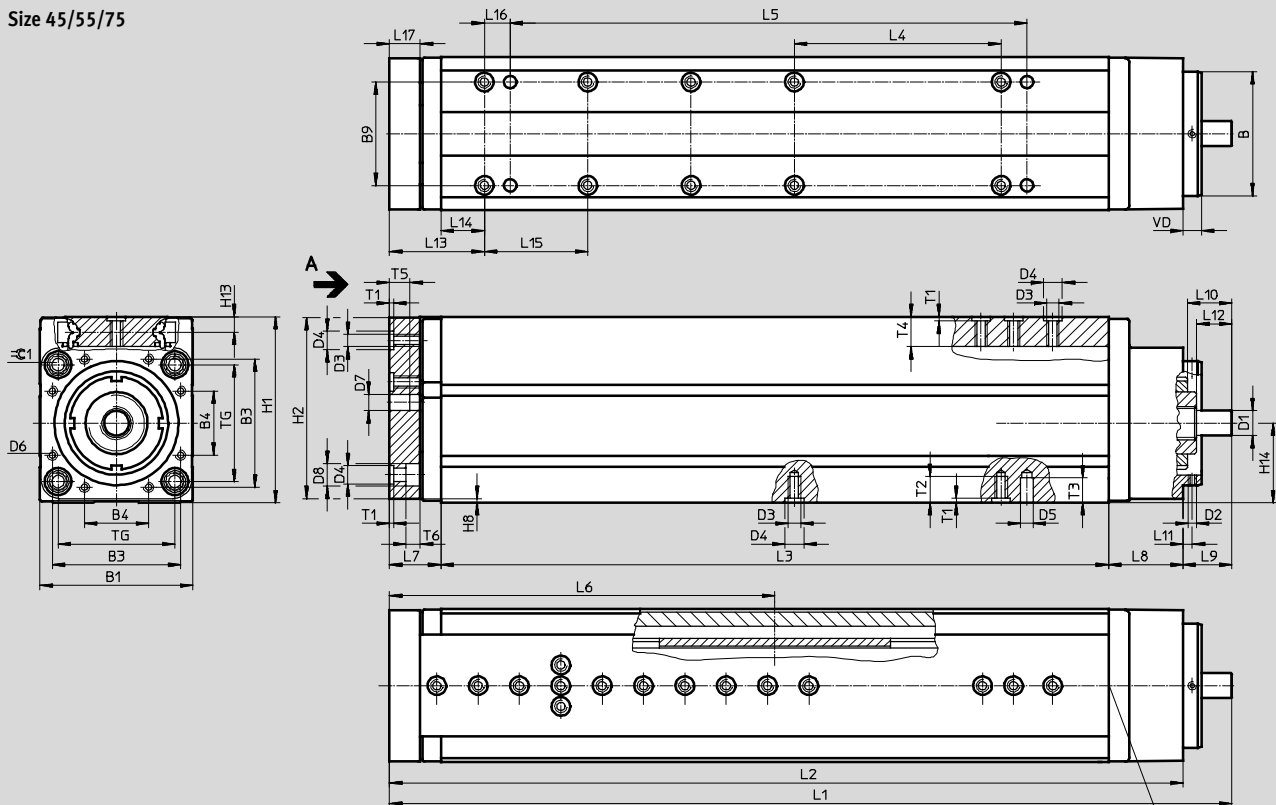

**View A**  
**Size 45**

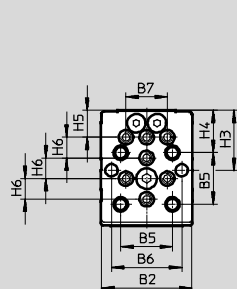

**Size 55**

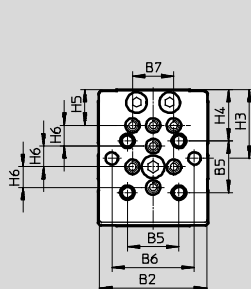

**Size 75**

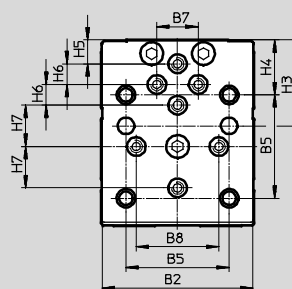

**1** Rubber buffers are integrated in the slide and can be removed for homing to the fixed stop.



# Mini slides EGSL, electric

Technical data

Size	B ∅ g7	B1	B2	B3	B4	B5	B6	B7	B8	B9 ±0.5
35	19	33.5	33	–	–	20	–	20	–	20
45	32	44.5	43.5	32	19	25	34	20	–	25
55	40	53	52	42	20	25	40	20	–	25
75	60	74	73	62	31	50	–	20	40	50

Size	D1 ∅	D2	D3	D4 ∅ H7	D5 ∅ H7	D6	D7 ∅	D8 ∅	H1	H2
35	5	–	M4	7	4	–	4	8	40	37.5
45	6	M3	M5	7	6	M3	6	10	56	43.5
55	8	M3	M5	7	6	M4	6	10	66	63.5
75	12	M4	M6	9	6	M5	8	11	90	87.5

Size	H3	H4	H5	H6	H7	H8	H13	H14	L7	
									2) ±1	3) ±1
35	4.2	13	–	10	–	2	4.2	17+0.09/–0.07	21	19
45	29	20.5	13	10	–	2	6.4	23±0.08	22	20
55	33.3	24.8	17.3	10	–	2	6.4	28.7±0.08	27	25
75	41.5	26.5	11.5	10	20	2	7.6	38.5±0.08	27	25

Size	L8	L9 ±1	L10	L11	L12 ±0.2	L13		L14 <sup>1)</sup>	L15 <sup>1)</sup>	L16 ±0.1
						2)	3)			
35	18	18.5	–	–	10.5	42	40	21	20	10
45	26	16	16.9	3.5	8	43	41	21	25	12.5
55	30	18.5	14.9	3.5	14	48	46	21	25	12.5
75	36	23.6	21.5	4.5	17	48	46	21	50	12.5

Size	L17	T1 ±0.1	T2	T3	T4	T5	T6	TG	VD	⊙ 1
35	10	1.6	7.6	7.5	9	7.5	4.6	22	–	5
45	10	1.6	8.1	7.5	12.4	7.5	5.7	32.5	7	6
55	15	1.6	8.6	8.5	12.4	10	8.7	38	7	6
75	15	2.1	12.6	12	14.5	10	6.8	56.5	9	8

Size	Stroke [mm]	L1		L2		L3 –0.2	L4 <sup>1)</sup>	L5 <sup>1)</sup> ±0.05	L6	
		2) ±1.5	3) ±1.5	2) ±1	3) ±1				2)	3)
35	50	182	180	163.5	161.5	124.5	–	60	83	81
45	100	248	246	232	230	184	75	125	114	112
	200	348	346	332	330	284	100	175	164	162
55	100	284.5	282.5	266	264	209	100	150	132	130
	200	384.5	382.5	366	364	309	100	175	182	180
	250	463.5	461.5	445	443	388	100	175	221	219
75	100	309.6	307.6	286	284	223	–	150	139	137
	200	409.6	407.6	386	384	323	100	250	189	187
	300	514.6	512.6	491	489	428	150	350	241	239

1) Tolerance for centring hole ±0.02 mm  
Tolerance for thread ±0.1 mm

2) With rubber buffer

3) Without rubber buffer: for homing to the fixed stop

# Mini slides EGSL, electric

Technical data

## Hole pattern for mounting threads and centring holes

EGSL-35-50

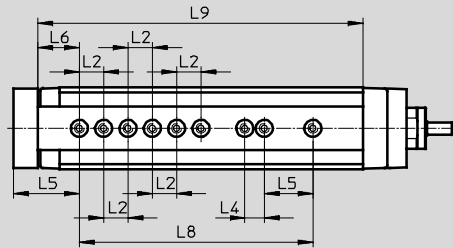

EGSL-45-100

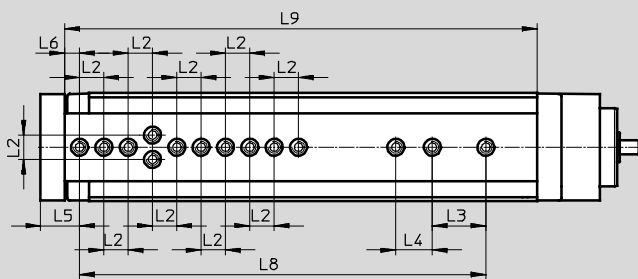

EGSL-45-200

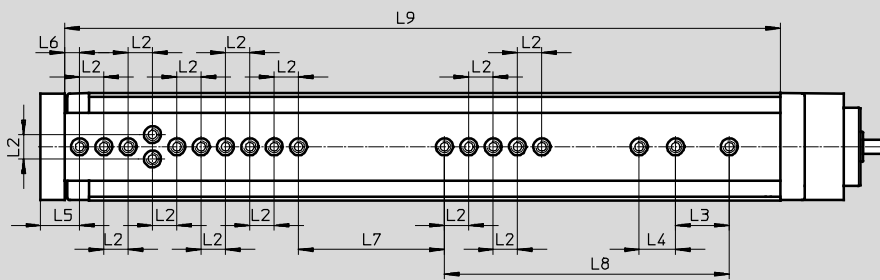

Size	Stroke [mm]	L2 <sup>1)</sup>	L3 <sup>1)</sup>	L4 <sup>1)</sup>	L5	L6	L7 <sup>1)</sup>	L8 <sup>1)</sup>	L9
35	50	10	20	8	27	17	-	96	133.5
45	100	10	22	15	16	6	-	167	194
	200						60	117	294

1) Tolerance for centring hole  $\pm 0.02$  mm  
Tolerance for thread  $\pm 0.1$  mm

# Mini slides EGSL, electric

Technical data

## Hole pattern for mounting threads and centring holes

EGSL-55-100

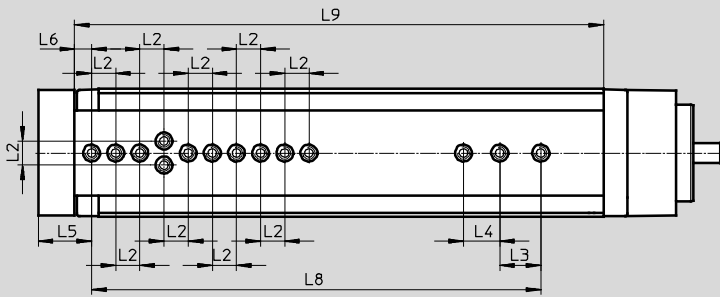

EGSL-55-200

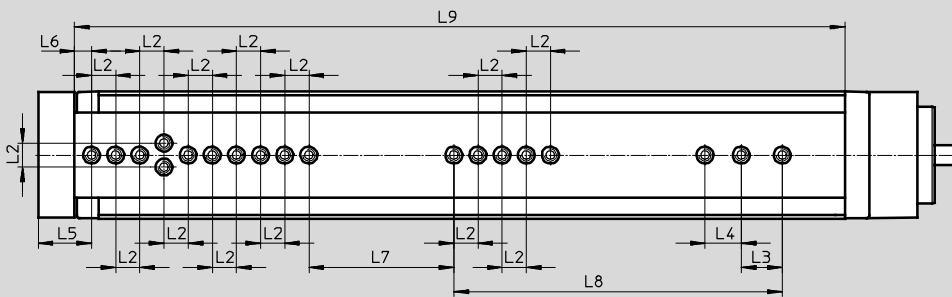

EGSL-55-250

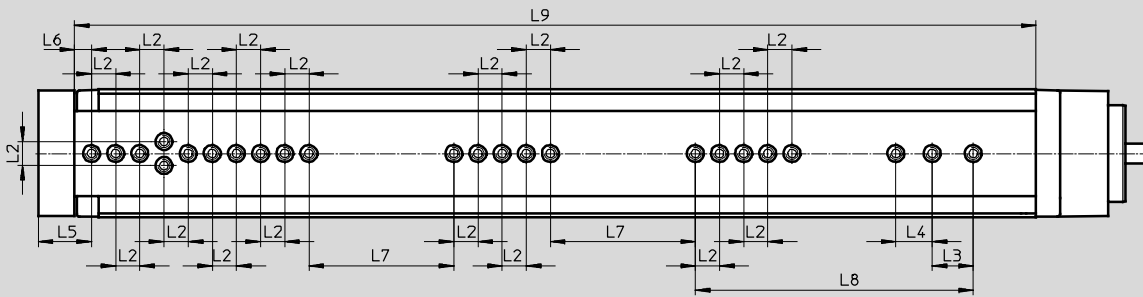

Size	Stroke [mm]	L2 <sup>1)</sup>	L3 <sup>1)</sup>	L4 <sup>1)</sup>	L5	L6	L7 <sup>1)</sup>	L8 <sup>1)</sup>	L9
55	100	10	17	15	22	7	-	186	219
	200						60	136	319
	250						60	115	398

1) Tolerance for centring hole  $\pm 0.02$  mm  
Tolerance for thread  $\pm 0.1$  mm

# Mini slides EGSL, electric

Technical data

## Hole pattern for mounting threads and centring holes

EGSL-75-100

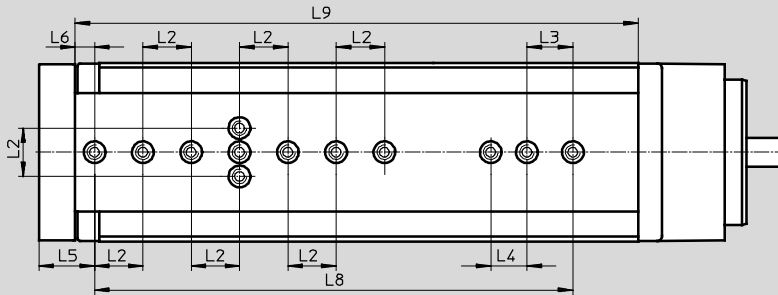

EGSL-75-200

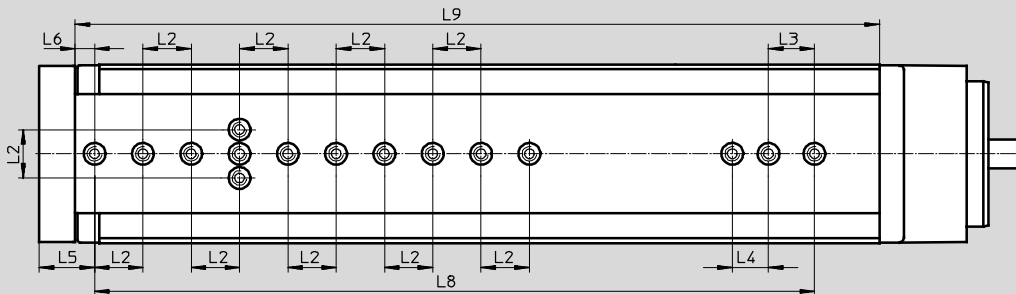

EGSL-75-300

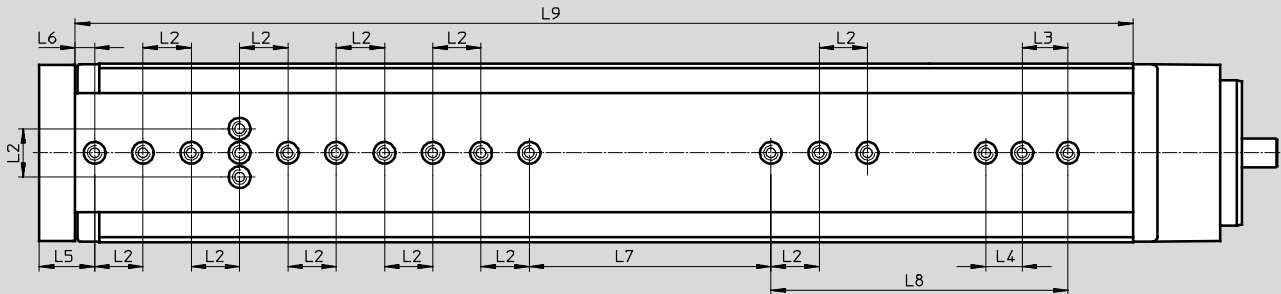

Size	Stroke [mm]	L2 <sup>1)</sup>	L3 <sup>1)</sup>	L4 <sup>1)</sup>	L5	L6	L7 <sup>1)</sup>	L8 <sup>1)</sup>	L9
75	100	20	19	15	23	8	-	198	233
	200						-	298	333
	300						100	123	438

1) Tolerance for centring hole  $\pm 0.02$  mm  
Tolerance for thread  $\pm 0.1$  mm

# Mini slides EGSL, electric

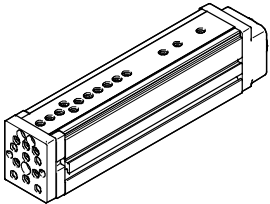

Technical data

FESTO

Ordering data					
	Size	Spindle pitch	Stroke	Part No.	Type
	35	8	50	562160	EGSL-BS-35-50-8P
	45	3	100	562225	EGSL-BS-45-100-3P
			200	562226	EGSL-BS-45-200-3P
		10	100	559335	EGSL-BS-45-100-10P
			200	559336	EGSL-BS-45-200-10P
	55	5	100	562227	EGSL-BS-55-100-5P
			200	562228	EGSL-BS-55-200-5P
			250	562229	EGSL-BS-55-250-5P
		12.7	100	559337	EGSL-BS-55-100-12.7P
			200	559338	EGSL-BS-55-200-12.7P
			250	559339	EGSL-BS-55-250-12.7P
	75	10	100	562230	EGSL-BS-75-100-10P
			200	562231	EGSL-BS-75-200-10P
			300	562232	EGSL-BS-75-300-10P
		20	100	559340	EGSL-BS-75-100-20P
			200	559341	EGSL-BS-75-200-20P
300			559342	EGSL-BS-75-300-20P	

# Mini slides EGSL, electric

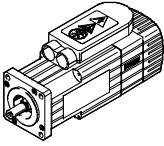
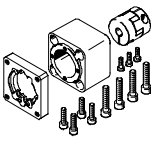
Accessories

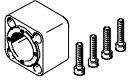
Permissible axis/motor combinations with axial kit					Technical data → Internet: eamm-a
Motor/motor unit	Axial kit	Axial kit consisting of:			
		Motor flange	Coupling	Coupling housing	
					
Type	Part No. Type	Part No. Type	Part No. Type	Part No. Type	
<b>EGSL-35</b>					
With servo motor					
EMMS-AS-40-...	1199152 EAMM-A-D19-40A	1199144 EAMF-A-28D-40A	543419 EAMC-16-20-5-6	1087585 EAMK-A-D19-28D	
With stepper motor					
EMMS-ST-28-...	1081659 EAMM-A-D19-28A	1087613 EAMF-A-28D-28A	562676 EAMC-16-20-5-5	1087585 EAMK-A-D19-28D	
EMMS-ST-42-...	1087642 EAMM-A-D19-42A	1087630 EAMF-A-28D-42A	562676 EAMC-16-20-5-5	1087585 EAMK-A-D19-28D	
<b>EGSL-45</b>					
With servo motor					
EMMS-AS-40-...	543147 EAMM-A-D32-40A	552163 EAMF-A-28B-40A	543420 EAMC-16-20-6-6	552155 EAMK-A-D32-28B	
EMMS-AS-55-...	550979 EAMM-A-D32-55A	529942 EAMF-A-44A/B-55A	551003 EAMC-30-32-6-9	551006 EAMK-A-D32-44A	
With stepper motor					
EMMS-ST-42-...	543148 EAMM-A-D32-42A	552164 EAMF-A-28B-42A	543419 EAMC-16-20-5-6	552155 EAMK-A-D32-28B	
EMMS-ST-57-...	550980 EAMM-A-D32-57A	530081 EAMF-A-44A/B-57A	551002 EAMC-30-32-6-6.35	551006 EAMK-A-D32-44A	
<b>EGSL-55</b>					
With servo motor					
EMMS-AS-55-...	543153 EAMM-A-D40-55A	529942 EAMF-A-44A/B-55A	543423 EAMC-30-32-8-9	552157 EAMK-A-D40-44A	
EMMS-AS-70-...	550981 EAMM-A-D40-70A	529943 EAMF-A-44A/B-70A	551004 EAMC-30-32-8-11	552157 EAMK-A-D40-44A	
With stepper motor					
EMMS-ST-57-...	543154 EAMM-A-D40-57A	530081 EAMF-A-44A/B-57A	543421 EAMC-30-32-6.35-8	552157 EAMK-A-D40-44A	
EMMS-ST-87-...	550982 EAMM-A-D40-87A	530082 EAMF-A-44A/B-87A	551004 EAMC-30-32-8-11	552157 EAMK-A-D40-44A	
<b>EGSL-75</b>					
With servo motor					
EMMS-AS-70-...	543161 EAMM-A-D60-70A	529945 EAMF-A-64A/B-70A	543424 EAMC-42-50-11-12	552160 EAMK-A-D60-64B	
EMMS-AS-100-...	550983 EAMM-A-D60-100A	529947 EAMF-A-64A/C-100A	551005 EAMC-42-50-12-19	551007 EAMK-A-D60-64C	
With stepper motor					
EMMS-ST-87-...	543162 EAMM-A-D60-87A	533140 EAMF-A-64A/B-87A	543424 EAMC-42-50-11-12	552160 EAMK-A-D60-64B	

# Mini slides EGSL, electric

Accessories

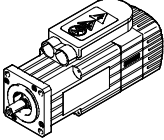
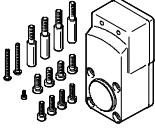
Permissible axis/motor combinations with parallel kit		Technical data → Internet: eamm-u
Motor/motor unit	Parallel kit	
	 <ul style="list-style-type: none"> <li>• Space-saving gravity die-cast housing</li> </ul>	
Type	Part No.	Type
<b>EGSL-45</b>		
With servo motor		
<b>EMMS-AS-40-...</b>	<b>543150</b>	<b>EAMM-U-D32-40A</b>
<b>EGSL-55</b>		
With servo motor		
<b>EMMS-AS-55-...</b>	<b>543157</b>	<b>EAMM-U-D40-55A</b>
<b>EGSL-75</b>		
With servo motor		
<b>EMMS-AS-70-...</b>	<b>543165</b>	<b>EAMM-U-D60-70A</b>

 - Note

The motor can only be mounted on the side and underneath when using these kits.

## Mini slides EGSL, electric

Accessories

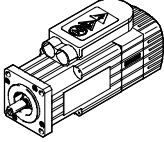
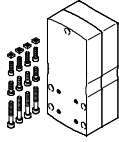
Permissible axis/motor combinations with parallel kit		Technical data → Internet: eamm-u
Motor/motor unit	Parallel kit	
		<ul style="list-style-type: none"> <li>• Increased housing rigidity</li> <li>• More flexible motor connection possible</li> <li>• Optionally with protection to IP65</li> <li>• Use in combination with third-party motors on request</li> </ul>
Type	Part No.	Type
<b>EGSL-45</b>		
With servo motor		
<b>EMMS-AS-40-...</b>	1201591	EAMM-U-50-D32-40A-78
<b>EMMS-AS-55-...</b>	1210126	EAMM-U-60-D32-55A-91
With stepper motor		
<b>EMMS-ST-42-...</b>	1201607	EAMM-U-50-D32-42A-78
<b>EMMS-ST-57-...</b>	1210419	EAMM-U-60-D32-57A-91
With motor		
<b>MTR-DCI-32S-...</b>	1570862	EAMM-U-50-D32-32B-78
<b>MTR-DCI-42S-...</b>	1577393	EAMM-U-60-D32-42B/C-91
With gear unit		
<b>EMGA-40-P-...</b>	1577358	EAMM-U-60-D32-40G-91
<b>EGSL-55</b>		
With servo motor		
<b>EMMS-AS-55-...</b>	1210438	EAMM-U-60-D40-55A-91
<b>EMMS-AS-70-...</b>	1212826	EAMM-U-86-D40-70A-102
With stepper motor		
<b>EMMS-ST-57-...</b>	1210442	EAMM-U-60-D40-57A-91
<b>EMMS-ST-87-...</b>	1215802	EAMM-U-86-D40-87A-102
With motor		
<b>MTR-DCI-42S-...</b>	1570950	EAMM-U-60-D40-42B/C-91
<b>MTR-DCI-52S-...</b>	1537046	EAMM-U-86-D40-52B/C-102
With gear unit		
<b>EMGA-40-P-...</b>	1577165	EAMM-U-60-D40-40G-91
<b>EMGA-60-P-...</b>	1586445	EAMM-U-86-D40-60G-102
<b>EMGC-60-P-...</b>	1586496	EAMM-U-86-D40-60H-102
<b>EGSL-75</b>		
With servo motor		
<b>EMMS-AS-70-...</b>	1212477	EAMM-U-86-D60-70A-102
<b>EMMS-AS-100-...</b>	1202436	EAMM-U-110-D60-100A-120
With stepper motor		
<b>EMMS-ST-87-...</b>	1215784	EAMM-U-86-D60-87A-102
With motor		
<b>MTR-DCI-52S-...</b>	1537000	EAMM-U-86-D60-52B/C-102
<b>MTR-DCI-62S-...</b>	1536988	EAMM-U-110-D60-62B-120
With gear unit		
<b>EMGA-60-P-...</b>	1586347	EAMM-U-86-D60-60G-102
<b>EMGC-60-P-...</b>	1586276	EAMM-U-86-D60-60H-102
<b>EMGA-60-P-...</b>	1543240	EAMM-U-110-D60-60G-120
<b>EMGC-60-P-...</b>	1542264	EAMM-U-110-D60-60H-120
<b>EMGA-80-P-...</b>	1532949	EAMM-U-110-D60-80G-120

 **Note**

The clamping component EADT is required to adjust the toothed belt pretension with EAMM-U-110.

The motor and/or axis shaft can optionally be supported with a counter bearing EAMG.

More information → eamm-u



# Mini slides EGSL, electric

Accessories

## Profile mounting

EAHF/MUE

Material:

Anodised aluminium

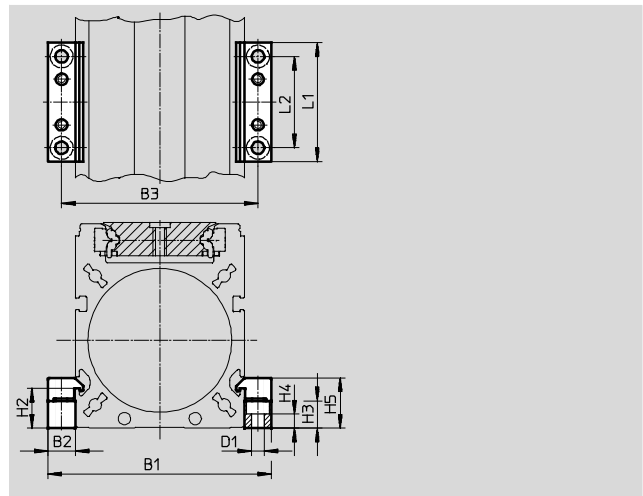

Dimensions and ordering data						
For size	B1	B2	B3	D1 Ø	H2	H3
35	49.5	8	41.5	3.4	10.5	10
45	68.5	12	56.5	5.5	12.5	8.3
55	77	12	65	5.5	17.5	12
75	98	12	86	5.5	17.5	12

For size	H4	H5	L1	L2	Weight [g]	Part No.	Type
35	6.8	15.5	40	20	20	1170211	EAHF-G1-35-P
45	2.5	17	52	40	23	1168859	EAHF-G1-45-P
55	6.2	22	52	40	80	558043	MUE-70/80
75	6.2	22	52	40	80	558043	MUE-70/80

## Switch lug EAPM

Material:

Galvanised steel

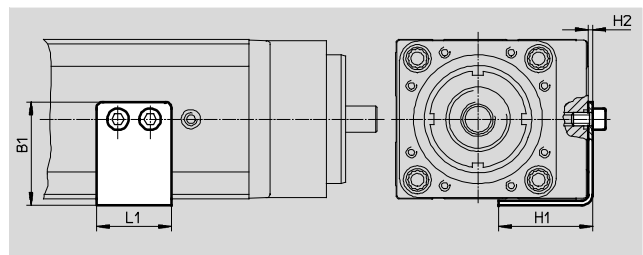

Dimensions and ordering data							
For size	B1	H1	H2	L1	Weight [g]	Part No.	Type
35	25.5	25	1.5	17	15	1235029	EAPM-G1-35-SLS
45	32	32.5	2	30	30	1235033	EAPM-G1-45-SLS
55	36	35	2	30	35	1235035	EAPM-G1-55-SLS
75	48	44	2	35	50	1235036	EAPM-G1-75-SLS

 Note  
The switch lug should only be attached to the designated threads (guide rail at the back).

# Mini slides EGSL, electric

Accessories

**Cover EASC**

Material:  
Anodised aluminium  
Free of copper, PTFE and silicone

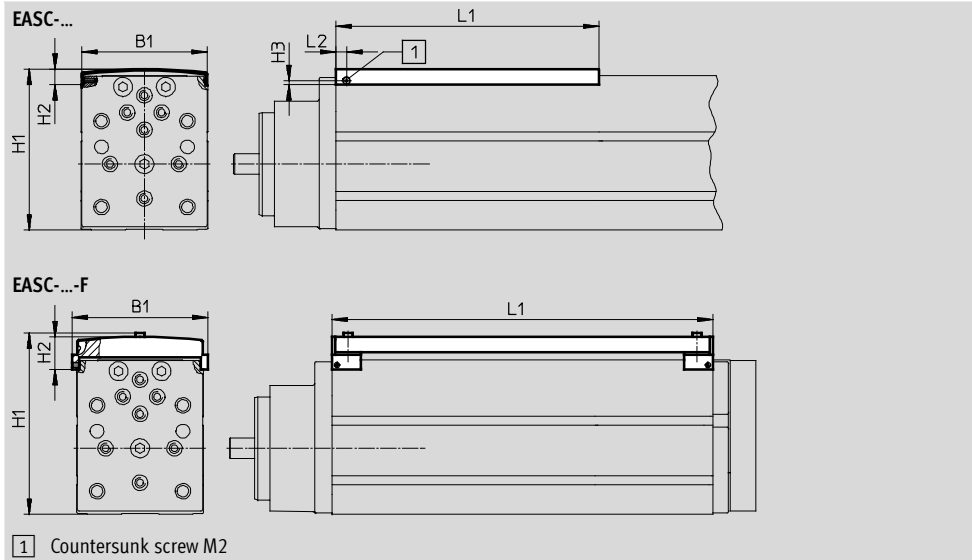

Dimensions and ordering data									
For size	Length [mm]	B1	H1	H2	H3	L1 -0.5	L2 -0.3	Part No.	Type
<b>For use without switch lug</b>									
35	50	32.5	43.2	8.5	2.3	58	6	570819	EASC-G1-35-50
	500 <sup>1)</sup>					500			
45	100	43.5	59.7	9	2.3	108	6	570822	EASC-G1-45-100
	200					208			
	500 <sup>1)</sup>					500			
55	100	52	69.7	9	2.3	108	6	570824	EASC-G1-55-100
	200					208			
	250					258			
	500 <sup>1)</sup>					500			
75	100	73	93.7	9	2.3	108	6	570827	EASC-G1-75-100
	200					208			
	300					308			
	500 <sup>1)</sup>					500			
<b>For use with switch lug</b>									
35	50	38.3	55	19.1	-	119.5	-	570830	EASC-G1-35-50-F
45	100	49.7	71.5	19.6	-	179	-	570833	EASC-G1-45-100-F
	200					279			
55	100	58.2	81.5	19.6	-	204	-	570835	EASC-G1-55-100-F
	200					304			
	250					383			
75	100	78.9	105.5	19.4	-	218	-	570838	EASC-G1-75-100-F
	200					318			
	300					423			

 **Note**



For covers with a length of 500 mm, the customer must bore the mounting hole on the side.

1) The cover can be shortened by the customer as required.

# Mini slides EGSL, electric

Accessories



**FESTO**

Ordering data					
	For size	Brief description	Part No.	Type	PU <sup>1)</sup>
<b>Centring sleeve ZBH</b>					
	35, 45, 55	For slide and yoke plate	<b>186717</b>	<b>ZBH-7</b>	10
	75		<b>150927</b>	<b>ZBH-9</b>	
<b>Connecting sleeve ZBV</b>					
	45, 55	For connecting mini slide EGSL with mini slide DGSL	<b>548803</b>	<b>ZBV-M5-7</b>	3
	75		<b>548804</b>	<b>ZBV-M6-9</b>	

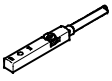
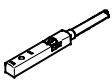
1) Packaging unit

Ordering data – Proximity sensors for T-slot, inductive					Technical data → Internet: sies	
	Type of mounting	Switching output	Electrical connection	Cable length [m]	Part No.	Type
<b>N/O contact</b>						
	Insertable in the slot from above, flush with the cylinder profile	PNP	Cable, 3-wire	7.5	<b>551386</b>	<b>SIES-8M-PS-24V-K-7,5-OE</b>
			Plug M8x1, 3-pin	0.3	<b>551387</b>	<b>SIES-8M-PS-24V-K-0,3-M8D</b>
		NPN	Cable, 3-wire	7.5	<b>551396</b>	<b>SIES-8M-NS-24V-K-7,5-OE</b>
			Plug M8x1, 3-pin	0.3	<b>551397</b>	<b>SIES-8M-NS-24V-K-0,3-M8D</b>
<b>N/C contact</b>						
	Insertable in the slot from above, flush with the cylinder profile	PNP	Cable, 3-wire	7.5	<b>551391</b>	<b>SIES-8M-PO-24V-K-7,5-OE</b>
			Plug M8x1, 3-pin	0.3	<b>551392</b>	<b>SIES-8M-PO-24V-K-0,3-M8D</b>
		NPN	Cable, 3-wire	7.5	<b>551401</b>	<b>SIES-8M-NO-24V-K-7,5-OE</b>
			Plug M8x1, 3-pin	0.3	<b>551402</b>	<b>SIES-8M-NO-24V-K-0,3-M8D</b>

Ordering data – Proximity sensors for T-slot, magneto-resistive					Technical data → Internet: smt	
	Type of mounting	Switching output	Electrical connection	Cable length [m]	Part No.	Type
<b>N/O contact</b>						
	Insertable in the slot lengthwise, flush with the cylinder profile	PNP	Cable, 3-wire	2.5	<b>175 436</b>	<b>SMT-8-PS-K-LED-24-B</b>
			Plug M8x1, 3-pin	0.3	<b>175 484</b>	<b>SMT-8-PS-S-LED-24-B</b>

Ordering data – Connecting cables				Technical data → Internet: nebu	
	Electrical connection, left	Electrical connection, right	Cable length [m]	Part No.	Type
	Straight socket, M8x1, 3-pin	Cable, open end, 3-wire	2.5	<b>541333</b>	<b>NEBU-M8G3-K-2.5-LE3</b>
			5	<b>541334</b>	<b>NEBU-M8G3-K-5-LE3</b>
	Angled socket, M8x1, 3-pin	Cable, open end, 3-wire	2.5	<b>541338</b>	<b>NEBU-M8W3-K-2.5-LE3</b>
			5	<b>541341</b>	<b>NEBU-M8W3-K-5-LE3</b>