

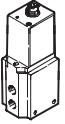

Proportional pressure regulators MPPE/MPPES



Proportional pressure regulators MPPE/MPPEs

Product range overview

Function	Version	Type	Design	Pneumatic connection 1	Nominal size pressurise/exhaust [mm]	Pressure regulation range ¹⁾ [bar]	Setpoint input		→ Page/Internet	
							Voltage type 0 ... 10 V	Current type 4 ... 20 mA		
Pressure regulators	With pilot control via 2/2-way valves (switching valves)									
		MPPE	Pilot-actuated valve	G ¹ / ₈	5/5	0 ... 1	■	■	5	
				G ³ / ₄	7/7	0 ... 2.5	■	■		
				G ¹ / ₂	11/12	0 ... 6	■	■		
							0 ... 10	■	■	
	With proportional solenoid									
		MPPEs	Directly actuated valve	G ¹ / ₈	3/2	0 ... 2	■	■	10	
				G ³ / ₄	7/7	0 ... 6	■	■		
			Pilot-actuated valve	G ¹ / ₂	11/12	0 ... 10	■	■		

1) Pressure regulation range also by customer request

Proportional pressure regulators MPPE/MPPES

Peripherals overview

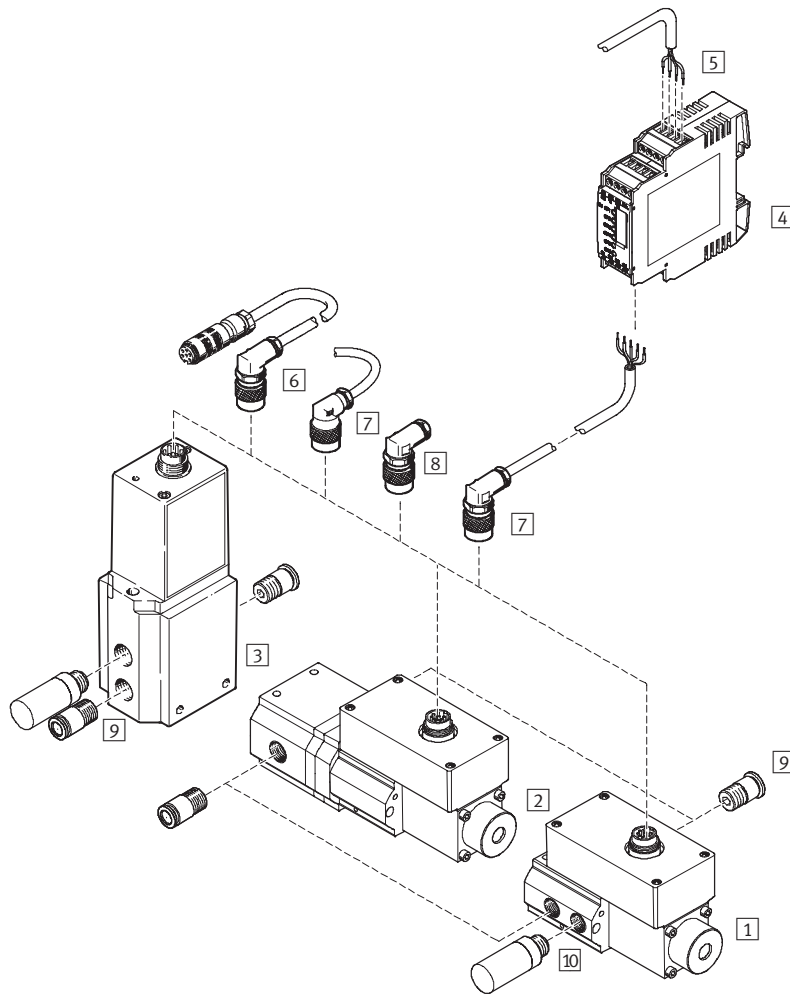

Accessories				
		Type	Brief description	→ Page/Internet
1	Proportional pressure regulator	MPPES	Directly controlled	10
2	Proportional pressure regulator	MPPES	Indirectly controlled	10
3	Proportional pressure regulator	MPPE	–	5
4	Setpoint module MPZ	MPZ	For generating 6+1 analogue voltage signals	14
5	Digital input/output	–	For controlling the setpoint module	–
6	Connecting cable	KVIA-MPPE	–	14
7	Plug socket with cable	KMPE-B	–	
8	Angled socket	MPPE-3-B	–	
9	Push-in fitting	QS	For connecting compressed air tubing	quick star
10	Silencer	U	For fitting in exhaust ports	u

Proportional pressure regulators MPPE

Type codes

Basic version

MPPE		-	3	-	1/8	-	1	-	010	-	B
Type											
MPPE	Proportional pressure regulator with switching valve head										
Valve function											
3	3-way pressure regulator										
Pneumatic connection											
1/8	Female thread G1/8										
1/4	Female thread G1/4										
1/2	Female thread G1/2										
Pressure regulation range											
1	0 ... 1 bar										
2,5	0 ... 2.5 bar										
6	0 ... 6 bar										
10	0 ... 10 bar										
Analogue setpoint input											
010	0 ... 10 V										
420	4 ... 20 mA										
Generation											
B	B series										

Special pressure regulation range by customer request

MPPE		-	3	-	1/8	-	2	-	4	-	010	-	B
Type													
MPPE	Proportional pressure regulator with switching valve head												
Valve function													
3	3-way pressure regulator												
Pneumatic connection													
1/8	Female thread G1/8												
1/4	Female thread G1/4												
1/2	Female thread G1/2												
Required pressure at 0 V or 4 mA [bar]													
Required pressure at 10 V or 20 mA [bar]													
Analogue setpoint input													
010	0 ... 10 V												
420	4 ... 20 mA												
Generation													
B	B series												

Proportional pressure regulators MPPE

Technical data

Flow rate
350 ... 8,800 l/min

Voltage
18 ... 30 V DC

 Pressure regulation range
0 ... 1 bar
0 ... 2.5 bar
0 ... 6 bar
0 ... 10 bar

- Variants
- Setpoint input as analogue voltage signal 0 ... 10 V
 - Setpoint input as analogue current signal 4 ... 20 mA



General technical data					
Pneumatic connection		G ¹ / ₈	G ¹ / ₄	G ¹ / ₂	
Design	Pilot-actuated piston regulator				
Sealing principle	Soft				
Actuation type	Electrical				
Type of control	Pilot-actuated via 2/2-way valves				
Type of mounting	Via through-hole				
Mounting position	Any				
Nominal size	Pressurisation	[mm]	5	7	11
	Exhaust	[mm]	5	7	12
Standard nominal flow rate	[l/min]	→ Graphs			
Product weight	[g]	710	920	2,400	

Flow rate qn as a function of output pressure p2

Pneumatic connection G¹/₈

Pressure regulation range 0 ... 1 bar

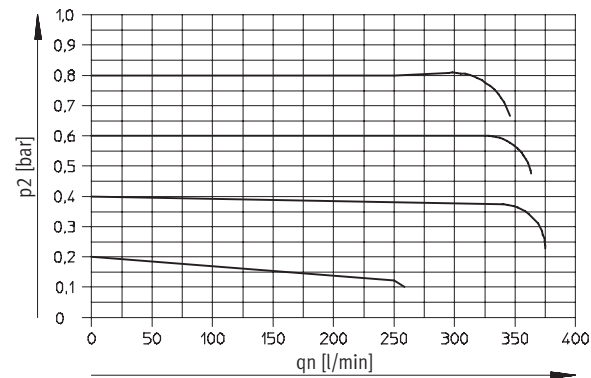

Pressure regulation range 0 ... 2.5 bar

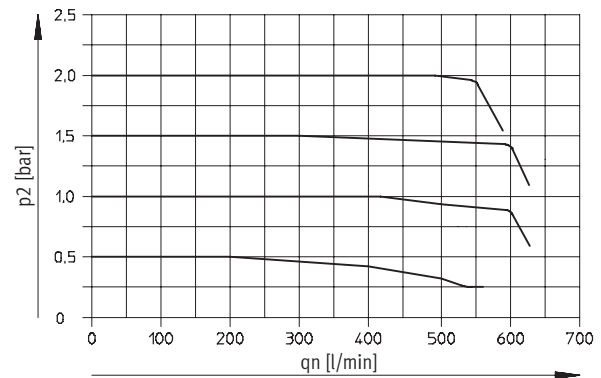

Pressure regulation range 0 ... 6 bar

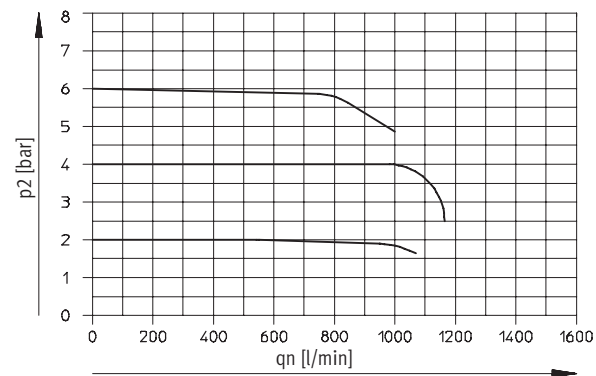

Pressure regulation range 0 ... 10 bar

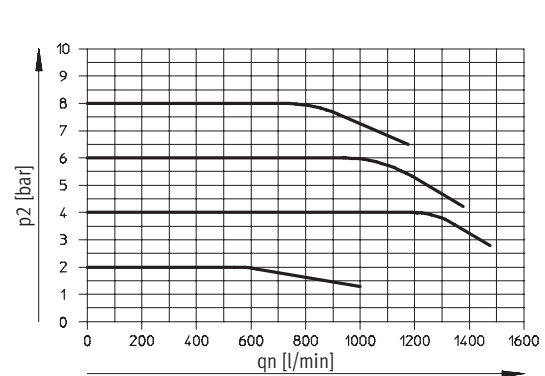

Proportional pressure regulators MPPE

Technical data



Flow rate q_n as a function of output pressure p_2

Pneumatic connection G $\frac{1}{4}$

Pressure regulation range 0 ... 1 bar

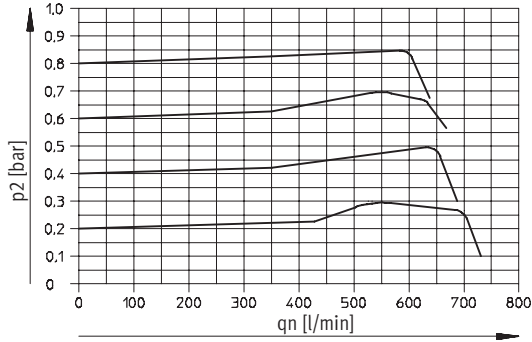

Pressure regulation range 0 ... 2.5 bar

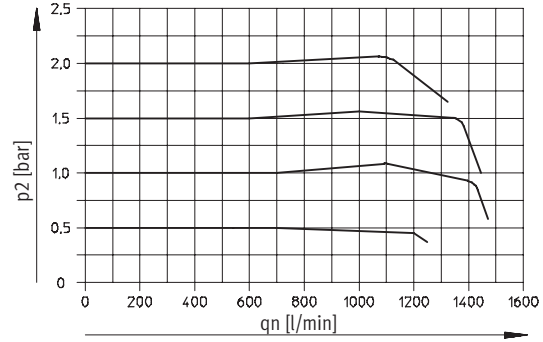

Pressure regulation range 0 ... 6 bar

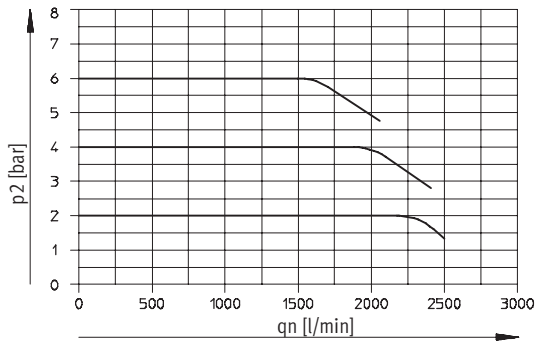

Pressure regulation range 0 ... 10 bar

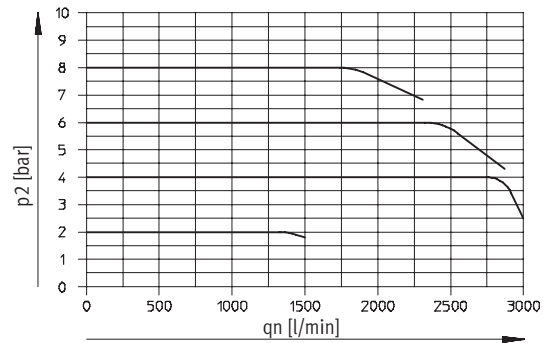

Pneumatic connection G $\frac{1}{2}$

Pressure regulation range 0 ... 1 bar

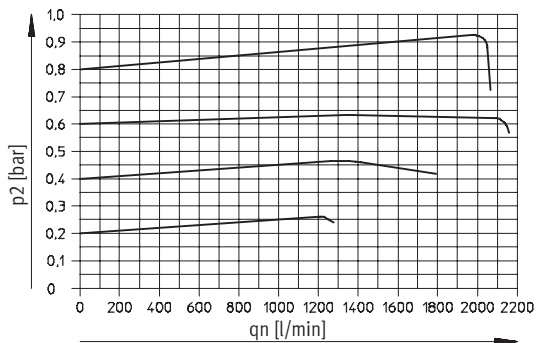

Pressure regulation range 0 ... 2.5 bar

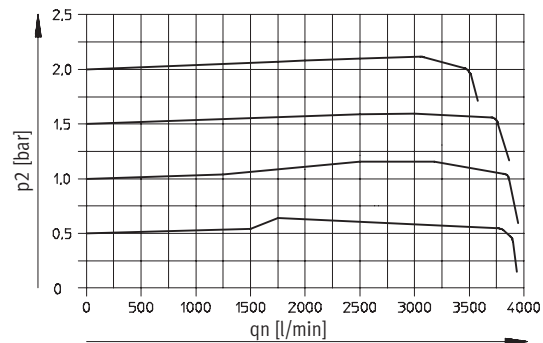

Pressure regulation range 0 ... 6 bar

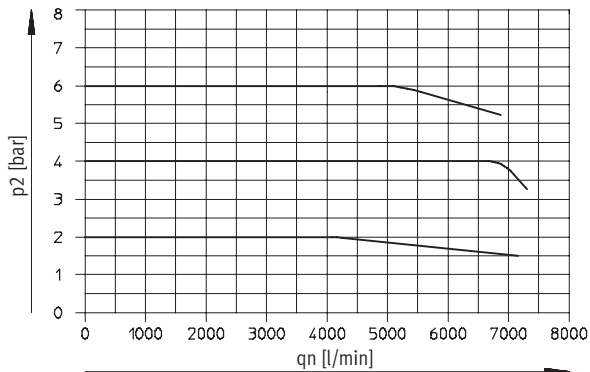

Pressure regulation range 0 ... 10 bar

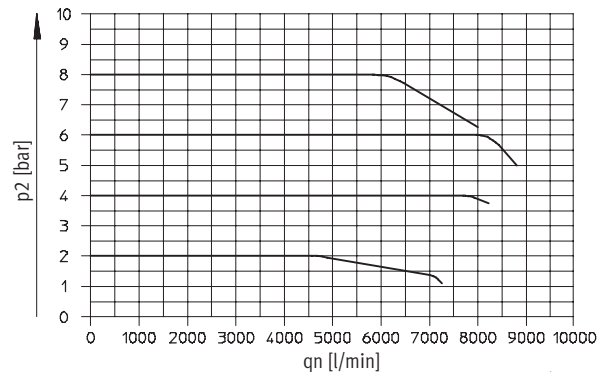

Proportional pressure regulators MPPE

Technical data

Operating and environmental conditions					
Pressure regulation range	[bar]	0 ... 1	0 ... 2.5	0 ... 6	0 ... 10
Operating medium		Filtered compressed air, lubricated or unlubricated, grade of filtration 40 µm, neutral gases			
Supply pressure 1	[bar]	1.5 ... 2	3.5 ... 4.5	7 ... 8	11 ... 12
Max. pressure hysteresis	[mbar]	30	40	40	50
Ambient temperature	[°C]	0 ... 50			
Temperature of medium	[°C]	0 ... 60			
Corrosion resistance class	[CRC]	2 ¹⁾			

- 1) Corrosion resistance class 2 according to Festo standard 940 070
 Components subject to moderate corrosion stress. Externally visible parts with primarily decorative surface requirements which are in direct contact with a normal industrial environment or media such as coolants or lubricating agents.

Electrical data					
Pressure regulation range	[bar]	0 ... 1	0 ... 2.5	0 ... 6	0 ... 10
Electrical connection		Plug, round design to DIN 45 326, M16 x 0.75, 8-pin			
Operating voltage range	U _B	[V DC]	18 ... 30		
Residual ripple		10%			
Power consumption	P _{max.}	[W]	3.6 (at 30 V DC and 100% duty cycle)		
Setpoint input signal	Voltage	V _w	[V DC]	0 ... 10	
	Current	I _w	[mA]	4 ... 20	
Actual value output signal	Voltage	V _x	[V DC]	0 ... 10	
	Current	I _x	[mA]	4 ... 20	
Actual value input signal, external	Voltage	V _{x,ext.}	[V DC]	0 ... 10	
	Current	I _{x,ext.}	[mA]	4 ... 20	
Protection class to DIN 60 529		IP65 (with connection socket)			
Safety note		In the event of a broken supply power wire or setpoint wire, output pressure remains and is uncontrolled. In the long-term, leakage results in pressure drop.			
Reverse polarity protection	Setpoint input, voltage signal 0 ... 10 V	For all electrical connections			
	Setpoint input, current signal 4 ... 20 mA	For operating voltage			
Protection against short circuit		Yes, for the types with voltage signal as setpoint input			

Materials	
Housing	Wrought aluminium alloy
Seals	NBR

Dimensions Download CAD Data → www.festo.com/us/cad

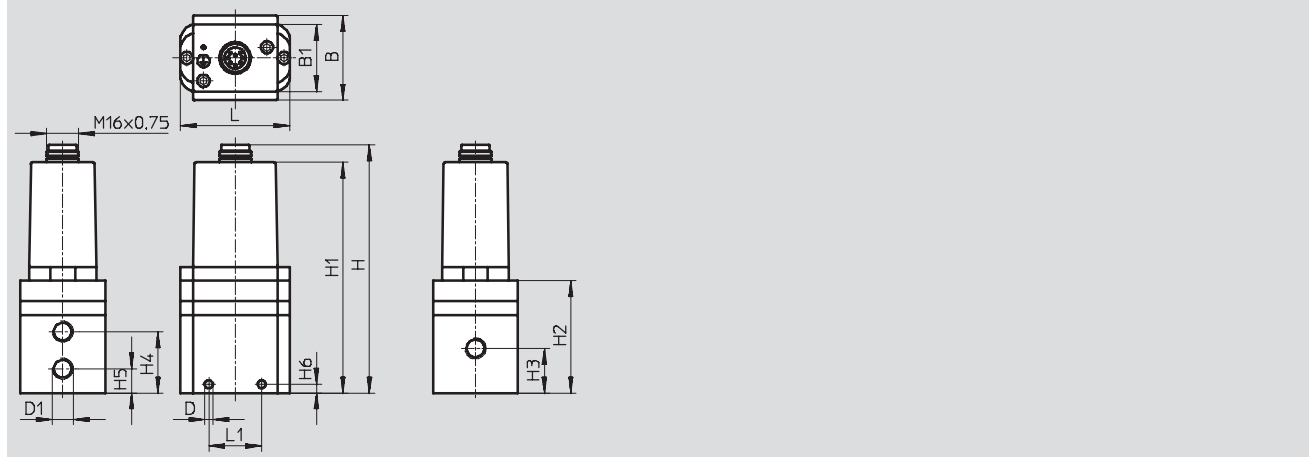

Connection D1	B	B1	∅ D	H	H1	H2	H3	H4	H5	H6	L	L1
G1/8	38	–	4.5	129.1	119.1	60.2	18.8	26.8	9.3	4	62	34
G1/4	48	38	4.5	140.7	130.7	63.6	25.3	34.8	13.8	5	62	30
G1/2	76	38	7	194.6	184.6	117.5	53	74	32	18	86	50

Proportional pressure regulators MPPE

Technical data

FESTO

Pin allocation Switching function

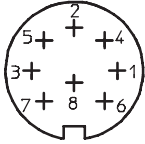

- | | | |
|---|----|-----------------------------------------------------|
| 1 | WH | $X_{\text{ext,in}}$ (external actual value input) |
| 2 | BN | GND |
| 3 | GN | GND |
| 4 | YE | W_{in} (setpoint input) |
| 5 | GY | 10 V_{out} (external potentiometer supply) |
| 6 | PK | X_{out} (actual value output) |
| 7 | RD | 24 V DC (supply voltage) |
| 8 | BU | GND |

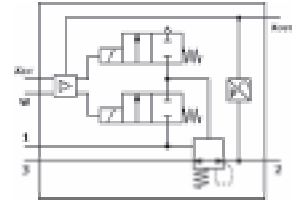

Ordering data					
Pneumatic connection	Pressure regulation range [bar]	Voltage type 0 ... 10 V		Current type 4 ... 20 mA	
		Part No.	Type	Part No.	Type
Basic version					
G $\frac{1}{8}$	0 ... 1	161160	MPPE-3-1/8-1-010-B	161163	MPPE-3-1/8-1-420-B
	0 ... 2.5	164315	MPPE-3-1/8-2,5-010-B	164316	MPPE-3-1/8-2,5-420-B
	0 ... 6	161161	MPPE-3-1/8-6-010-B	161164	MPPE-3-1/8-6-420-B
	0 ... 10	161162	MPPE-3-1/8-10-010-B	161165	MPPE-3-1/8-10-420-B
G $\frac{1}{4}$	0 ... 1	161166	MPPE-3-1/4-1-010-B	161169	MPPE-3-1/4-1-420-B
	0 ... 2.5	164317	MPPE-3-1/4-2,5-010-B	164318	MPPE-3-1/4-2,5-420-B
	0 ... 6	161167	MPPE-3-1/4-6-010-B	161170	MPPE-3-1/4-6-420-B
	0 ... 10	161168	MPPE-3-1/4-10-010-B	161171	MPPE-3-1/4-10-420-B
G $\frac{1}{2}$	0 ... 1	161172	MPPE-3-1/2-1-010-B	161175	MPPE-3-1/2-1-420-B
	0 ... 2.5	164319	MPPE-3-1/2-2,5-010-B	164320	MPPE-3-1/2-2,5-420-B
	0 ... 6	161173	MPPE-3-1/2-6-010-B	161176	MPPE-3-1/2-6-420-B
	0 ... 10	161174	MPPE-3-1/2-10-010-B	161177	MPPE-3-1/2-10-420-B
Special adaptation type¹⁾					
G $\frac{1}{8}$	0 ... 10	164330	MPPE-3-1/8-...-...-010-B ¹⁾	164330	MPPE-3-1/8-...-...-420-B ¹⁾
G $\frac{1}{4}$	0 ... 10	164331	MPPE-3-1/4-...-...-010-B ¹⁾	164331	MPPE-3-1/4-...-...-420-B ¹⁾
G $\frac{1}{2}$	0 ... 10	164332	MPPE-3-1/2-...-...-010-B ¹⁾	164332	MPPE-3-1/2-...-...-420-B ¹⁾

1) The special adaptation type allows a lower pressure to be assigned to the setpoint 0 V or 4 mA and an upper pressure to be assigned to the setpoint 10 V or 20 mA. Upper and lower pressure by customer request.

Proportional pressure regulators MPPES

Type codes

Basic version

		MPPES	-	3	-	1/8	-	1	-	010
Type										
MPPES	Proportional pressure regulator with proportional solenoid									
Valve function										
3	3-way pressure regulator									
Pneumatic connection										
1/8	Female thread G1/8									
1/4	Female thread G1/4									
1/2	Female thread G1/2									
Pressure regulation range										
2	0 ... 2 bar									
6	0 ... 6 bar									
10	0 ... 10 bar									
Analogue setpoint input										
010	0 ... 10 V									
420	4 ... 20 mA									

Special pressure regulation range by customer request

		MPPES	-	3	-	1/8	-	2	-	4	-	010
Type												
MPPES	Proportional pressure regulator with proportional solenoid											
Valve function												
3	3-way pressure regulator											
Pneumatic connection												
1/8	Female thread G1/8											
1/4	Female thread G1/4											
1/2	Female thread G1/2											
Required pressure at 0 V or 4 mA [bar]												
Required pressure at 10 V or 20 mA [bar]												
Analogue setpoint input												
010	0 ... 10 V											
420	4 ... 20 mA											

Proportional pressure regulators MPPES

Technical data

FESTO

Flow rate
230 ... 8,500 l/min

Voltage
18 ... 30 V DC

 Pressure regulation range
0 ... 2 bar
0 ... 6 bar
0 ... 10 bar

- Variants
- Setpoint input as analogue voltage signal 0 ... 10 V
 - Setpoint input as analogue current signal 4 ... 20 mA



General technical data			
Pneumatic connection	G ¹ / ₈	G ¹ / ₄	G ¹ / ₂
Design	Directly actuated piston regulator	Pilot-actuated piston regulator	
Sealing principle	Soft		
Actuation type	Electrical		
Type of mounting	Via through-hole		
Mounting position	Any		
Nominal size	Pressurisation [mm]	3	7
	Exhaust [mm]	2	7
Standard nominal flow rate	[l/min]	→ Graphs	
Product weight	[g]	915	1,310
			2,670

Flow rate qn as a function of output pressure p2

Pneumatic connection G¹/₈

Pressure regulation range 0 ... 2 bar

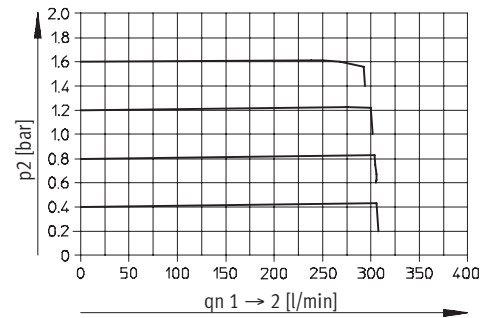

Pressure regulation range 0 ... 6 bar

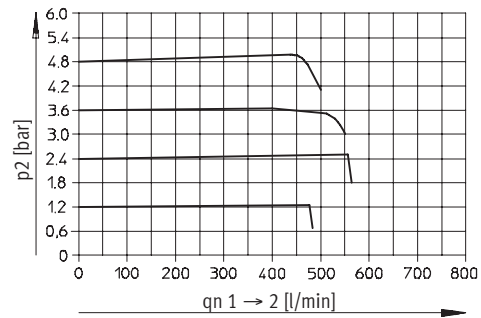

Pressure regulation range 0 ... 10 bar

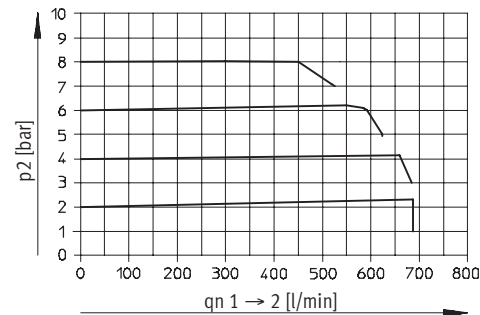

Proportional pressure regulators MPPES

Technical data

Flow rate q_n as a function of output pressure p_2

Pneumatic connection G $\frac{1}{4}$

Pressure regulation range 0 ... 2 bar

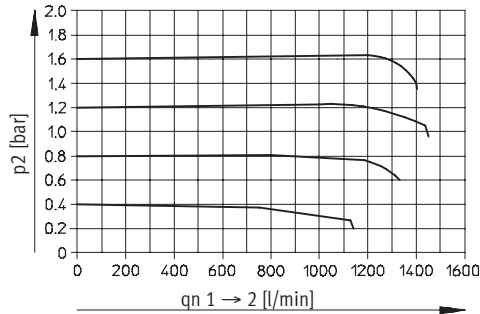

Pressure regulation range 0 ... 6 bar

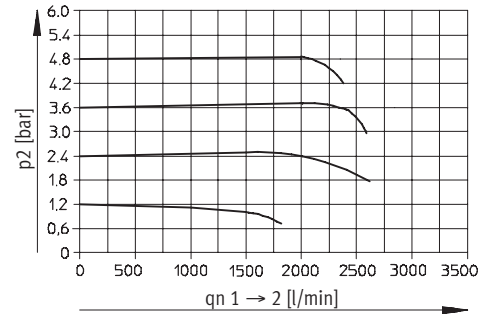

Pressure regulation range 0 ... 10 bar

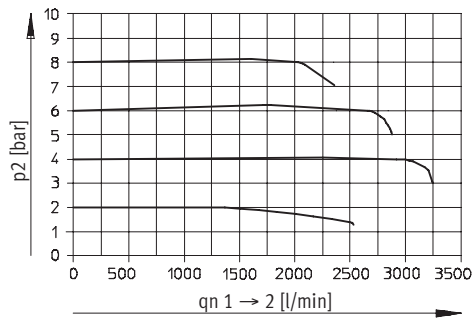

Pneumatic connection G $\frac{1}{2}$

Pressure regulation range 0 ... 2 bar

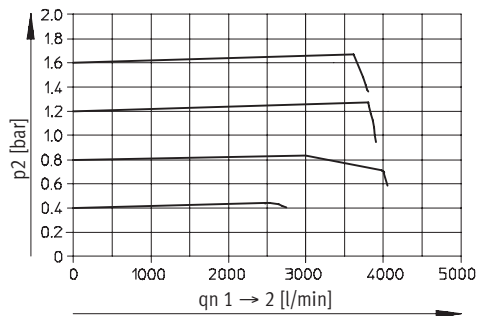

Pressure regulation range 0 ... 6 bar

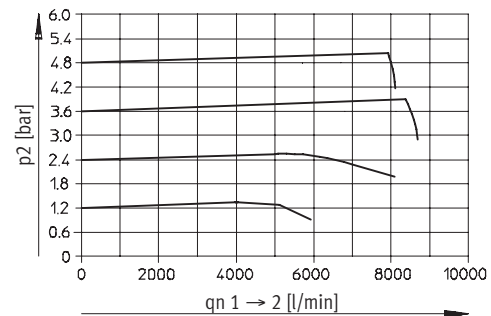

Pressure regulation range 0 ... 10 bar

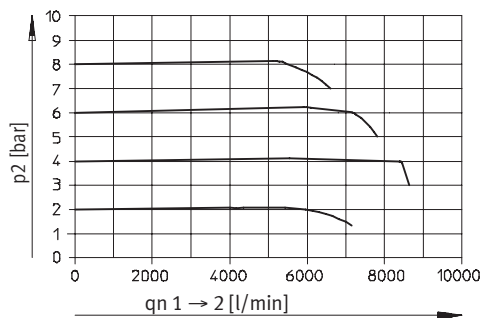

Proportional pressure regulators MPPES

Technical data

Operating and environmental conditions				
Pressure regulation range	[bar]	0 ... 2	0 ... 6	0 ... 10
Operating medium		Filtered compressed air, lubricated or unlubricated, neutral gases		
Supply pressure 1	[bar]	3 ... 4	7 ... 8	11 ... 12
Max. pressure hysteresis	[mbar]	10	50	50
Ambient temperature	[°C]	0 ... 50		
Temperature of medium	[°C]	0 ... 60		
Corrosion resistance class CRC		2 ¹⁾		

- 1) Corrosion resistance class 2 according to Festo standard 940 070
 Components subject to moderate corrosion stress. Externally visible parts with primarily decorative surface requirements which are in direct contact with a normal industrial environment or media such as coolants or lubricating agents.

Electrical data				
Pressure regulation range	[bar]	0 ... 2	0 ... 6	0 ... 10
Electrical connection		Plug, round design to DIN 45 326, M16 x 0.75, 8-pin		
Operating voltage range	U_B	[V DC]	18 ... 30	
Residual ripple		10%		
Power consumption	$P_{max.}$	[W]	20 (at 30 V DC)	
Setpoint input signal	Voltage	V_w	[V DC]	0 ... 10
	Current	I_w	[mA]	4 ... 20
Actual value output signal	Voltage	V_x	[V DC]	0 ... 10
	Current	I_x	[mA]	4 ... 20
Protection class to DIN 60 529		IP65 (with connection socket)		
Safety note		Output pressure is not maintained if the power supply cable is interrupted		
Reverse polarity protection	Setpoint input, voltage signal 0 ... 10 V	For all electrical connections		
	Setpoint input, current signal 4 ... 20 mA	For operating voltage		
Protection against short circuit		Yes, for the types with voltage signal as setpoint input		

Materials	
Housing	Wrought aluminium alloy
Seals	NBR

Note

The working line is vented if the power supply cable is interrupted.

Proportional pressure regulators MPPES

Technical data

FESTO

Dimensions Download CAD Data → www.festo.com/us/cad

MPPES-3-1/4-... MPPES-3-1/8-... MPPES-3-1/8-... MPPES-3-1/4-...
MPPES-3-1/2-... MPPES-3-1/2-...

Connection D1	B	B1	∅D	H	H1	H2	H3	H4	H5	H6	L	L1
G ¹ / ₈	77.1	67.1	4.4	116.5	100	55	34	45	23	4	62	34
G ¹ / ₄	82.1	72.1	4.5	170.2	153.7	63.7	25.3	34.8	13.8	5	62	30
G ¹ / ₂	96.1	86.1	7	227.1	210.6	120.6	53	74	32	18	86	50

Connections

Pin allocation

1	WH	n.c.
2	BN	GND
3	GN	GND
4	YE	W _{in} (setpoint input)
5	GY	n.c.
6	PK	X _{out} (actual value output)
7	RD	24 V DC (supply voltage)
8	BU	GND

Switching function

MPPES-3-1/8-... MPPES-3-1/4-.../MPPES-3-1/2-...

Ordering data



Pneumatic connection	Pressure regulation range [bar]	Voltage type 0 ... 10 V		Current type 4 ... 20 mA	
		Part No.	Type	Part No.	Type
Basic version					
G ¹ / ₈	0 ... 2	187350	MPPES-3-1/8-2-010	187351	MPPES-3-1/8-2-420
	0 ... 6	187352	MPPES-3-1/8-6-010	187353	MPPES-3-1/8-6-420
	0 ... 10	187348	MPPES-3-1/8-10-010	187349	MPPES-3-1/8-10-420
G ¹ / ₄	0 ... 2	187335	MPPES-3-1/4-2-010	187336	MPPES-3-1/4-2-420
	0 ... 6	187337	MPPES-3-1/4-6-010	187338	MPPES-3-1/4-6-420
	0 ... 10	187333	MPPES-3-1/4-10-010	187334	MPPES-3-1/4-10-420
G ¹ / ₂	0 ... 2	187328	MPPES-3-1/2-2-010	187329	MPPES-3-1/2-2-420
	0 ... 6	187330	MPPES-3-1/2-6-010	187331	MPPES-3-1/2-6-420
	0 ... 10	187326	MPPES-3-1/2-10-010	187327	MPPES-3-1/2-10-420
Special adaptation type¹⁾					
G ¹ / ₈	0 ... 10	187347	MPPES-3-1/8-PU-PO-010	187762	MPPES-3-1/8-PU-PO-420
G ¹ / ₄	0 ... 10	187339	MPPES-3-1/4-PU-PO-010	187744	MPPES-3-1/4-PU-PO-420
G ¹ / ₂	0 ... 10	187332	MPPES-3-1/2-PU-PO-010	187735	MPPES-3-1/2-PU-PO-420

1) The special adaptation type allows a lower pressure PU to be assigned to the setpoint 0 V or 4 mA and an upper pressure PO to be assigned to the setpoint 10 V or 20 mA. PU and PO by customer request.

Proportional pressure regulators MPPE/MPPEs

Accessories

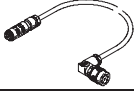
FESTO

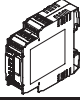
Ordering data				
	Description	Cable length [m]	Part No.	Type
Connecting cable Technical data → Internet: kvia-mppe				
	Connecting cable to the analogue module of valve terminal type 03/04	5	163882	KVIA-MPPE-5
		10	163883	KVIA-MPPE-10
Plug socket with cable Technical data → Internet: kmppe-b				
	Angled, 8-pin, M16x0.75	2.5	161879	KMPPE-B-2,5
		5	161878	KMPPE-B-5
Angled socket Technical data → Internet: mppe				
	Angled, 8-pin, M16x0.75	–	161839	MPPE-3-B
Setpoint module Technical data → Internet: mpz				
	Setpoint module for generating 6 + 1 analogue voltage signals	–	546224	MPZ-1-24DC-SGH-6-SW

Product Range and Company Overview

A Complete Suite of Automation Services

Our experienced engineers provide complete support at every stage of your development process, including: conceptualization, analysis, engineering, design, assembly, documentation, validation, and production.



Custom Automation Components
Complete custom engineered solutions



Custom Control Cabinets
Comprehensive engineering support and on-site services



Complete Systems
Shipment, stocking and storage services

The Broadest Range of Automation Components

With a comprehensive line of more than 30,000 automation components, Festo is capable of solving the most complex automation requirements.



Electromechanical
Electromechanical actuators, motors, controllers & drives



Pneumatics
Pneumatic linear and rotary actuators, valves, and air supply



PLCs and I/O Devices
PLC's, operator interfaces, sensors and I/O devices

Supporting Advanced Automation... As No One Else Can!

Festo is a leading global manufacturer of pneumatic and electromechanical systems, components and controls for industrial automation, with more than 12,000 employees in 56 national headquarters serving more than 180 countries. For more than 80 years, Festo has continuously elevated the state of manufacturing with innovations and optimized motion control solutions that deliver higher performing, more profitable automated manufacturing and processing equipment. Our dedication to the advancement of automation extends beyond technology to the education and development of current and future automation and robotics designers with simulation tools, teaching programs, and on-site services.

Quality Assurance, ISO 9001 and ISO 14001 Certifications

Festo Corporation is committed to supply all Festo products and services that will meet or exceed our customers' requirements in product quality, delivery, customer service and satisfaction.

To meet this commitment, we strive to ensure a consistent, integrated, and systematic approach to management that will meet or exceed the requirements of the ISO 9001 standard for Quality Management and the ISO 14001 standard for Environmental Management.



© Copyright 2008, Festo Corporation. While every effort is made to ensure that all dimensions and specifications are correct, Festo cannot guarantee that publications are completely free of any error, in particular typing or printing errors. Accordingly, Festo cannot be held responsible for the same. For Liability and Warranty conditions, refer to our "Terms and Conditions of Sale", available from your local Festo office. All rights reserved. No part of this publication may be reproduced, distributed, or transmitted in any form or by any means, electronic, mechanical, photocopying or otherwise, without the prior written permission of Festo. All technical data subject to change according to technical update.



Printed on recycled paper at New Horizon Graphic, Inc., FSC certified as an environmentally friendly printing plant.

Festo North America

Festo Regional Contact Center

5300 Explorer Drive
Mississauga, Ontario L4W 5G4
Canada

USA Customers:

For ordering assistance,

Call: 1.800.99.FESTO (1.800.993.3786)

Fax: 1.800.96.FESTO (1.800.963.3786)

Email: customer.service@us.festo.com

For technical support,

Call: 1.866.GO.FESTO (1.866.463.3786)

Fax: 1.800.96.FESTO (1.800.963.3786)

Email: product.support@us.festo.com

Canadian Customers:

Call: 1.877.GO.FESTO (1.877.463.3786)

Fax: 1.877.FX.FESTO (1.877.393.3786)

Email: festo.canada@ca.festo.com

USA Headquarters

Festo Corporation
395 Moreland Road
P.O. Box 18023
Hauppauge, NY 11788, USA
www.festo.com/us

USA Sales Offices

Appleton

North 922 Tower View Drive, Suite N
Greenville, WI 54942, USA

Boston

120 Presidential Way, Suite 330
Woburn, MA 01801, USA

Chicago

1441 East Business Center Drive
Mt. Prospect, IL 60056, USA

Dallas

1825 Lakeway Drive, Suite 600
Lewisville, TX 75057, USA

Detroit – Automotive Engineering Center

2601 Cambridge Court, Suite 320
Auburn Hills, MI 48326, USA

New York

395 Moreland Road
Hauppauge, NY 11788, USA

Silicon Valley

4935 Southfront Road, Suite F
Livermore, CA 94550, USA

United States



USA Headquarters, East: Festo Corp., 395 Moreland Road, Hauppauge, NY 11788

Phone: 1.631.435.0800; Fax: 1.631.435.8026;

Email: info@festo-usa.com

www.festo.com/us

Canada



Headquarters: Festo Inc., 5300 Explorer Drive, Mississauga, Ontario L4W 5G4

Phone: 1.905.624.9000; Fax: 1.905.624.9001;

Email: festo.canada@ca.festo.com

www.festo.ca

Mexico



Headquarters: Festo Pneumatic, S.A., Av. Ceylán 3, Col. Tequesquahuac,
54020 Tlalneantla, Edo. de México

Phone: 011 52 [55] 53 21 66 00; Fax: 011 52 [55] 53 21 66 65;

Email: festo.mexico@mx.festo.com

www.festo.com/mx

Central USA

Festo Corporation
1441 East Business
Center Drive
Mt. Prospect, IL 60056, USA
Phone: 1.847.759.2600
Fax: 1.847.768.9480



Western USA

Festo Corporation
4935 Southfront Road,
Suite F
Livermore, CA 94550, USA
Phone: 1.925.371.1099
Fax: 1.925.245.1286



Festo Worldwide

Argentina Australia Austria Belarus Belgium Brazil Bulgaria Canada Chile China Colombia Croatia Czech Republic Denmark
Estonia Finland France Germany Great Britain Greece Hong Kong Hungary India Indonesia Iran Ireland Israel Italy Japan Latvia
Lithuania Malaysia Mexico Netherlands New Zealand Norway Peru Philippines Poland Romania Russia Serbia Singapore
Slovakia Slovenia South Africa South Korea Spain Sweden Switzerland Taiwan Thailand Turkey Ukraine United States Venezuela

www.festo.com