

Parallel grippers HGP

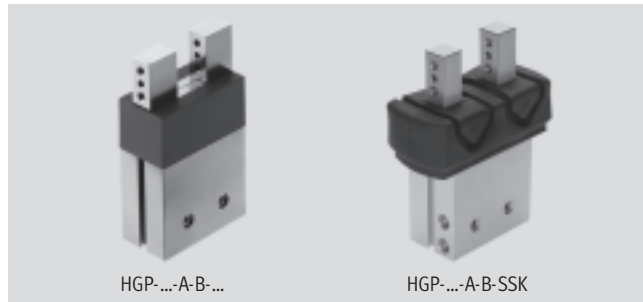

Parallel grippers HGP

Key features



At a glance

- Double-acting piston drive
- Self-centring
- Variable gripping action:
 - External/internal gripping
- Versatility thanks to externally adaptable gripper fingers
- Wide range of options for mounting on drive units
- High gripping force and compact size
- Max. repetition accuracy
- Gripping force retention
- Internal fixed flow control
- With protective dust cap for use in dusty environments (protection class IP54)
- Sensor technology:
 - Adaptable proximity sensors on the small grippers
 - Integral proximity sensors for medium and large grippers

Note
Sizing software
Gripper selection
→ www.festo.com

Mounting options for external gripper fingers (customer-specific)

- 1 Parallel gripper
- 2 External gripper fingers
- 3 Mounting screws
- 4 Centring pins

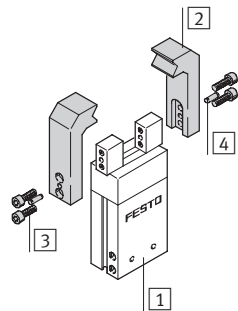

With protective dust cap

The sizes 16 and 25 can be adapted for use in dusty environments. They fulfil the requirements for protection class IP54.

The technical data corresponds to the data for parallel gripper HGP without protective dust cap.



Note
Grippers should always be used with exhaust air flow control. They are not suitable for the following, or for similar applications:

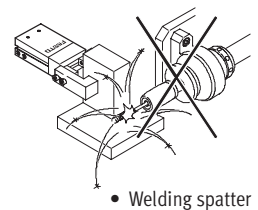
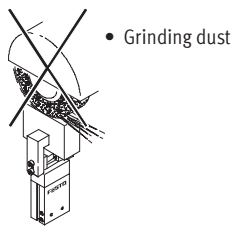
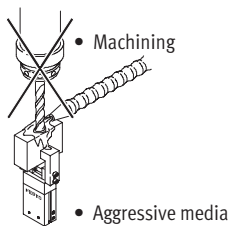

Parallel grippers HGP

Peripherals overview and type codes

Peripherals overview

HGP-06

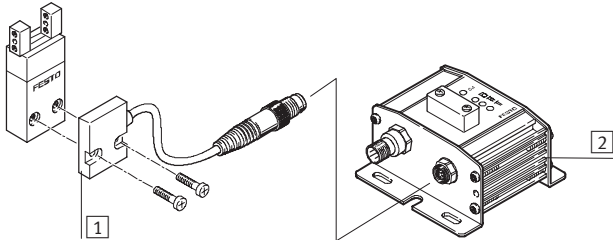

System product for handling and assembly technology

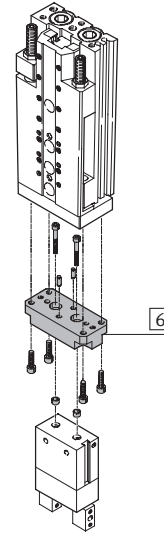

HGP-10 ... 35

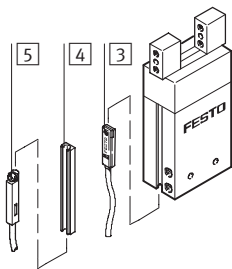

Accessories			
Type	Brief description	→ Page/Internet	
1	Position sensor SMH-S1 Adaptable and integratable sensor technology, for sensing the piston position	13	
2	Evaluation unit SMH-AE1 For position sensor SMH-S1	13	
3	Proximity sensor SME/SMT-8 For sensing the piston position	14	
4	Bondable sensor rail HGP-SL Allows the use of proximity sensors SME/SMT-10	13	
5	Proximity sensor SME/SMT-10 For sensing the piston position	15	
6	- Drive/gripper connections	adapter kit	

Type codes

HGP		16	A	B	G1	SSK
Type	HGP	Parallel gripper				
Size						
Position sensing	A	For proximity sensing				
Generation	B	B series				
Gripping force retention	G1	Opening				
	G2	Closing				
Protective dust cap	SSK	Protective dust cap				

Parallel grippers HGP

Technical data

FESTO

Function

Double-acting

HGP-06-A, HGP-...-A-B

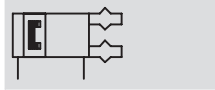

Size
6 ... 35 mm

Stroke
4 ... 25 mm

Variants

- With gripping force retention...
 - ... opening HGP-...-G1
 - ... closing HGP-...-G2
- With protective dust cap



www.festo.com

Wearing parts kits

→ 12

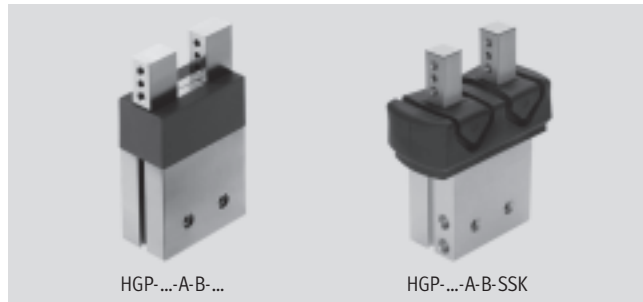

General technical data							
Size	6	10	16	20	25	35	
Design	Wedge-shaped		Lever mechanism				
Mode of operation	Double-acting						
Gripper function	Parallel						
Number of gripper jaws	2						
Max. weight force per external gripper finger ¹⁾	[N]	0.1	0.2	0.4	0.6	0.8	1.2
Stroke per gripper jaw	[mm]	2	3	5	6.5	7.5	12.5
Pneumatic connection		M3			M5	G1/8	
Repetition accuracy ²⁾	[mm]	≤ 0.04					
Max. interchangeability	[mm]	0.2					
Max. operating frequency	[Hz]	4					
Position sensing		For proximity sensing					
Type of mounting		With female thread and centring sleeve					
		-		Via through-holes and centring sleeve			

1) Valid for unthrottled operation

2) End position drift under constant conditions of use with 100 consecutive strokes in the direction of movement of the gripper jaws

-||- Note: This product conforms to ISO 1179-1 and to ISO 228-1

Operating and environmental conditions							
Size	6	10	16	20	25	35	
Min. operating pressure	HGP-...-A/-B [bar]	2					
	HGP-...-G... [bar]	5					
Max. operating pressure	[bar]	8					
Operating medium		Filtered compressed air, lubricated or unlubricated					
Ambient temperature	[°C]	+5 ... +60					
Corrosion resistance class CRC ¹⁾		2	1				

1) Corrosion resistance class 1 according to Festo standard 940 070

Components requiring low corrosion resistance. Transport and storage protection. Parts that do not have primarily decorative surface requirements, e.g. in internal areas that are not visible or behind covers.

Corrosion resistance class 2 according to Festo standard 940 070

Components requiring moderate corrosion resistance. Externally visible parts with primarily decorative surface requirements which are in direct contact with a normal industrial environment or media such as coolants or lubricating agents

Weights [g]							
Size	6	10	16	20	25	35	
HGP-...-A	18	75	194	396	725	1 369	
HGP-...-G1	-	76	197	402	737	1 387	
HGP-...-G2	-	76	197	402	737	1 387	
With protective dust cap							
HGP-...-SSK	-	-	197	-	737	-	

Parallel grippers HGP

Technical data

FESTO

Materials

Sectional view

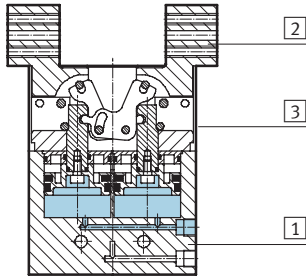

Parallel gripper	6	10	16	20	25	35
1 Body	Nickel-plated aluminium		Hard anodised aluminium			
2 Gripper jaw	Nickel-plated steel		High-alloy steel			
3 Cover cap	Polyamide					
- Protective dust cap SSK	-		Thermoplastic vulcanizate	-	Thermoplastic vulcanizate	-
- Note on materials	Copper, PTFE and silicone-free					
	Conforms to RoHS					

Gripping force [N] at 6 bar

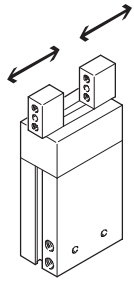

Size	6	10	16	20	25	35
Gripping force per gripper jaw						
Opening	10	22	70	120	185	375
Closing	10	17	80	115	170	350
Total gripping force						
Opening	20	44	140	240	370	750
Closing	20	34	160	230	340	700

Characteristic load values per gripper jaw

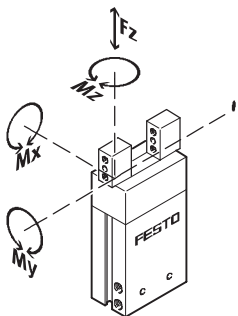

The indicated permissible forces and torques apply to a single gripper jaw. The indicated values include the lever arm, additional applied loads caused

by the workpiece or external gripper fingers, as well as forces which occur during movement.

The zero co-ordinate line (gripper jaw guide) must be taken into consideration for the calculation of torques.

Size	6	10	16	20	25	35	
Max. permissible force F_z	[N]	14	25	90	150	240	380
Max. permissible torque M_x	[Nm]	0.1	0.5	3.3	6	11	25
Max. permissible torque M_y	[Nm]	0.1	0.5	3.3	6	11	25
Max. permissible torque M_z	[Nm]	0.1	0.5	3.3	6	11	25

Parallel grippers HGP

Technical data

FESTO

Mass moment of inertia [$\text{kgm}^2 \times 10^{-4}$]

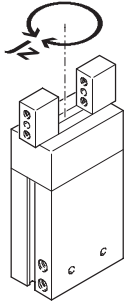

Mass moment of inertia [$\text{kgm}^2 \times 10^{-4}$] for parallel grippers in relation to the central axis, without external gripper fingers, without load.

Size	6	10	16	20	25	35
HGP-...-A	0.01	0.08	0.47	1.49	3.83	12.70
HGP-...-G1	–	0.08	0.47	1.52	3.92	12.83
HGP-...-G2	–	0.08	0.47	1.49	3.84	12.73

Opening and closing times [ms] at 6 bar

without external gripper fingers

with external gripper fingers

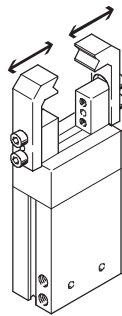
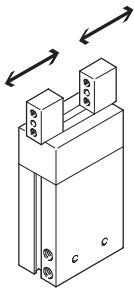

The indicated opening and closing times [ms] have been measured at room temperature and 6 bar operating pressure without external gripper fingers.

The grippers must be throttled for greater applied loads. Opening and closing times must then be adjusted accordingly.

Size		6	10	16	20	25	35
Without external gripper fingers							
HGP-...-A	Opening	5	22	44	32	47	77
	Closing	5	31	60	44	50	77
HGP-...-G1	Opening	–	17	39	30	39	71
	Closing	–	29	62	48	60	82
HGP-...-G2	Opening	–	33	66	39	62	90
	Closing	–	29	44	42	49	72
With external gripper fingers (as a function of weight force)							
HGP	0.06 N	5	–	–	–	–	–
	0.08 N	10	–	–	–	–	–
	0.10 N	20	–	–	–	–	–
	0.20 N	50	–	–	–	–	–
	0.50 N	–	100	–	–	–	–
	1.00 N	–	200	100	–	–	–
	1.25 N	–	–	–	100	–	–
	1.50 N	–	300	200	–	100	–
	1.75 N	–	–	–	200	–	–
	2.00 N	–	–	300	–	200	100
	2.50 N	–	–	–	300	–	–
	3.00 N	–	–	–	–	300	200
	4.00 N	–	–	–	–	–	300

Parallel grippers HGP

Technical data

Gripping force F_{Grip} per gripper jaw as a function of operating pressure and lever arm x

External and internal gripping (closing and opening)

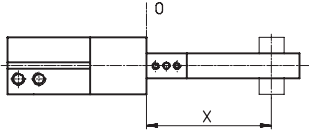

Gripping forces can be determined with the following diagrams for the various sizes in relation to operating

pressure and lever arm (distance from the zero co-ordinate line shown

opposite to the pressure point at which the fingers grip the workpiece).

HGP-06-A¹⁾

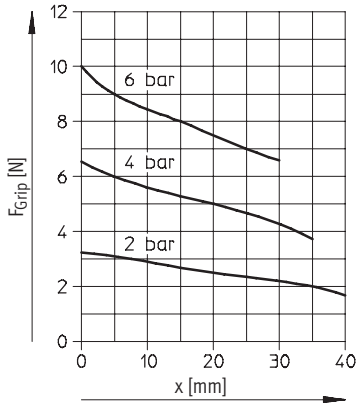

1) Due to the design, the opening and closing gripping forces for HGP-06-A are identical

HGP-10-A-B

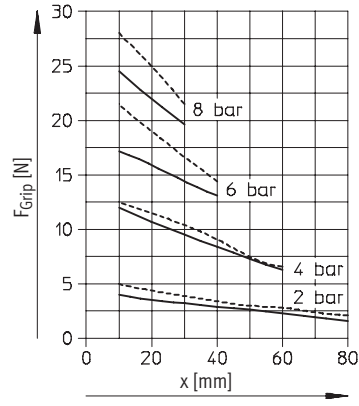

HGP-16-A-B

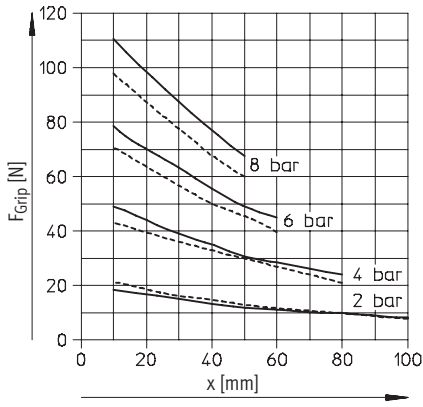

HGP-20-A-B

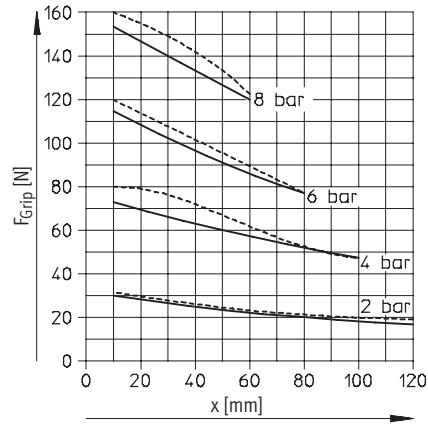

HGP-25-A-B

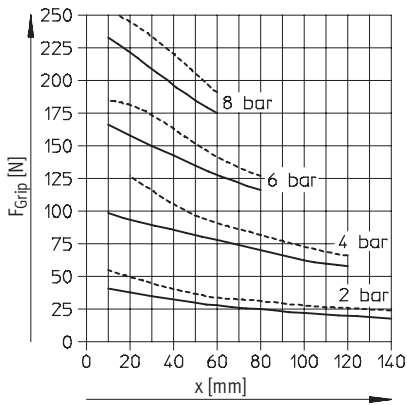

HGP-35-A-B

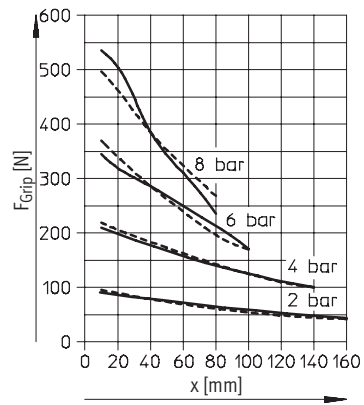

— Closing
 - - - Opening

Parallel grippers HGP

Technical data

Spring force F_{Spring} as a function of the gripper size and overall stroke length l

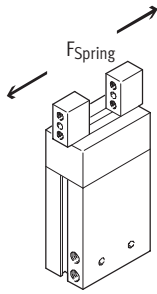

Gripper retention force, opening: the spring forces F_{Spring} of the parallel gripper HGP-...-G1 can be determined from the following graphs.

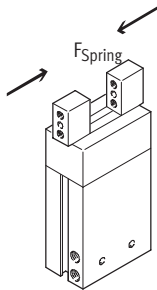
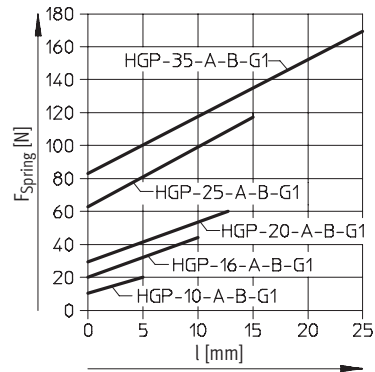

Gripper retention force, closing: the spring forces F_{Spring} of the parallel gripper HGP-...-G2 can be determined from the following graphs.

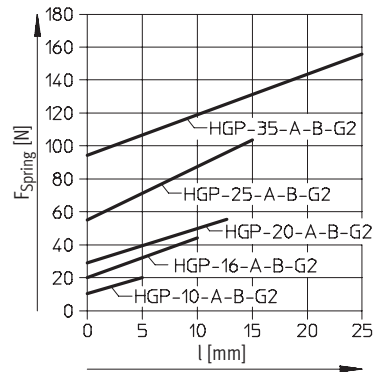

Determination of actual gripping forces for parallel grippers HGP-...-G1 and HGP-...-G2 depending upon the application

The parallel grippers with integrated spring can be used as:

- single-acting grippers
- grippers with supplementary gripping force and
- grippers with gripping force retention

In order to calculate available gripping forces F_{Gr} (per gripper jaw), the gripping force F_{Grip} and spring

force (F_{Spring}) must be combined accordingly.

Application

The resulting gripping force F_{Gr} , conditional on the application, depends on the gripping action (external/internal gripping) and the gripper design (with/without spring return). The spring force is supplemented in accordance with the design and gripping action.

	Single-acting	Supplementary gripping force	Gripping force retention
	<ul style="list-style-type: none"> • Gripping with spring force: $F_{Gr} = F_{Spring}$ • Gripping with pressure force: $F_{Gr} = F_{Grip} - F_{Spring}$ 	<ul style="list-style-type: none"> • Gripping with pressure and spring force: $F_{Gr} = F_{Grip} + F_{Spring}$ 	<ul style="list-style-type: none"> • Gripping with spring force: $F_{Gr} = F_{Spring}$

		Pressurised (in gripping action)	Unpressurised
HGP	Opening	$F_{Gr} = F_{Grip}$	$F_{Gr} = 0$
	Closing	$F_{Gr} = F_{Grip}$	$F_{Gr} = 0$
HGP-...-G1	Opening	$F_{Gr} = F_{Grip} + F_{Spring}$	$F_{Gr} = F_{Spring}$
	Closing	$F_{Gr} = F_{Grip} - F_{Spring}$	$F_{Gr} = 0$
HGP-...-G2	Opening	$F_{Gr} = F_{Grip} - F_{Spring}$	$F_{Gr} = 0$
	Closing	$F_{Gr} = F_{Grip} + F_{Spring}$	$F_{Gr} = F_{Spring}$

Parallel grippers HGP

Technical data

Gripping force F_{Grip} per gripper jaw at 6 bar as a function of lever arm x and eccentricity y

External and internal gripping (closing and opening)

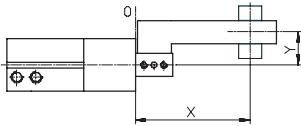

Gripping forces can be determined with the following diagrams for the various sizes at 6 bar in relation to

eccentric application of force (distance from the zero co-ordinate line shown opposite to the pressure point at

which the fingers grip the workpiece) and the maximum permissible off-centre point at which force is applied.

Calculation example

Given:

HGP-16-A-B

Lever arm $x = 20$ mm

Eccentricity $y = 22$ mm

To be found:

Gripping force at 6 bar

Procedure:

- Determine the intersection xy between lever arm x and eccentricity y in the graph for HGP-16-A-B
- Draw an arc (with centre at origin) through intersection xy
- Determine the intersection between the arc and the X axis
- Read the gripping force

Result:

Gripping force = approx. 66 N

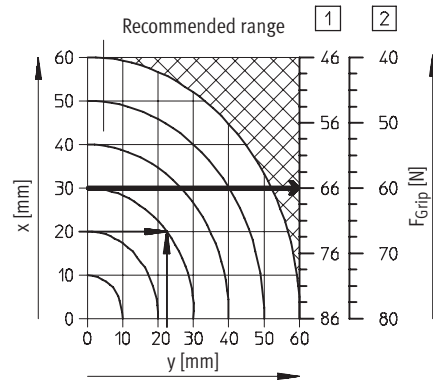

HGP-06-A

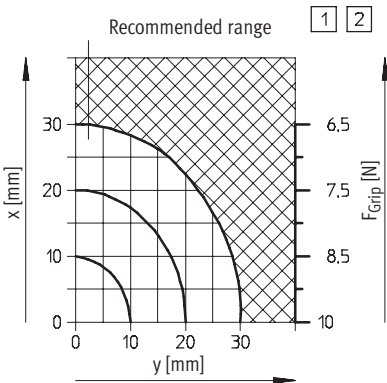

HGP-10-A-B

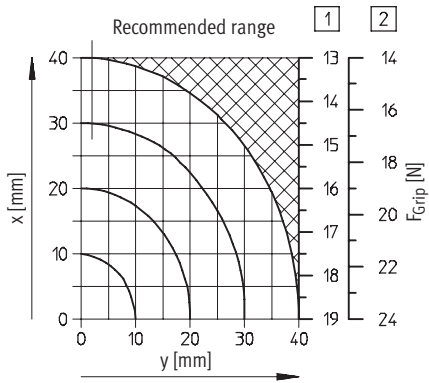

HGP-16-A-B

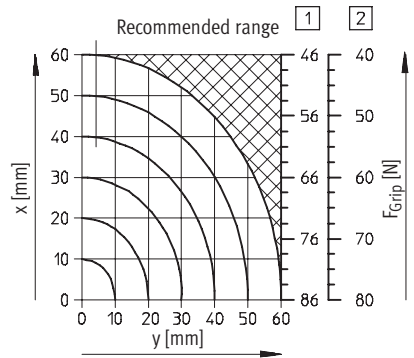

HGP-20-A

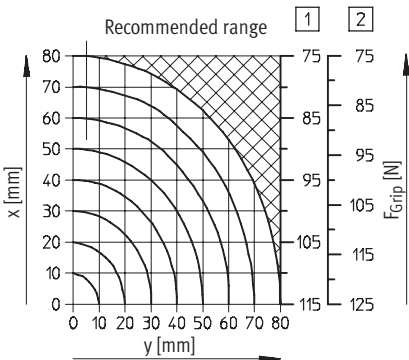

HGP-25-A-B

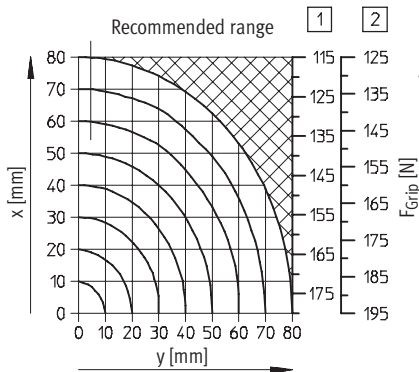

HGP-35-A-B

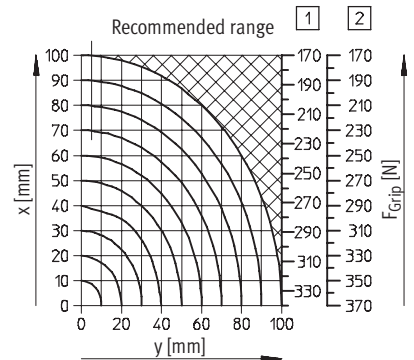

- 1 Closing
- 2 Opening

Parallel grippers HGP

Technical data

FESTO

Dimensions

Download CAD data → www.festo.com

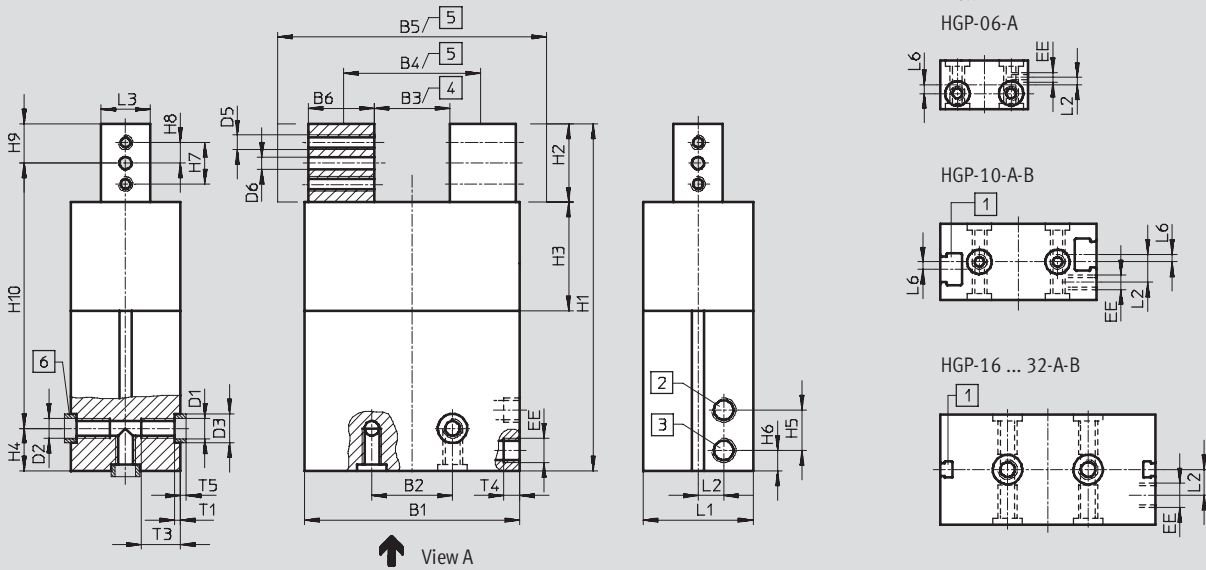

- | | |
|---|---|
| <p>1 Sensor slot for proximity sensor SME/SMT-8 (not with HGP-06-A). Proximity sensors SME/SMT-10 can also be used in combination with the sensor strip HGP-SL-... (can be glued into place).</p> | <p>2 Compressed air connection, opening</p> <p>3 Compressed air connection, closing</p> <p>4 Closed</p> <p>5 Open</p> <p>6 Centring sleeves ZBH (2 included in scope of delivery)</p> |
|---|---|

With protective dust cap HGP-...-SSK

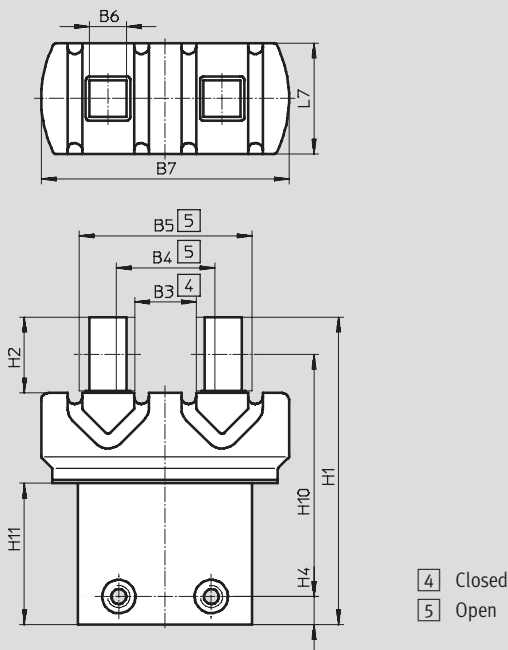

Parallel grippers HGP

Technical data

FESTO

Type	B1	B2 ¹⁾	B3	B4	B5	B6	B7	D1	D2	D3	D5	D6	EE	H1	H2	H3	H4 ²⁾
		±0.1	±0.5	±0.5	±0.5	-0.03	±0.5	∅		∅ H8/h7		∅ H8					±0.1
HGP-06-A	18	11	6	10	21	5.5	-	3.2	M3	5	M2	1.5	M3	45.5	9.9	10.2	7.5
HGP-10-A-B	32	16	15.8	21.8	35.8	7	-	3.2	M3	5	M3	2	M3	66	15	16	7.5
HGP-16-A-B	47	25	17.8	27.8	53.8	13	-	5.3	M4	7	M4	3	M3	80	20	21.9	7.5
HGP-20-A-B	55.6	25	17.4	30.4	65.4	17.5	-	5.3	M4	7	M4	4	M5	101	24.9	26.1	7.5
HGP-25-A-B	68.2	29	21	36	80	22	-	6.4	M6	9	M5	4	G $\frac{1}{8}$	121	30	32.2	17.5
HGP-35-A-B	88	33	31	56	110	27	-	8.4	M8	12	M6	5	G $\frac{1}{8}$	142	31.9	44.8	17.5
With protective dust cap																	
HGP-16-A-B-SSK	47	25	16.4	26.4	46.4	10	67	5.3	M4	7	M4	3	M3	83	20.5	21.9	7.5
HGP-25-A-B-SSK	68.2	29	21	36	66	15	101	6.4	M6	9	M5	4	G $\frac{1}{8}$	126.8	31.5	32.2	17.5

Type	H5	H6	H7	H8	H9	H10	H11	L1	L2	L3	L6	L7	T1	T3	T4	T5
						±0.2				-0.03			+0.1	+1	+0.5	-0.3
HGP-06-A	7	4	5.8	2.9	5	33	-	10	1.5	5	1.8	-	1.2	-	3.5	1.2
HGP-10-A-B	7	4	8	4	7.5	51	-	15.5	4.2	7	1.5	-	1.2	6	3.5	1.2
HGP-16-A-B	7	4	11	5.5	10	62.5	-	22	5.7	10	-	-	1.6	7.5	3.5	1.4
HGP-20-A-B	10.5	11.5	14	7	12.5	81	-	30	9	12	-	-	1.6	8	6	1.4
HGP-25-A-B	16.5	8.3	16	8	15	88.5	-	37	10.5	15	-	-	2.1	15	6.5	1.9
HGP-35-A-B	16.5	8.5	17	8.5	16	108.5	-	45	10.5	20	-	-	2.6	16	6.5	2.4
With protective dust cap																
HGP-16-A-B-SSK	7	4	11	5.5	10	65.5	38.1	22	5.7	10	-	30	1.6	7.5	3.5	1.4
HGP-25-A-B-SSK	16.5	8.3	16	8	15	94.3	58.8	37	10.5	15	-	47	2.1	15	6.5	1.9

1) Tolerance for centring hole: ±0.02

2) Tolerance for centring hole: -0.05

- | - Note: This product conforms to ISO 1179-1 and to ISO 228-1

- | - Note

Due to the distance H5 between the two air connections on types HGP-06/-10/-16 which measures 7 mm, only the following tube fittings can be used

- QSM-M3-3
- QSML-M3-3
- QSMLL-M3-3
- CN-M3-PK-3
- LCN-M3-PK-3

→ Internet: fitting

Parallel grippers HGP

Technical data

Ordering data						
Size [mm]	Double-acting Without compression spring		Gripper retention force G1 Opening		Gripper retention force G2 Closing	
	Part No.	Type	Part No.	Type	Part No.	Type
6	174 815	HGP-06-A	–		–	
10	197 542	HGP-10-A-B	197 543	HGP-10-A-B-G1	197 544	HGP-10-A-B-G2
16	197 545	HGP-16-A-B	197 546	HGP-16-A-B-G1	197 547	HGP-16-A-B-G2
20	525 889	HGP-20-A-B	525 890	HGP-20-A-B-G1	525 891	HGP-20-A-B-G2
25	197 548	HGP-25-A-B	197 549	HGP-25-A-B-G1	197 550	HGP-25-A-B-G2
35	197 551	HGP-35-A-B	197 552	HGP-35-A-B-G1	197 553	HGP-35-A-B-G2
With protective dust cap						
16	539 636	HGP-16-A-B-SSK	–		–	
25	539 635	HGP-25-A-B-SSK	–		–	

Ordering data – Wearing parts kits		
Size [mm]		
	Part No.	Type
6	378 516	HGP-06-A
10	397 376	HGP-10
16	397 377	HGP-16
20	397 378	HGP-20
25	397 397	HGP-25
32	397 380	HGP-35

Parallel grippers HGP

Accessories

FESTO

Sensor rail HGP-SL



can be glued into place

Material:

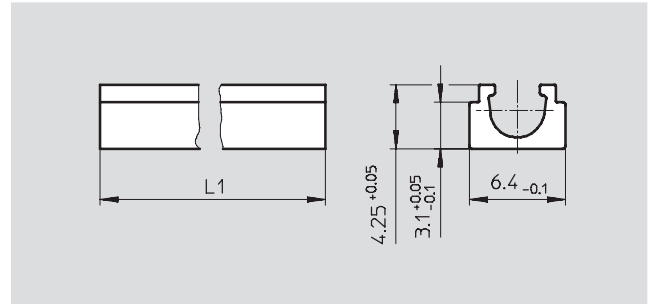
Wrought aluminium alloy

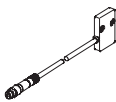

Dimensions and ordering data					
For size [mm]	L1	Weight [g]	Part No.	Type	
10	35	1.4	535 582	HGP-SL-10-10	
16	38	1.5	535 583	HGP-SL-10-16	
20	50	2.0	535 584	HGP-SL-10-20	
25	58	2.3	535 585	HGP-SL-10-25	
35	65	2.6	535 586	HGP-SL-10-35	

Ordering data						
Type	For size	Weight [g]	Part No.	Type	PU ¹⁾	
Position sensor SMH-S1						Technical data → Internet: smh-s1
	6	20	175 710	SMH-S1-HGP06	1	
Evaluation unit SMH-AE1						Technical data → Internet: smh-ae
	6	170	175 708	SMH-AE1-PS3-M12	1	
			175 709	SMH-AE1-NS3-M12		
Centring sleeve ZBH						Technical data → Internet: zbh
	6, 10	1	189 652	ZBH-5	10	
	16, 20		186 717	ZBH-7		
	25		150 927	ZBH-9		
	35		189 653	ZBH-12		

1) Packaging unit quantity

Installation instructions for position sensor SMH-S1

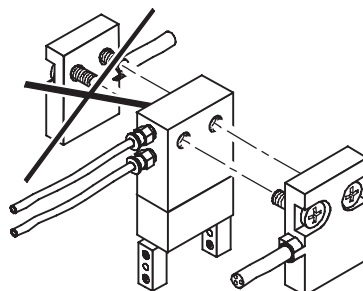

In order to ensure the correct functioning of the position sensor the outlet cables and the compressed air tubing must be mounted in the same direction.





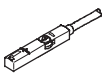

Parallel grippers HGP

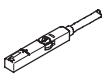
Accessories

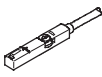
FESTO

Ordering data – Proximity sensors for T-slot, magneto-resistive						Technical data → Internet: smt
	Type of mounting	Switch output	Electrical connection	Cable length [m]	Part No.	Type
N/O contact						
	Insertable in the slot from above, flush with cylinder profile	PNP	Cable, 3-wire	2.5	543 867	SMT-8M-PS-24V-K-2,5-OE
			Plug M8x1, 3-pin	0.3	543 866	SMT-8M-PS-24V-K-0,3-M8D
			Plug M12x1, 3-pin	0.3	543 869	SMT-8M-PS-24V-K-0,3-M12
		NPN	Cable, 3-wire	2.5	543 870	SMT-8M-NS-24V-K-2,5-OE
			Plug M8x1, 3-pin	0.3	543 871	SMT-8M-NS-24V-K-0,3-M8D
			Plug M12x1, 3-pin	0.3	543 872	SMT-8M-NS-24V-K-0,3-M12
	Insertable in the slot lengthwise, flush with the cylinder profile	PNP	Cable, 3-wire	2.5	175 436	SMT-8-PS-K-LED-24-B
			Plug M8x1, 3-pin	0.3	175 484	SMT-8-PS-S-LED-24-B
N/C contact						
	Insertable in the slot from above, flush with cylinder profile	PNP	Cable, 3-wire	7.5	543 873	SMT-8M-PO-24V-K7,5-OE



Ordering data – Proximity sensors for T-slot, magnetic reed						Technical data → Internet: sme
	Type of mounting	Switch output	Electrical connection	Cable length [m]	Part No.	Type
N/O contact						
	Insertable in the slot from above, flush with cylinder profile	Contacting	Cable, 3-wire	2.5	543 862	SME-8M-DS-24V-K-2,5-OE
				5.0	543 863	SME-8M-DS-24V-K-5,0-OE
			Plug M8x1, 3-pin	2.5	543 872	SME-8M-ZS-24V-K-2,5-OE
				0.3	543 861	SME-8M-DS-24V-K-0,3-M8D
	Insertable in the slot lengthwise, flush with the cylinder profile	Contacting	Cable, 3-wire	2.5	150 855	SME-8-K-LED-24
			Plug M8x1, 3-pin	0.3	150 857	SME-8-S-LED-24
N/C contact						
	Insertable in the slot lengthwise, flush with the cylinder profile	Contacting	Cable, 3-wire	7.5	160 251	SME-8-O-K-LED-24



Ordering data – Connecting cables					Technical data → Internet: nebu
	Electrical connection, left	Electrical connection, right	Cable length [m]	Part No.	Type
	Straight socket, M8x1, 3-pin	Cable, open end, 3-wire	2.5	541 333	NEBU-M8G3-K-2.5-LE3
			5	541 334	NEBU-M8G3-K-5-LE3
	Straight socket, M12x1, 5-pin	Cable, open end, 3-wire	2.5	541 363	NEBU-M12G5-K-2.5-LE3
			5	541 364	NEBU-M12G5-K-5-LE3
	Angled socket, M8x1, 3-pin	Cable, open end, 3-wire	2.5	541 338	NEBU-M8W3-K-2.5-LE3
			5	541 341	NEBU-M8W3-K-5-LE3
	Angled socket, M12x1, 5-pin	Cable, open end, 3-wire	2.5	541 367	NEBU-M12W5-K-2.5-LE3
			5	541 370	NEBU-M12W5-K-5-LE3



Parallel grippers HGP

Accessories

FESTO

Ordering data – Proximity sensors for C-slot, magneto-resistive					Technical data → Internet: smt	
	Type of mounting	Switch output	Electrical connection, connection direction	Cable length [m]	Part No.	Type
N/O contact						
	Insertable in the slot from above, flush with cylinder profile	PNP	Cable, 3-wire, in-line	2.5	525 915	SMT-10F-PS-24V-K2,5L-OE
			Plug M8x1, 3-pin, in-line	0.3	525 916	SMT-10F-PS-24V-K0,3L-M8D
			Plug M8x1, 3-pin, lateral	0.3	526 675	SMT-10F-PS-24V-K0,3Q-M8D
	Insertable in the slot lengthwise	PNP	Plug M8x1, 3-pin, in-line	0.3	173 220	SMT-10-PS-SL-LED-24
			Cable, 3-wire, in-line	2.5	173 218	SMT-10-PS-KL-LED-24

Ordering data – Proximity sensors for C-slot, magnetic reed					Technical data → Internet: sme	
	Type of mounting	Switch output	Electrical connection, connection direction	Cable length [m]	Part No.	Type
N/O contact						
	Insertable in the slot from above, flush with cylinder profile	Contacting	Plug M8x1, 3-pin, in-line	0.3	525 914	SME-10F-DS-24V-K0,3L-M8D
			Cable, 3-wire, in-line	2.5	525 913	SME-10F-DS-24V-K2,5L-OE
			Cable, 2-wire, in-line	2.5	526 672	SME-10F-ZS-24V-K2,5L-OE
	Insertable in the slot lengthwise	Contacting	Plug M8x1, 3-pin, in-line	0.3	173 212	SME-10-SL-LED-24
			Cable, 3-wire, in-line	2.5	173 210	SME-10-KL-LED-24

Ordering data – Connecting cables				Technical data → Internet: nebu	
	Electrical connection, left	Electrical connection, right	Cable length [m]	Part No.	Type
	Straight socket, M8x1, 3-pin	Cable, open end, 3-wire	2.5	541 333	NEBU-M8G3-K-2.5-LE3
			5	541 334	NEBU-M8G3-K-5-LE3
	Angled socket, M8x1, 3-pin	Cable, open end, 3-wire	2.5	541 338	NEBU-M8W3-K-2.5-LE3
			5	541 341	NEBU-M8W3-K-5-LE3

Product Range and Company Overview

A Complete Suite of Automation Services

Our experienced engineers provide complete support at every stage of your development process, including: conceptualization, analysis, engineering, design, assembly, documentation, validation, and production.



Custom Automation Components
Complete custom engineered solutions



Custom Control Cabinets
Comprehensive engineering support and on-site services



Complete Systems
Shipment, stocking and storage services

The Broadest Range of Automation Components

With a comprehensive line of more than 30,000 automation components, Festo is capable of solving the most complex automation requirements.



Electromechanical
Electromechanical actuators, motors, controllers & drives



Pneumatics
Pneumatic linear and rotary actuators, valves, and air supply



PLCs and I/O Devices
PLC's, operator interfaces, sensors and I/O devices

Supporting Advanced Automation... As No One Else Can!

Festo is a leading global manufacturer of pneumatic and electromechanical systems, components and controls for industrial automation, with more than 12,000 employees in 56 national headquarters serving more than 180 countries. For more than 80 years, Festo has continuously elevated the state of manufacturing with innovations and optimized motion control solutions that deliver higher performing, more profitable automated manufacturing and processing equipment. Our dedication to the advancement of automation extends beyond technology to the education and development of current and future automation and robotics designers with simulation tools, teaching programs, and on-site services.

Quality Assurance, ISO 9001 and ISO 14001 Certifications

Festo Corporation is committed to supply all Festo products and services that will meet or exceed our customers' requirements in product quality, delivery, customer service and satisfaction.

To meet this commitment, we strive to ensure a consistent, integrated, and systematic approach to management that will meet or exceed the requirements of the ISO 9001 standard for Quality Management and the ISO 14001 standard for Environmental Management.



© Copyright 2008, Festo Corporation. While every effort is made to ensure that all dimensions and specifications are correct, Festo cannot guarantee that publications are completely free of any error, in particular typing or printing errors. Accordingly, Festo cannot be held responsible for the same. For Liability and Warranty conditions, refer to our "Terms and Conditions of Sale", available from your local Festo office. All rights reserved. No part of this publication may be reproduced, distributed, or transmitted in any form or by any means, electronic, mechanical, photocopying or otherwise, without the prior written permission of Festo. All technical data subject to change according to technical update.



Printed on recycled paper at New Horizon Graphic, Inc., FSC certified as an environmentally friendly printing plant.

Festo North America

Festo Regional Contact Center

5300 Explorer Drive
Mississauga, Ontario L4W 5G4
Canada

USA Customers:

For ordering assistance,

Call: 1.800.99.FESTO (1.800.993.3786)

Fax: 1.800.96.FESTO (1.800.963.3786)

Email: customer.service@us.festo.com

For technical support,

Call: 1.866.GO.FESTO (1.866.463.3786)

Fax: 1.800.96.FESTO (1.800.963.3786)

Email: product.support@us.festo.com

Canadian Customers:

Call: 1.877.GO.FESTO (1.877.463.3786)

Fax: 1.877.FX.FESTO (1.877.393.3786)

Email: festo.canada@ca.festo.com

USA Headquarters

Festo Corporation
395 Moreland Road
P.O. Box 18023
Hauppauge, NY 11788, USA
www.festo.com/us

USA Sales Offices

Appleton

North 922 Tower View Drive, Suite N
Greenville, WI 54942, USA

Boston

120 Presidential Way, Suite 330
Woburn, MA 01801, USA

Chicago

1441 East Business Center Drive
Mt. Prospect, IL 60056, USA

Dallas

1825 Lakeway Drive, Suite 600
Lewisville, TX 75057, USA

Detroit – Automotive Engineering Center

2601 Cambridge Court, Suite 320
Auburn Hills, MI 48326, USA

New York

395 Moreland Road
Hauppauge, NY 11788, USA

Silicon Valley

4935 Southfront Road, Suite F
Livermore, CA 94550, USA

United States



USA Headquarters, East: Festo Corp., 395 Moreland Road, Hauppauge, NY 11788

Phone: 1.631.435.0800; Fax: 1.631.435.8026;

Email: info@festo-usa.com

www.festo.com/us

Canada



Headquarters: Festo Inc., 5300 Explorer Drive, Mississauga, Ontario L4W 5G4

Phone: 1.905.624.9000; Fax: 1.905.624.9001;

Email: festo.canada@ca.festo.com

www.festo.ca

Mexico



Headquarters: Festo Pneumatic, S.A., Av. Ceylán 3, Col. Tequesquahuac,
54020 Tlalneantla, Edo. de México

Phone: 011 52 [55] 53 21 66 00; Fax: 011 52 [55] 53 21 66 65;

Email: festo.mexico@mx.festo.com

www.festo.com/mx

Central USA

Festo Corporation
1441 East Business
Center Drive
Mt. Prospect, IL 60056, USA
Phone: 1.847.759.2600
Fax: 1.847.768.9480



Western USA

Festo Corporation
4935 Southfront Road,
Suite F
Livermore, CA 94550, USA
Phone: 1.925.371.1099
Fax: 1.925.245.1286



Festo Worldwide

Argentina Australia Austria Belarus Belgium Brazil Bulgaria Canada Chile China Colombia Croatia Czech Republic Denmark
Estonia Finland France Germany Great Britain Greece Hong Kong Hungary India Indonesia Iran Ireland Israel Italy Japan Latvia
Lithuania Malaysia Mexico Netherlands New Zealand Norway Peru Philippines Poland Romania Russia Serbia Singapore
Slovakia Slovenia South Africa South Korea Spain Sweden Switzerland Taiwan Thailand Turkey Ukraine United States Venezuela

www.festo.com