

Compact cylinders ADN/AEN, to ISO 21287



Compact cylinders ADN/AEN, to ISO 21287

Key features



Sensor slots on three sides for flush mounting of proximity sensors

Piston rod with choice of male or female thread

Mounting option: Female thread and through-hole

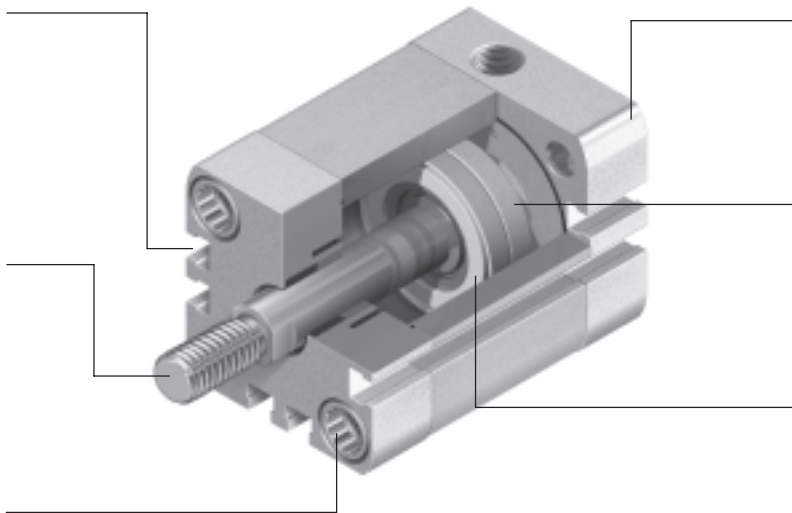

Centring hole in the end cap matches centring pins ZBS

Magnet for contactless position sensing

Integrated cushioning rings for absorbing residual energy at high speeds and machine cycles

More than the standard

- Series ADN/AEN compact cylinders comply with the standard ISO 21287
- The ADN/AEN is distinguished by its compact design and broad area of application thanks to the large number of variants
- The variants can be configured according to individual needs thanks to the modular product system

Powerful

- Flexible cushioning rings as standard for absorbing the residual energy facilitate high speeds and machine cycles
- Long service life thanks to exceptional cushioning characteristics and minimal friction factors
- The ADNP with bearing and end caps made of polymer and integrated QS push-in fittings is distinguished by its low weight

Convenient

- Easy to mount with a comprehensive range of mounting accessories for just about every type of installation
- Highly flexible thanks to the wide range of variants
- Contactless position sensing using proximity sensors

Reliable

- Optimised manufacturing methods, patented technology and more than 40 years of experience in the field of cylinders make Festo and ADN/AEN a great team

Mounting options

With through screw

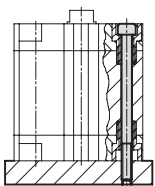

Direct mounting

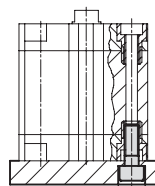

Size

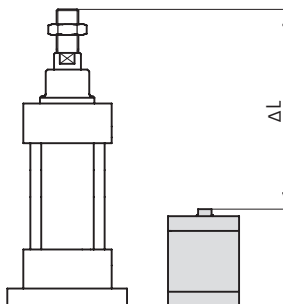

















- Space savings of up to 50% compared with the standard ISO 15552

Compact cylinders ADN, to ISO 21287

Key features

FESTO

Variants from the modular system		
Symbol	Key features	Description
	S1 Reinforced piston rod	Increased lateral forces. Absorbs many times more lateral force than a basic cylinder
	S2 Through piston rod	For working at both ends with the same forces in the advance and return stroke, for attaching external stops
	S6 Heat-resistant seals	Temperature resistance up to max. 120 °C
	S10 Constant (slow speed) operation at low piston speeds	Suitable for slow stroke movements at a constant, judder-free speed over the full stroke of the cylinder. Seal contains silicone grease (not free of paint-wetting impairment substances)
	S11 Low friction	The special seals considerably reduce system wear. This corresponds to a considerably lower response pressure. Seal contains silicone grease (not free of paint-wetting impairment substances)
	S20 Through, hollow piston rod	For carrying vacuum, small parts, media, etc.
	K2 Extended male piston rod thread	–
	K5 Special piston rod thread	Metric standard thread to ISO
	K8 Extended piston rod	–
	K10 Smooth anodised aluminium piston rod	Ideal for use in welding environments: – Protection against welding spatter – Small moving loads – Harder surface compared to steel – Long service life
	KP With clamping unit	Integrated clamping unit on the piston rod
	EL With end position lock	Positive lock in the end position as drop guard. If there is a drop in pressure, the piston rod is secured in its end position to prevent it from dropping
	Q Square piston rod	Protection against torsion. For correctly oriented feeding
	R3 High corrosion protection	All external cylinder surfaces comply with corrosion resistance class 3 to Festo standard 940 070. The piston rod is made from corrosion and acid resistant steel
	R8 Dust protection (wiper seal)	The cylinder is equipped with a hard-chrome plated piston rod and a rigid wiper seal, which protects against dry, dusty media
	TL Captive rating plate	Laser etched rating plate. For easy identification when it comes to replacement, even after years in a harsh environment
	TT Low temperature	Temperature resistance up to max. –40 °C







Note

Software tools and configuration of Festo product modules
→ www.festo.com

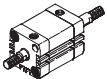
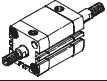
Compact cylinders ADN, to ISO 21287

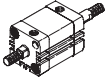
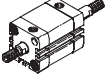
Product range overview

FESTO

Function	Version	Type	Piston Ø	Stroke	Position sensing	Cushioning	
			[mm]	[mm]			
Double-acting	Basic version						
		ADN	12	5, 10, 15, 20, 25, 30, 40	1 ... 300	■	■
			16	5, 10, 15, 20, 25, 30, 40, 50	1 ... 300		
			20, 25	5, 10, 15, 20, 25, 30, 40, 50, 60	1 ... 300		
			32, 40, 50	5, 10, 15, 20, 25, 30, 40, 50, 60, 80	1 ... 400		
			63	10, 15, 20, 25, 30, 40, 50, 60, 80	1 ... 400		
			80, 100	10, 15, 20, 25, 30, 40, 50, 60, 80	1 ... 500		
			125	–	1 ... 500		
		ADN-...-S2 Through piston rod	12, 16, 20, 25	–	1 ... 300	■	■
			32, 40, 50, 63	–	1 ... 400		
			80, 100, 125	–	1 ... 500		
		ADN-...-S20 Through, hollow piston rod	16, 20, 25	–	1 ... 300	■	■
			32, 40, 50, 63	–	1 ... 400		
			80, 100, 125	–	1 ... 500		
	Reinforced piston rod						
		ADN-...-S1	25	–	5 ... 300	■	■
			40, 63	–	10 ... 400		
			100	–	10 ... 500		
	Non-rotating with square piston rod						
		ADN-...-Q	12, 16, 20, 25	–	1 ... 300	■	■
			32, 40, 50, 63	–	1 ... 400		
			80, 100, 125	–	1 ... 500		
		ADN-...-Q-S2 Through piston rod	12, 16, 20, 25	–	1 ... 300	■	■
			32, 40, 50, 63	–	1 ... 400		
			80, 100, 125	–	1 ... 500		
		ADN-...-Q-S20 Through, hollow piston rod	16, 20, 25	–	1 ... 200	■	■
			32, 40, 50, 63, 80	–	1 ... 300		
			100, 125	–	1 ... 400		
Standard port pattern, with clamping unit							
	ADN-...-KP	20, 25	–	10 ... 300	■	■	
		32, 40, 50, 63	–	10 ... 400			
		80, 100	–	10 ... 500			
Standard port pattern, with end position lock							
	ADN-...-EL	20, 25	–	10 ... 300	■	■	
		32, 40, 50, 63	–	10 ... 400			
		80, 100	–	10 ... 500			
With polymer end cap							
	ADNP	20, 25	5, 10, 15, 20, 25, 30, 40, 50, 60	–	■	■	
		32, 40, 50	10, 15, 20, 25, 30, 40, 50, 60, 80	–			

Compact cylinders ADN, to ISO 21287

Product range overview



FESTO

Type	Male piston rod thread	Female piston rod thread	Extended male piston rod thread	Special thread	Extended piston rod	Smooth anodised piston rod	Heat-resistant seals up to max. 120 °C	Slow speed (constant motion)	Low friction	High corrosion protection	Dust protection	Low temperature	→ Page/Internet
	A	I	K2	K5	K8	K10	S6	S10	S11	R3	R8	TT	
Basic version													
ADN	■	■	■	■	■	■ Ø 20 and above	■	■	■	■	■ Ø 20 and above	■ Ø 20 ... 100	13
ADN-...-S2 Through piston rod	■	■	■	■	■	-	■	-	-	-	-	■ Ø 20 ... 100	13
ADN-...-S20 Through, hollow piston rod	■	-	■	■	■	-	■	-	-	-	-	-	13
Reinforced piston rod													
ADN-...-S1	■	■	■	■	■	-	■	-	-	■	-	-	13
Non-rotating with square piston rod													
ADN-...-Q	■	■	■	■	■	-	■	-	-	-	-	-	13
ADN-...-Q-S2 Through piston rod	■	■	■	■	■	-	■	-	-	-	-	-	13
ADN-...-Q-S20 Through, hollow piston rod	■	-	■	■	■	-	■	-	-	-	-	-	13
Standard port pattern, with clamping unit													
ADN-...-KP	■	■	■	■	■	-	-	-	-	-	-	-	38
Standard port pattern, with end position lock													
ADN-...-EL	■	■	■	■	■	-	-	-	-	-	-	-	47
With polymer end cap													
ADNP	■	■	-	-	-	-	-	-	-	-	-	-	73

Compact cylinders ADN, to ISO 21287

Product range overview

FESTO

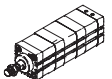
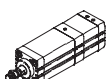
Function	Version	Type	Piston \varnothing	Stroke	Position sensing	Cushioning	
			[mm]				[mm]
Double-acting	Standard port pattern, non-rotating with yoke						
		ADNGF	12	5, 10, 15, 20, 25, 30, 40	1 ... 200	■	■
			16	5, 10, 15, 20, 25, 30, 40, 50	1 ... 200		
			20, 25	5, 10, 15, 20, 25, 30, 40, 50, 60	3 ... 200		
			32, 40, 50	5, 10, 15, 20, 25, 30, 40, 50, 60, 80	5 ... 300		
			63, 80	10, 15, 20, 25, 30, 40, 50, 60, 80	5 ... 300		
			100	10, 15, 20, 25, 30, 40, 50, 60, 80	5 ... 400		
		ADNGF-...-S2 Through piston rod	12, 16	–	1 ... 200	■	■
			20, 25		3 ... 200		
			32, 40, 50, 63, 80, 100		5 ... 250		
	Standard port pattern, high-force cylinder						
		ADNH	25	–	1 ... 150	■	■
			40				
			63				
100							
Standard port pattern, multi-position cylinder							
	ADNM	25	–	1 ... 2000	■	■	
		40					
		63					
		100					

Compact cylinders ADN, to ISO 21287



Product range overview

Type	Male piston rod thread	Female piston rod thread	Extended male piston rod thread	Special thread	Extended piston rod	Heat-resistant seals up to max. 120 °C	→ Page/Internet
	A	I	K2	K5	K8	S6	
Standard port pattern, non-rotating with yoke							
ADNGF	-	-	-	-	-	■	adngf
ADNGF-...-S2 Through piston rod	-	-	-	-	-	■	adngf
Standard port pattern, high-force cylinder							
ADNH	■	■	■	■	■	■	23
Standard port pattern, multi-position cylinder							
ADNM	■	■	■	■	■	■	8

Compact cylinders AEN, to ISO 21287

Product overview

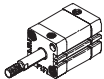

Function	Version	Type	Piston \varnothing	Stroke	Position sensing	Cushioning
			[mm]	[mm]	A	P
Single-acting	Basic version					
		AEN	12	1 ... 10	■	■
			16, 20, 25, 32, 40, 50, 63, 80, 100	1 ... 25		
		AEN-...-Z pulling	12	1 ... 10	■	■
			16, 20, 25, 32, 40, 50, 63, 80, 100	1 ... 25		
	Non-rotating with square piston rod					
	AEN-...-Q	16	1 ... 25	■	■	
		20, 25, 32, 40, 50, 63, 80, 100	1 ... 25			

Compact cylinders AEN, to ISO 21287

Product overview

Type	Male piston rod thread	Female piston rod thread	Extended male piston rod thread	Special piston rod thread	Extended piston rod	Smooth anodised piston rod	Heat-resistant seals up to max. 120 °C	→ Page/Internet
	A	I	K2	K5	K8	K10	S6	
Basic version								
AEN	■	■	■	■	■	■ Ø 20 and above	■	57
AEN-...-Z pulling	■	■	■	■	■	■ Ø 20 and above	■	57
Non-rotating with square piston rod								
AEN-...-Q	■	■	■	■	■	-	■	57

Compact cylinders ADN/AEN, to ISO 21287

Peripherals overview

FESTO

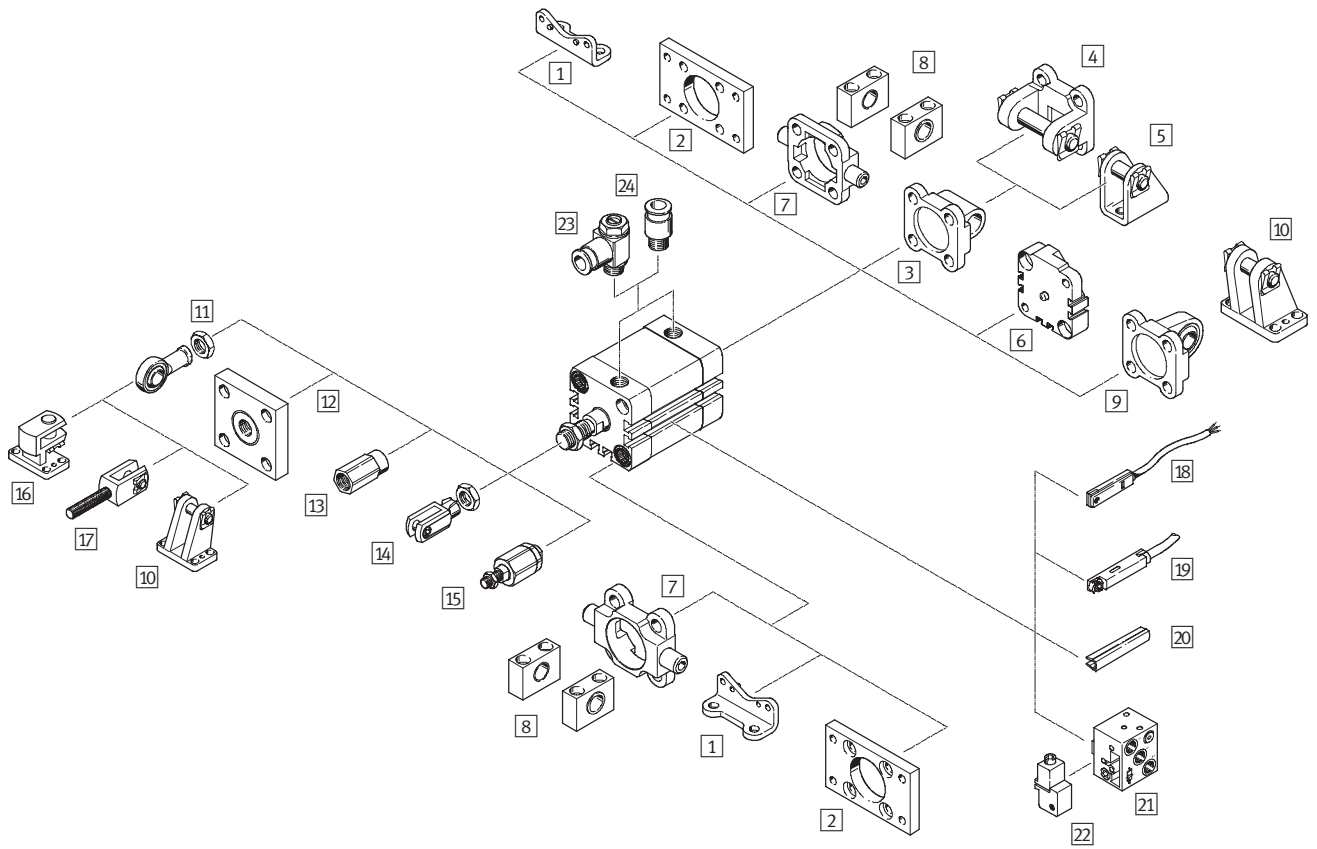

Compact cylinders ADN/AEN, to ISO 21287

Peripherals overview

FESTO

Mounting attachments and accessories		
	Brief description	→ Page/Internet
1	Foot mounting HNA	For bearing or end caps 77
2	Flange mounting FNC	For bearing or end caps 78
3	Swivel flange SNCL	For end caps 79
4	Swivel flange SNCB	For swivel flange SNCL 83
5	Clevis foot LBN/CRLBN	For swivel flange SNCL 82
6	Multi-position kit DPNA	For connecting two cylinders with identical piston \varnothing to form a multi-position cylinder 81
7	Trunnion flange ZNCF/CRZNG	For bearing caps 84
8	Trunnion support LNZG	For trunnion flange ZNCF/CRZNG 85
9	Swivel flange SNCS	For end caps 80
10	Clevis foot LBG	For swivel flange SNCS 80
11	Rod eye SGS/CRSGS	With spherical bearing 86
12	Coupling piece KSG/KSZ	For compensating radial deviations 86
13	Adapter AD	For mounting a vacuum suction cup on a hollow cylinder piston rod 86
14	Rod clevis SG/CRSG	Permits a swivelling movement of the cylinder in one plane 86
15	Self-aligning rod coupler FK	For compensating radial and angular deviations 86
16	Right-angle clevis foot LQG	For rod eye SGS 87
17	Rod clevis SGA	With male thread 86
18	Proximity sensor SME/SMT-8	Can be integrated in the sensor slot of the cylinder profile barrel 89
19	Proximity sensor SME/SMT-8M	Can be integrated in the sensor slot of the cylinder profile barrel 89
20	Slot cover ABP-5-S	For protecting the sensor cable and keeping dirt out of the sensor slots 89
21	Proximity sensor SMPO-8E	Pneumatic output signal 89
22	Mounting kit SMB-8E	For proximity sensor SMPO-8E 89
23	One-way flow control valve GRLA/GRLZ	For speed regulation 87
24	Push-in fitting QS	For connecting compressed air tubing with standard external diameters quick star

Compact cylinders ADN, to ISO 21287

Type codes

FESTO

ADN – 50 – 50 – A – P – A – S2

Type	
Double-acting	
ADN	Compact cylinder

Piston Ø [mm]	
---------------	--

Stroke [mm]	
-------------	--

Piston rod thread	
A	Male thread
I	Female thread

Cushioning	
P	Flexible cushioning rings/pads at both ends

Position sensing	
A	Via proximity sensor

Variant	
Q	Square piston rod
S1	Reinforced piston rod
S2	Through piston rod
S20	Through, hollow piston rod
K2	Extended male piston rod thread
K5	Special piston rod thread
K8	Extended piston rod
K10	Smooth anodised piston rod
S6	Heat-resistant seals up to max. 120 °C
S10	Slow speed (constant motion)
S11	Low friction
R3	High corrosion protection
R8	Dust protection
TL	Captive rating plate (laser etched)
TT	Low temperature

Compact cylinders ADN, to ISO 21287

Technical data

Function

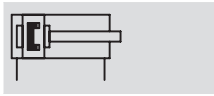

Variants → 3



Ø - Diameter
12 ... 125 mm

Stroke length
1 ... 500 mm

www.festo.com/en/Spare_parts_service

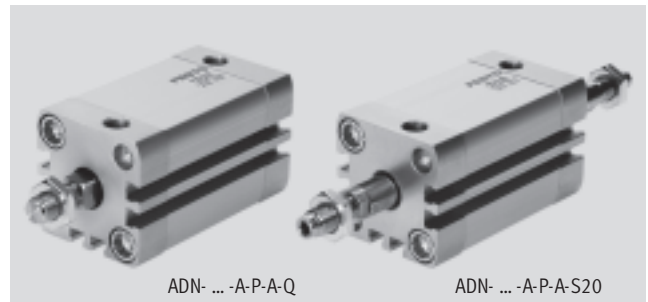
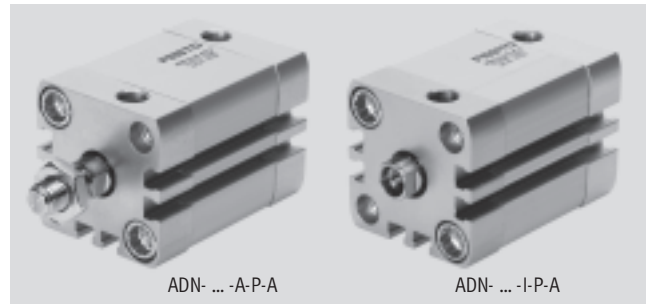

General technical data											
Piston Ø	12	16	20	25	32	40	50	63	80	100	125
Constructional design	Piston										
	Piston rod										
	Cylinder barrel										
Cushioning	Flexible cushioning rings/pads at both ends										
Position sensing	Via proximity sensor										
Type of mounting	Via through-holes										
	Via female threads										
	Via accessories										
Mounting position	Any										

Technical data – Basic version and variants							
Piston Ø	12	16	20	25	32	40	
Pneumatic connection	M5	M5	M5	M5	G $\frac{1}{8}$	G $\frac{1}{8}$	
Female piston rod thread	M3	M4	M6	M6	M8	M8	
	K5	–	–	M5	M5	M6	M6
Male piston rod thread	M5	M6	M8	M8	M10x1.25	M10x1.25	
	K5	M6	M8	M10, M10x1.25	M10, M10x1.25	M10, M12	M10, M12
Max. torsional backlash of piston rod [°]	Q 2	1.8	1.6	1.6	1.2	1.2	

Piston Ø	50	63	80	100	125
Pneumatic connection	G $\frac{1}{8}$	G $\frac{1}{8}$	G $\frac{1}{8}$	G $\frac{1}{8}$	G $\frac{1}{4}$
Female piston rod thread	M10	M10	M12	M12	M16
	K5	M8	M8	M10	M10
Male piston rod thread	M12x1.25	M12x1.25	M16x1.5	M16x1.5	M20x1.5
	K5	M12, M16	M12, M16	M16, M20	M16, M20, M20x1.5
Max. torsional backlash of piston rod [°]	Q 1	1	0.8	0.8	0.8

Compact cylinders ADN, to ISO 21287

Technical data

FESTO

Technical data – Variant S1					
Piston Ø		25	40	63	100
Pneumatic connection		M5	M5	G1/8	G1/8
Piston rod thread	Female	M6	M10	M12	M16
	Male	M8	M12x1.25	M16x1.5	M20x1.5
Special thread variant K5	Female	M5	M8	M10	–
	Male	M10, M10x1.25	M10x1.25, M12	M12x1.25, M16	M16x1.5, M20

Operating and environmental conditions														
Piston Ø		12	16	20	25	32	40	50	63	80	100	125		
Operating medium		Filtered compressed air, lubricated or unlubricated												
Operating pressure [bar]		1 ... 10			0.6 ... 10									
	Q	1.3 ... 10			1 ... 10			0.8 ... 10			0.6 ... 10			
	S1	–			1 ... 10		–		1 ... 10		–		1 ... 10	–
	S2, S20	1.5 ... 10		1.3 ... 10	1.2 ... 10			1 ... 10			0.8 ... 10			
	S6	1 ... 10			0.6 ... 10									
	S11	0.45 ... 10					0.25 ... 10							
	R8, TT	–			1,5 ... 10				1 ... 10				–	
Ambient temperature ¹⁾ [°C]		–20 ... +80												
	S6	0 ... +120												
	R3	–20 ... +80												
	TT	–			–40 ... +80						–			
Corrosion resistance class CRC ²⁾		2												
	R3	3												
ATEX		Specified types → www.festo.com												

1) Note operating range of proximity sensors

2) Corrosion resistance class 2 to Festo standard 940 070

Components subject to moderate corrosion stress. Externally visible parts with primarily decorative surface requirements which are in direct contact with a normal industrial environment or media such as coolants or lubricating agents

Corrosion resistance class 3 to Festo standard 940 070

Components with heavy corrosion exposure. Externally visible components in direct contact with normal industrial atmosphere or media such as solvents and cleaning agents, where the surface requirement is predominantly functional.

Forces [N] and impact energy [J]												
Piston Ø		12	16	20	25	32	40	50	63	80	100	125
Theoretical force at 6 bar, advancing		68	121	188	295	483	754	1178	1870	3016	4712	7363
	S1	–	–	–	295	–	754	–	1870	–	4712	–
	S2	51	90	141	247	415	686	1057	1750	2827	4524	7069
Theoretical force at 6 bar, retracting		51	90	141	247	415	686	1057	1750	2827	4524	7069
	S1	–	–	–	247	–	633	–	1681	–	4417	–
	S2	51	90	141	247	415	686	1057	1750	2827	4524	7069
Max. impact energy at the end positions		0.07	0.15	0.2	0.3	0.4	0.7	1	1.3	1.8	2.5	3.3
	S1	–	–	–	0.3	–	0.7	–	1.3	–	2.5	–
	S6	0.035	0.075	0.1	0.15	0.2	0.35	0.5	0.65	0.9	1.25	1.75
	K10	–	–	0.16	0.24	0.32	0.56	0.8	1	1.4	2	2.6
	S20	–	0.016	0.024	0.083	0.15	0.39	0.48	0.62	0.8	0.9	0.95

Permissible impact velocity:

$$v_{\text{perm.}} = \sqrt{\frac{2 \times E_{\text{perm.}}}{m_{\text{dead}} + m_{\text{load}}}}$$

$v_{\text{perm.}}$ Permissible impact velocity

$E_{\text{perm.}}$ Max. impact energy

m_{dead} Moving load (drive)

m_{load} Moving work load

Note

These specifications represent the maximum values which can be reached. Note the maximum permitted impact energy.

Maximum permissible load:

$$m_{\text{load}} = \frac{2 \times E_{\text{perm.}}}{v^2} - m_{\text{dead}}$$

Compact cylinders ADN, to ISO 21287

Technical data

Max. lateral force F_q as a function of the projection x

Ø 12 ... 63

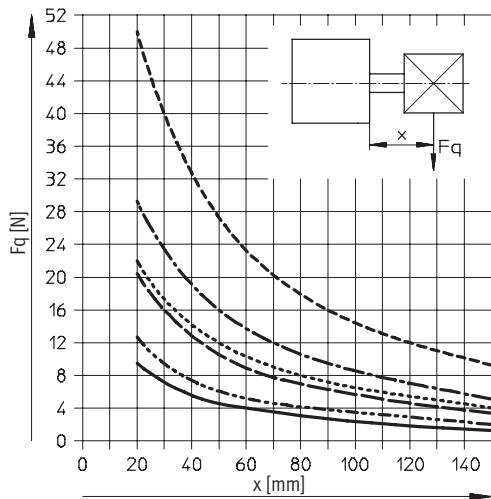

- Ø 12
- · - · - · Ø 16
- - - - - Ø 20
- · - · - · Ø 25
- - - - - Ø 32/40
- · - · - · Ø 50/63

Ø 80 ... 125

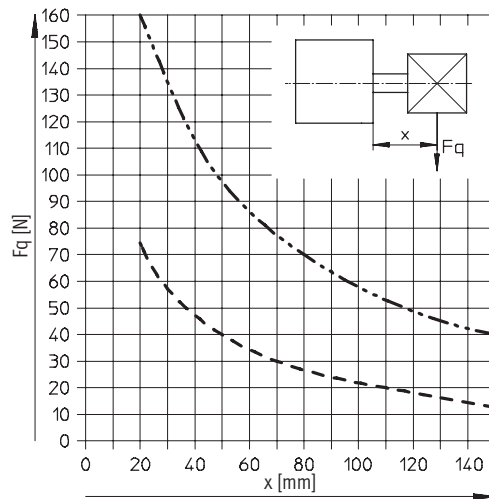

- - - - - Ø 80/100
- · - · - · Ø 125

Compact cylinders ADN, to ISO 21287

Technical data

FESTO

Max. lateral force F_q as a function of the projection x and the lever arm a

Q – Square piston rod

Ø 12

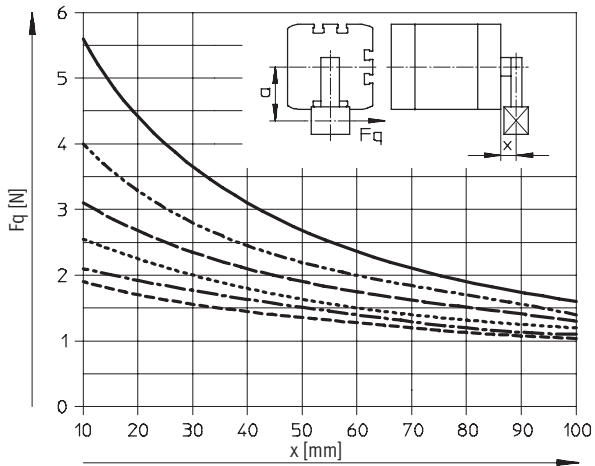

- a = 5 mm
- - - a = 10 mm
- - - a = 15 mm
- · - a = 20 mm
- · - a = 25 mm
- · - a = 30 mm

Ø 16

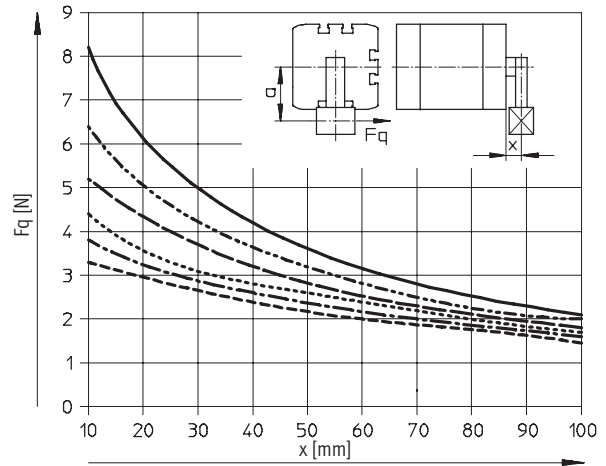

- a = 5 mm
- - - a = 10 mm
- - - a = 15 mm
- · - a = 20 mm
- · - a = 25 mm
- · - a = 30 mm

Ø 20/25

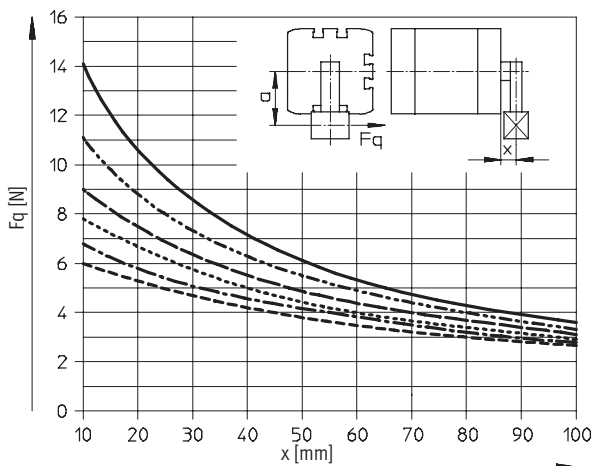

- a = 5 mm
- - - a = 10 mm
- - - a = 15 mm
- · - a = 20 mm
- · - a = 25 mm
- · - a = 30 mm

Ø 32/40

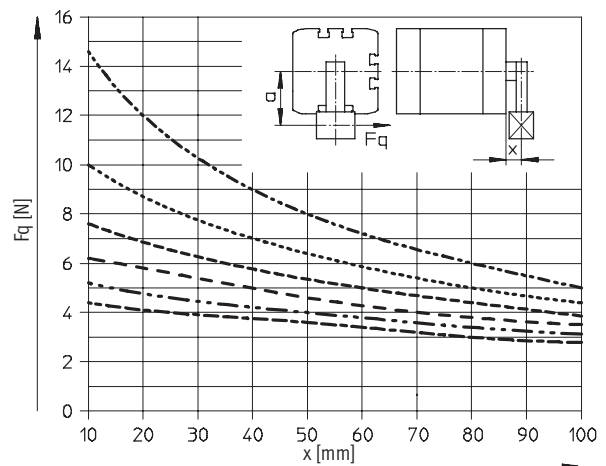

- · - a = 10 mm
- · - a = 20 mm
- - - a = 30 mm
- - - a = 40 mm
- · - a = 50 mm
- · - a = 60 mm

Note

- Torques on the piston rod are to be excluded with projections greater than those shown in the graphs.
- If $a = 0$, the corresponding lateral load line of the basic ADN version can be used (→ 15).

Compact cylinders ADN, to ISO 21287

Technical data

FESTO

Max. lateral force F_q as a function of the projection x and the lever arm a

Q – Square piston rod

Ø 50/63

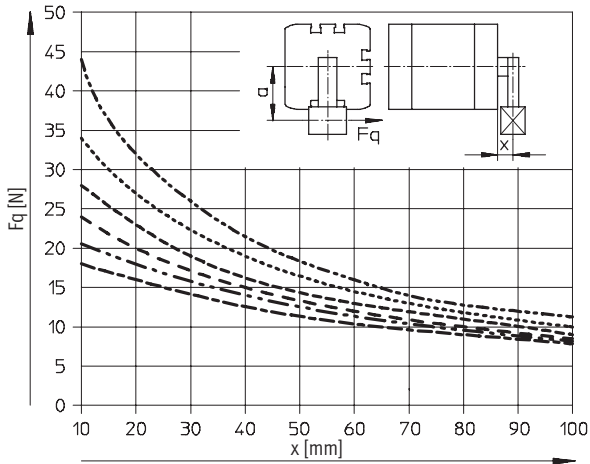

- a = 10 mm
- a = 20 mm
- a = 30 mm
- a = 40 mm
- a = 50 mm
- a = 60 mm

Ø 80/100

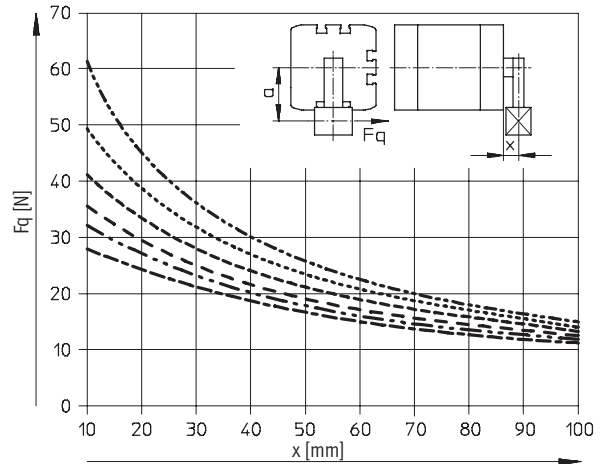

- a = 10 mm
- a = 20 mm
- a = 30 mm
- a = 40 mm
- a = 50 mm
- a = 60 mm

Ø 125

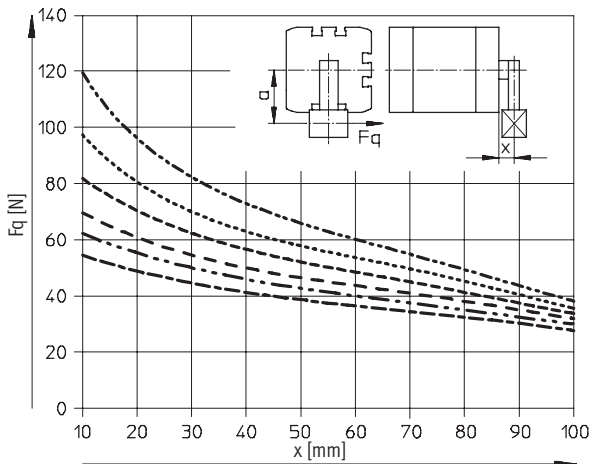

- a = 10 mm
- a = 20 mm
- a = 30 mm
- a = 40 mm
- a = 50 mm
- a = 60 mm

Note

- Torques on the piston rod are to be excluded with projections greater than those shown in the graphs.
- If $a = 0$, the corresponding lateral load line of the basic ADN version can be used (→ 15).

Compact cylinders ADN, to ISO 21287

Technical data

FESTO

Max. lateral force F_q as a function of the projection x

S1 – Reinforced piston rod

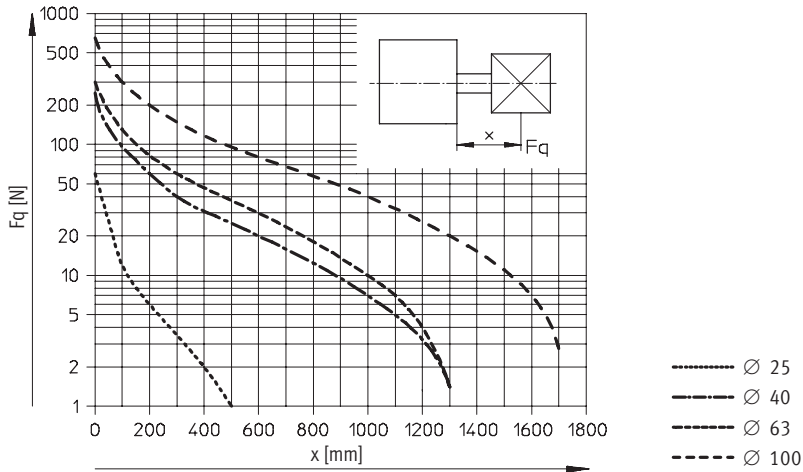

Weight [g]

Piston Ø	12	16	20	25	32	40	50	63	80	100	125
Product weight with 0 mm stroke	77	79	131	156	265	346	540	722	1300	2154	2880
Additional weight per 10 mm stroke	12	14	21	23	30	37	51	59	79	98	117
Moving load with 0 mm stroke	9	15	30	50	60	80	140	180	400	570	1080
Additional load per 10 mm stroke	2	4	6	6	9	9	16	16	25	25	39

Materials

Sectional view

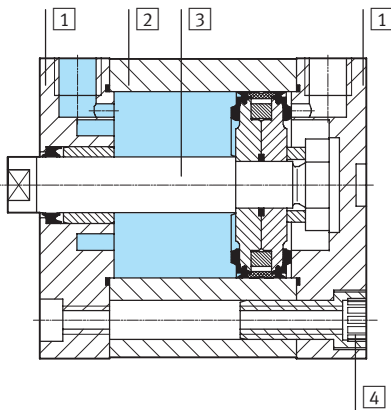

Compact cylinder	Basic version, Q	R8	S6, S10, S11	R3	K10
1 Cover	Anodised aluminium				
2 Cylinder barrel	Anodised aluminium				
3 Piston rod	High-alloy steel	Tempered steel, hard-chromium plated	High-alloy steel		Anodised aluminium
4 Flange screws	Ø 12 ... 16	High-alloy steel		High-alloy steel	–
	Ø 20 ... 25	Galvanised steel		High-alloy steel	Galvanised steel
	Ø 32 ... 63	Galvanised steel		Steel, zinc flake coating	Galvanised steel
	Ø 80 ... 125	Standard screws, galvanised steel		Standard screws, high-alloy steel	Standard screws, galvanised steel
– Seals	Polyurethane		Fluoro elastomer	Polyurethane	

Compact cylinders ADN, to ISO 21287

Technical data



Dimensions – Basic version

Download CAD Data → www.festo.com/us/cad

Ø 12 ... 63

Ø 32 ... 63

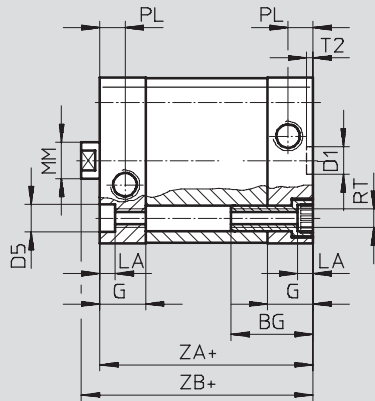
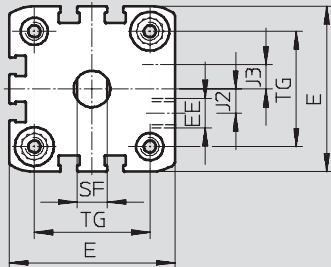

Ø 12 ... 25

Ø 12

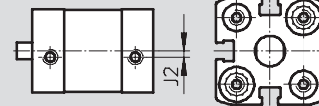

+ = plus stroke length

Ø 80 ... 125

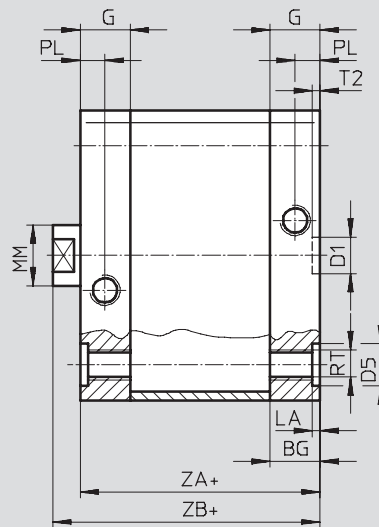
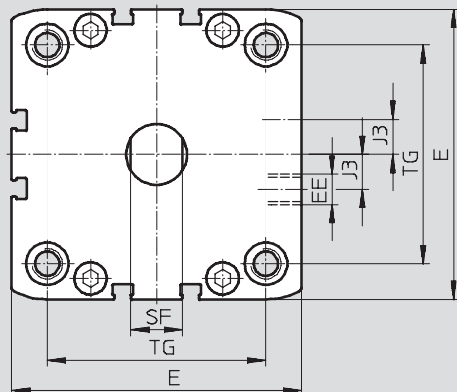

+ = plus stroke length

Ø [mm]	BG min.	D1 Ø H9	D5 Ø F9	E	EE	G	J2	J3	LA +0.2	MM Ø h8	PL +0.2	RT	SF h13	T2 +0.1	TG ±0.2	ZA ±0.3	ZB +1.2	
12	17	9	6	27.5 ^{+0.3}	M5	10.5	2	-	3.5	6	6	M4	5	2.1	16	35	39.2	
16				29 ^{+0.3}		11	2.6	8	7	18			39.7					
20	19.5		9	35.5 ^{+0.3}		12		10	9	22	37	42.5						
25				39.5 ^{+0.3}		6	12	32.5	44	50								
32	26	12	9	47 ^{+0.3}	G ³ / ₈	15	8	5	12	16	8.2	M6	10	2.6	38	45	51.1	
40				54.5 ^{+0.3}			16	10	46.5	53.2								
50	27		12	15			65.5 ^{+0.3}	16.5	11.5	2.6	20	16	M8		13	56.5	49	57.1
63							75.5 ^{+0.3}	21.5							20	89	67	76
80	17	21.5	-	95.5 ^{+0.6}	G ¹ / ₄	20	21.15	-	25	10.5	M10	17	72	54	62.9			
100	113.5 ^{+0.6}			21								89	67	76				
125	20			110								81	92					

Compact cylinders ADN, to ISO 21287

Technical data

FESTO

Dimensions – Variants

Download CAD Data → www.festo.com/us/cad

Basic version

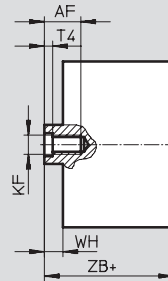
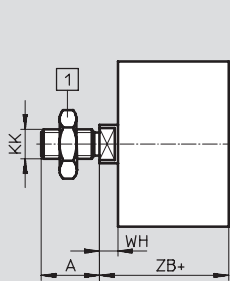

1 Hex nut to DIN 439-B
only with $\varnothing 32 \dots 125$

+ = plus stroke length

S2 – Through piston rod

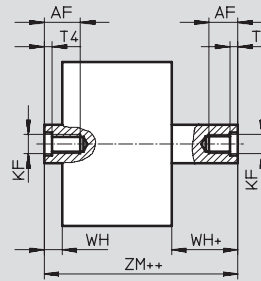
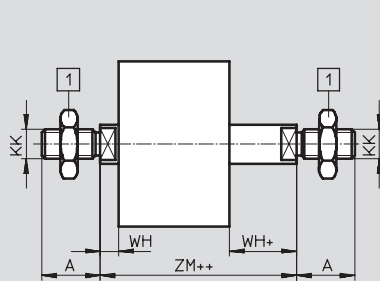

1 Hex nut to DIN 439-B
only with $\varnothing 32 \dots 125$

+ = plus stroke length

++ = plus 2x stroke length

S20 – Through, hollow piston rod

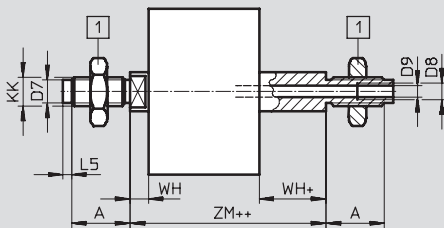

Note

Piston rod extension is performed at one end in combination with the S2/S20 variants.

1 Hex nut to DIN 439-B
only with $\varnothing 32 \dots 125$

+ = plus stroke length

++ = plus 2x stroke length

K2 – Extended male piston rod thread

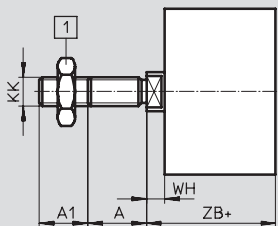

1 Hex nut to DIN 439-B
only with $\varnothing 32 \dots 125$

+ = plus stroke length

K5 – Special piston rod thread

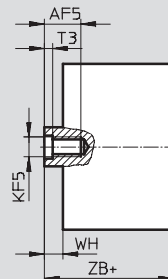
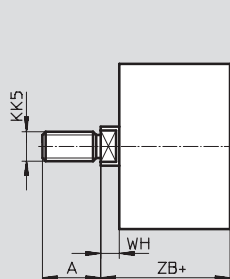

+ = plus stroke length

Compact cylinders ADN, to ISO 21287

Technical data

FESTO

Dimensions – Variants

Download CAD Data → www.festo.com/us/cad

K8 – Extended piston rod

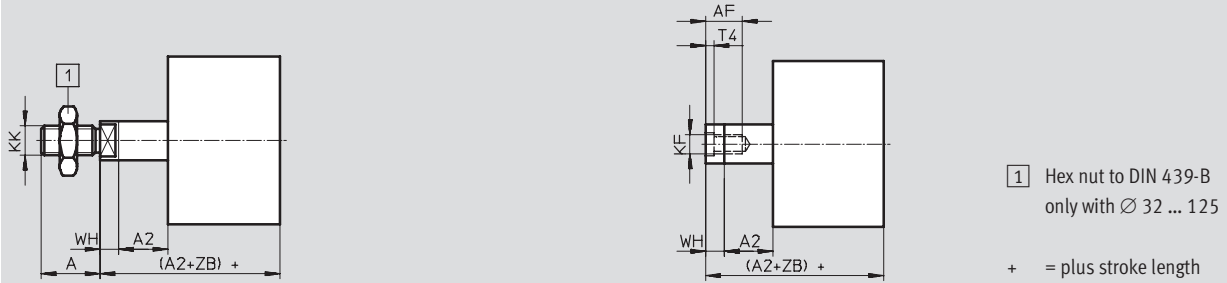

R8 – Dust protection / TT – Low temperature

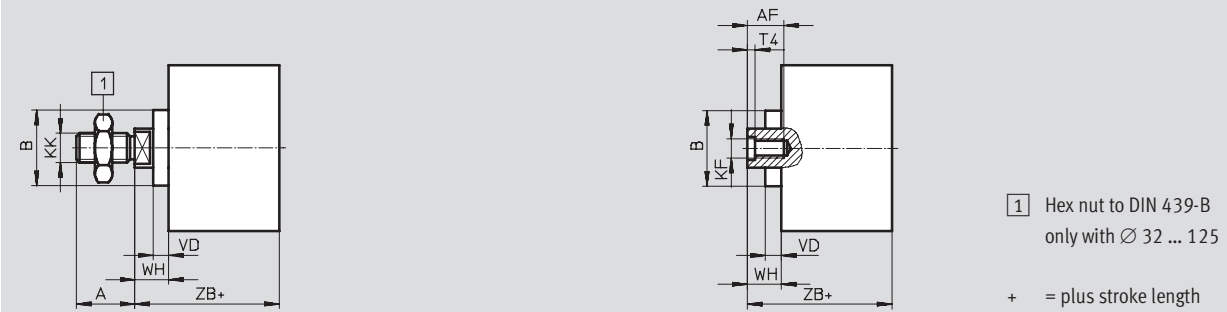

\varnothing	A	A1	A2	AF	AF5	B	D7	D8	D9	L5	KF
[mm]	-0.5			min.	min.	\varnothing	\varnothing		\varnothing		
12	10	1 ... 10	1 ... 300	8	-	-	-	-	-	-	M3
16	12			10			4.5		3.2	3	M4
20	16	1 ... 20		14	12	18	6		3.8	2	M6
25											
32	19	1 ... 20	1 ... 400	16	14	27	8	-	4.5	3	M8
40											
50	22	1 ... 30	1 ... 500	20	16	31	10	G $\frac{1}{8}$	6	3.5	M10
63											
80	28	1 ... 30	1 ... 500	20	20	35	-	G $\frac{1}{8}$	8	-	M12
100											
125	40	1 ... 40		25	-	-	-	G $\frac{1}{4}$	11.7		M16

\varnothing	KF5	KK	KK5	T3	T4	VD	WH		ZB		ZM
[mm]							+1.3	+1.2			
								R8/TT	R8/TT		
12	-	M5	M6	-	1.5	-	4.2	-	39.2	-	44.5 ^{+0.5}
16		M6	M8				4.7		39.7		45.7 ^{+0.5}
20	M5	M8	M10x1.25 M10	2	2.6	5.2	5.5	10.5	42.5	47.5	49.5 ^{+0.5}
25											
32	M6	M10x1.25	M10 M12	2.6	3.3	6.4	6	12.5	50	56.5	57.5 ^{+0.5}
40											
50	M8	M12x1.25	M12 M16	3.3	4.7	6.4	8.2	14.7	53.2	59.7	62.8 ^{+0.6}
63											
80	M10	M16x1.5	M16 M20x1.5 M20	4.7	6.1	6.4	8.9	15.4	62.9	69.4	73.2 ^{+0.6}
100											
125	-	M20x1.5	M20	-	7	-	11	-	92	-	104.4 ^{+0.6}

Compact cylinders ADN, to ISO 21287

Technical data

FESTO

Dimensions – Variants

Download CAD Data → www.festo.com/us/cad

Q – Square piston rod

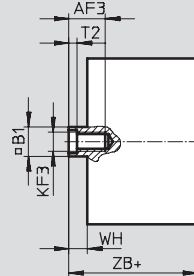
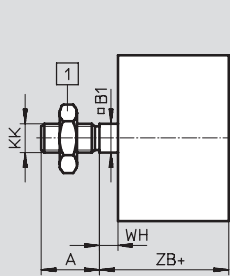

1 Hex nut to DIN 439-B only with $\varnothing 32 \dots 125$

+ = plus stroke length

Q-S2 – Square, through piston rod

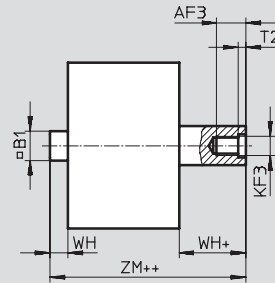
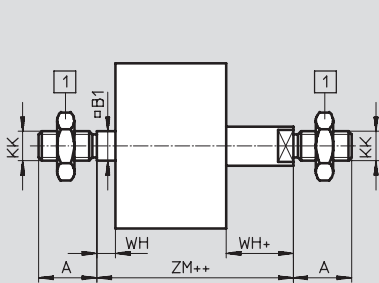

1 Hex nut to DIN 439-B only with $\varnothing 32 \dots 125$

+ = plus stroke length

++ = plus 2x stroke length

Q-S20 – Square, through, hollow piston rod

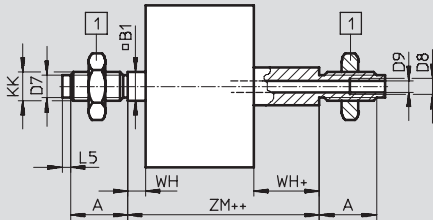

Note

Piston rod extension is performed at one end at the square piston rod in combination with the S2/S20 variants.

1 Hex nut to DIN 439-B only with $\varnothing 32 \dots 125$

+ = plus stroke length

++ = plus 2x stroke length

Q-K2 – Square, extended male piston rod thread

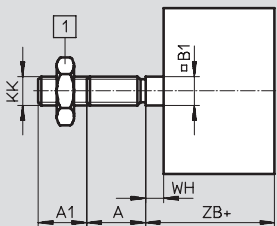

1 Hex nut to DIN 439-B only with $\varnothing 32 \dots 125$

+ = plus stroke length

Q-K5 – Square, special piston rod thread

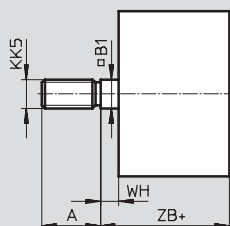

+ = plus stroke length

Compact cylinders ADN, to ISO 21287

Technical data

FESTO

Dimensions – Variants

Download CAD Data → www.festo.com/us/cad

Q-K8 – Square, extended piston rod

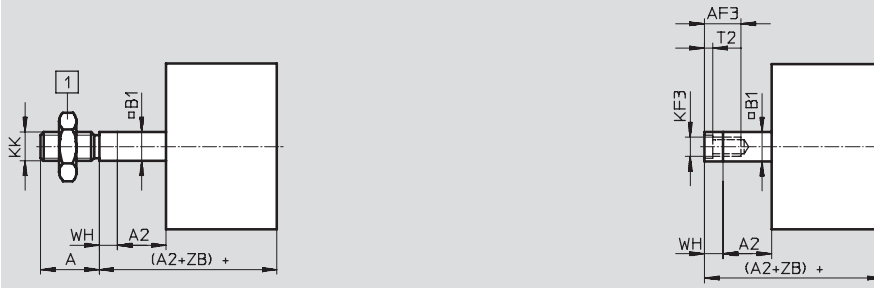

1 Hex nut to DIN 439-B
only with \varnothing 32 ... 125

+ = plus stroke length

\varnothing	A	A1	A2	AF3	B1	D7	D8	D9
[mm]	-0.5			min.	\square	\varnothing		\varnothing
12	10	1 ... 10	1 ... 300	8	5.5	-	-	-
16	12			10	7	4.5		3.2
20	16	12		9	6	3.8		
25	19	1 ... 20	1 ... 400	14	10	8	-	4.5
32				16	12	10		6
40				22	20	12		8
50	28	30		16	10	6		
63	28	1 ... 30	1 ... 500	20	16	-	G $\frac{1}{8}$	8
80				24	20	G $\frac{1}{4}$	11.7	
100		40		40				
125								

\varnothing	L5	KF3	KK	KK5	T2	WH	ZB	ZM
[mm]						+1.3	+1.2	
12	-	M3	M5	M6	1.5	4.2	39.2	44.5 ^{+0.5}
16	3	M4	M6	M8		4.7	39.7	45.7 ^{+0.5}
20	2	M5	M8	M10x1.25 M10	2	5.5	42.5	49.5 ^{+0.5}
25						44.5	51.5 ^{+0.5}	
32	3	M6	M10x1.25	M10	2.6	6	50	57.5 ^{+0.5}
40						6.1	51.1	58.6 ^{+0.6}
50	3.5	M8	M12x1.25	M16	3.3	8.2	53.2	62.8 ^{+0.6}
63						8.1	57.1	66.6 ^{+0.6}
80						8.9	62.9	73.2 ^{+0.6}
100	-	M10	M16x1.5	M16	4.7	9	76	86.4 ^{+0.6}
125						M12	M20x1.5	M20

Compact cylinders ADN, to ISO 21287

Technical data

FESTO

Dimensions – Variants

Download CAD Data → www.festo.com/us/cad

S1 – Reinforced piston rod

∅ 25

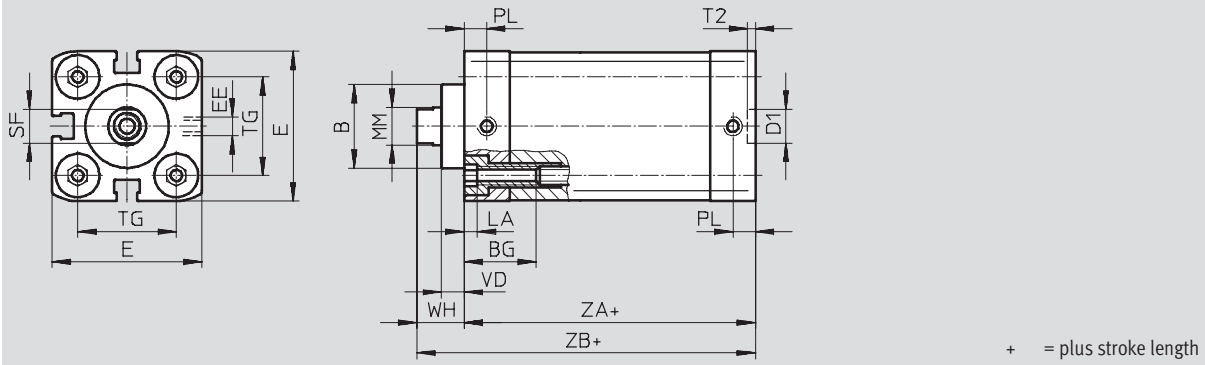

∅ 40 ... 100

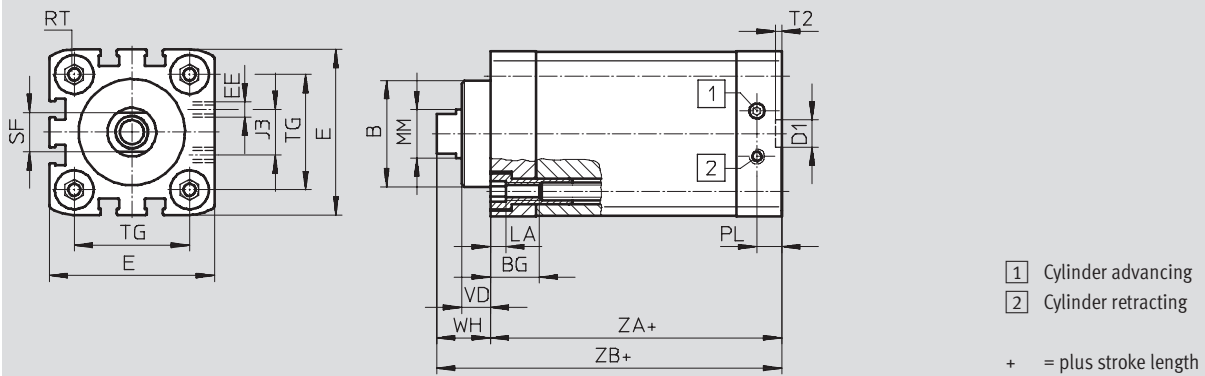

∅ [mm]	B ∅ f8	BG min.	D1 ∅ H9	E	EE	J3	LA	MM ∅ h9	PL
25	22	15	9	39.5 ^{+0.3}	M5	–	5	10	6
40	35	16		54.5 ^{+0.3}		15		8.2	
63	42	17	12	75.5 ^{+0.3}	G1/8	23	20		
100	55			113.5 ^{+0.6}		40	25	10.5	

∅ [mm]	RT	SF h13	T2	TG	VD	WH	ZA	ZB
			+0.1	±0.2		+1.3	±0.3	+1.2
25	M5	9	2.1	26	6	11.8	39	50.9
40	M6	13		38	9.5	18	45	62.9
63	M8	17	2.6	56.5	12	21	49	70.2
100	M10	21		89	15.5	26.5	67	93.5

Compact cylinders ADN, to ISO 21287

Technical data

FESTO

Dimensions – Variants

Download CAD Data → www.festo.com/us/cad

S1 – Reinforced piston rod

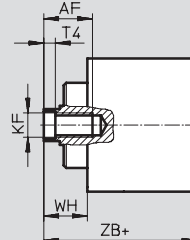
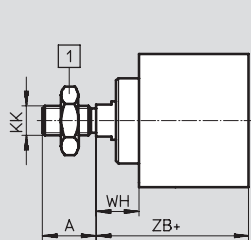

1 Hex nut to DIN 439-B only with \varnothing 40 ... 100

+ = plus stroke length

S1-K2 – Reinforced piston rod with extended male piston rod thread

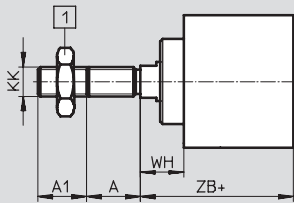

1 Hex nut to DIN 439-B only with \varnothing 40 ... 100

+ = plus stroke length

S1-K5 – Reinforced piston rod with special piston rod thread

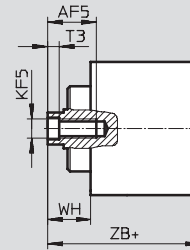
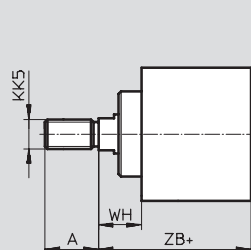

1 Hex nut to DIN 439-B only with \varnothing 40 ... 100

+ = plus stroke length

S1-K8 – Reinforced piston rod with extended piston rod

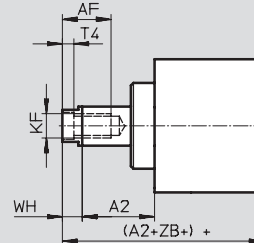
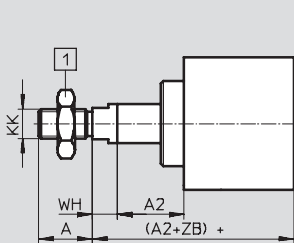

1 Hex nut to DIN 439-B only with \varnothing 40 ... 100

+ = plus stroke length

\varnothing	A	A1	A2	AF	AF5	KF	KF5	KK	KK5	T3	T4	WH	ZB
[mm]	-0.5			min.	min.							+1.3	+1.2
25	16	1 ... 20	1 ... 300	14	12	M6	M5	M8	M10x1.25 M10	2	2.6	11.8	50.9
40	22		1 ... 400	20	16	M10	M8	M12x1.25	M10x1.25 M12	3.3	4.7	18	62.9
63	28				20	M12	M10	M16x1.5	M12x1.25 M16	4.7	6.1	21	70.2
100	40	1 ... 30	1 ... 500	25	-	M16	-	M20x1.5	M16x1.5 M20	-	7	26.5	93.5

Compact cylinders ADN, to ISO 21287

Technical data

FESTO

Ordering data						
Type	Piston Ø [mm]	Stroke [mm]	Female piston rod thread		Male piston rod thread	
			Part No.	Type	Part No.	Type
	12	5	536 211	ADN-12-5-I-P-A	536 204	ADN-12-5-A-P-A
		10	536 212	ADN-12-10-I-P-A	536 205	ADN-12-10-A-P-A
		15	536 213	ADN-12-15-I-P-A	536 206	ADN-12-15-A-P-A
		20	536 214	ADN-12-20-I-P-A	536 207	ADN-12-20-A-P-A
		25	536 215	ADN-12-25-I-P-A	536 208	ADN-12-25-A-P-A
		30	536 216	ADN-12-30-I-P-A	536 209	ADN-12-30-A-P-A
		40	536 217	ADN-12-40-I-P-A	536 210	ADN-12-40-A-P-A
		16	5	536 226	ADN-16-5-I-P-A	536 219
	10		536 227	ADN-16-10-I-P-A	536 220	ADN-16-10-A-P-A
	15		536 228	ADN-16-15-I-P-A	536 221	ADN-16-15-A-P-A
	20		536 229	ADN-16-20-I-P-A	536 222	ADN-16-20-A-P-A
	25		536 230	ADN-16-25-I-P-A	536 223	ADN-16-25-A-P-A
	30		536 231	ADN-16-30-I-P-A	536 224	ADN-16-30-A-P-A
	40		536 232	ADN-16-40-I-P-A	536 225	ADN-16-40-A-P-A
	50		536 341	ADN-16-50-I-P-A	536 331	ADN-16-50-A-P-A
	20	5	536 242	ADN-20-5-I-P-A	536 234	ADN-20-5-A-P-A
		10	536 243	ADN-20-10-I-P-A	536 235	ADN-20-10-A-P-A
		15	536 244	ADN-20-15-I-P-A	536 236	ADN-20-15-A-P-A
		20	536 245	ADN-20-20-I-P-A	536 237	ADN-20-20-A-P-A
		25	536 246	ADN-20-25-I-P-A	536 238	ADN-20-25-A-P-A
		30	536 247	ADN-20-30-I-P-A	536 239	ADN-20-30-A-P-A
		40	536 248	ADN-20-40-I-P-A	536 240	ADN-20-40-A-P-A
		50	536 249	ADN-20-50-I-P-A	536 241	ADN-20-50-A-P-A
		60	536 362	ADN-20-60-I-P-A	536 352	ADN-20-60-A-P-A
	25	5	536 259	ADN-25-5-I-P-A	536 251	ADN-25-5-A-P-A
		10	536 260	ADN-25-10-I-P-A	536 252	ADN-25-10-A-P-A
		15	536 261	ADN-25-15-I-P-A	536 253	ADN-25-15-A-P-A
		20	536 262	ADN-25-20-I-P-A	536 254	ADN-25-20-A-P-A
25		536 263	ADN-25-25-I-P-A	536 255	ADN-25-25-A-P-A	
30		536 264	ADN-25-30-I-P-A	536 256	ADN-25-30-A-P-A	
40		536 265	ADN-25-40-I-P-A	536 257	ADN-25-40-A-P-A	
50		536 266	ADN-25-50-I-P-A	536 258	ADN-25-50-A-P-A	
60		536 383	ADN-25-60-I-P-A	536 373	ADN-25-60-A-P-A	
32	5	536 278	ADN-32-5-I-P-A	536 268	ADN-32-5-A-P-A	
	10	536 279	ADN-32-10-I-P-A	536 269	ADN-32-10-A-P-A	
	15	536 280	ADN-32-15-I-P-A	536 270	ADN-32-15-A-P-A	
	20	536 281	ADN-32-20-I-P-A	536 271	ADN-32-20-A-P-A	
	25	536 282	ADN-32-25-I-P-A	536 272	ADN-32-25-A-P-A	
	30	536 283	ADN-32-30-I-P-A	536 273	ADN-32-30-A-P-A	
	40	536 284	ADN-32-40-I-P-A	536 274	ADN-32-40-A-P-A	
	50	536 285	ADN-32-50-I-P-A	536 275	ADN-32-50-A-P-A	
	60	536 286	ADN-32-60-I-P-A	536 276	ADN-32-60-A-P-A	
	80	536 287	ADN-32-80-I-P-A	536 277	ADN-32-80-A-P-A	

Compact cylinders ADN, to ISO 21287

Technical data

FESTO

Ordering data						
Type	Piston Ø [mm]	Stroke [mm]	Female piston rod thread		Male piston rod thread	
			Part No.	Type	Part No.	Type
	40	5	536 299	ADN-40-5-I-P-A	536 289	ADN-40-5-A-P-A
		10	536 300	ADN-40-10-I-P-A	536 290	ADN-40-10-A-P-A
		15	536 301	ADN-40-15-I-P-A	536 291	ADN-40-15-A-P-A
		20	536 302	ADN-40-20-I-P-A	536 292	ADN-40-20-A-P-A
		25	536 303	ADN-40-25-I-P-A	536 293	ADN-40-25-A-P-A
		30	536 304	ADN-40-30-I-P-A	536 294	ADN-40-30-A-P-A
		40	536 305	ADN-40-40-I-P-A	536 295	ADN-40-40-A-P-A
		50	536 306	ADN-40-50-I-P-A	536 296	ADN-40-50-A-P-A
		60	536 307	ADN-40-60-I-P-A	536 297	ADN-40-60-A-P-A
	80	536 308	ADN-40-80-I-P-A	536 298	ADN-40-80-A-P-A	
	50	5	536 320	ADN-50-5-I-P-A	536 310	ADN-50-5-A-P-A
		10	536 321	ADN-50-10-I-P-A	536 311	ADN-50-10-A-P-A
		15	536 322	ADN-50-15-I-P-A	536 312	ADN-50-15-A-P-A
		20	536 323	ADN-50-20-I-P-A	536 313	ADN-50-20-A-P-A
		25	536 324	ADN-50-25-I-P-A	536 314	ADN-50-25-A-P-A
		30	536 325	ADN-50-30-I-P-A	536 315	ADN-50-30-A-P-A
		40	536 326	ADN-50-40-I-P-A	536 316	ADN-50-40-A-P-A
		50	536 327	ADN-50-50-I-P-A	536 317	ADN-50-50-A-P-A
		60	536 328	ADN-50-60-I-P-A	536 318	ADN-50-60-A-P-A
	80	536 329	ADN-50-80-I-P-A	536 319	ADN-50-80-A-P-A	
	63	10	536 342	ADN-63-10-I-P-A	536 332	ADN-63-10-A-P-A
		15	536 343	ADN-63-15-I-P-A	536 333	ADN-63-15-A-P-A
		20	536 344	ADN-63-20-I-P-A	536 334	ADN-63-20-A-P-A
		25	536 345	ADN-63-25-I-P-A	536 335	ADN-63-25-A-P-A
		30	536 346	ADN-63-30-I-P-A	536 336	ADN-63-30-A-P-A
		40	536 347	ADN-63-40-I-P-A	536 337	ADN-63-40-A-P-A
		50	536 348	ADN-63-50-I-P-A	536 338	ADN-63-50-A-P-A
		60	536 349	ADN-63-60-I-P-A	536 339	ADN-63-60-A-P-A
	80	10	536 363	ADN-80-10-I-P-A	536 353	ADN-80-10-A-P-A
		15	536 364	ADN-80-15-I-P-A	536 354	ADN-80-15-A-P-A
		20	536 365	ADN-80-20-I-P-A	536 355	ADN-80-20-A-P-A
		25	536 366	ADN-80-25-I-P-A	536 356	ADN-80-25-A-P-A
30		536 367	ADN-80-30-I-P-A	536 357	ADN-80-30-A-P-A	
40		536 368	ADN-80-40-I-P-A	536 358	ADN-80-40-A-P-A	
50		536 369	ADN-80-50-I-P-A	536 359	ADN-80-50-A-P-A	
60		536 370	ADN-80-60-I-P-A	536 360	ADN-80-60-A-P-A	
100	10	536 384	ADN-100-10-I-P-A	536 374	ADN-100-10-A-P-A	
	15	536 385	ADN-100-15-I-P-A	536 375	ADN-100-15-A-P-A	
	20	536 386	ADN-100-20-I-P-A	536 376	ADN-100-20-A-P-A	
	25	536 387	ADN-100-25-I-P-A	536 377	ADN-100-25-A-P-A	
	30	536 388	ADN-100-30-I-P-A	536 378	ADN-100-30-A-P-A	
	40	536 389	ADN-100-40-I-P-A	536 379	ADN-100-40-A-P-A	
	50	536 390	ADN-100-50-I-P-A	536 380	ADN-100-50-A-P-A	
	60	536 391	ADN-100-60-I-P-A	536 381	ADN-100-60-A-P-A	
80	536 392	ADN-100-80-I-P-A	536 382	ADN-100-80-A-P-A		

Compact cylinders ADN, to ISO 21287

Ordering data – Modular products, basic version and variants

M Mandatory data →

Module No.	Function	Stroke	Cushioning
	Piston Ø	Piston rod thread	Position sensing
536 203	ADN	12	P
536 218		16	
536 233		20	
536 250		25	
536 267		32	
536 288		40	
Order example			
536 309	ADN	40	250 - A - P - A

Ordering table										
Size	12	16	20	25	32	40	Condition s	Code	Enter Code	
M Module No.	536 203	536 218	536 233	536 250	536 267	536 288				
Function	Compact cylinder, double-acting, based on ISO 21287							ADN		ADN
Piston Ø [mm]	12	16	20	25	32	40		-...		
Stroke [mm]	1 ... 300				1 ... 400			-...		
Piston rod thread	Male thread							-A		
	Female thread						1	-I		
Cushioning	Flexible cushioning rings/pads at both ends							-P		-P
Position sensing	Via proximity sensor							-A		-A

1 I Not with piston rod type S20
Not with extended male thread K2

Transfer order code

ADN - - - - **P** - - **A**

Compact cylinders ADN, to ISO 21287

Ordering data – Modular products, basic version and variants



Options									
Type of piston rod		Special thread		Improved running performance		Corrosion protection		Low temperature	
Male thread extended		Piston rod extended		Temperature resistance		Captive rating plate		Wiper seal	
S2 S20	...K2	"...K5	...K8	K10	S6	R3	TL	TT	R8
- S2	- 15K2	- "M16"K5	- 50K8	-	- S6	-	-	-	-

Ordering table										
Size	12	16	20	25	32	40	Conditions	Code	Enter Code	
Type of piston rod [mm]	Through piston rod						[2]	-S2		
	Through, hollow piston rod						[2]	-S20		
Male thread extended [mm]	Extended male piston rod thread							-...K2		
Special piston rod thread	Male thread	M6	M8	M10x1,25 M10	M10x1,25 M10	M10 M12	M10 M12	"...K5		
	Female thread	-	-	M5	M5	M6	M6			
Piston rod extended [mm]	Extended piston rod						[3]	-...K8		
Improved running performance	Smooth anodised aluminium coated piston rod						[4]	-K10		
Temperature resistance	Heat-resistant seals up to max. 120 °C							-S6		
Corrosion protection	High corrosion protection						[5]	-R3		
Captive rating plate	Laser etched rating plate							-TL		
Low temperature [°C]	-40 ... +80						[6] [7]	-TT		
Wiper seal	Dust protection						[6]	-R8		

- | | | | |
|--------------------|---|-------------------|---|
| [2] S2, S20 | Not with improved running performance K10
Not with corrosion protection R3 | [5] R3 | Not with captive rating plate TL
Not with low temperature TT |
| [3] K8 | The sum of the stroke length and piston rod extension must not exceed the maximum permissible stroke length | [6] TT, R8 | Not with wiper seal R8
Not with improved running performance K10 |
| [4] K10 | Not with extended male thread K2
Not with special piston rod thread K5
Not with corrosion protection R3 | [7] TT | Not with temperature resistance S6
Not with wiper seal R8 |

Transfer order code

- [] - [] - [] - [] - [] - [] - [] - [] - [] - []

Compact cylinders ADN, to ISO 21287

Ordering data – Modular products, basic version and variants

M Mandatory data →							
Module No.	Function		Stroke		Cushioning		
	Piston Ø		Piston rod thread		Position sensing		
536 309	ADN	50	1 ... 500	A	P	A	
536 330		63		I			
536 351		80					
536 372		100					
536 393		125					
Order example							
536 309	ADN	- 50	- 350	- A	- P	- A	

Ordering table									
Size	50	63	80	100	125	Condition s	Code	Enter Code	
M Module No.	536 309	536 330	536 351	536 372	536 393				
Function	Compact cylinder, double-acting, based on ISO 21287							ADN	ADN
Piston Ø [mm]	50	63	80	100	125		-...		
Stroke [mm]	1 ... 400		1 ... 500				-...		
Piston rod thread	Male thread						-A		
	Female thread					1	-I		
Cushioning	Flexible cushioning rings/pads at both ends						-P	-P	
Position sensing	Via proximity sensor						-A	-A	

1 I Not with piston rod type S20
Not with extended male thread K2

Transfer order code

	ADN	-		-		-		-	P	-	A
--	------------	---	--	---	--	---	--	---	----------	---	----------

Compact cylinders ADN, to ISO 21287

Ordering data – Modular products, basic version and variants



Options									
Type of piston rod		Special thread		Improved running performance		Corrosion protection		Low temperature	
Male thread extended		Piston rod extended		Temperature resistance		Captive rating plate		Wiper seal	
S2 S20	...K2	"...K5	...K8	K10	S6	R3	TL	TT	R8
- S2	- 15K2	- "M16"K5	- 50K8	-	- S6	-	-	-	-

Ordering table									
Size	50	63	80	100	125	Conditions	Code	Enter Code	
0 Type of piston rod	Through piston rod					2	-S2		
	Through, hollow piston rod								
[mm]	1 ... 400		1 ... 500						
Male thread extended	Extended male piston rod thread								
[mm]	1 ... 20		1 ... 30		1 ... 40		-...K2		
Special piston rod thread	Male thread	M12	M12	M16	M16	M20	-"...K5		
	Female thread	M16	M16	M20	M20	M20x1,5			
		M8	M8	M10	M10	-			
Piston rod extended	Extended piston rod					3	-...K8		
[mm]	1 ... 400		1 ... 500						
Improved running performance	Smooth anodised aluminium coated piston rod					4	-K10		
[mm]	2 ... 400		5 ... 400	5 ... 500					
Temperature resistance	Heat-resistant seals up to max. 120 °C						-S6		
Corrosion protection	High corrosion protection					5	-R3		
Captive rating plate	Laser etched rating plate						-TL		
Low temperature [°C]	-40 ... +80					6 7	-TT		
Wiper seal	Dust protection					6	-R8		

- | | | | |
|-----------|---|----------|---|
| 2 S2, S20 | Not with improved running performance K10
Not with corrosion protection R3 | 5 R3 | Not with captive rating plate TL
Not with low temperature TT |
| 3 K8 | The sum of the stroke length and piston rod extension must not exceed the maximum permissible stroke length | 6 TT, R8 | Not with wiper seal R8
Not with improved running performance K10 |
| 4 K10 | Not with extended male thread K2
Not with special piston rod thread K5
Not with corrosion protection R3 | 7 TT | Not with temperature resistance S6
Not with wiper seal R8 |

Transfer order code

- [] - [] - [] - [] - [] - [] - [] - [] - [] - []

Compact cylinders ADN, to ISO 21287

Ordering data – Modular products, S10 – Version with constant motion, S11 – Version with low friction



M Mandatory data →

Module No.	Function	Piston Ø	Stroke	Piston rod thread	Cushioning	Position sensing
536 203	ADN	12	1 ... 500	A I	P	A
536 218						
536 233						
536 250						
536 267						
536 288						
536 309						
536 330						
536 351						
536 372						
536 393						
Order example						
536 309	ADN	50	350	A	P	A

Ordering table

Size	12	16	20	25	32	40	Condition s	Code	Enter code
M Module No.	536 203	536 218	536 233	536 250	536 267	536 288			
Function	Compact cylinder, double-acting, based on ISO 21287							ADN	ADN
Piston Ø [mm]	12	16	20	25	32	40		-...	
Stroke [mm]	1 ... 300				1 ... 400			-...	
Piston rod thread	Male thread							-A	
	Female thread						1	-I	
Cushioning	Flexible cushioning rings/pads at both ends							-P	-P
Position sensing	Via proximity sensor							-A	-A
O Male thread extended [mm]	Extended male piston rod thread							-...K2	
Special piston rod thread	Male thread	M6	M8	M10x1.25	M10x1.25	M10	M10	-“...”K5	
	Female thread	-	-	M5	M5	M6	M6		
Piston rod extended [mm]	Extended piston rod				1 ... 400		2	-...K8	
Improved running performance	-	-	Smooth anodised aluminium coated piston rod				3	-K10	
Constant motion [mm]	Slow speed (constant motion at low piston speeds)						4	-S10	
	Restricted stroke				20 ... 400				
Low friction	Low friction						5	-S11	
Corrosion protection	High corrosion protection						6	-R3	
Captive rating plate	Laser etched rating plate							-TL	

- | | | | |
|--------------|---|--------------|----------------------------------|
| 1 I | Not with extended male thread K2 | 4 S10 | Not with low friction S11 |
| 2 K8 | The sum of the stroke length and piston rod extension must not exceed the maximum permissible stroke length | 5 S11 | Not with constant motion S10 |
| 3 K10 | Not with extended male thread K2
Not with special piston rod thread K5
Not with corrosion protection R3 | 6 R3 | Not with captive rating plate TL |

Transfer order code

	ADN	-		-		-		-	P	-	A
--	------------	---	--	---	--	---	--	---	----------	---	----------

Compact cylinders ADN, to ISO 21287

Ordering data – Modular products, S10 – Version with constant motion, S11 – Version with low friction

Options							
Male thread extended	Special thread	Piston rod extended	Improved running performance	Constant motion	Low friction	Corrosion protection	Captive rating plate
...K2	"..."K5	...K8	K10	S10	S11	R3	TL
-	- "M16"K5	- 50K8	-	- S10	-	- R3	-

Ordering table										
Size	50	63	80	100	125	Conditions	Code	Enter code		
M Module No.	536 309	536 330	536 351	536 372	536 393					
Function	Compact cylinder, double-acting, based on ISO 21287							ADN	ADN	
Piston Ø [mm]	50	63	80	100	125		-...			
Stroke [mm]	1 ... 400		1 ... 500				-...			
Piston rod thread	Male thread							-A		
	Female thread						¹	-I		
Cushioning	Flexible cushioning rings/pads at both ends							-P	-P	
Position sensing	Via proximity sensor							-A	-A	
O Male thread extended [mm]	Extended male piston rod thread 1 ... 20		1 ... 30		1 ... 40			-...K2		
Special piston rod thread	Male thread	M12	M12	M16	M16	M20		-..."K5		
	Female thread	M16	M16	M20	M20	M20x1.5				
Piston rod extended [mm]	Extended piston rod 1 ... 400		1 ... 500				²	-...K8		
	Restricted stroke 2 ... 400		5 ... 400	5 ... 500			³	-K10		
Constant motion [mm]	Slow speed (constant motion at low piston speeds)						⁴	-S10		
	Restricted stroke 20 ... 400		20 ... 500							
Low friction	Low friction						⁵	-S11		
Corrosion protection	High corrosion protection						⁶	-R3		
Captive rating plate	Laser etched rating plate							-TL		

- ¹ **I** Not with extended male thread K2
- ² **K8** The sum of the stroke length and piston rod extension must not exceed the maximum permissible stroke length
- ³ **K10** Not with extended male thread K2
Not with special piston rod thread K5
Not with corrosion protection R3
- ⁴ **S10** Not with low friction S11
- ⁵ **S11** Not with constant motion S10
- ⁶ **R3** Not with captive rating plate TL

Transfer order code

- [] - [] - [] - [] - [] - [] - [] - []

Compact cylinders ADN, to ISO 21287

Ordering data – Modular products, Q – Version with square piston rod, non-rotating

M Mandatory data →											
Module No.	Function	Piston Ø	Stroke	Piston rod thread	Cushioning	Position sensing					
536 203	ADN	12	1 ... 500	A I	P	A					
536 218											
536 233											
536 250											
536 267											
536 288											
536 309											
536 330											
536 351											
536 372											
536 393											
Order example											
536 309		ADN					50	350	A	P	A

Ordering table									
Size	12	16	20	25	32	40	Condition s	Code	Enter code
M Module No.	536 203	536 218	536 233	536 250	536 267	536 288			
Function	Compact cylinder, double-acting, based on ISO 21287							ADN	ADN
Piston Ø [mm]	12	16	20	25	32	40	-...		
Stroke [mm]	1 ... 300				1 ... 400		-...		
Piston rod thread	Male thread							-A	
	Female thread							[1] -I	
Cushioning	Flexible cushioning rings/pads at both ends							-P	-P
Position sensing	Via proximity sensor							-A	-A
O Protection against torsion	Square piston rod							-Q	-Q
Type of piston rod	Through piston rod							-S2	
	-	Through, hollow piston rod Restricted stroke						-S20	
[mm]	1 ... 200			1 ... 300					
Male thread extended [mm]	Extended male piston rod thread						-...K2		
1 ... 10	1 ... 20								
Special piston rod thread	Male thread	M6	M8	M10x1.25 M10	M10x1.25 M10	M10	M10	-“...”K5	
Piston rod extended [mm]	Extended piston rod				1 ... 400		[2] -...K8		
1 ... 300									
Temperature resistance	Heat-resistant seals up to max. 120 °C							-S6	
Captive rating plate	Laser etched rating plate							-TL	

[1] I Not with piston rod type S20
Not with extended male thread K2

[2] K8 The sum of the stroke length and piston rod extension must not exceed the maximum permissible stroke length

Transfer order code

Compact cylinders ADN, to ISO 21287

Ordering data – Modular products, S1 – Version with reinforced piston rod

M Mandatory data							O Options					
Module No.	Function	Piston Ø	Stroke	Piston rod thread	Cushioning	Position sensing	Male thread extended	Special thread	Piston rod extended	Temperature resistance	Reinforced piston rod	Captive rating plate
536 250	ADN	25	5 ... 500	A I	P	A	...K2	"...K5	...K8	S6	S1	TL
536 288		40										
536 330		63										
536 372		100										
Order example												
536 288	ADN	40	320	I	P	A			50K8	S6	S1	TL

Ordering table												
Size	25		40		63		100		Conditions	Code	Enter code	
M Module No.	536 250		536 288		536 330		536 372					
Function	Compact cylinder, double-acting, based on ISO 21287									ADN	ADN	
Piston Ø [mm]	25		40		63		100			-...		
Stroke [mm]	5 ... 300		10 ... 400		10 ... 500					-...		
Piston rod thread	Male thread										-A	
	Female thread									[1]	-I	
Cushioning	Flexible cushioning rings/pads at both ends										-P	-P
Position sensing	Via proximity sensor										-A	-A
O Male thread extended [mm]	Extended male piston rod thread						1 ... 20		1 ... 30			-...K2
Special piston rod thread	Male thread		M10x1.25	M10x1.25	M12x1.25	M16x1.5				-"...K5		
	Female thread		M5	M8	M10	-						
Piston rod extended [mm]	Extended piston rod			1 ... 300		1 ... 400		1 ... 500		[2]	-...K8	
Temperature resistance	Heat-resistant seals up to max. 120 °C										-S6	
Reinforced piston rod	Reinforced piston rod or extended piston rod bearing										-S1	-S1
Captive rating plate	Laser etched rating plate										-TL	

[1] I Not with extended male thread K2

[2] K8 The sum of the stroke length and piston rod extension must not exceed the maximum permissible stroke length

Transfer order code

Compact cylinders ADN-KP, standard port pattern, with clamping unit

Type codes

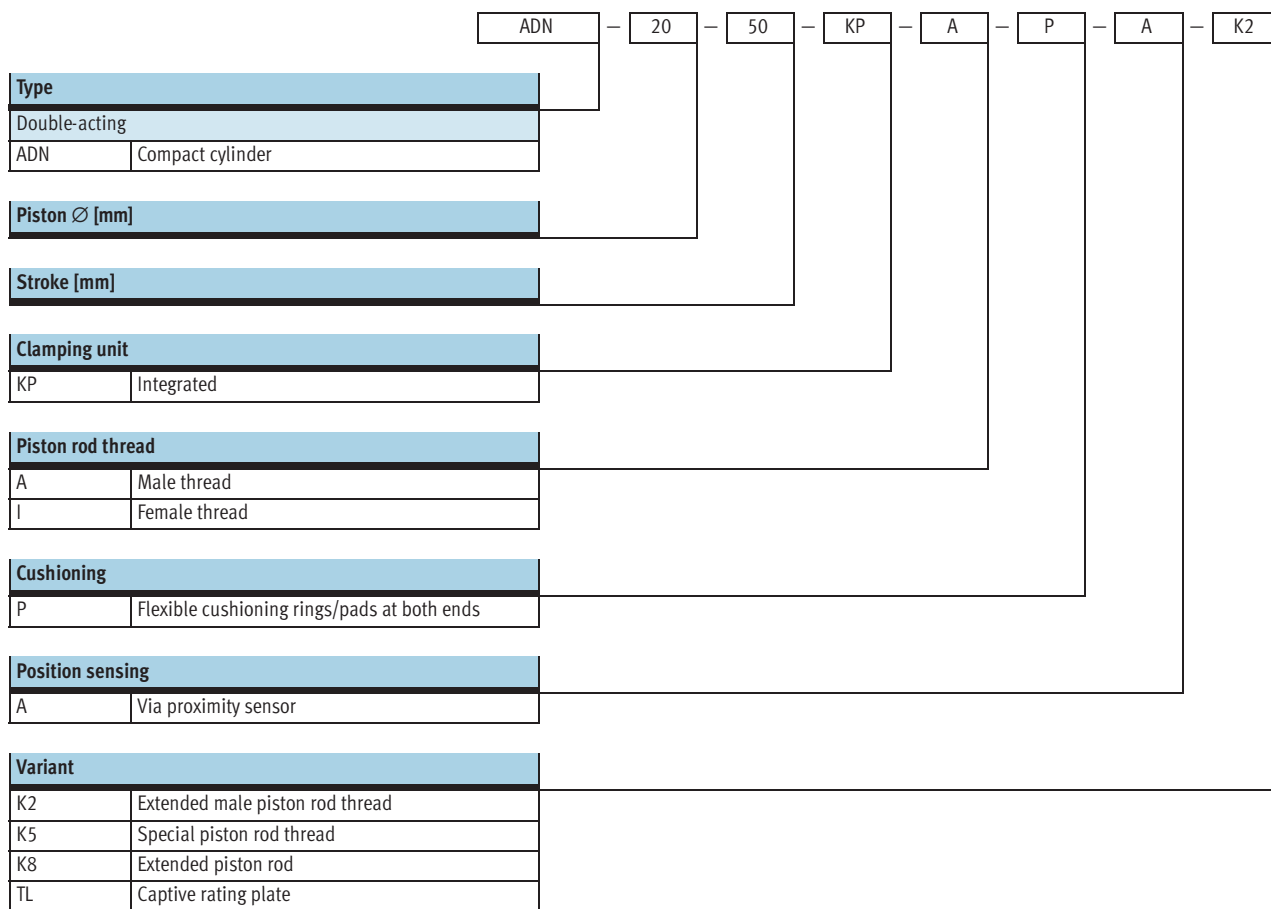

Compact cylinders ADN-KP, standard port pattern, with clamping unit

FESTO

Technical data

Function

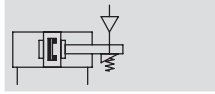

- \varnothing - Diameter
20 ... 100 mm

- | - Stroke length
10 ... 500 mm

Variants



K2



K5



K8

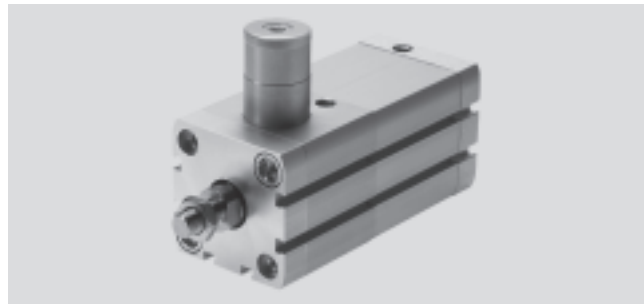

Note

Additional measures are required for use in safety-related control systems; in Europe, for example, the standards Directive must be observed. Without

additional measures in accordance with statutory minimum requirements, the product is not suitable for use in safety-related sections of control systems.

General technical data		20	25	32	40	50	63	80	100
Piston \varnothing		20	25	32	40	50	63	80	100
Pneumatic connection	Cylinder	M5	M5	G $\frac{1}{8}$	G $\frac{1}{8}$	G $\frac{1}{8}$	G $\frac{1}{8}$	G $\frac{1}{8}$	G $\frac{1}{8}$
	KP	M5	M5	M5	G $\frac{1}{8}$	G $\frac{1}{8}$	G $\frac{1}{8}$	G $\frac{1}{8}$	G $\frac{1}{8}$
Female piston rod thread		M6		M8		M10		M12	
	K5	M5		M6		M8		M10	
Male piston rod thread		M8		M10x1.25		M12x1.25		M16x1.5	
	K5	M10, M10x1.25		M10, M12		M12, M16		M16, M20, M20x1.5	
Max. axial backlash with clamped piston rod without load	[mm]	0.5				0.7			
Constructional design	Piston								
	Piston rod								
	Cylinder barrel								
Cushioning		Flexible cushioning rings/pads at both ends							
Position sensing		Via proximity sensor							
Type of mounting		Via through-holes							
		Via female threads							
		Via accessories							
Mounting position		Any							
Clamping type with effective direction of action		From both sides							

Operating and environmental conditions	
Operating medium	Filtered compressed air, lubricated or unlubricated
Operating pressure [bar]	1.5 ... 10
Min. release pressure [bar]	3
Ambient temperature ¹⁾ [°C]	-10 ... +80
Corrosion resistance class CRC ²⁾	2

1) Note operating range of proximity sensors

2) Corrosion resistance class 2 to Festo standard 940 070

Components subject to moderate corrosion stress. Externally visible parts with primarily decorative surface requirements which are in direct contact with a normal industrial environment or media such as coolants or lubricating agents

Compact cylinders ADN-KP, standard port pattern, with clamping unit

Technical data

Impact energy [J]								
Piston Ø	20	25	32	40	50	63	80	100
Max. impact energy at the end positions	0.2	0.3	0.4	0.7	1	1.3	1.8	2.5

Permissible impact velocity:

$$v_{perm.} = \sqrt{\frac{2 \times E_{perm.}}{m_{dead} + m_{load}}}$$

$v_{perm.}$ Permissible impact velocity
 $E_{perm.}$ Max. impact energy
 m_{dead} Moving load (drive)
 m_{load} Moving work load

Note

These specifications represent the maximum values which can be reached. Note the maximum permitted impact energy.

Maximum permissible load:

$$m_{load} = \frac{2 \times E_{perm.}}{v^2} - m_{dead}$$

Forces [N]								
Piston Ø	20	25	32	40	50	63	80	100
Theoretical force at 6 bar, advancing	188	295	483	754	1178	1870	3016	4712
Theoretical force at 6 bar, retracting	141	247	415	633	990	1682	2721	4418
Static holding force	350	350	600	1000	1400	2000	5000	5000

Note

The specified holding force refers to a static load. If this value is exceeded, slippage may occur. Dynamic forces occurring during operation must not exceed the static holding force. The clamping unit is not backlash-free in the clamped condition if varying loads are applied to the piston rod.

Activation:

The clamping unit may only be released if the forces at the piston have reached equilibrium. Otherwise, there is a risk of accidents due to

sudden movement of the piston rod. Blocking off the air supply at both ends (e.g. with a 5/3-way valve) does not provide any safety.

Max. lateral force F_q as a function of the projection x

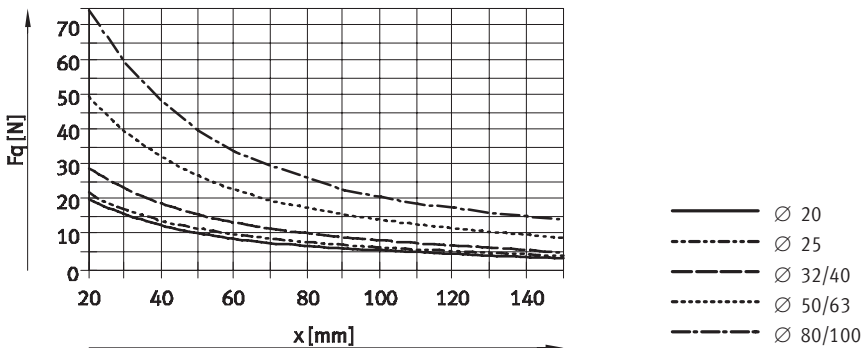

Weight [g]								
Piston Ø	20	25	32	40	50	63	80	100
Product weight with 0 mm stroke	282	344	503	789	1268	1894	3973	5497
Additional weight per 10 mm stroke	22	26	29	45	60	68	93	112
Moving load with 0 mm stroke	53	63	100	173	296	368	755	932
Additional load per 10 mm stroke	6	6	9	16	25	25	39	39

Compact cylinders ADN-KP, standard port pattern, with clamping unit

Technical data

Materials

Sectional view

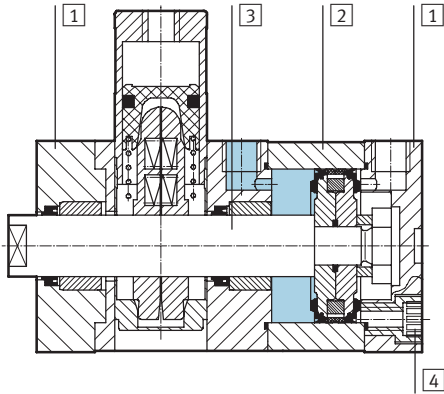

Compact cylinder

1	Cover	Anodised aluminium
2	Cylinder barrel	Anodised aluminium
3	Piston rod	High-alloy steel
4	Flange screws	∅ 20 ... 63 Galvanised steel
		∅ 80 ... 100 Standard screws, galvanised steel
-	Seals	Polyurethane, nitrile rubber

Compact cylinders ADN-KP, standard port pattern, with clamping unit

Technical data

Dimensions – Basic version Download CAD Data → www.festo.com/us/cad

∅ 20 ... 63

∅ 32 ... 63 ∅ 20, 25

This variant only supports direct mounting.

+ = plus stroke length

∅ 80, 100

This variant only supports direct mounting.

+ = plus stroke length

∅	BG	D1	D2	D5	E	E1	EE	G	G1	H1	J2
[mm]	min.	∅ H9	∅	∅ F9							
20	19.5	9	20	9	35.5 ^{+0.3}	M5	M5	49.8	12	63	2.6
25					39.5 ^{+0.3}			50.6		65	
32					47 ^{+0.3}			56.4		68	
40	26	9	24	9	54.5 ^{+0.3}	G1/8	G1/8	60.4	15	89	6
50					65.5 ^{+0.3}			67.4		108	
63					75.5 ^{+0.3}			76.8		120	
80	17	12	38	12	95.5 ^{+0.6}	G1/8	G1/8	99	16.5	167	11.5
100	21.5				48			15	113.5 ^{+0.6}	99.6	

∅	LA	MM	PL	PL1	RT	SF	T2	TG	ZA	ZB
[mm]	+0.2	∅ h8	+0.2	+0.2		h13	+0.2	±0.2	±0.3	+1.2
20	5	10	42.8	6	M5	9	2.1	22	74.8	80.8
25			44.6					77.6	83.1	
32			49.6					85.4	91.4	
40		12	53.6	8.2	M6	10	2.6	38	90.4	96.5
50		16	60.6		M8	13		46.5	97.4	105.6
63		20	70			56.5		110.8	118.9	
80	2.6	25	90.7	10.5	M10	21	2.6	72	136.5	145.4
100			88.6					89	145.1	154.1

Compact cylinders ADN-KP, standard port pattern, with clamping unit

FESTO

Technical data

Dimensions – Variants

Download CAD Data → www.festo.com/us/cad

Basic version

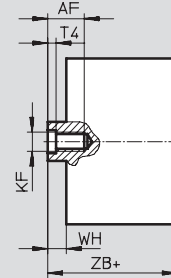
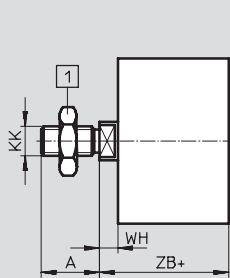

1 Hex nut to DIN 439-B
only with \varnothing 32 ... 100

+ = plus stroke length

K2 – Extended male piston rod thread

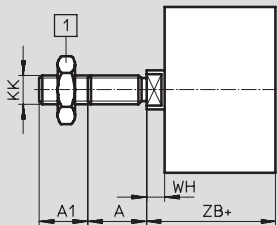

1 Hex nut to DIN 439-B
only with \varnothing 32 ... 100

+ = plus stroke length

K5 – Special piston rod thread

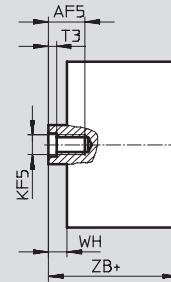
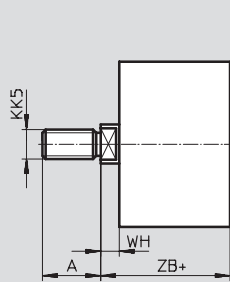

+ = plus stroke length

K8 – Extended piston rod

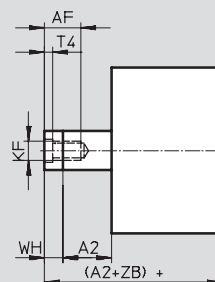
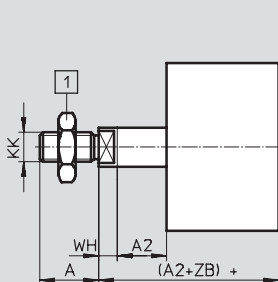

1 Hex nut to DIN 439-B
only with \varnothing 32 ... 100

+ = plus stroke length

Compact cylinders ADN-KP, standard port pattern, with clamping unit

FESTO

Technical data

∅ [mm]	A	A1	A2	AF	AF5	KF	KF5	
	-0.5			min.	min.			
20	16	1 ... 20	1 ... 300	14	12	M6	M5	
25				16	14	M8	M6	
32	19		1 ... 400	20	16	16	M10	M8
40					20	20	M12	M10
50	22							
63	28	1 ... 30	1 ... 500					
80								
100								

∅ [mm]	KK	KK5	T3	T4	WH +1.3	ZB +1.2
20	M8	M10x1.25	2	2.6	5.5	80.8
25		M10			6	83.1
32	M10x1.25	M10	2.6	3.3	6	91.4
40		M12			6.1	96.5
50	M12x1.25	M12	3.3	4.7	8.2	105.6
63		M16			8.1	118.9
80	M16x1.5	M16	4.7	6.1	8.9	145.4
100		M20x1.5 M20			9	154.1

Compact cylinders ADN-KP, standard port pattern, with clamping unit

Ordering data – Modular products

M Mandatory data →

Module No.	Function	Piston Ø	Stroke	Clamping unit	Piston rod thread	Cushioning	Position sensing
548 206	ADN	20	10 ... 500	KP	A	P	A
548 207		25					
548 208		32					
548 209		40					
548 210		50					
548 211		63					
548 212		80					
548 213		100					
Order example							
548 209	ADN	- 40	- 350	- KP	- A	- P	- A

Ordering table

Size	20	25	32	40	Condition s	Code	Enter code
M Module No.	548 206	548 207	548 208	548 209			
Function	Compact cylinder, double-acting, standard port pattern, with clamping unit					ADN	ADN
Piston Ø [mm]	20	25	32	40		-...	
Stroke [mm]	10 ... 300		10 ... 400			-...	
Clamping unit	Integrated					-KP	-KP
Piston rod thread	Male thread					-A	
	Female thread				1	-I	
Cushioning	Flexible cushioning rings/pads at both ends					-P	-P
Position sensing	Via proximity sensor					-A	-A
O Male thread extended	Extended male piston rod thread					-...K2	
	[mm]	1 ... 20					
Special piston rod thread	Male thread	M10x1.25	M10x1.25	M10	M10	-“...”K5	
		M10	M10	M12	M12		
	Female thread	M5	M5	M6	M6		
Piston rod extended	Extended piston rod						
	[mm]	1 ... 300		1 ... 400	2	-...K8	
Captive rating plate	Laser etched rating plate					-TL	

- 1 I Not with extended male thread K2
- 2 K8 The sum of the stroke length and piston rod extension must not exceed the maximum permissible stroke length

Transfer order code

Compact cylinders ADN-KP, standard port pattern, with clamping unit

Ordering data – Modular products

Options			
Male thread extended	Special thread	Piston rod extended	Captive rating plate
...K2	"... "K5	...K8	TL
- 20K2	- "M10"K5	-	- TL

Ordering table							
Size	50	63	80	100	Conditions	Code	Enter code
M Module No.	548 210	548 211	548 212	548 213			
Function	Compact cylinder, double-acting, standard port pattern, with clamping unit					ADN	ADN
Piston Ø [mm]	50	63	80	100		-...	
Stroke [mm]	10 ... 400		10 ... 500			-...	
Clamping unit	Integrated					-KP	-KP
Piston rod thread	Male thread					-A	
	Female thread				¹	-I	
Cushioning	Flexible cushioning rings/pads at both ends					-P	-P
Position sensing	Via proximity sensor					-A	-A
0 Male thread extended [mm]	Extended male piston rod thread 1 ... 20		1 ... 30			-...K2	
Special piston rod thread	Male thread	M12 M16	M12 M16	M16 M20 M20x1.5	M16 M20 M20x1.5	"... "K5	
	Female thread	M8	M8	M10	M10		
Piston rod extended [mm]	Extended piston rod 1 ... 400		1 ... 500		²	-...K8	
Captive rating plate	Laser etched rating plate					-TL	

- ¹ **I** Not with extended male thread K2
- ² **K8** The sum of the stroke length and piston rod extension must not exceed the maximum permissible stroke length

Transfer order code

- - - -

Compact cylinders ADN-EL, standard port pattern, with end position lock

Type codes

ADN – 20 – 100 – ELV – A – P – A – K2

Type	
Double-acting	
ADN	Compact cylinder
Piston Ø [mm]	
Stroke [mm]	
End position lock	
ELB	At both ends
ELV	At front
ELH	At rear
Piston rod thread	
A	Male thread
I	Female thread
Cushioning	
P	Flexible cushioning rings/pads at both ends
Position sensing	
A	Via proximity sensor
Variant	
K2	Extended male piston rod thread
K5	Special piston rod thread
K8	Extended piston rod
TL	Captive rating plate

Compact cylinders ADN-EL, standard port pattern, with end position lock

FESTO

Technical data

Operating and environmental conditions								
Piston Ø	20	25	32	40	50	63	80	100
Operating medium	Filtered compressed air, lubricated or unlubricated							
Operating pressure [bar]	2.5 ... 10				1.5 ... 10			
Ambient temperature ¹⁾ [°C]	-20 ... +80							
Corrosion resistance class CRC ²⁾	2							

1) Note operating range of proximity sensors

2) Corrosion resistance class 2 to Festo standard 940 070

Components subject to moderate corrosion stress. Externally visible parts with primarily decorative surface requirements which are in direct contact with a normal industrial environment or media such as coolants or lubricating agents

Forces [N]								
Piston Ø	20	25	32	40	50	63	80	100
Theoretical force at 6 bar, advancing	188	295	483	754	1178	1870	3016	4712
Theoretical force at 6 bar, retracting	141	247	415	686	1057	1750	2827	4524
Static holding force	250	500			2000		5000	

Sizing example

Note
When sizing pneumatic cylinders it is recommended as a basic principle that only 50% of the indicated theoretical forces (see above) be used.

Given:
Installation position = Vertical
Workpiece load = 44 kg
 $F = m \times g = 44 \text{ kg} \times 9.81 \text{ m/s}^2 = 431.6 \text{ N}$

To be calculated:
Suitable piston Ø

Analysis with 32 mm piston Ø:
Theoretical force at 6 bar, advancing = 483 N
50% of the theoretical force = 241.5 N
Static holding force with 32 mm piston Ø = 500 N
The static force on the end position lock is within the permissible range (max. 500 N) with a workpiece load of 44 kg (431.6 N), however the cylinder would be at 89% capacity.
Result:
A cylinder with a piston Ø of 40 mm is therefore recommended for this application.

Impact energy [J]								
Piston Ø	20	25	32	40	50	63	80	100
Max. impact energy at the end positions	0.2	0.3	0.4	0.7	1	1.3	1.8	2.5

Permissible impact velocity:

$$v_{\text{perm.}} = \sqrt{\frac{2 \times E_{\text{perm.}}}{m_{\text{dead}} + m_{\text{load}}}}$$

$v_{\text{perm.}}$ Permissible impact velocity
 $E_{\text{perm.}}$ Max. impact energy
 m_{dead} Moving load (drive)
 m_{load} Moving work load

Note
These specifications represent the maximum values which can be reached. Note the maximum permitted impact energy.

Maximum permissible load:

$$m_{\text{load}} = \frac{2 \times E_{\text{perm.}}}{v^2} - m_{\text{dead}}$$

Max. lateral force F_q as a function of the projection x

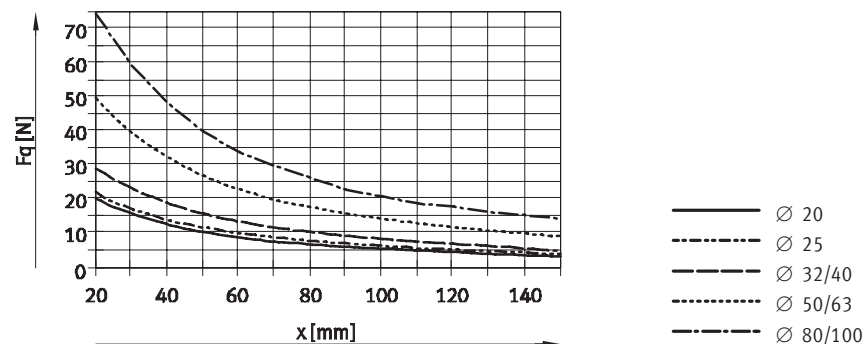

Compact cylinders ADN-EL, standard port pattern, with end position lock

FESTO

Technical data

Weight [g]								
Piston \varnothing	20	25	32	40	50	63	80	100
End position lock at both ends								
Product weight with 0 mm stroke	234	339	518	665	1334	1734	3300	4735
Additional weight per 10 mm stroke	22	26	29	38	51	59	79	98
Moving load with 0 mm stroke	43	53	85	101	199	248	475	637
Additional load per 10 mm stroke	6	6	9	9	16	16	25	25
End position lock at front								
Product weight with 0 mm stroke	177	248	387	498	922	1228	2296	3448
Additional weight per 10 mm stroke	22	26	29	38	51	59	79	98
Moving load with 0 mm stroke	35	46	75	98	175	225	464	626
Additional load per 10 mm stroke	6	6	9	9	16	16	25	25
End position lock at rear								
Product weight with 0 mm stroke	181	252	380	505	920	1217	2233	3409
Additional weight per 10 mm stroke	22	26	29	38	51	59	79	98
Moving load with 0 mm stroke	37	45	73	89	168	217	413	582
Additional load per 10 mm stroke	6	6	9	9	16	16	25	25

Materials

Sectional view

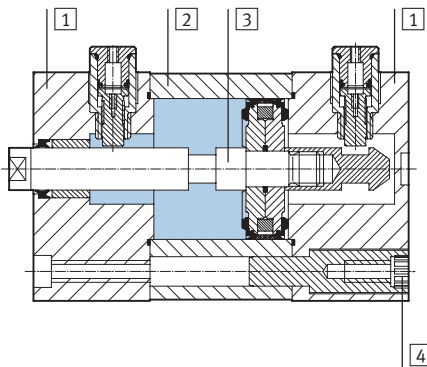

Compact cylinder		
1	Cover	Anodised aluminium
2	Cylinder barrel	Anodised aluminium
3	Piston rod	High-alloy steel
4	Flange screws	\varnothing 20 ... 63
		\varnothing 80 ... 100
-	Seals	Polyurethane, nitrile rubber

Compact cylinders ADN-EL, standard port pattern, with end position lock

Technical data



Dimensions – Basic version

Download CAD Data → www.festo.com/us/cad

ELB – End position lock at both ends

Ø 20 ... 63

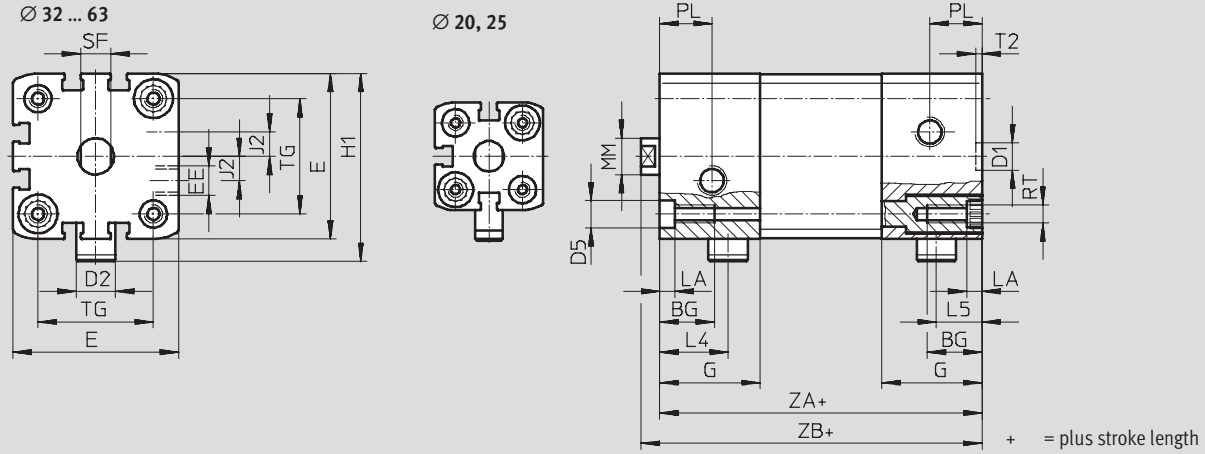

Ø 80 ... 100

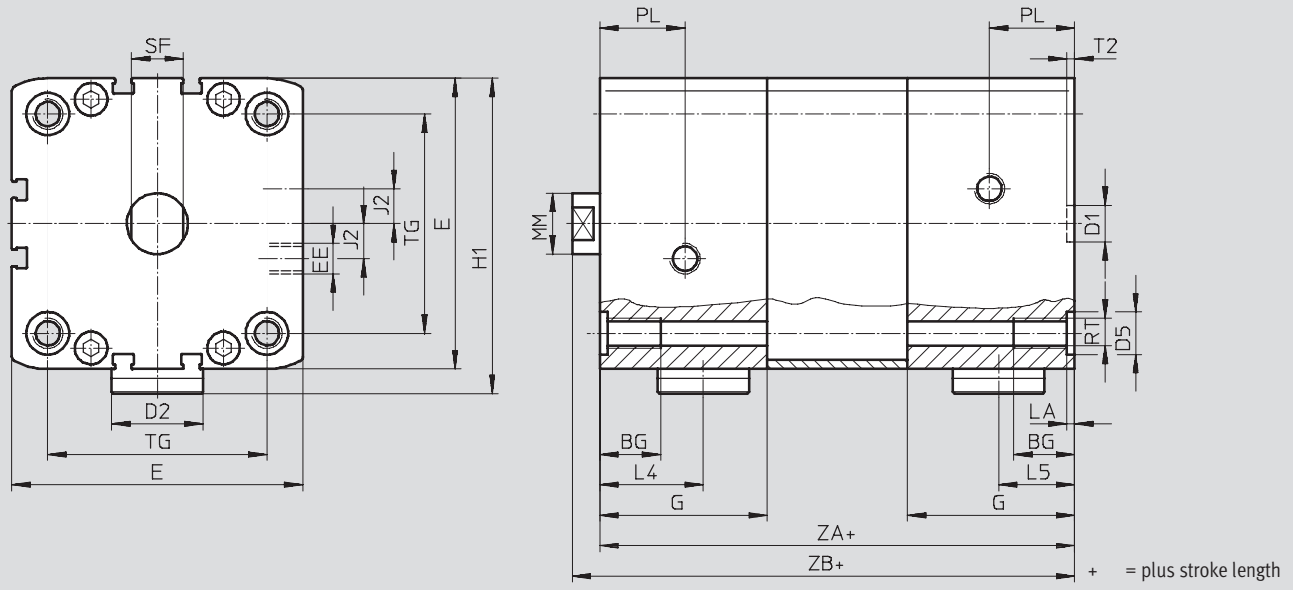

ELV – End position lock at front

ELH – End position lock at rear

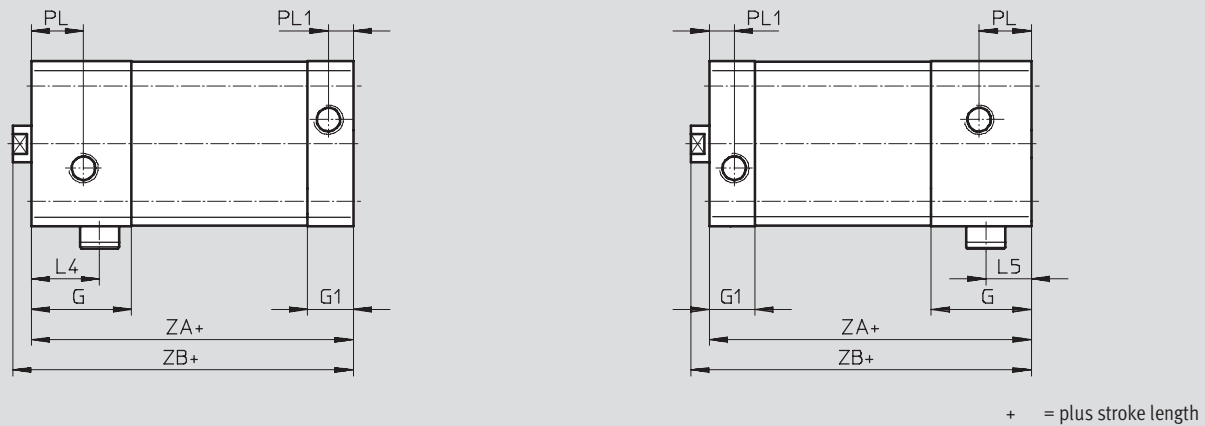

Compact cylinders ADN-EL, standard port pattern, with end position lock

Technical data

∅ [mm]	BG min.	D1 ∅ H9	D2 ∅	D5 ∅ F9	E	EE	G	G1	H1	J2	L4	L5	
20	18	9	9	9	35.5 ^{+0.3}	M5	25	12	45.5	2.6	18.5	12.5	
25			13		39.5 ^{+0.3}		29.5		53.3		20.8	14	
32					20	12	47 ^{+0.3}	G $\frac{1}{8}$	33	15	58	8	22.5
40			54.5 ^{+0.3}				77				20.5		
50	20	12	20	12	65.5 ^{+0.3}	43	16.5		82	11.5	27.5	21.7	
63			30	15	75.5 ^{+0.3}	55			103.5		34	25	
80					95.5 ^{+0.6}	57	21.5	113.5	20	35	27		
100			113.5 ^{+0.6}										

∅ [mm]	LA +0.2	MM ∅ h8	PL	PL1	RT	SF h13	T2 +0.1	TG ±0.2	ZA ±0.3		ZB +1.2						
									ELB	ELV. ELH	ELB	ELV. ELH					
20	5	10	6	6	M5	9	2.1	22	63	50	68.8	55.5					
25								26	74	56.5	79.5	62					
32								12	16	8.2	M6	10	32.5	80	62	86	68
40													38	81	63	87.1	69
50	16	21	M8	13	46.5	101	73	109.2	81.2								
63					56.5	105	77	113.1	85.1								
80	2.6	20	28	10.5	M10	17	72	131	92.5	139.9	101.4						
100							89	138	102.5	147	111.5						

Compact cylinders ADN-EL, standard port pattern, with end position lock

FESTO

Technical data

Dimensions – Variants

Download CAD Data → www.festo.com/us/cad

Basic version

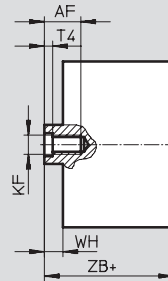
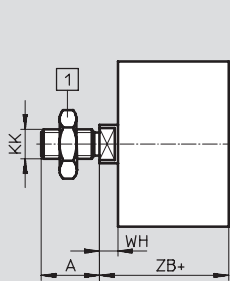

1 Hex nut to DIN 439-B
only with \varnothing 32 ... 100

+ = plus stroke length

K2 – Extended male piston rod thread

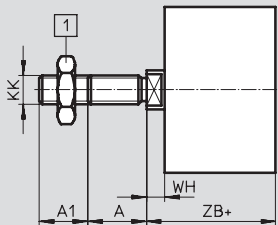

1 Hex nut to DIN 439-B
only with \varnothing 32 ... 100

+ = plus stroke length

K5 – Special piston rod thread

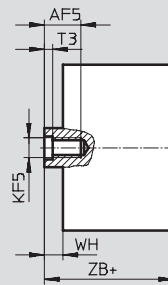
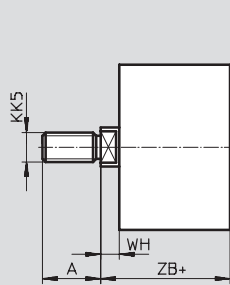

+ = plus stroke length

K8 – Extended piston rod

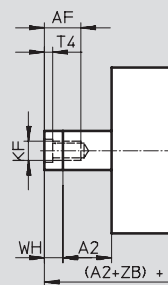
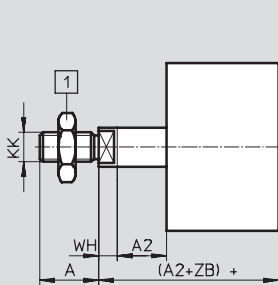

1 Hex nut to DIN 439-B
only with \varnothing 32 ... 100

+ = plus stroke length

Compact cylinders ADN-EL, standard port pattern, with end position lock



Technical data

∅ [mm]	A	A1	A2	AF	AF5	KF	KF5
	-0.5			min.	min.		
20	16	1 ... 20	1 ... 300	14	12	M6	M5
25							
32	19		1 ... 400	16	14	M8	M6
40							
50	22	1 ... 30	1 ... 500	20	16	M10	M8
63							
80	28				20	M12	M10
100							

∅ [mm]	KK	KK5	T3	T4	WH +1.3	ZB +1.2	
						ELB	ELV. ELH
20	M8	M10x1.25 M10	2	2.6	5.5	68.8	55.5
25						79.5	62
32	M10x1.25	M10 M12	2.6	3.3	6	86	68
40						6.1	87.1
50	M12x1.25	M12 M16	3.3	4.7	8.2	109.2	81.2
63						8.1	113.1
80	M16x1.5	M16 M20x1.5 M20	4.7	6.1	8.9	139.9	101.4
100						9	147

Compact cylinders ADN-EL, standard port pattern, with end position lock

FESTO

Ordering data – Modular products

M Mandatory data →

Module No.	Function	Piston Ø	Stroke	End position lock	Piston rod thread	Cushioning	Position sensing
548 214	ADN	20	10 ... 500	ELB	A	P	A
548 215		25		ELV	I		
548 216		32		ELH			
548 217		40					
548 218		50					
548 219		63					
548 220		80					
548 221		100					
Order example							
548 220	ADN	- 80	- 450	- ELV	- I	- P	- A

Ordering table							
Size	20	25	32	40	Condition s	Code	Enter code
M Module No.	548 214	548 215	548 216	548 217			
Function	Compact cylinder, double-acting, standard port pattern, with end position lock						ADN
Piston Ø [mm]	20	25	32	40		-...	
Stroke [mm]	10 ... 300		10 ... 400			-...	
End position lock	At both ends					-ELB	
	At front					-ELV	
	At rear					-ELH	
Piston rod thread	Male thread					-A	
	Female thread				¹	-I	
Cushioning	Flexible cushioning rings/pads at both ends					-P	-P
Position sensing	Via proximity sensor					-A	-A
O Male thread extended	Extended male piston rod thread						
[mm]	1 ... 20					-...K2	
Special piston rod thread	Male thread	M10x1.25	M10x1.25	M10	M10	-“...”K5	
		M10	M10	M12	M12		
	Female thread	M5	M5	M6	M6		
Piston rod extended	Extended piston rod		1 ... 400		²	-...K8	
[mm]	1 ... 300						
Captive rating plate	Laser etched rating plate					-TL	

- ¹ I Not with extended male thread K2
- ² K8 The sum of the stroke length and piston rod extension must not exceed the maximum permissible stroke length

Transfer order code

Compact cylinders ADN-EL, standard port pattern, with end position lock

Ordering data – Modular products

→ **Options**

Male thread extended	Special thread	Piston rod extended	Captive rating plate
...K2	"... "K5	...K8	TL
-	- "M10"K5	- 50K8	- TL

Ordering table							
Size	50	63	80	100	Conditions	Code	Enter code
M Module No.	548 218	548 219	548 220	548 221			
Function	Compact cylinder, double-acting, standard port pattern, with end position lock					ADN	ADN
Piston Ø [mm]	50	63	80	100		-...	
Stroke [mm]	10 ... 400		10 ... 500			-...	
End position lock	At both ends					-ELB	
	At front					-ELV	
	At rear					-ELH	
Piston rod thread	Male thread					-A	
	Female thread				¹	-I	
Cushioning	Flexible cushioning rings/pads at both ends					-P	-P
Position sensing	Via proximity sensor					-A	-A
O Male thread extended [mm]	Extended male piston rod thread 1 ... 20		1 ... 30			-...K2	
Special piston rod thread	Male thread	M12	M12	M16	M16	-"... "K5	
		M16	M16	M20	M20		
	Female thread	M8	M8	M10	M10		
Piston rod extended [mm]	Extended piston rod 1 ... 400		1 ... 500		²	-...K8	
	Captive rating plate Laser etched rating plate					-TL	

- ¹ **I** Not with extended male thread K2
- ² **K8** The sum of the stroke length and piston rod extension must not exceed the maximum permissible stroke length

Transfer order code

- - - -

Compact cylinders AEN, to ISO 21287

Type codes

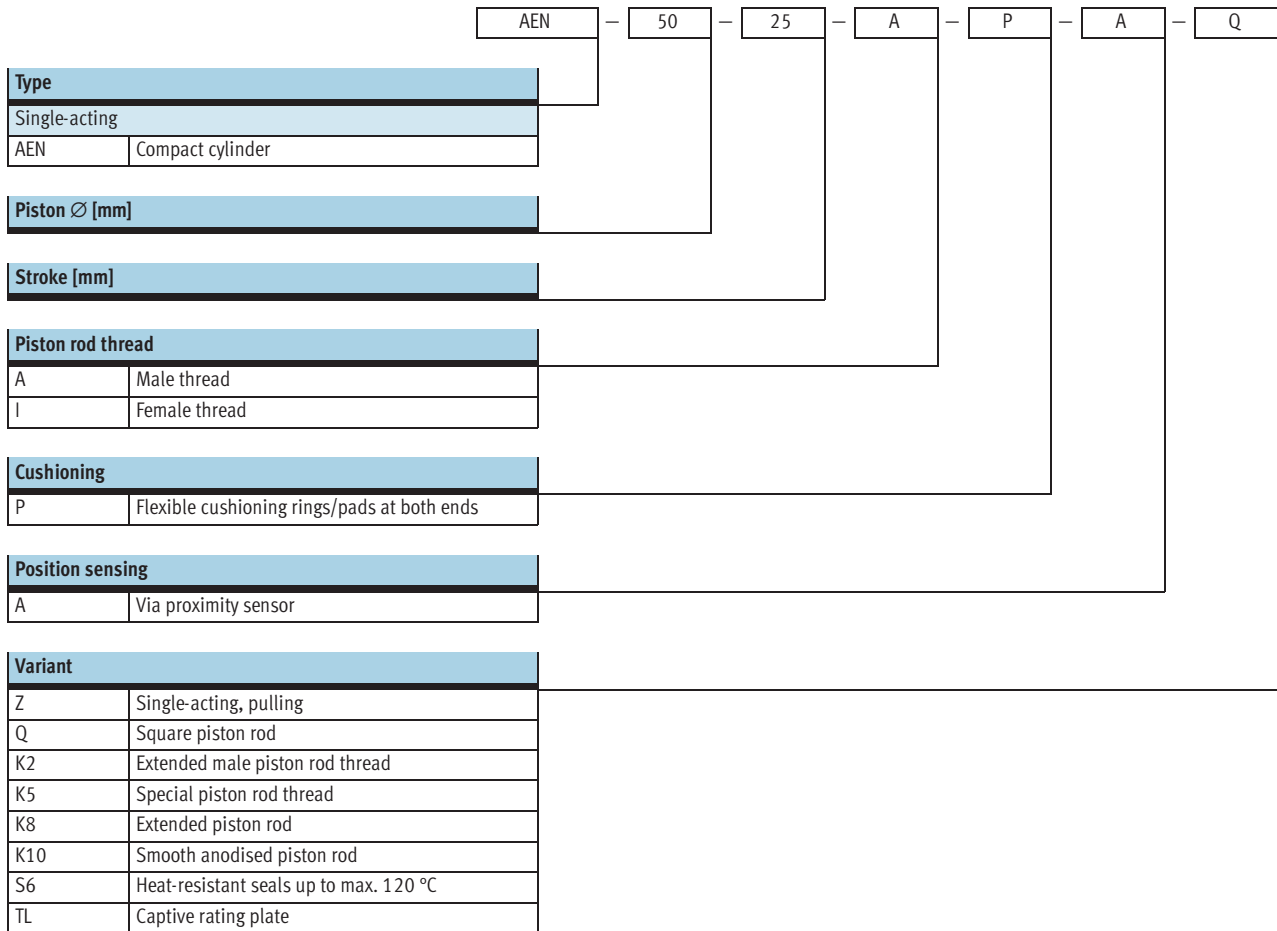

Compact cylinders AEN, to ISO 21287

Technical data

Function

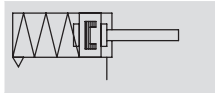

- \varnothing - Diameter
12 ... 100 mm

- | - Stroke length
1 ... 25 mm

www.festo.com/en/Spare_parts_service

Variants



S6



K2



K5



K8



K10



Q

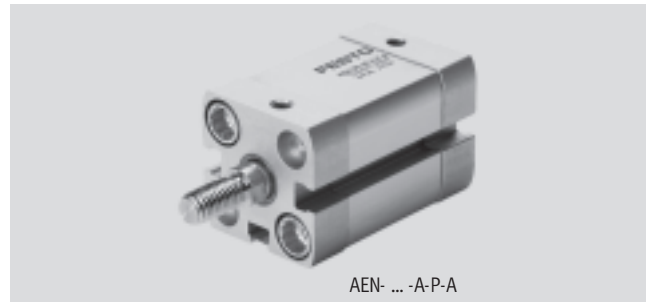

AEN- ... -A-P-A

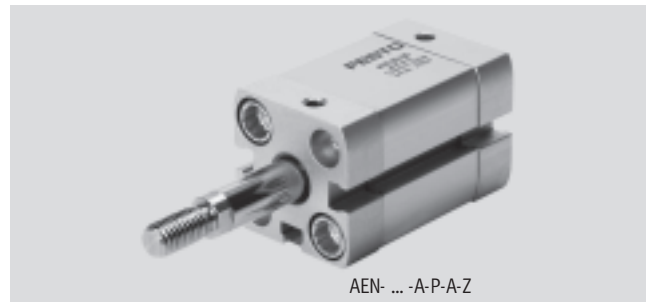

AEN- ... -A-P-A-Z



General technical data											
Piston \varnothing		12	16	20	25	32	40	50	63	80	100
Pneumatic connection		M5	M5	M5	M5	G $\frac{1}{8}$	G $\frac{1}{8}$	G $\frac{1}{8}$	G $\frac{1}{8}$	G $\frac{1}{8}$	G $\frac{1}{8}$
Piston rod thread	Female	M3	M4	M6	M6	M8	M8	M10	M10	M12	M12
	Male	M5	M6	M8	M8	M10x1.25	M10x1.25	M12x1.25	M12x1.25	M16x1.5	M16x1.5
Constructional design		Piston									
		Piston rod									
		Cylinder barrel									
Cushioning		Flexible cushioning rings/pads at both ends									
Position sensing		Via proximity sensor									
Type of mounting		Via through-holes									
		Via female threads									
		Via accessories									
Mounting position		Any									

Operating and environmental conditions											
Piston \varnothing		12	16	20	25	32	40	50	63	80	100
Operating medium		Filtered compressed air, lubricated or unlubricated									
Operating pressure [bar]		1.5 ... 10			1 ... 10						
	Z	1.7 ... 10	2.2 ... 10	1.3 ... 10	0.7 ... 10	0.6 ... 10					
	Q	1.5 ... 10	1 ... 10								
Ambient temperature ¹⁾ [°C]		-20 ... +80									
	S6	0 ... +120									
Corrosion resistance class CRC ²⁾		2									

1) Note operating range of proximity sensors

2) Corrosion resistance class 2 to Festo standard 940 070

Components subject to moderate corrosion stress. Externally visible parts with primarily decorative surface requirements which are in direct contact with a normal industrial environment or media such as coolants or lubricating agents

Compact cylinders AEN, to ISO 21287

Technical data

Forces [N] and impact energy [J]										
Piston Ø	12	16	20	25	32	40	50	63	80	100
AEN										
Theoretical force at 6 bar, advancing	59	95	161	260	440	700	1100	1780	2870	4510
AEN-...Z, pulling										
Theoretical force at 6 bar, retracting	40	65	115	210	380	632	980	1660	2700	4324
	0.04	0.04	0.04	0.08	0.1	0.15	0.18	0.28	0.35	0.7

Permissible impact velocity:

$$v_{perm.} = \sqrt{\frac{2 \times E_{perm.}}{m_{dead} + m_{load}}}$$

$v_{perm.}$ Permissible impact velocity

$E_{perm.}$ Max. impact energy

m_{dead} Moving load (drive)

m_{load} Moving work load

Note

These specifications represent the maximum values which can be reached. Note the maximum permitted impact energy.

Maximum permissible load:

$$m_{load} = \frac{2 \times E_{perm.}}{v^2} - m_{dead}$$

Spring return force F as a function of the stroke l

Ø 12 ... 20

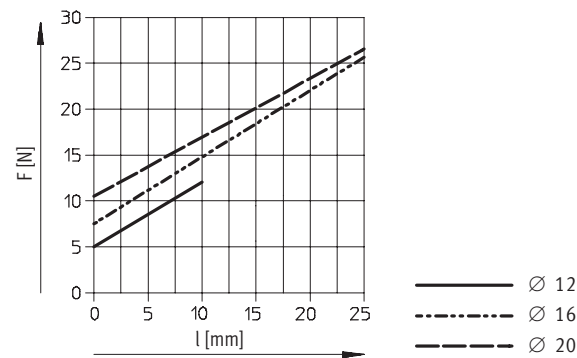

Ø 25 ... 100

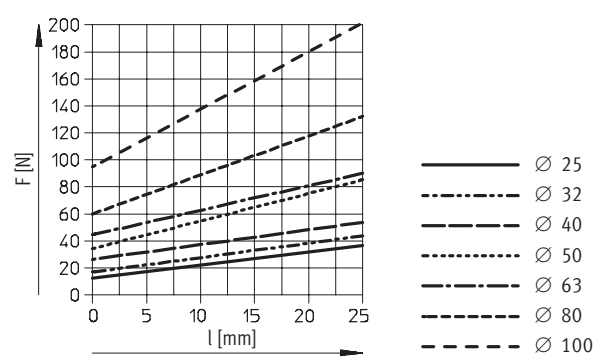

Note

The degree of friction depends upon the assembly position and the type of load involved. Single-acting cylinders should as far as possible be operated without lateral forces.

Compact cylinders AEN, to ISO 21287

Technical data

FESTO

Weight [g]										
Piston Ø	12	16	20	25	32	40	50	63	80	100
Product weight with 0 mm stroke	77	79	131	156	265	346	540	722	1300	2154
Additional weight per 10 mm stroke	12	14	21	23	30	37	51	59	79	98
Moving load with 0 mm stroke	9	15	30	50	60	80	140	180	400	570
Additional load per 10 mm stroke	2	4	6	6	9	9	16	16	25	25

Materials

Sectional view

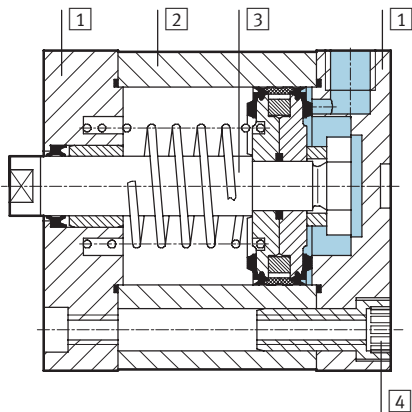

Compact cylinder	Basic version	S6
1 Cover	Anodised aluminium	
2 Cylinder barrel	Anodised aluminium	
3 Piston rod	High-alloy steel	
4 Flange screws	Ø 12 ... 16	High-alloy steel
	Ø 20 ... 63	Galvanised steel
	Ø 80 ... 100	Standard screws, galvanised steel
- Seals	Polyurethane	Fluoro elastomer

Compact cylinders AEN, to ISO 21287

Technical data

FESTO

Dimensions – Basic version

Download CAD Data → www.festo.com/us/cad

Ø 12 ... 63

Ø 32 ... 63

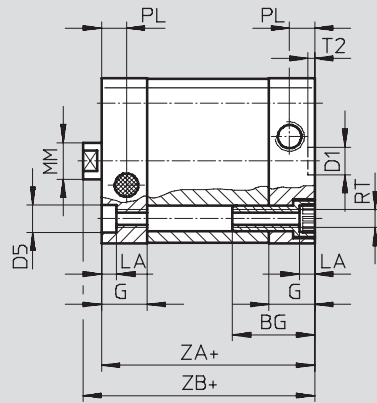
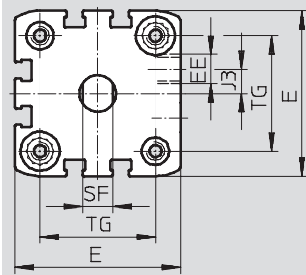

Ø 12

Ø 12 ... 25

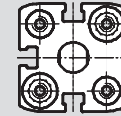
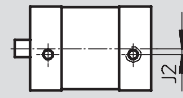

+ = plus stroke length

Ø 80 ... 100

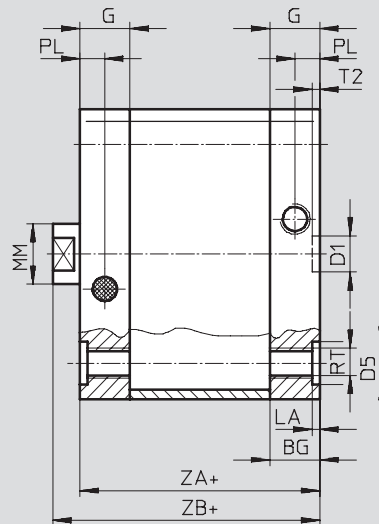
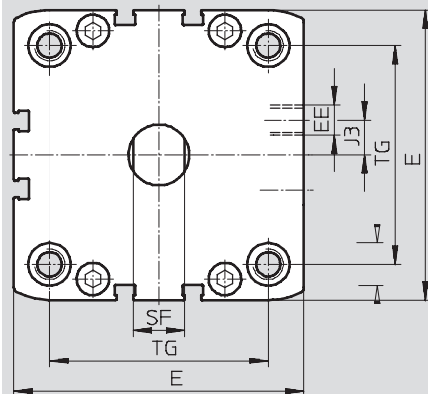

+ = plus stroke length

Compact cylinders AEN, to ISO 21287

Technical data

FESTO

∅ [mm]	BG min.	D1 ∅ H9	D5 ∅ F9	E	EE	G	J2	J3	LA +0.2
12	17	9	6	27.5 ^{+0.3}	M5	10.5	2	-	3.5
16				29 ^{+0.3}		11	2.6		
20	19.5		9	35.5 ^{+0.3}		12			
25				39.5 ^{+0.3}					
32	26		12	12	G1/8	15	6		5
40							47 ^{+0.3}	8	
50	27	12	65.5 ^{+0.3}	16.5		11.5			
63			75.5 ^{+0.3}						
80	17	15	95.5 ^{+0.6}	21.5		20		2.6	
100	21.5		113.5 ^{+0.6}						

∅ [mm]	MM ∅ h8	PL +0.2	RT	SF h13	T2 +0.1	TG ±0.2	ZA ±0.3	ZB +1.2
12	6	6	M4	5	2.1	16	35	39.2
16	8			7		18		39.7
20	10		M5	9		22	37	42.5
25						26	39	44.5
32	12	8.2	M6	10	2.6	32.5	44	50
40						38		45
50	16		M8	13	46.5	49	53.2	
63					56.5		57.1	
80	20		M10	17	72	54	62.9	
100					10.5		89	67

Compact cylinders AEN, to ISO 21287

Technical data

FESTO

Dimensions – Variants

Download CAD Data → www.festo.com/us/cad

Basic version

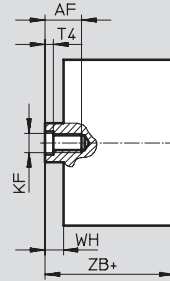
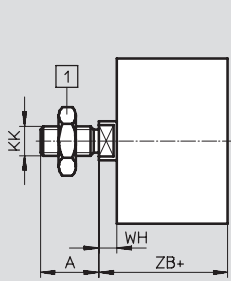

1 Hex nut to DIN 439-B
only with $\varnothing 32 \dots 100$

+ = plus stroke length

Z – Pulling

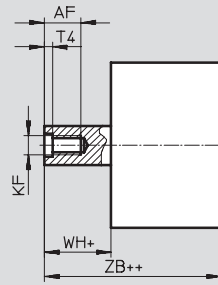
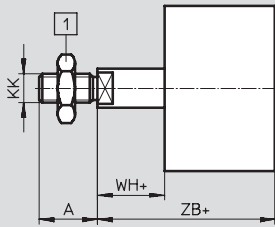

1 Hex nut to DIN 439-B
only with $\varnothing 32 \dots 100$

+ = plus stroke length

++ = plus 2x stroke length

K2 – Extended male piston rod thread

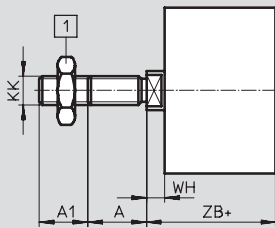

1 Hex nut to DIN 439-B
only with $\varnothing 32 \dots 100$

+ = plus stroke length

K5 – Special piston rod thread

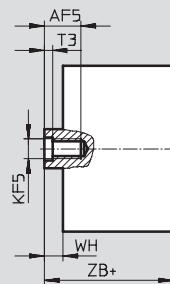
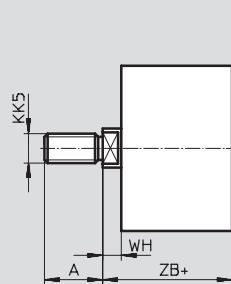

+ = plus stroke length

K8 – Extended piston rod

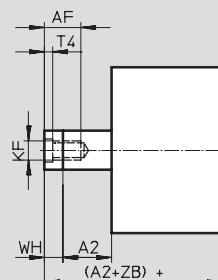
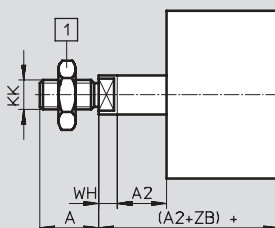

1 Hex nut to DIN 439-B
only with $\varnothing 32 \dots 100$

+ = plus stroke length

Compact cylinders AEN, to ISO 21287

Technical data

FESTO

∅ [mm]	A -0.5	A1	A2	AF min.	AF5 min.	KF	KF5
12	10	1 ... 10	1 ... 300	8	-	M3	-
16	12			10		M4	
20	16	1 ... 20		14	12	M6	M5
25			16	14	M8	M6	
32	19		16	14	M10	M8	
40			19	16	M12	M10	
50	22		20	16	M10	M8	
63		22	20	16	M12	M10	
80	28	1 ... 30	1 ... 500	20	20	M12	M10
100							

∅ [mm]	KK	KK5	T3	T4	WH +1.3	ZB +1.2
12	M5	M6	-	1.5	4.2	39.2
16	M6	M8			4.7	39.7
20	M8	M10x1.25	2	2.6	5.5	42.5
25		M10				44.5
32	M10x1.25	M10	2.6	3.3	6	50
40		M12				6.1
50	M12x1.25	M12	3.3	4.7	8.2	53.2
63		M16				8.1
80	M16x1.5	M16	4.7	6.1	8.9	62.9
100		M20x1.5 M20				9

Compact cylinders AEN, to ISO 21287

Technical data

FESTO

Dimensions – Variants

Download CAD Data → www.festo.com/us/cad

Q – Square piston rod

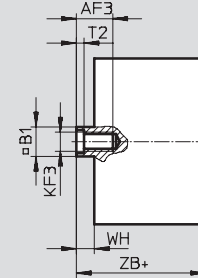
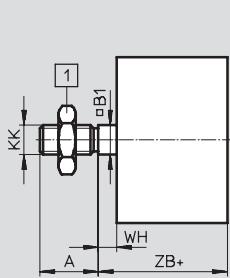

1 Hex nut to DIN 439-B
only with \varnothing 32 ... 100

+ = plus stroke length

Q – Z – Pulling

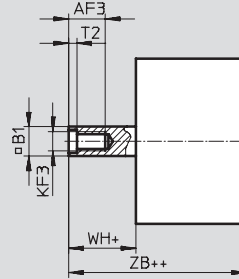
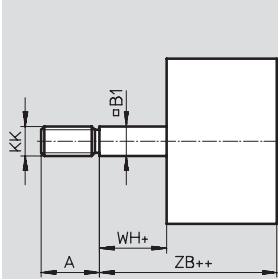

1 Hex nut to DIN 439-B
only with \varnothing 32 ... 100

+ = plus stroke length

++ = plus 2x stroke length

Q-K2 – Square, extended male piston rod thread

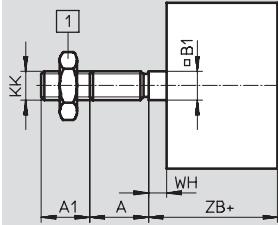

1 Hex nut to DIN 439-B
only with \varnothing 32 ... 100

+ = plus stroke length

Q-K5 – Square, special piston rod thread

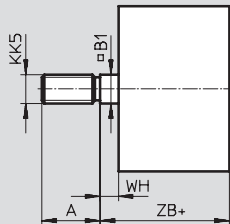

+ = plus stroke length

Q-K8 – Square, extended piston rod

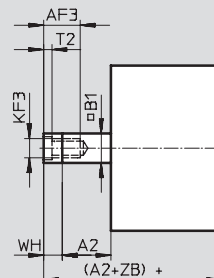
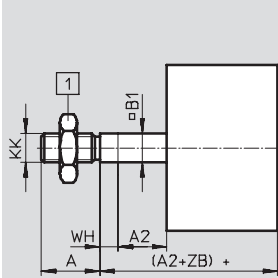

1 Hex nut to DIN 439-B
only with \varnothing 32 ... 100

+ = plus stroke length

Compact cylinders AEN, to ISO 21287

Technical data

FESTO

∅ [mm]	A -0.5	A1	A2	AF3 min.	B1 □	KF3
12	10	1 ... 10	1 ... 300	8	5.5	M3
16	12			10	7	M4
20	16	1 ... 20		12	9	M5
25			19	14	10	M6
32	22			16	12	M8
40				20	16	M10
50	28	1 ... 30	1 ... 500	20	16	M10
63						
80						
100						

∅ [mm]	KK	KK5	T2	WH +1.3	ZB +1.2
12	M5	M6	1.5	4.2	39.2
16	M6	M8		4.7	39.7
20	M8	M10x1.25	2	5.5	42.5
25		M10			44.5
32	M10x1.25	M10	2.6	6	50
40				6.1	51.1
50	M12x1.25	M16	3.3	8.2	53.2
63				8.1	57.1
80				8.9	62.9
100	M16x1.5	M16	4.7	9	76

Compact cylinders AEN, to ISO 21287

Ordering data – Modular products, basic version and variants

M Mandatory data →

Module No.	Function	Piston Ø	Stroke	Type of thread	Cushioning	Position sensing
536 414	AEN	12	1 ... 25	A	P	A
536 415		16				
536 416		20				
536 417		25				
536 418		32				
536 419		40				
536 420		50				
536 421		63				
536 422		80				
536 423		100				
Order example						
536 423	AEN	100	21	A	P	A

Ordering table

Size	12	16	20	25	32	Condition s	Code	Enter code
M Module No.	536 414	536 415	536 416	536 417	536 418			
Function	Compact cylinder, single-acting, based on ISO 21287						AEN	AEN
Piston Ø [mm]	12	16	20	25	32	-...		
Stroke [mm]	1 ... 10		1 ... 25			-...		
Type of thread	Male thread						-A	
	Female thread						[1] -I	
Cushioning	Flexible cushioning rings/pads at both ends						-P	-P
Position sensing	Via proximity sensor						-A	-A
O Effective direction of action	Single-acting, pulling						-Z	
Male thread extended [mm]	Extended male piston rod thread						[2] -...K2	
	1 ... 10		1 ... 20					
Special piston rod thread	Male thread	M6	M8	M10x1.25 M10	M10x1.25 M10	M10 M12	[2] -“...”K5	
	Female thread	-	-	M5	M5	M6		
Piston rod extended [mm]	Extended piston rod					[3] -...K8		
Improved running performance	-		Smooth anodised aluminium coated piston rod			-K10		
Temperature resistance	Heat-resistant seals up to max. 120 °C						-S6	
Captive rating plate	Laser etched rating plate						-TL	

- [1] I Not with extended male thread K2
- [2] K2, K5 Not with improved running performance K10

- [3] K8 The sum of the stroke length and piston rod extension must not exceed the maximum permissible stroke length

Transfer order code

Compact cylinders AEN, to ISO 21287

Ordering data – Modular products, basic version and variants

Options						
Effective direction of action	Male thread extended	Special thread	Piston rod extended	Improved running performance	Temperature resistance	Captive rating plate
Z	...K2	"..."K5	...K8	K10	S6	TL
-	- 25K2 -	-	- 4K8 -	-	- S6 -	- TL -

Ordering table									
Size	40	50	63	80	100	Conditions	Code	Enter code	
M Module No.	536 419	536 420	536 421	536 422	536 423				
Function	Compact cylinder, single-acting, based on ISO 21287							AEN	AEN
Piston Ø [mm]	40	50	63	80	100		-...		
Stroke [mm]	1 ... 25							-...	
Type of thread	Male thread							-A	
	Female thread						1	-I	
Cushioning	Flexible cushioning rings/pads at both ends							-P	-P
Position sensing	Via proximity sensor							-A	-A
O Effective direction of action	Single-acting, pulling							-Z	
Male thread extended [mm]	Extended male piston rod thread			1 ... 30			2	-...K2	
	Special piston rod thread	Male thread	M10	M12	M12	M16	M16	2	-"...K5
		M12	M16	M16	M20	M20			
					M20x1.5	M20x1.5			
	Female thread	M6	M8	M8	M10	M10			
Piston rod extended [mm]	Extended piston rod						3	-...K8	
Improved running performance	Smooth anodised aluminium coated piston rod							-K10	
Temperature resistance	Heat-resistant seals up to max. 120 °C							-S6	
Captive rating plate	Laser etched rating plate							-TL	

- 1** I Not with extended male thread K2
- 2** K2, K5 Not with improved running performance K10

- 3** K8 The sum of the stroke length and piston rod extension must not exceed the maximum permissible stroke length

Transfer order code

- [] - [] - [] - [] - [] - [] - []

Compact cylinders AEN, to ISO 21287

Ordering data – Modular products, Q – Version with square piston rod, non-rotating

M Mandatory data →

Module No.	Function	Piston Ø	Stroke	Type of thread	Cushioning	Position sensing
536 415	AEN	16	1 ... 25	A	P	A
536 416		20		I		
536 417		25				
536 418		32				
536 419		40				
536 420		50				
536 421		63				
536 422		80				
536 423		100				
Order example						
536 423	AEN	100	21	A	P	A

Ordering table							
Size	16	20	25	32	Condition s	Code	Enter code
M Module No.	536 415	536 416	536 417	536 418			
Function	Compact cylinder, single-acting, based on ISO 21287					AEN	AEN
Piston Ø [mm]	16	20	25	32		-...	
Stroke [mm]	1 ... 25					-...	
Type of thread	Male thread					-A	
	Female thread				¹	-I	
Cushioning	Flexible cushioning rings/pads at both ends					-P	-P
Position sensing	Via proximity sensor					-A	-A
O Effective direction of action	Single-acting, pulling					-Z	
Protection against torsion	Square piston rod					-Q	-Q
Male thread extended [mm]	1 ... 10		1 ... 20			-...K2	
Special piston rod thread	Male thread M8	M10x1.25	M10x1.25	M10		-“...”K5	
Piston rod extended [mm]	Extended piston rod 1 ... 25				²	-...K8	
Temperature resistance	Heat-resistant seals up to max. 120 °C					-S6	
Captive rating plate	Laser etched rating plate					-TL	

¹ I Not with extended male thread K2

² K8 The sum of the stroke length and piston rod extension must not exceed the maximum permissible stroke length

Transfer order code

Compact cylinders AEN, to ISO 21287

Ordering data – Modular products, Q – Version with square piston rod, non-rotating

Options						
Effective direction of action	Protection against torsion	Male thread extended	Special thread	Piston rod extended	Temperature resistance	Captive rating plate
Z	Q	...K2	"..."K5	...K8	S6	TL
- Z	- Q	- 25K2	-	- 4K8	-	- TL

Ordering table									
Size	40	50	63	80	100	Conditions	Code	Enter code	
M Module No.	536 419	536 420	536 421	536 422	536 423				
Function	Compact cylinder, single-acting, based on ISO 21287							AEN	AEN
Piston Ø [mm]	40	50	63	80	100		-...		
Stroke [mm]	1 ... 25							-...	
Type of thread	Male thread							-A	
	Female thread						¹	-I	
Cushioning	Flexible cushioning rings/pads at both ends							-P	-P
Position sensing	Via proximity sensor							-A	-A
O Effective direction of action	Single-acting, pulling							-Z	
Protection against torsion	Square piston rod							-Q	-Q
Male thread extended [mm]	Extended male piston rod thread			1 ... 20			1 ... 30	-...K2	
Special piston rod thread	M10	M12	M12	M16	M16		-"... "K5		
Piston rod extended [mm]	Extended piston rod							-...K8	
Temperature resistance	Heat-resistant seals up to max. 120 °C						²	-S6	
Captive rating plate	Laser etched rating plate							-TL	

¹ I Not with extended male thread K2

² K8 The sum of the stroke length and piston rod extension must not exceed the maximum permissible stroke length

Transfer order code

- - Q - - - - -

Compact cylinders ADNP, to ISO 21287, with polymer end caps

Peripherals overview

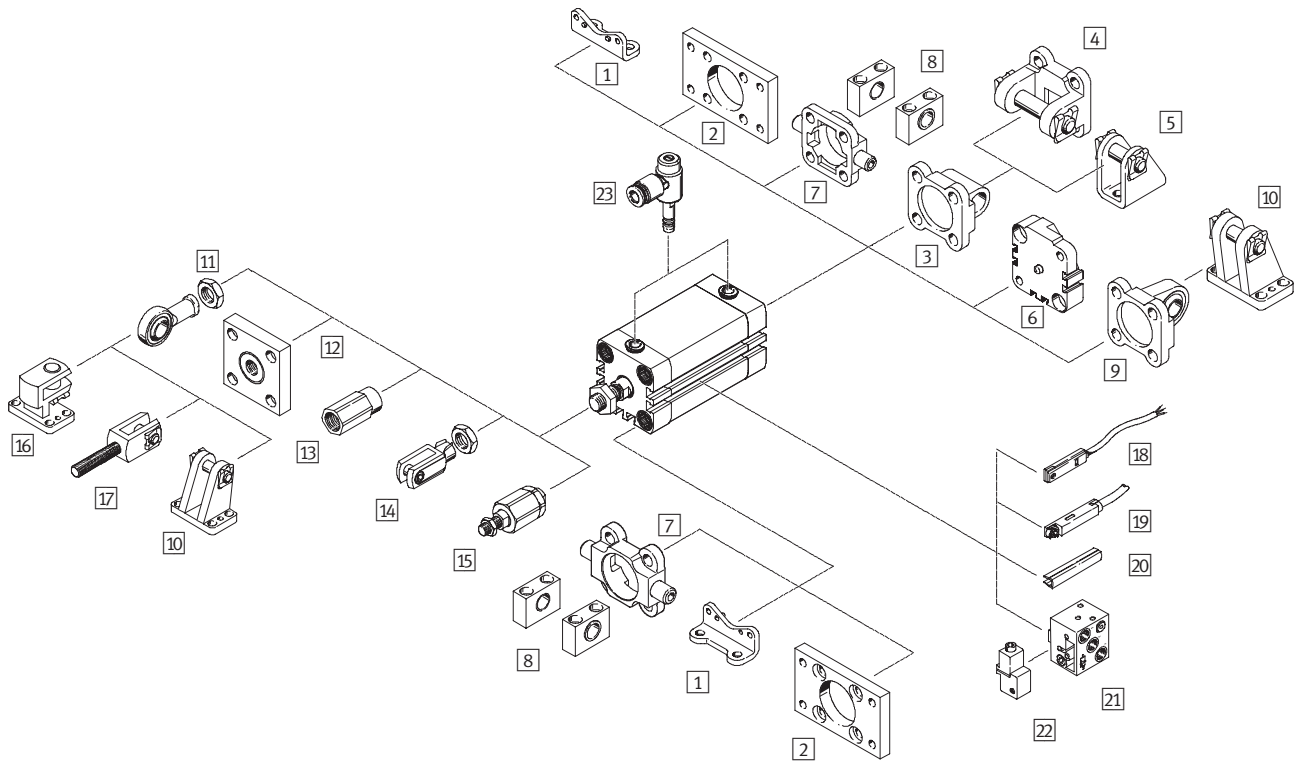

Compact cylinders ADNP, to ISO 21287, with polymer end caps

Peripherals overview

Mounting attachments and accessories		
	Brief description	→ Page/Internet
1	Foot mounting HNA	For bearing or end caps 77
2	Flange mounting FNC	For bearing or end caps 78
3	Swivel flange SNCL	For end caps 79
4	Swivel flange SNCB	For swivel flange SNCL 83
5	Clevis foot LBN/CRLBN	For swivel flange SNCL 82
6	Multi-position kit DPNA	For connecting two cylinders with identical piston \varnothing to form a multi-position cylinder 81
7	Trunnion flange ZNCF/CRZNG	For bearing caps 84
8	Trunnion support LNZG	For trunnion flange ZNCF/CRZNG 85
9	Swivel flange SNCS	For end caps 80
10	Clevis foot LBG	For swivel flange SNCS 80
11	Rod eye SGS/CRSGS	With spherical bearing 86
12	Coupling piece KSG/KSZ	For compensating radial deviations 86
13	Adapter AD	For mounting a vacuum suction cup on a hollow cylinder piston rod 86
14	Rod clevis SG/CRSG	Permits a swivelling movement of the cylinder in one plane 86
15	Self-aligning rod coupler FK	For compensating radial and angular deviations 86
16	Right-angle clevis foot LQG	For rod eye SGS 87
17	Rod clevis SGA	With male thread 86
18	Proximity sensor SME/SMT-8	Can be integrated in the sensor slot of the cylinder profile barrel 89
19	Proximity sensor SME/SMT-8M	Can be integrated in the sensor slot of the cylinder profile barrel 89
20	Slot cover ABP-5-S	For protecting the sensor cable and keeping dirt out of the sensor slots 89
21	Proximity sensor SMPO-8E	Pneumatic output signal 89
22	Mounting kit SMB-8E	For proximity sensor SMPO-8E 89
23	One-way flow control valve VFOC	For speed regulation 88

Compact cylinders ADNP, to ISO 21287, with polymer end caps

Type codes

ADNP – 20 – 50 – A – P – A – QS-4

Type	
Double-acting	
ADNP	Compact cylinder
Piston Ø [mm]	
Stroke [mm]	
Piston rod thread	
A	Male thread
I	Female thread
Cushioning	
P	Flexible cushioning rings/pads at both ends
Position sensing	
A	Via proximity sensor
Connection	
QS-4	Integrated push-in fitting for connecting compressed air tubing with standard external Ø 4 mm
QS-6	Integrated push-in fitting for connecting compressed air tubing with standard external Ø 6 mm

Compact cylinders ADNP, to ISO 21287, with polymer end caps

Technical data

Function

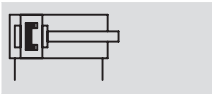

- \varnothing - Diameter
20 ... 50 mm

- | - Stroke length
5 ... 80 mm

www.festo.com/en/Spare_parts_service

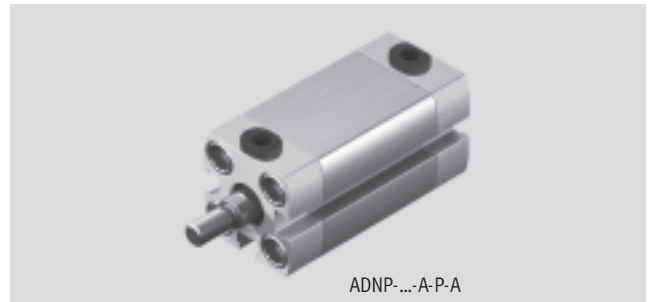

General technical data						
Piston \varnothing		20	25	32	40	50
Pneumatic connection		QS-4	QS-4	QS-6	QS-6	QS-6
Piston rod thread	Female	M6	M6	M8	M8	M10
	Male	M8	M8	M10x1.25	M10x1.25	M10x1.25
Constructional design		Piston				
		Piston rod				
		Cylinder barrel				
Cushioning		Flexible cushioning rings/pads at both ends				
Position sensing		Via proximity sensor				
Type of mounting		Via through-holes				
		Via female threads				
		Via accessories				
Mounting position		Any				

Operating and environmental conditions	
Operating medium	Filtered compressed air, lubricated or unlubricated
Operating pressure [bar]	0.6 ... 10
Ambient temperature ¹⁾ [°C]	-10 ... +60
Corrosion resistance class CRC ²⁾	2

1) Note operating range of proximity sensors

2) Corrosion resistance class 2 to Festo standard 940 070

Components subject to moderate corrosion stress. Externally visible parts with primarily decorative surface requirements which are in direct contact with a normal industrial environment or media such as coolants or lubricating agents

Compact cylinders ADNP, to ISO 21287, with polymer end caps

FESTO

Technical data

Forces [N] and impact energy [J]					
Piston \varnothing	20	25	32	40	50
Theoretical force at 6 bar, advancing	188	295	483	754	1178
Theoretical force at 6 bar, retracting	141	247	415	686	1057
Max. impact energy at the end positions	0.16	0.24	0.32	0.56	0.80

Max. lateral force F_q as a function of the projection x

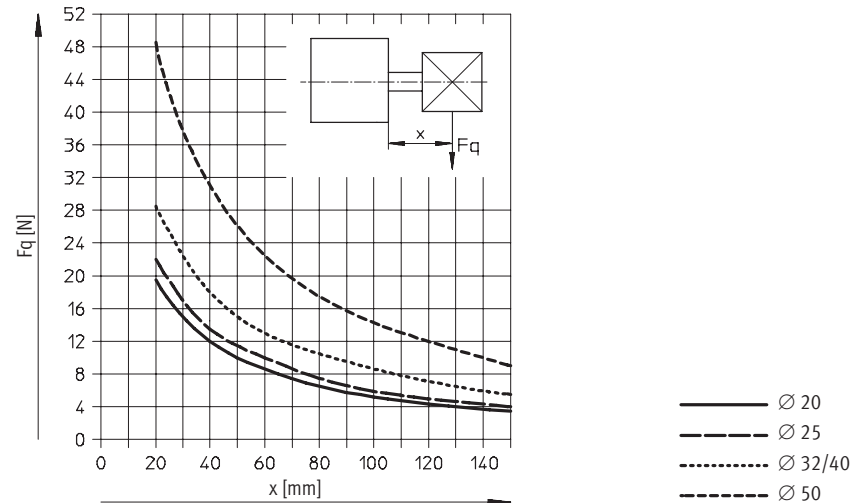

Weight [g]					
Piston \varnothing	20	25	32	40	50
Product weight with 0 mm stroke	115	116	204	240	380
Additional weight per 10 mm stroke	17	19	24	32	41
Moving load with 0 mm stroke	20	20	45	55	94
Additional load per 10 mm stroke	2	2	3	3	6

Materials

Sectional view

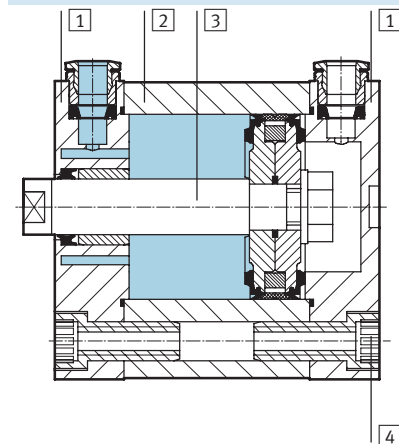

Compact cylinder		
1	Cover	Polyarylamide
2	Cylinder barrel	Smooth anodised aluminium
3	Piston rod	Smooth anodised aluminium, steel insert with male thread
4	Flange screws	Galvanised steel
-	Seals	Polyurethane, nitrile rubber

Compact cylinders ADNP, to ISO 21287, with polymer end caps

Technical data

Dimensions – Basic version Download CAD Data → www.festo.com/us/cad

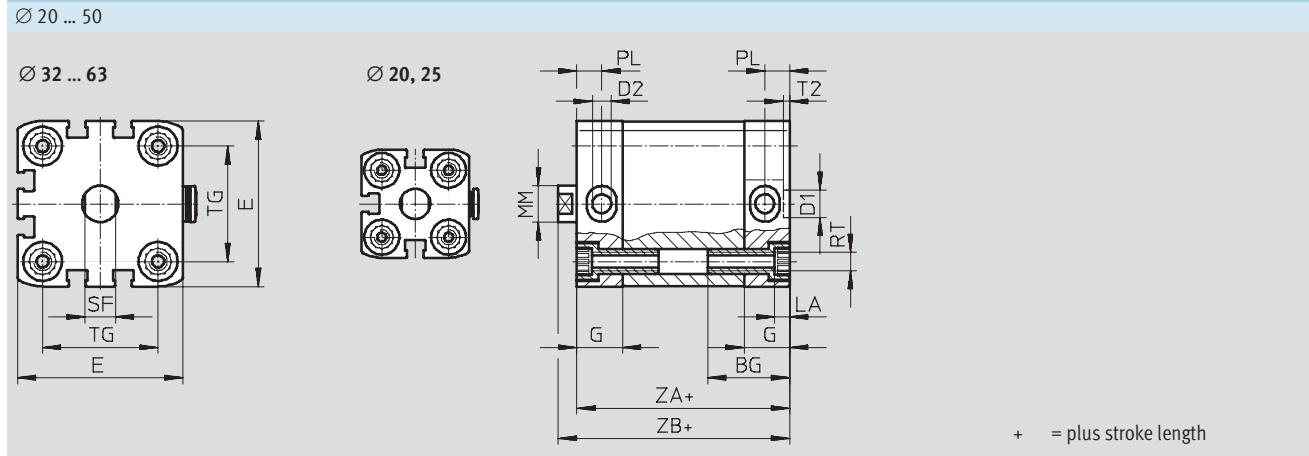

∅	BG	D1	D2	E	G	LA	MM	PL	RT	SF	T2	TG	ZA	ZB	
[mm]	min.	∅ H9	∅	+0.3			∅ h8	+0.2		h13	+0.1	±0.2	±0.3	+1.3	
20	19.5	9	4	35.5	12	5	10	6	M5	9	2.1	22	37	42.5	
25				39.5								26	39	44.5	
32	26		6	47	15		12	8.2		M6		10	32.5	44	50
40				54.5									38	45	51.1
50	27	12		65.5		16		M8	13	2.6	46.5	45	53.2		

Dimensions – Variants Download CAD Data → www.festo.com/us/cad

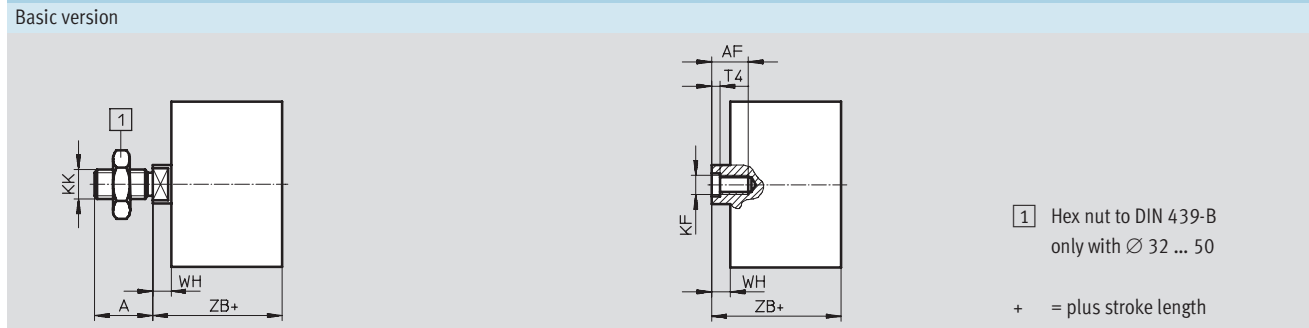

∅	A	AF	KF	KK	T4	WH	ZB
[mm]	-0.5	min.				+1.3	+1.2
20	16	14	M6	M8	2.6	5.5	42.5
25						44.5	
32	19	16	M8	M10x1.25	3.3	6	50
40						6.1	51.1
50	22	20	M10	M12x1.25	4.7	8.2	53.2

Compact cylinders ADNP, to ISO 21287, with polymer end caps

FESTO

Technical data

Ordering data						
Type	Piston Ø [mm]	Stroke [mm]	Female piston rod thread		Male piston rod thread	
			Part No.	Type	Part No.	Type
	20	5	539 435	ADNP-20-5-I-P-A-QS-4	539 390	ADNP-20-5-A-P-A-QS-4
		10	539 436	ADNP-20-10-I-P-A-QS-4	539 391	ADNP-20-10-A-P-A-QS-4
		15	539 437	ADNP-20-15-I-P-A-QS-4	539 392	ADNP-20-15-A-P-A-QS-4
		20	539 438	ADNP-20-20-I-P-A-QS-4	539 393	ADNP-20-20-A-P-A-QS-4
		25	539 439	ADNP-20-25-I-P-A-QS-4	539 394	ADNP-20-25-A-P-A-QS-4
		30	539 440	ADNP-20-30-I-P-A-QS-4	539 395	ADNP-20-30-A-P-A-QS-4
		40	539 441	ADNP-20-40-I-P-A-QS-4	539 396	ADNP-20-40-A-P-A-QS-4
		50	539 442	ADNP-20-50-I-P-A-QS-4	539 397	ADNP-20-50-A-P-A-QS-4
	60	539 443	ADNP-20-60-I-P-A-QS-4	539 398	ADNP-20-60-A-P-A-QS-4	
	25	5	539 444	ADNP-25-5-I-P-A-QS-4	539 399	ADNP-25-5-A-P-A-QS-4
		10	539 445	ADNP-25-10-I-P-A-QS-4	539 400	ADNP-25-10-A-P-A-QS-4
		15	539 446	ADNP-25-15-I-P-A-QS-4	539 401	ADNP-25-15-A-P-A-QS-4
		20	539 447	ADNP-25-20-I-P-A-QS-4	539 402	ADNP-25-20-A-P-A-QS-4
		25	539 448	ADNP-25-25-I-P-A-QS-4	539 403	ADNP-25-25-A-P-A-QS-4
		30	539 449	ADNP-25-30-I-P-A-QS-4	539 404	ADNP-25-30-A-P-A-QS-4
		40	539 450	ADNP-25-40-I-P-A-QS-4	539 405	ADNP-25-40-A-P-A-QS-4
		50	539 451	ADNP-25-50-I-P-A-QS-4	539 406	ADNP-25-50-A-P-A-QS-4
	60	539 452	ADNP-25-60-I-P-A-QS-4	539 407	ADNP-25-60-A-P-A-QS-4	
	32	10	539 453	ADNP-32-10-I-P-A-QS-6	539 408	ADNP-32-10-A-P-A-QS-6
		15	539 454	ADNP-32-15-I-P-A-QS-6	539 409	ADNP-32-15-A-P-A-QS-6
		20	539 455	ADNP-32-20-I-P-A-QS-6	539 410	ADNP-32-20-A-P-A-QS-6
		25	539 456	ADNP-32-25-I-P-A-QS-6	539 411	ADNP-32-25-A-P-A-QS-6
		30	539 457	ADNP-32-30-I-P-A-QS-6	539 412	ADNP-32-30-A-P-A-QS-6
		40	539 458	ADNP-32-40-I-P-A-QS-6	539 413	ADNP-32-40-A-P-A-QS-6
		50	539 459	ADNP-32-50-I-P-A-QS-6	539 414	ADNP-32-50-A-P-A-QS-6
		60	539 460	ADNP-32-60-I-P-A-QS-6	539 415	ADNP-32-60-A-P-A-QS-6
	80	539 461	ADNP-32-80-I-P-A-QS-6	539 416	ADNP-32-80-A-P-A-QS-6	
	40	10	539 462	ADNP-40-10-I-P-A-QS-6	539 417	ADNP-40-10-A-P-A-QS-6
		15	539 463	ADNP-40-15-I-P-A-QS-6	539 418	ADNP-40-15-A-P-A-QS-6
		20	539 464	ADNP-40-20-I-P-A-QS-6	539 419	ADNP-40-20-A-P-A-QS-6
		25	539 465	ADNP-40-25-I-P-A-QS-6	539 420	ADNP-40-25-A-P-A-QS-6
		30	539 466	ADNP-40-30-I-P-A-QS-6	539 421	ADNP-40-30-A-P-A-QS-6
		40	539 467	ADNP-40-40-I-P-A-QS-6	539 422	ADNP-40-40-A-P-A-QS-6
		50	539 468	ADNP-40-50-I-P-A-QS-6	539 423	ADNP-40-50-A-P-A-QS-6
		60	539 469	ADNP-40-60-I-P-A-QS-6	539 424	ADNP-40-60-A-P-A-QS-6
	80	539 470	ADNP-40-80-I-P-A-QS-6	539 425	ADNP-40-80-A-P-A-QS-6	
	50	10	539 471	ADNP-50-10-I-P-A-QS-6	539 426	ADNP-50-10-A-P-A-QS-6
		15	539 472	ADNP-50-15-I-P-A-QS-6	539 427	ADNP-50-15-A-P-A-QS-6
		20	539 473	ADNP-50-20-I-P-A-QS-6	539 428	ADNP-50-20-A-P-A-QS-6
		25	539 474	ADNP-50-25-I-P-A-QS-6	539 429	ADNP-50-25-A-P-A-QS-6
		30	539 475	ADNP-50-30-I-P-A-QS-6	539 430	ADNP-50-30-A-P-A-QS-6
		40	539 476	ADNP-50-40-I-P-A-QS-6	539 431	ADNP-50-40-A-P-A-QS-6
		50	539 477	ADNP-50-50-I-P-A-QS-6	539 432	ADNP-50-50-A-P-A-QS-6
		60	539 478	ADNP-50-60-I-P-A-QS-6	539 433	ADNP-50-60-A-P-A-QS-6
	80	539 479	ADNP-50-80-I-P-A-QS-6	539 434	ADNP-50-80-A-P-A-QS-6	

Compact cylinders ADN/AEN, to ISO 21287

Accessories

FESTO

Foot mounting HNA

Material:

HNA: Galvanised steel

HNA-...-R3: Steel with protective coating

Free of copper, PTFE and silicone

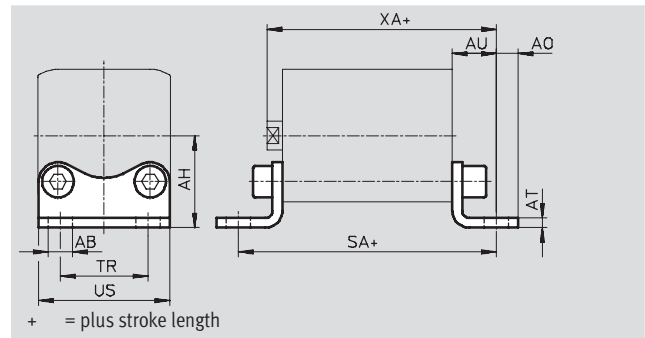

Dimensions and ordering data									
For \varnothing	AB \varnothing	AH	AO	AT	AU	SA	TR	US	XA
[mm]	H14	JS14		± 0.5	± 0.2		± 0.2	-0.5	
12	5.8	21	5	3	13	61	16	26	52.2
16		22	4.75				18	27.5	52.9
20	7	27	6.25	4	16	69	22	34.5	58.7
25		29					26	38.5	60.7
32		33.5					7	32	46
40	10	38	9	5	18	81	36	54	69.2
50		45	8				45	64	74.2
63		50					50	75	78.2
80	12	63	10.5	6	26	106	63	63	89
100	14.5	74	12.5				27	121	75

For \varnothing	Basic version				R3 – High corrosion protection			
	CRC ¹⁾	Weight [g]	Part No.	Type	CRC ¹⁾	Weight [g]	Part No.	Type
[mm]								
12	2	25	537 237	HNA-12	3	25	537 252	HNA-12-R3
16	2	30	537 238	HNA-16	3	30	537 253	HNA-16-R3
20	2	50	537 239	HNA-20	3	50	537 254	HNA-20-R3
25	2	55	537 240	HNA-25	3	55	537 255	HNA-25-R3
32	2	70	537 241	HNA-32	3	70	537 256	HNA-32-R3
40	2	90	537 242	HNA-40	3	90	537 257	HNA-40-R3
50	2	160	537 243	HNA-50	3	160	537 258	HNA-50-R3
63	2	180	537 244	HNA-63	3	180	537 259	HNA-63-R3
80	2	380	537 249	HNA-80	3	380	537 260	HNA-80-R3
100	2	470	537 250	HNA-100	3	470	537 261	HNA-100-R3

1) Corrosion resistance class 2 to Festo standard 940 070
 Components subject to moderate corrosion stress. Externally visible parts with primarily decorative surface requirements which are in direct contact with a normal industrial environment or media such as coolants or lubricating agents.
 Corrosion resistance class 3 to Festo standard 940 070
 Components requiring higher corrosion resistance. External visible parts in direct contact with industrial atmospheres or media such as solvents and cleaning agents, with a predominantly functional requirement for the surface

Compact cylinders ADN/AEN, to ISO 21287

Accessories



Flange mounting FNC

Material:
Galvanised steel
Free of copper, PTFE and silicone

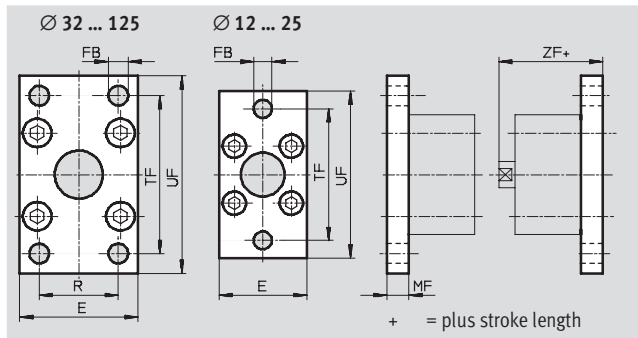

Dimensions and ordering data											
For Ø	E	FB	MF	R	TF	UF	ZF	CRC ¹⁾	Weight	Part No.	Type
[mm]		Ø				±1			[g]		
12	28	5.5	8	-	40	50	47.2	2	80	537 245	FNC-12
16	29				43	55	47.9	2	90	537 246	FNC-16
20	36	55			70	50.7	2	145	537 247	FNC-20	
25	40	6.6			60	76	52.7	2	170	537 248	FNC-25
32	45	7	10	32	64	80	60.2	2	240	174 376	FNC-32
40	54	9		36	72	90	61.2	2	280	174 377	FNC-40
50	65	9	12	45	90	110	65.2	2	520	174 378	FNC-50
63	75			50	100	120	69.2	2	690	174 379	FNC-63
80	93	12	16	63	126	150	79	2	1650	174 380	FNC-80
100	110	14		75	150	175	92	2	2400	174 381	FNC-100
125	132	16	20	90	180	210	112	2	3750	174 382	FNC-125

1) Corrosion resistance class 2 to Festo standard 940 070
Components subject to moderate corrosion stress. Externally visible parts with primarily decorative surface requirements which are in direct contact with a normal industrial environment or media such as coolants or lubricating agents

Compact cylinders ADN/AEN, to ISO 21287

Accessories

FESTO

Swivel flange SNCL

Material:

SNCL: Die-cast aluminium

SNCL-...-R3: Die-cast aluminium with protective coating

Free of copper, PTFE and silicone

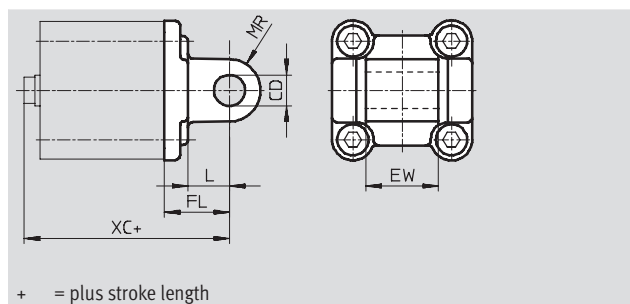
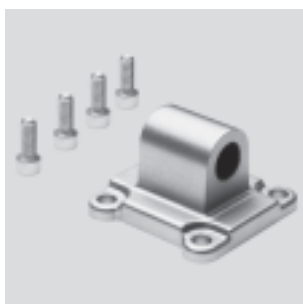

Dimensions and ordering data						
For \varnothing [mm]	CD \varnothing H9	EW	FL ± 0.2	L	MR	XC
12	6	12 _{h12}	16	10	6	55.2
16						55.9
20	8	16 _{h12}	20	14	8	62.7
25						64.7
32	10	26 _{-0.2/-0.6}	22	13	10	72.2
40	12	28 _{-0.2/-0.6}	25	16	12	75.2
50		32 _{-0.2/-0.6}	27			80.2
63	16	40 _{-0.2/-0.6}	32	21	16	89.2
80		50 _{-0.2/-0.6}	36	22		99
100	20	60 _{-0.2/-0.6}	41	27	20	117
125	25	70 _{-0.2/-0.6}	50	30		142

For \varnothing [mm]	Basic version				R3 – High corrosion protection			
	CRC ¹⁾	Weight [g]	Part No.	Type	CRC ¹⁾	Weight [g]	Part No.	Type
12	2	20	537 790	SNCL-12	3	20	537 794	SNCL-12-R3
16	2	25	537 791	SNCL-16	3	25	537 795	SNCL-16-R3
20	2	40	537 792	SNCL-20	3	40	537 796	SNCL-20-R3
25	2	45	537 793	SNCL-25	3	45	537 797	SNCL-25-R3
32	2	85	174 404	SNCL-32	–	–	–	–
40	2	115	174 405	SNCL-40	–	–	–	–
50	2	180	174 406	SNCL-50	–	–	–	–
63	2	270	174 407	SNCL-63	–	–	–	–
80	2	480	174 408	SNCL-80	–	–	–	–
100	2	700	174 409	SNCL-100	–	–	–	–
125	2	1300	174 410	SNCL-125	–	–	–	–

1) Corrosion resistance class 2 to Festo standard 940 070

Components subject to moderate corrosion stress. Externally visible parts with primarily decorative surface requirements which are in direct contact with a normal industrial environment or media such as coolants or lubricating agents.

Corrosion resistance class 3 to Festo standard 940 070

Components requiring higher corrosion resistance. External visible parts in direct contact with industrial atmospheres or media such as solvents and cleaning agents, with a predominantly functional requirement for the surface

Compact cylinders ADN/AEN, to ISO 21287

Accessories

FESTO

Swivel flange SNCS

Material:
Die-cast aluminium

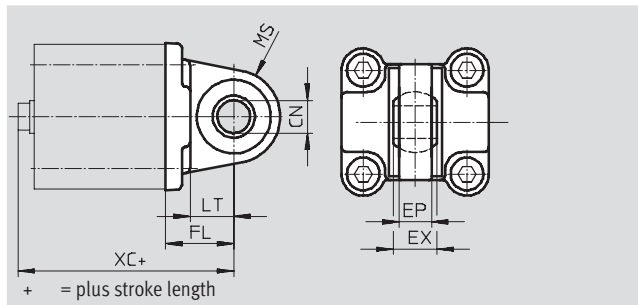
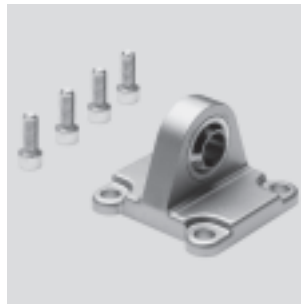

Dimensions and ordering data											
For \varnothing	CN	EP	EX	FL	LT	MS	XC	CRC ¹⁾	Weight	Part No.	Type
[mm]	\varnothing H7	± 0.2		± 0.2					[g]		
32	10	10.5	14	22	13	15	72.2	2	85	174 397	SNCS-32
40	12	12	16	25	16	17	75.2	2	125	174 398	SNCS-40
50	16	15	21	27	16	20	80.2	2	210	174 399	SNCS-50
63	16	15	21	32	21	22	89.2	2	280	174 400	SNCS-63
80	20	18	25	36	22	27	99	2	540	174 401	SNCS-80
100	20	18	25	41	27	29	117	2	700	174 402	SNCS-100
125	30	25	37	50	30	39	142	2	1410	174 403	SNCS-125

1) Corrosion resistance class 2 to Festo standard 940 070
Components subject to moderate corrosion stress. Externally visible parts with primarily decorative surface requirements which are in direct contact with a normal industrial environment or media such as coolants or lubricating agents

Clevis foot LBG

The clevis foot is secured against rotation with a dowel pin.

Material:
Nodular graphite cast iron
Free of copper, PTFE and silicone

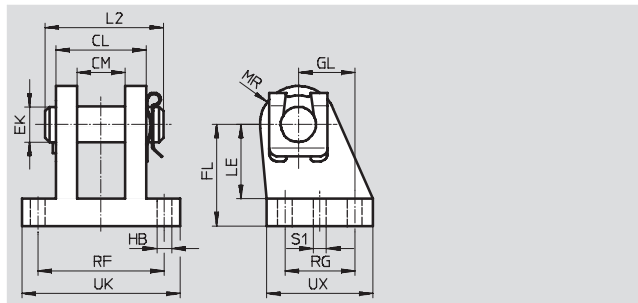

Dimensions and ordering data																		
For \varnothing	CL	CM	EK	FL	GL	HB	L2	LE	MR	RF	RG	S1	UK	UX	CRC ¹⁾	Weight	Part No.	Type
[mm]			\varnothing			\varnothing						\varnothing				[g]		
32	28	14.1	10	32	16	6.8	35	24	12	42	20	4.8	56	36	2	220	31 761	LBG-32
40	30	16.1	12	36	20	6.8	39	26	14	44	26	5.8	58	41.5	2	300	31 762	LBG-40
50	40	21.1	16	45	25	9.2	50	33	15	56	31	5.8	70	47	2	540	31 763	LBG-50
63	40	21.1	16	50	25	9	50	38	17	56	31	7.8	70	45	2	580	31 764	LBG-63
80	50	25.1	20	63	30	11	60	49	18	70	36	7.8	89	55	2	1050	31 765	LBG-80
100	50	25.1	20	71	41	11	60	56	22	70	46	9.8	89	65	2	1375	31 766	LBG-100
125	80	37.2	30	90	60	14	89	70	26	106	70	11.8	128	96	2	4140	31 767	LBG-125

1) Corrosion resistance class 2 to Festo standard 940 070
Components subject to moderate corrosion stress. Externally visible parts with primarily decorative surface requirements which are in direct contact with a normal industrial environment or media such as coolants or lubricating agents

Compact cylinders ADN/AEN, to ISO 21287

Accessories

FESTO

Multi-position kit DPNA

Material:

Flange: Aluminium

Screws: Galvanised steel

Free of copper, PTFE and silicone

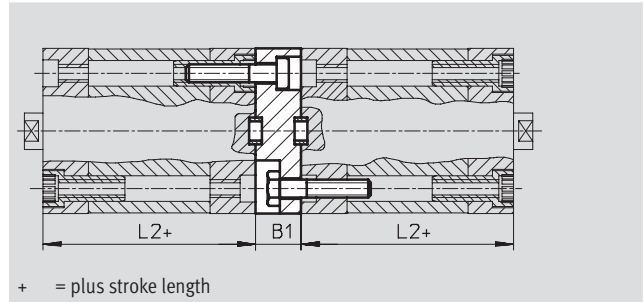

Note

The maximum overall stroke length may not be exceeded when combining cylinders and multi-position kits.

Dimensions and ordering data						
For Ø	L2	B1	Max. overall stroke length	CRC ¹⁾	Part No.	Type
[mm]			[mm]			
12	35	13	600	2	537 263	DPNA-12
16			600	2	537 264	DPNA-16
20			600	2	537 265	DPNA-20
25			600	2	537 266	DPNA-25
32	44	15	800	2	537 267	DPNA-32
40	45		800	2	537 268	DPNA-40
50			800	2	537 269	DPNA-50
63			800	2	537 270	DPNA-63
80	54	17	1000	2	537 271	DPNA-80
100	67	19.5	1000	2	537 272	DPNA-100

1) Corrosion resistance class 2 to Festo standard 940 070

Components subject to moderate corrosion stress. Externally visible parts with primarily decorative surface requirements which are in direct contact with a normal industrial environment or media such as coolants or lubricating agents

Compact cylinders ADN/AEN, to ISO 21287

Accessories

FESTO

Clevis foot LBN

Material:
Galvanised steel
Free of copper, PTFE and silicone

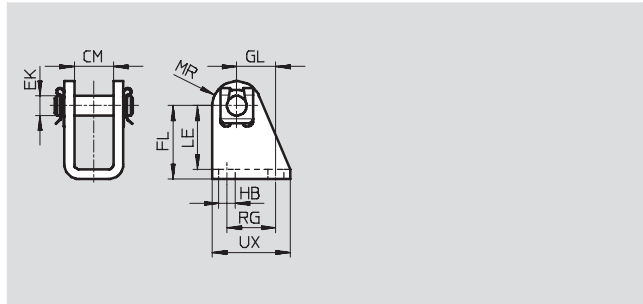
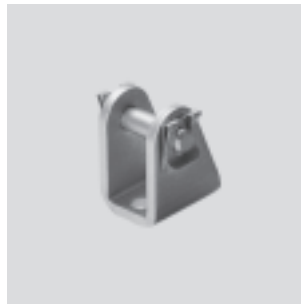

Dimensions and ordering data													
For \varnothing	CM	EK \varnothing	FL	GL	HB \varnothing	LE	MR	RG	UX	CRC ¹⁾	Weight [g]	Part No.	Type
[mm]													
12/16	12.1	6	27 +0.3/-0.2	13	5.5	24	7	15	25	2	40	6 058	LBN-12/16
20/25	16.1	8	30 +0.4/-0.2	16	6.6	26	10	20	32	2	81	6 059	LBN-20/25

1) Corrosion resistance class 2 to Festo standard 940 070
Components subject to moderate corrosion stress. Externally visible parts with primarily decorative surface requirements which are in direct contact with a normal industrial environment or media such as coolants or lubricating agents

Clevis foot CRLBN, stainless steel

Material:
High-alloy steel
Free of copper, PTFE and silicone

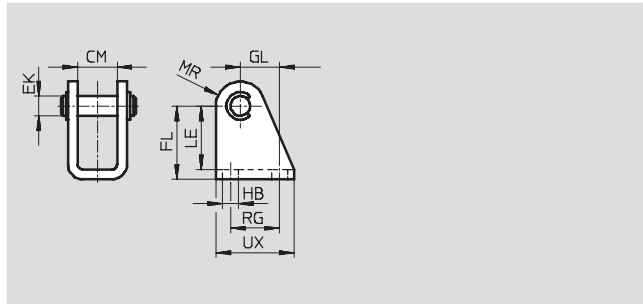

Dimensions and ordering data													
For \varnothing	CM	EK \varnothing	FL	GL	HB \varnothing	LE	MR	RG	UX	CRC ¹⁾	Weight [g]	Part No.	Type
[mm]													
12/16	12.1	6	27 +0.3/-0.2	13	5.5	24	7	15	25	4	55	161 862	CRLBN-12/16
20/25	16.1	8	30 +0.4/-0.2	16	6.6	26	10	20	32	4	62	161 863	CRLBN-20/25

1) Corrosion resistance class 4 to Festo standard 940 070
Components requiring higher corrosion resistance. Parts used with aggressive media, e.g. food or chemical industry. These applications should be supported with special tests with the media if required

Compact cylinders ADN/AEN, to ISO 21287

Accessories

FESTO

Swivel flange SNCB/SNCB-...-R3

Material:
SNCB: Die-cast aluminium
SNCB-...-R3: Die-cast aluminium with protective coating, high corrosion protection
Free of copper, PTFE and silicone

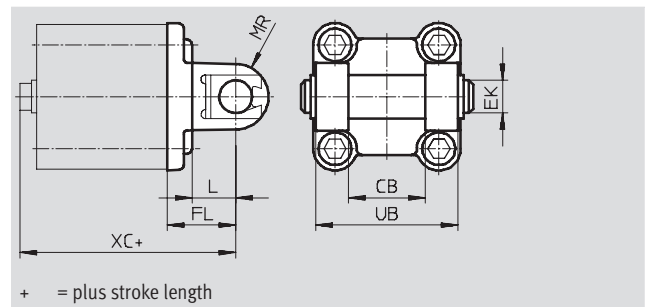

+ = plus stroke length

Dimensions and ordering data							
For \varnothing	CB	EK	FL	L	MR	UB	XC
[mm]	H14	\varnothing e8	± 0.2			h14	
32	26	10	22	13	8.5	45	72
40	28	12	25	16	12	52	76
50	32	12	27	16	12	60	80
63	40	16	32	21	16	70	89
80	50	16	36	22	16	90	99
100	60	20	41	27	20	110	117
125	70	25	50	30	25	130	142

For \varnothing	Basic version				R3 – High corrosion protection			
	CRC ¹⁾	Weight [g]	Part No.	Type	CRC ¹⁾	Weight [g]	Part No.	Type
[mm]								
32	2	100	174 390	SNCB-32	3	100	176 944	SNCB-32-R3
40	2	150	174 391	SNCB-40	3	150	176 945	SNCB-40-R3
50	2	225	174 392	SNCB-50	3	225	176 946	SNCB-50-R3
63	2	365	174 393	SNCB-63	3	365	176 947	SNCB-63-R3
80	2	610	174 394	SNCB-80	3	610	176 948	SNCB-80-R3
100	2	925	174 395	SNCB-100	3	925	176 949	SNCB-100-R3
125	2	1785	174 396	SNCB-125	3	1785	176 950	SNCB-125-R3

1) Corrosion resistance class 2 to Festo standard 940 070
Components subject to moderate corrosion stress. Externally visible parts with primarily decorative surface requirements which are in direct contact with a normal industrial environment or media such as coolants or lubricating agents.
Corrosion resistance class 3 to Festo standard 940 070
Components requiring higher corrosion resistance. External visible parts in direct contact with industrial atmospheres or media such as solvents and cleaning agents, with a predominantly functional requirement for the surface

Compact cylinders ADN/AEN, to ISO 21287

Accessories

FESTO

Trunnion flange ZNCF/CRZNG

Material:

ZNCF: Special steel casting
 CRZNG: Electrolytically polished special steel casting
 Free of copper, PTFE and silicone

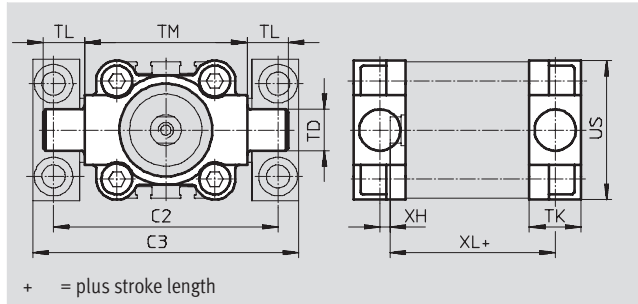

Dimensions and ordering data									
For \varnothing	C2	C3	TD	TK	TL	TM	US	XH	XL
[mm]			\varnothing e9						
32	71	86	12	16	12	50	45	2	52
40	87	105	16	20	16	63	54	4	55
50	99	117	16	24	16	75	64	4	57
63	116	136	20	24	20	90	75	4	61
80	136	156	20	28	20	110	93	5	81
100	164	189	25	38	25	132	110	10	86
125	192	217	25	50	25	160	131	14	106

For \varnothing	Basic version				R3 – High corrosion protection			
	CRC ¹⁾	Weight [g]	Part No.	Type	CRC ¹⁾	Weight [g]	Part No.	Type
[mm]								
32	2	130	174 411	ZNCF-32	4	150	161 852	CRZNG-32
40	2	240	174 412	ZNCF-40	4	260	161 853	CRZNG-40
50	2	390	174 413	ZNCF-50	4	430	161 854	CRZNG-50
63	2	600	174 414	ZNCF-63	4	640	161 855	CRZNG-63
80	2	1150	174 415	ZNCF-80	4	1300	161 856	CRZNG-80
100	2	2030	174 416	ZNCF-100	4	2400	161 857	CRZNG-100
125	2	3490	174 417	ZNCF-125	4	3600	185 362	CRZNG-125

1) Corrosion resistance class 2 to Festo standard 940 070
 Components subject to moderate corrosion stress. Externally visible parts with primarily decorative surface requirements which are in direct contact with a normal industrial environment or media such as coolants or lubricating agents.
 Corrosion resistance class 4 to Festo standard 940 070
 Components requiring higher corrosion resistance. Parts used with aggressive media, e.g. food or chemical industry. These applications should be supported with special tests with the media if required

Compact cylinders ADN/AEN, to ISO 21287

Accessories

Trunnion support LNZG

Material:

Trunnion support: Anodised aluminium

Plain bearing: Plastic

Free of copper, PTFE and silicone

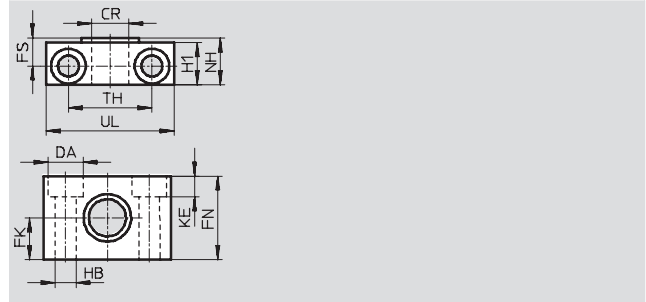
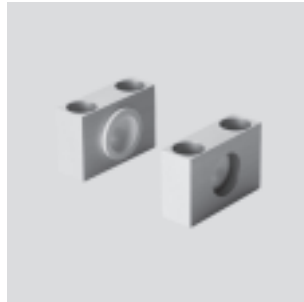

Dimensions and ordering data														Weight	Part No.	Type
For \varnothing	CR	DA	FK	FN	FS	H1	HB	KE	NH	TH	UL	CRC ¹⁾				
[mm]	\varnothing D11	\varnothing H13	\varnothing ± 0.1				\varnothing H13			± 0.2				[g]		
32	12	11	15	30	10.5	15	6.6	6.8	18	32	46	2		125	32 959	LNZG-32
40, 50	16	15	18	36	12	18	9	9	21	36	55	2		400	32 960	LNZG-40/50
63, 80	20	18	20	40	13	20	11	11	23	42	65	2		480	32 961	LNZG-63/80
100, 125	25	20	25	50	16	24.5	14	13	28.5	50	75	2		960	32 962	LNZG-100/125







1) Corrosion resistance class 2 to Festo standard 940 070

Components subject to moderate corrosion stress. Externally visible parts with primarily decorative surface requirements which are in direct contact with a normal industrial environment or media such as coolants or lubricating agents

Compact cylinders ADN/AEN, to ISO 21287

Accessories

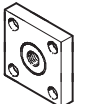
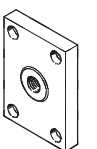

FESTO

Ordering data – Piston rod attachments				Technical data → Internet: piston-rod attachment			
Designation	For Ø	Part No.	Type	Designation	For Ø	Part No.	Type
Rod eye SGS				Rod clevis SGA used in combination with rod eye SGS			
	12	–			12, 16, 20, 25	–	
	16	9 254	SGS-M6		32, 40	32 954	SGA-M10x1,25
	20, 25	9 255	SGS-M8		50, 63	10 767	SGA-M12x1,25
	32, 40	9 261	SGS-M10x1,25		80, 100	10 768	SGA-M16x1,25
	50, 63	9 262	SGS-M12x1,25		125	10 769	SGA-M20x1,25
	80, 100	9 263	SGS-M16x1,5				
	125	9 264	SGS-M20x1,5				
Rod clevis SG				Self-aligning rod coupler FK			
	12	–			12	30 984	FK-M5
	16	3 110	SG-M6		16	2 061	FK-M6
	20, 25	3 111	SG-M8		20, 25	2 062	FK-M8
	32, 40	6 144	SG-M10x1,25		32, 40	6 140	FK-M10x1,25
	50, 63	6 145	SG-M12x1,25		50, 63	6 141	FK-M12x1,25
	80, 100	6 146	SG-M16x1,5		80, 100	6 142	FK-M16x1,5
	125	6 147	SG-M20x1,5		125	6 143	FK-M20x1,5
Coupling piece KSG				Coupling piece KSZ			
	12, 16, 20, 25	–			12	–	
	32, 40	32 963	KSG-M10x1,25		16	36 123	KSZ-M6
	50, 63	32 964	KSG-M12x1,25		20, 25	36 124	KSZ-M8
	80, 100	32 965	KSG-M16x1,5		32, 40	36 125	KSZ-M10x1,25
	125	32 966	KSG-M20x1,5		50, 63	36 126	KSZ-M12x1,25
			80, 100		36 127	KSZ-M16x1,5	
			125	36 128	KSZ-M20x1,5		
Adapter AD							
	12	–					
	16	157 328	AD-M6-M5				
		157 329	AD-M6-1/8				
		157 330	AD-M6-1/4				
	20	157 331	AD-M8-1/8				
	25	157 332	AD-M8-1/4				
	32	157 333	AD-M10x1,25-1/8				
	40	157 334	AD-M10x1,25-1/4				
	50	160 256	AD-M12x1,25-1/4				
63	160 257	AD-M12x1,25-3/8					

Compact cylinders ADN/AEN, to ISO 21287

Accessories

FESTO

Ordering data – Corrosion and acid resistant piston rod attachments				Technical data → Internet: crsg			
Designation	For Ø	Part No.	Type	Designation	For Ø	Part No.	Type
Rod eye CRSGS				Rod clevis CRSG			
	12	–			12	–	
	16	195 580	CRSGS-M6		16, 20	13 567	CRSG-M6
	20, 25	195 581	CRSGS-M8		20, 25	13 568	CRSG-M8
	32, 40	195 582	CRSGS-M10x1,25		32, 40	13 569	CRSG-M10x1,25
	50, 63	195 583	CRSGS-M12x1,25		50, 63	13 570	CRSG-M12x1,25
	80, 100	195 584	CRSGS-M16x1,5		80, 100	13 571	CRSG-M16x1,5
	125	195 585	CRSGS-M20x1,5		125	13 572	CRSG-M20x1,5

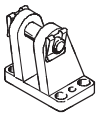
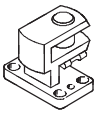
Ordering data – Mounting attachments				Technical data → Internet: clevis foot			
Designation	For Ø	Part No.	Type	Designation	For Ø	Part No.	Type
Clevis foot LBG for rod eye SGS				Right-angle clevis foot LQG for rod eye SGS			
	32, 40	31 761	LBG-32		32, 40	31 768	LQG-32
	50, 63	31 762	LBG-40		50, 63	31 769	LQG-40
	80, 100	31 763	LBG-50		80, 100	31 770	LQG-50
		31 764	LBG-63			31 771	LQG-63
	125	31 765	LBG-80		125	31 772	LQG-80
31 766		LBG-100	31 773	LQG-100			

Ordering data – One-way flow control valves				Technical data → Internet: grla				
Designation	Connection		Material	Part No.	Type			
	For Ø	For tubing O.D.						
For exhaust air								
	12, 16, 20, 25	3	Metal design	193 137	GRLA-M5-QS-3-D			
		4			193 138	GRLA-M5-QS-4-D		
		6			193 139	GRLA-M5-QS-6-D		
	32, 40, 50, 63, 80, 100	3			193 142	GRLA-1/8-QS-3-D		
		4			193 143	GRLA-1/8-QS-4-D		
		6			193 144	GRLA-1/8-QS-6-D		
		8			193 145	GRLA-1/8-QS-8-D		
		125			6	193 146	GRLA-1/4-QS-6-D	
					8	193 147	GRLA-1/4-QS-8-D	
	10				193 148	GRLA-1/4-QS-10-D		



Compact cylinders ADN/AEN, to ISO 21287

Accessories

FESTO

Ordering data – One-way flow control valves				Technical data → Internet: grlz	
	Connection		Material	Part No.	Type
	For Ø	For tubing O.D.			
For supply air					
	12, 16, 20, 25	3	Metal design	193 153	GRLZ-M5-QS-3-D
		4		193 154	GRLZ-M5-QS-4-D
		6		193 155	GRLZ-M5-QS-6-D
	32, 40, 50, 63, 80, 100	3		193 156	GRLZ-1/8-QS-3-D
		4		193 157	GRLZ-1/8-QS-4-D
		6		193 158	GRLZ-1/8-QS-6-D
		8		193 159	GRLZ-1/8-QS-8-D
	125	–		151 195	GRLZ-1/4-B

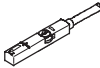

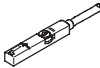
Ordering data – One-way flow control valves for cylinder ADNP			Technical data → Internet: vfo	
	Connection		Part No.	Type
	For Ø			
Inline				
	20, 25		540 362	VFOC-E-S4-Q4
	32, 40, 50		540 363	VFOC-E-S6-Q6



Ordering data – Proximity sensors for T-slot, magneto-resistive					Technical data → Internet: smt	
	Type of mounting	Switch output	Electrical connection	Cable length [m]	Part No.	Type
	Insertable in the slot from above, flush with cylinder profile	PNP	Cable, 3-wire	2.5	543 867	SMT-8M-PS-24V-K-2,5-OE
			Plug M8x1, 3-pin	0.3	543 866	SMT-8M-PS-24V-K-0,3-M8D
			Plug M12x1, 3-pin	0.3	543 869	SMT-8M-PS-24V-K-0,3-M12
	Insertable in the slot lengthwise, flush with the cylinder profile	NPN	Cable, 3-wire	2.5	543 870	SMT-8M-NS-24V-K-2,5-OE
			Plug M8x1, 3-pin	0.3	543 871	SMT-8M-NS-24V-K-0,3-M8D
N/C contact						
	Insertable in the slot from above, flush with cylinder profile	PNP	Cable, 3-wire	7.5	543 873	SMT-8M-PO-24V-K7,5-OE

Compact cylinders ADN/AEN, to ISO 21287

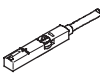
Accessories

FESTO

Ordering data – Proximity sensors for T-slot, magnetic reed					Technical data → Internet: sme	
	Type of mounting	Switch output	Electrical connection	Cable length [m]	Part No.	Type
N/O contact						
	Insertable in the slot from above, flush with cylinder profile	Contacting	Cable, 3-wire	2.5	543 862	SME-8M-DS-24V-K-2,5-OE
				5.0	543 863	SME-8M-DS-24V-K-5,0-OE
			Plug M8x1, 3-pin	2.5	543 872	SME-8M-ZS-24V-K-2,5-OE
				0.3	543 861	SME-8M-DS-24V-K-0,3-M8D
	Insertable in the slot lengthwise, flush with the cylinder profile	Contacting	Cable, 3-wire	2.5	150 855	SME-8-K-LED-24
			Plug M8x1, 3-pin	0.3	150 857	SME-8-S-LED-24
N/C contact						
	Insertable in the slot lengthwise, flush with the cylinder profile	Contacting	Cable, 3-wire	7.5	160 251	SME-8-O-K-LED-24

Ordering data – Connecting cables				Technical data → Internet: nebu	
	Electrical connection, left	Electrical connection, right	Cable length [m]	Part No.	Type
	Straight socket, M8x1, 3-pin	Cable, open end, 3-wire	2.5	541 333	NEBU-M8G3-K-2.5-LE3
			5	541 334	NEBU-M8G3-K-5-LE3
	Straight socket, M12x1, 5-pin	Cable, open end, 3-wire	2.5	541 363	NEBU-M12G5-K-2.5-LE3
			5	541 364	NEBU-M12G5-K-5-LE3
	Angled socket, M8x1, 3-pin	Cable, open end, 3-wire	2.5	541 338	NEBU-M8W3-K-2.5-LE3
			5	541 341	NEBU-M8W3-K-5-LE3
	Angled socket, M12x1, 5-pin	Cable, open end, 3-wire	2.5	541 367	NEBU-M12W5-K-2.5-LE3
			5	541 370	NEBU-M12W5-K-5-LE3

Ordering data – Rectangular proximity sensors, pneumatic			Technical data → Internet: smpo	
	Pneumatic connection		Part No.	Type
3/2-way valve, normally closed				
	Female thread M5		178 563	SMPO-8E

Ordering data – Mounting kits for proximity sensors SMPO-8E			Technical data → Internet: smb	
	Assembly		Part No.	Type
	Clamped in T-slot		178 230	SMB-8E

Ordering data – Slot cover for T-slot				
	Assembly	Length	Part No.	Type
	Insertable from above	2x 0.5 m	151 680	ABP-5-S

Product Range and Company Overview

A Complete Suite of Automation Services

Our experienced engineers provide complete support at every stage of your development process, including: conceptualization, analysis, engineering, design, assembly, documentation, validation, and production.



Custom Automation Components
Complete custom engineered solutions



Custom Control Cabinets
Comprehensive engineering support and on-site services



Complete Systems
Shipment, stocking and storage services

The Broadest Range of Automation Components

With a comprehensive line of more than 30,000 automation components, Festo is capable of solving the most complex automation requirements.



Electromechanical
Electromechanical actuators, motors, controllers & drives



Pneumatics
Pneumatic linear and rotary actuators, valves, and air supply



PLCs and I/O Devices
PLC's, operator interfaces, sensors and I/O devices

Supporting Advanced Automation... As No One Else Can!

Festo is a leading global manufacturer of pneumatic and electromechanical systems, components and controls for industrial automation, with more than 12,000 employees in 56 national headquarters serving more than 180 countries. For more than 80 years, Festo has continuously elevated the state of manufacturing with innovations and optimized motion control solutions that deliver higher performing, more profitable automated manufacturing and processing equipment. Our dedication to the advancement of automation extends beyond technology to the education and development of current and future automation and robotics designers with simulation tools, teaching programs, and on-site services.

Quality Assurance, ISO 9001 and ISO 14001 Certifications

Festo Corporation is committed to supply all Festo products and services that will meet or exceed our customers' requirements in product quality, delivery, customer service and satisfaction.

To meet this commitment, we strive to ensure a consistent, integrated, and systematic approach to management that will meet or exceed the requirements of the ISO 9001 standard for Quality Management and the ISO 14001 standard for Environmental Management.



© Copyright 2008, Festo Corporation. While every effort is made to ensure that all dimensions and specifications are correct, Festo cannot guarantee that publications are completely free of any error, in particular typing or printing errors. Accordingly, Festo cannot be held responsible for the same. For Liability and Warranty conditions, refer to our "Terms and Conditions of Sale", available from your local Festo office. All rights reserved. No part of this publication may be reproduced, distributed, or transmitted in any form or by any means, electronic, mechanical, photocopying or otherwise, without the prior written permission of Festo. All technical data subject to change according to technical update.



Printed on recycled paper at New Horizon Graphic, Inc., FSC certified as an environmentally friendly printing plant.

Festo North America

Festo Regional Contact Center

5300 Explorer Drive
Mississauga, Ontario L4W 5G4
Canada

USA Customers:

For ordering assistance,

Call: 1.800.99.FESTO (1.800.993.3786)

Fax: 1.800.96.FESTO (1.800.963.3786)

Email: customer.service@us.festo.com

For technical support,

Call: 1.866.GO.FESTO (1.866.463.3786)

Fax: 1.800.96.FESTO (1.800.963.3786)

Email: product.support@us.festo.com

Canadian Customers:

Call: 1.877.GO.FESTO (1.877.463.3786)

Fax: 1.877.FX.FESTO (1.877.393.3786)

Email: festo.canada@ca.festo.com

USA Headquarters

Festo Corporation
395 Moreland Road
P.O. Box 18023
Hauppauge, NY 11788, USA
www.festo.com/us

USA Sales Offices

Appleton

North 922 Tower View Drive, Suite N
Greenville, WI 54942, USA

Boston

120 Presidential Way, Suite 330
Woburn, MA 01801, USA

Chicago

1441 East Business Center Drive
Mt. Prospect, IL 60056, USA

Dallas

1825 Lakeway Drive, Suite 600
Lewisville, TX 75057, USA

Detroit – Automotive Engineering Center

2601 Cambridge Court, Suite 320
Auburn Hills, MI 48326, USA

New York

395 Moreland Road
Hauppauge, NY 11788, USA

Silicon Valley

4935 Southfront Road, Suite F
Livermore, CA 94550, USA

United States



USA Headquarters, East: Festo Corp., 395 Moreland Road, Hauppauge, NY 11788

Phone: 1.631.435.0800; Fax: 1.631.435.8026;

Email: info@festo-usa.com

www.festo.com/us

Canada



Headquarters: Festo Inc., 5300 Explorer Drive, Mississauga, Ontario L4W 5G4

Phone: 1.905.624.9000; Fax: 1.905.624.9001;

Email: festo.canada@ca.festo.com

www.festo.ca

Mexico



Headquarters: Festo Pneumatic, S.A., Av. Ceylán 3, Col. Tequesquahuac,
54020 Tlalneantla, Edo. de México

Phone: 011 52 [55] 53 21 66 00; Fax: 011 52 [55] 53 21 66 65;

Email: festo.mexico@mx.festo.com

www.festo.com/mx

Central USA

Festo Corporation
1441 East Business
Center Drive
Mt. Prospect, IL 60056, USA
Phone: 1.847.759.2600
Fax: 1.847.768.9480



Western USA

Festo Corporation
4935 Southfront Road,
Suite F
Livermore, CA 94550, USA
Phone: 1.925.371.1099
Fax: 1.925.245.1286



Festo Worldwide

Argentina Australia Austria Belarus Belgium Brazil Bulgaria Canada Chile China Colombia Croatia Czech Republic Denmark
Estonia Finland France Germany Great Britain Greece Hong Kong Hungary India Indonesia Iran Ireland Israel Italy Japan Latvia
Lithuania Malaysia Mexico Netherlands New Zealand Norway Peru Philippines Poland Romania Russia Serbia Singapore
Slovakia Slovenia South Africa South Korea Spain Sweden Switzerland Taiwan Thailand Turkey Ukraine United States Venezuela

www.festo.com