

Vacuum gauges

FESTO



Vacuum gauges

Technical data

FESTO

Vacuum gauge VAM, EN 837-1

Function



-  - Temperature range
-10 ... +60 °C

-  - Pressure
-1 ... +9 bar

- Analogue display via Bourdon tube
- Vacuum gauges can be loaded up to $\frac{3}{4}$ of their full scale value under static load and up to $\frac{2}{3}$ under intermittent load conditions



General technical data			
Nominal tubing size, pressure gauge	40	63	
Type	VAM-40-V1/0	VAM-63-V1/0	VAM-63-V1/9
Pneumatic connection	R $\frac{1}{8}$	R $\frac{1}{4}$	
Operating pressure [bar]	-1 ... 0	-1 ... 0	-1 ... +9
Operating medium	Dried air, lubricated or unlubricated, vacuum		
Design	Bourdon tube pressure gauge		
Based on standard	EN 837-1		
Type of mounting	Can be screwed in		
Type of seal on threaded plug	Coating		
Mounting position	Any		
Connection position	Centre, rear side		
Ambient temperature [°C]	-10 ... +60		
Medium temperature [°C]	-20 ... +60		
Accuracy of measurement, class	2.5		
Factor, continuous load	0.75		
Factor, intermittent load	0.66		

Display			
Nominal tubing size, pressure gauge	40	63	
Type	VAM-40-V1/0	VAM-63-V1/0	VAM-63-V1/9
Scale	Double scale	Double scale	Double scale
	bar (outer)	bar (outer)	bar (outer)
	inchHg (inner)	inchHg (inner)	inchHg/psi (inner)
Indicating range [bar]	-1 ... 0	-1 ... 0	-1 ... +9
	[inchHg]	-30 ... 0	-30 ... 0
	[psi]	-	0 ... +130

Product weights [g]		
Nominal tubing size, pressure gauge	40	63
VAM	63	83

Materials	
Housing	Acrylic butadiene styrene
Window shield	Polystyrene
Threaded plug	Brass
Note on materials	RoHS-compliant

Vacuum gauges

Technical data

FESTO

Dimensions

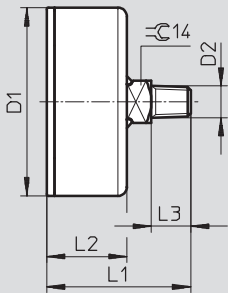

Type	D1 ∅	D2	L1	L2	L3
VAM-40	39 ±0.5	R1/8	46 ±1	26 ±0.5	12
VAM-63-V1/0	62 ±0.5	R1/4	50 ±1	29 ±0.5	13
VAM-63-V1/9	62 ±0.5	R1/4	47.5 ±1	26.5 ±0.5	13

Ordering data

Nominal tubing size, pressure gauge	Pneumatic connection	Indicating range			Part No.	Type
		[bar]	[inchHg]	[psi]		
40	R1/8	-1 ... 0	-30 ... 0	-	537810	VAM-40-V1/0-R1/8-EN
63	R1/4	-1 ... 0	-30 ... 0	-	537811	VAM-63-V1/0-R1/4-EN
		-1 ... 9	-30 ... 0	0 ... +130	537814	VAM-63-V1/9-R1/4-EN

Vacuum gauges

Technical data

FESTO

Vacuum gauge VAM, EN 837-1,
with red-green range

•  Temperature range
-10 ... +60 °C

Function



•  Pressure
-1 ... 0 bar

- Analogue display via Bourdon tube
- Vacuum gauges can be loaded up to $\frac{3}{4}$ of their full scale value under static load and up to $\frac{2}{3}$ under intermittent load conditions
- The adjustable red-green range provides additional safety when monitoring compressed air



General technical data		
Nominal tubing size, pressure gauge	40	63
Type	VAM-40-V1/0-R $\frac{1}{8}$	VAM-63-V1/0-R $\frac{1}{4}$
Pneumatic connection	R $\frac{1}{8}$	R $\frac{1}{4}$
Operating pressure [bar]	-1 ... 0	
Operating medium	Dried air, lubricated or unlubricated	
Design	Bourdon tube pressure gauge	
Based on standard	EN 837-1	
Type of mounting	Can be screwed in	
Type of seal on threaded plug	Coating	
Mounting position	Any	
Connection position	Centre, rear side	
Ambient temperature [°C]	-10 ... +60	
Medium temperature [°C]	-20 ... +60	
Accuracy of measurement, class	2.5	
Factor, continuous load	0.75	
Factor, intermittent load	0.66	

Display		
Nominal tubing size, pressure gauge	40	63
Type	VAM-40-V1/0-R $\frac{1}{8}$	VAM-63-V1/0-R $\frac{1}{4}$
Scale	Single scale	Single scale
	bar	bar
Indicating range [bar]	-1 ... 0	

Product weights [g]		
Nominal tubing size, pressure gauge	40	63
Type	VAM-40-V1/0-R $\frac{1}{8}$	VAM-63-V1/0-R $\frac{1}{4}$
VAM	65	90

Materials	
Housing	Acrylic butadiene styrene
Window shield	Polystyrene
Segment	Polystyrene
Threaded plug	Brass

Vacuum gauges

Technical data

FESTO

Dimensions

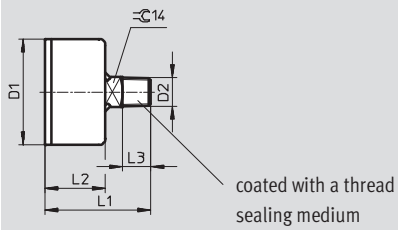

Type	D1 Ø	D2	L1	L2	L3
VAM-40-...-E-RG	39 ±0.5	R $\frac{1}{8}$	48.5 ±1	28.5 ±0.5	12
VAM-63-...-E-RG	62 ±0.5	R $\frac{1}{4}$	53 ±1	32 ±0.5	13

Ordering data

Nominal tubing size, pressure gauge	Pneumatic connection	Indicating range	Part No.	Type
		[bar]		
40	R $\frac{1}{8}$	-1 ... 0	547842	VAM-40-V1/0-R $\frac{1}{8}$ -E-RG
63	R $\frac{1}{4}$	-1 ... 0	547843	VAM-63-V1/0-R $\frac{1}{4}$ -E-RG

Vacuum gauges

Technical data

FESTO

Vacuum gauge FVAM, EN 837-1

Function



-  - Temperature range
-10 ... +60 °C

-  - Pressure
-1 ... 0 bar

- Analogue display via Bourdon tube
- Vacuum gauges can be loaded up to $\frac{3}{4}$ of their full scale value under static load and up to $\frac{2}{3}$ under intermittent load conditions.



General technical data		
Nominal tubing size, pressure gauge	40	63
Pneumatic connection	G $\frac{1}{8}$	G $\frac{1}{4}$
Operating pressure [bar]	-1 ... 0	-1 ... 0
Operating medium	Dried air, lubricated or unlubricated, vacuum	
Design	Bourdon tube pressure gauge	
Based on standard	EN 837-1	
Type of mounting	Panel mounting	
Type of seal on threaded plug	Coating	
Mounting position	Any	
Connection position	Centre, rear side	
Ambient temperature [°C]	-10 ... +60	
Medium temperature [°C]	-20 ... +60	
Accuracy of measurement, class	2.5	
Factor, continuous load	0.75	
Factor, intermittent load	0.66	

Display		
Nominal tubing size, pressure gauge	40	63
Scale	Double scale	Double scale
	bar (outer)	bar (outer)
	inchHg (inner)	inchHg (inner)
Indicating range [bar]	-1 ... 0	-1 ... 0
	[inchHg] -30 ... 0	-30 ... 0

Product weights [g]		
Nominal tubing size, pressure gauge	40	63
FVAM	81	121

Materials	
Housing	Acrylic butadiene styrene
Window shield	Polymethylmethacrylate
Threaded plug	Brass
Note on materials	RoHS-compliant

Vacuum gauges

Technical data

FESTO

Dimensions

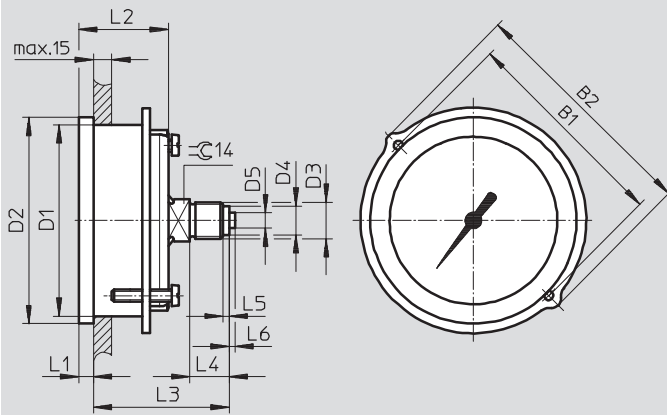

Type	B1	B2	D1 Ø	D2 Ø	D3	D4 Ø	D5 Ø	L1	L2	L3	L4	L5	L6
FVAM-40	48	56	40	45	G $\frac{1}{8}$	8	–	4.5	26.5	40	10	2	–
FVAM-63	70	79	63	68	G $\frac{1}{4}$	9.5	5	4.8	29.5	42.5	13	2	2

Ordering data

Nominal tubing size, pressure gauge	Pneumatic connection	Indicating range		Part No.	Type
		[bar]	[inchHg]		
40	G $\frac{1}{8}$	–1 ... 0	–30 ... 0	537812	FVAM-40-V1/0-G $\frac{1}{8}$ -EN
63	G $\frac{1}{4}$	–1 ... 0	–30 ... 0	537813	FVAM-63-V1/0-G $\frac{1}{4}$ -EN