

Valve terminals type 44/45, VTSA/VTSA-F, NPT

FESTO

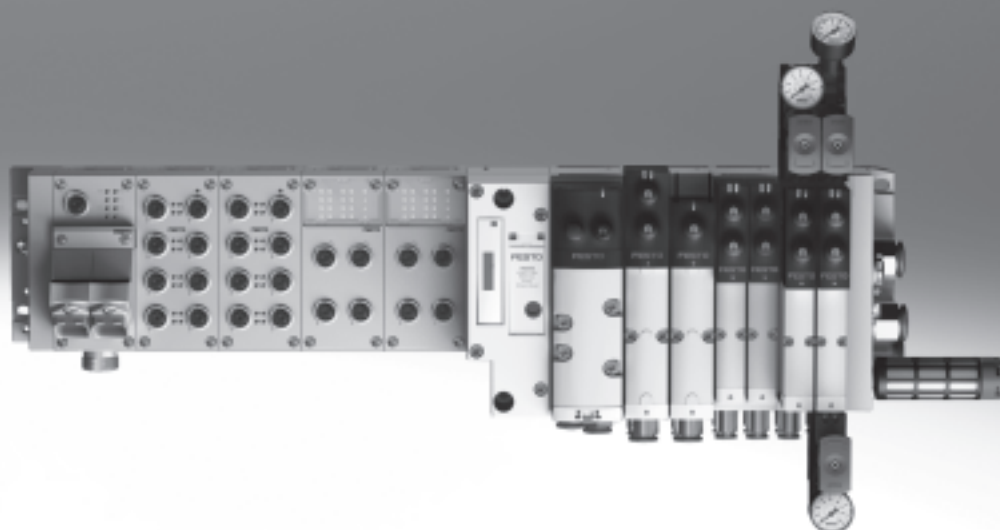

Valve terminals type 44/45, VTSA/VTSA-F, NPT

Key features – ISO 15407-2, width 18 and 26 mm; ISO 5599-2, width 42 and 52 mm

FESTO

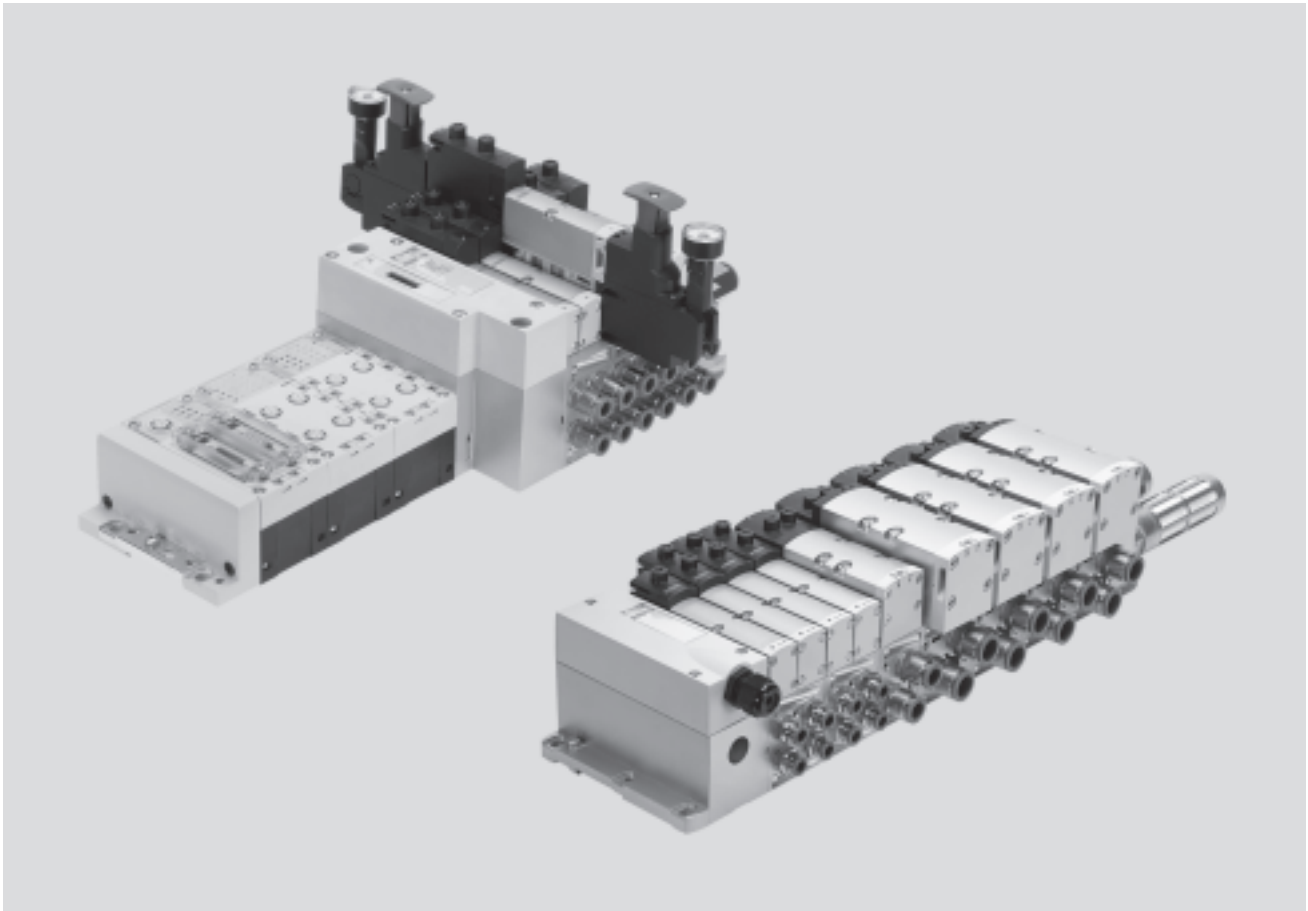

Innovative

- High-performance valves in sturdy metal housing
- Four valve sizes on one valve terminal
- Standardised from the multi-pin plug to the fieldbus connection and control block
- Dream team: fieldbus valve terminal suitable for CPX electrical peripherals. This means:
 - Forward-looking internal communication system for actuating the valves and CPX modules
 - Four valve sizes on one valve terminal without adapters
- Valve functions for integration in control architectures of higher categories to EN ISO 13849-1

Versatile

- Modular system offering a range of configuration options
- Expandable with up to 32 solenoid coils
- Conversions and extensions are possible at any time
- Manifold sub-bases can be extended using four screws, sturdy duct separation on metal substrate
- Integration of innovative function modules possible
- Supply plates enable a flexible air supply and variable pressure zones
- Reverse operation
- High pressure range
–0.9 ... 10 bar
Flow range from 400 l/min up to 4,000 l/min
- Wide range of valve functions
- Valve supply: 24 V DC or 110 V AC

Reliable

- Sturdy and durable metal components
 - Valves
 - Manifold sub-bases
 - Seals
- Fast troubleshooting thanks to LEDs on the valves and diagnostics via fieldbus
- Reliability of service thanks to valves that can be replaced quickly and easily
- Manual override either non-detenting, non-detenting/detenting or covered
- Durable thanks to tried-and-tested piston spool valves
- Large and durable labelling system
- 100% duty cycle

Easy to mount

- Ready-to-install and tested unit
- Lower selection, ordering, installation and commissioning costs
- Secure mounting on wall or H-rail

Valve terminals type 44/45, VTSA/VTSA-F, NPT

Key features – ISO 15407-2, width 18 and 26 mm; ISO 5599-2, width 42 and 52 mm

Reduced downtimes:
On-the-spot diagnostics via LEDs

Width 18 mm, 26 mm, 42 mm and 52 mm can be combined on a single valve terminal without adapter

Pneumatic interface to CPX

Simple electrical connections
– Fieldbus connection via CPX
– Multi-pin plug connection with pre-assembled cable or terminal strip (Cage Clamp®)
– Control block via CPX
– AS-interface
– Individual connection

CPX diagnostic interface for handheld devices (channel-oriented diagnostics down to the individual valve)

Quick mounting:
Direct mounting using screws or H-rail

Safe:
Valves, outputs and logic voltage can be switched off separately

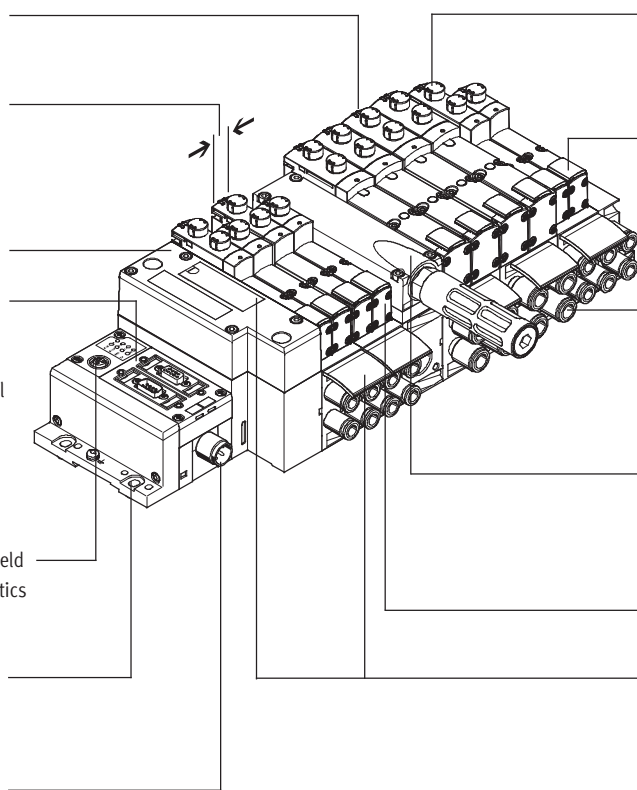

Reliable operation:
Manual override, non-detenting/detenting or covered

Flexible:
– 32 valve positions/32 solenoid coils
– One valve series for a wide range of flow rates

Functional:
Large ports, flow-optimised ducts, sturdy metal thread or pre-assembled QS connectors

Modular:
Supply plates facilitate the creation of multiple pressure zones as well as numerous additional exhaust and supply ports

Comprehensive range of valve functions

Practical:
Large inscription labels

Equipment options

Valve functions

- 2x 2/2-way valve, single solenoid, pneumatic spring, normally closed
- 2x 3/2-way valve, single solenoid
 - Normally open
 - Normally open, reversible
 - Normally closed
 - Normally closed, reversible
- 2x 3/2-way valve, single solenoid
 - 1x normally open, 1x normally closed
 - 1x normally open, 1x normally closed, reversible
- 5/2-way valve
 - Single solenoid, pneumatic spring/mechanical spring
 - Double solenoid
 - Double solenoid with dominant signal
- 5/2-way valve for special functions, single solenoid
 - Mechanical spring
 - Switching position sensing via inductive sensors with PNP or NPN output
 - Protection against unexpected start-up to EN 1037
 - Reversing
- 5/3-way valve
 - Mid-position pressurised
 - Mid-position closed
 - Mid-position exhausted
- 5/3-way valve for special functions
 - Switching position 14 with memory function (switching position 14 is retained in the event of an emergency-stop application/power failure) since there is no spring return on switching position 12
 - Only for valve terminal (plug-in)
 - Mid-position exhausted or mid-position 1 → 2, 4 → 5
 - Switching position 14 with memory function
 - Pneumatic spring return
- Soft-start valve for slow and safe pressure build-up
 - High degree of safety
 - Safe pressurisation by means of sensor function

Valve terminals type 44/45, VTSA/VTSA-F, NPT

Key features – ISO 15407-2, width 18 and 26 mm; ISO 5599-2, width 42 and 52 mm

Special features			
Individual valve on individual sub-base up to width 52 mm		Valve terminal with fieldbus connection and electrical peripherals	
Plug-in <ul style="list-style-type: none"> Electrical connection via standardised 4-pin M12 plug or via 4-pin spring-loaded terminal for configuration by the user Available with internal/external pilot air supply 	Square plug or plug-in, with integrated piston position sensing <ul style="list-style-type: none"> Electrical connection to DIN EN 175301-803 type C (square design) or for configuration by the user via 4-pin spring-loaded terminal or cable with open end 	Type CPX <ul style="list-style-type: none"> Max. 32 valve positions/ max. 32 solenoid coils Any compressed air supply Any number of pressure zones 	
Valve terminal with individual connection <ul style="list-style-type: none"> Max. 20 valve positions/ max. 20 solenoid coils Any compressed air supply Any number of pressure zones 	Valve terminal with multi-pin plug connection <ul style="list-style-type: none"> Max. 32 valve positions/ max. 32 solenoid coils Parallel modular valve linking Any compressed air supply Any number of pressure zones 	AS-interface <ul style="list-style-type: none"> 1 to 8 valve positions/ max. 8 solenoid coils Soft-start valve for slow and safe pressure build-up <ul style="list-style-type: none"> High degree of safety Safe pressurisation by means of sensor function 	Combinable <ul style="list-style-type: none"> Width 18 mm: valve flow rate up to 550 (700) l/min Width 26 mm: valve flow rate up to 1,100 (1,400) l/min Width 42 mm: valve flow rate up to 1,400 l/min Width 52 mm: valve flow rate up to 2,900 l/min Width 18 mm, 26 mm, 42 mm and 52 mm can be combined on a single valve terminal
<p> Note</p> <ul style="list-style-type: none"> Valve terminal VTSA complies with ISO 15407-2 in width 18 and 26 mm and with ISO 5599-2 in width 42 and 52 mm 			

Values in brackets apply to type 45, VTSA-F

Valve terminal configurator			→ Internet: www.festo.com
A valve terminal configurator is available to help you select a suitable VTSA/VTSA-F valve terminal. This makes it much easier to order the right product.	The valve terminals are fully assembled according to your order specification and are individually tested. This reduces assembly and installation time to a minimum.	You order a valve terminal VTSA using the order code:	You order a valve terminal VTSA-F using the order code:
		Ordering system for VTSA → Internet: vtsa	Ordering system for VTSA-F → Internet: vtsa-f
		Ordering system for CPX → Internet: cpx	Ordering system for CPX → Internet: cpx

Valve terminals type 44/45, VTSA/VTSA-F, NPT

Key features – ISO 15407-2, width 18 and 26 mm; ISO 5599-2, width 42 and 52 mm

Individual pneumatic connection

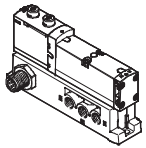

Valves on individual sub-bases can be used for actuators further away from the valve terminal.

The electrical connection is established either via a standardised 4-pin M12 plug 24 V DC (EN 61076-2-101), 4-pin

spring-loaded terminal or a cable with open end 24 V DC or 110 V AC, which are configured by the user.

Valve terminal with individual electrical connection

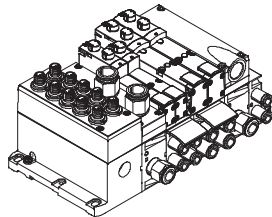

Control signals from the controller to the valve terminal are transmitted via an individual connecting cable.

The valve terminal can be equipped with max. 20 valves and max. 20 solenoid coils.

The electrical connection is established via a 5-pin M12 plug 24 V DC.

Valve terminal with multi-pin plug connection

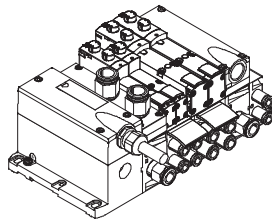

Control signals from the controller to the valve terminal are transmitted via a pre-assembled multi-wire cable or a self-assembled multi-pin plug connection (spring-loaded terminal), which substantially reduces installation time.

The valve terminal can be equipped with max. 32 valves and max. 32 solenoid coils.

Versions

- Multi-pin plug connection with terminal strip (spring-loaded terminal) 24 V DC or 110 V AC
- Pre-assembled connecting cable 24 V DC
- Sub-D plug connector for assembly by the user, 37-pin
- Round plug connector M23, 19-pin, 24 V DC

AS-interface connection

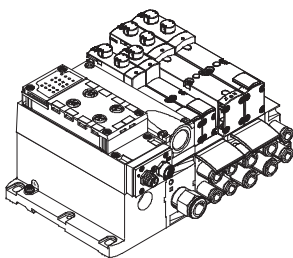

A special feature of the AS-interface is the simultaneous transmission of data and supply power via a two-wire cable. The encoded cable profile prevents connection with incorrect polarity. The valve terminal with AS-interface is available in the following versions:

- With one to eight modular valve positions (max. 8 solenoid coils). This corresponds to one to eight valves VTSA/VTSA-F.
- With all available valve functions. The connection technology used for the inputs can be selected as with

CPX: M8, M12, quick connection, Sub-D, spring-loaded terminal (terminals to IP20).

More information
 → Internet: as-interface



Note

The valve terminal VTSA/VTSA-F with AS-interface connection is based on the same electrical manifold module as the valve terminal with multi-pin plug connection. This means it is possible to convert a valve terminal with multi-pin plug connection using an AS-interface module

(→ page 97). The technical specifications of the AS-interface system must be observed in this case.

→ Page 52
 → Internet: as-interface

Valve terminals type 44/45, VTSA/VTSA-F, NPT

Key features – ISO 15407-2, width 18 and 26 mm; ISO 5599-2, width 42 and 52 mm

Valve terminal with fieldbus connection from the CPX system

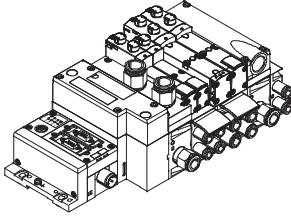

An integrated fieldbus node manages the communication connection with a higher-order PLC. This enables a space-saving pneumatic and electronic solution.

Valve terminals with fieldbus interfaces from the CPX system can be configured with up to 16 manifold sub-bases. With 2 solenoid coils per connection, up to 32 solenoid coils can thus be actuated.

Versions

- Profibus DP
- Interbus
- DeviceNet
- CANopen
- CC-Link
- CPX terminal
- Ethernet/IP
- EtherCAT
- CoDeSys controller
- Modbus/TCP
- PROFINET

➔ Internet: cpx

Valve terminal with control block connection from the CPX system

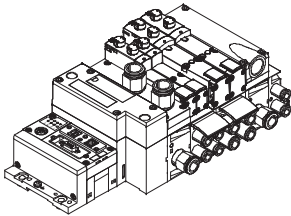

A controller integrated in the Festo valve terminal enables the construction of stand-alone control units with protection to IP65 without a control cabinet thanks to two different operating modes.

In the slave operating mode, these valve terminals can be used for intelligent preprocessing and are therefore ideal modules for designs using decentralised intelligence.

In the master operating mode, terminal groups can be designed with many options and functions that can autonomously control a medium-sized machine/system.

- CPX terminal

➔ Internet: cpx

CP string extension from the CPX system

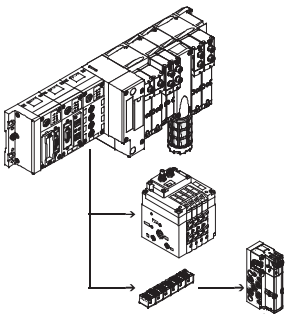

The optional CP string extension enables additional valve terminals and I/O modules to be connected to the fieldbus node of the CPX terminal on up to 4 CP strings. Different input and output modules as well as CPV-SC, CPV and CPA valve terminals can be connected.

The maximum length of the CP string extension is 10 metres, which means that the extension modules can be mounted directly on-site. All of the required electrical signals are transmitted via the CP cable, which in turn means that no further installation is needed on the extension module.

One CP string offers:

- 32 input signals
- 32 output signals for output modules 24 V DC or solenoid coils
- Logic and sensor supply for the input modules
- Load voltage supply for the valve terminals
- Logic supply for the output module

➔ Internet: ctec

Valve terminals type 44/45, VTSA/VTSA-F, NPT

Key features – Valves

Solenoid valve with switching position sensing, width 26 mm

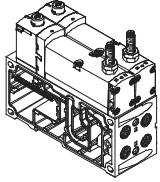

The single solenoid 5/2-way valve with spring return in width 26 mm features switching position sensing. The normal position of the piston spool valve is monitored.

Designed as plug-in or individual connection valve with pilot valves to ISO 15218 and square plug type C. This valve is not a safety component in accordance with the Machinery Directive 2006/42/EC.

It is suitable for use in safety-related parts of control systems to EN ISO 13849-1.

→ Page 99

Control block with safety function, width 26 mm

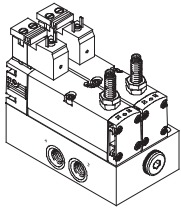

These valves are used for special applications, for example for:

- Protecting against unexpected start-up
- Reversing
- Drives in manually loaded devices

This control block is suitable for use as a press safety valve to EN 962.

This valve is a safety component in accordance with the Machinery Directive 2006/42/EC.

→ Page 105

For holding, blocking a movement (mechanically)

5/3-way valve for special functions; port 2 is pressurised, port 4 exhausted. Switching position 14 features a memory function.

Possible applications:

- Using lifting cylinders
- Using rotary cylinders

For pressureless switching, self-holding, pneumatic operation

5/3-way valve for special functions (3 phases). Mid-position is exhausted. Switching position 14 features a memory function.

Possible applications:

- Pneumatic manual clamps for devices (insert stations)

Pilot air switching valve, width 26 mm

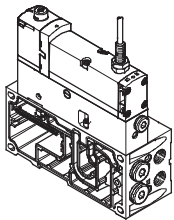

The pilot air switching valve is designed to switch pilot air from duct 1 to 14. The piston position sensing feature of the inductive PNP proximity sensor is realised using a cable and a push-in connector in the size M12x1 to EN 61076-2-104.

This valve is not a safety component in accordance with the Machinery Directive 2006/42/EC.

It is suitable for use in safety-related parts of control systems to EN ISO 13849-1.

→ Page 112



Note

The pilot air switching valve may only be operated on the valve terminal VTSA/VTSA-F in combination with a right-hand end plate for external pilot air type VABE-S6-1RZ-.... Port 14 on the right-hand end plate must be sealed for this.

Soft-start valve, module width 43 mm

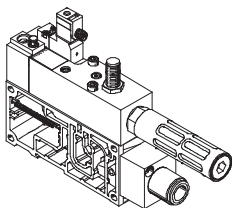

The soft-start valve is separately electrically actuated, independently of the multi-pin plug, AS-interface or fieldbus connection, via a 4-pin plug to ISO 15407-1 or optionally via an M12 adapter.

The valve can optionally be ordered with a sensor that monitors switching of the soft-start valve and in this way supplies the valve terminal or one or more pressure zones with supply air.

The optimum pressure build-up required by the application for each pressure zone is configured directly on the valve terminal by setting the switchover pressure and filling time. A maximum of 5 soft-start valves can be integrated on one valve terminal in this way.

→ Page 118

Valve terminals type 44/45, VTSA/VTSA-F, NPT

Peripherals – ISO 15407-2, width 18 and 26 mm; ISO 5599-2, width 42 and 52 mm

FESTO

Modular pneumatic peripherals

The modular design of the valve terminal VTSA/VTSA-F enables maximum flexibility right from the planning stage and offers maximum ease of service in operation.

The system consists of manifold sub-bases and valves. The manifold sub-bases are screwed together and thus form the support system for the valves.

Inside the manifold sub-bases are the connection ducts for supplying compressed air to and venting from the valves on the terminal as well as the working lines for the pneumatic cylinders for each valve.

Each manifold sub-base is connected to the next using four screws. Individual valve terminal sections can be isolated and further blocks easily inserted by loosening these screws. This ensures that the valve terminal can be rapidly and reliably extended.

Basic system modularity

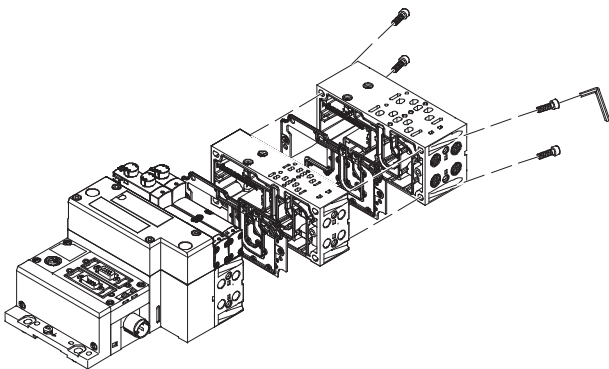

Valve modularity

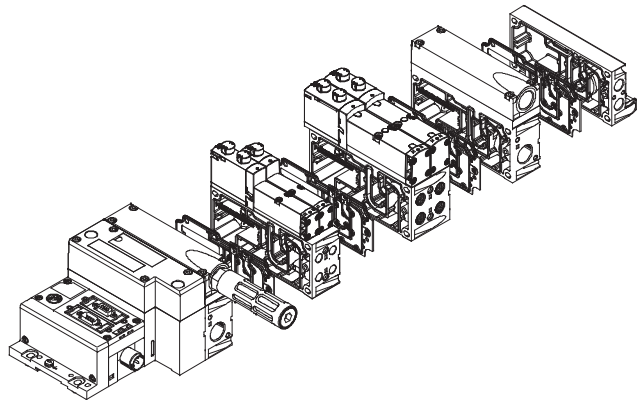

Vertical stacking modularity

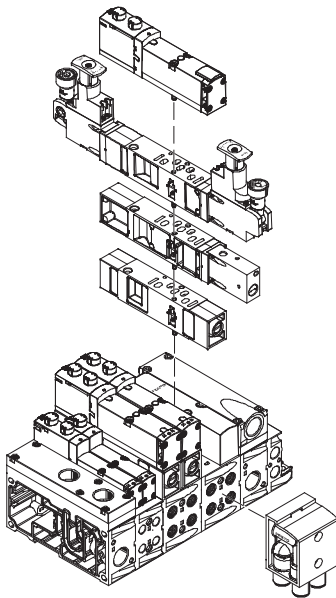

Valve terminals type 44/45, VTSA/VTSA-F, NPT

Peripherals – ISO 15407-2, width 18 and 26 mm; ISO 5599-2, width 42 and 52 mm

Modular electrical peripherals

The manner in which the valves are actuated differs according to whether you are using a multi-pin terminal or fieldbus terminal.

The VTSA/VTSA-F with CPX interface is based on the internal bus system of the CPX and uses this communication system for all solenoid coils and a range of electrical input and output functions.

Parallel linking enables the following:

- Transmission of switching information
- High valve density
- Compact design
- Position-based diagnostics
- Separate voltage supply for valves
- Flexible conversion without address shifting
- Option of CP interface
- CPX-FEC as stand-alone controller with access via Ethernet and web server
- Transmission of status, parameter and diagnostic data

→ Internet: cpx

VTSA/VTSA-F with electrical peripherals CPX

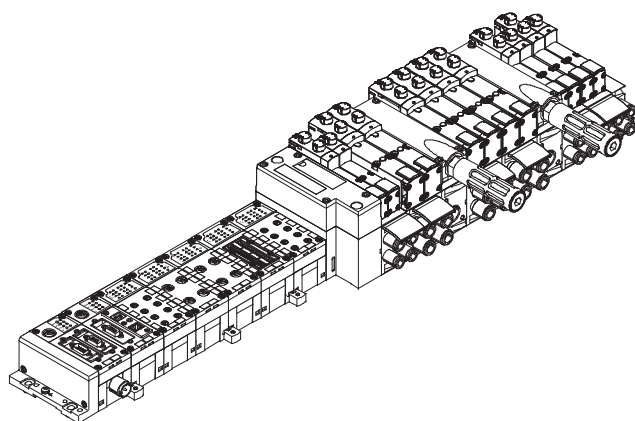

Modularity with electrical peripherals CPX

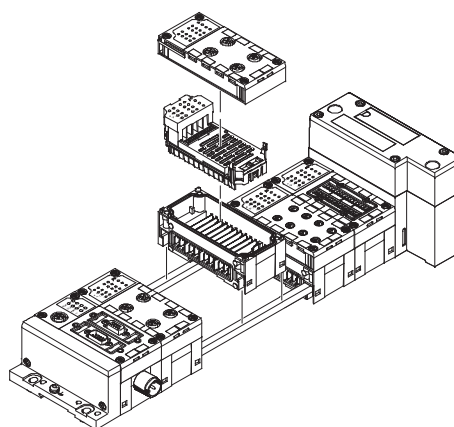

CPX terminal in metal design

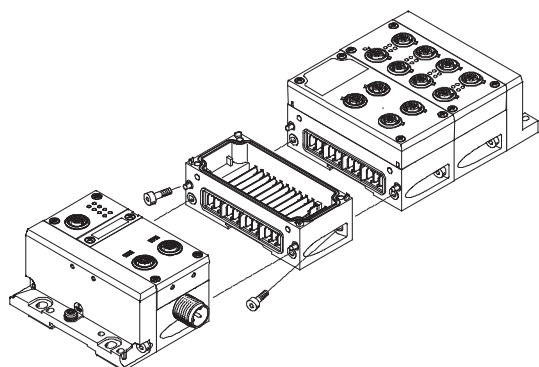

The mechanical connection between the CPX modules in metal design is created using special angle fittings. The CPX terminal can thus be expanded at any time.

-  - Note

The CPX manifold blocks are also available in a metal design. This means a complete solution in a sturdy metal design can be selected for applications of the valve terminal VTSA/VTSA-F in welding environments.

Valve terminals type 44/45, VTSA/VTSA-F, NPT

Peripherals – Pneumatic components – ISO 15407-2, width 18 and 26 mm; ISO 5599-2, width 42 and 52 mm

Individual sub-base, width 18 mm, ISO 15407-2

Order code: Individual sub-bases can be equipped with any valve.
 • Using individual part numbers

Width 18 mm with spring-loaded terminal or cable (open end)

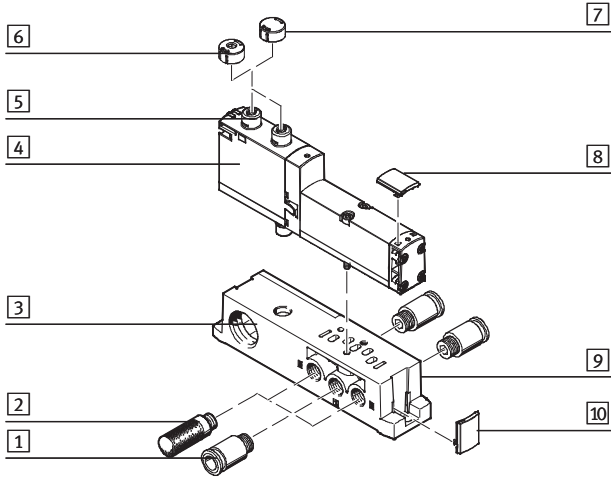

	Brief description	→ Page/Internet	
1	Fitting	1/8" NPT for working air/exhaust ports (1, 3, 5) and working lines (2, 4)	134
2	Silencer	U-1/8-B-NPT for exhaust ports (3, 5)	134
3	Electrical connection	Spring-loaded terminal, cable (open end)	-
4	Valve VSVA	Width 18 mm	81
5	Manual override	Non-detenting/detenting, per solenoid coil	-
6	Cover cap	For non-detenting manual override	95
7	Cover cap	For covered manual override	95
8	Inscription label holder	For valves	98
9	Individual sub-base	For valve VSVA	133
10	Inscription label holder	For manifold blocks	98

Valve terminals type 44/45, VTSA/VTSA-F, NPT

Peripherals – Pneumatic components – ISO 15407-2, width 18 and 26 mm; ISO 5599-2, width 42 and 52 mm

Individual sub-base, width 26 mm, ISO 15407-2

With spring-loaded terminal or cable (open end)

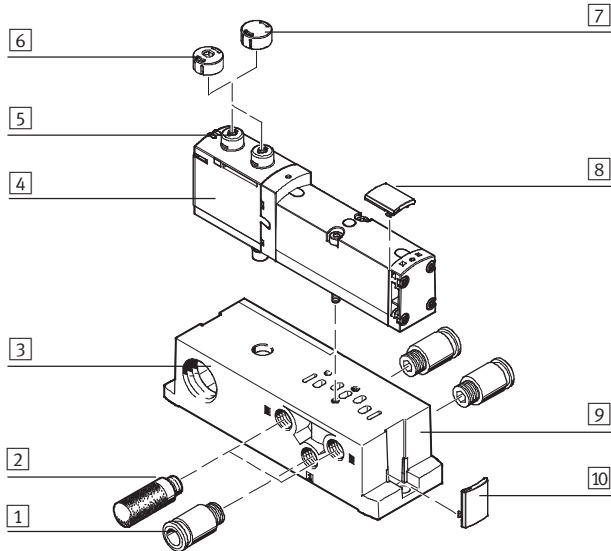

	Brief description	→ Page/Internet
1	Fitting	1/4" NPT for working air/exhaust ports (1, 3, 5) and working lines (2, 4)
2	Silencer	U-1/4-B-NPT for exhaust ports (3, 5)
3	Electrical connection	Spring-loaded terminal, cable (open end)
4	Valve VSVA	Width 26 mm
5	Manual override	Non-detenting/detenting, per solenoid coil
6	Cover cap	For non-detenting manual override
7	Cover cap	For covered manual override
8	Inscription label holder	For valves
9	Individual sub-base	For valve VSVA
10	Inscription label holder	For manifold blocks

Valve terminals type 44/45, VTSA/VTSA-F, NPT

FESTO

Peripherals – Pneumatic components – ISO 15407-2, width 18 and 26 mm; ISO 5599-2, width 42 and 52 mm

Individual sub-base, width 42 mm, ISO 5599-2

With spring-loaded terminal or cable (open end)

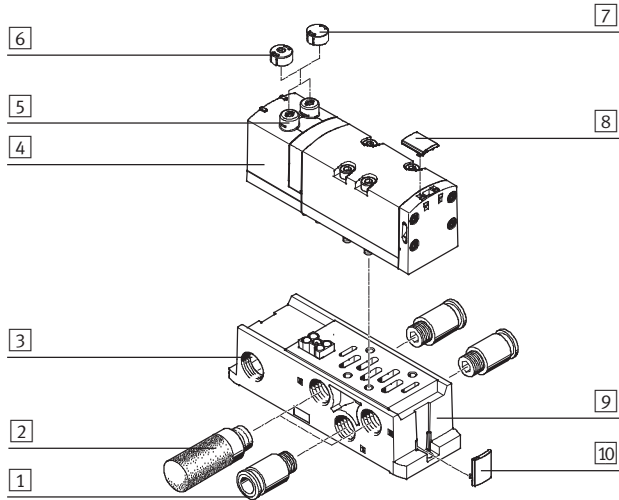

	Brief description	→ Page/Internet	
1	Fitting	3/8" NPT for working air/exhaust ports (1, 3, 5) and working lines (2, 4)	134
2	Silencer	U-3/8-B-NPT for exhaust ports (3, 5)	134
3	Electrical connection	Spring-loaded terminal, cable (open end)	–
4	Valve VSVA	Width 42 mm	83
5	Manual override	Non-detenting/detenting, per solenoid coil	–
6	Cover cap	For non-detenting manual override	95
7	Cover cap	For covered manual override	95
8	Inscription label holder	For valves	98
9	Individual sub-base	For valve VSVA	133
10	Inscription label holder	For manifold blocks	98

Valve terminals type 44/45, VTSA/VTSA-F, NPT

Peripherals – Pneumatic components – ISO 15407-2, width 18 and 26 mm; ISO 5599-2, width 42 and 52 mm

Individual sub-base, width 52 mm, ISO 5599-2

With spring-loaded terminal or cable (open end)

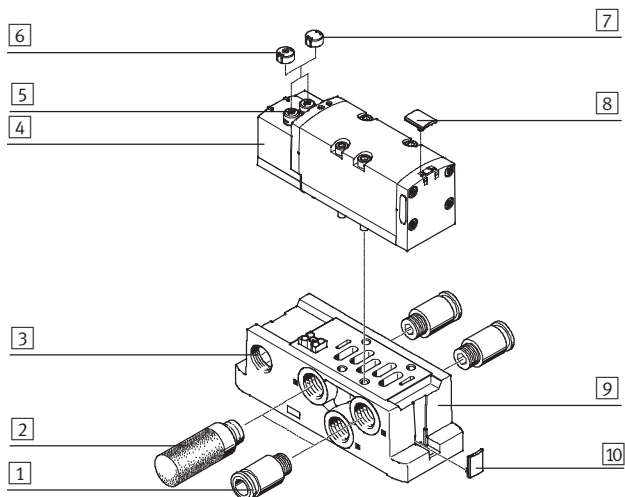

	Brief description	→ Page/Internet	
1	Fitting	1/2" NPT for working air/exhaust ports (1, 3, 5) and working lines (2, 4)	134
2	Silencer	U-1/2-B-NPT for exhaust ports (3, 5)	134
3	Electrical connection	Spring-loaded terminal, cable (open end)	-
4	Valve VSVA	Width 52 mm	84
5	Manual override	Non-detenting/detenting, per solenoid coil	-
6	Cover cap	For non-detenting manual override	95
7	Cover cap	For covered manual override	95
8	Inscription label holder	For valves	98
9	Individual sub-base	For valve VSVA	133
10	Inscription label holder	For manifold blocks	98

Valve terminals type 44/45, VTSA/VTSA-F, NPT

Peripherals – Pneumatic components – ISO 15407-2, width 18 and 26 mm; ISO 5599-2, width 42 and 52 mm

Valve terminal pneumatics

The manifold sub-bases for valves with a width of 18 or 26 mm are either prepared for

- 2 single solenoid valves or
- 2 double solenoid valves.

The manifold sub-bases for valves with a width of 42 or 52 mm are suitable for

- 1 single solenoid valve or
- 1 double solenoid valve.

- Double solenoid valve positions can be equipped with any valve or a blanking plate.

- Single solenoid valve positions can only be equipped with single solenoid valves or a blanking plate.

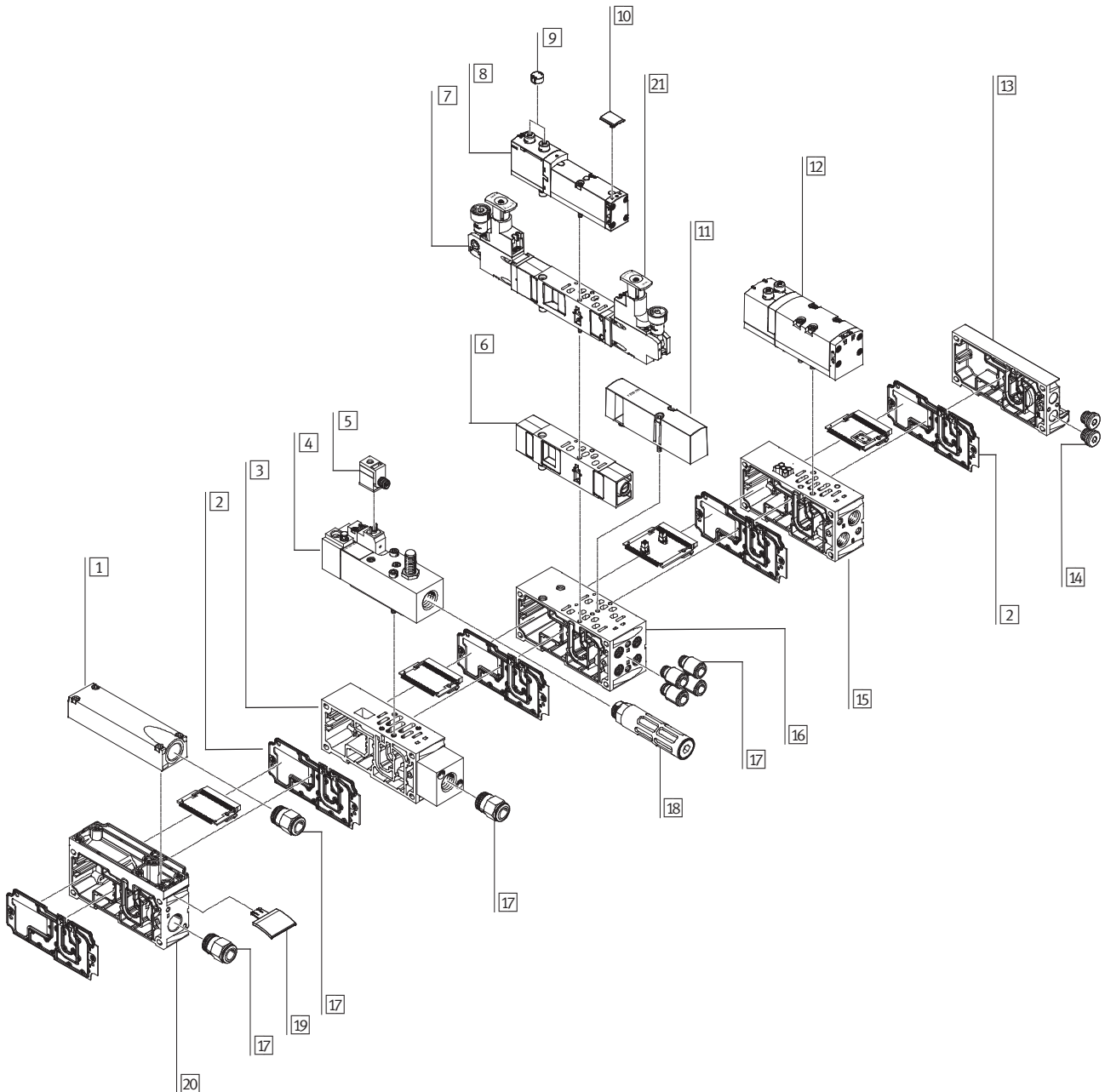

Valve terminals type 44/45, VTSA/VTSA-F, NPT

Peripherals – Pneumatic components – ISO 15407-2, width 18 and 26 mm; ISO 5599-2, width 42 and 52 mm

Valve terminal pneumatics			
	Brief description	→ Page/Internet	
1	Exhaust port cover	For ducted exhaust air (ports 3 and 5 combined)	90
2	Duct separation/seal	–	90
3	Manifold sub-base	For soft-start valve	118
4	Soft-start valve	For slow and safe pressure build-up	118
5	Plug socket	–	123
6	Flow control plate	–	95
7	Pressure regulator plate	–	91
8	Valve	Width 18 mm or 26 mm	81
9	Cover cap	For manual override, non-detenting, covered	95
10	Inscription label holder	For valve	98
11	Blanking plate	For unused valve position (vacant position)	95
12	Valve	Width 42 mm or 52 mm	83
13	End plate with pilot air selector	–	89
14	Blanking plug	–	134
15	Manifold sub-base VTSA	For valves with a width of 42 mm or 52 mm	89
15	Manifold sub-base VTSA-F	For valves with a width of 42 mm or 52 mm	89
16	Manifold sub-base VTSA	For valves with a width of 18 mm or 26 mm	89
16	Manifold sub-base VTSA-F	For valves with a width of 18 mm or 26 mm	89
17	Fittings	–	134
18	Silencer	–	134
19	Inscription label holder	For manifold sub-base, sub-base, 90° connection plate	98
20	Supply plate	–	90
21	Control element	Regulator knobs in different versions	34

Valve terminals type 44/45, VTSA/VTSA-F, NPT

Peripherals – Pneumatic components – ISO 15407-2, width 18 and 26 mm; ISO 5599-2, width 42 and 52 mm

Valve terminal widths

Order code for VTSA:

- 44E... for the electrical components
- 44P... for the pneumatic components

Order code for VTSA-F:

- 45E... for the electrical components
- 45P... for the pneumatic components

Regardless of the type of actuation (e.g. multi-pin plug, fieldbus, etc.), valve terminals VTSA/VTSA-F in the widths

- 18 mm
- 26 mm
- 42 mm
- 52 mm

can be combined without adapters. This enables a flow range of 400 l/min to 2,900 l/min in the case of VTSA and 700 l/min to 2,900 l/min in the case of VTSA-F to be covered on one valve terminal. A wide range of valve functions and vertical stacking components are available for all widths.

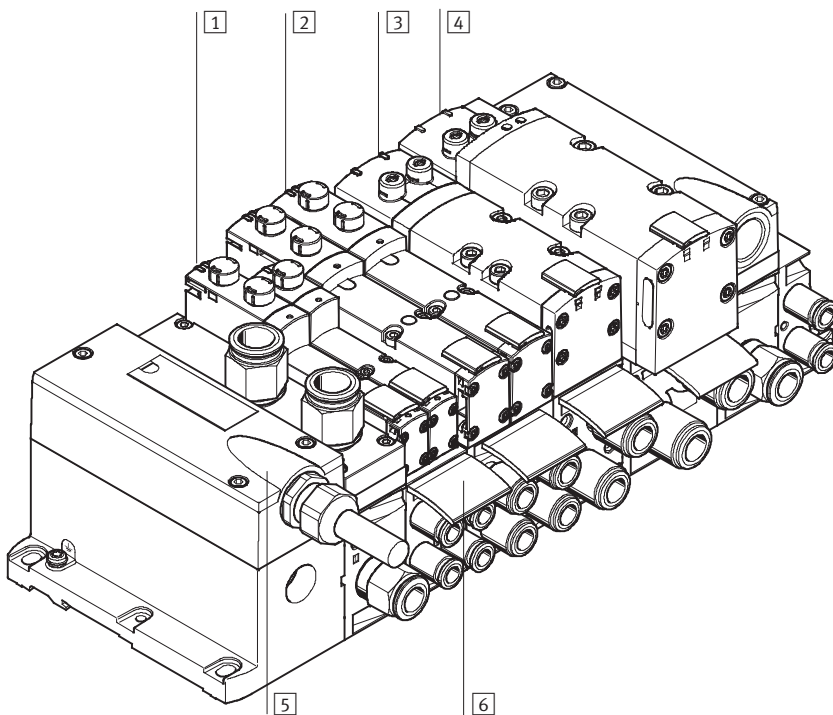

	Brief description	→ Page/Internet
1	Valve Width 18 mm	89
2	Valve Width 26 mm	89
3	Valve Width 42 mm	89
4	Valve Width 52 mm	89
5	Multi-pin plug connection Via multi-pin cable 24 V DC	96
6	Inscription labels For manifold sub-base, sub-base, 90° connection plate	98

Valve terminals type 44/45, VTSA/VTSA-F, NPT

Peripherals – Electrical components – ISO 15407-2, width 18 and 26 mm; ISO 5599-2, width 42 and 52 mm

Valve terminal with individual electrical connection

Order code for VTSA:

- 44E-... for the electrical components
- 44P-... for the pneumatic components

Order code for VTSA-F:

- 45E-... for the electrical components
- 45P-... for the pneumatic components

Valve terminals VTSA/VTSA-F with individual electrical connection can be expanded with up to 20 valves with max. 20 solenoid coils.

The manifold sub-bases for valves with a width of 18 or 26 mm are either prepared for

- 2 single solenoid valves or
- 2 double solenoid valves

and the manifold sub-bases for valves with a width of 42 or 52 mm are prepared for

- 1 single solenoid valve or
- 1 double solenoid valve.

- Double solenoid valve positions can be equipped with any valve or a blanking plate.

- Single solenoid valve positions can only be equipped with single solenoid valves or a blanking plate.
- The electrical connection is established via a 5-pin M12 plug (24 V DC).

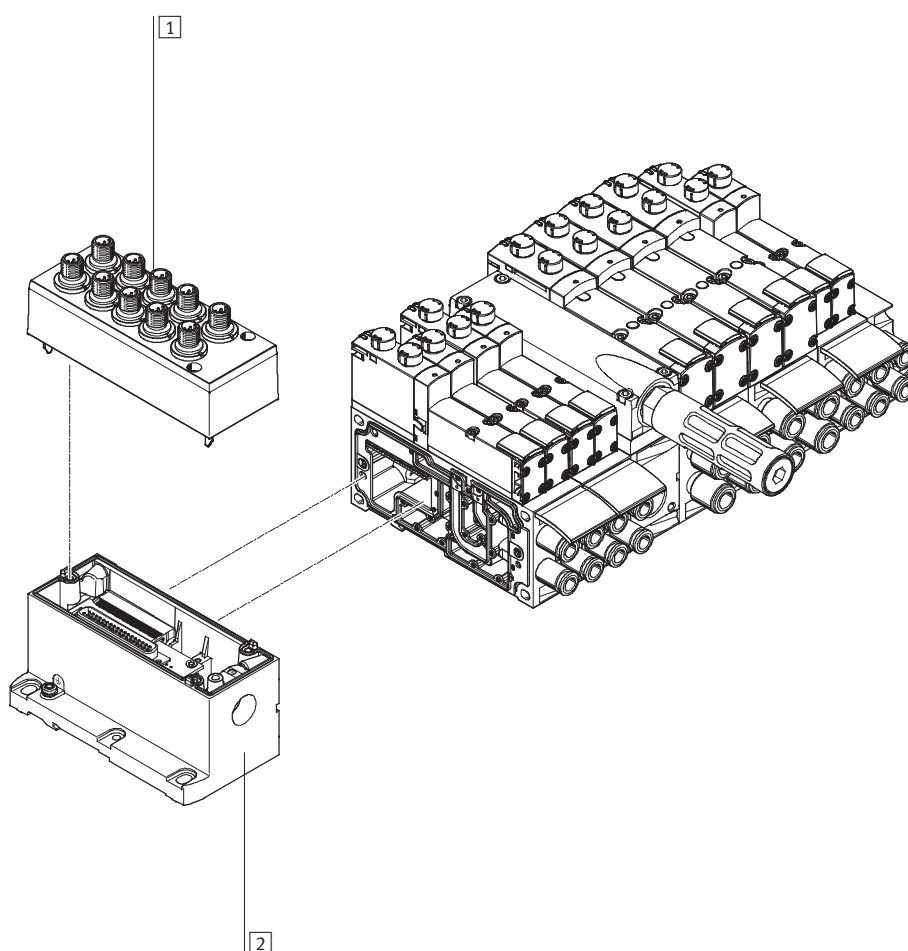

	Brief description	→ Page/Internet
1	Cover	For individual connection 96
2	Multi-pin plug connection	Individual connection with M12, 10-way or 6-way (including cover) 96

Valve terminals type 44/45, VTSA/VTSA-F, NPT

Peripherals – Electrical components – ISO 15407-2, width 18 and 26 mm; ISO 5599-2, width 42 and 52 mm

Valve terminal with electrical multi-pin plug connection

Order code for VTSA:

- 44E... for the electrical components
- 44P... for the pneumatic components

Order code for VTSA-F:

- 45E... for the electrical components
- 45P... for the pneumatic components

Valve terminals VTSA/VTSA-F with multi-pin plug connection can be expanded with up to 32 valves with max. 32 solenoid coils. The manifold sub-bases for valves with a width of 18 or 26 mm are prepared for

- 2 single solenoid valves or
- 2 double solenoid valves

and the manifold sub-bases for valves with a width of 42 or 52 mm are prepared for

- 1 single solenoid valve or
- 1 double solenoid valve.

- Double solenoid valve positions can be equipped with any valve or a blanking plate.
- Single solenoid valve positions can only be equipped with single solenoid valves or a blanking plate.
- The following multi-pin plug connections to IP65 are available:
 - 37-pin Sub-D connection (24 V DC): the connecting cable can be ordered in lengths of 2.5 m, 5 m and 10 m for max. 8, 22 or 32 solenoid coils respectively.

- Terminal strip (24 V DC or 110 V AC) 19-pin round plug connector (24 V DC).

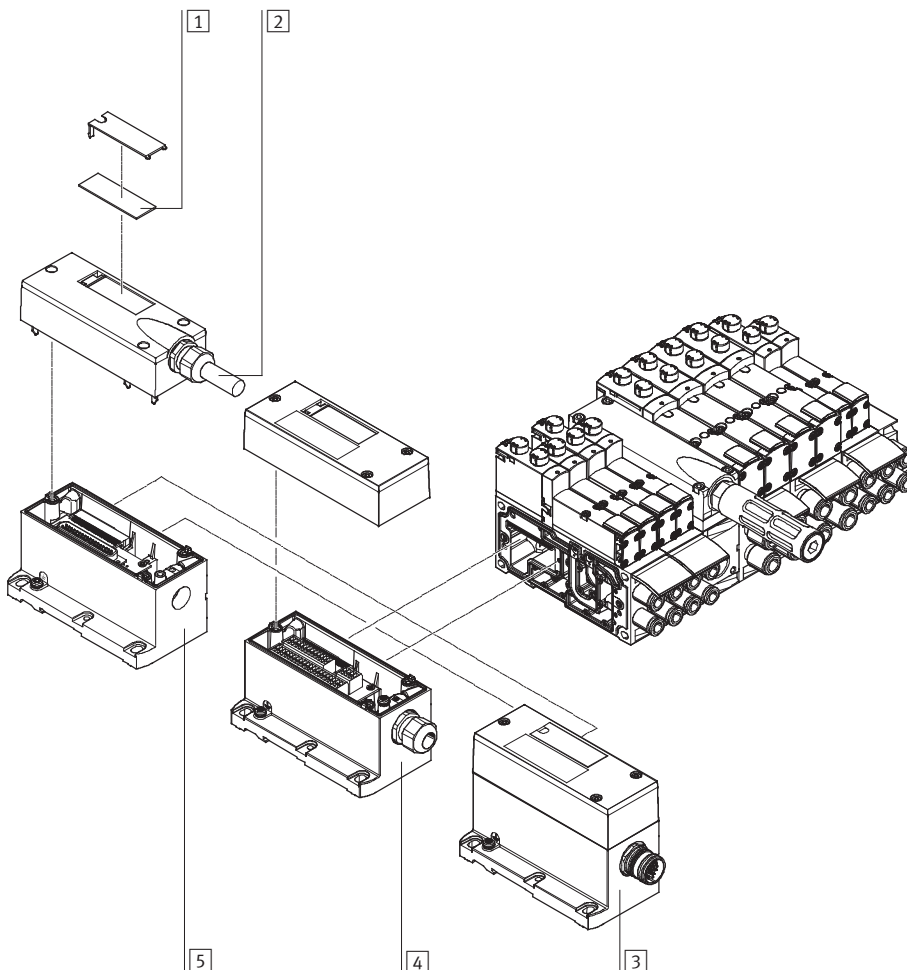

	Brief description	→ Page/Internet	
1	Inscription labels	Large, for multi-pin plug connection	–
2	Multi-pin plug cable	–	97
3	Multi-pin plug connection	Via M23 round plug connection 24 V DC	96
4	Multi-pin plug connection	Via terminal strip (Cage Clamp®) 24 V DC or 110 V AC	96
5	Multi-pin plug connection	Via multi-pin cable 24 V DC	96

Valve terminals type 44/45, VTSA/VTSA-F, NPT

Peripherals – Electrical components – ISO 15407-2, width 18 and 26 mm; ISO 5599-2, width 42 and 52 mm

Valve terminal with AS-interface connection

Order code for VTSA:

- 52E... for the electrical components
- 44P... for the pneumatic components

Order code for VTSA-F:

- 52E... for the electrical components
- 45P... for the pneumatic components

Valve terminals VTSA/VTSA-F with AS-interface connection can be expanded with up to 8 valves with max. 8 solenoid coils.

The manifold sub-bases for valves with a width of 18 or 26 mm are either prepared for

- 2 single solenoid valves or
- 2 double solenoid valves

and the manifold sub-bases for valves with a width of 42 or 52 mm are prepared for

- 1 single solenoid valve or
- 1 double solenoid valve.

- Double solenoid valve positions can be equipped with any valve or a blanking plate.
- Single solenoid valve positions can only be equipped with single solenoid valves or a blanking plate.

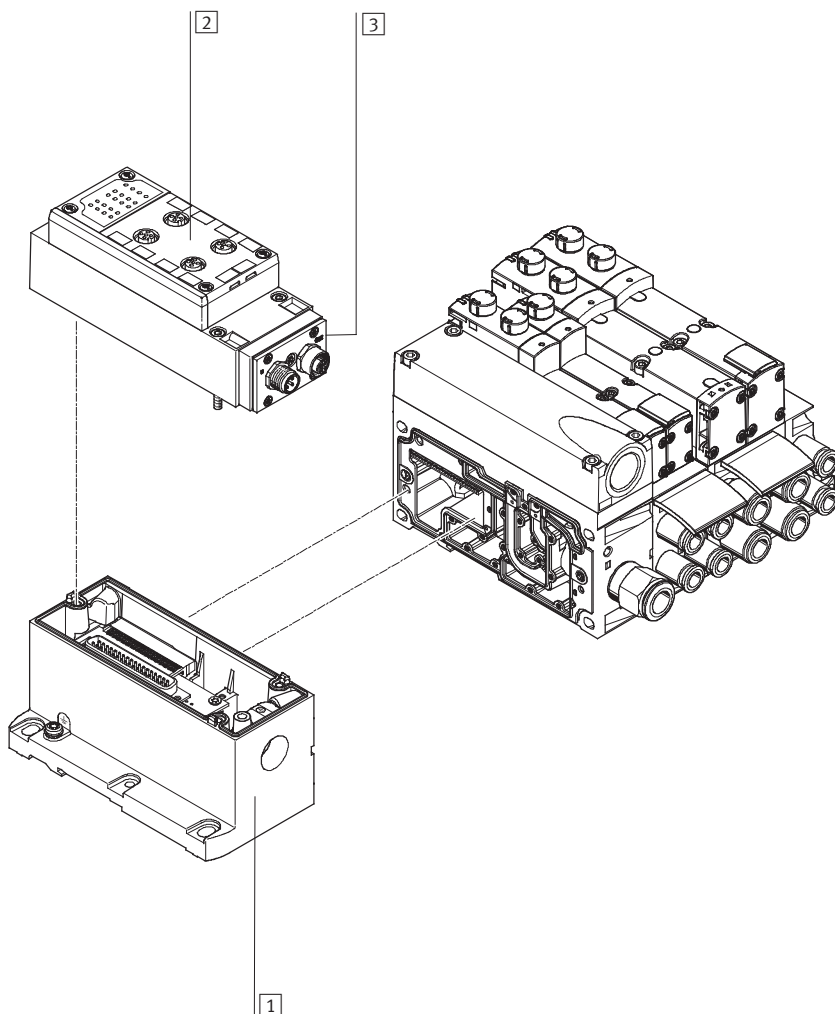

	Brief description	→ Page/Internet
1	Multi-pin plug connection	Can be ordered together with the AS-interface module as an electrical connection for AS-interface
2	Manifold block for AS-interface	–
3	AS-interface module	–

Valve terminals type 44/45, VTSA/VTSA-F, NPT

Peripherals – Electrical components – ISO 15407-2, width 18 and 26 mm; ISO 5599-2, width 42 and 52 mm

Valve terminal with fieldbus connection, control block (electrical peripherals CPX)

Order code:

- 50E-... for the electrical peripherals
- 51E-... for the electrical peripherals, metal manifold module

For VTSA:

- 44P-... for the pneumatic components

For VTSA-F:

- 45P-... for the pneumatic components

Valve terminals VTSA/VTSA-F with fieldbus interface can be expanded with up to 32 valves with max. 32 solenoid coils.

Each valve position can be equipped with any valve or a blanking plate. The rules for CPX apply to the equipment that can be used in combination with the electrical peripherals CPX.

In general:

- Max. 10 electrical modules
- Digital inputs/outputs
- Analogue inputs/outputs
- Parameterisation of inputs and outputs
- Integrated convenient diagnostic system
- Preventive maintenance concepts

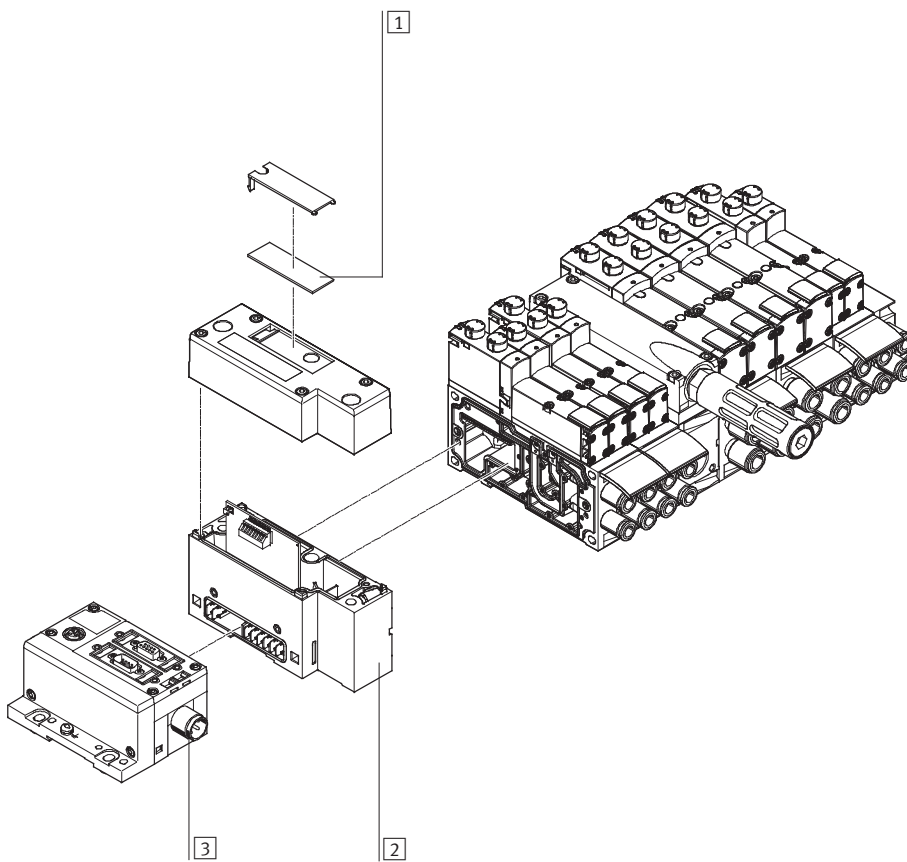

	Brief description	→ Page/Internet
1	Inscription labels Large, for pneumatic interface CPX	–
2	Pneumatic interface	96
3	Fieldbus interface	cpx

Valve terminals type 44/45, VTSA/VTSA-F, NPT

Peripherals – Electrical components – ISO 15407-2, width 18 and 26 mm; ISO 5599-2, width 42 and 52 mm

Valve terminal with fieldbus/multi-pin plug connection and individually electrically actuated valve

In applications with specific emergency stop conditions, it may be necessary to switch one or more valves separately from the valve terminal controller. Standard valves (VSA) with individual electrical connection (round or square plug) are mounted on the

valve terminal to this end.

In order for the protection class IP65 to be achieved, the functionless opening in the sub-base for the electrical connection must be sealed.

A sealing cap is available for the 18 mm and 26 mm widths.

With manifold or individual sub-bases, valves with width 42 mm and 52 mm must be used with a seal to comply with the IP protection class (see → page 95).

For central control of the valve terminal via a multi-pin plug or

fieldbus connection, the valve position occupied in this way acts like a vacant position, i.e. the assigned address in the fieldbus node or the corresponding connection in the multi-pin plug connection is occupied.

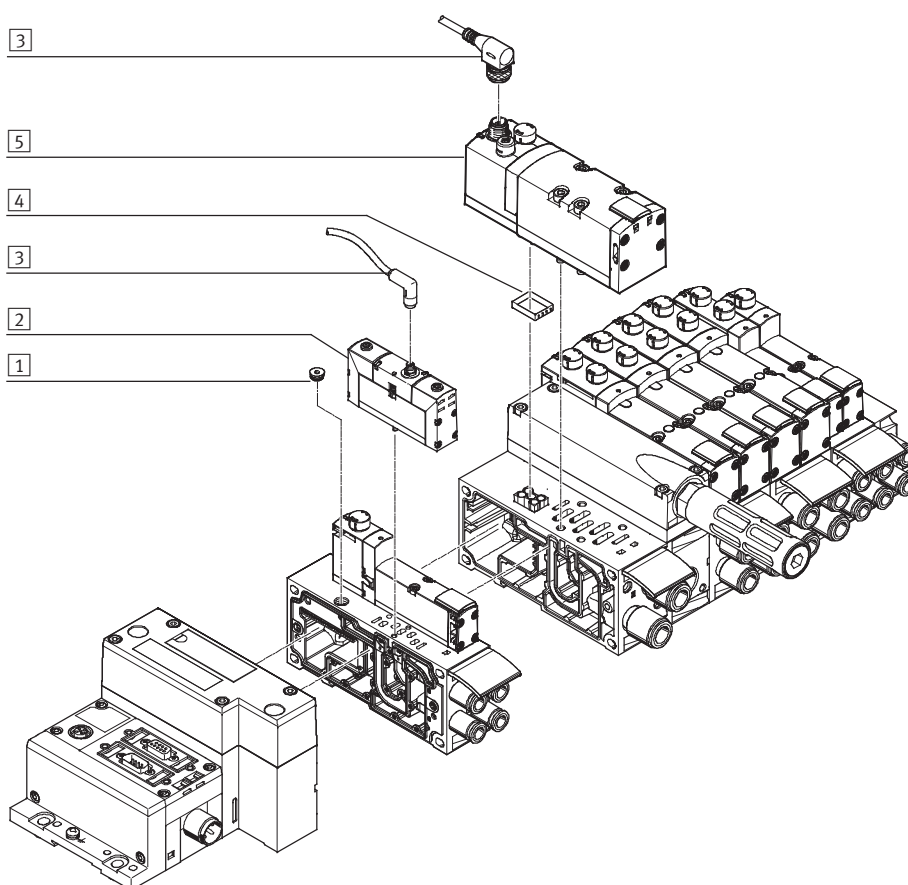

	Brief description	→ Page/Internet	
1	Sealing cap	For sealing the electrical connection on the sub-base	95
2	Valve	Width 18 mm or width 26 mm	valves vsva
3	Connecting cable	–	valves vsva
4	Seal	For ensuring the IP protection class (with width 42 mm and 52 mm)	95
5	Valve	Width 42 mm or width 52 mm	valves vsva

Valve terminals type 44/45, VTSA/VTSA-F, NPT

Key features – Pneumatic components – ISO 15407-2, width 18 and 26 mm; ISO 5599-2, width 42 and 52 mm

Manifold sub-base

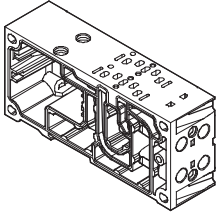

VTSA/VTSA-F is based on a modular system which consists of manifold sub-bases and valves. Manifold sub-bases are available for valve widths 18 mm and 26 mm in a double grid, i.e. two valves per manifold sub-base. For valves with a width of 42 mm or 52 mm, there are manifold sub-bases with one valve per sub-base. The manifold sub-base contains a duct seal and an electrical

interlinking module. They can be freely mixed within a valve terminal. The manifold sub-bases are screwed together and thus form the support system for the valves. Inside the manifold sub-bases are the connection ducts for supplying compressed air to and venting from the valves on the terminal as well as the working lines for the pneumatic

cylinders for each valve. Each manifold sub-base is connected to the next using four screws. Individual valve terminal sections can be isolated and further manifold sub-bases inserted by loosening these screws. This ensures that the valve terminal can be rapidly and reliably extended.

Port patterns on the manifold sub-base for one valve position

Width 18 mm



Width 26 mm

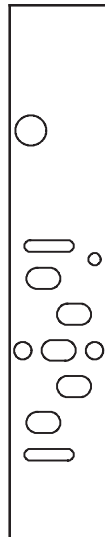

Width 42 mm

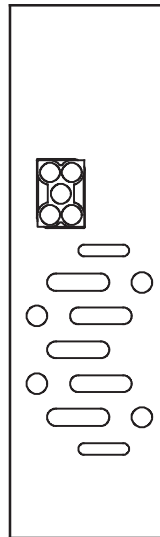

Width 52 mm

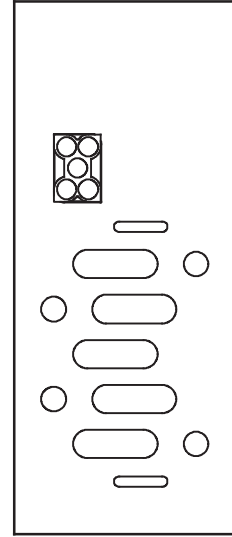

-  - Note

The illustrations shown depict a schematic representation of the pneumatic ISO port patterns.
The port patterns on the valve terminal VTSA-F do not correspond to the ISO standard.

Valve terminals type 44/45, VTSA/VTSA-F, NPT

Key features – Pneumatic components – ISO 15407-2, width 18 and 26 mm; ISO 5599-2, width 42 and 52 mm

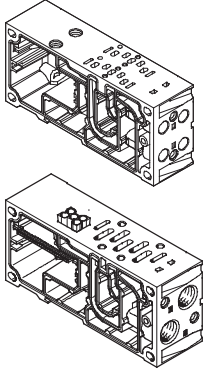
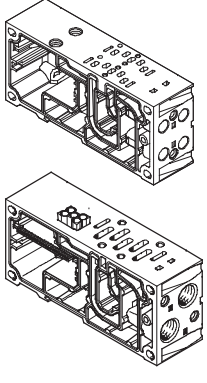
Manifold sub-base variants with NPT thread, valve terminal VTSA								
Code	Image	Type	Width				No. of valve positions/ solenoid coils	Working lines (2, 4) on the manifold sub-base
			18 mm	26 mm	42 mm	52 mm		
Manifold sub-base for multi-pin plug/fieldbus connection for double solenoid valves								
A AK		VABV-S4-2S-N18-2T2	■	-	-	-	2/4	3/8" NPT QS-1/8-5/16-U, QS-1/8-1/4-U
B BK		VABV-S4-1S-N14-2T2	-	■	-	-	2/4	1/4" NPT: QS-1/4-3/8-U, QS-1/4-5/16-U
C CK		VABV-S2-1S-N38-T2	-	-	■	-	1/2	3/8" NPT QS-3/8-3/8-U, QS-3/8-1/2-U
D DK		VABV-S2-2S-N12-T2	-	-	-	■	1/2	1/2" NPT QS-1/2-1/2-U
Manifold sub-base for multi-pin plug/fieldbus connection for single solenoid valves								
E EK		VABV-S4-2S-N18-2T1	■	-	-	-	2/2	3/8" NPT QS-1/8-5/16-U, QS-1/8-1/4-U
F FK		VABV-S4-1S-N14-2T1	-	■	-	-	2/2	1/4" NPT QS-1/4-3/8-U, QS-1/4-5/16-U
G GK		VABV-S2-1S-N38-T1	-	-	■	-	1/1	3/8" NPT QS-3/8-3/8-U, QS-3/8-1/2-U
H HK		VABV-S2-2S-N12-T1	-	-	-	■	1/1	1/2" NPT QS-1/2-1/2-U

Valve terminals type 44/45, VTSA/VTSA-F, NPT

FESTO

Key features – Pneumatic components – ISO 15407-2, width 18 and 26 mm; ISO 5599-2, width 42 and 52 mm

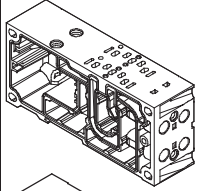
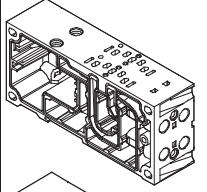
Manifold sub-base variants with NPT thread, valve terminal VTSA-F								
Code		Type	Width				No. of valve positions/ solenoid coils	Working lines (2, 4) on the manifold sub-base
			18 mm	26 mm	42 mm	52 mm		
Manifold sub-base for multi-pin plug/fieldbus connection for double solenoid valves								
A AK		VABV-S4-2HS-N18-2T2	■	-	-	-	2/4	1/8" NPT QS-1/8-5/16-U, QS-1/8-1/4-U
B BK		VABV-S4-1HS-N14-2T2	-	■	-	-	2/4	1/4" NPT QS-1/4-3/8-U, QS-1/4-5/16-U
C CK		VABV-S2-1HS-N38-T2	-	-	■	-	1/2	3/8" NPT QS-3/8-3/8-U, QS-3/8-1/2-U
D DK		VABV-S2-2HS-N12-T2	-	-	-	■	1/2	1/2" NPT QS-1/2-1/2-U
Manifold sub-base for multi-pin plug/fieldbus connection for single solenoid valves								
E EK		VABV-S4-2HS-N18-2T1	■	-	-	-	2/2	1/8" NPT QS-1/8-5/16-U, QS-1/8-1/4-U
F FK		VABV-S4-1HS-N14-2T1	-	■	-	-	2/2	1/4" NPT QS-1/4-3/8-U, QS-1/4-5/16-U
G GK		VABV-S2-1HS-N38-T1	-	-	■	-	1/1	3/8" NPT QS-3/8-3/8-U, QS-3/8-1/2-U
H HK		VABV-S2-2HS-N12-T1	-	-	-	■	1/1	1/2" NPT QS-1/2-1/2-U

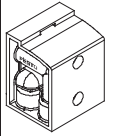
90° connection plate for working lines 2 and 4 with NPT thread								
Code		Type	Width				Ports	Working lines (2, 4) on the 90° connection plate
			18 mm	26 mm	42 mm	52 mm		
P		VABF-S4-...-A2G2-N...	■				2 and 4	1/8" NPT
				■				1/4" NPT
					■			3/8" NPT
						■		1/2" NPT

Valve terminals type 44/45, VTSA/VTSA-F, NPT

Key features – Pneumatic components – ISO 15407-2, width 18 and 26 mm; ISO 5599-2, width 42 and 52 mm

Sub-base valve

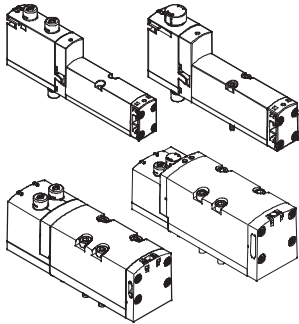

VTSA/VTSA-F offers a comprehensive range of valve functions. All valves are fitted with piston spool and patented sealing system, which ensures efficient sealing, a broad operating pressure range and long service life.

Sub-base valves can be quickly replaced since the tubing connections remain on the sub-base. Irrespective of the valve function there are sub-base valves with one solenoid coil (single solenoid) or with two solenoid coils for double solenoid or double valve functions.

Reverse/vacuum operation

Select reverse operation (code Z) if you wish to operate an actuator (cylinder) with different pressures for the forward and return stroke. Please note that the valves must then be operated via a separate pressure zone.

The reversible 3/2-way valves are also suitable for vacuum operation.

Blanking plate

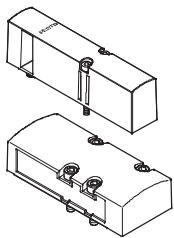

Plate without valve function for reserving valve positions on a valve terminal.

Valves and blanking plates are attached to the manifold sub-base using screws.

Design

Valve replacement

The valves are attached to the metal manifold sub-base using two screws, which means that they can be easily

replaced. The mechanical robustness of the manifold sub-base guarantees efficient long-term sealing.

Expansion

Vacant positions can be fitted with valves at a later date. The dimensions, mounting points and existing pneumatic installations remain

unchanged during this process. The order code VSVA-... is located on the front of the valve beneath the manual override.

Valve terminals type 44/45, VTSA/VTSA-F, NPT



Key features – Pneumatic components – ISO 15407-2, width 18 and 26 mm; ISO 5599-2, width 42 and 52 mm

Valve functions						
Code	Circuit symbol	Width				Description
		18 mm	26 mm	42 mm	52 mm	
VC		■	■	■	■	2x 2/2-way valve, single solenoid <ul style="list-style-type: none"> • Normally closed • Pneumatic spring return
VV		■	■	■	-	2x 2/2-way valve, single solenoid <ul style="list-style-type: none"> • Normally closed • Pneumatic spring return • Vacuum operation possible at 3 and 5
N		■	■	■	■	2x 3/2-way valve, single solenoid <ul style="list-style-type: none"> • Normally open • Pneumatic spring return • Operating pressure > 3 bar
K		■	■	■	■	2x 3/2-way valve, single solenoid <ul style="list-style-type: none"> • Normally closed • Pneumatic spring return • Operating pressure > 3 bar
H		■	■	■	■	2x 3/2-way valve, single solenoid <ul style="list-style-type: none"> • Normal position <ul style="list-style-type: none"> - 1x closed - 1x open • Pneumatic spring return • Operating pressure > 3 bar
P		■	■	■	■	2x 3/2-way valve, single solenoid <ul style="list-style-type: none"> • Reverse operation • Normally open • Pneumatic spring return
Q		■	■	■	■	2x 3/2-way valve, single solenoid <ul style="list-style-type: none"> • Reverse operation • Normally closed • Pneumatic spring return
R		■	■	■	■	2x 3/2-way valve, single solenoid <ul style="list-style-type: none"> • Reverse operation • Normal position <ul style="list-style-type: none"> - 1x closed - 1x open • Pneumatic spring return



Note

A filter must be installed upstream of valves operated in vacuum mode. This prevents any foreign matter in the intake air getting into the valve (e.g. when operating a suction cup).

Valve terminals type 44/45, VTSA/VTSA-F, NPT

Key features – Pneumatic components – ISO 15407-2, width 18 and 26 mm; ISO 5599-2, width 42 and 52 mm

Valve function						
Code	Circuit symbol	Width				Description
		18 mm	26 mm	42 mm	52 mm	
M		■	■	■	■	5/2-way valve, single solenoid • Pneumatic spring return
O		■	■	■	■	5/2-way valve, single solenoid • Mechanical spring return
J		■	■	■	■	5/2-way valve, double solenoid
D		■	■	■	■	5/2-way valve, double solenoid • Dominant signal at port 14 on the control side
SO SQ		-	■	-	-	5/2-way valve ²⁾ , single solenoid, in plug-in or via pilot valve with pneumatic interface to ISO 15218 See also special valve function in the section “Control block with safety function” → page 105
B		■	■	■	■	5/3-way valve • Mid-position pressurised ¹⁾ • Mechanical spring return
G		■	■	■	■	5/3-way valve • Mid-position closed ¹⁾ • Mechanical spring return
E		■	■	■	■	5/3-way valve • Mid-position exhausted ¹⁾ • Mechanical spring return
SA		-	■	-	-	5/3-way valve, with enhanced function through signal storage in switching position 14 • Pressureless switching, self-holding, pneumatic operation • Mid-position exhausted, switching position 14 with memory function • Mechanical spring return
SB		-	■	-	-	5/3-way valve, with enhanced function through signal storage in switching position 14 • Holding, blocking a movement (mechanically) • Mid-position: port 2 pressurised, port 4 exhausted, switching position 14 with memory function • Mechanical spring return
L		■	■	■	■	For valve terminal only: Blanking plate for vacant valve position

- 1) If neither solenoid coil is energised, the valve moves to its mid-position by means of a mechanical spring. If the two coils are permanently energised one after the other, the valve remains in the switching position of the coil that was activated first.
- 2) The symbol represents a valve with a proximity sensor with a switching output signal, in the illustration an N/O contact. In accordance with ISO 1219-1, this symbol applies to both N/O contacts as well as N/C contacts. The switching element function of all sensors used here is an N/C contact.

Valve terminals type 44/45, VTSA/VTSA-F, NPT

Key features – Pneumatic components – ISO 15407-2, width 18 and 26 mm; ISO 5599-2, width 42 and 52 mm

Vertical stacking

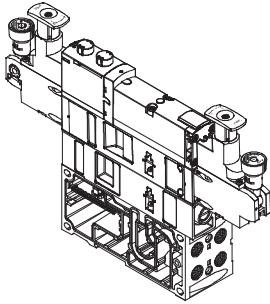

Additional functions can be added to each valve position between the sub-base and the valve. These functions are known as vertical stacking modules and enable special

functioning or control of an individual valve position. Combinations of several valve sizes on one valve terminal are possible.

 Note
Certain combinations are not recommended due to the design of the individual vertical stacking components.

Vertical stacking components

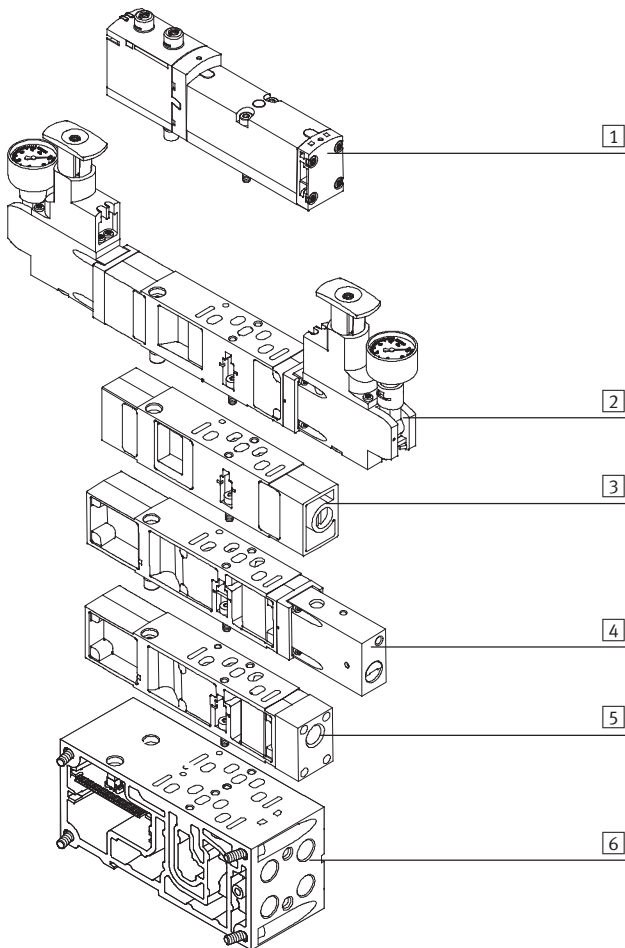

The following component sequence is recommended for valve positions with vertical stacking:

- 1 ISO valve
- 2 Pressure regulator plate
- 3 Flow control plate
- 4 Vertical pressure shut-off plate
- 5 Vertical supply plate
- 6 Manifold sub-base

Valve terminals type 44/45, VTSA/VTSA-F, NPT

Key features – Pneumatic components – ISO 15407-2, width 18 and 26 mm; ISO 5599-2, width 42 and 52 mm

Vertical stacking

Pressure regulator plate

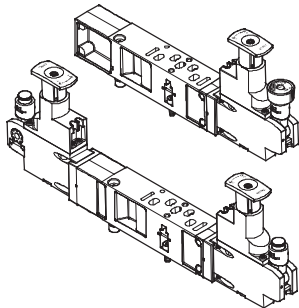

An adjustable pressure regulator can be installed between the sub-base and the valve in order to control the force of the triggered actuator.

This pressure regulator maintains an essentially constant output pressure (secondary side) independent of pressure fluctuations (primary side) and air consumption. Also suitable for symmetrical valves.

Standard version:

- Standard port pattern to ISO 15407-2 or ISO 5599-2
- For supply pressure up to 6 bar or up to 10 bar
- Without pressure gauge (optional)
- Regulator knob with 3 positions (locked, reference position, free running)

Note

With the A, B and AB pressure regulators VABF-S-1..., the control pressure should not be under 2 bar. Use the reversible A, B or AB pressure regulators for control pressures under 2 bar.

Note

Please note for repeat orders: Certain equipment versions of pressure regulator plates can only be ordered via type codes. The part number imprinted on the regulator plate installed on the VTSA/VTSA-F valve terminal will not match the equipment version in these cases. For that reason, always use the VABF configurator for repeat orders.

Mode of operation of the pressure regulator plate (P regulator) for port 1; code: ZA, ZAY, ZF, ZFY

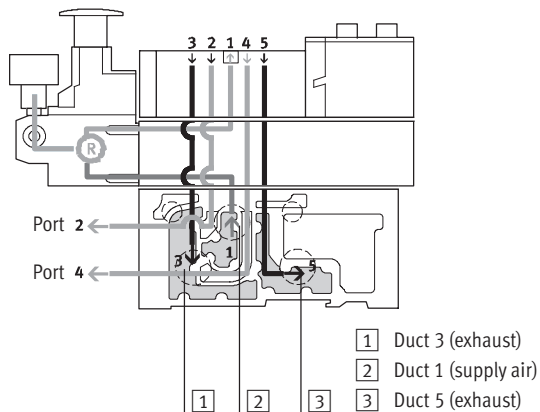

This pressure regulator regulates the pressure upstream of the valve in duct 1. Ducts 2 and 4 thus have the same regulated pressure.

During venting, the exhaust flow in the valve is from duct 2 to duct 3 and from duct 4 to duct 5.

Advantages

- The pressure regulator is not affected by venting, since the pressure is regulated upstream of the valve.
- The pressure regulator can always be adjusted, since the pressure from the valve terminal is always present.

Application examples

- An equal working pressure is required at working lines 2 and 4.
- A lower working pressure (e.g. 3 bar) than the operating pressure present on the valve terminal (e.g. 8 bar) is required.

Valve terminals type 44/45, VTSA/VTSA-F, NPT

Key features – Pneumatic components – ISO 15407-2, width 18 and 26 mm; ISO 5599-2, width 42 and 52 mm



Vertical stacking

Mode of operation of the pressure regulator plate (AB regulator) for ports 2 and 4; code: ZD, ZDY, ZI, ZIY

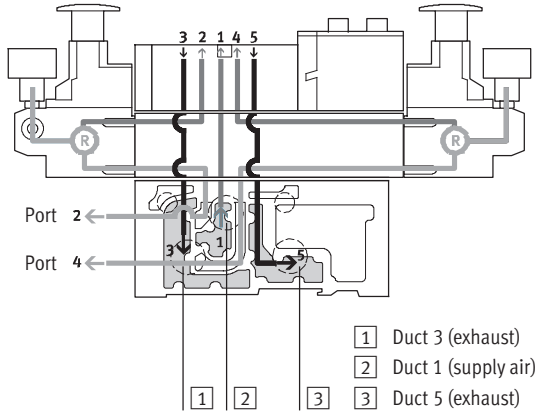

This pressure regulator regulates the pressure in ducts 2 and 4 after the pressure medium flows through the valve. During venting, the exhaust flow in the valve is from duct 2 to duct 3 and from duct 4 to duct 5 via the pressure regulator.

Example with the following switching position:
 The supply air flows from duct 1 of the manifold sub-base via the valve to duct 2, it is then regulated and made available at port 2 of the manifold sub-base. At the same time, venting takes place via duct 4 of the manifold sub-base, via the regulator and via the valve into duct 5 of the manifold sub-base.

Restrictions

- The pressure regulator cannot be adjusted in the exhaust position. For example, the pressure regulator for duct 4 cannot be adjusted when the valve is pressurised in the switching position from duct 1 to duct 2 and exhausted from duct 4 to duct 5.

Application examples

- When two different working pressures are required at ports 2 and 4 instead of the valve terminal operating pressure.

Valve terminals type 44/45, VTSA/VTSA-F, NPT

Key features – Pneumatic components – ISO 15407-2, width 18 and 26 mm; ISO 5599-2, width 42 and 52 mm

Vertical stacking

Mode of operation of the pressure regulator plate (AB regulator, reversible) for ports 2 and 4, reversible; code: ZE, ZEY, ZJ, ZJY

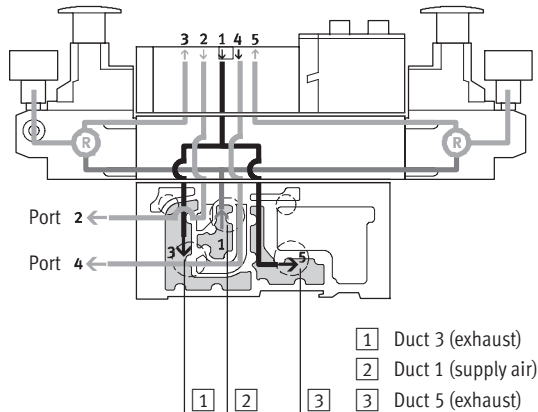

With this pressure regulator, the supply air (duct 1) is split and routed directly to both pressure regulators. In each case the regulated supply air is present in ducts 3 and 5 on the valve. The valve is thus operated in reversible mode.

This means:

- Duct 3 routes the working pressure to port 2
- Duct 5 routes the working pressure to port 4

Example with the following switching position:

The supply air in duct 1 is split between ducts 3 and 5 in the regulator and flows from here to the valve. In the valve, the supply air is routed to port 2 of the manifold sub-base. The exhaust air is simultaneously routed via duct 4 of the manifold sub-base and via the valve to regulator duct 1, where it is split between ducts 3 and 5 and then expelled via the manifold sub-base.

Application examples

- When two different pressures are required in ducts 2 and 4 instead of the operating pressure.
- When fast venting is required.
- When the pressure regulator must always be adjustable.

Note

- Reversible pressure regulator plates may only be combined with valves that can be operated in reversible mode.
- Valves in valve positions with vertical pressure shut-off plates are operated with internal pilot air supply, even when the valve terminal is operated with external pilot air supply.
- The following combination of reversible valve terminals with vertical stacking components is not permitted:
 - Reversible pressure regulator plates
 - Flow control plates
 - Vertical pressure shut-off plates
 - Vertical supply plates

Advantages

- Fast cycle times.
- 50% higher exhaust flow rate, as air is not vented via the pressure regulator. The load on the pressure regulator is also reduced.
- No quick exhaust valves are required.
- Operating pressure is always present at the pressure regulator, as the pressure is regulated upstream of the valve, i.e. the regulator can always be adjusted.

Disadvantages

- 2x 3/2-way valves (code N, K, H) cannot be used, as pressure is present at ports 3 and 5.
- No practical combination with a flow control plate possible.

Valve terminals type 44/45, VTSA/VTSA-F, NPT

Key features – Pneumatic components – ISO 15407-2, width 18 and 26 mm; ISO 5599-2, width 42 and 52 mm

Vertical stacking – Pressure regulator plate – Variants ¹⁾									
Code	Type	Width				Supply pressure		Description	
		18 mm	26 mm	42 mm	52 mm	6 bar	10 bar		
Pressure regulator plate for port 1 (P regulator)									
ZA		VABF-S...-R1C2-C-10	■	■	■	■	-	■	<ul style="list-style-type: none"> Regulates the operating pressure in duct 1 upstream of the directional control valve
ZAY ²⁾		VABF-S...-R1C2-C-10-E	■	■	■	■	-	■	
ZF		VABF-S...-R1C2-C-6	■	■	■	■	■	-	
ZFY ²⁾		VABF-S...-R1C2-C-6-E	■	■	■	■	■	-	
Pressure regulator plate for port 2 (B regulator)									
ZC		VABF-S...-R2C2-C-10	■	■	■	■	-	■	<ul style="list-style-type: none"> Regulates the operating pressure in duct 2 downstream of the directional control valve
ZCY ²⁾		VABF-S...-R2C2-C-10-E	■	■	■	■	-	■	
ZH		VABF-S...-R2C2-C-6	■	■	■	■	■	-	
ZHY ²⁾		VABF-S...-R2C2-C-6-E	■	■	■	■	■	-	
Pressure regulator plate for port 4 (A regulator)									
ZB ²⁾		VABF-S...-R3C2-C-10	■	■	■	■	-	■	<ul style="list-style-type: none"> Regulates the operating pressure in duct 4 downstream of the directional control valve
ZG ²⁾		VABF-S...-R3C2-C-6	■	■	■	■	■	-	
Pressure regulator plate for ports 2 and 4 (AB regulator)									
ZD		VABF-S...-R4C2-C-10	■	■	■	■	-	■	<ul style="list-style-type: none"> Regulates the working pressure in ducts 2 and 4 downstream of the directional control valve
ZDY ²⁾		VABF-S...-R4C2-C-10-E	■	■	■	■	-	■	
ZI		VABF-S...-R4C2-C-6	■	■	■	■	■	-	
ZIY ²⁾		VABF-S...-R4C2-C-6-E	■	■	■	■	■	-	

1) These functions are also available via the pressure regulator configurator VABF-S2 for width 42 mm and 52 mm (ISO 5599-2, ISO 1 and ISO 2)
 2) Also suitable for symmetrical valves

Valve terminals type 44/45, VTSA/VTSA-F, NPT



Key features – Pneumatic components – ISO 15407-2, width 18 and 26 mm; ISO 5599-2, width 42 and 52 mm

Vertical stacking – Pressure regulator plate – Variants ¹⁾									
Code	Type	Width				Supply pressure		Description	
		18 mm	26 mm	42 mm	52 mm	6 bar	10 bar		
Pressure regulator plate for port 2, reversible (B regulator)									
ZL		VABF-S...-R6C2-C-10	■	■	■	■	–	■	<ul style="list-style-type: none"> Reversible pressure regulator for port 2
ZLY ²⁾		VABF-S...-R6C2-C-10-E	■	■	■	■	–	■	
ZN		VABF-S...-R6C2-C-6	■	■	■	■	■	–	
ZNY ²⁾		VABF-S...-R6C2-C-6-E	■	■	■	■	■	–	
Pressure regulator plate for port 4, reversible (A regulator)									
ZK ²⁾		VABF-S...-R7C2-C-10	■	■	■	■	–	■	<ul style="list-style-type: none"> Reversible pressure regulator for port 4
ZM ²⁾		VABF-S...-R7C2-C-6	■	■	■	■	■	–	
Pressure regulator plate for ports 2 and 4, reversible (AB regulator)									
ZE		VABF-S...-R5C2-C-10	■	■	■	■	–	■	<ul style="list-style-type: none"> Reversible pressure regulator for ports 2 and 4 Pressure regulation upstream of the directional control valve
ZEY ²⁾		VABF-S...-R5C2-C-10-E	■	■	■	■	–	■	
ZJ		VABF-S...-R5C2-C-6	■	■	■	■	■	–	<p>Note</p> <p>These pressure regulator plates cannot be combined with standard 2x 3/2-way valves (code N, K, H). Reversible 2x 3/2-way valves (code P, Q, R) must not be operated in a separate pressure zone in combination with these pressure regulators.</p>
ZJY ²⁾		VABF-S...-R5C2-C-6-E	■	■	■	■	■	–	

1) These functions are also available via the pressure regulator configurator VABF-S2 for width 42 mm and 52 mm (ISO 5599-2, ISO 1 and ISO 2)

2) Also suitable for symmetrical valves

Valve terminals type 44/45, VTSA/VTSA-F, NPT

Key features – Pneumatic components – ISO 15407-2, width 18 and 26 mm; ISO 5599-2, width 42 and 52 mm

Vertical stacking – Pressure regulator plate – Type codes

VABF – S2 – 1 R1 C2 – C – 6 – L1 – E

Valve series	
VABF	Regulator plate

Allocation	
S2	ISO 5599-2 ¹⁾
S4	ISO 15407-2

Valve size	
1	26 mm (ISO 15407-2, ISO 01)
2	18 mm (ISO 15407-2, ISO 02)
1	42 mm (ISO 5599-2, ISO 1)
2	52 mm (ISO 5599-2, ISO 2)

Function plate	
R1	Pressure regulator, port 1
R2	Pressure regulator, port 2
R3	Pressure regulator, port 4
R4	Pressure regulator, ports 2 and 4
R5	Pressure regulator, ports 2 and 4, reversible
R6	Pressure regulator, port 2, reversible
R7	Pressure regulator, port 4, reversible

Pressure display	
C2	Sealed
C3	Pressure gauge [bar] ¹⁾
C4	Pressure gauge [MPa] ¹⁾
C6	Pressure gauge [psi] ¹⁾

Pneumatic connection	
C	Sealed

Pressure range	
6	6 bar
10	10 bar

Control element ²⁾	
–	Short (standard button)
L1	Long
L2	Long, lockable
K2	Short, lockable
K3	With integrated lock

Optional	
E	Extended design ¹⁾

1) These functions are available via the pressure regulator configurator VABF-S2, for width 42 mm and 52 mm (ISO 5599-2, ISO 1 and ISO 2) only. Alternatively they can be selected for all four sizes in the valve terminal configurator or via their own order numbers in the chapter Accessories on page 91.

2) All variants are only possible for VABF-S2.

Valve terminals type 44/45, VTSA/VTSA-F, NPT

Key features – Pneumatic components – ISO 15407-2, width 18 and 26 mm; ISO 5599-2, width 42 and 52 mm

Vertical stacking

Flow control plate

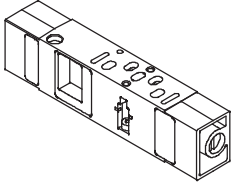

The flow control plate is equipped with two flow control valves on which the exhaust air flow rate at exhaust ports 3 or 5 can be adjusted. This enables the movement of the drive to be initiated and the desired speed to be set on the valve terminal using the manual override.

Ducts 3 and 5 can be adjusted independently of each other.



Note

On reversible valve terminals, supply air flow control takes place in ducts 3 and 5 upstream of the valve.

Code	Type	Width				Description
		18 mm	26 mm	42 mm	52 mm	
X	VABF-S4-...F1B1-C	■	■	■	■	<ul style="list-style-type: none"> Restricts the exhaust air downstream of the valve in ducts 3 and 5

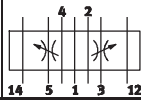

Vertical pressure shut-off plate

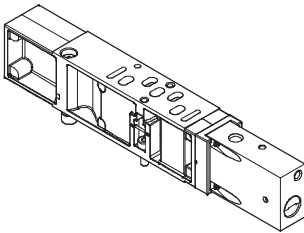

The vertical pressure shut-off plate is equipped with a switch via which the compressed air supply can be shut off. This enables a directional control valve or subsequent vertical stacking plate to be replaced without switching off the overall air supply. If the control chain has a redundant connection, the cycle can continue in the case of a cyclical control system.

Following activation of the shut-off, the exhaust air/return air from the cylinder is expelled via the M5 threaded connection.



Note

It must be ensured that the operating pressure of the valve terminal lies within the range of the required pilot pressure (i.e. min. 3 bar).
When using an end plate with pilot air selector, only end plates with the code W and U can be used.

Code	Type	Width				Description
		18 mm	26 mm	42 mm	52 mm	
ZT	VABF-S4-...L1D1-C	■	■	■	■	<ul style="list-style-type: none"> 3/2-way valve for shutting off the operating pressure at the valve position Blocks ducts 1 and 14 for the valve position Supplies the valve position with internal pilot air

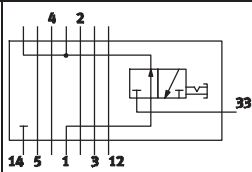

Valve terminals type 44/45, VTSA/VTSA-F, NPT

FESTO

Key features – Pneumatic components – ISO 15407-2, width 18 and 26 mm; ISO 5599-2, width 42 and 52 mm

Vertical supply plate

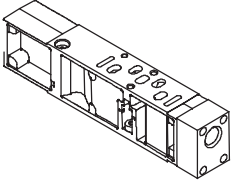

This plate enables a valve to be supplied with individual operating pressure independently of the operating pressure of the valve terminal.

As additional pressure supply for a valve. To supply an additional pressure zone.

Code	Type	Width				Description
		26 mm	18 mm	42 mm	52 mm	
ZU	VABF-S4-...P1A3-...	■	■	■	■	<ul style="list-style-type: none"> Plate with port 11 for supplying individual operating pressure to a valve position

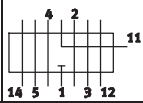

Valve terminals type 44/45, VTSA/VTSA-F, NPT

Key features – Pneumatic components – ISO 15407-2, width 18 and 26 mm; ISO 5599-2, width 42 and 52 mm

Compressed air supply and venting

Right-hand end plate

- Code V
- Internal pilot air supply

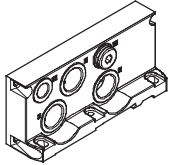

Right-hand end plate

- Code X
- External pilot air supply

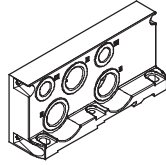

End plate with pilot air selector

- Code Z, Y, W, U

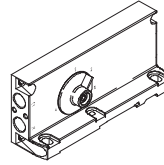

The valve terminal VTSA/VTSA-F can be supplied with compressed air at one or more points. This is a reliable way of ensuring that all functional components will always offer good performance, even with large-scale extensions. The valve terminal is supplied via supply plates (max. 16 per valve terminal) or via an end plate.

Right-hand end plate

- Code V1
- Internal pilot air supply

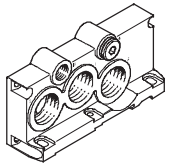

Right-hand end plate

- Code X1
- External pilot air supply

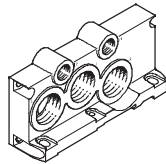

Venting is via silencers or ports for ducted exhaust air on the supply plates and/or on the right-hand end plate. There are two types of supply plates:

- Exhaust port 3/5 common
- Exhaust port 3/5 separated

Port configuration for supply plates

Exhaust port 3/5 separated

- Code K

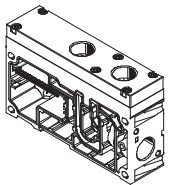

Port configuration for supply plates

Exhaust port 3/5 common

- Code L

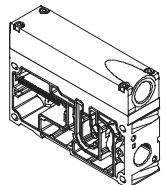

Pilot air supply

The port for the pneumatic supply is located on the supply plates or the right-hand end plate.

The ports differ for the following types of pilot air supply:

- Internal
- External



Note

If a gradual pressure build-up is required in the system by means of a soft-start valve, then external pilot air should be selected whereby the pilot pressure is already applied at the point of switch-on.

Internal pilot air supply

Internal pilot air supply can be selected if the working pressure is between 3 and 10 bar.

The pilot air supply is then branched from the compressed air supply 1 using an internal connection. Port 14 on the right-hand end plate is sealed with a blanking plug.

External pilot air supply

If the supply pressure is less than 3 bar, you must operate your valve terminal VTSA/VTSA-F using external pilot air supply.

The pilot air supply is then supplied via port 14 on the right-hand end plate. This is the case even if the valve terminal is operated with different pressure zones.

Valve terminals type 44/45, VTSA/VTSA-F, NPT

Key features – Pneumatic components – ISO 15407-2, width 18 and 26 mm; ISO 5599-2, width 42 and 52 mm

Additional compressed air supply/duct separation

Additional supply plates can be used for larger valve terminals or to create additional pressure zones.

These can be selected at any point upstream or downstream of the manifold sub-bases.

Supply plates contain the ports:

- Compressed air supply (1)
- Exhaust port (3/5) common or separated

Depending on your order, the exhaust air ducts are either ducted or vented via silencers.

VTSA/VTSA-F with ducted exhaust air:

With ducted exhaust air, venting can be via a supply plate or a right-hand end plate (code V or X).

If duct separation is required, there are three different options:

- Duct separation 1, 3, 5: code S
- Duct separation 1: code T
- Duct separation 3, 5: code R

If a combination of duct separation (S, T or R) and one or two supply plates is required, the following variants can be selected:

- Supply plate with duct separation on the left-hand side: code SU, TU, RU
- Supply plate with duct separation on the right-hand side: code US, UT, UR
- 2 supply plates with intermediate duct separation: code USU, UTU, URU

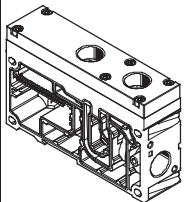
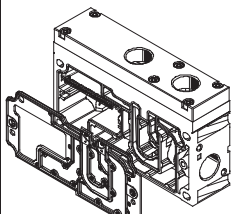
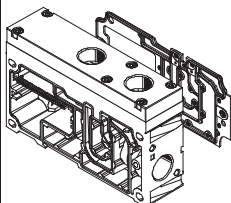
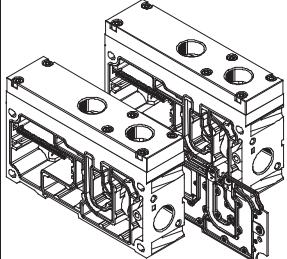
Supply plates							
Code	Image	Type	Width				Description
			18 mm	26 mm	42 mm	52 mm	
U		<ul style="list-style-type: none"> • Exhaust port 3/5 common VABF-S6-10-P1A7-G12 • Exhaust port 3/5 separated VABF-S6-10-P1A6-G12 	■	■	■	■	Supply plate without duct separation (no R, S or T selected)
SU TU RU			■	■	■	■	Supply plate with duct separation on left, if R, S or T selected
US UT UR			■	■	■	■	Supply plate with duct separation on right, if R, S or T selected
USU UTU URU			■	■	■	■	2 supply plates with duct separation in centre, if R, S or T selected

Valve terminals type 44/45, VTSA/VTSA-F, NPT

Key features – Pneumatic components – ISO 15407-2, width 18 and 26 mm; ISO 5599-2, width 42 and 52 mm

Right-hand end plate

Different right-hand end plates are available.

With the following two end plates, the outgoing direction of the ports is aligned with the horizontal stacking direction.

Right-hand end plates with pilot air supply/pilot exhaust air

- Internal pilot air supply: code V, V1 and V2
- External pilot air supply: code X, X1 and X2

For end plates with pilot air selector, the outgoing direction of the ports is to the front of the valve terminal. This means that all the ports on the valve terminal can be combined in one outgoing direction.

The special feature of the end plates with pilot air selector is the selector switch itself, which has four settings for different pilot air supply/pilot exhaust air.

End plates with pilot air selector switch set at the factory for:

- External pilot air supply: code Z
- Internal pilot air supply: code Y
- External pilot air supply, ducted pilot exhaust air: code W
- Internal pilot air supply, ducted pilot exhaust air: code U

 Note

The end plate with pilot air selector must be used in combination with a supply plate. The reversible 3/2-way valves (code P, Q, R) must only be operated in selector position 1 or 2. Ducted pilot exhaust air via port 12 is only possible with turned seals on the valve.

Right-hand end plate				
Code	Pilot supply air	Seal turned, pilot exhaust air ducted at port 12	Connecting thread	
			1, 3, 5	12, 14
V, V1, V2	Internal	■	1/2" NPT	1/4" NPT
X, X1, X2	External	■	1/2" NPT	1/4" NPT

Right-hand end plate with pilot air selector				
Code	Pilot supply air	Selector position	Seal turned, pilot exhaust air ducted at port 12	Connecting thread 12, 14
Z	External	1		1/4" NPT
Y	Internal	2		1/4" NPT
W	External	3	■	1/4" NPT
U	Internal	4	■	1/4" NPT

Handling of the seals with ducted/unducted pilot exhaust air

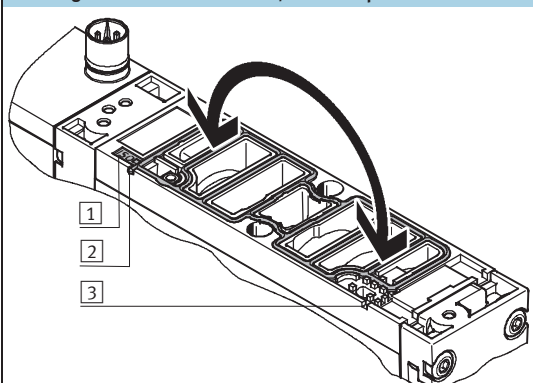

Unducted pilot exhaust air:

- The seal is visible in the inspection window on control side 14.
- The ISO mark is visible on the designation label on the seal surface.

Ducted pilot exhaust air:

- The seal is visible in the inspection window on control side 12.
- The ISO mark is visible on the designation label on the seal surface.

1 Designation label
2 Inspection window on control side 14
3 Inspection window on control side 12

Valve terminals type 44/45, VTSA/VTSA-F, NPT

Key features – Pneumatic components – ISO 15407-2, width 18 and 26 mm; ISO 5599-2, width 42 and 52 mm

Right-hand end plate							
Code	Type of compressed air supply and pilot air supply		Width				Description
			18 mm	26 mm	42 mm	52 mm	
Right-hand end plate							
V V1 V2			■	■	■	■	Internal pilot air supply <ul style="list-style-type: none"> • Pilot air supply is branched internally from port 1 • Port 14 is sealed with a blanking plug • Exhaust air via ports 3 and 5 • For operating pressure in the range 3 ... 10 bar • Pilot exhaust air via port 12¹⁾
X X1 X2			■	■	■	■	External pilot air supply <ul style="list-style-type: none"> • Pilot air supply between 2 and 10 bar is connected at port 14 • Exhaust air via ports 3 and 5 • For operating pressure in the range 0.9 ... 10 bar (suitable for vacuum) • Pilot exhaust air via port 12¹⁾
XP1			■	■	■	■	External pilot air supply, pressure supply via soft-start valve ²⁾ <ul style="list-style-type: none"> • Port 1 is sealed with a blanking plug • Exhaust air via ports 3 and 5 • Pilot exhaust air via port 12¹⁾
XP2			■	■	■	■	External pilot air supply, pressure supply via soft-start valve ²⁾ <ul style="list-style-type: none"> • Internal pilot air supply 14 via soft-start valve • Ports 1 and 14 are sealed with a blanking plug • Exhaust air via ports 3 and 5 • Pilot exhaust air via port 12¹⁾
XP3			■	■	■	■	External pilot air supply, pressure supply via soft-start valve ²⁾ <ul style="list-style-type: none"> • Internal pilot air supply 14 via soft-start valve • Ports 1, 3, 5 and 14 are sealed with a blanking plug • Pilot exhaust air via port 12¹⁾

1) Ducted pilot exhaust air is only possible with turned seals on the valve
 2) Application with XP1, XP2, XP3 and soft-start valve in combination with valves of width 52 mm: please note the maximum flow rate of the soft-start valve in this pressure zone

Valve terminals type 44/45, VTSA/VTSA-F, NPT

Key features – Pneumatic components – ISO 15407-2, width 18 and 26 mm; ISO 5599-2, width 42 and 52 mm

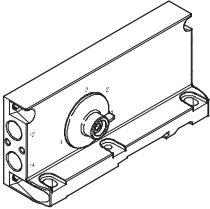
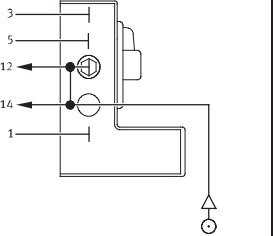
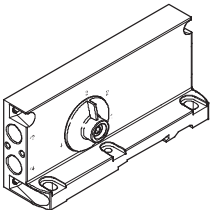
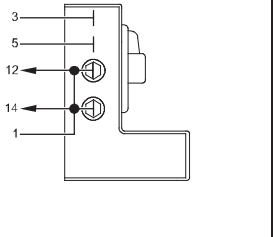
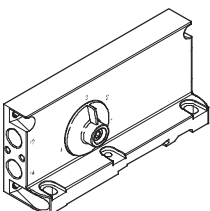
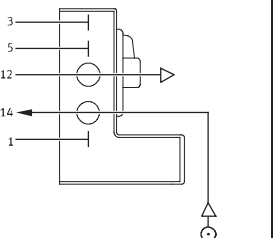
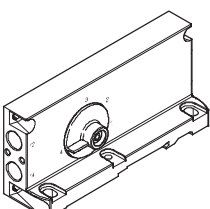
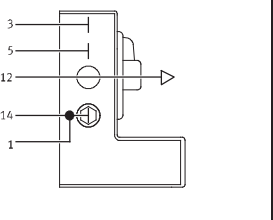
Right-hand end plate							
Code	Type of compressed air supply and pilot air supply	Width				Description	
		18 mm	26 mm	42 mm	52 mm		
Code ²⁾	End plate with pilot air selector ³⁾						
Z (1)			■	■	■	■	<p>External pilot air supply</p> <ul style="list-style-type: none"> Pilot air supply is connected at port 14 Port 12 is sealed with a blanking plug Ports 12 and 14 are internally connected Pilot exhaust air unducted via valve housing
Y (2)			■	■	■	■	<p>Internal pilot air supply</p> <ul style="list-style-type: none"> Pilot air supply is branched internally from port 1 Ports 1, 12 and 14 are internally connected Ports 12 and 14 are sealed with blanking plugs Pilot exhaust air unducted via valve housing
W (3)			■	■	■	■	<p>External pilot air supply, ducted pilot exhaust air</p> <ul style="list-style-type: none"> Pilot air supply is connected at port 14 Pilot exhaust air via port 12¹⁾
U (4)			■	■	■	■	<p>Internal pilot air supply, ducted pilot exhaust air</p> <ul style="list-style-type: none"> Pilot air supply is branched internally from port 1 Ports 1 and 14 are internally connected Port 14 is sealed with a blanking plug Pilot exhaust air via port 12¹⁾

1) Ducted pilot exhaust air is only possible with turned seals on the valve
 2) Selector setting in brackets
 3) Ducted pilot exhaust air is only possible in pilot air selector position 3 or 4

Valve terminals type 44/45, VTSA/VTSA-F, NPT



Key features – Pneumatic components – ISO 15407-2, width 18 and 26 mm; ISO 5599-2, width 42 and 52 mm

Configuration of all pneumatic connections with NPT thread						
Code		Port	Designation	Code M Push-in connector, large	Code N Push-in connector, small	
Right-hand end plate						
V			1	Push-in fitting	QS-1/2-5/8-U	QS-1/2-1/2-U
			3 and 5	Silencer or push-in fitting	U-1/2-B-NPT or QS-1/2-5/8-U	U-1/2-B-NPT or QS-1/2-1/2-U
			12	Silencer or push-in fitting	U-1/4-B-NPT or QS-1/4-3/8-U	U-1/4-B-NPT or QS-1/4-5/16-U
			14	Blanking plug	B-1/4-NPT	B-1/4-NPT
X			1	Push-in fitting	QS-1/2-5/8-U	QS-1/2-1/2-U
			3 and 5	Silencer or push-in fitting	U-1/2-B-NPT or QS-1/2-5/8-U	U-1/2-B-NPT or QS-1/2-1/2-U
			12	Silencer or push-in fitting	U-1/4-B-NPT or QS-1/4-3/8-U	U-1/4-B-NPT or QS-1/4-5/16-U
			14	Push-in fitting	QS-1/4-3/8-U	QS-1/4-5/16-U
V1			1	Female hose connector	N-3/4-P-19-NPT ¹⁾	–
			3 and 5	Silencer or female hose connector	U-3/4-B-NPT ¹⁾ or N-3/4-P-19-NPT ¹⁾	–
			12	Silencer or push-in fitting	U-1/4-B-NPT or QS-1/4-1/2-U	U-1/4-B-NPT or QS-1/4-3/8-U
			14	Blanking plug	B-1/4-NPT	B-1/4-NPT
X1			1	Female hose connector	N-3/4-P-19-NPT ¹⁾	–
			3 and 5	Silencer or female hose connector	U-3/4-B-NPT or N-3/4-P-19-NPT ¹⁾	–
			12	Silencer or push-in fitting	U-1/4-B-NPT or QS-1/4-1/2-U	U-1/4-B-NPT or QS-1/4-3/8-U
			14	Push-in fitting	QS-1/4-1/2-U	QS-1/4-3/8-U

1) For tubing with I.D. 19 mm. Use tubing clips to DIN 3017

Valve terminals type 44/45, VTSA/VTSA-F, NPT

Key features – Pneumatic components – ISO 15407-2, width 18 and 26 mm; ISO 5599-2, width 42 and 52 mm

Configuration of all pneumatic connections with NPT thread						
Code		Port	Designation	Code M Push-in connector, large	Code N Push-in connector, small	
Code ¹⁾	End plate with pilot air selector					
Z (1)			12	Blanking plug	B-1/4-NPT	B-1/4-NPT
			14	Push-in fitting	QS-1/4-3/8-U	QS-1/4-5/16-U
Y (2)			12	Blanking plug	B-1/4-NPT	B-1/4-NPT
			14	Blanking plug	B-1/4-NPT	B-1/4-NPT
W (3)			12	Silencer or push-in fitting	U-1/4-B-NPT or QS-1/4-3/8-U	U-1/4-B-NPT or QS-1/4-5/16-U
			14	Push-in fitting	QS-1/4-3/8-U	QS-1/4-5/16-U
U (4)			12	Silencer or push-in fitting	U-1/4-B-NPT or QS-1/4-3/8-U	U-1/4-B-NPT or QS-1/4-5/16-U
			14	Blanking plug	B-1/4-NPT	B-1/4-NPT

1) Selector setting in brackets

Valve terminals type 44/45, VTSA/VTSA-F, NPT

Key features – Pneumatic components – ISO 15407-2, width 18 and 26 mm; ISO 5599-2, width 42 and 52 mm



Creating pressure zones and separating exhaust air

The valve terminal VTSA/VTSA-F offers a number of options for creating pressure zones if different working pressures are required. Pressure zones are created by isolating the internal supply ducts between the manifold sub-bases by means of appropriate duct separation.

Compressed air is supplied and vented via a supply plate. The position of the supply plates and duct separations can be freely selected for VTSA/VTSA-F.

Duct separations are integrated ex-works as per your order. Duct separations can be distinguished by their coding, even when the valve terminal is assembled.

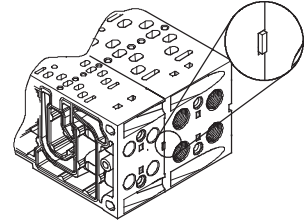

Creating pressure zones							
Code	Separating seal		Width				Description
	Pictorial examples	Coding	18 mm	26 mm	42 mm	52 mm	
T			■	■	■	■	Duct 1 separated
S			■	■	■	■	Ducts 1, 3 and 5 separated
R			■	■	■	■	Ducts 3 and 5 separated

Examples: Compressed air supply and pilot air supply, right-hand end plate

Internal pilot air supply, silencer/ducted exhaust air

Right-hand end plate: code V and V1
The diagram opposite shows an example of the configuration and connection of the compressed air supply with internal pilot air supply. Port 14 on the right-hand end plate is tightly sealed. At exhaust port 3/5 the air is expelled via the silencer. Duct separations can optionally be used to create pressure zones.

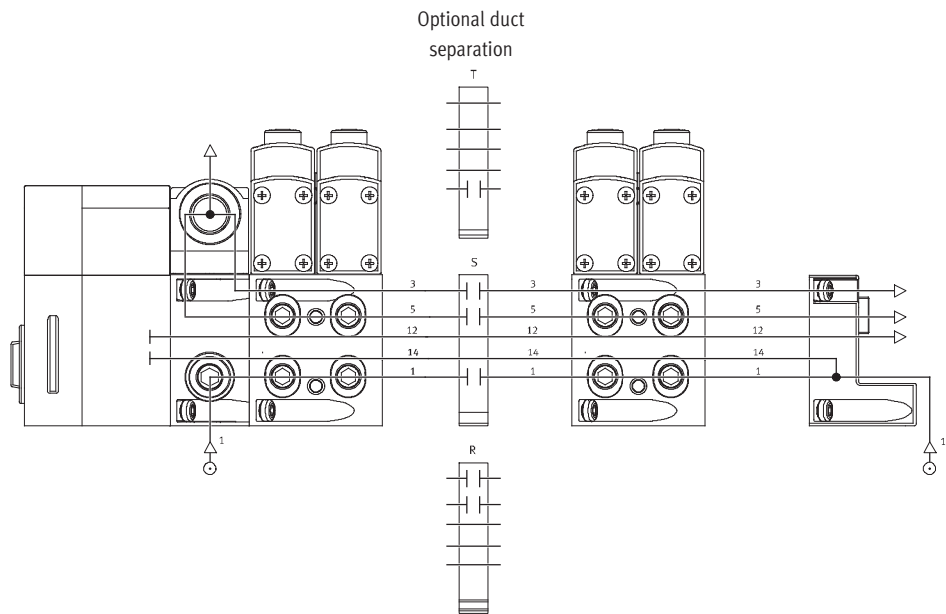

Valve terminals type 44/45, VTSA/VTSA-F, NPT

Key features – Pneumatic components – Compressed air supply and pressure zones, examples – ISO 15407-2, width 18 / 26 mm; ISO 5599-2, width 42 / 52 mm

Examples: Compressed air supply and pilot air supply, right-hand end plate

External pilot air supply, silencer/ducted exhaust air

Right-hand end plate: code X and X1
 The diagram opposite shows an example of the configuration and connection of the compressed air supply with external pilot air supply. Port 14 on the right-hand end plate is equipped with a fitting for this. At exhaust port 3/5 the air is expelled via the silencer.
 Duct separations can optionally be used to create pressure zones.

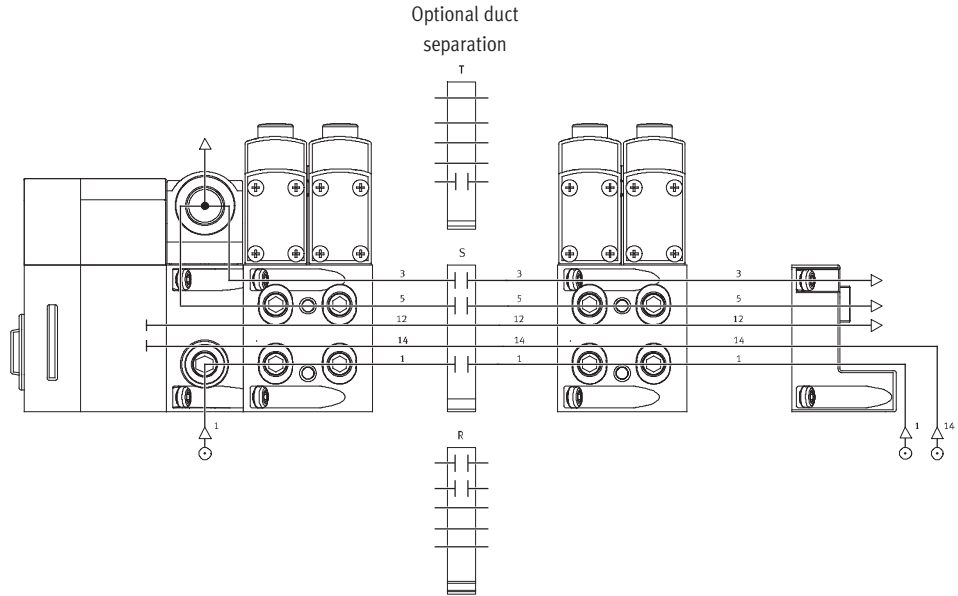

Examples: Compressed air supply and pilot air supply via end plate with pilot air selector

Internal pilot air supply, ducted exhaust air/silencer

Right-hand end plate: code U
 The diagram opposite shows an example of the configuration and connection of the compressed air supply with internal pilot air supply. Port 14 on the right-hand end plate is tightly sealed. At exhaust port 3/5 the air is ducted or expelled via the silencer.
 The selector switch in the pilot air selector is in position 4.
 Duct separations can optionally be used to create pressure zones.

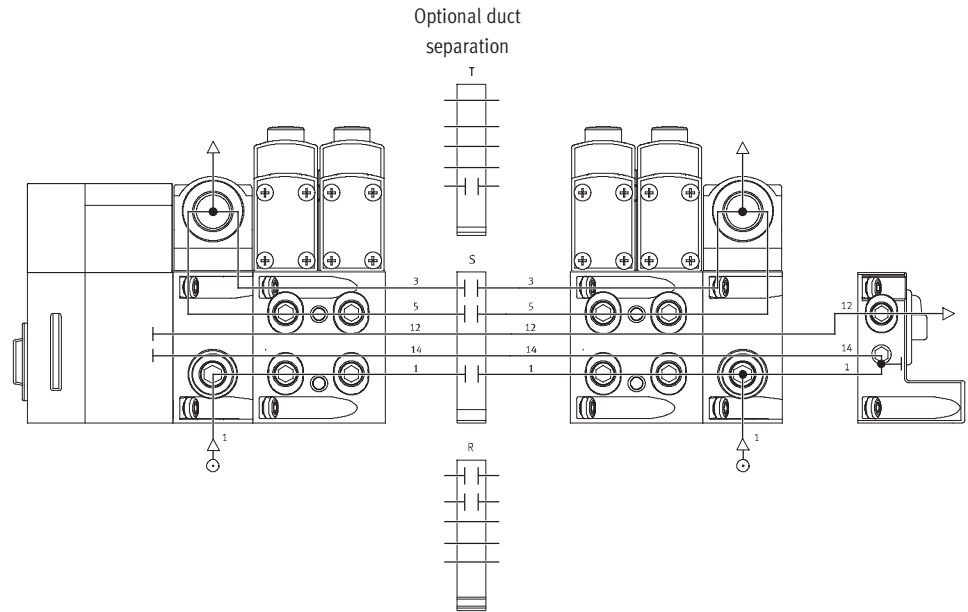

Valve terminals type 44/45, VTSA/VTSA-F, NPT

Key features – Pneumatic components – Compressed air supply and pressure zones, examples – ISO 15407-2, width 18 / 26 mm; ISO 5599-2, width 42 / 52 mm

Examples: Compressed air supply and pilot air supply via end plate with pilot air selector
 External pilot air supply, ducted exhaust air/silencer

Right-hand end plate: code Z
 The diagram opposite shows an example of the configuration and connection of the compressed air supply with external pilot air supply. Port 14 on the right-hand end plate is equipped with a fitting for this. Port 12 is sealed with a blanking plug since it is internally connected with port 14. At exhaust port 3/5 the air is ducted or expelled via the silencer. The selector switch on the pilot air selector is in position 1. Duct separations can optionally be used to create pressure zones.

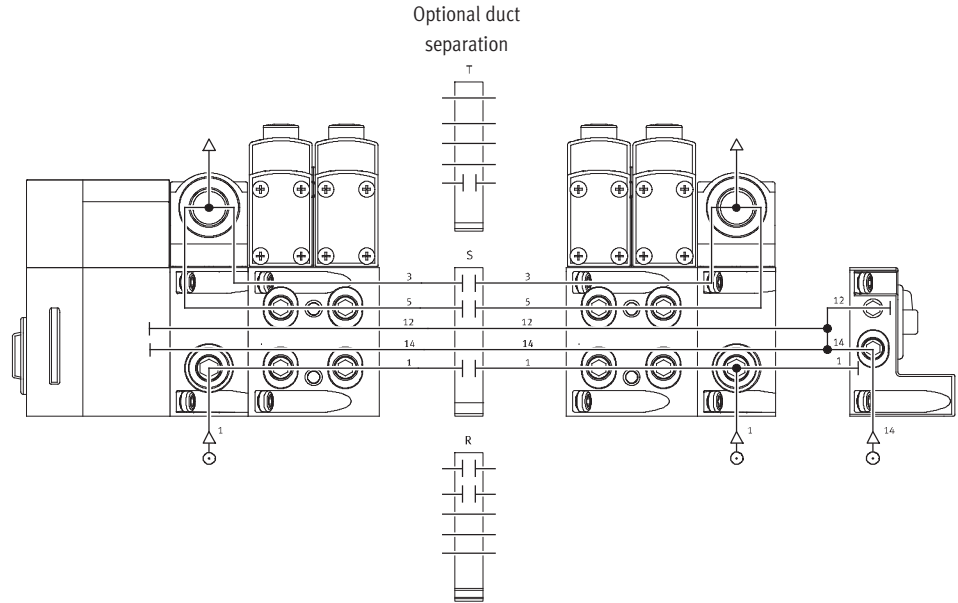

Examples: Creating pressure zones
 VTSA/VTSA-F with CPX terminal connection

VTSA/VTSA-F facilitates the creation of up to 16 pressure zones (up to 32 pressure zones if only size 1, ISO 5599-2, is fitted). The diagram shows an example of the configuration and connection of three pressure zones using duct separations – with internal pilot air supply.

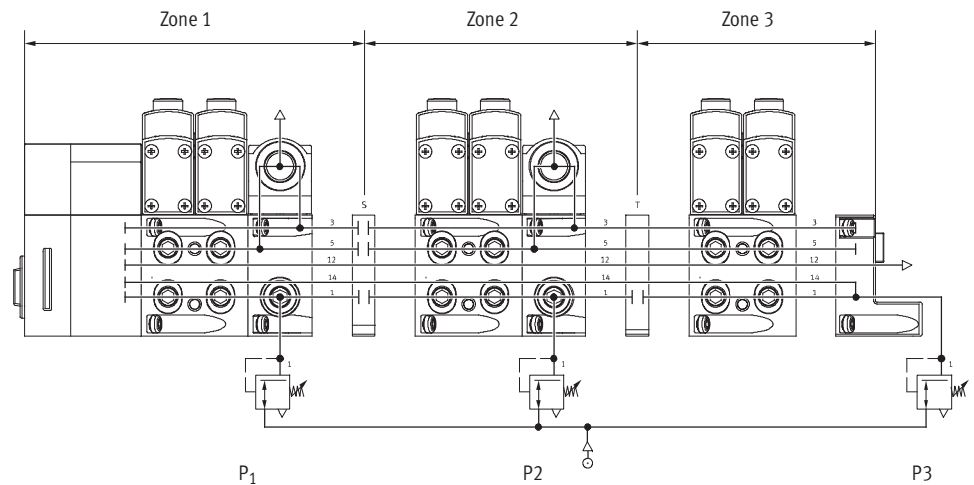

Valve terminals type 44/45, VTSA/VTSA-F, NPT

Key features – Mounting – ISO 15407-2, width 18 and 26 mm; ISO 5599-2, width 42 and 52 mm

Valve terminal mounting

Sturdy valve terminal mounting thanks to:

- Four through-holes for wall mounting
- Additional mounting brackets
- H-rail mounting

Wall mounting

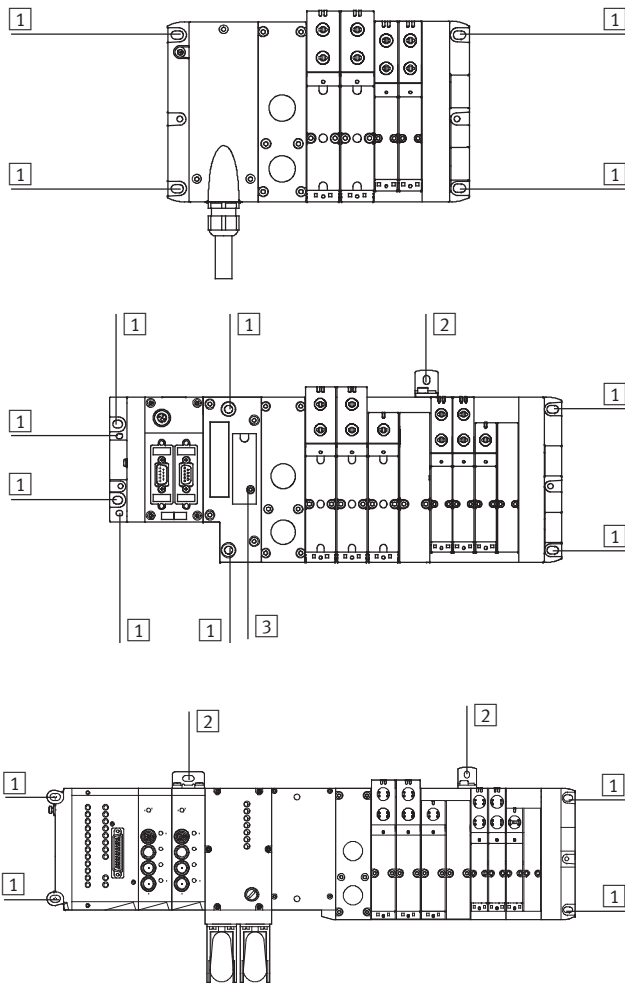

The valve terminal VTSA/VTSA-F is screwed onto the mounting surface using M6 screws. The mounting holes are located at the following points:

- Multi-pin plug (4 pieces): 2 each on the multi-pin connection block and the right-hand end plate
- Fieldbus, CPX (4 pieces): 2 each on the left-hand (CPX) and right-hand (VTSA/VTSA-F) end plate. The pneumatic interface additionally provides further mounting holes as well as optional mounting brackets.

- 1 Hole for M6 screw
- 2 Hole for M5 screw
- 3 Hole for H-rail mounting



Note

When wall mounting valve terminals with more than five manifold sub-bases, use additional mounting brackets of the type VAME-S...-10-W to prevent damage to the valve terminal. The mounting brackets are mounted on the pneumatic supply plates.

H-rail mounting

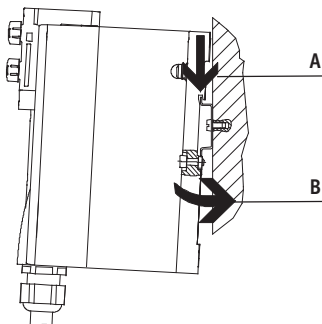

The valve terminal VTSA/VTSA-F is hooked onto the H-rail (see arrow A). It is then swivelled onto the H-rail and secured in place with the clamping component (see arrow B).

For H-rail mounting of the valve terminal you will need the following VTSA/VTSA-F mounting kit:

- CPX-CPA-BG-NRH

This permits mounting of the valve terminal on an H-rail to EN 60715.

Valve terminals type 44/45, VTSA/VTSA-F, NPT

FESTO

Key features – Mounting – ISO 15407-2, width 18 and 26 mm; ISO 5599-2, width 42 and 52 mm

Individual valve mounting

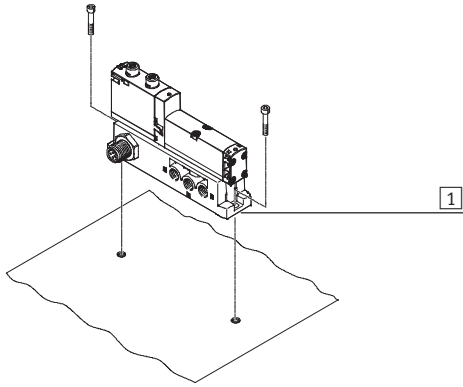

1 Vertical mounting holes

The individual sub-base for wall mounting is designed for integration into a system or machine. It is mounted vertically.

Valve terminals type 44/45, VTSA/VTSA-F, NPT

Key features – Display and operation – ISO 15407-2, width 18 and 26 mm; ISO 5599-2, width 42 and 52 mm

Display and operation

Each solenoid coil is allocated an LED which indicates its switching status.

- Indicator 12 shows the switching status of the pilot control for output 2
- Indicator 14 shows the switching status of the pilot control for output 4

Manual override

The manual override enables the valve to be switched when not electrically actuated or energised.

The valve is switched by pushing the manual override. The set switching status can also be locked by turning

the manual override.

Alternatives:

- A cover cap (accessory code N) can be fitted over the manual override to prevent it from being turned. The valve can then only be actuated by pressing it.

- A cover (code V) can be fitted over the manual override to prevent it from being accidentally actuated.

Pneumatic connection and control elements

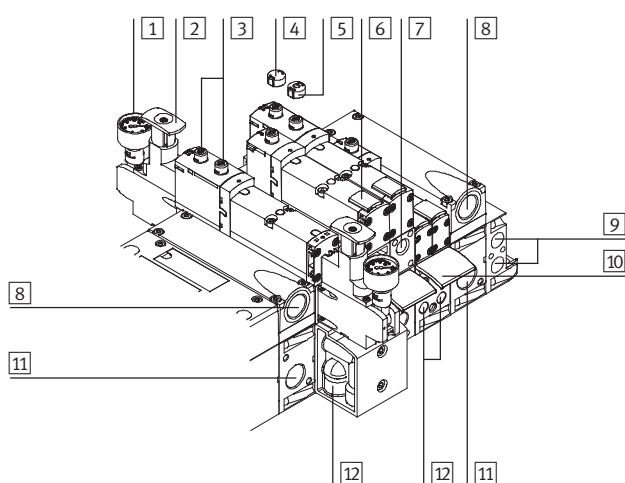

- 1 Pressure gauge (optional)
- 2 Adjusting knob of optional pressure regulator plate
- 3 Manual override (for each pilot solenoid coil, non-detenting or non-detenting/detenting)
- 4 Optional cover cap for manual override (prevents usage of manual override)
- 5 Optional cover cap for manual override with non-detenting function
- 6 Inscription label holder for valve
- 7 Adjusting screw of optional flow control plate
- 8 Exhaust ports "valves" (3/5)
- 9 Pilot ports 12 and 14 for supplying the external pilot air
- 10 Inscription label holder for sub-base
- 11 Supply port 1 "operating pressure"
- 12 Working lines 2 and 4, for each valve position

Note
A manually actuated valve (manual override) cannot be reset electrically. Conversely, an electrically actuated valve cannot be reset using the mechanical manual override.

Electrical connection and display components

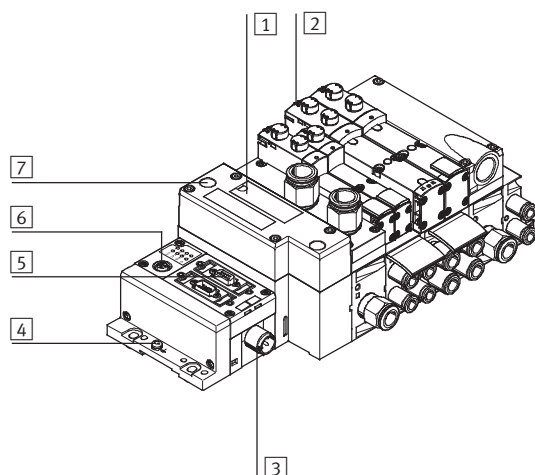

- 1 Inscription area and cover for H-rail mounting
- 2 Yellow LEDs: signal status display for pilot solenoid coils
- 3 Power supply connection
- 4 Earth terminal
- 5 Fieldbus connection (bus-specific)
- 6 Service interface for handheld unit, etc.
- 7 Red LED: common error display for valves

Valve terminals type 44/45, VTSA/VTSA-F, NPT

Key features – Display and operation – ISO 15407-2, width 18 and 26 mm; ISO 5599-2, width 42 and 52 mm

Manual override (MO)

MO with automatic return (non-detenting)

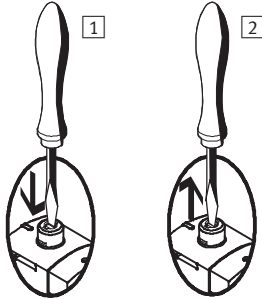

- 1 Press in the stem of the manual override using a pointed object or screwdriver. Valve is then switched.
- 2 Remove the pointed object or screwdriver. Spring force pushes the stem of the manual override back. Valve returns to initial position (not with double solenoid valve code J).

MO set via turning (covered)

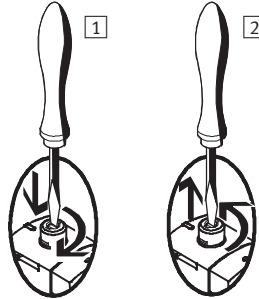

- 1 Press in the stem of the manual override using a pointed object or screwdriver until the valve switches and then turn the stem clockwise by 90° until the stop is reached. Valve remains switched.
- 2 Turn the stem anti-clockwise by 90° until the stop is reached and then remove the pointed object or screwdriver. Spring force pushes the stem of the manual override back. Valve returns to initial position (not with double solenoid valve code J and D).

Identification system

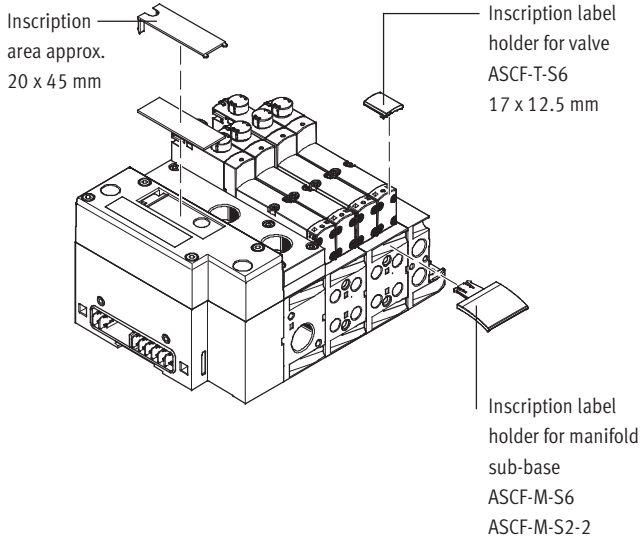

Inscription label holders can be applied to the valves and manifold sub-bases to identify them. These inscription label holders can be ordered by entering the code B or T in the order code for accessories. Scope of delivery: inscription label holder including inscription label. The following inscription labels can be used as spares:

- Inscription label holder for valve type ASCF-T-S6: Part-No. 540888

- Inscription label holder for manifold sub-base type ASCF-M-S6: Part No. 540889
 - Inscription label holder for manifold sub-base (for valve width 52 mm) type ASCF-M-S2-2: Part No. 562577
- Large inscription labels can be attached to the pneumatic interface as an alternative or in addition to the smaller labels.

Valve terminals type 44/45, VTSA/VTSA-F, NPT

Key features – Electrical components – ISO 15407-2, width 18 and 26 mm; ISO 5599-2, width 42 and 52 mm

Protective circuit

Each VSVA solenoid coil is protected with a spark arresting protective circuit as well as against polarity reversal.

The 24 V DC version of width 52 mm additionally features integrated holding current reduction.

24 V DC version (width 18 to 42 mm)

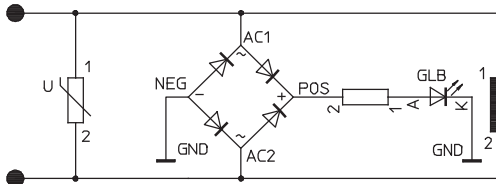

110 V AC version (width 18 to 52 mm)

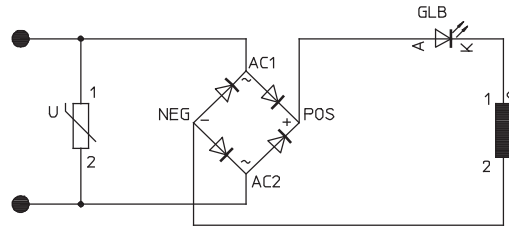

24 V DC version (width 52 mm)

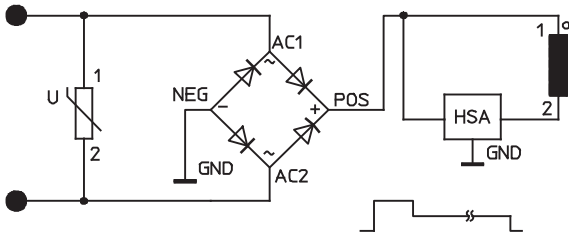

Individual valve

Valves can also be used on individual sub-bases for actuators further away from the valve terminal.

- Electrical connection M12, 4 pin 24 V DC
- 4-pin clamped terminal connection for configuration by the user 24 V DC or 110 V AC
- Cable (open end) for configuration by the user 24 V DC or 110 V AC

Individual electrical connection

A maximum of 20 solenoid coils can be actuated. 2 solenoid coils per valve can be addressed.

Individual electrical connection:

- M12
- 6-way or 10-way
- 5-pin
- 24 V DC

Valve terminals type 44/45, VTSA/VTSA-F, NPT

Key features – Electrical components – ISO 15407-2, width 18 and 26 mm; ISO 5599-2, width 42 and 52 mm

Electrical multi-pin plug connection

The following multi-pin plug connection variants are offered for the valve terminal VTSA/VTSA-F:

- Sub-D multi-pin plug connection (37-pin for 24 V DC): this valve terminal is available with 1 ... 16 valve positions equipped with double solenoid valves and 1 ... 32 valve positions equipped with single solenoid valves. A maximum of 32 solenoid coils can be actuated.
- Terminal box (terminal strip for 24 V DC or 110 V AC): this valve terminal is available with 1 ... 16 valve positions equipped

with double solenoid valves and 1 ... 32 valve positions equipped with single solenoid valves.

- A maximum of 32 solenoid coils can be actuated.
- Multi-pin node (round plug connector): electrical multi-pin plug connection with round plug connector, 19-pin to CNOMO E03.62.530.N, connecting thread M23 for 24 V DC. The valve terminal can be equipped with max. 16 solenoid coils.

The valves are switched by means of positive or negative logic

(PNP or NPN). Mixed operation is not permitted.

Each pin on the Sub-D multi-pin plug or terminal box (terminal strip) can actuate exactly one solenoid coil. If the maximum configurable number of valve positions is 32, this means that 32 valves, each with a single solenoid coil, can be addressed. With 16 or fewer valve positions, 2 solenoid coils per valve can be addressed.



Note

Use the following 37-pin connecting cables from Festo to connect the valve terminal VTSA/VTSA-F with Sub-D multi-pin plug connection:

- NEBV-S1W37-...-LE10 for max. 8 solenoid coils
- NEBV-S1W37-...-LE26 for max. 22 solenoid coils
- NEBV-S1W37-...-LE37 for max. 32 solenoid coils
- NECV-S1W37 pre-assembled plug connector

AS-interface connection

Valve terminals VTSA/VTSA-F with AS-interface connection can be expanded with up to 8 valves with max. 8 solenoid coils. The valve terminal with AS-interface connection is based on the same electrical manifold module as the

valve terminal with multi-pin plug connection. This means it is possible to convert a valve terminal with multi-pin plug connection using an AS-interface module.

- The technical specifications of the AS-interface system must be observed in this case.



Note

AS-i module VAEM-S6-S-FAS-4-4E. Always operate solenoid valves with additional power supply if 4 solenoid coils (width 52 mm) are supplied with current simultaneously. More information can be found at:
 → Internet: as-interface

Fieldbus connection/control block

All functions and features of the electrical peripherals CPX are permitted in connection with the CPX interface. This means:

- The valves and electrical outputs are supplied via the operating voltage connection CPX
- The valves are supplied and switched off independently via a separate port on the CPX



Note

More information can be found at:
 → Internet: cpx

Valve terminals type 44/45, VTSA/VTSA-F, NPT

Key features – Electrical components – ISO 15407-2, width 18 and 26 mm; ISO 5599-2, width 42 and 52 mm

Pin allocation – Sub-D plug socket, 24 V DC; electrical connection code MP1							
	Pin ²⁾	Address/coil	Wire colour ¹⁾		Pin ²⁾	Address/coil	Wire colour ¹⁾
	1	0	WH		17	16	WH PK
	2	1	BN		18	17	PK BN
	3	2	GN		19	18	WH BU
	4	3	YE		20	19	BN BU
	5	4	GY		21	20	WH RD
	6	5	PK		22	21	BN RD
	7	6	BU		23	22	GY GN
	8	7	RD		24	23	YE GY
	9	8	GY PK		25	24	PK GN
	10	9	RD BU		26	25	YE PK
	11	10	WH GN		27	26	GN BU
	12	11	BN GN		28	27	YE BU
	13	12	WH YE		29	28	GN RD
	14	13	YE BN		30	29	YE RD
	15	14	WH GY		31	30	GN BK
	16	15	GY BN		32	31	GY BU
<p>Note</p> <p>The drawing shows the view onto the Sub-D plug socket at the connecting cable NEBV-S1W37-....</p>	Conductor						
	33	0 V ³⁾	YE BK		35	0 V ³⁾	BN BK
	34	0 V ³⁾	WH BK		36	0 V ³⁾	BK
	Earthing						
	37	FE	VT		-	-	-

- 1) To IEC 757
- 2) Pin 9 ... 35: not used with connecting cable NEBV-S1-W37-...-LE10
Pin 23 ... 33: not used with connecting cable NEBV-S1-W37-...-LE26
- 3) 0 V for positive switching control signals; connect 24 V for negative switching control signals; mixed operation is not permitted.

Dimensions

Download CAD data → www.festo.com

Connecting cable NEBV-S1W37-...

1 Cable connector M20x1.5

The wire colours refer to the following pre-assembled connecting cables from Festo:

- NEBV-S1W37-...-LE10 for valve terminal with max. 8 solenoid coils
- NEBV-S1W37-...-LE26 for valve terminal with max. 22 solenoid coils
- NEBV-S1W37-...-LE37 for valve terminal with max. 32 solenoid coils

Valve terminals type 44/45, VTSA/VTSA-F, NPT

FESTO

Key features – Electrical components – ISO 15407-2, width 18 and 26 mm; ISO 5599-2, width 42 and 52 mm

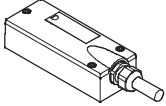
Sub-D plug, 24 V DC, connecting cable; electrical connection code MP1						
	Sheath	Length [m]	Wire x mm ² [mm ²]	Cable diameter [mm]	Part No.	Type
	Polyurethane	2.5	10 x 0.34	7.7	539240	NEBV-S1W37-E2,5-LE10
		5			539241	NEBV-S1W37-E5-LE10
		10			539242	NEBV-S1W37-E10-LE10
		2.5	26 x 0.34	11.5	539243	NEBV-S1W37-E2,5-LE26
		5			539244	NEBV-S1W37-E5-LE26
		10			539245	NEBV-S1W37-E10-LE26
		2.5	37 x 0.34	13	539246	NEBV-S1W37-K2,5-LE37
		5			539247	NEBV-S1W37-K5-LE37
		10			539248	NEBV-S1W37-K10-LE37
	Polyvinyl chloride, cable properties (standard)	2.5	10 x 0.34	7.7	543271	NEBV-S1W37-KM-2,5-LE10
		5			543272	NEBV-S1W37-KM-5-LE10
		10			543273	NEBV-S1W37-KM-10-LE10
		2.5	27 x 0.34	11.5	543274	NEBV-S1W37-KM-2,5-LE27
		5			543275	NEBV-S1W37-KM-5-LE27
		10			543276	NEBV-S1W37-KM-10-LE27
		2.5	37 x 0.34	13	543277	NEBV-S1W37-KM-2,5-LE37
		5			543278	NEBV-S1W37-KM-5-LE37
		10			543279	NEBV-S1W37-KM-10-LE37

Valve terminals type 44/45, VTSA/VTSA-F, NPT

Key features – Electrical components – ISO 15407-2, width 18 and 26 mm; ISO 5599-2, width 42 and 52 mm

Pin allocation – Multi-pin terminal strip (CageClamp), 24 V DC and 110–V AC; electrical connection code T					
	Terminal	Coil/address		Terminal	Coil/address
<p>Each solenoid coil must be assigned to a specific terminal on the terminal strip in order for the valves to be actuated.</p> <p>Coil 0</p> <p>Coil 19</p> <p>0 V¹⁾ Coil 20</p> <p>Coil 31</p>	1	0		17	16
	2	1		18	17
	3	2		19	18
	4	3		20	19
	5	4		21	20
	6	5		22	21
	7	6		23	22
	8	7		24	23
	9	8		25	24
	10	9		26	25
	11	10		27	26
	12	11		28	27
	13	12		29	28
	14	13		30	29
	15	14		31	30
	16	15		32	31
<p> Note</p> <p>The drawing shows the view onto the multi-pin terminal strip (Cage Clamp®).</p>	Conductor				
	33	0 V		35	0 V
	34	0 V		36	0 V

Pin allocation – Round plug connector, 24 V DC; electrical connection code MP4					
	Address	Pin ¹⁾		Address	Pin ¹⁾
	0	15		8	17
	1	7		9	9
	2	5		10	2
	3	4		11	13
	4	16		12	11
	5	8		13	10
	6	3		14	1
	7	14		15	18

Pin allocation – Round plug connector, 24 V DC; electrical connection – CNOMO assignment					
	Pin	Valve position/solenoid coil		Pin	Valve position/solenoid coil
	1	8/14		10	7/12
	2	6/14		11	7/14
	3	4/14		12	FE
	4	2/12		13	6/12
	5	2/14		14	4/12
	6	0 V ¹⁾		15	1/14
	7	1/12		16	3/14
	8	3/12		17	5/14
	9	5/12		18	8/12
			19	Unused	

1) Pin 6: 0 V for positive switching control signals; connect 24 V for negative switching control signals; mixed operation is not permitted.
 Pin 12: earth
 Pin 19: unused

Rules for addressing

- Address allocation does not depend on whether single or double solenoid valves are fitted.
- Addresses are allocated in

ascending order without gaps, from left to right.

- A valve position for actuating one solenoid coil occupies one address (type VABV-...-...T1).

- A valve position for actuating two solenoid coils occupies two addresses (type VABV-...-...T2). The following allocation applies in this case:

- Coil 14: lower-value address
- Coil 12: higher-value address

Valve terminals type 44/45, VTSA/VTSA-F, NPT

Key features – Electrical components – ISO 15407-2, width 18 and 26 mm; ISO 5599-2, width 42 and 52 mm

Electrical connection, individual valve 24 V DC or 110 V AC up to width 52 mm

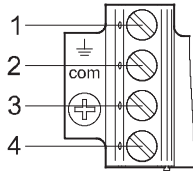
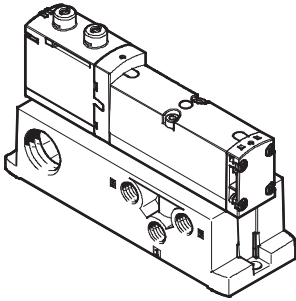

Pin allocation for assembly by the user

With positive logic:

Pin1 – Unused (with 110 V AC connection for earthing)

Pin2 – U_B for coil 12

Pin3 – 0 V for coil 12 and 14

Pin4 – U_B for coil 14

With negative logic:

Pin1 – Unused

Pin2 – 0 V for coil 12

Pin3 – U_B for coil 12 and 14

Pin4 – 0 V for coil 14

Individual electrical connection, 6-way or 10-way, 24 V DC, code MP2/MP3 for valve terminal up to width 52 mm

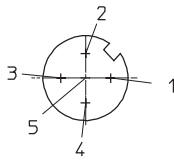
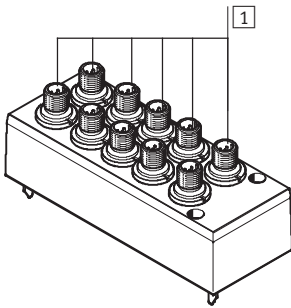

Pin allocation M12

With positive logic:

Pin1 – Unused

Pin2 – U_B for coil 12

Pin3 – 0 V for coil 12 and 14

Pin4 – U_B for coil 14

Pin5 – Functional earth

Pin allocation M12

With negative logic:

Pin1 – Unused

Pin2 – 0 V for coil 12

Pin3 – U_B for coil 12 and 14

Pin4 – 0 V for coil 14

Pin5 – Functional earth

1 Connector plug M12x1, 5-pin

 Note

Mixed operation of positive switching (PNP) and negative switching (NPN) control signals is not permitted.

Valve terminals type 44/45, VTSA/VTSA-F, NPT

FESTO

Instructions for use – ISO 15407-2, width 18 and 26 mm; ISO 5599-2, width 42 and 52 mm

System equipment

Operate system equipment with unlubricated compressed air if possible. Festo valves and cylinders are designed so that, if used as designated, they will not require additional lubrication and will still achieve a long service life. The quality of compressed air downstream of the compressor must correspond to that of unlubricated compressed air. If possible, do not operate all of your system equipment with lubricated compressed air. The lubricators should, where possible, always be installed directly upstream of the actuator used.

Incorrect additional oil and too high an oil content in the compressed air reduce the service life of the valve terminal.

Use Festo special oil OFSW-32 or the alternatives listed in the Festo catalogue (as specified in DIN 51524 HLP32; basic oil viscosity 32 CST at 40 °C).

Bio-oils

When using bio-oils (oils which are based on synthetic or native ester, e.g. rapeseed oil methyl ester), the maximum residual oil content of 0.1 mg/m³ must not be exceeded (see ISO 8573-1 Class 2).

Mineral oils

When using mineral oils (e.g. HLP oils to DIN 51524, parts 1 to 3) or similar oils based on poly-alpha-olefins (PAO), the maximum residual oil content of 5 mg/m³ must not be exceeded (see ISO 8573-1 Class 4). A higher residual oil content irrespective of the compressor oil cannot be permitted, as the basic lubricant would be flushed out over time.

Valve terminals type 44/45, VTSA/VTSA-F, NPT

FESTO

Technical data – Valve terminal – ISO 15407-2, width 18 and 26 mm; ISO 5599-2, width 42 and 52 mm

-  - Valve width
to ISO 15407-2
- 18 mm
 - 26 mm
- to ISO 5599-2
- 42 mm (ISO 1)
 - 52 mm (ISO 2)

-  - Voltage
24 V DC
110 V AC

-  - Flow rate
- Width 18 mm:
up to 550 (700) l/min
- Width 26 mm:
up to 1,100 (1,400) l/min
- Width 42 mm:
up to 1,400 l/min
- Width 52 mm:
up to 2,900 l/min

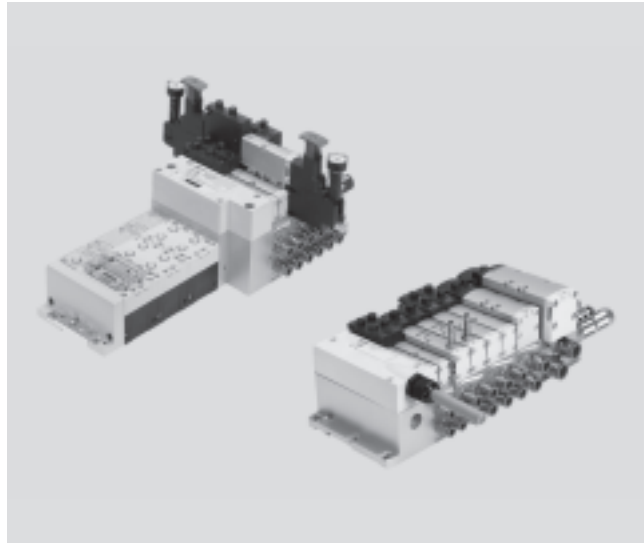

Values in brackets apply to VTSA-F

General technical data					
Design	Piston spool valve				
Sealing principle	Soft				
Actuation type	Electrical				
Type of control	Piloted				
Exhaust function, with flow control	Via flow control plate				
Lubrication	Lubricated for life				
Type of mounting	Wall mounting				
	On H-rail to EN 60715				
Mounting position	Any				
Manual override	Non-detenting, detenting, covered				
Valve terminal design	Modular and expandable				
Max. no of valve positions	32				
Pneumatic connections – NPT thread					
Width	18 mm	26 mm	42 mm	52 mm	
Pneumatic connection	Via manifold sub-base				
Supply port	1	<ul style="list-style-type: none"> • 1/2" NPT • QS-1/2-5/8-U • QS-1/2-1/2-U 	<ul style="list-style-type: none"> • 1/2" NPT • QS-1/2-5/8-U • QS-1/2-1/2-U 	<ul style="list-style-type: none"> • 1/2" NPT • QS-1/2-5/8-U • QS-1/2-1/2-U 	<ul style="list-style-type: none"> • 3/4" NPT • N-3/4-P-19-NPT
Exhaust port	3/5	<ul style="list-style-type: none"> • 1/2" NPT • QS-1/2-5/8-U • QS-1/2-1/2-U 	<ul style="list-style-type: none"> • 1/2" NPT • QS-1/2-5/8-U • QS-1/2-1/2-U 	<ul style="list-style-type: none"> • 1/2" NPT • QS-1/2-5/8-U • QS-1/2-1/2-U 	<ul style="list-style-type: none"> • 3/4" NPT • N-3/4-P-19-NPT
Working lines	2/4	Dependent on the connection type selected			
		<ul style="list-style-type: none"> • 1/8" NPT • QS-1/8-5/16-U • QS-1/8-1/4-U 	<ul style="list-style-type: none"> • 1/4" NPT • QS-1/4-3/8-U • QS-1/4-5/16-U 	<ul style="list-style-type: none"> • 3/8" NPT • QS-3/8-1/2-U • QS-3/8-3/8-U 	<ul style="list-style-type: none"> • 1/2" NPT • QS-1/2-5/8-U • QS-1/2-1/2-U
External pilot air supply port	14	<ul style="list-style-type: none"> • 1/4" NPT • QS-1/4-3/8-U • QS-1/4-5/16-U 	<ul style="list-style-type: none"> • 1/4" NPT • QS-1/4-3/8-U • QS-1/4-5/16-U 	<ul style="list-style-type: none"> • 1/4" NPT • QS-1/4-3/8-U • QS-1/4-5/16-U 	<ul style="list-style-type: none"> • 1/4" NPT • QS-1/4-1/2-U • QS-1/4-3/8-U
Pilot exhaust air port	12	<ul style="list-style-type: none"> • 1/4" NPT • QS-1/4-3/8-U • QS-1/4-5/16-U 	<ul style="list-style-type: none"> • 1/4" NPT • QS-1/4-3/8-U • QS-1/4-5/16-U 	<ul style="list-style-type: none"> • 1/4" NPT • QS-1/4-3/8-U • QS-1/4-5/16-U 	<ul style="list-style-type: none"> • 1/4" NPT • QS-1/4-1/2-U • QS-1/4-3/8-U

-  - Note: This product conforms to ISO 1179-1 and to ISO 228-1

Valve terminals type 44/45, VTSA/VTSA-F, NPT

Technical data – Valve terminal – ISO 15407-2, width 18 and 26 mm; ISO 5599-2, width 42 and 52 mm

Standard nominal flow rate – Valve terminal VTSA																	
Valve function order code	VC	VV	N	K	H	P	Q	R	M	O	J	D	B	G	E	SA	SB
Width 18 mm																	
Flow rate of valve [l/min]	700		600						750				700 ¹⁾ , 330 ²⁾			–	–
Flow rate of valve on valve terminal [l/min]	500		400						550				450 ¹⁾ , 330 ²⁾			–	–
Width 26 mm																	
Flow rate of valve [l/min]	1,350		1,250						1,400				1,400 ¹⁾			1,400	700
Flow rate of valve on valve terminal [l/min]	1,000		900						1,100				1,000 ¹⁾ , 700 ²⁾			1,000	700
Width 42 mm																	
Flow rate of valve [l/min]	1,600		1,600						2,000				1,900 ¹⁾ , 800 ²⁾			–	–
Flow rate of valve on valve terminal [l/min]	1,400		1,200						1,300				1,200 ¹⁾ , 800 ²⁾			–	–
Width 52 mm																	
Flow rate of valve [l/min]	4,000	–	3,000						4,000				3,600 ¹⁾ , 1,700 ²⁾			–	–
Flow rate of valve on valve terminal [l/min]	2,800	–	2,400						2,900				2,800 ¹⁾ , 1,700 ²⁾			–	–

- 1) Switching position
- 2) Mid-position

Standard nominal flow rate – Valve terminal VTSA-F																	
Valve function order code	VC	VV	N	K	H	P	Q	R	M	O	J	D	B	G	E	SA	SB
Width 18 mm																	
Flow rate of valve [l/min]	700		600						750				700 ¹⁾ 330 ²⁾			–	–
Flow rate of valve on valve terminal [l/min]	650		550						700				480 ¹⁾ (U) 330 ²⁾ (E) 650 (C)			–	–
Width 26 mm																	
Flow rate of valve [l/min]	1,350		1,250						1,400				1,400 ¹⁾			1,400	700
Flow rate of valve on valve terminal [l/min]	1,300		1,150						1,350				1,350 ¹⁾ 700 ²⁾			1,000	700

- 1) Switching position
- 2) Mid-position

Operating and environmental conditions																	
Valve function order code	VC	N	K	H	VV	P	Q	R	M	O	J	D	B	G	E	SA	SB
Operating medium	Filtered compressed air, lubricated or unlubricated, inert gases → 57																
Grade of filtration [µm]	40 (average pore size)																
Operating pressure [bar]	3 ... 10				–0.9 ... +10												
Operating pressure for valve terminal with internal pilot air supply [bar]	3 ... 10																
Pilot pressure [bar]	3 ... 10																
Ambient temperature [°C]	–5 ... +50																
Temperature of medium [°C]	–5 ... +50																
Storage temperature ¹⁾ [°C]	–20 ... +40																
Relative air humidity [%]	90																
PWIS criterion	Free of paint-wetting impairment substances																

- 1) Long-term storage

Valve terminals type 44/45, VTSA/VTSA-F, NPT

Technical data – Valve terminal – ISO 15407-2, width 18 and 26 mm; ISO 5599-2, width 42 and 52 mm

Pneumatic characteristic data																	
Valve function order code	VC	VV	N	K	H	P	Q	R	M	O	J	D	B	G	E	SA	SB
Direction of flow																	
Any	-	■	-	-	-	-	-	-	■	■	■	■	■	■	■	-	■
Reversible only	-	-	-	-	-	■	■	■	-	-	-	-	-	-	-	-	-
Non-reversible	■	-	■	■	■	-	-	-	-	-	-	-	-	-	-	■	-
Reset method																	
Pneumatic	■	■	■	-	■	■	■	■	■	-	-	-	-	-	-	■	■
Mechanical spring	-	-	-	■	-	-	-	-	-	■	-	-	■	■	■	-	-

Pilot pressure p12/14 as a function of operating pressure p1 for 3/2-way valves

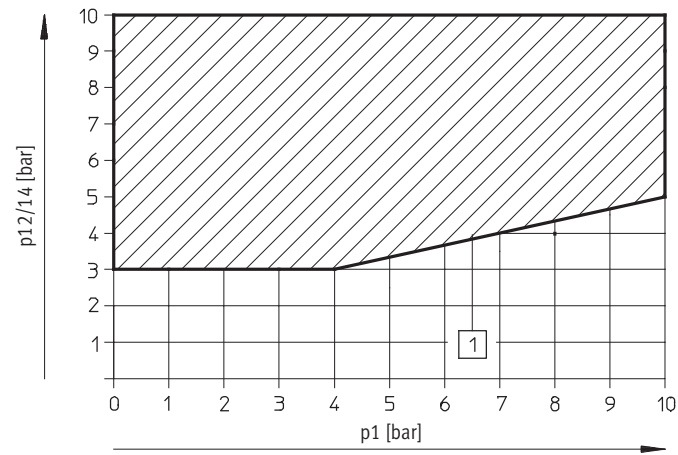

1 Operating range for valves with external pilot air supply

Note

Reversible 3/2-way valves (flow direction reversible only)

- These values must only be operated on pressure zones with reversible supply (3 and 5 with supply pressure 1 as exhaust air) or on a reversible pressure regulator. If necessary create pressure separation zones with duct separation.
- Reversible 3/2-way valves do not permit the special function "pilot exhaust air ducting"
 - Ports 12 and 14 on the end plate variants must be supplied with the same pressure
 - Right-hand end plate with pilot air selector: can be realised via position 1 or 2
 - Right-hand end plate with threaded connections: 12 and 14 must be supplied with the same pressure level

Valve terminals type 44/45, VTSA/VTSA-F, NPT

Technical data – Valve terminal – ISO 15407-2, width 18 and 26 mm; ISO 5599-2, width 42 and 52 mm

Valve switching times																		
Valve function order code ¹⁾	VC	VV	N	K	H	P	Q	R	M	O	J	D	B	G	E	SA	SB	
Width 18 mm, nominal operating voltage 24 V DC/110 V AC																		
Switching times [ms]	On	12	12	12	12	12	25	25	25	22	12	–	–	15	15	15	–	–
	Off	30	30	30	30	30	12	12	12	28	38	–	–	44	44	44	–	–
	Change-over	–	–	–	–	–	–	–	–	–	–	11	13	–	–	–	–	–
Width 26 mm, nominal operating voltage 24 V DC/110 V AC																		
Switching times [ms]	On	20	20	20	20	20	32	32	32	25	20	–	–	22	22	22	9/22	9/19
	Off	38	38	38	38	38	30	30	30	45	65	–	–	65	65	65	49	36
	Change-over	–	–	–	–	–	–	–	–	–	–	18	21	–	–	–	33	32
Width 42 mm, nominal operating voltage 24 V DC																		
Switching times [ms]	On	20	20	20	20	20	34	34	34	27	22	–	–	22	22	22	–	–
	Off	38	38	38	38	38	28	28	28	45	60	–	–	65	65	65	–	–
	Change-over	–	–	–	–	–	–	–	–	–	–	16	19	–	–	–	–	–
Width 42 mm, nominal operating voltage 110 V AC																		
Switching times [ms]	On	22	22	22	22	22	34	34	34	20	20	–	–	22	22	22	–	–
	Off	46	46	46	46	46	38	38	38	55	55	–	–	68	68	68	–	–
	Change-over	–	–	–	–	–	–	–	–	–	–	16	19	–	–	–	–	–
Width 52 mm, nominal operating voltage 24 V DC with holding current reduction																		
Switching times [ms]	On	14	–	20	20	20	30	30	30	40	20	–	–	23	23	23	–	–
	Off	35	–	35	35	35	30	30	30	45	60	–	–	60	60	60	–	–
	Change-over	–	–	–	–	–	–	–	–	–	–	18	18	–	–	–	–	–
Width 52 mm, nominal operating voltage 110 V AC																		
Switching times [ms]	On	35	–	35	35	35	50	50	50	70	25	–	–	30	30	30	–	–
	Off	70	–	70	70	70	65	65	65	90	110	–	–	100	100	100	–	–
	Change-over	–	–	–	–	–	–	–	–	–	–	35	42	–	–	–	–	–

1) Valve code SA, switching time 22 ms for control side 12, 9 ms for control side 14
 Valve code SB, switching time 19 ms for control side 12, 9 ms for control side 14

Valve terminals type 44/45, VTSA/VTSA-F, NPT

FESTO

Technical data – Valve terminal – ISO 15407-2, width 18 and 26 mm; ISO 5599-2, width 42 and 52 mm

Electrical data – Maximum current consumption per solenoid coil			
Width	52 mm		
At nominal voltage (valves with holding current reduction)			
	2x 2/2-way and 2x 3/2-way valve	5/2-way, 5/3-way valve	
Nominal pick-up current	[mA]	165	165
Nominal current following current reduction	[mA]	35	35
Time until current reduction	[ms]	30	30

Electrical data – Individual electrical connection				
Width	18 mm	26 mm	42 mm	52 mm
Load voltage supply for valves (U_{val})				
Operating voltage	[V DC]	24 ±10%		
Max. residual current at 24 V DC	[A]	10		
Duty cycle		100%		
Protection class to EN 60529		IP65 and NEMA 4 (for all types of signal transmission in assembled state)		
Coil characteristics at 24 V DC				
2/2-way and 3/2-way valve	[W]	1.3		4.6
5/2-way valve (code D)	[W]	1.3		4.6
5/2-way, 5/3-way valve	[W]	1.6		4.6

Electrical data – Multi-pin plug connection				
Width	18 mm	26 mm	42 mm	52 mm
Load voltage supply for valves (U_{val})				
Operating voltage	[V DC]	24 ±10%		
	[V AC]	110 ±10% (50 ... 60 Hz)		
Max. residual current	[A]	6		
Acceptable current load at 40 °C	[A]	1		
Surge capacity	[kV]	1.5		
Degree of contamination		3		
Duty cycle		100%		
Protection class to EN 60529		IP65 and NEMA 4 (for all types of signal transmission in assembled state)		
Coil characteristics at 24 V DC				
2/2-way and 3/2-way valve	[W]	1.3		4.6
5/2-way valve (code D)	[W]	1.3		4.6
5/2-way, 5/3-way valve	[W]	1.6		4.6
Coil characteristics at 110 V AC				
2/2-way and 3/2-way valve	[VA]	1		
5/2-way, 5/3-way valve	[VA]	1.6		

Valve terminals type 44/45, VTSA/VTSA-F, NPT

FESTO

Technical data – Valve terminal – ISO 15407-2, width 18 and 26 mm; ISO 5599-2, width 42 and 52 mm

Electrical data – With CPX terminal				
Width	18 mm	26 mm	42 mm	52 mm
Power supply for electronics ($U_{EL/SEN}$)				
Operating voltage	[V DC]	24 ±10%		
Max. intrinsic current consumption at 24 V DC	[mA]	20		
Duty cycle		100%		
Load voltage supply for valves (U_{val})				
Operating voltage	[V DC]	24 ±10%		
Diagnostic message undervoltage U_{OFF} , load voltage outside function range	[V]	21.6 ... 21.5		
Protection class to EN 60529		IP65 and NEMA 4 (for all types of signal transmission in assembled state)		
Coil characteristics at 24 V DC				
2/2-way and 3/2-way valve	[W]	1.3		4.6
5/2-way valve (code D)	[W]	1.3		4.6
5/2-way, 5/3-way valve	[W]	1.6		4.6

Valve terminals type 44/45, VTSA/VTSA-F, NPT

FESTO

Technical data – Valve terminal – ISO 15407-2, width 18 and 26 mm; ISO 5599-2, width 42 and 52 mm

ATEX		VTSA-MP	VTSA-FB	VTSA-ASI
Connection variant ¹⁾				
ATEX category for gas		II 3G		
Explosion ignition protection type for gas		Ex nA II T3 X		
ATEX category for dust		II 3D		
Explosion ignition protection type for dust		Ex tD A22 IP65 T125° C X		
ATEX temperature rating	[°C]	-5 ≤ Ta ≤ +50		
CE marking (see declaration of conformity) ²⁾		To EU EMC Directive		

1) This product is certified for use in the ATEX zone in accordance with the EU ATEX Directive
The certification is valid for: VTSA-MP, VTSA-FB and VTSA-ASI

2) Multi-pin plug variant 1 (24 V DC): no
Multi-pin plug variant 2A (110 V): to EU Low Voltage Directive
CPX variant: to EU EMC Directive

Materials				
Width	18 mm	26 mm	42 mm	52 mm
Manifold sub-base	Die-cast aluminium			
Valve	Die-cast aluminium, reinforced polyamide			
Seals	Nitrile rubber, elastomer (support made of steel)			
Supply plate	Die-cast aluminium			
Right-hand end plate	Die-cast aluminium			
Pneumatic interface for CPX	Die-cast aluminium			
Flow control plate	Die-cast aluminium			
Pressure regulator plate	Die-cast aluminium, reinforced polyamide			
Multi-pin connection block	Die-cast aluminium			
Cover for the pneumatic interface and multi-pin plug connection	Wellamid, reinforced polyamide			
RoHS status	RoHS-compliant			

Valve terminals type 44/45, VTSA/VTSA-F, NPT

FESTO

Technical data – Valve terminal – ISO 15407-2, width 18 and 26 mm; ISO 5599-2, width 42 and 52 mm

Product weight				
Approx. weight	[g]			
Width	18 mm	26 mm	42 mm	52 mm
Sub-D multi-pin interface module or terminal strip ¹⁾	550			
Multi-pin node with M12 individual connection	760			
Interface module CPX ¹⁾	1,470			
Electrical connection for AS-interface	300			
AS-interface module	850			
Supply plate ²⁾				
• Exhaust plate with 3 and 5 common	617			
• Exhaust port cover with 3 and 5 separated	597			
Right-hand end plate ³⁾				
– Axial	339			336
– Selector	281			–
Manifold sub-base ⁴⁾	447	634	340	815
90° connection plate ³⁾	170	230	176	359
Pressure regulator plate				
for port 1	350	402	640	1,190
for port 4 or 2	367	448	640	1,230
for ports 4 and 2	611	692	920	1,990
Flow control plate	228	320	220	565
Vertical supply plate ³⁾	140	191	340	605
Vertical pressure shut-off plate	209	273	600	1,030
Valves				
– 5/3-way valve (code: B, G, E)	191	320	456	780
– 5/3-way valve (code: SA, SB)	–	301	–	–
– 5/2-way valve, single solenoid (code: M, O)	163	293	426	702
– 5/2-way valve, double solenoid (code: J, D)	172	276	439	732
– 2x 3/2-way valve (code: N, K, H, P, Q, R)	190	335	442	740
– 2x 2/2-way valve (code: VC, VV)	190	335	442	740
Blanking plate	34	73	68	146

1) With sheet metal seal, printed circuit board

2) With sheet metal seal and electrical interlinking module

3) With screws

4) With sheet metal seal, electrical interlinking module, inscription label holder, 4 screws

Valve terminals type 44/45, VTSA/VTSA-F, NPT

Technical data – Valve terminal – ISO 15407-2, width 18 and 26 mm; ISO 5599-2, width 42 and 52 mm

Flow rate q_n as a function of output pressure p_2 with pressure regulator plates (P regulator plate) for port 1

6 bar

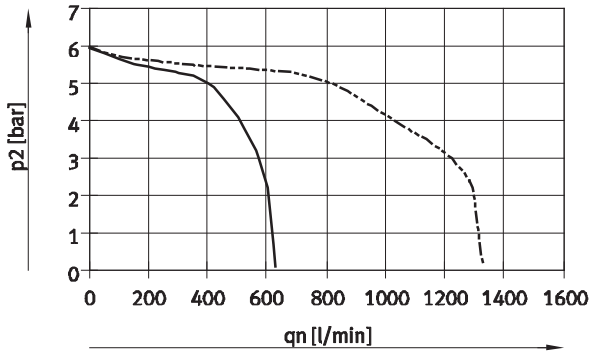

— Width 18 mm
 - - - Width 26 mm

10 bar

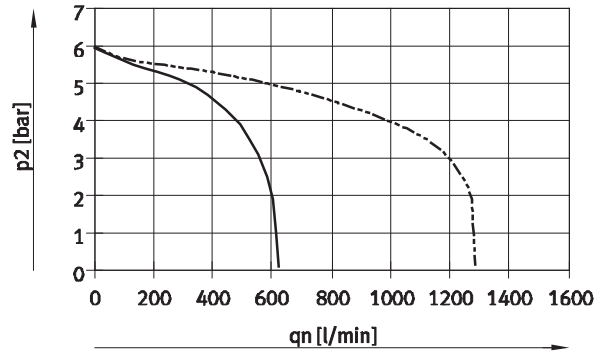

— Width 18 mm
 - - - Width 26 mm

Flow rate q_n as a function of output pressure p_2 with pressure regulator plates (P regulator plate) for port 1

Supply pressure 10 bar, set control pressure 6 bar

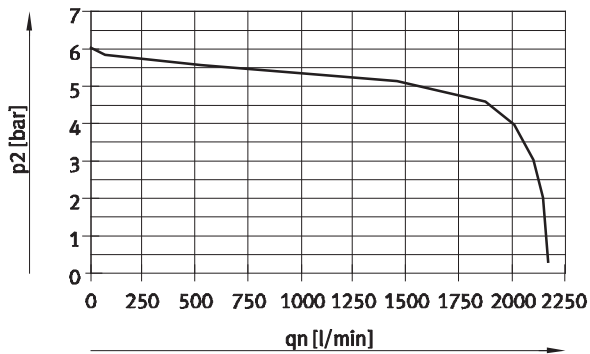

Width 42 mm (ISO 1)

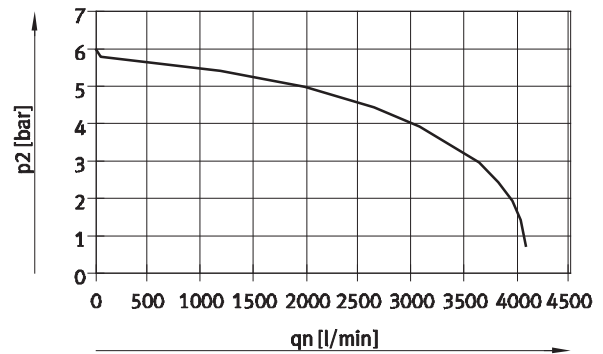

Width 52 mm (ISO 2)

Valve terminals type 44/45, VTSA/VTSA-F, NPT

Technical data – Valve terminal – ISO 15407-2, width 18 and 26 mm; ISO 5599-2, width 42 and 52 mm

Flow rate q_n as a function of output pressure p_2 with pressure regulator plates (AB regulator plates) for port 2, 4 or ports 4/2

6 bar

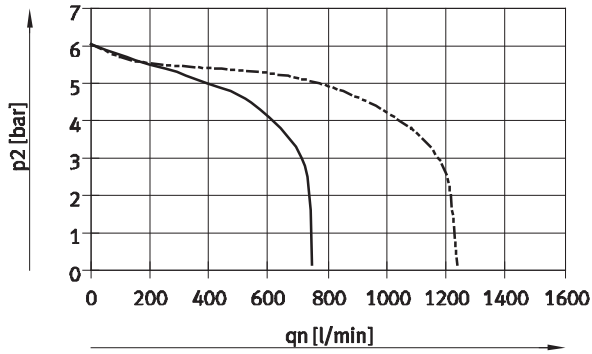

— Width 18 mm
- - - Width 26 mm

10 bar

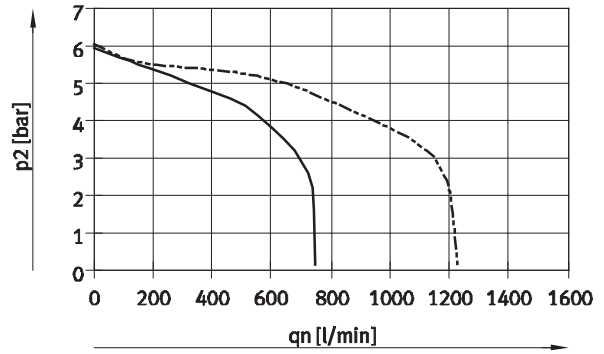

— Width 18 mm
- - - Width 26 mm

Flow rate q_n as a function of output pressure p_2 with pressure regulator plates (AB regulator plates) for port 2, 4 or ports 4/2

Supply pressure 10 bar, set controller pressure 6 bar

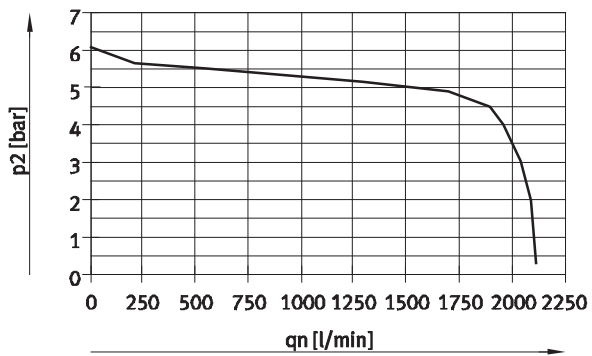

Width 42 mm (ISO 1)

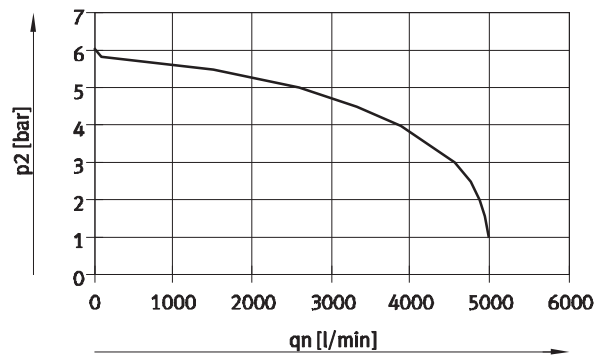

Width 52 mm (ISO 2)

Valve terminals type 44/45, VTSA/VTSA-F, NPT

Technical data – Valve terminal – ISO 15407-2, width 18 and 26 mm; ISO 5599-2, width 42 and 52 mm

Flow rate q_n as a function of output pressure p_2 with pressure regulator plates (AB regulator plates, rev.) for ports 4/2, reversible

6 bar

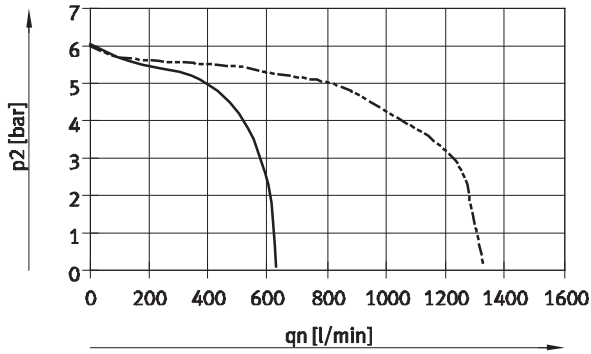

— Width 18 mm
- - - Width 26 mm

10 bar

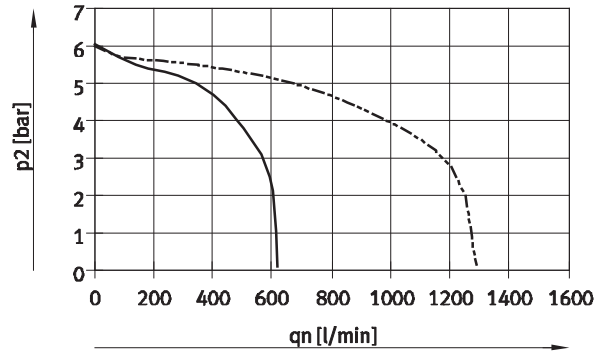

— Width 18 mm
- - - Width 26 mm

Flow rate q_n as a function of output pressure p_2 with pressure regulator plates (AB regulator plates, rev.) for ports 4/2, reversible

Supply pressure 10 bar, set controller pressure 6 bar

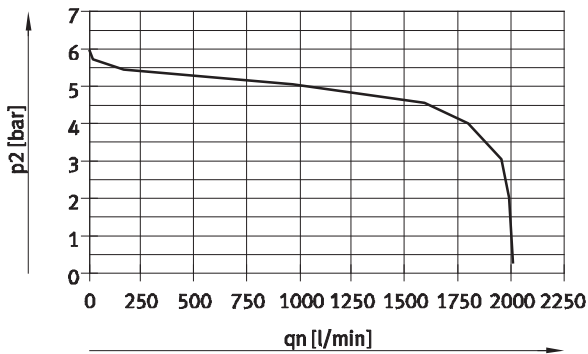

Width 42 mm (ISO 1)

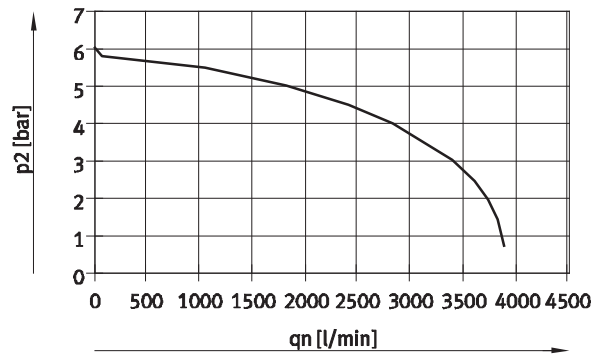

Width 52 mm (ISO 2)

Valve terminals type 44/45, VTSA/VTSA-F, NPT

Technical data – Valve terminal – ISO 15407-2, width 18 and 26 mm; ISO 5599-2, width 42 and 52 mm

Flow rate q_n as a function of flow control

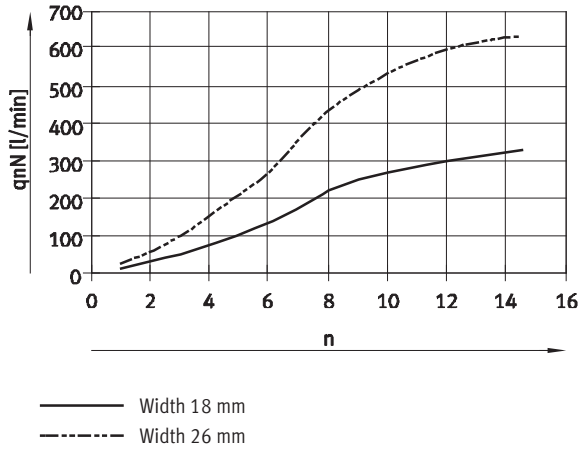

Flow rate q_n as a function of flow control

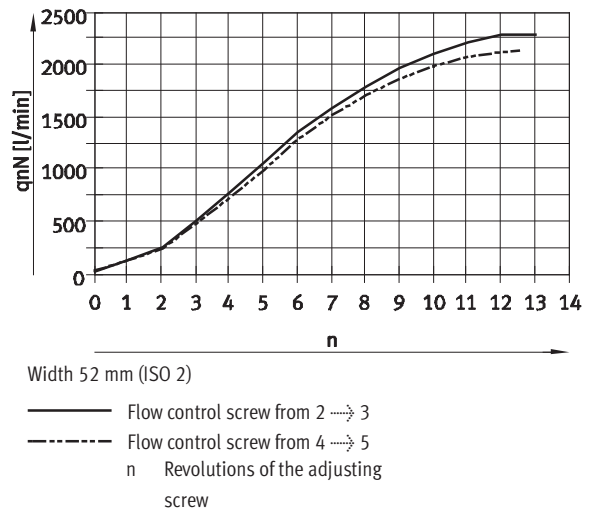
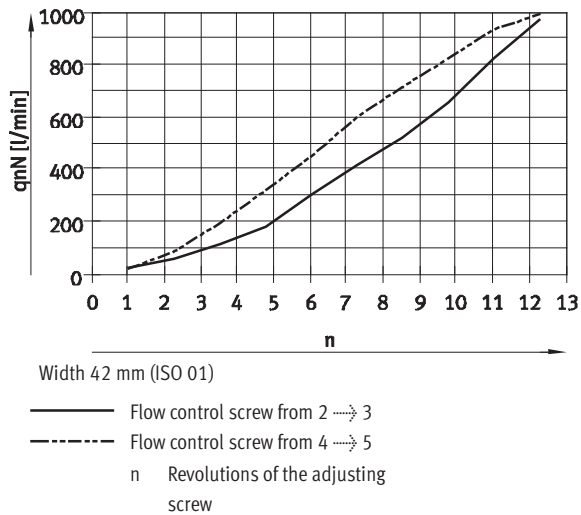

Valve terminals type 44/45, VTSA/VTSA-F, NPT

Technical data – Valve terminal – ISO 15407-2, width 18 and 26 mm; ISO 5599-2, width 42 and 52 mm

Dimensions

Download CAD data → www.festo.com

Valve terminal with individual electrical connection

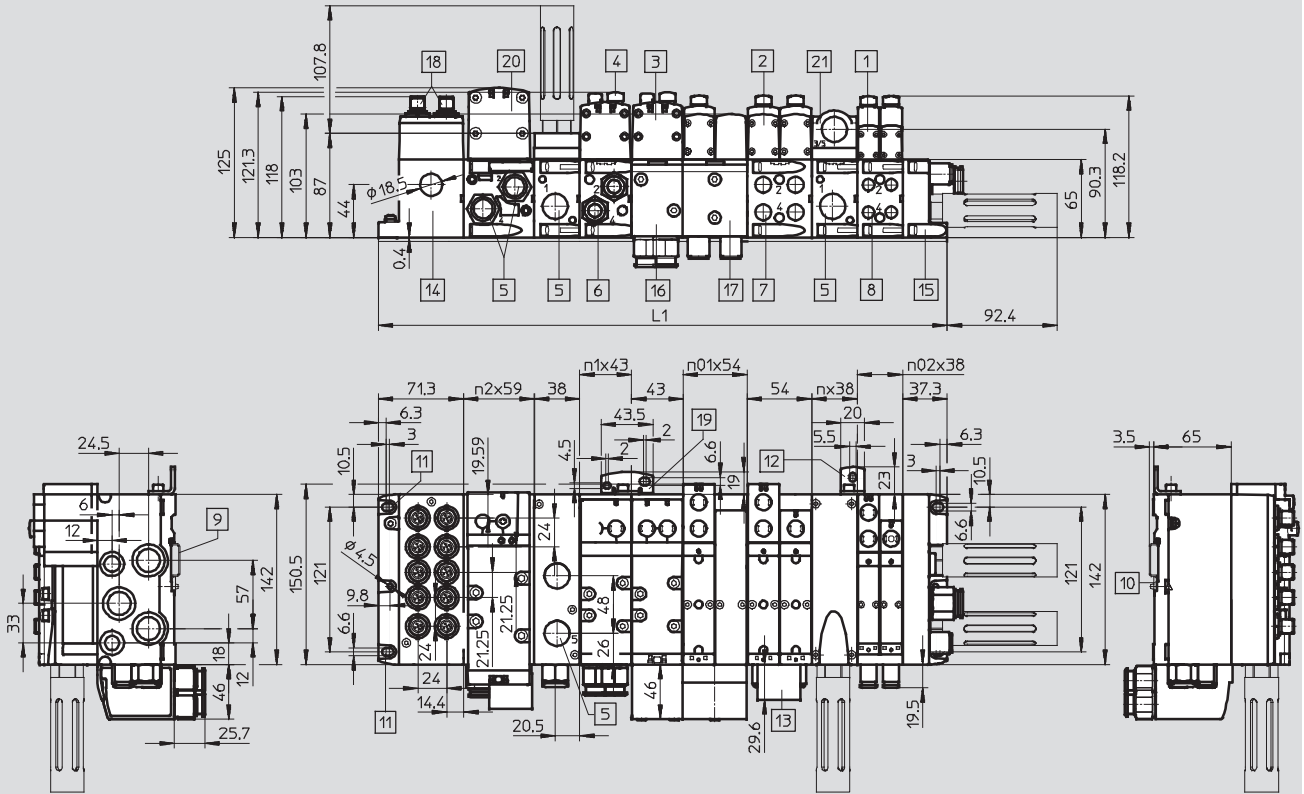

- | | | | |
|--------------------------------|--------------------------------|---|---|
| 1 Solenoid valve, width 18 mm | 7 Threaded connection 1/4" NPT | 16 90° connection plate 43 mm, 3/8" NPT | n02 Number of manifold sub-bases 38 mm |
| 2 Solenoid valve, width 26 mm | 8 Threaded connection 1/8" NPT | 17 90° connection plate 54 mm, 1/2" NPT | n01 Number of manifold sub-bases 54 mm |
| 3 Solenoid valve, width 42 mm | 9 H-rail | 18 M12 plug, 5-pin (6-way or 10-way) | n1 Number of manifold sub-bases 43 mm |
| 4 Cover cap/manual override | 10 H-rail mounting | 19 Additional mounting bracket | n2 Number of manifold sub-bases 59 mm |
| 5 Threaded connection 1/2" NPT | 11 Mounting hole | 20 Solenoid valve, width 52 mm | n Number of supply plates (only with end plate with pilot air selector) |
| 6 Threaded connection 3/8" NPT | 12 Additional mounting bracket | 21 Supply plate | |
| | 13 Inscription label holder | | |
| | 14 Individual connection | | |
| | 15 End plate | | |

Width	L1
18 mm	$71.3 + n02 \times 38 + n \times 38 + 37.3$
26 mm	$71.3 + n01 \times 54 + n \times 38 + 37.3$
42 mm	$71.3 + n1 \times 43 + n \times 38 + 37.3$
52 mm	$71.3 + n2 \times 59 + n \times 38 + 37.3$
Mixture of 18 mm, 26 mm, 42 mm and 52 mm	$71.3 + n02 \times 38 + n01 \times 54 + n1 \times 43 + n2 \times 59 + n \times 38 + 37.3$

• Note: This product conforms to ISO 1179-1 and to ISO 228-1

Valve terminals type 44/45, VTSA/VTSA-F, NPT

Technical data – Valve terminal – ISO 15407-2, width 18 and 26 mm; ISO 5599-2, width 42 and 52 mm

Dimensions

Download CAD data → www.festo.com

Valve terminal with multi-pin plug connection

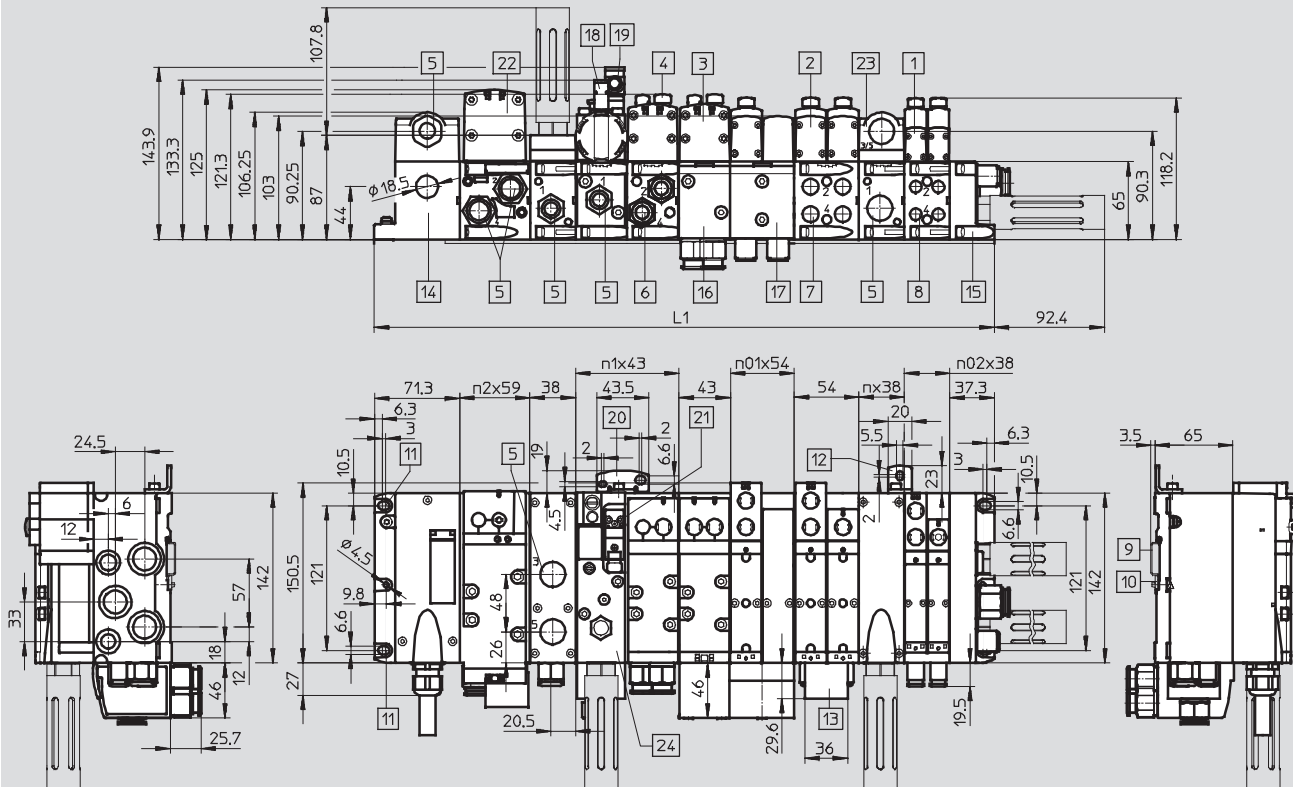

- | | | | |
|--------------------------------|---|---|---|
| 1 Solenoid valve, width 18 mm | 9 H-rail | 17 90° connection plate 54 mm, 1/2" NPT | n02 Number of manifold sub-bases 38 mm |
| 2 Solenoid valve, width 26 mm | 10 H-rail mounting | 18 Proximity sensor M12x1 | n01 Number of manifold sub-bases 54 mm |
| 3 Solenoid valve, width 42 mm | 11 Mounting hole | 19 Plug socket M12x1 | n1 Number of manifold sub-bases 43 mm |
| 4 Cover cap/manual override | 12 Additional mounting bracket | 20 Additional mounting | n2 Number of manifold sub-bases 59 mm |
| 5 Threaded connection 1/2" NPT | 13 Inscription label holder | 21 Electrical connection to DIN EN 175301-803, type C | n Number of supply plates (only with end plate with pilot air selector) |
| 6 Threaded connection 3/8" NPT | 14 Multi-pin plug connection | 22 Solenoid valve, width 52 mm | |
| 7 Threaded connection 1/4" NPT | 15 End plate | 23 Supply plate | |
| 8 Threaded connection 1/8" NPT | 16 90° connection plate 43 mm, 3/8" NPT | 24 Soft-start valve | |

Width	L1
18 mm	71.3 + n02 x 38 + n x 38 + 37.3
26 mm	71.3 + n01 x 54 + n x 38 + 37.3
42 mm	71.3 + n1 x 43 + n x 38 + 37.3
52 mm	71.3 + n2 x 59 + n x 38 + 37.3
Mixture of 18 mm, 26 mm, 42 mm and 52 mm	71.3 + n02 x 38 + n01 x 54 + n1 x 43 + n2 x 59 + n x 38 + 37.3

Note: This product conforms to ISO 1179-1 and to ISO 228-1

Valve terminals type 44/45, VTSA/VTSA-F, NPT

FESTO

Technical data – Valve terminal – ISO 15407-2, width 18 and 26 mm; ISO 5599-2, width 42 and 52 mm

Dimensions

Download CAD data → www.festo.com

Multi-pin, terminal strip (Cage Clamp®)

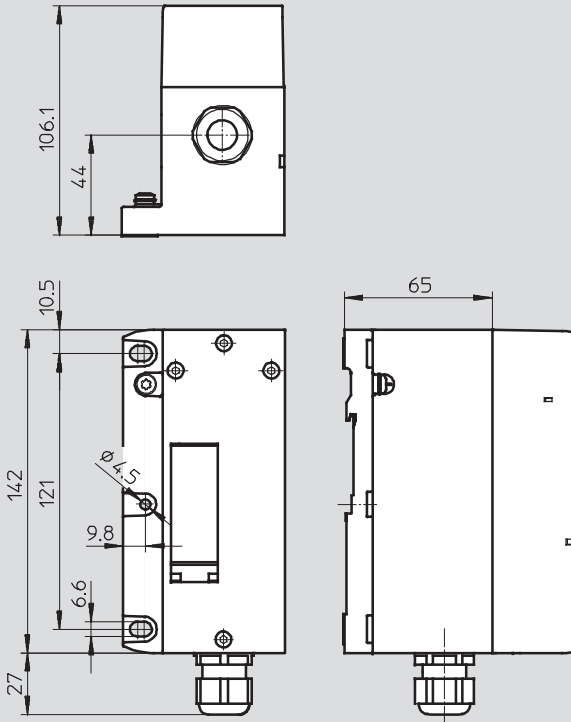

Multi-pin, round plug connector

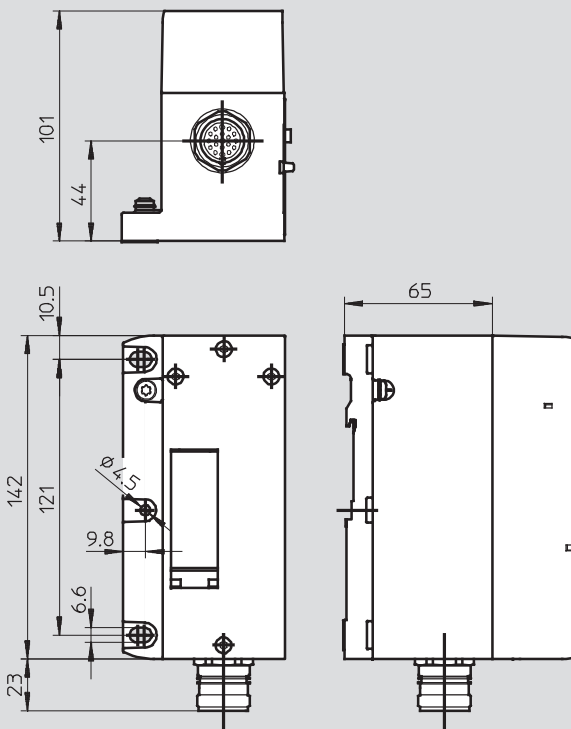

Valve terminals type 44/45, VTSA/VTSA-F, NPT

Technical data – Valve terminal – ISO 15407-2, width 18 and 26 mm; ISO 5599-2, width 42 and 52 mm

Dimensions

Download CAD data → www.festo.com

Valve terminal with AS-interface connection

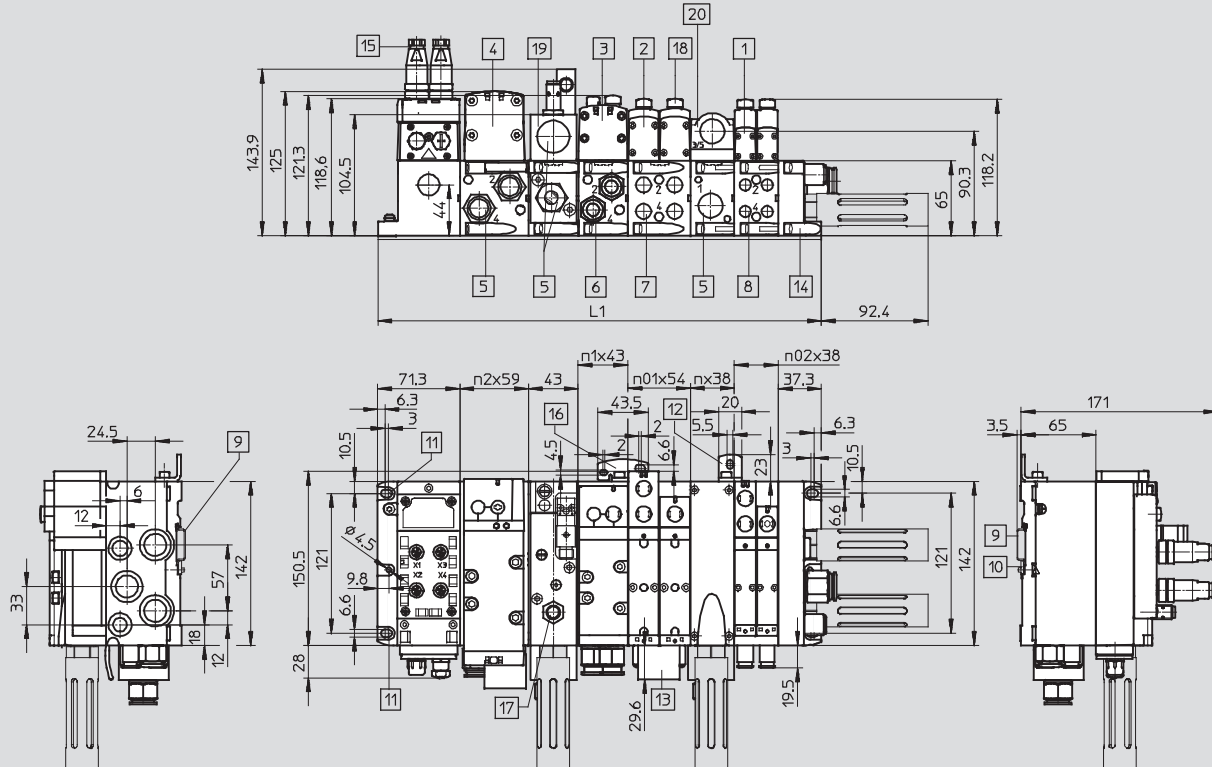

- | | | | |
|--------------------------------|--------------------------------|----------------------------------|--|
| 1 Solenoid valve, width 18 mm | 9 H-rail | 16 Additional mounting | n02 Number of manifold sub-bases 38 mm |
| 2 Solenoid valve, width 26 mm | 10 H-rail mounting | 17 Proximity sensor M12x1 | n01 Number of manifold sub-bases 54 mm |
| 3 Solenoid valve, width 42 mm | 11 Mounting hole | 18 Cover cap/manual override | n1 Number of manifold sub-bases 43 mm |
| 4 Solenoid valve, width 52 mm | 12 Additional mounting bracket | 19 Soft-start valve, width 43 mm | n2 Number of manifold sub-bases 59 mm |
| 5 Threaded connection 1/2" NPT | 13 Inscription label | 20 Supply plate | n Number of supply plates |
| 6 Threaded connection 3/8" NPT | 14 End plate | | |
| 7 Threaded connection 1/4" NPT | 15 Plug M12 | | |
| 8 Threaded connection 1/8" NPT | | | |

Width	L1
18 mm	$71.3 + n02 \times 38 + n \times 38 + 37.3$
26 mm	$71.3 + n01 \times 54 + n \times 38 + 37.3$
42 mm	$71.3 + n1 \times 43 + n \times 38 + 37.3$
52 mm	$71.3 + n2 \times 59 + n \times 38 + 37.3$
Mixture of 18 mm, 26 mm, 42 mm and 52 mm	$71.3 + n02 \times 38 + n01 \times 54 + n1 \times 43 + n2 \times 59 + n \times 38 + 37.3$

Valve terminals type 44/45, VTSA/VTSA-F, NPT

Technical data – Valve terminal – ISO 15407-2, width 18 and 26 mm; ISO 5599-2, width 42 and 52 mm

Dimensions Download CAD data → www.festo.com

Valve terminal with fieldbus connection

1 Solenoid valve, width 18 mm
 2 Solenoid valve, width 26 mm
 3 Solenoid valve, width 42 mm
 4 Cover cap/manual override
 5 Threaded connection 1/2" NPT
 6 Threaded connection 3/8" NPT
 7 Threaded connection 1/4" NPT
 8 Threaded connection 1/8" NPT
 9 H-rail
 10 H-rail mounting
 11 Mounting hole
 12 Additional mounting bracket
 13 Inscription label holder
 14 Pneumatic interface CPX
 15 End plate
 16 CPX module/fieldbus node
 17 90° connection plate 43 mm, 3/8" NPT
 18 90° connection plate 54 mm, 1/2" NPT
 19 Proximity sensor M12x1
 20 Plug socket M12x1
 21 Electrical connection to DIN EN 175301-803, type C
 22 Additional mounting bracket
 23 Hole for additional mounting, diameter 6.4 2x
 24 Solenoid valve, width 52 mm
 25 Supply plate
 26 Soft-start valve
 n02 Number of manifold sub-bases 38 mm
 n01 Number of manifold sub-bases 54 mm
 n1 Number of manifold sub-bases 43 mm
 n2 Number of manifold sub-bases 59 mm
 n Number of supply plates (only with end plate with pilot air selector)
 m Number of CPX modules

Width	L1
18 mm	$30.4 + m \times 50.1 + 50 + n02 \times 38 + n \times 38 + 37.3$
26 mm	$30.4 + m \times 50.1 + 50 + n01 \times 54 + n \times 38 + 37.3$
42 mm	$30.4 + m \times 50.1 + 50 + n1 \times 43 + n \times 38 + 37.3$
52 mm	$30.4 + m \times 50.1 + 50 + n2 \times 59 + n \times 38 + 37.3$
Mixture of 18 mm, 26 mm, 42 mm and 52 mm	$30.4 + m \times 50.1 + 50 + n02 \times 38 + n01 \times 54 + n1 \times 43 + n2 \times 59 + n \times 38 + 37.3$

• Note: This product conforms to ISO 1179-1 and to ISO 228-1

Valve terminals type 44/45, VTSA/VTSA-F, NPT

Technical data – Valve terminal – ISO 15407-2, width 18 and 26 mm; ISO 5599-2, width 42 and 52 mm

Dimensions

Download CAD data → www.festo.com

Vertical stacking components, width 18 mm

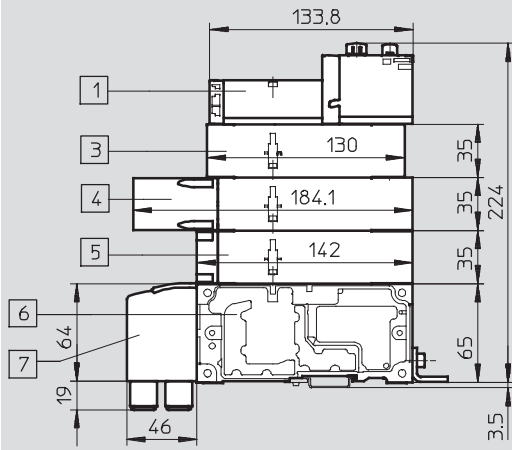

- 1 Solenoid valve with two solenoid coils, width 18 mm
- 3 Flow control plate
- 4 Vertical pressure shut-off plate
- 5 Vertical supply plate
- 6 Manifold sub-base
- 7 90° connection plate

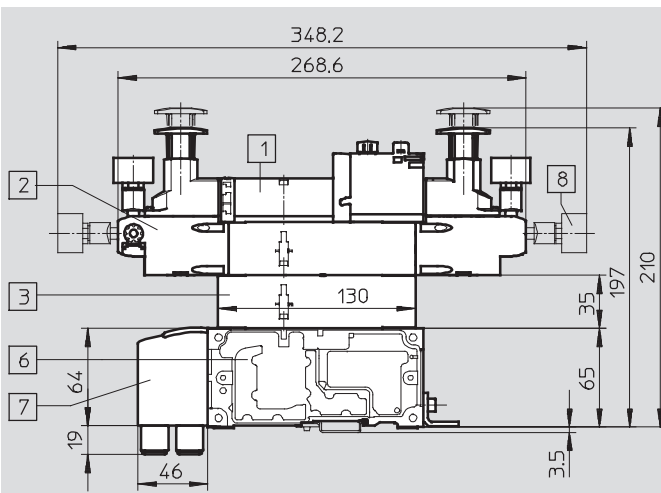

- 1 Solenoid valve with two solenoid coils, width 18 mm
- 2 Pressure regulator plate
- 3 Flow control plate
- 6 Manifold sub-base
- 7 90° connection plate
- 8 Pressure gauge, freely positionable

Vertical stacking components, width 18 mm, with the pressure regulator plate also suitable for symmetrical valves

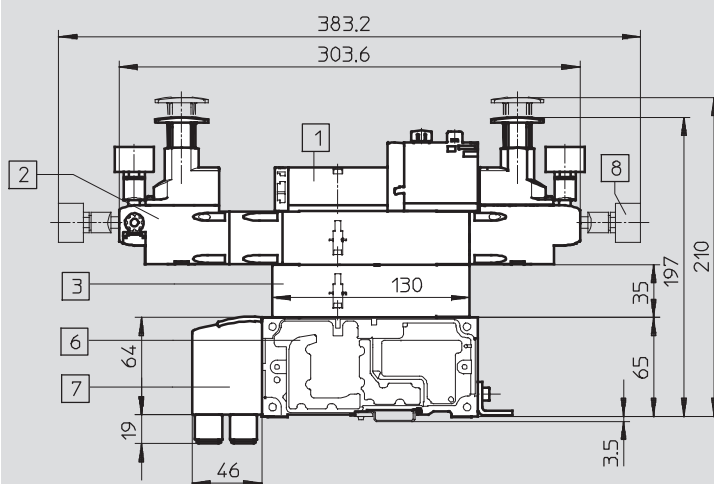

- 1 Solenoid valve with two solenoid coils, width 18 mm
- 2 Pressure regulator plate
- 3 Flow control plate
- 6 Manifold sub-base
- 7 90° connection plate
- 8 Pressure gauge, freely positionable

Valve terminals type 44/45, VTSA/VTSA-F, NPT

Technical data – Valve terminal – ISO 15407-2, width 18 and 26 mm; ISO 5599-2, width 42 and 52 mm

Dimensions

Download CAD data → www.festo.com

Vertical stacking components, width 26 mm

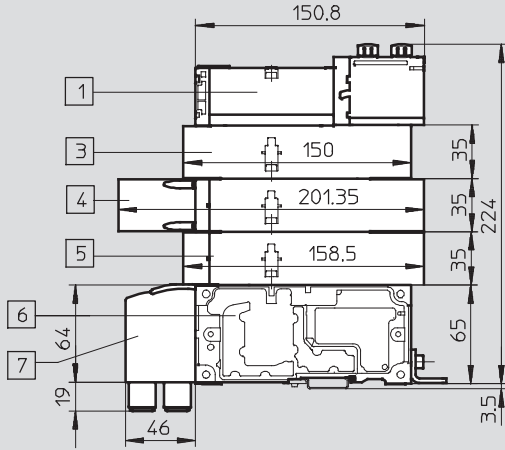

- 1 Solenoid valve with two solenoid coils, width 26 mm
- 3 Flow control plate
- 4 Vertical pressure shut-off plate
- 5 Vertical supply plate
- 6 Manifold sub-base
- 7 90° connection plate

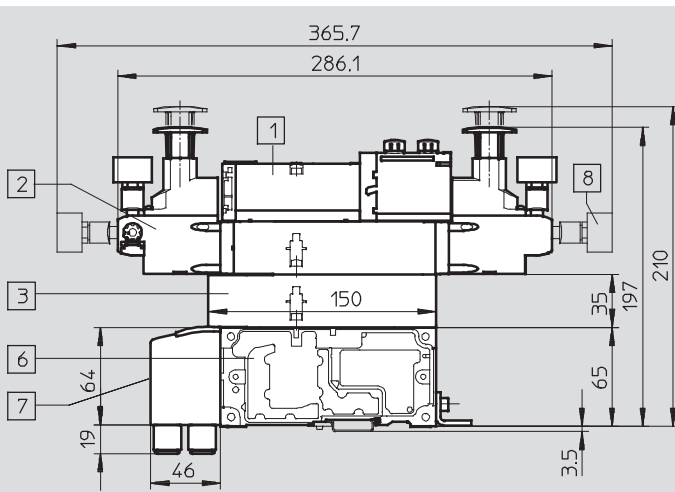

- 1 Solenoid valve with two solenoid coils, width 26 mm
- 2 Pressure regulator plate
- 3 Flow control plate
- 6 Manifold sub-base
- 7 90° connection plate
- 8 Pressure gauge, freely positionable

Vertical stacking components, width 26 mm, with the pressure regulator plate also suitable for symmetrical valves

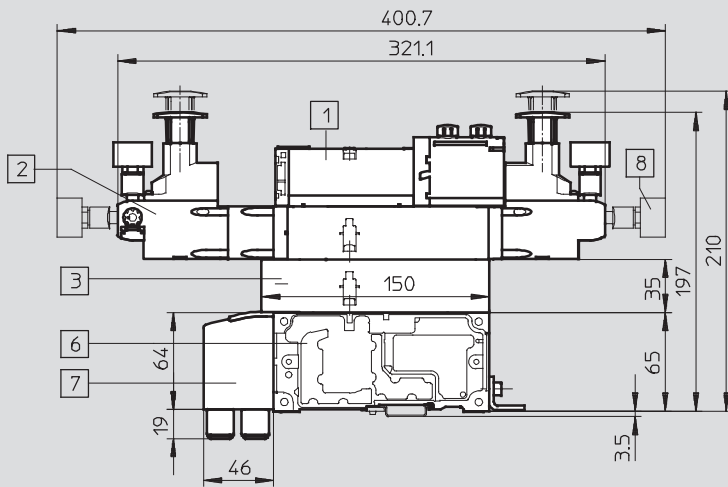

- 1 Solenoid valve with two solenoid coils, width 26 mm
- 2 Pressure regulator plate
- 3 Flow control plate
- 6 Manifold sub-base
- 7 90° connection plate
- 8 Pressure gauge, freely positionable

Valve terminals type 44/45, VTSA/VTSA-F, NPT

Technical data – Valve terminal – ISO 15407-2, width 18 and 26 mm; ISO 5599-2, width 42 and 52 mm

Dimensions

Download CAD data → www.festo.com

Vertical stacking components, width 42 mm

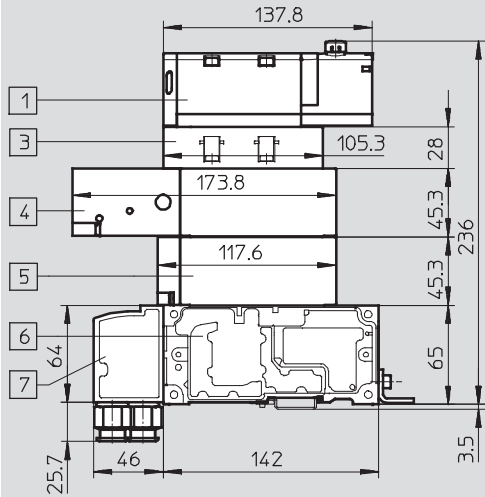

- 1 Solenoid valve
- 3 Flow control plate
- 4 Vertical pressure shut-off plate
- 5 Vertical supply plate
- 6 Manifold sub-base
- 7 90° connection plate

Vertical stacking components, width 42 mm

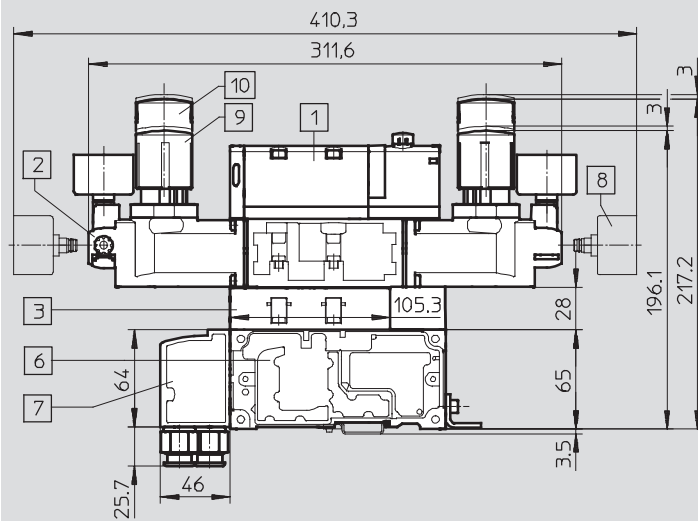

- 1 Solenoid valve
- 2 Pressure regulator plate
- 3 Flow control plate
- 6 Manifold sub-base
- 7 90° connection plate
- 8 Pressure gauge, freely positionable
- 9 Standard rotary knob
- 10 Lockable rotary knob

Note

Pressure regulator plates for symmetrical valves with widths of 42 mm and 52 mm can only be ordered via the pressure regulator configurator VABF-S2.

→ Internet: vabf-s2

Valve terminals type 44/45, VTSA/VTSA-F, NPT

Technical data – Valve terminal – ISO 15407-2, width 18 and 26 mm; ISO 5599-2, width 42 and 52 mm

Dimensions Download CAD data → www.festo.com

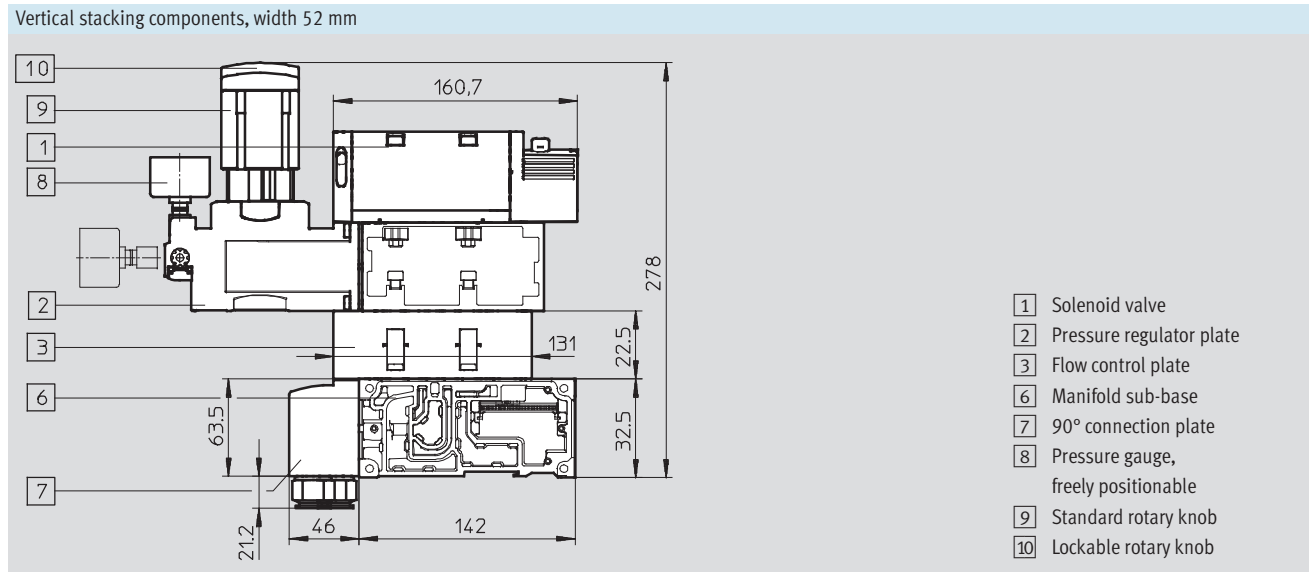
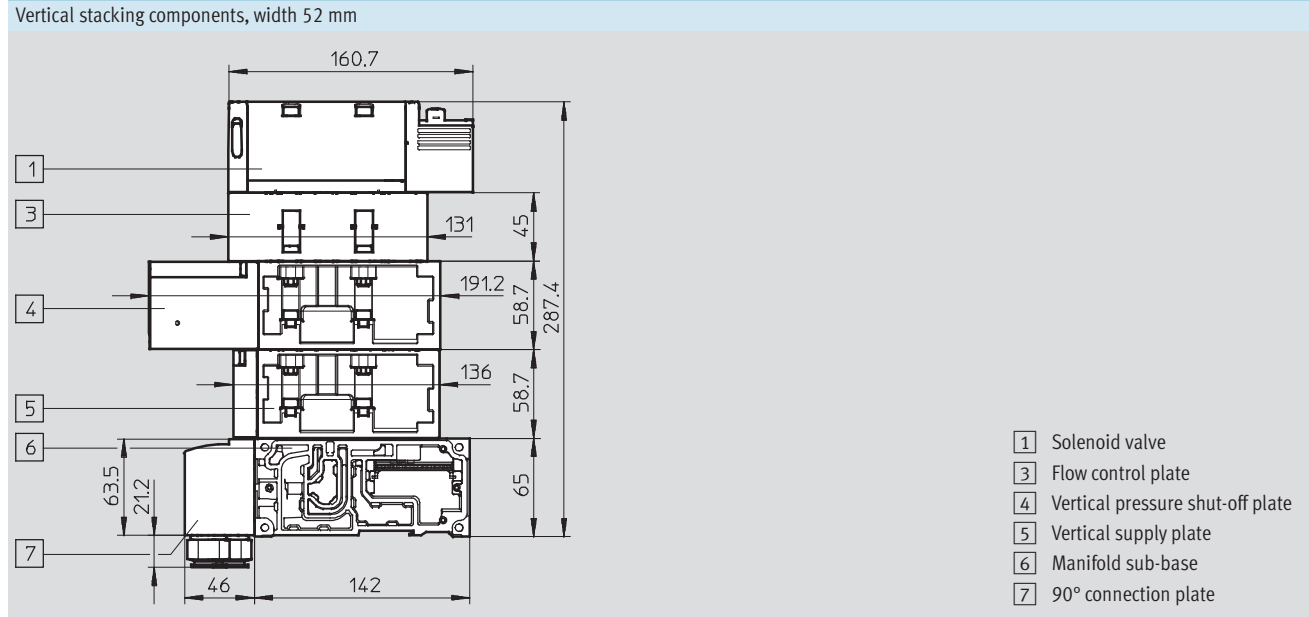

-  - Note
 Pressure regulator plates for symmetrical valves with widths of 42 mm and 52 mm can only be ordered via the pressure regulator configurator VABF-S2. → Internet: vabf-s2

Valve terminals type 44/45, VTSA/VTSA-F, NPT

Technical data – Valve terminal – ISO 15407-2, width 18 and 26 mm; ISO 5599-2, width 42 and 52 mm

Dimensions

Download CAD data → www.festo.com

Supply plate with silencer

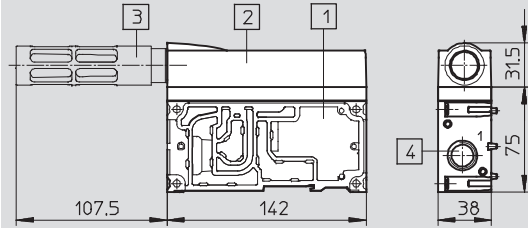

- 1 Supply plate
- 2 Exhaust port cover
- 3 Silencer U-1/2-B-NPT
- 4 Threaded connection 1/2" NPT

Right-hand end plate

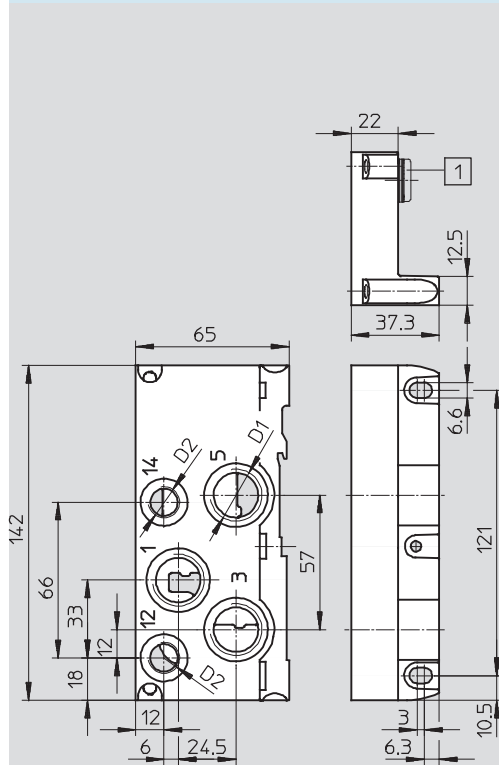

- 1 Blanking plug

Right-hand end plate with pilot air selector

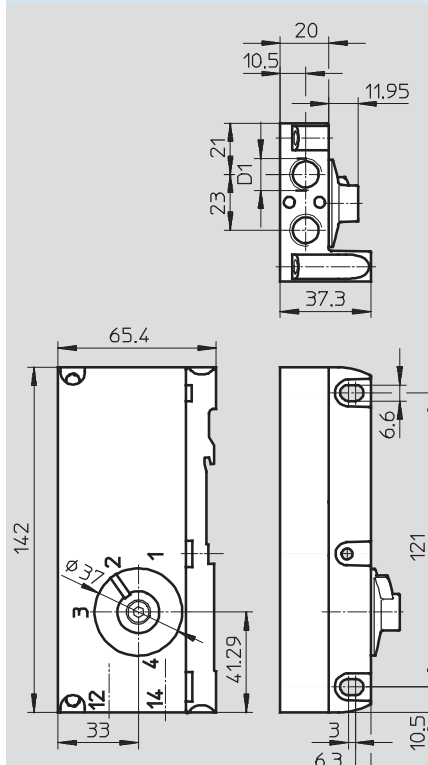

Type	D1	D2	With
VABE-S6-1R-N12	1/2" NPT	1/4" NPT	1
VABE-S6-1RZ-N12	1/2" NPT	1/4" NPT	-

Type	D1
VABE-S6-1RZ-N-B1	1/4" NPT

• Note: This product conforms to ISO 1179-1 and to ISO 228-1

Valve terminals type 44/45, VTSA/VTSA-F, NPT

Technical data – Valve terminal – ISO 15407-2, width 18 and 26 mm; ISO 5599-2, width 42 and 52 mm

Right-hand end plate

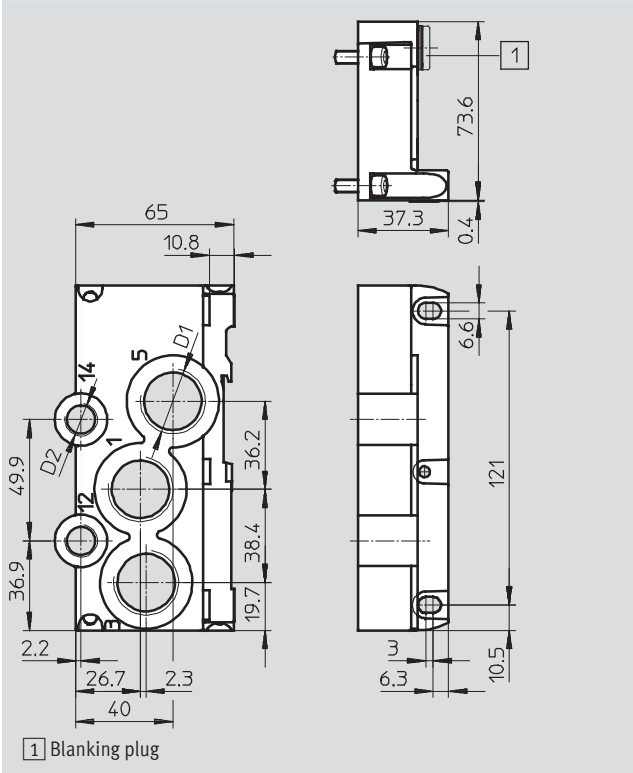

Type	D1	D2	With
VABE-S6-2R-N34	3/4" NPT	1/4" NPT	1
VABE-S6-2RZ-N34	3/4" NPT	1/4" NPT	

- Note: This product conforms to ISO 1179-1 and to ISO 228-1

Valve terminals type 44/45, VTSA/VTSA-F, NPT

FESTO

Ordering data – Individual valve 24 V DC – ISO 15407-2, width 18 and 26 mm; ISO 5599-2, width 42 and 52 mm

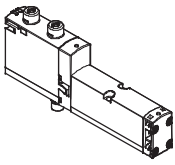
Ordering data				
	Code	Valve function	Width	Part No. Type
Solenoid valves, 24 V DC				
	VC	2x 2/2-way valve, single solenoid, normally closed, pneumatic spring return	18 mm	561155 VSVA-B-T22C-AZD-A2-1T1L
	VV	2x 2/2-way valve, single solenoid, normally closed, pneumatic spring return, vacuum operation possible at 3 and 5	18 mm	561159 VSVA-B-T22CV-AZD-A2-1T1L
	N	2x 3/2-way valve, single solenoid, normally open	18 mm	539178 VSVA-B-T32U-AZD-A2-1T1L
	K	2x 3/2-way valve, single solenoid, normally closed	18 mm	539176 VSVA-B-T32C-AZD-A2-1T1L
	H	2x 3/2-way valve, single solenoid, 1x normally open, 1x normally closed	18 mm	539180 VSVA-B-T32H-AZD-A2-1T1L
	P	2x 3/2-way valve, single solenoid, reverse operation, normally open	18 mm	539179 VSVA-B-T32F-AZD-A2-1T1L
	Q	2x 3/2-way valve, single solenoid, reverse operation, normally closed	18 mm	539177 VSVA-B-T32N-AZD-A2-1T1L
	R	2x 3/2-way valve, single solenoid, reverse operation, 1x normally open, 1x normally closed	18 mm	539181 VSVA-B-T32W-AZD-A2-1T1L
	M	5/2-way valve, single solenoid, pneumatic spring return	18 mm	539184 VSVA-B-M52-AZD-A2-1T1L
	O	5/2-way valve, single solenoid, mechanical spring return	18 mm	539185 VSVA-B-M52-MZD-A2-1T1L
	J	5/2-way valve, double solenoid	18 mm	539182 VSVA-B-B52-ZD-A2-1T1L
	D	5/2-way valve, double solenoid, with dominant signal	18 mm	539183 VSVA-B-D52-ZD-A2-1T1L
	B	5/3-way valve, mid-position pressurised	18 mm	539186 VSVA-B-P53U-ZD-A2-1T1L
	G	5/3-way valve, mid-position closed	18 mm	539188 VSVA-B-P53C-ZD-A2-1T1L
	E	5/3-way valve, mid-position exhausted	18 mm	539187 VSVA-B-P53E-ZD-A2-1T1L

Valve terminals type 44/45, VTSA/VTSA-F, NPT

FESTO

Ordering data – Individual valve 24 V DC – ISO 15407-2, width 18 and 26 mm; ISO 5599-2, width 42 and 52 mm

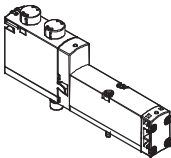
Ordering data					
	Code	Valve function	Width	Part No.	Type
Solenoid valves, 24 V DC					
	VC	2x 2/2-way valve, single solenoid, normally closed, pneumatic spring return	26 mm	561149	VSVA-B-T22C-AZD-A1-1T1L
	VV	2x 2/2-way valve, single solenoid, normally closed, pneumatic spring return, vacuum operation possible at 3 and 5	26 mm	561153	VSVA-B-T22CV-AZD-A1-1T1L
	N	2x 3/2-way valve, single solenoid, normally open	26 mm	539152	VSVA-B-T32U-AZD-A1-1T1L
	K	2x 3/2-way valve, single solenoid, normally closed	26 mm	539150	VSVA-B-T32C-AZD-A1-1T1L
	H	2x 3/2-way valve, single solenoid, 1x normally open, 1x normally closed	26 mm	539154	VSVA-B-T32H-AZD-A1-1T1L
	P	2x 3/2-way valve, single solenoid, reverse operation, normally open	26 mm	539153	VSVA-B-T32F-AZD-A1-1T1L
	Q	2x 3/2-way valve, single solenoid, reverse operation, normally closed	26 mm	539151	VSVA-B-T32N-AZD-A1-1T1L
	R	2x 3/2-way valve, single solenoid, reverse operation, 1x normally open, 1x normally closed	26 mm	539155	VSVA-B-T32W-AZD-A1-1T1L
	M	5/2-way valve, single solenoid, pneumatic spring return	26 mm	539158	VSVA-B-M52-AZD-A1-1T1L
	O	5/2-way valve, single solenoid, mechanical spring return	26 mm	539159	VSVA-B-M52-MZD-A1-1T1L
	J	5/2-way valve, double solenoid	26 mm	539156	VSVA-B-B52-ZD-A1-1T1L
	D	5/2-way valve, double solenoid, with dominant signal	26 mm	539157	VSVA-B-D52-ZD-A1-1T1L
	B	5/3-way valve, mid-position pressurised	26 mm	539160	VSVA-B-P53U-ZD-A1-1T1L
	G	5/3-way valve, mid-position closed	26 mm	539162	VSVA-B-P53C-ZD-A1-1T1L
	E	5/3-way valve, mid-position exhausted	26 mm	539161	VSVA-B-P53E-ZD-A1-1T1L
	SA	5/3-way valve, mid-position exhausted, switching position 14 detenting, mechanical spring return	26 mm	560727	VSVA-B-P53ED-ZD-A1-1T1L
SB	5/3-way valve, mid-position 1x exhausted from 4 to 5, 1x pressurised from 1 to 2, switching position 14 detenting, same function in both switching positions: pressurised from 1 to 4 and exhausted from 2 to 3, mechanical spring return	26 mm	560728	VSVA-B-P53AD-ZD-A1-1T1L	

Valve terminals type 44/45, VTSA/VTSA-F, NPT

FESTO

Ordering data – Individual valve 24 V DC – ISO 15407-2, width 18 and 26 mm; ISO 5599-2, width 42 and 52 mm

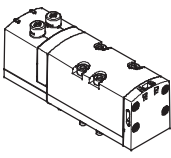
Ordering data				
	Code	Valve function	Width	Part No. Type
Solenoid valves, 24 V DC				
	VC	2x 2/2-way valve, single solenoid, normally closed, pneumatic spring return	42 mm	561340 VSVA-B-T22C-AZD-D1-1T1L
	VV	2x 2/2-way valve, single solenoid, normally closed, pneumatic spring return, vacuum operation possible at 3 and 5	42 mm	561344 VSVA-B-T22CV-AZD-D1-1T1L
	N	2x 3/2-way valve, single solenoid, normally open	42 mm	543692 VSVA-B-T32U-AZD-D1-1T1L
	K	2x 3/2-way valve, single solenoid, normally closed	42 mm	543690 VSVA-B-T32C-AZD-D1-1T1L
	H	2x 3/2-way valve, single solenoid, 1x normally open, 1x normally closed	42 mm	543694 VSVA-B-T32H-AZD-D1-1T1L
	P	2x 3/2-way valve, single solenoid, reverse operation, normally open	42 mm	543693 VSVA-B-T32F-AZD-D1-1T1L
	Q	2x 3/2-way valve, single solenoid, reverse operation, normally closed	42 mm	543691 VSVA-B-T32N-AZD-D1-1T1L
	R	2x 3/2-way valve, single solenoid, reverse operation, 1x normally open, 1x normally closed	42 mm	543695 VSVA-B-T32W-AZD-D1-1T1L
	M	5/2-way valve, single solenoid, pneumatic spring return	42 mm	543698 VSVA-B-M52-AZD-D1-1T1L
	O	5/2-way valve, single solenoid, mechanical spring return	42 mm	543699 VSVA-B-M52-MZD-D1-1T1L
	J	5/2-way valve, double solenoid	42 mm	543696 VSVA-B-B52-ZD-D1-1T1L
	D	5/2-way valve, double solenoid, with dominant signal	42 mm	543697 VSVA-B-D52-ZD-D1-1T1L
	B	5/3-way valve, mid-position pressurised	42 mm	543700 VSVA-B-P53U-ZD-D1-1T1L
	G	5/3-way valve, mid-position closed	42 mm	543702 VSVA-B-P53C-ZD-D1-1T1L
	E	5/3-way valve, mid-position exhausted	42 mm	543701 VSVA-B-P53E-ZD-D1-1T1L

Valve terminals type 44/45, VTSA/VTSA-F, NPT

FESTO

Ordering data – Individual valve 24 V DC – ISO 15407-2, width 18 and 26 mm; ISO 5599-2, width 42 and 52 mm

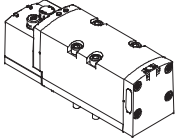
Ordering data					
	Code	Valve function	Width	Part No.	Type
Solenoid valves, 24 V DC					
	VC	2x 2/2-way valve, single solenoid, normally closed, pneumatic spring return	52 mm	560831	VSVA-B-T22C-AZD-D2-1T1L
	N	2x 3/2-way valve, single solenoid, normally open	52 mm	560827	VSVA-B-T32U-AZD-D2-1T1L
	K	2x 3/2-way valve, single solenoid, normally closed	52 mm	560825	VSVA-B-T32C-AZD-D2-1T1L
	H	2x 3/2-way valve, single solenoid, 1x normally open, 1x normally closed	52 mm	560829	VSVA-B-T32H-AZD-D2-1T1L
	P	2x 3/2-way valve, single solenoid, reverse operation, normally open	52 mm	560828	VSVA-B-T32F-AZD-D2-1T1L
	Q	2x 3/2-way valve, single solenoid, reverse operation, normally closed	52 mm	560826	VSVA-B-T32N-AZD-D2-1T1L
	R	2x 3/2-way valve, single solenoid, reverse operation, 1x normally open, 1x normally closed	52 mm	560830	VSVA-B-T32W-AZD-D2-1T1L
	M	5/2-way valve, single solenoid, pneumatic spring return	52 mm	560820	VSVA-B-M52-AZD-D2-1T1L
	O	5/2-way valve, single solenoid, mechanical spring return	52 mm	560821	VSVA-B-M52-MZD-D2-1T1L
	J	5/2-way valve, double solenoid	52 mm	560818	VSVA-B-B52-ZD-D2-1T1L
	D	5/2-way valve, double solenoid, with dominant signal	52 mm	560819	VSVA-B-D52-ZD-D2-1T1L
	B	5/3-way valve, mid-position pressurised	52 mm	560822	VSVA-B-P53U-ZD-D2-1T1L
	G	5/3-way valve, mid-position closed	52 mm	560824	VSVA-B-P53C-ZD-D2-1T1L
	E	5/3-way valve, mid-position exhausted	52 mm	560823	VSVA-B-P53E-ZD-D2-1T1L

Valve terminals type 44/45, VTSA/VTSA-F, NPT

FESTO

Ordering data – Individual valve 110 V AC – ISO 15407-2, width 18 and 26 mm; ISO 5599-2, width 42 and 52 mm

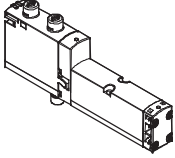
Ordering data				
	Code	Valve function	Width	Part No. Type
Solenoid valves, 110 V AC				
	VC	2x 2/2-way valve, single solenoid, normally closed, pneumatic spring return	18 mm	561156 VSVA-B-T22C-AZD-A2-2AT1L
	VV	2x 2/2-way valve, single solenoid, normally closed, pneumatic spring return, vacuum operation possible at 3 and 5	18 mm	561160 VSVA-B-T22CV-AZD-A2-2AT1L
	N	2x 3/2-way valve, single solenoid, normally open	18 mm	539165 VSVA-B-T32U-AZD-A2-2AT1L
	K	2x 3/2-way valve, single solenoid, normally closed	18 mm	539163 VSVA-B-T32C-AZD-A2-2AT1L
	H	2x 3/2-way valve, single solenoid, 1x normally open, 1x normally closed	18 mm	539167 VSVA-B-T32H-AZD-A2-2AT1L
	P	2x 3/2-way valve, single solenoid, reverse operation, normally open	18 mm	539166 VSVA-B-T32F-AZD-A2-2AT1L
	Q	2x 3/2-way valve, single solenoid, reverse operation, normally closed	18 mm	539164 VSVA-B-T32N-AZD-A2-2AT1L
	R	2x 3/2-way valve, single solenoid, reverse operation, 1x normally open, 1x normally closed	18 mm	539168 VSVA-B-T32W-AZD-A2-2AT1L
	M	5/2-way valve, single solenoid, pneumatic spring return	18 mm	539171 VSVA-B-M52-AZD-A2-2AT1L
	O	5/2-way valve, single solenoid, mechanical spring return	18 mm	539172 VSVA-B-M52-MZD-A2-2AT1L
	J	5/2-way valve, double solenoid	18 mm	539169 VSVA-B-B52-ZD-A2-2AT1L
	D	5/2-way valve, double solenoid, with dominant signal	18 mm	539170 VSVA-B-D52-ZD-A2-2AT1L
	B	5/3-way valve, mid-position pressurised	18 mm	539173 VSVA-B-P53U-ZD-A2-2AT1L
	G	5/3-way valve, mid-position closed	18 mm	539175 VSVA-B-P53C-ZD-A2-2AT1L
	E	5/3-way valve, mid-position exhausted	18 mm	539174 VSVA-B-P53E-ZD-A2-2AT1L

Valve terminals type 44/45, VTSA/VTSA-F, NPT

FESTO

Ordering data – Individual valve 110 V AC – ISO 15407-2, width 18 and 26 mm; ISO 5599-2, width 42 and 52 mm

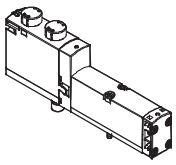
Ordering data					
	Code	Valve function	Width	Part No.	Type
Solenoid valves, 110 V AC					
	VC	2x 2/2-way valve, single solenoid, normally closed, pneumatic spring return	26 mm	561150	VSVA-B-T22C-AZD-A1-2AT1L
	VV	2x 2/2-way valve, single solenoid, normally closed, pneumatic spring return, vacuum operation possible at 3 and 5	26 mm	561154	VSVA-B-T22CV-AZD-A1-2AT1L
	N	2x 3/2-way valve, single solenoid, normally open	26 mm	539139	VSVA-B-T32U-AZD-A1-2AT1L
	K	2x 3/2-way valve, single solenoid, normally closed	26 mm	539137	VSVA-B-T32C-AZD-A1-2AT1L
	H	2x 3/2-way valve, single solenoid, 1x normally open, 1x normally closed	26 mm	539141	VSVA-B-T32H-AZD-A1-2AT1L
	P	2x 3/2-way valve, single solenoid, reverse operation, normally open	26 mm	539140	VSVA-B-T32F-AZD-A1-2AT1L
	Q	2x 3/2-way valve, single solenoid, reverse operation, normally closed	26 mm	539138	VSVA-B-T32N-AZD-A1-2AT1L
	R	2x 3/2-way valve, single solenoid, reverse operation, 1x normally open, 1x normally closed	26 mm	539142	VSVA-B-T32W-AZD-A1-2AT1L
	M	5/2-way valve, single solenoid, pneumatic spring return	26 mm	539145	VSVA-B-M52-AZD-A1-2AT1L
	O	5/2-way valve, single solenoid, mechanical spring return	26 mm	539146	VSVA-B-M52-MZD-A1-2AT1L
	J	5/2-way valve, double solenoid	26 mm	539143	VSVA-B-B52-ZD-A1-2AT1L
	D	5/2-way valve, double solenoid, with dominant signal	26 mm	539144	VSVA-B-D52-ZD-A1-2AT1L
	B	5/3-way valve, mid-position pressurised	26 mm	539147	VSVA-B-P53U-ZD-A1-2AT1L
	G	5/3-way valve, mid-position closed	26 mm	539149	VSVA-B-P53C-ZD-A1-2AT1L
	E	5/3-way valve, mid-position exhausted	26 mm	539148	VSVA-B-P53E-ZD-A1-2AT1L

Valve terminals type 44/45, VTSA/VTSA-F, NPT

FESTO

Ordering data – Individual valve 110 V AC – ISO 15407-2, width 18 and 26 mm; ISO 5599-2, width 42 and 52 mm

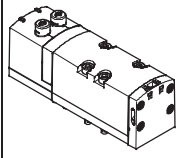
Ordering data				
	Code	Valve function	Width	Part No. Type
Solenoid valves, 110 V AC				
	VC	2x 2/2-way valve, single solenoid, normally closed, pneumatic spring return	42 mm	561341 VSVA-B-T22C-AZD-D1-2AT1L
	VV	2x 2/2-way valve, single solenoid, normally closed, pneumatic spring return, vacuum operation possible at 3 and 5	42 mm	561345 VSVA-B-T22CV-AZD-D1-2AT1L
	N	2x 3/2-way valve, single solenoid, normally open	42 mm	543679 VSVA-B-T32U-AZD-D1-2AT1L
	K	2x 3/2-way valve, single solenoid, normally closed	42 mm	543677 VSVA-B-T32C-AZD-D1-2AT1L
	H	2x 3/2-way valve, single solenoid, 1x normally open, 1x normally closed	42 mm	543681 VSVA-B-T32H-AZD-D1-2AT1L
	P	2x 3/2-way valve, single solenoid, reverse operation, normally open	42 mm	543680 VSVA-B-T32F-AZD-D1-2AT1L
	Q	2x 3/2-way valve, single solenoid, reverse operation, normally closed	42 mm	543678 VSVA-B-T32N-AZD-D1-2AT1L
	R	2x 3/2-way valve, single solenoid, reverse operation, 1x normally open, 1x normally closed	42 mm	543682 VSVA-B-T32W-AZD-D1-2AT1L
	M	5/2-way valve, single solenoid, pneumatic spring return	42 mm	543685 VSVA-B-M52-AZD-D1-2AT1L
	O	5/2-way valve, single solenoid, mechanical spring return	42 mm	543686 VSVA-B-M52-MZD-D1-2AT1L
	J	5/2-way valve, double solenoid	42 mm	543683 VSVA-B-B52-ZD-D1-2AT1L
	D	5/2-way valve, double solenoid, with dominant signal	42 mm	543684 VSVA-B-D52-ZD-D1-2AT1L
	B	5/3-way valve, mid-position pressurised	42 mm	543687 VSVA-B-P53U-ZD-D1-2AT1L
	G	5/3-way valve, mid-position closed	42 mm	543689 VSVA-B-P53C-ZD-D1-2AT1L
	E	5/3-way valve, mid-position exhausted	42 mm	543688 VSVA-B-P53E-ZD-D1-2AT1L

Valve terminals type 44/45, VTSA/VTSA-F, NPT

FESTO

Ordering data – Individual valve 110 V AC – ISO 15407-2, width 18 and 26 mm; ISO 5599-2, width 42 and 52 mm

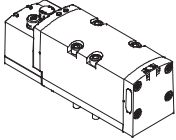
Ordering data					
	Code	Valve function	Width	Part No.	Type
Solenoid valves, 110 V AC					
	VC	2x 2/2-way valve, single solenoid, normally closed, pneumatic spring return	52 mm	560812	VSVA-B-T22C-AZD-D2-2AT1L
	N	2x 3/2-way valve, single solenoid, normally open	52 mm	560808	VSVA-B-T32U-AZD-D2-2AT1L
	K	2x 3/2-way valve, single solenoid, normally closed	52 mm	560806	VSVA-B-T32C-AZD-D2-2AT1L
	H	2x 3/2-way valve, single solenoid, 1x normally open, 1x normally closed	52 mm	560810	VSVA-B-T32H-AZD-D2-2AT1L
	P	2x 3/2-way valve, single solenoid, reverse operation, normally open	52 mm	560809	VSVA-B-T32F-AZD-D2-2AT1L
	Q	2x 3/2-way valve, single solenoid, reverse operation, normally closed	52 mm	560807	VSVA-B-T32N-AZD-D2-2AT1L
	R	2x 3/2-way valve, single solenoid, reverse operation, 1x normally open, 1x normally closed	52 mm	560811	VSVA-B-T32W-AZD-D2-2AT1L
	M	5/2-way valve, single solenoid, pneumatic spring return	52 mm	560801	VSVA-B-M52-AZD-D2-2AT1L
	O	5/2-way valve, single solenoid, mechanical spring return	52 mm	560802	VSVA-B-M52-MZD-D2-2AT1L
	J	5/2-way valve, double solenoid	52 mm	560799	VSVA-B-B52-ZD-D2-2AT1L
	D	5/2-way valve, double solenoid, with dominant signal	52 mm	560800	VSVA-B-D52-ZD-D2-2AT1L
	B	5/3-way valve, mid-position pressurised	52 mm	560803	VSVA-B-P53U-ZD-D2-2AT1L
	G	5/3-way valve, mid-position closed	52 mm	560805	VSVA-B-P53C-ZD-D2-2AT1L
	E	5/3-way valve, mid-position exhausted	52 mm	560804	VSVA-B-P53E-ZD-D2-2AT1L

Valve terminals type 44/45, VTSA/VTSA-F, NPT

FESTO

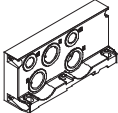
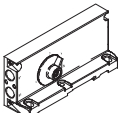
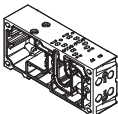
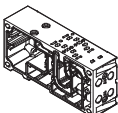

Accessories – Valve terminal – Pneumatic components – ISO 15407-2, width 18 and 26 mm; ISO 5599-2, width 42 and 52 mm

Ordering data					
Designation	Code	Description	Width	Part No.	Type
Right-hand end plate					
	V	With supply air/exhaust air, internal pilot air supply, 1/2" NPT		539235	VABE-S6-1R-N12
	V1	With supply air/exhaust air, internal pilot air supply, 3/4" NPT		560838	VABE-S6-2R-N34
	X	With supply air/exhaust air, external pilot air supply, 1/2" NPT		539237	VABE-S6-1RZ-N12
	X1	With supply air/exhaust air, external pilot air supply, 3/4" NPT		560840	VABE-S6-2RZ-N34
End plate with pilot air selector					
	Y	Internal pilot air supply		539239	VABE-S6-1RZ-N-B1
	U	Internal pilot air supply, ducted pilot exhaust air			
	Z	External pilot air supply			
	W	External pilot air supply, ducted pilot exhaust air			
Manifold sub-base, port pattern to ISO 15407-2 and ISO 5599-2					
	A	2 valve positions, 4 addresses, for double solenoid valves	18 mm	539219	VABV-S4-2S-N18-2T2
	B	2 valve positions, 4 addresses, for double solenoid valves	26 mm	539223	VABV-S4-1S-N14-2T2
	C	1 valve position, 2 addresses, for double solenoid valves	42 mm	542460	VABV-S2-1S-N38-T2
	D	1 valve position, 2 addresses, for double solenoid valves	52 mm	560843	VABV-S2-2S-N12-T2
	E	2 valve positions, 2 addresses, for single solenoid valves	18 mm	539221	VABV-S4-2S-N18-2T1
	F	2 valve positions, 2 addresses, for single solenoid valves	26 mm	539225	VABV-S4-1S-N14-2T1
	G	1 valve position, 1 address, for single solenoid valves	42 mm	542461	VABV-S2-1S-N38-T1
	H	1 valve position, 1 address, for single solenoid valves	52 mm	560844	VABV-S2-2S-N12-T1
Manifold sub-base VTSA-F, optimised for flow rate					
	A	2 valve positions, 4 addresses, for double solenoid valves	18 mm	546217	VABV-S4-2HS-N18-2T2
	B	2 valve positions, 4 addresses, for double solenoid valves	26 mm	546213	VABV-S4-1HS-N14-2T2
	E	2 valve positions, 2 addresses, for single solenoid valves	18 mm	546216	VABV-S4-2HS-N18-2T1
	F	2 valve positions, 2 addresses, for single solenoid valves	26 mm	546212	VABV-S4-1HS-N14-2T1

Valve terminals type 44/45, VTSA/VTSA-F, NPT

FESTO

Accessories – Valve terminal – Pneumatic components – ISO 15407-2, width 18 and 26 mm; ISO 5599-2, width 42 and 52 mm

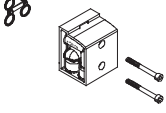
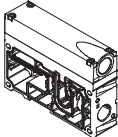
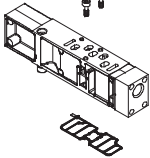
Ordering data					
Designation	Code	Description	Width	Part No.	Type
Separator plate					
	S	Duct separation 1, 3, 5		539228	VABD-S6-10-P3-C
	T	Duct separation 1		539227	VABD-S6-10-P1-C
	R	Duct separation 3, 5		539229	VABD-S6-10-P2-C
90° connection plate					
	P	Outlet at bottom, connecting thread 1/8" NPT	18 mm	539720	VABF-S4-2-A2G2-N18
		Outlet at bottom, connecting thread 1/4" NPT	26 mm	539722	VABF-S4-1-A2G2-N14
		Outlet at bottom, connecting thread 3/8" NPT	42 mm	546098	VABF-S2-1-A1G2-N38
		Outlet at bottom, connecting thread 1/2" NPT	52 mm	555703	VABF-S2-2-A1G2-N12
Supply plate					
	L	With exhaust plate, 3/5 common, 1/2" NPT		539233	VABF-S6-10-P1A7-N12
	K	With exhaust port cover, 3/5 separated, 1/2" NPT		539232	VABF-S6-10-P1A6-N12
Vertical supply plate					
	ZU	Connecting thread 1/8" NPT	18 mm	540174	VABF-S4-2-P1A3-N18
		Connecting thread 1/4" NPT	26 mm	540172	VABF-S4-1-P1A3-N14
		Connecting thread 3/8" NPT	42 mm	546094	VABF-S2-1-P1A3-N38
		Connecting thread 1/2" NPT	52 mm	555787	VABF-S2-2-P1A3-N12

Valve terminals type 44/45, VTSA/VTSA-F, NPT

FESTO

Accessories – Valve terminal – Pneumatic components – ISO 15407-2, width 18 and 26 mm; ISO 5599-2, width 42 and 52 mm

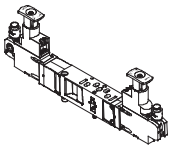
Ordering data					
Designation	Code	Description	Width	Part No.	Type
Regulator plate, width 18 mm					
	ZA	For port 1, 0.5...10 bar	18 mm	540153	VABF-S4-2-R1C2-C-10
	ZF	For port 1, 0.5...6 bar	18 mm	540151	VABF-S4-2-R1C2-C-6
	ZC	For port 2, 2...10 bar	18 mm	540161	VABF-S4-2-R2C2-C-10
	ZH	For port 2, 2...6 bar	18 mm	540159	VABF-S4-2-R2C2-C-6
	ZB	For port 4, 2...10 bar	18 mm	540157	VABF-S4-2-R3C2-C-10
	ZG	For port 4, 2...6 bar	18 mm	540155	VABF-S4-2-R3C2-C-6
	ZD	For ports 2 and 4, 2...10 bar	18 mm	540165	VABF-S4-2-R4C2-C-10
	ZI	For ports 2 and 4, 2...6 bar	18 mm	540163	VABF-S4-2-R4C2-C-6
	ZE	For ports 2 and 4, reversible, 0.5...10 bar	18 mm	540169	VABF-S4-2-R5C2-C-10
	ZJ	For ports 2 and 4, reversible, 0.5...6 bar	18 mm	540167	VABF-S4-2-R5C2-C-6
	ZL	For port 2, reversible, 0.5...10 bar	18 mm	546252	VABF-S4-2-R6C2-C-10
	ZN	For port 2, reversible, 0.5...6 bar	18 mm	546248	VABF-S4-2-R6C2-C-6
	ZK	For port 4, reversible, 0.5...10 bar	18 mm	546254	VABF-S4-2-R7C2-C-10
	ZM	For port 4, reversible, 0.5...6 bar	18 mm	546250	VABF-S4-2-R7C2-C-6

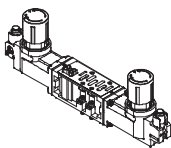
Ordering data					
Designation	Code	Description	Width	Part No.	Type
Regulator plate, width 26 mm					
	ZA	For port 1, 0.5...10 bar	26 mm	540154	VABF-S4-1-R1C2-C-10
	ZF	For port 1, 0.5...6 bar	26 mm	540152	VABF-S4-1-R1C2-C-6
	ZC	For port 2, 2...10 bar	26 mm	540162	VABF-S4-1-R2C2-C-10
	ZH	For port 2, 2...6 bar	26 mm	540160	VABF-S4-1-R2C2-C-6
	ZB	For port 4, 2...10 bar	26 mm	540158	VABF-S4-1-R3C2-C-10
	ZG	For port 4, 2...6 bar	26 mm	540156	VABF-S4-1-R3C2-C-6
	ZD	For ports 2 and 4, 2...10 bar	26 mm	540166	VABF-S4-1-R4C2-C-10
	ZI	For ports 2 and 4, 2...6 bar	26 mm	540164	VABF-S4-1-R4C2-C-6
	ZE	For ports 2 and 4, reversible, 0.5...10 bar	26 mm	540170	VABF-S4-1-R5C2-C-10
	ZJ	For ports 2 and 4, reversible, 0.5...6 bar	26 mm	540168	VABF-S4-1-R5C2-C-6
	ZL	For port 2, reversible, 0.5...10 bar	26 mm	546251	VABF-S4-1-R6C2-C-10
	ZN	For port 2, reversible, 0.5...6 bar	26 mm	546247	VABF-S4-1-R6C2-C-6
	ZK	For port 4, reversible, 0.5...10 bar	26 mm	546253	VABF-S4-1-R7C2-C-10
	ZM	For port 4, reversible, 0.5...6 bar	26 mm	546249	VABF-S4-1-R7C2-C-6

Valve terminals type 44/45, VTSA/VTSA-F, NPT

FESTO

Accessories – Valve terminal – Pneumatic components – ISO 15407-2, width 18 and 26 mm; ISO 5599-2, width 42 and 52 mm

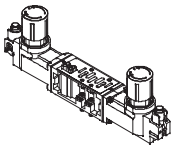
Ordering data					
Designation	Code	Description	Width	Part No.	Type
Regulator plate, width 42 mm					
	ZA	For port 1, 0.5...10 bar	42 mm	546084	VABF-S2-1-R1C2-C-10
	ZF	For port 1, 0.5...6 bar	42 mm	546083	VABF-S2-1-R1C2-C-6
	ZC	For port 2, 0.5...10 bar	42 mm	546088	VABF-S2-1-R2C2-C-10
	ZH	For port 2, 0.5...6 bar	42 mm	546087	VABF-S2-1-R2C2-C-6
	ZB	For port 4, 0.5...10 bar	42 mm	546086	VABF-S2-1-R3C2-C-10
	ZG	For port 4, 0.5...6 bar	42 mm	546085	VABF-S2-1-R3C2-C-6
	ZD	For ports 2 and 4, 0.5...10 bar	42 mm	546090	VABF-S2-1-R4C2-C-10
	ZI	For ports 2 and 4, 0.5...6 bar	42 mm	546089	VABF-S2-1-R4C2-C-6
	ZE	For ports 2 and 4, reversible, 0.5...10 bar	42 mm	546092	VABF-S2-1-R5C2-C-10
	ZJ	For ports 2 and 4, reversible, 0.5...6 bar	42 mm	546091	VABF-S2-1-R5C2-C-6
	ZL	For port 2, reversible, 0.5...10 bar	42 mm	546832	VABF-S2-1-R6C2-C-10
	ZN	For port 2, reversible, 0.5...6 bar	42 mm	546831	VABF-S2-1-R6C2-C-6
	ZK	For port 4, reversible, 0.5...10 bar	42 mm	546834	VABF-S2-1-R7C2-C-10
	ZM	For port 4, reversible, 0.5...6 bar	42 mm	546833	VABF-S2-1-R7C2-C-6

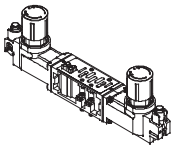
Ordering data					
Designation	Code	Description	Width	Part No.	Type
Regulator plate, width 52 mm					
	ZA	For port 1, 0.5...10 bar	52 mm	555772	VABF-S2-2-R1C2-C-10
	ZF	For port 1, 0.5...6 bar	52 mm	555771	VABF-S2-2-R1C2-C-6
	ZC	For port 2, 0.5...10 bar	52 mm	555774	VABF-S2-2-R2C2-C-10
	ZH	For port 2, 0.5...6 bar	52 mm	555773	VABF-S2-2-R2C2-C-6
	ZB	For port 4, 0.5...10 bar	52 mm	555776	VABF-S2-2-R3C2-C-10
	ZG	For port 4, 0.5...6 bar	52 mm	555775	VABF-S2-2-R3C2-C-6
	ZD	For ports 2 and 4, 0.5...10 bar	52 mm	555778	VABF-S2-2-R4C2-C-10
	ZI	For ports 2 and 4, 0.5...6 bar	52 mm	555777	VABF-S2-2-R4C2-C-6
	ZE	For ports 2 and 4, reversible, 0.5...10 bar	52 mm	555780	VABF-S2-2-R5C2-C-10
	ZJ	For ports 2 and 4, reversible, 0.5...6 bar	52 mm	555779	VABF-S2-2-R5C2-C-6
	ZL	For port 2, reversible, 0.5...10 bar	52 mm	555782	VABF-S2-2-R6C2-C-10
	ZN	For port 2, reversible, 0.5...6 bar	52 mm	555781	VABF-S2-2-R6C2-C-6
	ZK	For port 4, reversible, 0.5...10 bar	52 mm	555784	VABF-S2-2-R7C2-C-10
	ZM	For port 4, reversible, 0.5...6 bar	52 mm	555783	VABF-S2-2-R7C2-C-6

Valve terminals type 44/45, VTSA/VTSA-F, NPT

FESTO

Accessories – Valve terminal – Pneumatic components – ISO 15407-2, width 18 and 26 mm; ISO 5599-2, width 42 and 52 mm

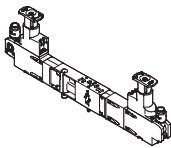
Ordering data					
Designation	Code	Description	Width	Part No.	Type
Regulator plate for symmetrical valves, width 18 mm					
	ZAY	For port 1, 0.5...10 bar	18 mm	560756	VABF-S4-2-R1C2-C-10-E
	ZFY	For port 1, 0.5...6 bar	18 mm	560758	VABF-S4-2-R1C2-C-6-E
	ZCY	For port 2, 2...10 bar	18 mm	560763	VABF-S4-2-R2C2-C-10-E
	ZHY	For port 2, 2...6 bar	18 mm	560765	VABF-S4-2-R2C2-C-6-E
	ZDY	For ports 2 and 4, 2...10 bar	18 mm	560767	VABF-S4-2-R4C2-C-10-E
	ZIY	For ports 2 and 4, 2...6 bar	18 mm	560769	VABF-S4-2-R4C2-C-6-E
	ZEY	For ports 2 and 4, reversible, 0.5...10 bar	18 mm	560771	VABF-S4-2-R5C2-C-10-E
	ZJY	For ports 2 and 4, reversible, 0.5...6 bar	18 mm	560773	VABF-S4-2-R5C2-C-6-E
	ZLY	For port 2, reversible, 0.5...10 bar	18 mm	560775	VABF-S4-2-R6C2-C-10-E
	ZNY	For port 2, reversible, 0.5...6 bar	18 mm	560777	VABF-S4-2-R6C2-C-6-E

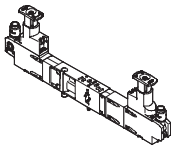
Ordering data					
Designation	Code	Description	Width	Part No.	Type
Regulator plate for symmetrical valves, width 26 mm					
	ZAY	For port 1, 0.5...10 bar	26 mm	560757	VABF-S4-1-R1C2-C-10-E
	ZFY	For port 1, 0.5...6 bar	26 mm	549876	VABF-S4-1-R1C2-C-6-E
	ZCY	For port 2, 2...10 bar	26 mm	560764	VABF-S4-1-R2C2-C-10-E
	ZHY	For port 2, 2...6 bar	26 mm	560766	VABF-S4-1-R2C2-C-6-E
	ZDY	For ports 2 and 4, 2...10 bar	26 mm	560768	VABF-S4-1-R4C2-C-10-E
	ZIY	For ports 2 and 4, 2...6 bar	26 mm	560770	VABF-S4-1-R4C2-C-6-E
	ZEY	For ports 2 and 4, reversible, 0.5...10 bar	26 mm	560772	VABF-S4-1-R5C2-C-10-E
	ZJY	For ports 2 and 4, reversible, 0.5...6 bar	26 mm	560774	VABF-S4-1-R5C2-C-6-E
	ZLY	For port 2, reversible, 0.5...10 bar	26 mm	560776	VABF-S4-1-R6C2-C-10-E
	ZNY	For port 2, reversible, 0.5...6 bar	26 mm	560778	VABF-S4-1-R6C2-C-6-E

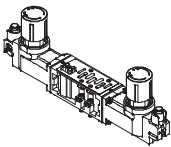
Ordering data					
Designation	Code	Description	Width	Part No.	Type
Regulator plate for symmetrical valves, width 42 mm ¹⁾					
	ZAY	For port 1, 0.5...10 bar	42 mm		VABF-S2-1-R1C2-C-10-E
	ZFY	For port 1, 0.5...6 bar	42 mm		VABF-S2-1-R1C2-C-6-E
	ZCY	For port 2, 0.5...10 bar	42 mm		VABF-S2-1-R2C2-C-10-E
	ZHY	For port 2, 0.5...6 bar	42 mm		VABF-S2-1-R2C2-C-6-E
	ZBY	For port 4, 0.5...10 bar	42 mm		VABF-S2-1-R3C2-C-10-E
	ZGY	For port 4, 0.5...6 bar	42 mm		VABF-S2-1-R3C2-C-6-E
	ZDY	For ports 2 and 4, 0.5...10 bar	42 mm		VABF-S2-1-R4C2-C-10-E
	ZIY	For ports 2 and 4, 0.5...6 bar	42 mm		VABF-S2-1-R4C2-C-6-E
	ZEY	For ports 2 and 4, reversible, 0.5...10 bar	42 mm		VABF-S2-1-R5C2-C-10-E
	ZJY	For ports 2 and 4, reversible, 0.5...6 bar	42 mm		VABF-S2-1-R5C2-C-6-E
	ZLY	For port 2, reversible, 0.5...10 bar	42 mm		VABF-S2-1-R6C2-C-10-E
	ZNY	For port 2, reversible, 0.5...6 bar	42 mm		VABF-S2-1-R6C2-C-6-E
	ZKY	For port 4, reversible, 0.5...10 bar	42 mm		VABF-S2-1-R7C2-C-10-E
	ZMY	For port 4, reversible, 0.5...6 bar	42 mm		VABF-S2-1-R7C2-C-6-E

1) These functions are available via the pressure regulator configurator VABF-S2 for width 42 mm and 52 mm (ISO 5599-2, ISO 1 and ISO 2) only.

Valve terminals type 44/45, VTSA/VTSA-F, NPT

FESTO

Accessories – Valve terminal – Pneumatic components – ISO 15407-2, width 18 and 26 mm; ISO 5599-2, width 42 and 52 mm

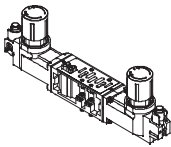
Ordering data					
Designation	Code	Description	Width	Part No.	Type
Regulator plate for symmetrical valves, width 52 mm ¹⁾					
	ZAY	For port 1, 0.5...10 bar	52 mm		VABF-S2-2-R1C2-C-10-E
	ZFY	For port 1, 0.5...6 bar	52 mm		VABF-S2-2-R1C2-C-6-E
	ZCY	For port 2, 2...10 bar	52 mm		VABF-S2-2-R2C2-C-10-E
	ZHY	For port 2, 2...6 bar	52 mm		VABF-S2-2-R2C2-C-6-E
	ZBY	For port 4, 2...10 bar	52 mm		VABF-S2-2-R3C2-C-10-E
	ZGY	For port 4, 2...6 bar	52 mm		VABF-S2-2-R3C2-C-6-E
	ZDY	For ports 2 and 4, 2...10 bar	52 mm		VABF-S2-2-R4C2-C-10-E
	ZIY	For ports 2 and 4, 2...6 bar	52 mm		VABF-S2-2-R4C2-C-6-E
	ZEY	For ports 2 and 4, reversible, 0.5...10 bar	52 mm		VABF-S2-2-R5C2-C-10-E
	ZJY	For ports 2 and 4, reversible, 0.5...6 bar	52 mm		VABF-S2-2-R5C2-C-6-E
	ZLY	For port 2, reversible, 0.5...10 bar	52 mm		VABF-S2-2-R6C2-C-10-E
	ZNY	For port 2, reversible, 0.5...6 bar	52 mm		VABF-S2-2-R6C2-C-6-E
	ZKY	For port 4, reversible, 0.5...10 bar	52 mm		VABF-S2-2-R7C2-C-10-E
	ZMY	For port 4, reversible, 0.5...6 bar	52 mm		VABF-S2-2-R7C2-C-6-E







1) These functions are available via the pressure regulator configurator VABF-S2 for width 42 mm and 52 mm (ISO 5599-2, ISO 1 and ISO 2) only.

Ordering data							
Designation	Code	Description	Width	Part No.	Type		
Pressure gauge							
	T	With cartridge connection for regulator, 10 bar, scale bar/psi, display range 0...16 bar/0...240 psi, for regulator plate code ZA, ZB, ZC, ZD, ZE, ZK, ZL	18 mm	543487	PAGN-26-16-P10		
			26 mm				
			42 mm			548010	PAGN-40-16-P10
			52 mm				
	U	With cartridge connection for regulator, 6 bar, scale bar/psi, display range 0...10 bar/0...145 psi, for regulator plate code ZF, ZG, ZH, ZI, ZJ, ZM, ZN	18 mm	543488	PAGN-26-10-P10		
			26 mm				
			42 mm			548009	PAGN-40-10-P10
	52 mm						
	TM	With cartridge connection for regulator, 10 bar, scale MPa, display range 0...16 bar/0...1.6 MPa, for regulator plate code ZA, ZB, ZC, ZD, ZE, ZK, ZL	18 mm	563735	PAGN-26-1.6M-P10		
			26 mm				
			42 mm			563737	PAGN-40-1.6M-P10
	52 mm						
	UM	With cartridge connection for regulator, 6 bar, scale MPa, display range 0...16 bar/0...1 MPa, for regulator plate code ZF, ZG, ZH, ZI, ZJ, ZM, ZN	18 mm	563736	PAGN-26-1M-P10		
			26 mm				
			42 mm			563738	PAGN-40-1M-P10
	52 mm						
	TP	With cartridge connection for regulator, 10 bar, scale psi/bar, display range 0...16 bar/0...232 psi, for regulator plate code ZA, ZB, ZC, ZD, ZE, ZK, ZL	18 mm	563731	PAGN-26-232P-P10		
			26 mm				
42 mm			563733			PAGN-40-232P-P10	
52 mm							
UP	With cartridge connection for regulator, 6 bar, scale psi/bar, display range 0...10 bar/0...145 psi, for regulator plate code ZF, ZG, ZH, ZI, ZJ, ZM, ZN	18 mm	563732	PAGN-26-145P-P10			
		26 mm					
		42 mm			563734	PAGN-40-145P-P10	
52 mm							

Valve terminals type 44/45, VTSA/VTSA-F, NPT

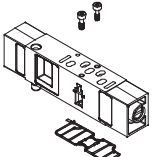
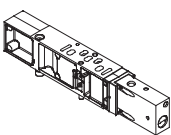
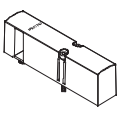
FESTO

Accessories – Valve terminal – Pneumatic components – ISO 15407-2, width 18 and 26 mm; ISO 5599-2, width 42 and 52 mm

Ordering data					
Designation	Code	Description	Width	Part No.	Type
Cartridge for regulator plate					
	-	For tubing O.D. 4 mm		172972	QSP10-4
Adapter					
	-	Adapter for pressure gauge		565811	QSP10-G $\frac{1}{8}$
Flow control plate					
	X	Controls the flow of exhaust air downstream of the valve to ducts 3 and 5	18 mm	540176	VABF-S4-2-F1B1-C
			26 mm	540175	VABF-S4-1-F1B1-C
			42 mm	546095	VABF-S2-1-F1B1-C
			52 mm	555789	VABF-S2-2-F1B1-C
Vertical pressure shut-off plate					
	ZT	2/2-way valve for shutting off the operating pressure at the valve position	18 mm	542884	VABF-S4-2-L1D1-C
			26 mm	542885	VABF-S4-1-L1D1-C
			42 mm	546096	VABF-S2-1-L1D1-C
			52 mm	555791	VABF-S2-2-L1D1-C
Cover					
	L	Blanking plate for vacant position	18 mm	539213	VABB-S4-2-WT
			26 mm	539212	VABB-S4-1-WT
			42 mm	543186	VABB-S2-1-WT
			52 mm	560845	VABB-S2-2-WT
	N	Cover cap for manual override, non-detenting	10 pieces	541010	VAMC-S6-CH
	V	Cover cap for manual override, covered	10 pieces	541011	VAMC-S6-CS
	-	End cap for electrical interlinking module (with individual connection), size 18 mm and 26 mm	10 pieces	547713	VABD-S4-E-C
	-	Seal (with individual connection), size 42 mm and 52 mm	2 pieces	571343	VABD-S2-1-S-C

Valve terminals type 44/45, VTSA/VTSA-F, NPT

FESTO

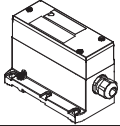
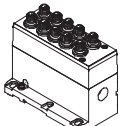
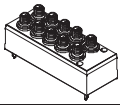
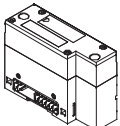
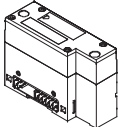

Accessories – Valve terminal – Electrical components – ISO 15407-2, width 18 and 26 mm; ISO 5599-2, width 42 and 52 mm

Ordering data				
Designation	Code	Description	Part No.	Type
Multi-pin node				
	T	Terminal strip, 36-pin	543412	VABE-S6-1LF-C-M1-C36M
	MP1	Sub-D plug, 37-pin	543414	VABE-S6-1LT-C-M1-S37
	MP4	Round plug, 19-pin	543415	VABE-S6-1LF-C-M1-R19
Individual electrical connection				
	-MP2	Multi-pin node with individual connection M12, 6-way	549046	VABE-S6-LT-C-S6-R5
	-MP3	Multi-pin node with individual connection M12, 10-way	549047	VABE-S6-LT-C-S10-R5
	-	Cover for individual connection M12, 6-way	549048	VAEM-S6-C-S6-R5
	-	Cover for individual connection M12, 10-way	549049	VAEM-S6-C-S10-R5
Pneumatic interface				
	-	For electrical terminal CPX in plastic design	543416	VABA-S6-1-X1
	-	For electrical terminal CPX in metal design	550663	VABA-S6-1-X2

Valve terminals type 44/45, VTSA/VTSA-F, NPT

FESTO

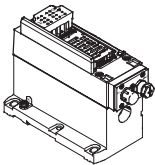
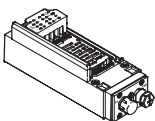
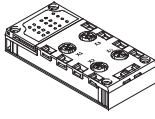

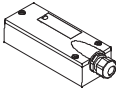

Accessories – Valve terminal – Electrical components – ISO 15407-2, width 18 and 26 mm; ISO 5599-2, width 42 and 52 mm

Ordering data						
Designation	Code	Description	Part No.	Type		
Electrical connection for AS-interface						
	–	4 inputs/4 outputs	549042	VABE-S6-1LF-C-A4-E		
	–	8 inputs/8 outputs	549043	VABE-S6-1LF-C-A8-E		
AS-interface module						
	–	4 inputs/4 outputs	549044	VAEM-S6-S-FAS-4-4E		
	–	8 inputs/8 outputs	549045	VAEM-S6-S-FAS-8-8E		
Manifold block for AS-interface						
	X	4x M12, 5-pin, double, socket	195704	CPX-AB-4-M12x2-5POL		
	GW	4x M12, 5-pin, socket, metal thread	541254	CPX-AB-4-M12x2-5POL-R		
	R	8x M8, 3-pin, socket	195706	CPX-AB-8-M8-3POL		
	J	8x spring-loaded terminal, Cage Clamp®, 4-pin	195708	CPX-AB-8-KL-4POL		
	H	4x Harax®, 4-pin, socket	525636	CPX-AB-4-HAR-4POL		
	B	Sub-D, 25-pin, socket	525676	CPX-AB-1-SUB-BU-25POL		
Connecting cable with Sub-D plug socket						
	Polyurethane, IP65					
	GA	Connecting cable for max. 8 solenoid coils, 10-pin	2.5 m	539240	NEBV-S1W37-E-2,5-LE10	
	GB		5 m	539241	NEBV-S1W37-E-5-LE10	
	GC		10 m	539242	NEBV-S1W37-E-10-LE10	
	GD	Connecting cable for max. 22 solenoid coils, 26-pin	2.5 m	539243	NEBV-S1W37-E-2,5-LE26	
	GE		5 m	539244	NEBV-S1W37-E-5-LE26	
	GF		10 m	539245	NEBV-S1W37-E-10-LE26	
	GG	Connecting cable for max. 32 solenoid coils, 37-pin	2.5 m	539246	NEBV-S1W37-K-2,5-LE37	
	GH		5 m	539247	NEBV-S1W37-K-5-LE37	
	GI		10 m	539248	NEBV-S1W37-K-10-LE37	
	Polyvinyl chloride, IP65					
	GK	Connecting cable for max. 8 solenoid coils, 10-pin,	2.5 m	543271	NEBV-S1W37-KM-2,5-LE10	
	GL	cable properties (standard)	5 m	543272	NEBV-S1W37-KM-5-LE10	
	GM		10 m	543273	NEBV-S1W37-KM-10-LE10	
	GN	Connecting cable for max. 22 solenoid coils, 27-pin,	2.5 m	543274	NEBV-S1W37-KM-2,5-LE27	
	GO	cable properties (standard)	5 m	543275	NEBV-S1W37-KM-5-LE27	
	GP		10 m	543276	NEBV-S1W37-KM-10-LE27	
	GQ	Connecting cable for max. 32 solenoid coils, 37-pin,	2.5 m	543277	NEBV-S1W37-KM-2,5-LE37	
	GR	cable properties (standard)	5 m	543278	NEBV-S1W37-KM-5-LE37	
	GS		10 m	543279	NEBV-S1W37-KM-10-LE37	
Cover for multi-pin plug						
	–	For user configuration	545974	NECV-S1W37		

Valve terminals type 44/45, VTSA/VTSA-F, NPT

FESTO

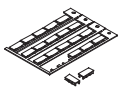
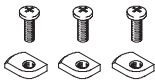
Accessories – Valve terminal – General – ISO 15407-2, width 18 and 26 mm; ISO 5599-2, width 42 and 52 mm

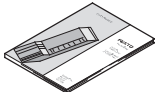



Ordering data					
Designation	Code	Description	Part No.	Type	
Inscription label holder/inscription labels					
	B	Clip-on inscription label holder for valve cap	5 pieces	540888	ASCF-T-S6
	T	Inscription label holder for manifold blocks	5 pieces	540889	ASCF-M-S6
	TD	Inscription label holder for manifold blocks, size 52 mm	5 pieces	562577	ASCF-M-S2-2
	–	Inscription label (20 labels in frames)	20 pieces	18182	IBS-9x20
H-rail mounting					
	–	VTSA/VTSA-F	3 pieces	526032	CPX-CPA-BG-NRH
Wall mounting					
	U	Mounting bracket	5 pieces	539214	VAME-S6-10-W
	–	Mounting bracket		567038	VAME-S6-W-M46
Manual					
	D	Manual for valve terminal VTSA/VTSA-F	German	538922	P.BE-VTSA-44-DE
	E		English	538923	P.BE-VTSA-44-EN
	S		Spanish	538924	P.BE-VTSA-44-ES
	F		French	538925	P.BE-VTSA-44-FR
	I		Italian	538926	P.BE-VTSA-44-IT
	V		Swedish	538927	P.BE-VTSA-44-SV
Pneumatic connection accessories					
<p>A selection of possible fittings, blanking plugs, silencers and other pneumatic accessories can be found in the chapter Accessories → page 134 or on the Internet via the individual search terms:</p> <p>Internet → connection technology, silencer, blanking plug</p>					

Valve terminals type 44/45, VTSA/VTSA-F, NPT

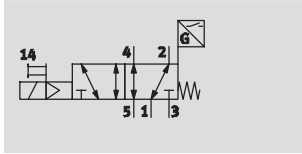
Solenoid valve with switching position sensing

Function¹⁾



-  - Flow rate
950 l/min
-  - Valve width
26 mm
-  - Voltage
24 V DC
-  - Operating pressure
3 ... 10 bar

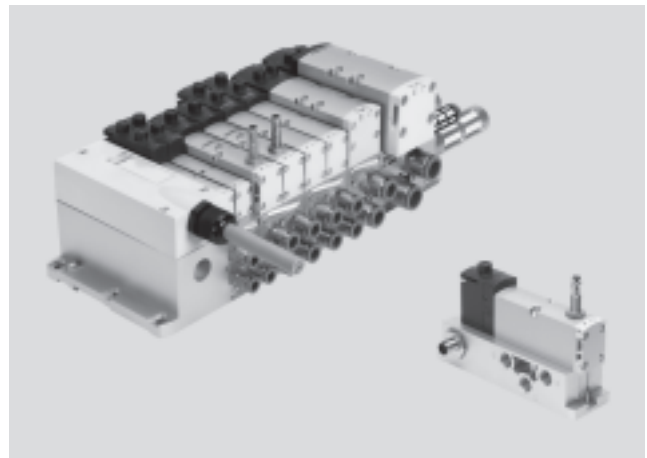

ISO valves with switching position sensing for safety-oriented pneumatic components

Function

The single solenoid 5/2-way valve with spring return in width 26 mm features valve diagnostics. Designed as plug-in or individual connection valve with pilot valves to ISO 15218

and square plug type C. The normal position of the piston spool valve is monitored by the inductive sensor.

This valve is not a safety component in accordance with the Machinery Directive 2006/42/EC. For use in higher categories, the sensor signal from the valve must be evaluated by the control system.

This valve is suitable for use in safety-related parts of control systems to EN ISO 13849-1. This valve is designed for installation in machines or automated systems and must only be used in industrial applications (high-demand mode).

Decentralised individual connection variant

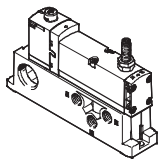

Valve on individual sub-base (square plug or plug-in), with integrated piston position sensing.

The electrical connection is established either via a standardised 4-pin M12 plug 24 V DC (ISO 15407-2), 4-pin spring-loaded terminal or a cable (open end)

24 V DC/110 V AC, which are configured by the user. The individual sub-base can be supplied with internal or external pilot air depending on the version.

Variant for valve terminal VTSA

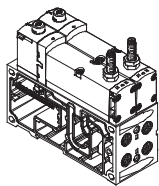

The valves with integrated piston position sensing in plug-in design for valve terminal VTSA can be used regardless of the type of electrical actuation (individual, multi-pin plug or fieldbus/control block connection).

Pilot air supply:
The valve terminal can be supplied with internal or external pilot air via the various end plate variants.

-  - Note
Valves in plug-in design always get their pilot air from duct 14 in the manifold sub-base.

1) The circuit symbol represents a valve with a proximity sensor with switching output signal with an N/O contact. In accordance with ISO 1219-1, this symbol applies to both N/O contacts as well as N/C contacts. The switching element function of the sensors used here is designed as an N/C contact.

Valve terminals type 44/45, VTSA/VTSA-F, NPT

Technical data – Solenoid valve with switching position sensing

General technical data		
Valve	VSVA-B-M52-MZD-A1-1T1L-...- on valve terminal	VSVA-B-M52-MZ-A1-1C1-...-
Width	26 mm	
Design	Piston spool valve	
Sealing principle	Soft	
Actuation type	Electrical	
Type of control	Piloted	
Exhaust function, with flow control	Via individual sub-base, via flow control plate	
Lubrication	Lubricated for life	
Type of mounting	Via through-hole, on manifold sub-base	
Mounting position	Any	
Manual override	Covered	
Individual sub-base		
Pneumatic connection	NPT thread	Fitting
Supply port	1 1/4" NPT	QS-1/4-3/8 QS-1/4-5/16-U
Exhaust port	3/5 1/4" NPT	QS-1/4-3/8 QS-1/4-5/16-U
Working lines	2/4 1/4" NPT	QS-1/4-3/8 QS-1/4-5/16-U
Pilot air supply port	14 1/8" NPT	QS-1/8-5/16-U QS-1/8-1/4-U
Pilot exhaust air port	12 1/8" NPT ¹⁾	QS-1/8-5/16-U QS-1/8-1/4-U
Valve terminal		→ 58

1) Pilot exhaust air port 12 vents directly at the valve, without a connection.

Note: if the customer requests a "turned seal", exhaust air is vented at the end plates of the valve terminal, which does not conform to the ISO standard.

Standard nominal flow rate [l/min]		
Valve	VSVA-B-M52-MZD-A1-1T1L-...- on valve terminal	VSVA-B-M52-MZ-A1-1C1-...-
Width	26 mm	
Flow rate of valve on individual sub-base	-	
Flow rate of valve on valve terminal	1,100	-

Operating and environmental conditions		
Valves and manifold sub-base		
Width	26 mm	
Operating medium	Filtered compressed air, lubricated or unlubricated	
Grade of filtration	[µm]	40 (average pore size)
Operating pressure	[bar]	-0.9 ... 10
Operating pressure for valve terminal with internal pilot air supply	[bar]	3 ... 10
Pilot pressure	[bar]	3 ... 10
Ambient temperature	[°C]	-5 ... +50
Temperature of medium	[°C]	-5 ... +50
Storage temperature ¹⁾	[°C]	-20 ... +40
Relative air humidity	[%]	90
Note on materials	Contains PWIS (paint-wetting impairment substances), RoHS-compliant	

Valve terminals type 44/45, VTSA/VTSA-F, NPT

Technical data – Solenoid valve with switching position sensing

Valve switching times [ms]			
Valve		VSVA-B-M52-MZD-A1-1T1L-...- on valve terminal	VSVA-B-M52-MZ-A1-1C1-...-
Width		26 mm	
Switching times	On	20	21
Switching times	Off	54	41

Electrical data – Valve			
Valve		VSVA-B-M52-MZD-A1-1T1L-...- on valve terminal	VSVA-B-M52-MZ-A1-1C1-...-
Width		26 mm	
Electrical connection		4-pin plug to ISO 15407-2	Plug to DIN EN 175301-803, type C, without protective earth conductor
Nominal operating voltage	[V DC]	24	
Permissible voltage fluctuations	[%]	±10	-15/+10
Surge capacity	[kV]	2.5	
Degree of contamination		3	
Power consumption	[W]	1.6 W	1.8 W
Piston position sensing		Normal position via sensor	
Duty cycle	[%]	100	
Protection class to DIN EN 60529		IP65, NEMA 4	

Electrical data – Sensor			
Electrical connection		Cable, 3-wire	
		Plug M8x1, 3-pin	
Cable length	[m]	2.5	
Switching output		PNP or NPN	
Switching element function		N/C contact	
Switching status display		Yellow LED	
Operating voltage range	[V DC]	10 ... 30	
Residual ripple	[%]	±10	
Sensor idle current	[mA]	≤10	
Max. output current	[mA]	200	
Voltage drop	[V]	≤2	
Max. switching frequency	[Hz]	5,000	
Protection against short circuit		Pulsed	
Protection against polarity reversal for sensor		For all electrical connections	
Measuring principle		Inductive	
Piston position sensing		Valve normal position via sensor	

Valve terminals type 44/45, VTSA/VTSA-F, NPT

Technical data – Solenoid valve with switching position sensing

Materials	
Width	26 mm
Sub-base/manifold sub-base	Die-cast aluminium
Valve	Die-cast aluminium, reinforced polyamide
Seals	Nitrile rubber, elastomer (support made of steel)
Screws	Galvanised steel
Sensor housing	High-alloy stainless steel
Sensor cable sheath	Polyurethane

Product weight	
Approx. weight	[g]
Width	26 mm
5/2-way valve type...	
VSVA-B-M52-MZD-A1-1T1L-APC	307
VSVA-B-M52-MZD-A1-1T1L-APP	264
VSVA-B-M52-MZ-A1-1C1-APC	332
VSVA-B-M52-MZ-A1-1C1-APP	289
VSVA-B-M52-MZD-A1-1T1L-ANC	307
VSVA-B-M52-MZD-A1-1T1L-ANP	264
VSVA-B-M52-MZ-A1-1C1-ANC	332
VSVA-B-M52-MZ-A1-1C1-ANP	289
VSVA-B-M52-MZD-A1-1T1L-APX-0,5	281
Individual sub-base	302

Valve terminals type 44/45, VTSA/VTSA-F, NPT

Ordering data – Solenoid valve with switching position sensing

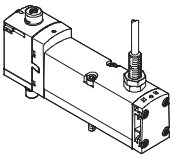
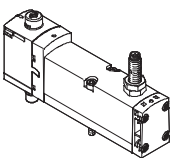
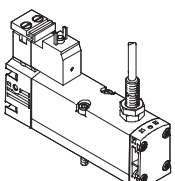
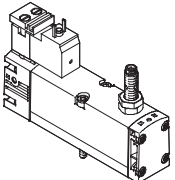
Ordering data					
Designation	Code	Valve function	Width	Part No.	Type
Solenoid valves, 24 V DC, plug-in design for valve terminal VTSA					
	-	5/2-way valve, single solenoid, mechanical spring return, with switching position sensing via inductive sensor with PNP output and cable, 3-wire, 2.5 m	26 mm	560723	VSVA-B-M52-MZD-A1-1T1L-APC
	-	5/2-way valve, single solenoid, mechanical spring return, with switching position sensing via inductive sensor with NPN output and cable, 3-wire, 2.5 m	26 mm	560742	VSVA-B-M52-MZD-A1-1T1L-ANC
	SO	5/2-way valve, single solenoid, mechanical spring return, with switching position sensing via inductive sensor with PNP output and 3-pin sensor push-in connector M8x1	26 mm	560724	VSVA-B-M52-MZD-A1-1T1L-APP
	SQ	5/2-way valve, single solenoid, mechanical spring return, with switching position sensing via inductive sensor with NPN output and 3-pin sensor push-in connector M8x1	26 mm	560743	VSVA-B-M52-MZD-A1-1T1L-ANP
	-	5/2-way valve, single solenoid, mechanical spring return, with switching position sensing via inductive sensor with PNP output and 0.5 m cable with 3-pin sensor push-in connector M12x1	26 mm	570850	VSVA-B-M52-MZD-A1-1T1L-APX-0,5
Solenoid valves, 24 V DC, with pneumatic interface to ISO 15218 for individual sub-base					
	-	5/2-way valve, single solenoid, mechanical spring return, with switching position sensing via inductive sensor with PNP output and cable, 3-wire	26 mm	560725	VSVA-B-M52-MZ-A1-1C1-APC
	-	5/2-way valve, single solenoid, mechanical spring return, with switching position sensing via inductive sensor with NPN output and cable, 3-wire	26 mm	560744	VSVA-B-M52-MZ-A1-1C1-ANC
	-	5/2-way valve, single solenoid, mechanical spring return, with switching position sensing via inductive sensor with PNP output and 3-pin sensor push-in connector M8	26 mm	560726	VSVA-B-M52-MZ-A1-1C1-APP
	-	5/2-way valve, single solenoid, mechanical spring return, with switching position sensing via inductive sensor with NPN output and 3-pin sensor push-in connector M8	26 mm	560745	VSVA-B-M52-MZ-A1-1C1-ANP

 Note







The sensors contained in the valves must not be replaced. Incorrect assembly can result in malfunctions or damage to the valve. Return the module to Festo for maintenance in the event of a fault.

Valves with switching position sensing from the VSVA-B-M52 -...- series can only be ordered individually. If these are used on a valve terminal, appropriate vacant positions must be provided for them.

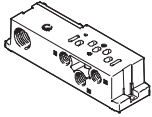
Exceptions are the two valves with ident. code SO and SQ.

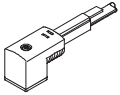
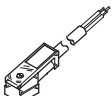
Valve terminals type 44/45, VTSA/VTSA-F, NPT

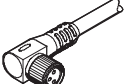
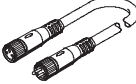
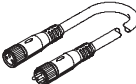
Accessories – Solenoid valve with switching position sensing





Ordering data					
Designation	Code	Description	Width	Part No.	Type
Individual sub-base					
	Individual sub-base, port pattern to ISO 15407-2, electrical connection via cable terminals				
	-	Threaded connection, internal pilot air supply, lateral connections, 1/4" NPT	26 mm	541066	VABS-S4-1S-N14-B-K2
	-	Threaded connection, external pilot air supply, lateral connections, 1/4" NPT	26 mm	539726	VABS-S4-1S-N14-K2
Plug socket for electrical connection of individual valves					
	-	Angled socket, 3-pin, screw terminal, cable connector PG7		151687	MSSD-EB
	-	Angled socket, 3-pin, screw terminal, cable connector M12		539712	MSSD-EB-M12
Connecting cable for electrical connection of individual valves					
	-	Angled socket, 3-pin, cable length 2.5 m		151688	KMEB-1-24-2,5-LED
	-	Angled socket, 3-pin, cable length 5 m		151589	KMEB-1-24-5-LED
	-	Angled socket, 3-pin, cable length 10 m		193457	KMEB-1-24-10-LED
	-	Angled socket, 4-pin, cable length 2.5 m		174844	KMEB-2-24-2,5-LED
	-	Angled socket, 4-pin, cable length 5 m		174845	KMEB-2-24-5-LED
Connecting cable for electrical connection of sensors for switching position sensing					
	-	Straight socket, 3-pin, M8 plug, cable length 2.5 m		541333	NEBU-M8G3-K-2,5-LE3
	-	Straight socket, 3-pin, M8 plug, cable length 5 m		541334	NEBU-M8G3-K-5-LE3
	-	Angled socket, 3-pin, M8 plug, cable length 2.55 m		541338	NEBU-M8-W3-K-2,5-LE3
	-	Angled socket, 3-pin, M8 plug, cable length 5 m		541341	NEBU-M8W3-K-5-LE3
	-	Straight socket, straight plug, 3-pin, M8 plug, cable length 2.5 m		554037	NEBU-M8G3-K-2,5-M8G4
	-	Modular system for connecting cables		-	NEBU-... → Internet: nebu
Illuminating seal for plug pattern DIN EN 175301-803, type C					
	-	12 ... 24 V DC		151717	MEB-LD-12-24DC
	-	230 V AC		151718	MEB-LD-230AC
Pneumatic connection accessories					
<p>A selection of possible fittings, blanking plugs, silencers and other pneumatic accessories can be found in the chapter Accessories → page 134 or on the Internet via the individual search terms:</p> <p>Internet → connection technology, silencer, blanking plug</p>					

Valve terminals type 44/45, VTSA/VTSA-F, NPT

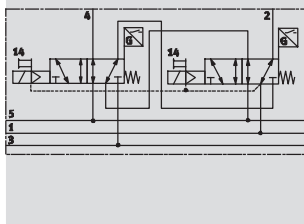
Control block with safety function – Width 26 mm

Function¹⁾



-  Flow rate
950 l/min
-  Valve width
01: 26 mm
-  Voltage
24 V DC
-  Operating pressure
3 ... 10 bar

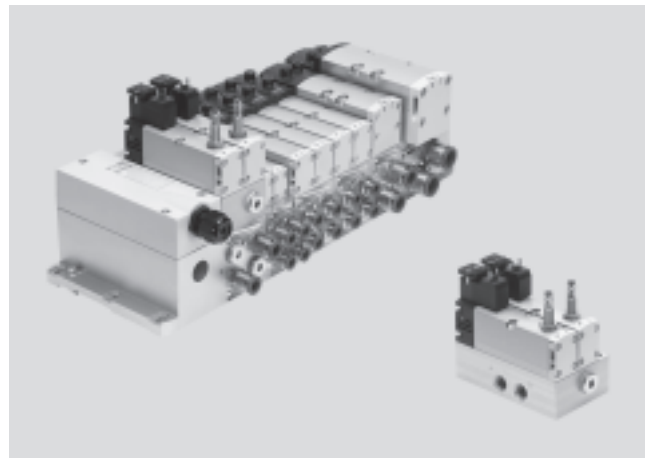

Description

The control block is designed for two-channel actuation of pneumatic drive components such as double-acting linear cylinders, for example, and can be used to realise the following protective measures:

- Protection against unexpected start-up (EN 1037)
- Reversing hazardous movements, provided the reversing motion will not result in further hazards

The control attributes of the control block enable a performance level e to be achieved for the safety measures. The control block has been developed and manufactured in accordance with the basic and proven safety principles of EN ISO 13849–2. The requirements of EN ISO 13849 (e.g. CCF, DC) must be taken into consideration for use in higher categories (2 to 4).

The basic safety principles of EN ISO 13849–2 relating to implementation and operation of the component must be satisfied. For category 2 to 4, the proven safety principles to EN ISO 13849–2 for implementation and operation of the component must be satisfied. When using this product in machines or systems subject to specific C standards, the requirements specified in these standards must be observed.

The control block with safety function is designed for installation in machines and automation systems and must only be used in industrial applications (high-demand mode). The control block with safety function is suitable for use as a press safety valve to EN 962.

More information and technical data
➔ Internet: manual

Vertical stacking variant for valve terminal VTSA, width 26 mm

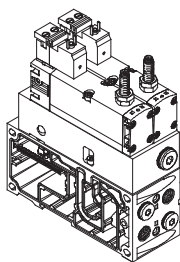

The valves with integrated piston position sensing on manifold sub-base for valve terminal VTSA must be supplied with electrical power regardless of the type of electrical actuation (individual, multi-pin plug or fieldbus/control block connection).

The electrical connection for the solenoid valves is established separately via a standardised square plug to DIN EN 175301–803, type C. The piston position sensing feature of

the inductive PNP or NPN proximity sensor is realised using a push-in connector in the size M8x1 to EN 61076–2–104.

1) The circuit symbol represents a valve with a proximity sensor with switching output signal with an N/O contact. In accordance with ISO 1219-1, this symbol applies to both N/O contacts as well as N/C contacts. The switching element function of the sensors used here is designed as an N/C contact.

Valve terminals type 44/45, VTSA/VTSA-F, NPT

Technical data – Control block with safety function – Width 26 mm

Function – Pneumatic/electrical interlinking

Vertical stacking variant
(on valve terminal)

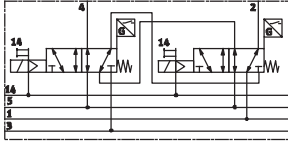

The safety function is achieved through two-channel pneumatic interlinking of two single solenoid 5/2-way directional control valves within the control block: port (4) is only fed with compressed air if both solenoid valves are switched to switching position (14). Port (2) is always fed with compressed air if at least one of the two solenoid valves is in normal position. The valve is reset via a mechanical spring.

The switching operation of the solenoid valves can be monitored by sensing the proximity sensors at the solenoid valves. This is done by linking the control signal and signal change of the proximity sensor so that it is possible to check whether the piston spools of the solenoid valves are reaching or leaving the normal position (expectations).

The piston spools of the solenoid valves are designed so that pneumatic short circuits between the ports (2) and (4) are ruled out (freedom from overlap).

To achieve the required category, the two solenoid valves must be actuated via two separate channels.

General technical data		
Control block	VOFA-B26-T52-M-1C1-...- on valve terminal	
Width	53 mm	
Design	Piston spool valve	
Sealing principle	Soft	
Actuation type	Electrical	
Type of control	Piloted	
Pilot air supply	Internal/external via valve terminal	
Type of mounting	Via through-hole, on manifold sub-base	
Mounting position	Any	
Manual override	Covered	
Valve switching status display	Via accessories	
Pneumatic connections	VOFA-B26-T52-M-1C1-...- on valve terminal	
	Connection with NPT thread	Fitting
Supply port	1	Via the manifold sub-base of the valve terminal
Exhaust port	3/5	Via the manifold sub-base of the valve terminal
Working lines	2/4	1/4" NPT QS-1/4-3/8 QS-1/4-3/16-U
Pilot air supply port	14	Via the manifold sub-base of the valve terminal
Pressure gauge		G1/4

Valve terminals type 44/45, VTSA/VTSA-F, NPT

Technical data – Control block with safety function – Width 26 mm

Standard nominal flow rate [l/min]	
Control block	VOFA-B26-T52-M-1C1-...- on valve terminal
Width	53 mm
Flow rate of valve on valve terminal	830

Operating and environmental conditions	
Control block	VOFA-B26-T52-M-1C1-...- on valve terminal
Width	53 mm
Operating medium	Filtered compressed air, lubricated or unlubricated ¹⁾
Grade of filtration [µm]	40 (average pore size)
Operating pressure [bar]	0 ... 10
Operating pressure for valve terminal with internal pilot air supply [bar]	3 ... 10
Pilot pressure [bar]	3 ... 10
Noise level LpA [dB (A)]	85
Ambient temperature [°C]	-5 ... +50
Temperature of medium [°C]	-5 ... +50
Fire protection classification to UL94	HB
Note on materials	Contains PWIS (paint-wetting impairment substances), RoHS-compliant
Common cause failure (CCF)	Observe operating pressure limits
	Observe pilot pressure limits
	Observe temperature range
	Observe vibration/shock limits
	Compressed air quality according to the technical data, in particular avoidance of flash rust dust (for example caused by servicing work) as well as adherence to the residual oil content of max. 0.1 mg/m ³ when using ester-containing oils (which may, for example, be contained in the compressor oil)
Performance level [PL]	Cat. 4, PL e safety component
Max. positive test pulse with 0 signal [µs]	1,000
Max. negative test pulse with 1 signal [µs]	800

1) The pressure dew point must be at least 10 K lower than the temperature of the medium, since ice would otherwise form in the expanded compressed air.

 Note

With the test pulses, make sure that the maximum pulse length is not exceeded as otherwise the safety function can be impaired.

Valve terminals type 44/45, VTSA/VTSA-F, NPT

Technical data – Control block with safety function – Width 26 mm

Switching times [ms]		
Control block		VOFA-B26-T52-M-1C1-...- on valve terminal
Width		53 mm
Valve switching time	On	22
	Off	59
Valve sensor switching time ¹⁾	On	60
	Off	11

- 1) Valve sensor switching time off: period of time from coil being energised to sensor being switched off when using a PNP sensor.
Valve sensor switching time on: period of time from coil being de-energised to 0-L edge at the sensor when using a PNP sensor.

Electrical data – Control block		
Control block		VOFA-B26-T52-M-1C1-...- on valve terminal
Width		53 mm
Electrical connection		Plug to DIN EN 175301-803, type C, without protective earth conductor
Nominal operating voltage	[V DC]	24
Permissible voltage fluctuations	[%]	-15/+10
Surge capacity	[kV]	2.5
Degree of contamination		3
Power consumption	[W]	1.8 W
Max. magnetic disruption field	[mT]	60
Piston position sensing		Normal position via sensor
Duty cycle	[%]	100
Protection class to DIN EN 60529		IP65, NEMA 4 (for all types of signal transmission in assembled state)
Protection against direct and indirect contact		PELV (Protective Extra-Low Voltage) Protected to EN 60950/IEC 950

Electrical data – Sensor		
Electrical connection		Cable, 3-wire Plug M8x1, 3-pin
Cable length	[m]	2.5
Switching output		PNP or NPN
Switching element function		N/C contact
Switching status display		Yellow LED
Operating voltage range	[V DC]	10 ... 30
Residual ripple	[%]	±10
Sensor idle current	[mA]	≤10
Max. output current	[mA]	200
Voltage drop	[V]	≤2
Max. switching frequency	[Hz]	5,000
Protection against short circuit		Pulsed
Protection against polarity reversal for sensor		For all electrical connections
Measuring principle		Inductive
Piston position sensing		Valve normal position via sensor

 Note

With a 100% duty cycle, the control block must be de-energised once per week.

Valve terminals type 44/45, VTSA/VTSA-F, NPT

Technical data – Control block with safety function – Width 26 mm

Certifications	
Certification	BIA
CE marking (see declaration of conformity)	To EU Machinery Directive

Materials	
Control block	VOFA-B26-T52-M-1C1-...- on valve terminal
Width	53 mm
Sub-base/manifold sub-base	Die-cast aluminium
Valve	Die-cast aluminium, reinforced polyamide
Seals	Nitrile rubber, elastomer (support made of steel)
Screws	Galvanised steel
Sensor housing	High-alloy stainless steel
Sensor cable sheath	Polyurethane

Product weight	
Control block	VOFA-B26-T52-M-1C1-...- on valve terminal
Width	53 mm
Approx. weight [g]	1,112

Valve terminals type 44/45, VTSA/VTSA-F, NPT

Ordering data – Control block with safety function – Width 26 mm

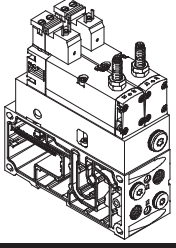
Ordering data					
Designation	Code	Valve function	Width	Part No.	Type
Control block, 24 V DC, vertical stacking variant for valve terminal VTSA					
	SP	5/2-way valve, single solenoid, mechanical spring return, with switching position sensing via inductive sensor with PNP output and 3-pin sensor push-in connector M8, mounted on intermediate plate for pneumatic interlinking	53 mm	– 1)	VOFA-B26-T52-M-1C1-APP
	SN	5/2-way valve, single solenoid, mechanical spring return, with switching position sensing via inductive sensor with NPN output and 3-pin sensor push-in connector M8, mounted on intermediate plate for pneumatic interlinking	53 mm	– 1)	VOFA-B26-T52-M-1C1-ANP



1) The control block with safety function can only be ordered via the valve terminal configurator and therefore does not have a separate part number.

 **Note**

The sensors contained in the valves must not be replaced. Incorrect assembly can result in malfunctions or damage to the valve. Please contact Festo in the event of a malfunction.

Valve terminals type 44/45, VTSA/VTSA-F, NPT

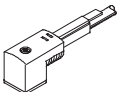
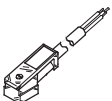
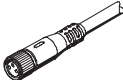
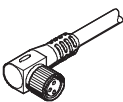
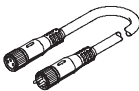
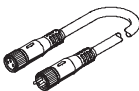
Accessories – Control block with safety function – Width 26 mm

Ordering data				
Designation	Code	Description	Part No.	Type
Plug socket for electrical connection of individual valves				
	-	Angled socket, 3-pin, screw terminal, cable connector PG7	151687	MSSD-EB
	-	Angled socket, 3-pin, screw terminal, cable connector M12	539712	MSSD-EB-M12
Connecting cable for electrical connection of individual valves				
	-	Angled socket, 3-pin, cable length 2.5 m	151688	KMEB-1-24-2,5-LED
	-	Angled socket, 3-pin, cable length 5 m	151589	KMEB-1-24-5-LED
	-	Angled socket, 3-pin, cable length 10 m	193457	KMEB-1-24-10-LED
	-	Angled socket, 4-pin, cable length 2.5 m	174844	KMEB-2-24-2,5-LED
	-	Angled socket, 4-pin, cable length 5 m	174845	KMEB-2-24-5-LED
Connecting cable for electrical connection of sensors for switching position sensing				
	-	Straight socket, 3-pin, M8 plug, cable length 2.5 m	541333	NEBU-M8G3-K-2,5-LE3
	-	Straight socket, 3-pin, M8 plug, cable length 5 m	541334	NEBU-M8G3-K-5-LE3
	-	Angled socket, 3-pin, M8 plug, cable length 2.55 m	541338	NEBU-M8-W3-K-2,5-LE3
	-	Angled socket, 3-pin, M8 plug, cable length 5 m	541341	NEBU-M8W3-K-5-LE3
	-	Straight socket, straight plug, 3-pin, M8 plug, cable length 2.5 m	554037	NEBU-M8G3-K-2,5-M8G4
	-	Modular system for connecting cables	-	NEBU-... → Internet: nebu
Illuminating seal for plug pattern DIN EN 175301-803, type C Technical data → Internet: meb-ld				
	-	12 ... 24 V DC	151717	MEB-LD-12-24DC
	-	230 V AC	151718	MEB-LD-230AC
Pneumatic connection accessories				
<p>A selection of possible fittings, blanking plugs, silencers and other pneumatic accessories can be found in the chapter Accessories → page 134 or on the Internet via the individual search terms:</p> <p>Internet → connection technology, silencer, blanking plug</p>				





Valve terminals type 44/45, VTSA/VTSA-F, NPT

Pilot air switching valve – Width 26 mm

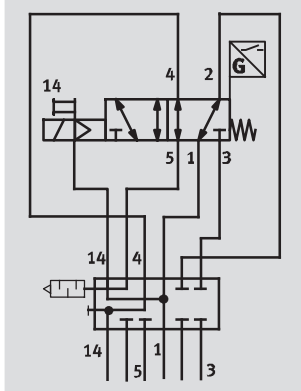
FESTO

Function¹⁾



-  - Flow rate
450 l/min
-  - Valve width
26 mm
-  - Voltage
24 V DC
-  - Operating pressure
3 ... 10 bar

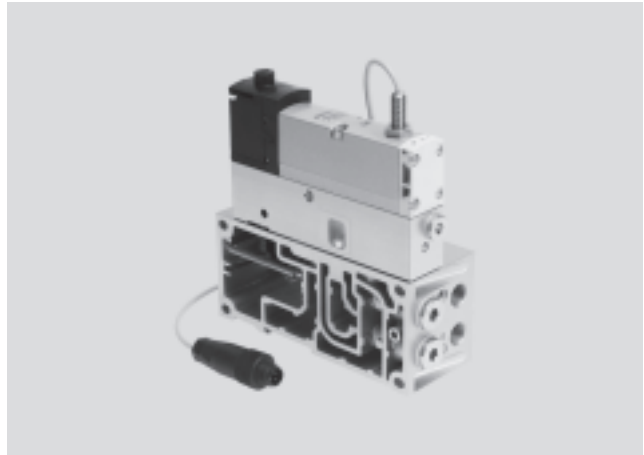

Description

The pilot air switching valve is designed to switch pilot air from duct 1 to 14.

This valve is not a safety component in accordance with the Machinery Directive 2006/42/EC. For use in higher categories, the sensor signal from the valve must be evaluated by the control system.

This valve is suitable for use in safety-related parts of control systems to EN ISO 13849-1. This valve is designed for installation in machines and automation systems and must only be used in industrial applications (high-demand mode).

More information and technical data
➔ Internet: manual

Vertical stacking variant for valve terminal VTSA, width 26 mm

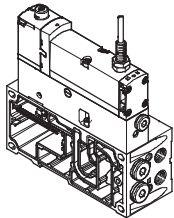

The pilot air switching valve with integrated piston position sensing on manifold sub-base for valve terminal VTSA is supplied with electrical power regardless of the type of electrical actuation of the valve terminal.

This module is supplied pre-assembled together with the valve terminal VTSA. No other assembly steps are required before installation.

The piston position sensing feature of the inductive PNP proximity sensor is realised using a cable and a push-in connector in the size M12x1 to EN 61076-2-104.

1) The circuit symbol represents a valve with a proximity sensor with switching output signal with an N/O contact. In accordance with ISO 1219-1, this symbol applies to both N/O contacts as well as N/C contacts. The switching element function of the sensors used here is designed as an N/C contact.

Note

The pilot air switching valve can only be operated on the valve terminal VTSA in combination with a right-hand end plate for external pilot air type VABE-S6-1RZ-.... Port 14 on the right-hand end plate must be sealed for this.

Valve terminals type 44/45, VTSA/VTSA-F, NPT

Technical data – Pilot air switching valve – Width 26 mm

Function – Pneumatic/electrical interlinking

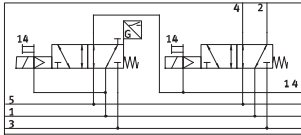

The function for switching off the pilot air is achieved on this module by combining the vertical stacking plate type VABF-S4-1-S with the single solenoid 5/2-way valve type VSVA-B-M52-MZD-A1-1T1L-APX-0,5. The valve terminal is not supplied with any pilot air via the right-hand end plate type VABE-S6-1 (ident. code XS, external pilot air). Port 14 on the end plate is sealed.

The pilot air for the valve is branched from duct (1) in the vertical stacking plate and redirected to the pilot air duct (14) of the valve terminal when the valve is in the switching position. Ports (2) and (4) of the manifold sub-base are sealed with blanking plugs. The switching operation of the solenoid valve can be monitored by sensing the proximity sensor in the solenoid valve.

This is done by linking the control signal and signal change of the proximity sensor so that it is possible to check whether the piston spool of the solenoid valve is reaching or leaving the normal position (expectations). The piston spool of the solenoid valve is designed so that pneumatic short circuits between the ports (2) and (4) are ruled out (freedom from overlap).



Note

A valve from the VTSA modular system can be planned or configured to the right of the valve with piston position sensing on the vertical stacking plate of the pilot air switching valve.

General technical data		
Pilot air switching valve	Vertical stacking plate type VABF-S4-1-S and solenoid valve type VSVA-B-M52-MZD-A1-1T1L-APX-0,5 mounted on valve terminal VTSA	
Width	26 mm	
Design	Piston spool valve	
Sealing principle	Soft	
Actuation type	Electrical	
Type of control	Piloted	
Type of mounting	Via through-hole, on manifold sub-base	
Mounting position	Any	
Pneumatic connections		
Supply port	1	Via the manifold sub-base of the valve terminal
Exhaust port	3/5	Via the manifold sub-base of the valve terminal
Working lines	2/4	Sealed with blanking plug type U-1/4-B-NPT
Pilot air supply port	14	Via the manifold sub-base of the valve terminal
Pressure gauge	G $\frac{1}{4}$	

Valve terminals type 44/45, VTSA/VTSA-F, NPT

Technical data – Pilot air switching valve – Width 26 mm

Standard nominal flow rate [l/min]	
Pilot air switching valve	Vertical stacking plate type VABF-S4-1-S and solenoid valve type VSVA-B-M52-MZD-1A-1T1L-APX-0,5 mounted on valve terminal VTSA
Width	26 mm
Valve flow rate, port 1 to 4	950
Vertical stacking plate flow rate, port 4 to 14	450

Operating and environmental conditions	
Pilot air switching valve	Vertical stacking plate type VABF-S4-1-S and solenoid valve type VSVA-B-M52-MZD-A1-1T1L-APX-0,5 mounted on valve terminal VTSA
Operating medium	Filtered compressed air, lubricated or unlubricated
Grade of filtration [µm]	40 (average pore size)
Operating pressure [bar]	3 ... 10
Noise level LpA [dB (A)]	85
Ambient temperature [°C]	-5 ... +50
Temperature of medium [°C]	-5 ... +50
Fire protection classification to UL94	HB
Note on materials	Contains PWIS (paint-wetting impairment substances), RoHS-compliant

Switching times [ms]		
Valve	VSVA-B-M52-MZD-A1-1T1L-APX-0,5	
Width	26 mm	
Valve switching time	On	20
	Off	54
Valve sensor switching time ¹⁾	On	60
	Off	11

- 1) Valve sensor switching time off: period of time from coil being energised to sensor being switched off when using a PNP sensor.
 Valve sensor switching time on: period of time from coil being de-energised to 0-L edge at the sensor when using a PNP sensor.

Valve terminals type 44/45, VTSA/VTSA-F, NPT

Technical data – Pilot air switching valve – Width 26 mm

Electrical data – Pilot air switching valve	
Pilot air switching valve	Vertical stacking plate type VABF-S4-1-S and solenoid valve type VSVA-B-M52-MZD-A1-1T1L-APX-0,5 mounted on valve terminal VTSA
Width	26 mm
Nominal operating voltage [V DC]	24
Permissible voltage fluctuations [%]	±10
Surge capacity [kV]	2.5
Degree of contamination	3
Power consumption [W]	1.6 W
Max. magnetic disruption field [mT]	60
Piston position sensing	Normal position via sensor
Duty cycle [%]	100
Protection class to DIN EN 60529	IP65, NEMA 4 (for all types of signal transmission in assembled state)

Electrical data – Sensor	
Electrical connection	Plug M12x1, 4-pin
Cable length [m]	0.5
Switching output	PNP
Switching element function	N/C contact
Switching status display	Yellow LED
Operating voltage range [V DC]	10 ... 30
Residual ripple [%]	±10
Rated operating voltage [V DC]	24
Sensor idle current [mA]	≤10
Max. output current [mA]	200
Voltage drop [V]	≤2
Max. switching frequency [Hz]	5,000
Protection against short circuit	Pulsed
Protection against polarity reversal for sensor	For all electrical connections
Measuring principle	Inductive
Piston position sensing	Valve normal position via sensor

Valve terminals type 44/45, VTSA/VTSA-F, NPT



Technical data – Pilot air switching valve – Width 26 mm

Materials	
Pilot air switching valve	
Width	26 mm
Sub-base/manifold sub-base	Die-cast aluminium
Valve	Die-cast aluminium, reinforced polyamide
Seals	Nitrile rubber, elastomer (support made of steel)
Screws	Galvanised steel
Sensor housing	High-alloy stainless steel
Sensor cable sheath	Polyurethane

Product weight	
Pilot air switching valve	Vertical stacking plate type VABF-S4-1-S without solenoid valve and adjacent configuration-dependent valve terminal components
Width	26 mm
Approx. weight [g]	576

Valve terminals type 44/45, VTSA/VTSA-F, NPT

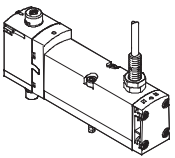
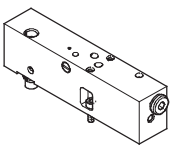
Ordering data – Pilot air switching valve – Width 26 mm

Ordering data					
Designation	Code	Valve function	Width	Part No.	Type
Solenoid valve, 24 V DC, plug-in design for valve terminal VTSA					
	–	5/2-way valve, single solenoid, mechanical spring return, with switching position sensing via inductive sensor with PNP output and 0.5 m cable with 4-pin sensor push-in connector M12x1	26 mm	570850	VSVA-B-M52-MZD-A1-1T1L-APX-0,5
Vertical stacking plate for pilot air switching valve for valve terminal VTSA					
	–	Vertical stacking plate, for switching pilot air from duct 1 to duct 14	26 mm	570851	VABF-S4-1-S
Cover					
	–	Cover cap for manual override, non-detenting	10 pieces	541010	VAMC-S6-CH

 Note





The sensors contained in the valves must not be replaced themselves. Incorrect assembly can result in malfunctions or damage to the valve. Please contact Festo in the event of a malfunction.

Valve terminals type 44/45, VTSA/VTSA-F, NPT

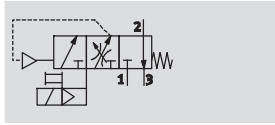
Soft-start valve – Width 43 mm

Function



-  - Flow rate
Pressurisation: 3,000 l/min
Exhaust: 3,300 l/min
-  - Module width
1: 43 mm
-  - Temperature range
-5 ... +50 °C
-  - Operating pressure
2 ... 10 bar

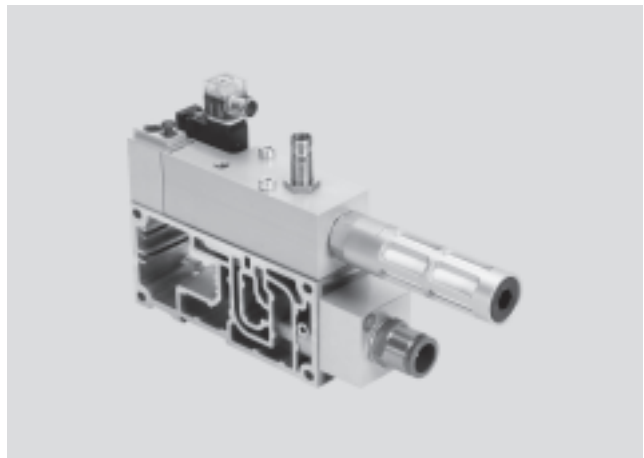

Description

Function

The purpose of the soft-start valve is to slowly and safely build up the supply pressure in duct 1 of the valve terminal or to quickly vent it. Switch-on takes place in two stages:

- First the working pressure provided for duct 1 gradually increases (the speed can be adjusted using a flow control screw).

- Once the working pressure in duct 1 reaches a previously set value, the soft-start valve switches the full operating pressure at duct 1 of the valve terminal.

The switching point for full operating pressure is set to 4 bar at the factory,

but can be changed using an adjusting screw.

The full operating pressure is applied to duct 14 (pilot air) at all times. This pressure causes the valves on the valve terminal to immediately move to the required switching position.

When the valve is not switched, duct 1 of the valve terminal is exhausted via the soft-start valve's exhaust port. A self-resetting manual override is available for maintenance and service purposes.

Diagnostics

The piston position of the soft-start valve can be monitored by a sensor with integrated LED display. This sensor registers whether the valve has

switched and thus whether the valve terminal is being supplied with air. Pressure sensing via a pressure gauge (optional) is also possible.

The soft-start valve can alternatively be ordered with a sensor (retrofitting of a sensor is very complicated due to the necessary sensor calibration).

Connecting cables with integrated LED display are provided for displaying the signal status.

Pilot air supply

The valve terminal can either be supplied with internal pilot air via the soft-start valve or with internal or

external pilot air via the various end plate variants. The type of pilot air supply is determined by the seal of the

soft-start valve. The scope of delivery of the soft-start valve includes both the seal for

internal pilot air supply and the seal for external pilot air supply.

Restrictions

Compressed air supply

There must be no other elements supplying compressed air in the pressure zone in which the soft-start valve is being operated.

Exhaust air

Exhaust air cannot be expelled via the soft-start valve. If it is being operated in a pressure zone with duct 3/5 separated, an exhaust plate is required.

Pilot air supply

If internal pilot air supply (duct 14) via the soft-start valve is chosen, there must be no other pilot air supply within the valve terminal.

Reverse operation

The soft-start valve is not approved for reverse operation.

Valve terminals type 44/45, VTSA/VTSA-F, NPT

Technical data – Soft-start valve – Width 43 mm

General technical data	
Design	Piston spool valve
Actuation type	Electrical
Sealing principle	Soft
Type of mounting	On sub-base
Mounting position	Any
Valve function	Soft-start function
Manual override	Non-detenting
Reset method	Mechanical spring
Type of control	Piloted
Pilot air supply	Internal, external
Direction of flow	Non-reversible
Piston position sensing	Switching position via sensor

Standard nominal flow rate [l/min]	
Pressurisation	3,000
Exhaust	3,300

Operating and environmental conditions		
Type	VABF-S6-1-P5A4-...-2A	VABF-S6-1-P5A4-...-1
Operating pressure [bar]	2 ... 10	
Switchover pressure [bar] presetting	4	
Operating medium	Filtered compressed air, lubricated or unlubricated, grade of filtration 40 µm	
Ambient temperature [°C]	-5 ... +50	
CE mark (see declaration of conformity)	To EU EMC Directive	-

Valve terminals type 44/45, VTSA/VTSA-F, NPT

Technical data – Soft-start valve – Width 43 mm

Valve switching times [ms]		
Switching times	On	17
	Off	50
	Change-over	–

Electrical data – Soft-start valve		
Type	VABF-S6-1-P5A4-...-1	VABF-S6-1-P5A4-...-2A
Electrical connection	Plug type C to DIN EN 175301-803, square design	
Nominal operating voltage [V]	24 DC	110 AC
Operating voltage range [V]	24 DC $\pm 10\%$	110 AC $\pm 10\%$
Coil characteristics	24 V DC: 2.5 W	110 V AC: 50/60 Hz, 3 VA pull: 110 V AC: 50/60 Hz, 2.4 VA hold
Protection class to EN 60529	IP65, NEMA 4	

Electrical data – Sensor		
Electrical connection	Plug M12x1, 4-pin	
Switching output	PNP	
Switching element function	N/O contact	
Switching status display	Yellow LED	
Operating voltage range [V DC]	10 ... 30	
Residual ripple [%]	± 10	
Rated operating voltage [V DC]	24	
Sensor idle current [mA]	≤ 10	
Max. output current [mA]	200	
Voltage drop [V]	≤ 2	
Max. switching frequency [Hz]	3,000	
Protection against short circuit	Pulsed	
Protection against polarity reversal for sensor	For all electrical connections	
Measuring principle	Inductive	
Piston position sensing	Switching position via sensor	

Materials	
Housing	Wrought aluminium alloy
Seals	Nitrile rubber
Screws	Galvanised steel

Product weight	
Approx. weight [g]	
Manifold sub-base	570
Soft-start valves without proximity sensor	590
Soft-start valves with proximity sensor	605

Valve terminals type 44/45, VTSA/VTSA-F, NPT

Technical data – Soft-start valve – Width 43 mm

Dimensions

Download CAD data → www.festo.com

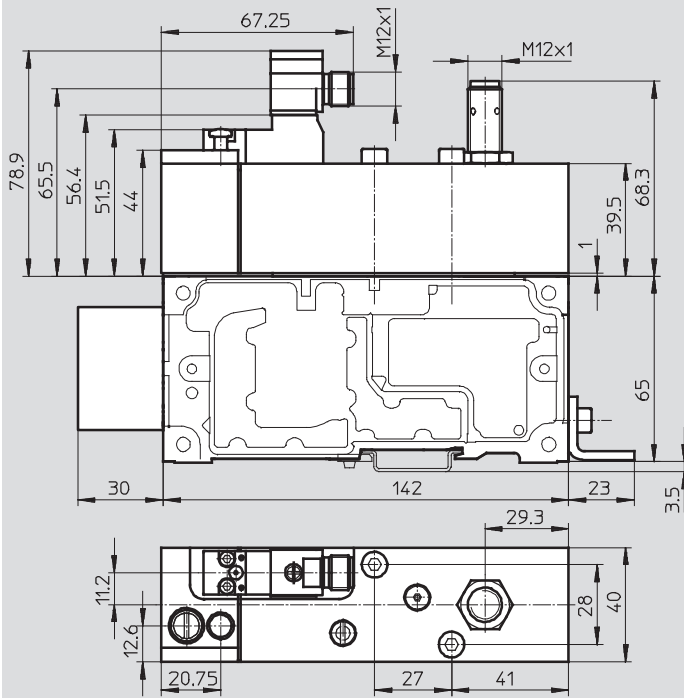





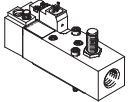
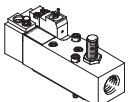
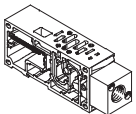



Valve terminals type 44/45, VTSA/VTSA-F, NPT

Ordering data – Soft-start valve – Width 43 mm

Ordering data				
Designation	Code	Description	Part No.	Type
Soft-start valve, 24 V DC				
	-	Without sensor output, pneumatic connection 1/2" NPT	558231	VABF-S6-1-P5A4-N12-4-1
	-	With sensor output PNP, pneumatic connection 1/2" NPT	558232	VABF-S6-1-P5A4-N12-4-1-P
	-	With sensor output NPN, pneumatic connection 1/2" NPT	558234	VABF-S6-1-P5A4-N12-4-1-N
Soft-start valve, 110 V AC				
	-	Without sensor output, pneumatic connection 1/2" NPT	558229	VABF-S6-1-P5A4-N12-4-2A
Manifold sub-base				
	-	Pneumatic connection 1/2" NPT	556988	VABV-S6-1Q-N12

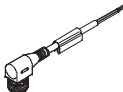
Valve terminals type 44/45, VTSA/VTSA-F, NPT

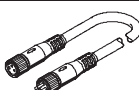
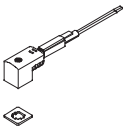
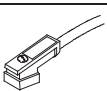
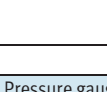
Accessories – Soft-start valve – Width 43 mm

Ordering data				
Designation	Code	Description	Part No.	Type
Proximity sensor				
	–	With integrated switching	PNP	150403 SIEN-M12B-PS-S-L
		status display via LED (yellow)	NPN	150401 SIEN-M12B-NS-S-L
Protective cap				
	–	M12, for sealing the sensor opening (10 pieces)	165592	ISK-M12
Plug socket for electrical connection of the soft-start valve				
	–	Angled socket, 2-pin, for solenoid coil, straight plug, M12	188024	MSSD-EB-M12-MONO
Connecting cable for electrical connection of the proximity sensor				
	–	Straight socket, M12x1 plug, 4-wire, cable length 5 m	164259	SIM-M12-4GD-5-PU
	–	Angled socket, 5-pin, M12 plug, cable length 5 m	541370	NEBU-M12W5-K-5-LE3
	–	Straight socket, 5-pin, M12 plug, cable length 5 m	541364	NEBU-M12G5-K-5-LE3
	–	Modular system for connecting cables	–	NEBU-... → Internet: nebu
Connecting cable for electrical connection of the soft-start valve				
	–	Angled socket, type C, 24 V DC, with LED for switching status display	Cable length 2.5 m	151688 KMEB-1-24-2,5-LED
			Cable length 5 m	151689 KMEB-1-24-5-LED
			Cable length 10 m	193457 KMEB-1-24-10-LED
	–	Angled socket, type C, for solenoid coil 230 V AC	Cable length 2.5 m	151690 KMEB-1-230AC-2,5
			Cable length 5 m	151691 KMEB-1-230-5
	–	Angled socket, type C, 24 V DC, with LED for switching status display	Cable length 2.5 m	174844 KMEB-2-24-2,5-LED
			Cable length 5 m	174845 KMEB-2-24-5-LED
			Angled socket, type C, for solenoid coil 230 V AC	Cable length 2.5 m
			Cable length 5 m	174847 KMEB-2-230-5
Pressure gauge				
	–	0 ... 10 bar, pneumatic connection M5	526323	MA-27-10-M5
Pneumatic connection accessories				
<p>A selection of possible fittings, blanking plugs, silencers and other pneumatic accessories can be found in the chapter Accessories → page 134 or on the Internet via the individual search terms:</p> <p>Internet → connection technology, silencer, blanking plug</p>				

Valve terminals type 44/45, VTSA/VTSA-F, NPT

Individual connection – ISO 15407-2, width 18 and 26 mm; ISO 5599-2, width 42 and 52 mm

FESTO

-  - Flow rate
 Width 18 mm:
 up to 600 l/min
 Width 26 mm:
 up to 1,200 l/min
 Width 42 mm:
 up to 1,500 l/min
 Width 52 mm:
 up to 3,200 l/min

-  - Voltage
 24 V DC
 110 V AC

-  - Valve width
 to ISO 15407-2
 • 18 mm
 • 26 mm
 to ISO 5599-2
 • 42 mm (ISO 1)
 • 52 mm (ISO 2)

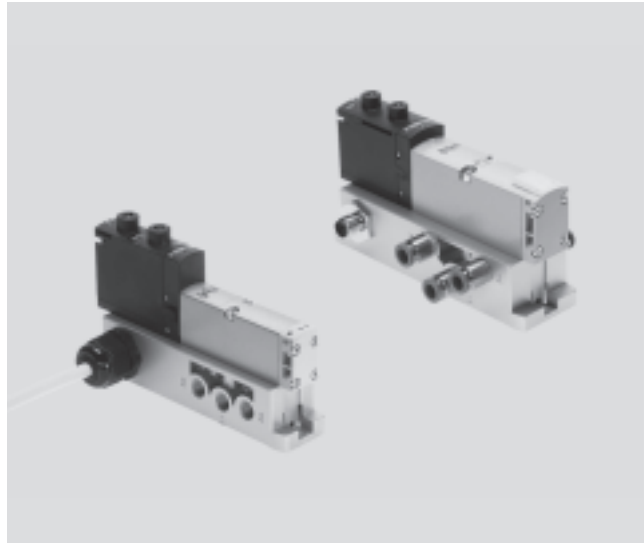

General technical data				
Design	Piston spool valve			
Sealing principle	Soft			
Actuation type	Electrical			
Type of control	Piloted			
Exhaust function, with flow control	Via individual sub-base			
Lubrication	Lubricated for life			
Type of mounting	Through-hole to ISO 15407-2			
Mounting position	Any			
Manual override	Detenting, non-detenting, covered			
Pneumatic connections – NPT thread				
Width	18 mm	26 mm	42 mm	52 mm
Pneumatic connection	Via sub-base			
Supply port	1	1/8" NPT	1/4" NPT	3/8" NPT
Exhaust port	3/5	1/8" NPT	1/4" NPT	3/8" NPT
Working lines	2/4	1/8" NPT	1/4" NPT	3/8" NPT
External pilot air supply port	14	10-32UNF-2B	1/8" NPT	1/8" NPT
Pilot exhaust air port	12	10-32UNF-2B	1/8" NPT	1/8" NPT

Valve terminals type 44/45, VTSA/VTSA-F, NPT

FESTO

Technical data – Individual connection – ISO 15407-2, width 18 and 26 mm; ISO 5599-2, width 42 and 52 mm

Standard nominal flow rate [l/min]																		
Valve function order code ¹⁾	VC	VW	N	K	H	P	Q	R	M	O	J	D	B	E	G	SA	SB	
Width 18 mm																		
Flow rate of valve	700		600			750			700 ²⁾		330 ³⁾		-		-			
Flow rate of valve on individual sub-base	500		500			600			500 ²⁾		330 ³⁾		550		-			
Width 26 mm																		
Flow rate of valve	1,350		1,250			1,400			1,400 ²⁾		700 ³⁾		1,400		700			
Flow rate of valve on individual sub-base	1,100		1,100		1,000		1,200		1,200 ²⁾		700 ³⁾		1,200		700			
Width 42 mm																		
Flow rate of valve	1,600		1,600			2,000			1,900 ²⁾		950 ³⁾		-		-			
Flow rate of valve on individual sub-base	1,400		1,200			1,500			1,400 ¹⁾		800 ³⁾		-		-			
Width 52 mm																		
Flow rate of valve	3,500		3,000			4,000			3,500 ²⁾		1,700 ³⁾		-		-			
Flow rate of valve on individual sub-base	3,000		2,500			3,200			3,000 ²⁾		1,700 ³⁾		-		-			

1) Order code VW not for size 2

2) Switching position

3) Mid-position

Operating and environmental conditions	
Operating medium	Filtered compressed air, lubricated or unlubricated, inert gases → 57
Grade of filtration [µm]	40 (average pore size)
Operating pressure [bar]	-0.9 ... +10
Ambient temperature [°C]	-5 ... +50
PWIS criterion	Free of paint-wetting impairment substances

Valve terminals type 44/45, VTSA/VTSA-F, NPT

FESTO

Technical data – Individual connection – ISO 15407-2, width 18 and 26 mm; ISO 5599-2, width 42 and 52 mm

Pneumatic characteristic data																	
Valve function order code	VC	VV	N	K	H	P	Q	R	M	O	J	D	B	G	E	SA	SB
Direction of flow																	
Any	-	■	-	-	-	-	-	-	■	■	■	■	■	■	■	-	■
Reversible only	-	-	-	-	-	■	■	■	-	-	-	-	-	-	-	-	-
Non-reversible	■	-	■	■	■	-	-	-	-	-	-	-	-	-	-	■	-
Reset method																	
Pneumatic spring	■	■	■	-	■	■	■	■	■	-	-	-	-	-	-	■	■
Mechanical spring	-	-	-	■	-	-	-	-	-	■	-	-	■	■	■	-	-

Valve switching times																		
Valve function order code ¹⁾	VC	VV	N	K	H	P	Q	R	M	O	J	D	B	G	E	SA	SB	
Width 18 mm, nominal operating voltage 24 V DC/110 V AC																		
Switching times [ms]	On	12	12	12	12	12	25	25	25	22	12	-	-	15	15	15	-	-
	Off	30	30	30	30	30	12	12	12	28	38	-	-	44	44	44	-	-
	Change-over	-	-	-	-	-	-	-	-	-	-	11	13	-	-	-	-	-
Width 26 mm, nominal operating voltage 24 V DC/110 V AC																		
Switching times [ms]	On	20	20	20	20	20	32	32	32	25	20	-	-	22	22	22	9/22	9/19
	Off	38	38	38	38	38	30	30	30	45	65	-	-	65	65	65	49	36
	Change-over	-	-	-	-	-	-	-	-	-	-	18	21	-	-	-	33	32
Width 42 mm, nominal operating voltage 24 V DC																		
Switching times [ms]	On	20	20	20	20	20	34	34	34	27	22	-	-	22	22	22	-	-
	Off	38	38	38	38	38	28	28	28	45	60	-	-	65	65	65	-	-
	Change-over	-	-	-	-	-	-	-	-	-	-	16	19	-	-	-	-	-
Width 42 mm, nominal operating voltage 110 V AC																		
Switching times [ms]	On	22	22	22	22	22	34	34	34	20	20	-	-	22	22	22	-	-
	Off	46	46	46	46	46	38	38	38	55	55	-	-	68	68	68	-	-
	Change-over	-	-	-	-	-	-	-	-	-	-	16	19	-	-	-	-	-
Width 52 mm, nominal operating voltage 24 V DC with holding current reduction																		
Switching times [ms]	On	14	-	20	20	20	30	30	30	40	20	-	-	23	23	23	-	-
	Off	35	-	35	35	35	30	30	30	45	60	-	-	60	60	60	-	-
	Change-over	-	-	-	-	-	-	-	-	-	-	18	18	-	-	-	-	-
Width 52 mm, nominal operating voltage 110 V AC																		
Switching times [ms]	On	35	-	35	35	35	50	50	50	70	25	-	-	30	30	30	-	-
	Off	70	-	70	70	70	65	65	65	90	110	-	-	100	100	100	-	-
	Change-over	-	-	-	-	-	-	-	-	-	-	35	35	-	-	-	-	-

1) Not for individual sub-base with round plug type VABS ...B-R3

2) Order code SA, switching time 22 ms for control side 12, 9 ms for control side 14
Order code SB, switching time 19 ms for control side 12, 9 ms for control side 14

Valve terminals type 44/45, VTSA/VTSA-F, NPT

FESTO

Technical data – Individual connection – ISO 15407-2, width 18 and 26 mm; ISO 5599-2, width 42 and 52 mm

Electrical data					
Valve on individual sub-base		18 mm	26 mm	42 mm	52 mm
Acceptable current load at 40 °C	[A]	2 (1 A per coil)			
Variants with cable connector					
Operating voltage range	[V AC]	110 ±10% (50 ... 60 Hz) (with variants with cable and spring-loaded terminal VABS-...-K1/C1)			
Surge capacity	[kV]	4			
Degree of contamination		3			
Duty cycle	[%]	100			

-  - Note

A cable connector is needed to ensure the IP protection class and to protect against tensile load, twisting and bending.

Valve terminals type 44/45, VTSA/VTSA-F, NPT

Technical data – Individual connection – ISO 15407-2, width 18 and 26 mm

Certifications	
This product is certified for use in the ATEX zone in accordance with the EU ATEX Directive	
ATEX category for gas	II 3G
Explosion ignition protection type for gas	Ex nA II T3 X
ATEX category for dust	II 3D
Explosion ignition protection type for dust	Ex tD A22 IP65 T125° C X
ATEX temperature rating [°C]	-5 ≤ Ta ≤ +50
Certification	cULus recognized (OL)
Protection class	IP65, NEMA 4 in assembled state
CE mark ¹⁾ (see declaration of conformity)	To EU Low Voltage Directive

 Note

The sub-bases with the part numbers shown opposite are ATEX-certified

- 563066
- 563067
- 563068
- 563069
- 563070
- 563071
- 567703
- 567704

Materials				
Width	18 mm	26 mm	42 mm	52 mm
Sub-base	Die-cast aluminium			Chill-cast aluminium
Valve	Die-cast aluminium, reinforced polyamide			
Seals	Nitrile rubber, elastomer (support made of steel)			

Product weight				
Approx. weight [g]				
Width	18 mm	26 mm	42 mm	52 mm
Valves				
– 5/3-way valve (code: B, G, E)	191	320	456	780
– 5/3-way valve (code: SA, SB)	–	301	–	–
– 5/2-way valve, single solenoid (code: M, O)	163	293	426	702
– 5/2-way valve, double solenoid (code: J, D)	172	276	439	732
– 2x 3/2-way valve (code: N, K, H, P, Q, R)	190	335	442	740
– 2x 2/2-way valve (code: VC, VV)	190	335	442	740
Individual sub-base	192	302	386	815

Valve terminals type 44/45, VTSA/VTSA-F, NPT

Technical data – Individual connection – ISO 15407-2, width 18 and 26 mm

Dimensions

Download CAD data → www.festo.com

Individual sub-base with cable terminals, width 18 mm

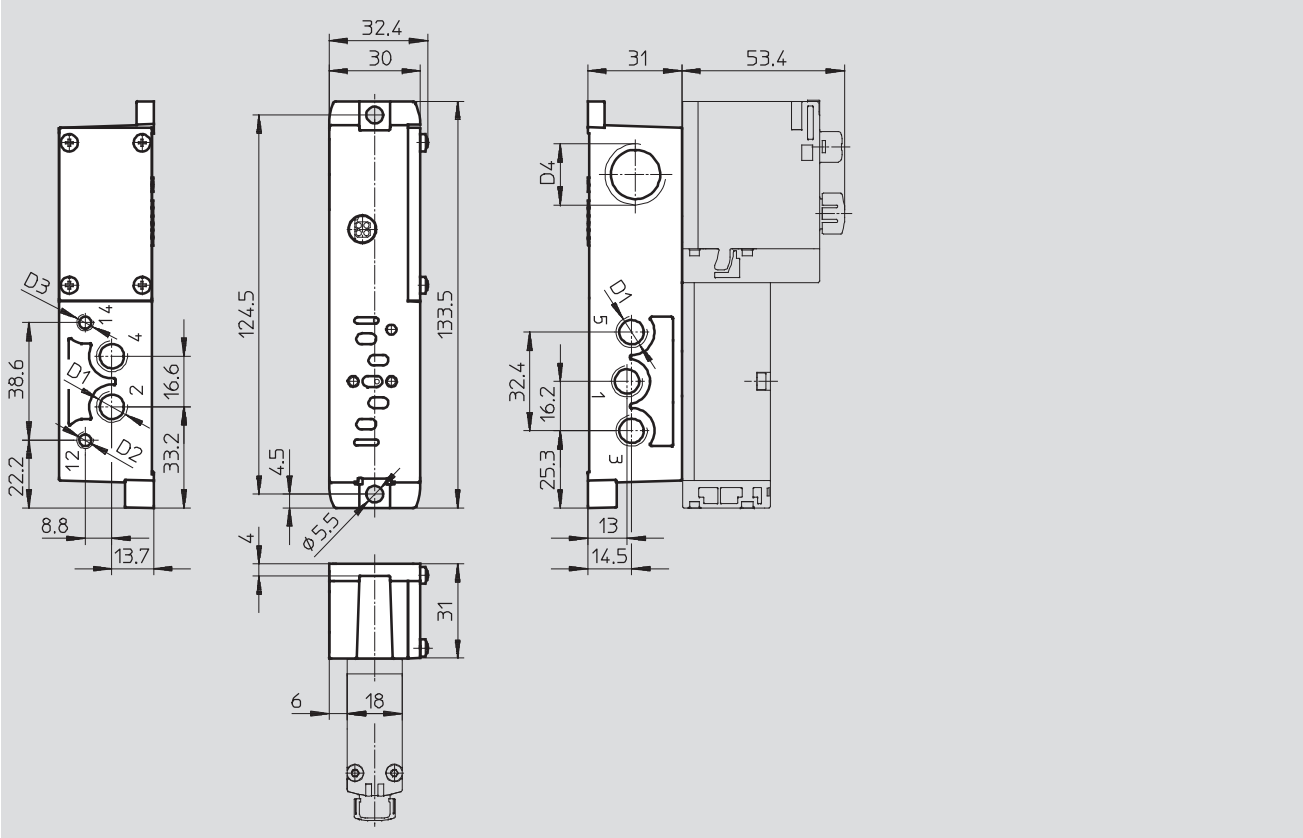

Type	D1	D2	D3	D4
External pilot air supply				
VABS-S4-2S-N18-K2	1/8" NPT	10-32UNF-2B	10-32UNF-2B	M20x1.5
Internal pilot air supply				
VABS-S4-2S-N18-B-K2	1/8" NPT	10-32UNF-2B	-	M20x1.5

Note: This product conforms to ISO 1179-1 and to ISO 228-1

Valve terminals type 44/45, VTSA/VTSA-F, NPT

Technical data – Individual connection – ISO 15407-2, width 18 and 26 mm

Dimensions Download CAD data → www.festo.com
 Individual sub-base with cable terminals, width 26 mm

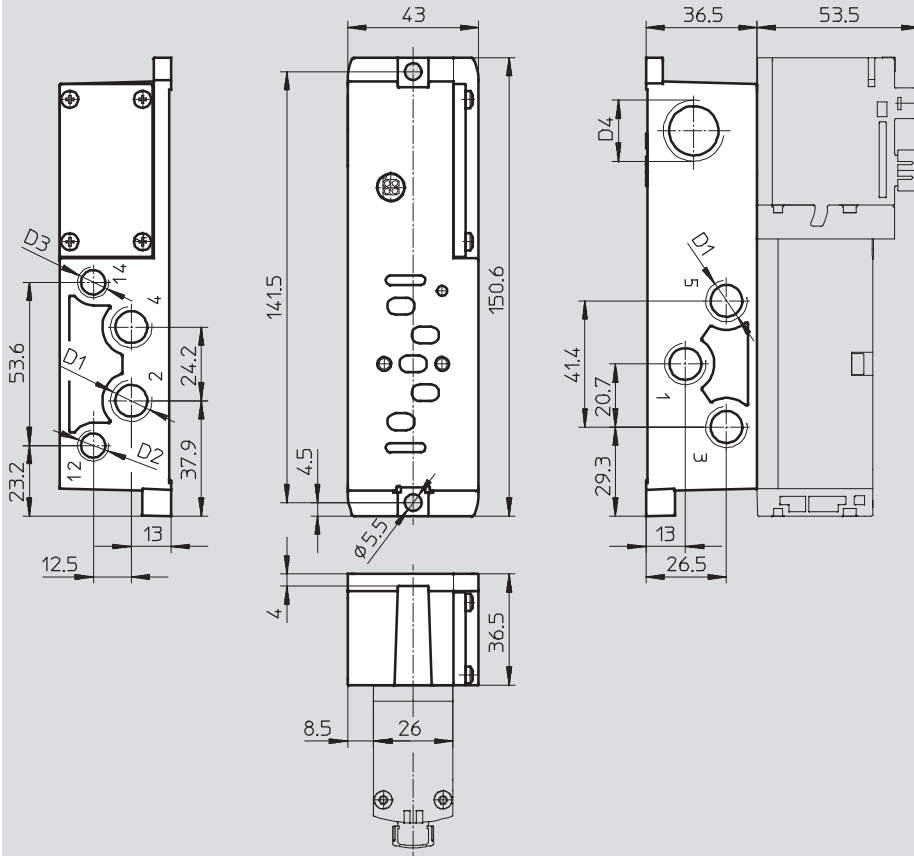

Type	D1	D2	D3	D4
External pilot air supply				
VABS-S4-1S-N14-K2	1/4" NPT	1/8" NPT	1/8" NPT	M20x1.5
Internal pilot air supply				
VABS-S4-1S-N14-B-K2	1/4" NPT	1/8" NPT	-	M20x1.5

• Note: This product conforms to ISO 1179-1 and to ISO 228-1

Valve terminal VTSA

Technical data – Individual connection – ISO 15407-2, width 18 and 26 mm; ISO 5599-2, width 42 and 52 mm

Dimensions

Download CAD data → www.festo.com

Individual sub-base with spring-loaded terminal or for self-assembly, width 42 mm

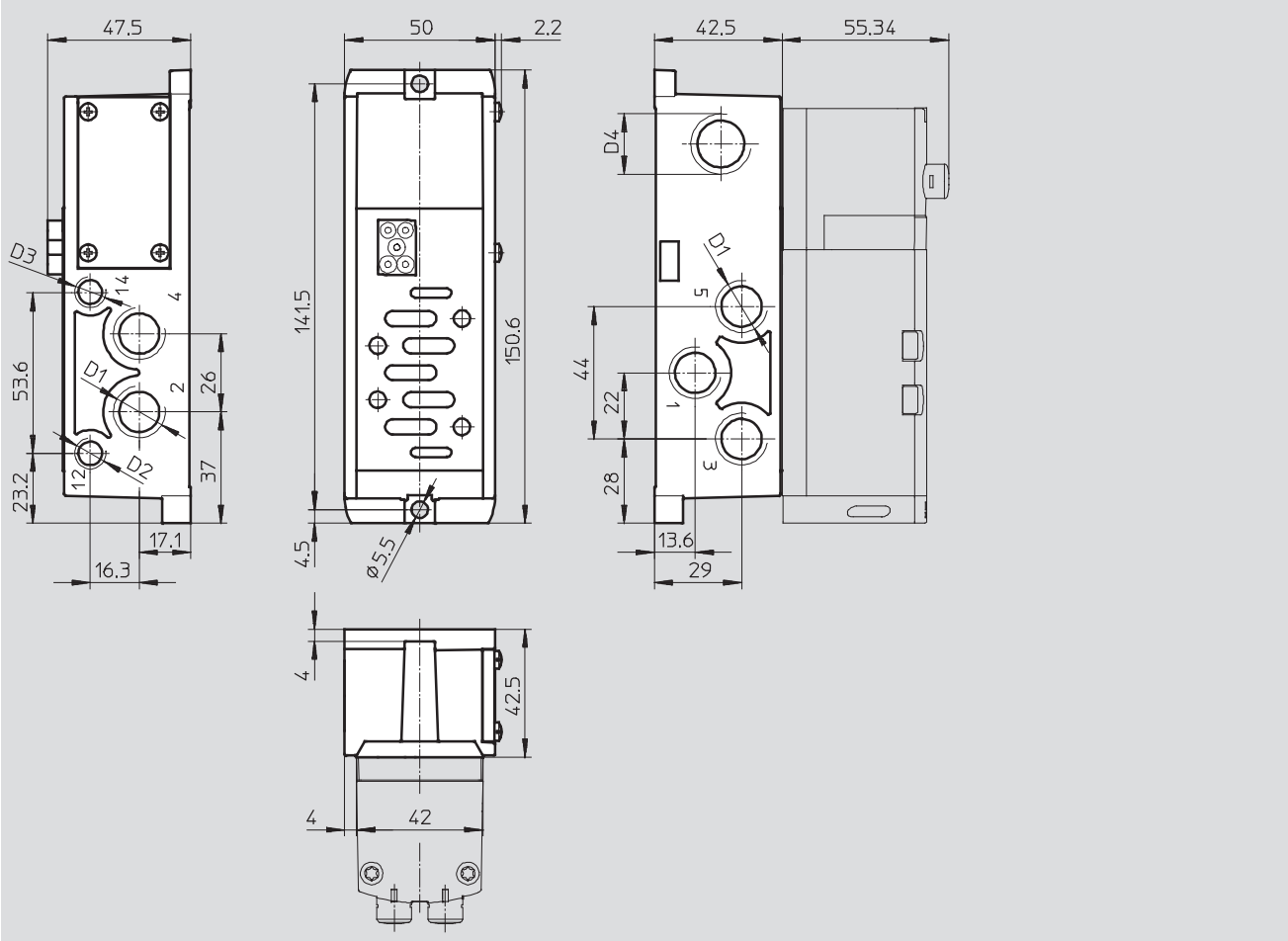

Type	D1	D2	D3	D4
External pilot air supply				
VABS-S2-1S-N38-K1	3/8" NPT	1/8" NPT	1/8" NPT	M20x1.5
VABS-S2-1S-N38-C1	3/8" NPT	1/8" NPT	1/8" NPT	M20x1.5
Internal pilot air supply				
VABS-S2-1S-N38-B-K1	3/8" NPT	1/8" NPT	–	M20x1.5
VABS-S2-1S-N38-B-C1	3/8" NPT	1/8" NPT	–	M20x1.5

Note: This product conforms to ISO 1179-1 and to ISO 228-1



Note

Electrical connection

- VABS-...-K1: open end
- VABS-...-C1: spring-loaded terminal

Valve terminal VTSA

Technical data – Individual connection – ISO 15407-2, width 18 and 26 mm; ISO 5599-2, width 42 and 52 mm

Dimensions Download CAD data → www.festo.com
 Individual sub-base with spring-loaded terminal or for self-assembly, width 52 mm

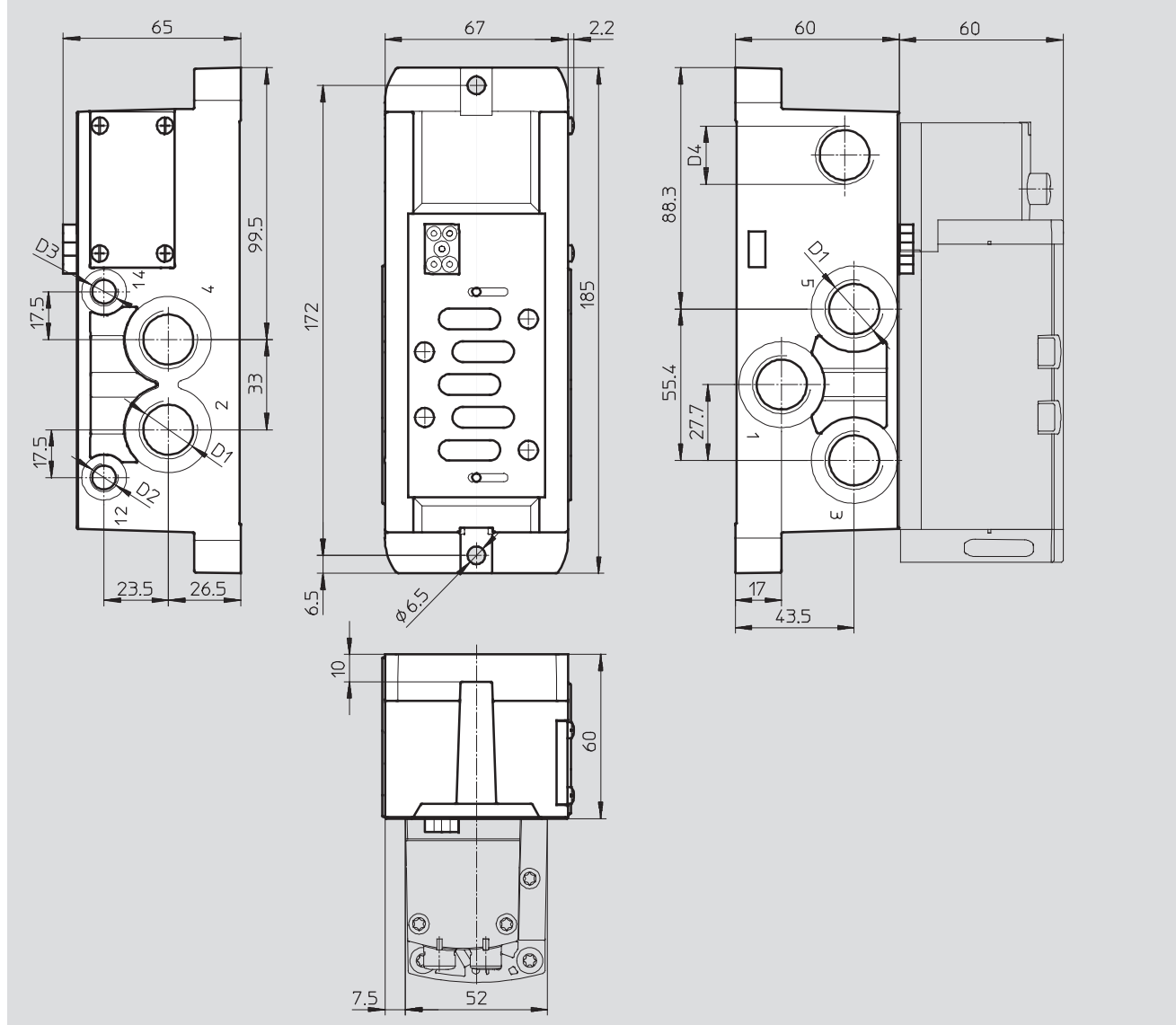



Type	D1	D2	D3	D4
External pilot air supply				
VABS-S2-2S-N12-K1	1/2" NPT	1/8" NPT	1/8" NPT	M20x1.5
VABS-S2-2S-N12-C1	1/2" NPT	1/8" NPT	1/8" NPT	M20x1.5
Internal pilot air supply				
VABS-S2-2S-N12-B-K1	1/2" NPT	1/8" NPT	–	M20x1.5
VABS-S2-2S-N12-B-C1	1/2" NPT	1/8" NPT	–	M20x1.5

– † – Note: This product conforms to ISO 1179-1 and to ISO 228-1

– † – Note
 Electrical connection
 • VABS-...-K1: open end
 • VABS-...-C1: spring-loaded terminal

Valve terminals type 44/45, VTSA/VTSA-F, NPT

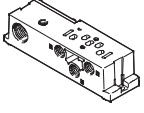
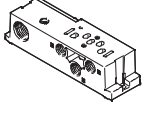
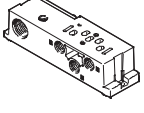
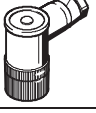
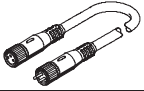

Accessories – Individual connection – ISO 15407-2, width 18 and 26 mm

Ordering data				
Designation	Code	Description	Width	Part No. Type
Individual sub-base, port pattern to ISO 15407-2, electrical connection via cable terminals				
		Threaded connection, internal pilot air supply		
	–	Lateral connections, 1/8" NPT	18 mm	541068 VABS-S4-2S-N18-B-K2
	–	Lateral connections, 1/4" NPT	26 mm	541066 VABS-S4-1S-N14-B-K2
		Threaded connection, external pilot air supply		
	–	Lateral connections, 1/8" NPT	18 mm	539724 VABS-S4-2S-N18-K2
	–	Lateral connections, 1/4" NPT	26 mm	539726 VABS-S4-1S-N14-K2
Individual sub-base, port pattern to ISO 5599-2, electrical connection via cable (open end)				
		Threaded connection, internal pilot air supply		
	–	Lateral connections, 3/8" NPT	42 mm	546103 VABS-S2-1S-N38-B-K1
	–	Lateral connections, 1/2" NPT	52 mm	555642 VABS-S2-2S-N12-B-K1
		Threaded connection, external pilot air supply		
	–	Lateral connections, 3/8" NPT	42 mm	546100 VABS-S2-1S-N38-K1
	–	Lateral connections, 1/2" NPT	52 mm	555637 VABS-S2-2S-N12-K1
Individual sub-base, port pattern to ISO 5599-2, electrical connection via spring-loaded terminal				
		Threaded connection, internal pilot air supply		
	–	Lateral connections, 3/8" NPT	42 mm	546763 VABS-S2-1S-N38-B-C1
	–	Lateral connections, 1/2" NPT	52 mm	555644 VABS-S2-2S-N12-B-C1
		Threaded connection, external pilot air supply		
	–	Lateral connections, 3/8" NPT	42 mm	546761 VABS-S2-1S-N38-C1
	–	Lateral connections, 1/2" NPT	52 mm	555639 VABS-S2-2S-N12-C1
Plug socket for electrical connection of individual valves				
	–	Angled socket, 4-pin, screw terminal, union nut M12		185498 SEA-M12-4WD-PG7
Connecting cable for electrical connection of individual valves at the individual electrical connection				
	–	Modular system for connecting cables		– NEBU... → Internet: nebu
Illuminating seal for plug pattern DIN EN 175301-803, type C				Technical data → Internet: meb-ld
	–	12 ... 24 V DC	151717	MEB-LD-12-24DC
	–	230 V AC	151718	MEB-LD-230AC
Pneumatic connection accessories				
A selection of possible fittings, blanking plugs, silencers and other pneumatic accessories can be found in the chapter Accessories → page 134 or on the Internet via the individual search terms: Internet → connection technology, silencer, blanking plug				

Valve terminals type 44/45, VTSA/VTSA-F, NPT

FESTO

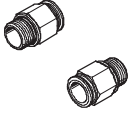
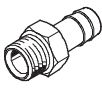
Accessories

Ordering data				
Designation	Code	Description	Part No.	Type
Push-in fitting				
	-	Connecting thread 1/4" NPT for tubing O.D. 1/2"	190681	QS-1/4-1/2-U
		Connecting thread 1/4" NPT for tubing O.D. 3/8"	153611	QS-1/4-3/8-U
		Connecting thread 1/4" NPT for tubing O.D. 5/16"	153609	QS-1/4-5/16-U
		Connecting thread 1/8" NPT for tubing O.D. 3/8"	190679	QS-1/8-3/8-U
		Connecting thread 1/8" NPT for tubing O.D. 1/4"	153605	QS-1/8-1/4-U
		Connecting thread 1/8" NPT for tubing O.D. 5/16"	153608	QS-1/8-5/16-U
		Connecting thread 3/8" NPT for tubing O.D. 1/2"	153614	QS-3/8-1/2-U
		Connecting thread 3/8" NPT for tubing O.D. 3/8"	153612	QS-3/8-3/8-U
		Connecting thread 1/2" NPT for tubing O.D. 5/8"	190682	QS-1/2-5/8-U
		Connecting thread 1/2" NPT for tubing O.D. 1/2"	153615	QS-1/2-1/2-U
Female hose connector				
	-	For right-hand end plate 3/4" NPT	564848	N-3/4-P-19-NPT
		For right-hand end plate R1	752414	N-1-P-19-R-NPT
		For adapter plate R1		
Silencer				
	-	Connecting thread 1/8" NPT	12638	U-1/8-B-NPT
		Connecting thread 1/4" NPT	12639	U-1/4-B-NPT
		Connecting thread 1/2" NPT	12741	U-1/2-B-NPT
		Connecting thread 3/4" NPT	566823	U-3/4-B-NPT
		Connecting thread 1" NPT	571280	U-1-NPT-SA
Blanking plug				
	-	Connecting thread 1/8" NPT	173985	B-1/8-NPT
		Connecting thread 1/4" NPT	174165	B-1/4-NPT
		Connecting thread 1/2" NPT	31785	B-1/2-NPT
		Connecting thread 3/4" NPT	31786	B-3/4-NPT
		Connecting thread 1" NPT	31787	B-1-NPT
Other pneumatic connection accessories				
A selection of possible fittings, blanking plugs and silencers can be found on the Internet via the individual search terms: Internet → connection technology, silencer, blanking plug				